

OXFORD REFERENCE 

THE OXFORD-DUDEN

# Pictorial English Dictionary



Over 28,000 illustrations



OXFORD REFERENCE  
THE  
OXFORD-DUDEN  
PICTORIAL ENGLISH  
DICTIONARY

Forward

# THE OXFORD-DUDEN PICTORIAL ENGLISH DICTIONARY

There are certain kinds of words which are more readily illustrated by pictures than by text. This is especially true of words which are used in a concrete sense, or which have a specific meaning. The Oxford-Duden Pictorial English Dictionary is a dictionary of such words. It contains over 10,000 words, each illustrated by a picture. The pictures are arranged in a grid, with the word in English on the left and the word in German on the right. The pictures are arranged in a grid, with the word in English on the left and the word in German on the right. The pictures are arranged in a grid, with the word in English on the left and the word in German on the right.

The word 'DUDEN' is a registered trademark of the Bibliographisches Institut for books of any kind. Edited by John Perry, Oxford, with the assistance of Roland Beyerle, Michael Clark, Janis Cunningham, David Jordan, and Werner Schürz-Schürz. Illustrations by Robert Schmidt, Mannheim. The Oxford-Duden Pictorial English Dictionary. ISBN 0-19-504122-9 (hard cover). OXFORD UNIVERSITY PRESS



Oxford University Press, Walton Street, Oxford OX2 6DP

Oxford New York Toronto  
Delhi Bombay Calcutta Madras Karachi  
Petaling Jaya Singapore Hong Kong Tokyo  
Nairobi Dar es Salaam Cape Town  
Melbourne Auckland  
and associated companies in  
Berlin Ibadan

Oxford is a trade mark of Oxford University Press

© Illustrations: Bibliographisches Institut, Mannheim 1979

© Text: Oxford University Press 1981

First published 1981

First issued as a paperback 1984

Reprinted 1984 (twice), 1985 (twice), 1987, 1988, 1990 (twice), 1991

All rights reserved. No part of this publication may be reproduced, stored in a retrieval system, or transmitted, in any form or by any means, electronic, mechanical, photocopying, recording, or otherwise, without the prior permission of Oxford University Press

This book is sold subject to the condition that it shall not, by way of trade or otherwise, be lent, re-sold, hired out or otherwise circulated without the publisher's prior consent in any form of binding or cover other than that in which it is published and without a similar condition including this condition being imposed on the subsequent purchaser

The word 'DUDEN' is a registered trademark of the Bibliographisches Institut for books of any kind

Edited by John Pheby, Oxford, with the assistance of Roland Breitsprecher, Michael Clark, Judith Cunningham, Derek Jordan, and Werner Scholze-Stubenrecht  
Illustrations by Jochen Schmidt, Mannheim

British Library Cataloguing in Publication Data

The Oxford-Duden pictorial English dictionary.

1. English language—Dictionaries

I. Pheby, J. A.

423 PE1625

ISBN 0-19-864155-9 (pbk)

Printed in Hong Kong

## Foreword

This pictorial dictionary is based on the Oxford–Duden Pictorial German–English Dictionary published in 1980. It was produced by the German Section of the Oxford University Press Dictionary Department in cooperation with the Dudenredaktion of the Bibliographisches Institut, Mannheim, and with the assistance of various British companies, institutions, and specialists. Numerous modifications of the text and illustrations of the original work have been carried out, especially regarding the depiction of everyday objects and situations, in order to allow greater scope for the treatment of these objects and situations in the context of English-speaking countries.

There are certain kinds of information which can be conveyed more readily and clearly by pictures than by definitions and explanations alone: an illustration will help the reader to visualize the object denoted by the word and to form an impression of the way in which objects function in their own technical field or in the everyday life of English-speaking countries. The layout of the illustrations and the text will be particularly useful to the learner. Each double page of the dictionary contains a list of the vocabulary of a subject together with a picture illustrating this vocabulary. This arrangement, and the presence of an alphabetical index, allows the book to be used in two ways: either as a key to the vocabulary of a subject or as an alphabetical dictionary in which the reader is referred to the section or sections in which the word is illustrated.

Oxford, 1981

J.P.

## Abbreviations

Am.	American usage
c.	castrated (animal)
coll.	colloquial
f.	female (animal)
form.	formerly
joc.	jocular
m.	male (animal)
poet.	poetic
sg.	singular
sim.	similar
y.	young (animal)



## Contents

The arabic numerals are the numbers of the pictures.

### Atom, Universe, Earth

Atom I 1  
Atom II 2  
Astronomy I 3  
Astronomy II 4  
Astronomy III 5  
Moon Landing 6  
The Atmosphere 7  
Meteorology I 8  
Meteorology II and Climatology 9  
Meteorological Instruments 10  
Physical Geography I 11  
Physical Geography II 12  
Physical Geography III 13  
Map I 14  
Map II 15

### Man and his Social Environment

Man I 16  
Man II 17  
Man III 18  
Man IV 19  
Man V 20  
First Aid 21  
Doctor I 22  
Doctor II 23  
Dentist 24  
Hospital I 25  
Hospital II 26  
Hospital III 27  
Infant Care and Layette 28  
Children's Clothes 29  
Ladies' Wear I (Winter Wear) 30  
Ladies' Wear II (Summer Wear) 31  
Underwear, Nightwear 32  
Men's Wear 33  
Hairstyles and Beards 34  
Headgear 35  
Jewellery (*Am. Jewelry*) 36  
Types of Dwelling 37  
Roof and Boiler Room 38  
Kitchen 39  
Kitchen Utensils and Appliances 40  
Hall 41  
Living Room (Lounge) 42  
Bedroom 43  
Dining Room 44  
Tableware and Cutlery 45  
Flat (Apartment) 46  
Children's Room (Nursery) 47  
Kindergarten (Day Nursery) 48  
Bathroom and Toilet 49  
Household Appliances and Utensils 50

### Nature as Environment, Agriculture, and Forestry

Flower Garden 51  
Fruit and Vegetable Garden 52  
Indoor Plants (Houseplants) 53  
Propagation of Plants 54  
Market Garden (*Am. Truck Garden, Truck Farm*) 55  
Garden Tools 56  
Vegetables (Vegetable Plants) 57  
Soft Fruit and Pomes 58  
Drupes and Nuts 59  
Garden Flowers 60  
Weeds 61  
Farm Buildings (*Am. Farmstead*) 62  
Agriculture (Farming) 63  
Agricultural Machinery I 64  
Agricultural Machinery II 65  
Agricultural Implements 66  
Overhead Irrigation 67  
Arable Crops 68  
Fodder Plants (Forage Plants) 69  
Breeds of Dog 70  
Horse I 71  
Horse II 72  
Domestic Animals 73  
Poultry Farming, Egg Production 74  
Rearing (*Am. Raising*) of Livestock 75  
Dairy 76  
Bees and Beekeeping (Apiculture) 77  
Wine Growing (Viculture, Viticulture) 78  
Wine Cellar 79  
Garden and Field Pests 80  
House Insects, Food Pests, and Parasites 81  
Forest Pests 82  
Pest Control 83  
Forestry I 84  
Forestry II 85  
Hunting 86  
Hunting Weapons, Hunting Equipment 87  
Game 88  
Fish Farming (Fish Culture, Pisciculture) and Angling 89  
Sea Fishing 90

### Trades, Crafts, and Industry

Mills 91  
Malting and Brewing I 92  
Brewing II 93  
Slaughterhouse (Abattoir) 94

Meat Joints 95  
Butcher's Shop 96  
Bakery 97  
Grocer's Shop (*Am. Grocery Store*) 98  
Supermarket 99  
Shoemaker (Bootmaker) 100  
Shoes (Footwear) 101  
Needlework 102  
Dressmaker 103  
Tailor 104  
Ladies' Hairdresser 105  
Men's Hairdresser (Barber) 106  
Tobacco and Smoking Requisites 107  
Goldsmith, Silversmith 108  
Watchmaker, Clockmaker 109  
Clocks and Watches 110  
Optician 111  
Optical Instruments I 112  
Optical Instruments II 113  
Photography I 114  
Photography II 115  
Photography III 116  
Cine Film 117  
Building Site (Construction Site) I 118  
Building Site (Construction Site) II 119  
Carpenter 120  
Roof, Timber Joints 121  
Roof and Roofer 122  
Floor, Ceiling, Staircase Construction 123  
Glazier 124  
Plumber 125  
Plumber, Gas Fitter, Heating-Engineer 126  
Electrician 127  
Paperhanger 128  
Painter 129  
Cooper and Tank Construction Engineer 130  
Furrier 131  
Joiner I 132  
Joiner II 133  
Do-it-yourself 134  
Turner (Ivory Carver) 135  
Basket Maker 136  
Blacksmith (Smith) I 137  
Blacksmith (Smith) II (Farm Vehicle Engineering) 138  
Hammer Forging (Smith Forging) and Drop Forging 139  
Metalworker 140  
Gas Welder 141  
Arc Welder 142  
Sections, Bolts, and Machine Parts 143  
Coal Mine 144  
Mineral Oil (Oil, Petroleum) 145  
Offshore Drilling 146  
Iron and Steel Works 147  
Iron Foundry and Rolling Mill 148  
Machine Tools I 149  
Machine Tools II 150

Drawing Office 151  
Power Plant (Power Station) I 152  
Power Plant (Power Station) II 153  
Nuclear Energy 154  
Modern Sources of Energy 155  
Coking Plant 156  
Sawmill 157  
Quarry 158  
Brickworks (Brickyard, Brickfield) 159  
Cement Works (Cement Factory) 160  
Porcelain and China Manufacture 161  
Glass Production 162  
Cotton Spinning I 163  
Cotton Spinning II 164  
Weaving I 165  
Weaving II 166  
Knitting 167  
Finishing of Textile Fabrics 168  
Synthetic (Man-made) Fibres (*Am. Fibers*) I 169  
Synthetic (Man-made) Fibres (*Am. Fibers*) II 170  
Weaves and Knits 171  
Papermaking I 172  
Papermaking II 173

### Printing Industry

Composing Room (Case Room) I 174  
Composing Room (Case Room) II 175  
Composing Room (Case Room) III (Phototypesetting, Photocomposition, Photosetting, Filmsetting) 176  
Photomechanical Reproduction 177  
Electrotyping and Block Making 178  
Offset Platemaking 179  
Offset Printing 180  
Letterpress Printing 181  
Photogravure (Gravure Printing, Intaglio Printing) 182  
Bookbinding I 183  
Bookbinding II 184  
Bookbinding III 185

### Transport, Communications, and Information Technology

Horse-drawn Carriages 186  
Bicycle 187  
Motorcycles, Bicycles, Scooters, Mopeds 188  
Motorcycle 189  
Internal Combustion Engines 190  
Motor Car (*Am. Automobile*) I 191  
Motor Car (*Am. Automobile*) II 192  
Motor Car (*Am. Automobile*) III 193  
Lorries (*Am. Trucks*), Vans, Buses 194  
Garage (*Am. Shop*) 195  
Service Station 196  
Tram (*Am. Streetcar, Trolley*), Interurban Electric Train 197



Cross-section of a Street 198  
Refuse Disposal (*Am.* Garbage Disposition), Street Cleaning 199  
Road Construction I (Road Building, Road Making) 200  
Road Construction II (Road Building, Road Making) 201  
Railway Line (*Am.* Railroad Track) I 202  
Railway Line (*Am.* Railroad Track) II (Signalling Equipment) 203  
Station Hall 204  
Station Platform 205  
Goods Station (Freight Depot) 206  
Railway Vehicles (Rolling Stock) I 207  
Railway Vehicles (Rolling Stock) II 208  
Railway Vehicles (Rolling Stock) III 209  
Railway Vehicles (Rolling Stock) IV 210  
Railway Vehicles (Rolling Stock) V 211  
Railway Vehicles (Rolling Stock) VI 212  
Railway Vehicles (Rolling Stock) VII 213  
Mountain Railways (*Am.* Mountain Railroads) and Cableways 214  
Bridges 215  
Rivers and River Engineering 216  
Waterway and Hydraulic Engineering 217  
Types of Historical Ship 218  
Sailing Ship I 219  
Sailing Ship II 220  
Types of Ship 221  
Shipbuilding 222  
Motor Ship 223  
Navigation 224  
Docks, Port, Harbour (*Am.* Harbor) I 225  
Docks, Port, Harbour (*Am.* Harbor) II 226  
Salvage (Salving) and Towage 227  
Life Saving 228  
Aircraft I 229  
Aircraft II 230  
Aircraft III 231  
Aircraft IV 232  
Airport 233  
Space Flight I 234  
Space Flight II 235  
Post Office I 236  
Post Office II (Telephones and Telegraphy) 237  
Broadcasting (Radio and Television) I 238  
Broadcasting (Radio and Television) II 239  
Broadcasting III (Television Engineering) 240  
Music Systems (Audio Systems) 241  
Teaching Equipment and Information Technology 242  
Audiovision (AV) 243  
Computer Centre (*Am.* Center) 244

#### Office, Bank, Stock Exchange

Office I 245  
Office II 246  
Office III 247  
Office IV 248  
Office V 249  
Bank 250  
Stock Exchange 251

#### Community

Money (Coins and Notes, *Am.* Coins and Bills) 252  
Flags 253  
Heraldry, Crowns and Coronets 254  
Armed Forces I (Army) 255  
Armed Forces II (Air Force I) 256  
Armed Forces III (Air Force II) 257  
Warships I 258  
Warships II (Modern Fighting Ships) 259  
School I (Primary School) 260  
School II (Secondary School, High School) 261  
University 262  
Election 263  
Police 264  
Café 265  
Restaurant 266  
Hotel 267  
Town (Town Centre, *Am.* Downtown) 268  
Water Supply 269  
Fire Service (*Am.* Fire Department) 270  
Department Store 271  
Park 272

#### Recreation, Games, Sport

Children's Playground 273  
Spa 274  
Roulette 275  
Board Games and Party Games 276  
Billiards 277  
Camping and Caravanning (*Am.* Trailering) 278  
Surf Riding (Surfing), Skin Diving 279  
Bathing Beach 280  
Swimming Bath (Leisure Centre, *Am.* Center) 281  
Swimming 282  
Rowing and Canoeing 283  
Sailing (Yachting) I 284  
Sailing (Yachting) II 285  
Motorboats (Powerboats), Water Skiing 286  
Gliding (Soaring) 287  
Aerial Sports (Airsports) 288  
Horsemanship, Equestrian Sport 289  
Cycle Racing and Motorsports 290  
Ball Games I (Football, Association Football, Soccer) 291

Ball Games II 292  
Ball Games III 293  
Fencing 294  
Free Exercise 295  
Apparatus Gymnastics I 296  
Apparatus Gymnastics II (Women's Gymnastics) 297  
Athletics (Track and Field Events) 298  
Weightlifting and Combat Sports 299  
Mountaineering 300  
Winter Sports I (Skiing) 301  
Winter Sports II 302  
Winter Sports III 303  
Countryside in Winter 304  
Various Sports 305

#### Entertainment, Culture, and Art

Carnival 306  
Circus 307  
Fair, Fairground 308  
Flea Market 309  
Films (Motion Pictures) I 310  
Films (Motion Pictures) II 311  
Films (Motion Pictures) III 312  
Films (Motion Pictures) IV 313  
Ballet 314  
Theatre (*Am.* Theater) I 315  
Theatre (*Am.* Theater) II 316  
Discotheque 317  
Nightclub 318  
Bullfighting, Rodeo 319  
Musical Notation I 320  
Musical Notation II 321  
Musical Instruments I 322  
Musical Instruments II 323  
Musical Instruments III 324  
Musical Instruments IV 325  
Musical Instruments V 326  
Fabulous Creatures (Fabled Beings) 327  
Prehistory 328  
Chivalry 329  
Church I 330  
Church II 331  
Church III 332  
Art I 333  
Art II 334  
Art III 335  
Art IV 336  
Art V 337  
Artist's Studio 338  
Sculptor's Studio 339  
Graphic Art 340  
Script I 341

Script II 342  
Colour (*Am.* Color) 343  
Mathematics I 344  
Mathematics II 345  
Mathematics III (Geometry I) 346  
Mathematics IV (Geometry II) 347  
Mathematics V (Sets) 348  
Chemistry Laboratory I 349  
Chemistry Laboratory II 350  
Crystals, Crystallography 351  
Ethnology I 352  
Ethnology II 353  
Ethnology III 354  
Historical Costumes 355

#### Animals and Plants

Zoo (Zoological Gardens) 356  
Invertebrates 357  
Articulates 358  
Birds I 359  
Birds II (Indigenous Birds, Endemic Birds) 360  
Birds III (Passerines) 361  
Birds IV (Birds of Prey) 362  
Birds V (Exotic Birds) 363  
Fish, Amphibia, and Reptiles 364  
Lepidoptera (Butterflies and Moths) 365  
Mammals I 366  
Mammals II 367  
Mammals III 368  
Deep-sea Fauna 369  
General Botany 370  
Deciduous Trees 371  
Conifers 372  
Ornamental Shrubs and Trees I 373  
Ornamental Shrubs and Trees II 374  
Meadow Flowers and Wayside Flowers (Wild Flowers) I 375  
Meadow Flowers and Wayside Flowers (Wild Flowers) II 376  
Plants of Forest, Marsh, and Heathland 377  
Alpine Plants, Aquatic Plants (Water Plants), and Marsh Plants 378  
Poisonous Plants 379  
Medicinal Plants 380  
Edible Fungi (Esculent Fungi) 381  
Tropical Plants used as Stimulants, Spices, and Flavourings (*Am.* Flavorings) 382  
Plants used in Industry 383  
Southern Fruits (Tropical, Subtropical, and Mediterranean Fruits) 384



- 1-8 atom models
- 1 model of the hydrogen (H) atom
- 2 atomic nucleus, a proton
- 3 electron
- 4 electron spin
- 5 model of the helium (He) atom
- 6 electron shell
- 7 Pauli exclusion principle (exclusion principle, Pauli principle)
- 8 complete electron shell of the Na atom (sodium atom)
- 9-14 molecular structures (lattice structures)
- 9 crystal of sodium chloride (of common salt)
- 10 chlorine ion
- 11 sodium ion
- 12 crystal of cristobalite
- 13 oxygen atom
- 14 silicon atom
- 15 energy levels (possible quantum jumps) of the hydrogen atom
- 16 atomic nucleus (proton)
- 17 electron
- 18 ground state level
- 19 excited state
- 20-25 quantum jumps (quantum transitions)
- 20 Lyman series
- 21 Balmer series
- 22 Paschen series
- 23 Brackett series
- 24 Pfund series
- 25 free electron
- 26 Bohr-Sommerfeld model of the H atom
- 27 energy levels of the electron
- 28 spontaneous decay of radioactive material
- 29 atomic nucleus
- 30-31 alpha particle ( $\alpha$ , alpha radiation, helium nucleus)
- 30 neutron
- 31 proton
- 32 beta particle ( $\beta$ , beta radiation, electron)
- 33 gamma radiation ( $\gamma$ , a hard X-radiation)
- 34 nuclear fission:
- 35 heavy atomic nucleus
- 36 neutron bombardment

- 37-38 fission fragments
- 39 released neutron
- 40 gamma radiation ( $\gamma$ )
- 41 chain reaction
- 42 incident neutron
- 43 nucleus prior to fission
- 44 fission fragment
- 45 released neutron
- 46 repeated fission
- 47 fission fragment
- 48 controlled chain reaction in a nuclear reactor
- 49 atomic nucleus of a fissionable element
- 50 neutron bombardment
- 51 fission fragment (new atomic nucleus)
- 52 released neutron
- 53 absorbed neutrons
- 54 moderator, a retarding layer of graphite
- 55 extraction of heat (production of energy)
- 56 X-radiation
- 57 concrete and lead shield
- 58 bubble chamber for showing the tracks of high-energy ionizing particles
- 59 light source
- 60 camera
- 61 expansion line
- 62 path of light rays
- 63 magnet
- 64 beam entry point
- 65 reflector
- 66 chamber

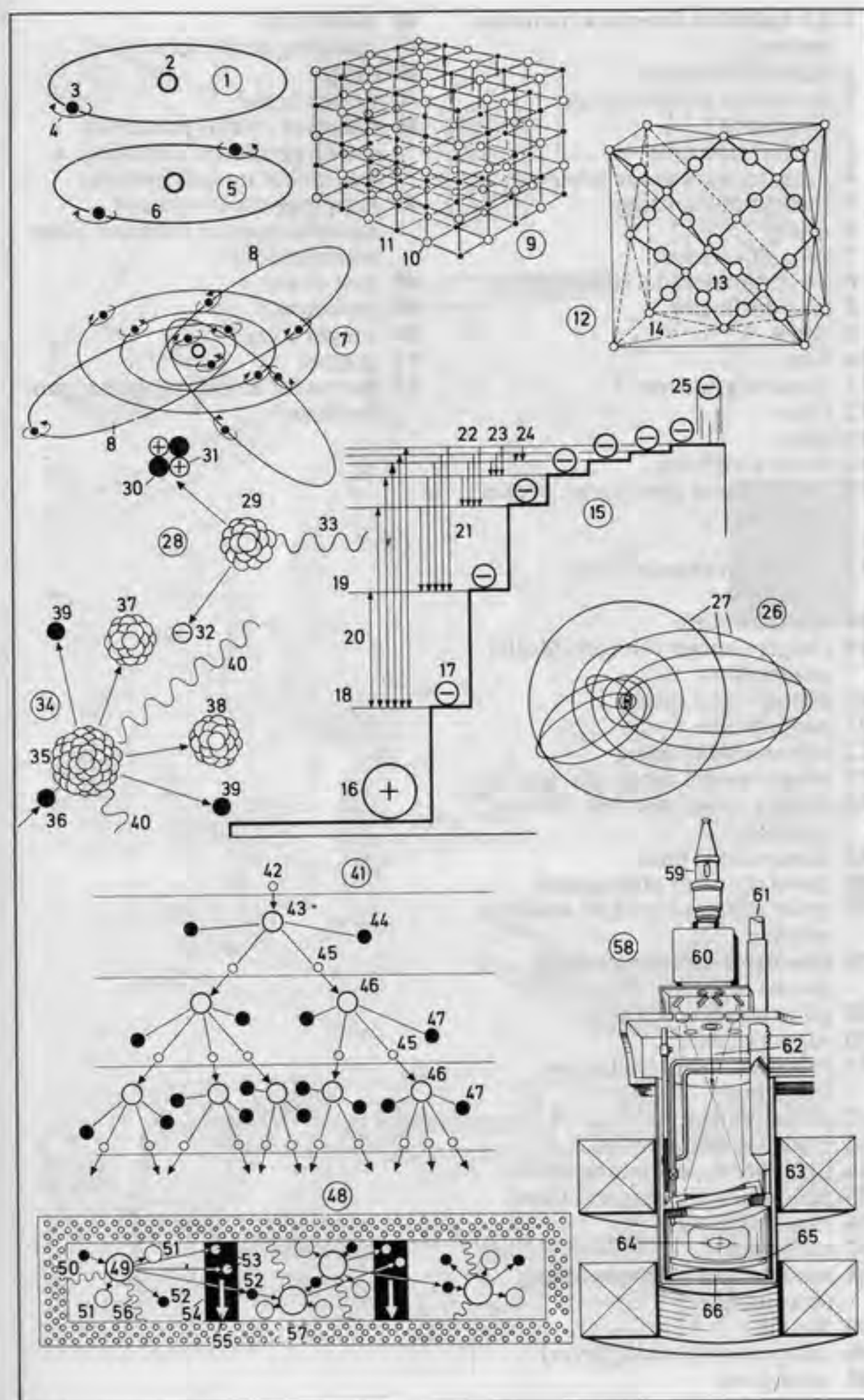



- 1-23 radiation detectors (radiation meters)
- 1 radiation monitor
- 2 ionization chamber (ion chamber)
- 3 central electrode
- 4 measurement range selector
- 5 instrument housing
- 6 meter
- 7 zero adjustment
- 8-23 dosimeter (dosemeter)
- 8 film dosimeter
- 9 filter
- 10 film
- 11 film-ring dosimeter
- 12 filter
- 13 film
- 14 cover with filter
- 15 pocket meter (pen meter, pocket chamber)
- 16 window
- 17 ionization chamber (ion chamber)
- 18 clip (pen clip)
- 19 Geiger counter (Geiger-Müller counter)
- 20 counter tube casing
- 21 counter tube
- 22 instrument housing
- 23 measurement range selector
- 24 Wilson cloud chamber (Wilson chamber)
- 25 compression plate
- 26 cloud chamber photograph
- 27 cloud chamber track of an alpha particle
- 28 telecobalt unit (coll. cobalt bomb)
- 29 pillar stand
- 30 support cables
- 31 radiation shield (radiation shielding)
- 32 sliding shield
- 33 bladed diaphragm
- 34 light-beam positioning device
- 35 pendulum device (pendulum)
- 36 irradiation table
- 37 rail (track)
- 38 manipulator with sphere unit (manipulator)
- 39 handle
- 40 safety catch (locking lever)
- 41 wrist joint
- 42 master arm
- 43 clamping device (clamp)
- 44 tongs
- 45 slotted board
- 46 radiation shield (protective shield, protective shielding), a lead shielding wall [section]
- 47 grasping arm of a pair of manipulators (of a master/slave manipulator)
- 48 dust shield
- 49 cyclotron
- 50 danger zone
- 51 magnet
- 52 pumps for emptying the vacuum chamber

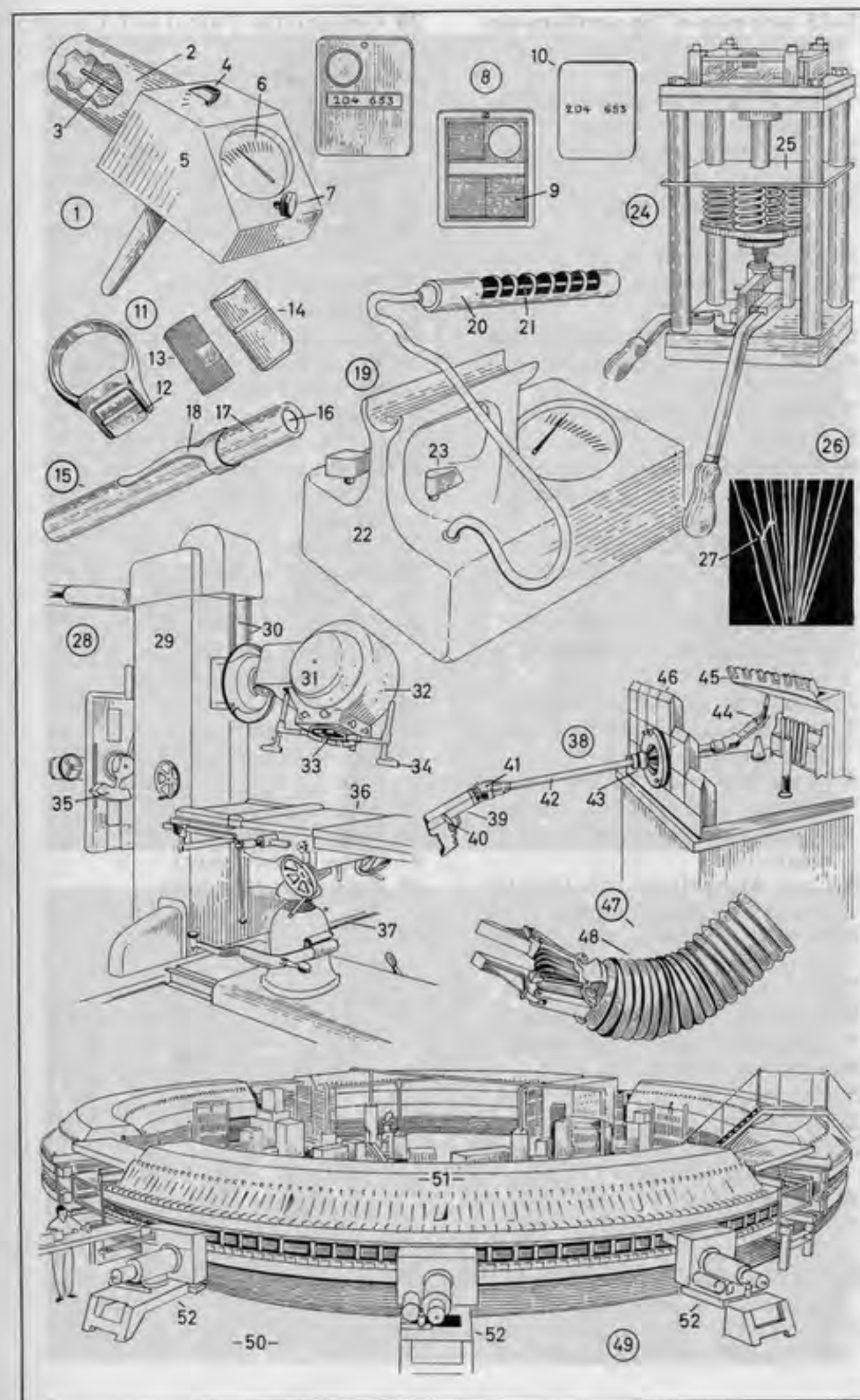



- 1-35 star map of the northern sky**  
(northern hemisphere)
- 1-8 divisions of the sky**
- 1 celestial pole with the Pole Star (Polaris, the North Star)
  - 2 ecliptic (apparent annual path of the sun)
  - 3 celestial equator (equinoctial line)
  - 4 tropic of Cancer
  - 5 circle enclosing circumpolar stars
  - 6-7 equinoctial points (equinoxes)
  - 6 vernal equinoctial point (first point of Aries)
  - 7 autumnal equinoctial point
  - 8 summer solstice (solstice)
- 9-48 constellations** (grouping of fixed stars into figures) **and names of stars**
- 9 Aquila (the Eagle) with Altair the principal star (the brightest star)
  - 10 Pegasus (the Winged Horse)
  - 11 Cetus (the Whale) with Mira, a variable star
  - 12 Eridanus (the Celestial River)
  - 13 Orion (the Hunter) with Rigel, Betelgeuse and Bellatrix
  - 14 Canis Major (the Great Dog, the Greater Dog) with Sirius (the Dog Star), a star of the first magnitude
  - 15 Canis Minor (the Little Dog, the Lesser Dog) with Procyon
  - 16 Hydra (the Water Snake, the Sea Serpent)
  - 17 Leo (the Lion)
  - 18 Virgo (the Virgin) with Spica
  - 19 Libra (the Balance, the Scales)
  - 20 Serpens (the Serpent)
  - 21 Hercules
  - 22 Lyra (the Lyre) with Vega
  - 23 Cygnus (the Swan, the Northern Cross) with Deneb
  - 24 Andromeda
  - 25 Taurus (the Bull) with Aldebaran
  - 26 The Pleiades (Pleiads, the Seven Sisters), an open cluster of stars
  - 27 Auriga (the Wagoner, the Charioteer) with Capella
  - 28 Gemini (the Twins) with Castor and Pollux
  - 29 Ursa Major (the Great Bear, the Greater Bear, the Plough, Charles's Wain, *Am.* the Big Dipper) with the double star (binary star) Mizar and Alcor
  - 30 Boötes (the Herdsman)
  - 31 Corona Borealis (the Northern Crown)
  - 32 Draco (the Dragon)
  - 33 Cassiopeia
  - 34 Ursa Minor (the Little Bear, Lesser Bear, *Am.* Little Dipper) with the Pole Star (Polaris, the North Star)
- 35 the Milky Way (the Galaxy)**
- 36-48 the southern sky**
- 36 Capricorn (the Goat, the Sea Goat)
  - 37 Sagittarius (the Archer)
  - 38 Scorpio (the Scorpion)
  - 39 Centaurus (the Centaur)
  - 40 Triangulum Australe (the Southern Triangle)
  - 41 Pavo (the Peacock)
  - 42 Grus (the Crane)
  - 43 Octans (the Octant)
  - 44 Crux (the Southern Cross, the Cross)
  - 45 Argo (the Celestial Ship)
  - 46 Carina (the Keel)
  - 47 Pictor (the Painter)
  - 48 Reticulum (the Net)

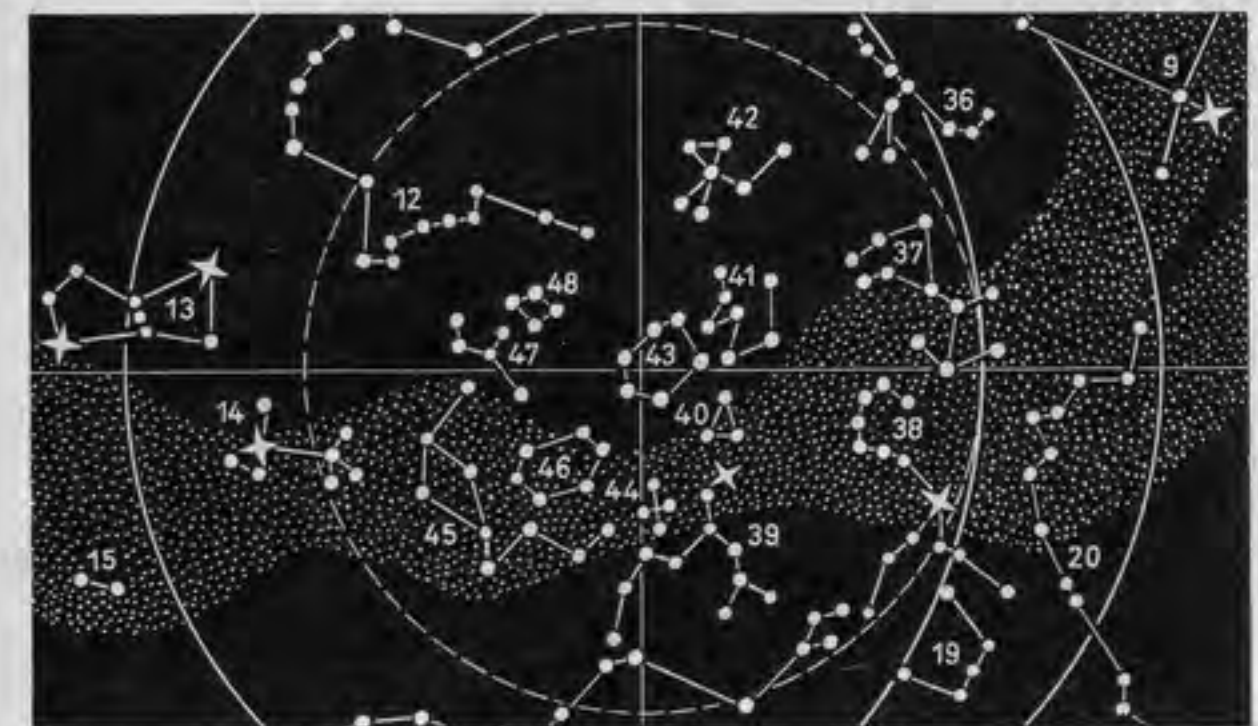
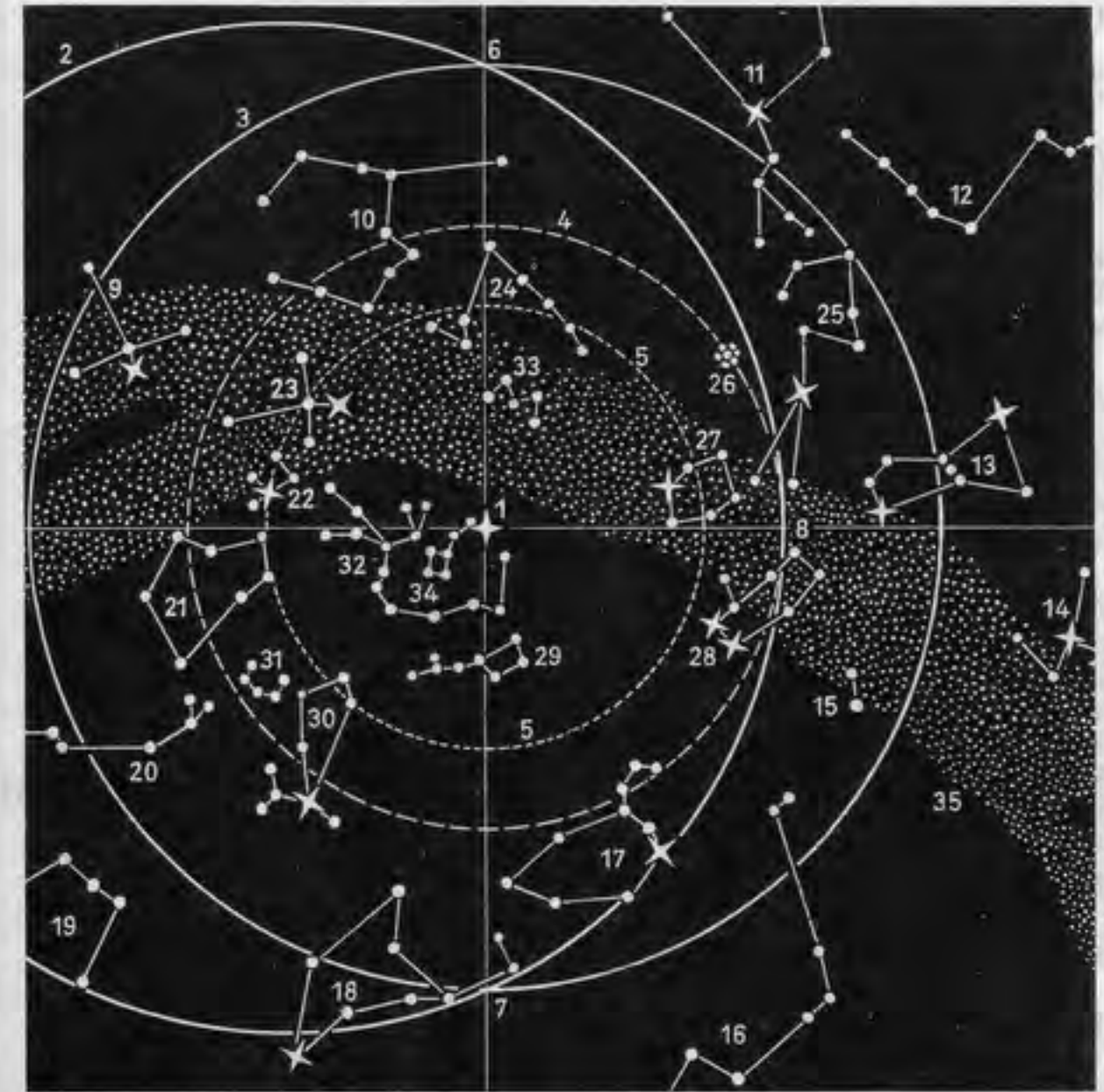



- 1-9 the moon
- 1 moon's path (moon's orbit round the earth)
- 2-7 lunar phases (moon's phases, lunation)
- 2 new moon
- 3 crescent (crescent moon, waxing moon)
- 4 half-moon (first quarter)
- 5 full moon
- 6 half-moon (last quarter, third quarter)
- 7 crescent (crescent moon, waning moon)
- 8 the earth (terrestrial globe)
- 9 direction of the sun's rays
- 10-21 apparent path of the sun at the beginning of the seasons
- 10 celestial axis
- 11 zenith
- 12 horizontal plane
- 13 nadir
- 14 east point
- 15 west point
- 16 north point
- 17 south point
- 18 apparent path of the sun on 21 December
- 19 apparent path of the sun on 21 March and 23 September
- 20 apparent path of the sun on 21 June
- 21 border of the twilight area
- 22-28 rotary motions of the earth's axis
- 22 axis of the ecliptic
- 23 celestial sphere
- 24 path of the celestial pole (precession and nutation)
- 25 instantaneous axis of rotation
- 26 celestial pole
- 27 mean axis of rotation
- 28 polhode
- 29-35 solar and lunar eclipse [not to scale]
- 29 the sun
- 30 the earth
- 31 the moon
- 32 solar eclipse
- 33 area of the earth in which the eclipse appears total
- 34-35 lunar eclipse
- 34 penumbra (partial shadow)
- 35 umbra (total shadow)
- 36-41 the sun
- 36 solar disc (disk) (solar globe, solar sphere)
- 37 sunspots
- 38 cyclones in the area of sunspots
- 39 corona (solar corona), observable during total solar eclipse or by means of special instruments
- 40 prominences (solar prominences)
- 41 moon's limb during a total solar eclipse
- 42-52 planets (planetary system, solar system) [not to scale] and planet symbols
- 42 the sun
- 43 Mercury
- 44 Venus
- 45 Earth, with the moon, a satellite
- 46 Mars, with two moons (satellites)
- 47 asteroids (minor planets)
- 48 Jupiter, with 14 moons (satellites)
- 49 Saturn, with 10 moons (satellites)
- 50 Uranus, with five moons (satellites)
- 51 Neptune, with two moons (satellites)
- 52 Pluto
- 53-64 signs of the zodiac (zodiacal signs)
- 53 Aries (the Ram)
- 54 Taurus (the Bull)
- 55 Gemini (the Twins)
- 56 Cancer (the Crab)
- 57 Leo (the Lion)
- 58 Virgo (the Virgin)
- 59 Libra (the Balance, the Scales)
- 60 Scorpio (the Scorpion)
- 61 Sagittarius (the Archer)
- 62 Capricorn (the Goat, the Sea Goat)
- 63 Aquarius (the Water Carrier, the Water Bearer)
- 64 Pisces (the Fish)

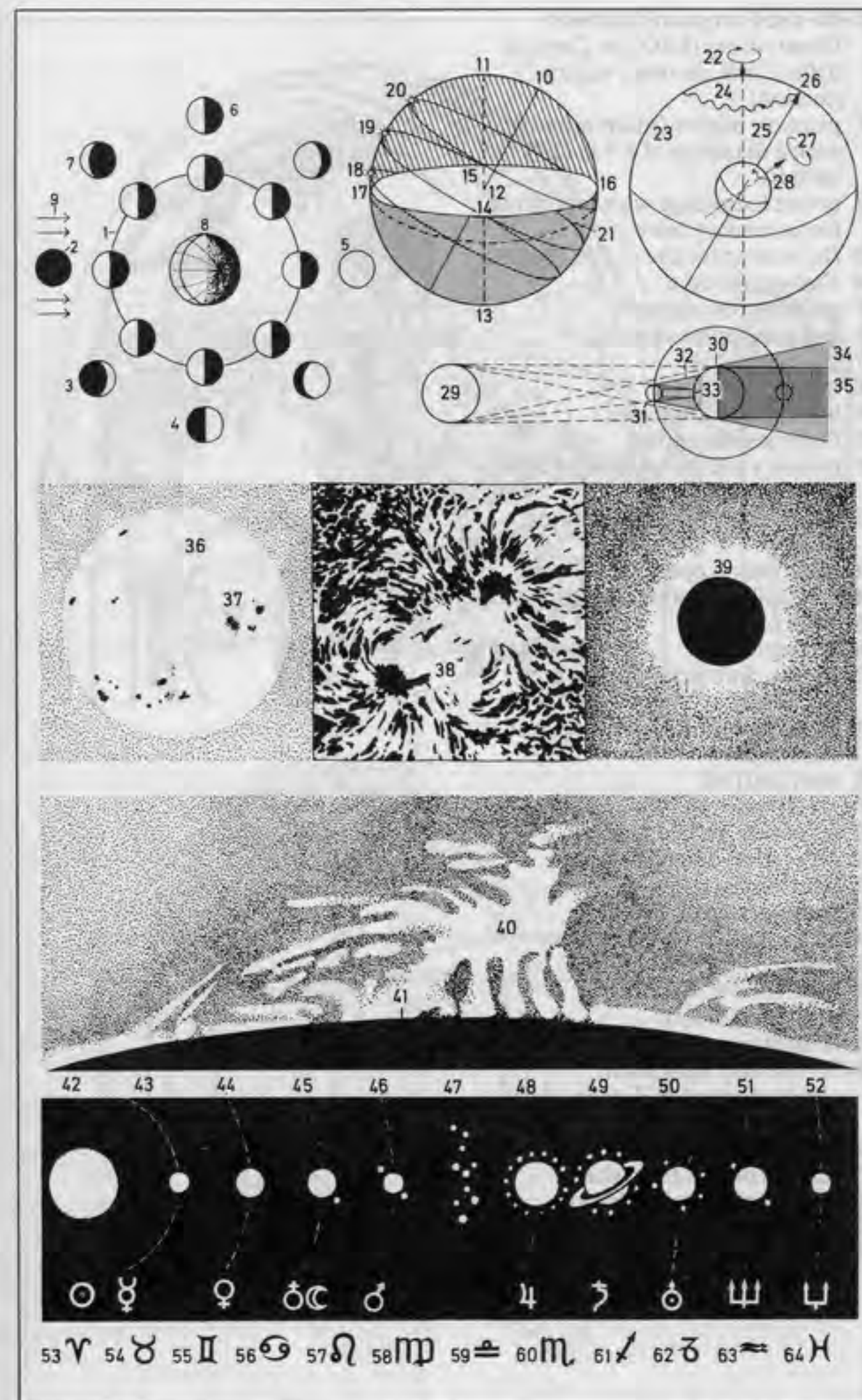



- 1-16 the European Southern Observatory (ESO) on *Cerro la Silla, Chile*, an observatory [section]
- 1 primary mirror (main mirror) with a diameter of 3.6 m (144 inches)
  - 2 prime focus cage with mounting for secondary mirrors
  - 3 flat mirror for the coudé ray path
  - 4 Cassegrain cage
  - 5 grating spectrograph
  - 6 spectrographic camera
  - 7 hour axis drive
  - 8 hour axis
  - 9 horseshoe mounting
  - 10 hydrostatic bearing
  - 11 primary and secondary focusing devices
  - 12 observatory dome (revolving dome)
  - 13 observation opening
  - 14 vertically movable dome shutter
  - 15 wind screen
  - 16 siderostat
- 17-28 the *Stuttgart Planetarium* [section]
- 17 administration, workshop, and store area
  - 18 steel scaffold
  - 19 glass pyramid
  - 20 revolving arched ladder
  - 21 projection dome
  - 22 light stop
  - 23 planetarium projector
  - 24 well
  - 25 foyer
  - 26 theatre (*Am. theater*)
  - 27 projection booth
  - 28 foundation pile
- 29-33 the *Kitt Peak solar observatory near Tucson, Ariz.* [section]
- 29 heliostat
  - 30 sunken observation shaft
  - 31 water-cooled windshield
  - 32 concave mirror
  - 33 observation room housing the spectrograph

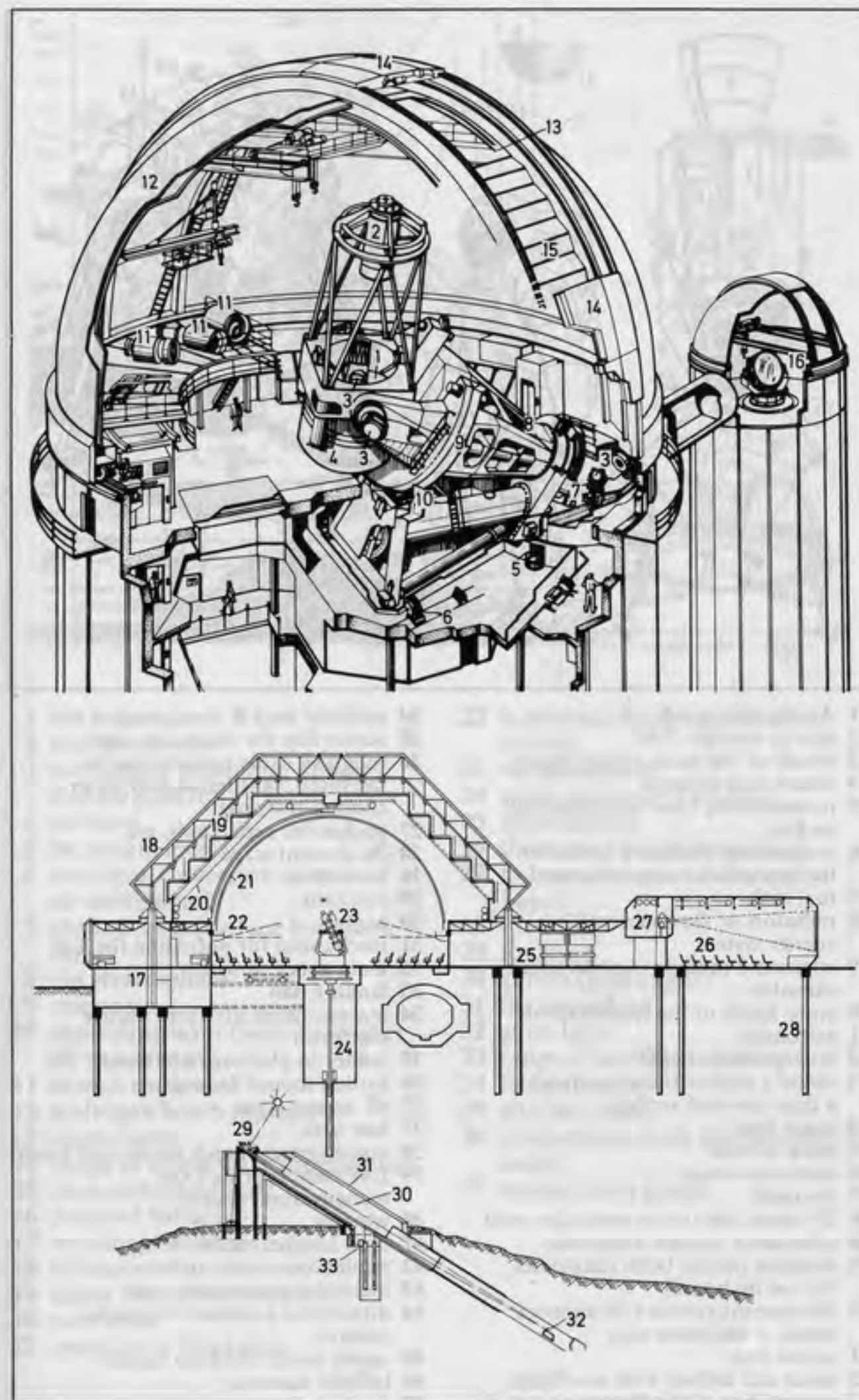



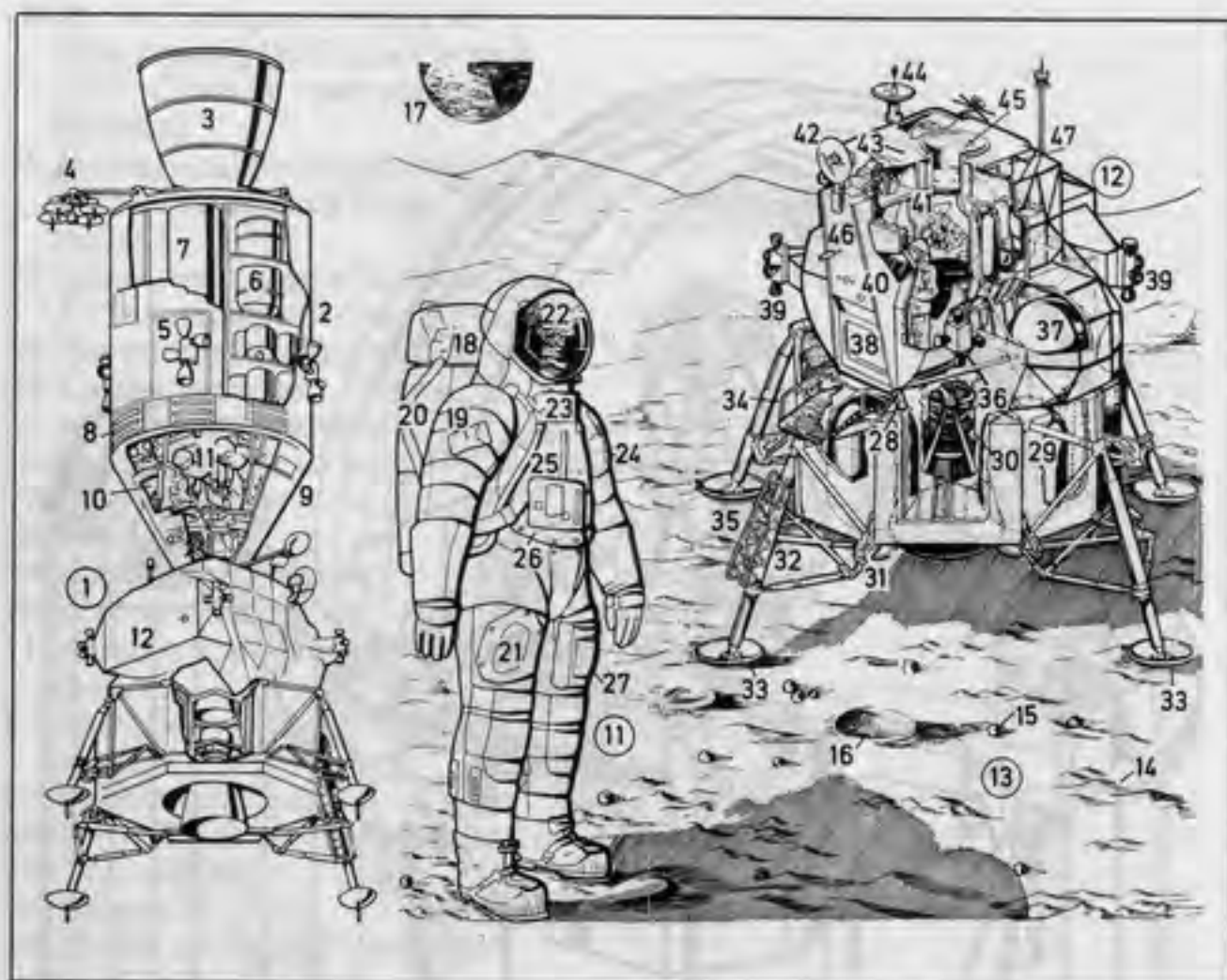

- |  |   |
|--|---|
| 1 Apollo spacecraft  | 24 penlight pocket  |
| 2 service module (SM)  | 25 access flap for the purge valve  |
| 3 nozzle of the main rocket engine                             | 26 tube and cable connections for the radio, ventilation, and water-cooling systems |
| 4 directional antenna  | 27 pocket for pens, tools, etc.   |
| 5 manoeuvring ( <i>Am.</i> maneuvering) rockets                | 28-36 descent stage   |
| 6 oxygen and hydrogen tanks for the spacecraft's energy system | 28 connector  |
| 7 fuel tank  | 29 fuel tank  |
| 8 radiators of the spacecraft's energy system                  | 30 engine   |
| 9 command module (Apollo space capsule)                        | 31 mechanism for unfolding the legs   |
| 10 entry hatch of the space capsule                            | 32 main shock absorber  |
| 11 astronaut   | 33 landing pad  |
| 12 lunar module (LM)   | 34 ingress/egress platform (hatch platform)   |
| 13 moon's surface (lunar surface), a dust-covered surface      | 35 ladder to platform and hatch   |
| 14 lunar dust  | 36 cardan mount for engine  |
| 15 piece of rock   | 37-47 ascent stage  |
| 16 meteorite crater  | 37 fuel tank  |
| 17 the earth   | 38 ingress/egress hatch (entry/exit hatch)  |
| 18-27 space suit (extra-vehicular suit)                        | 39 LM manoeuvring ( <i>Am.</i> maneuvering) rockets                                 |
| 18 emergency oxygen apparatus                                  | 40 window   |
| 19 sunglass pocket [with sunglasses for use on board]          | 41 crew compartment   |
| 20 life support system (life support pack), a backpack unit    | 42 rendezvous radar antenna   |
| 21 access flap   | 43 inertial measurement unit  |
| 22 space suit helmet with sun filters                          | 44 directional antenna for ground control   |
| 23 control box of the life support pack                        | 45 upper hatch (docking hatch)  |
|  | 46 inflight antenna   |
|  | 47 docking target recess  |

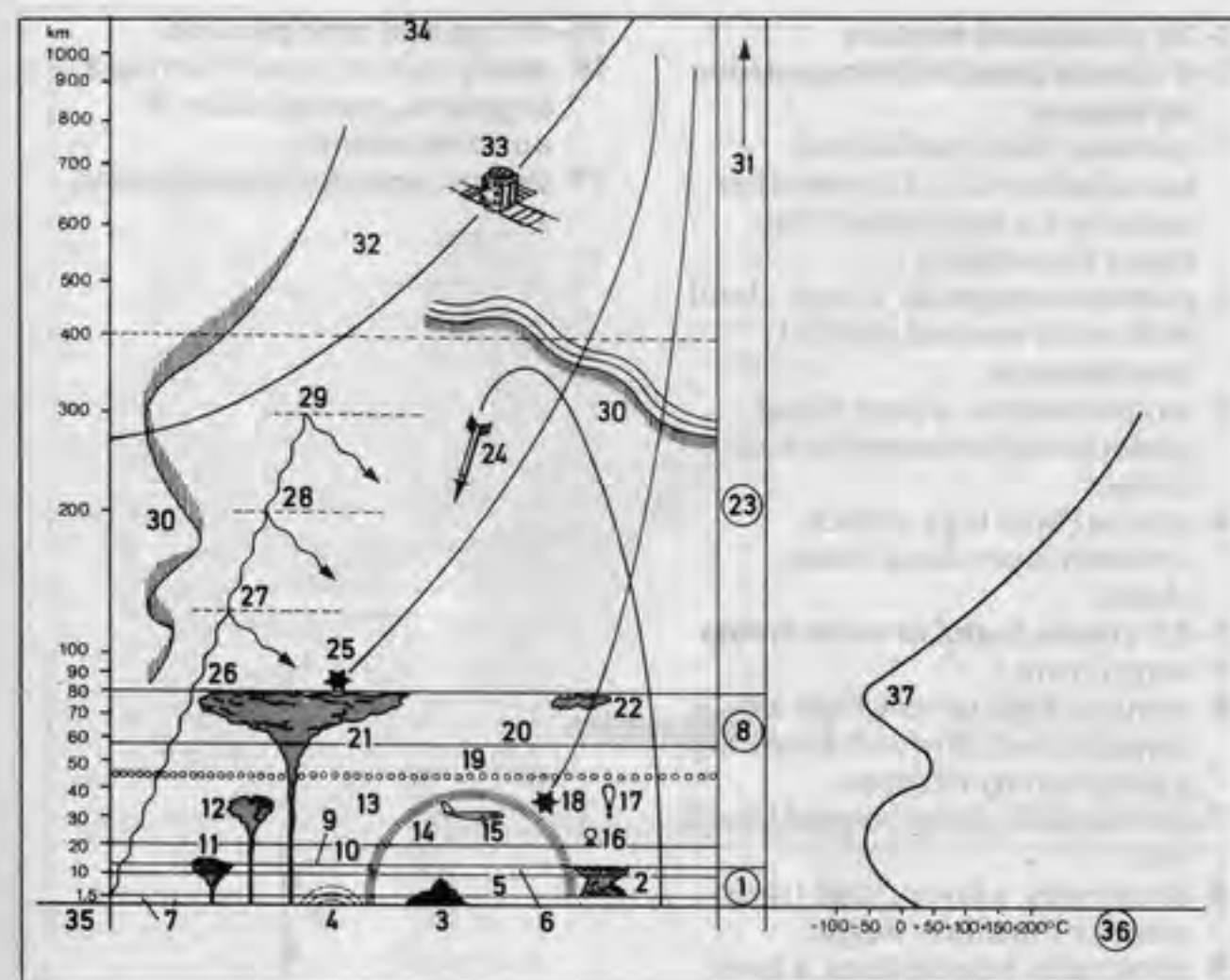

- |   |   |
|---|---|
| 1 the troposphere                                     | 22 luminous clouds (noctilucent clouds)   |
| 2 thunderclouds                                       | 23 the ionosphere                         |
| 3 the highest mountain, <i>Mount Everest</i> [8,882m] | 24 range of research rockets              |
| 4 rainbow   | 25 shooting star                          |
| 5 jet stream level                                    | 26 short wave (high frequency)            |
| 6 zero level (inversion of vertical air movement)     | 27 E-layer (Heaviside-Kennelly Layer)     |
| 7 ground layer (surface boundary layer)               | 28 F <sub>1</sub> -layer                  |
| 8 the stratosphere                                    | 29 F <sub>2</sub> -layer                  |
| 9 tropopause  | 30 aurora (polar light)                   |
| 10 separating layer (layer of weaker air movement)    | 31 the exosphere                          |
| 11 atomic explosion                                   | 32 atom layer                             |
| 12 hydrogen bomb explosion                            | 33 range of satellite sounding            |
| 13 ozone layer  | 34 fringe region                          |
| 14 range of sound wave propagation                    | 35 altitude scale                         |
| 15 stratosphere aircraft                              | 36 temperature scale (thermometric scale) |
| 16 manned balloon                                     | 37 temperature graph                      |
| 17 sounding balloon                                   |   |
| 18 meteor   |   |
| 19 upper limit of ozone layer                         |   |
| 20 zero level   |   |
| 21 eruption of Krakatoa                               |   |



1-19 clouds and weather

1-4 clouds found in homogeneous air masses

- 1 cumulus (woolpack cloud, cumulus humilis, fair-weather cumulus), a heap cloud (flat-based heap cloud)
- 2 cumulus congestus, a heap cloud with more marked vertical development
- 3 stratocumulus, a layer cloud (sheet cloud) arranged in heavy masses
- 4 stratus (high fog), a thick, uniform layer cloud (sheet cloud)

5-12 clouds found at warm fronts

- 5 warm front
- 6 cirrus, a high to very high ice-crystal cloud, thin and assuming a wide variety of forms
- 7 cirrostratus, an ice-crystal cloud veil
- 8 altostratus, a layer cloud (sheet cloud) of medium height
- 9 altostratus praecipitans, a layer cloud (sheet cloud) with precipitation in its upper parts
- 10 nimbostratus, a rain cloud, a layer cloud (sheet cloud) of very large vertical extent which produces precipitation (rain or snow)

- 11 fractostratus, a ragged cloud occurring beneath nimbostratus
- 12 fractocumulus, a ragged cloud like 11 but with billowing shapes

13-17 clouds at cold fronts

- 13 cold front
- 14 cirrocumulus, thin fleecy cloud in the form of globular masses; covering the sky: mackerel sky
- 15 altocumulus, a cloud in the form of large globular masses
- 16 altocumulus castellanus and altocumulus floccus, species of 15
- 17 cumulonimbus, a heap cloud of very large vertical extent, to be classified under 1-4 in the case of tropical storms

18-19 types of precipitation

- 18 steady rain or snow covering a large area, precipitation of uniform intensity
- 19 shower, scattered precipitation

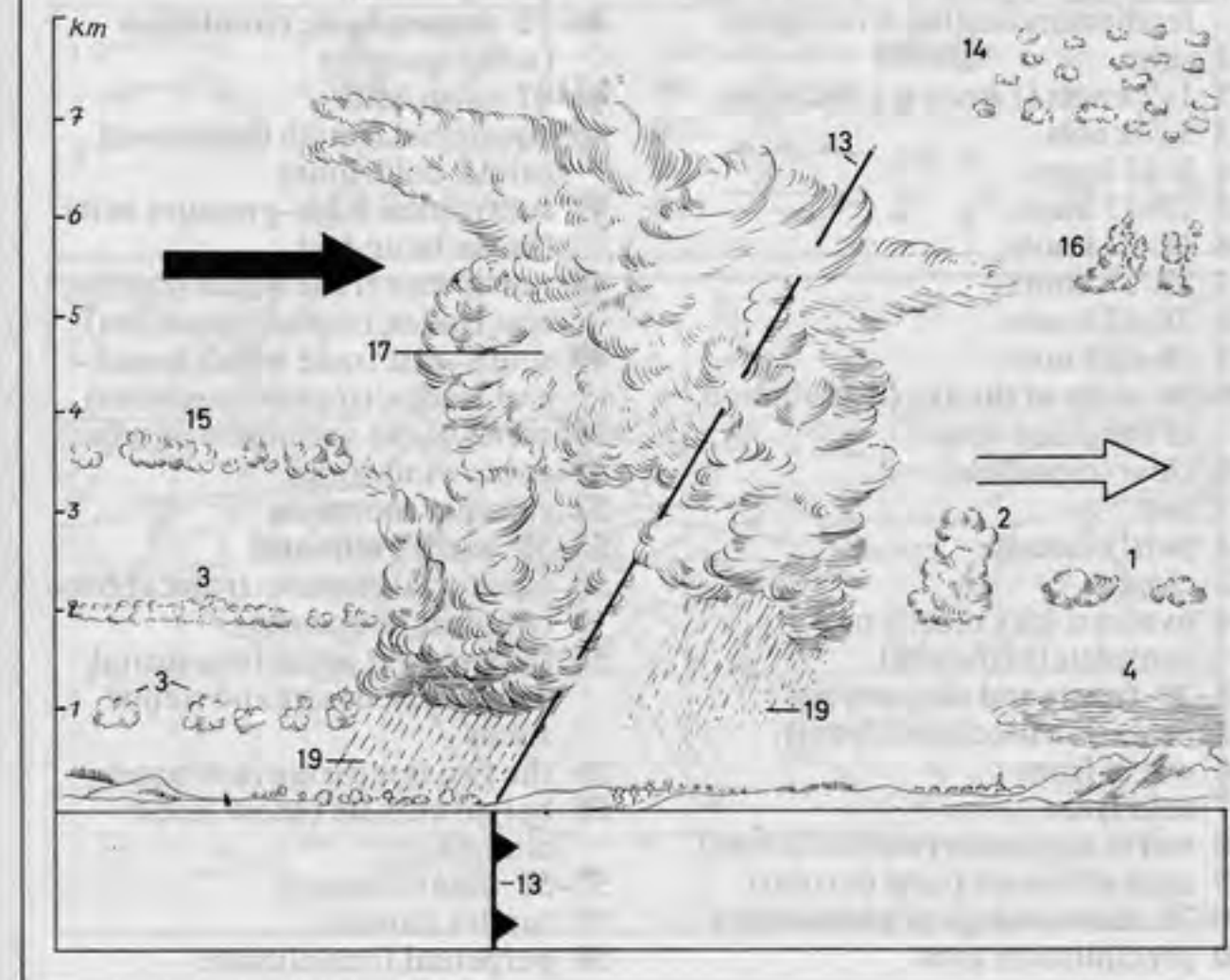
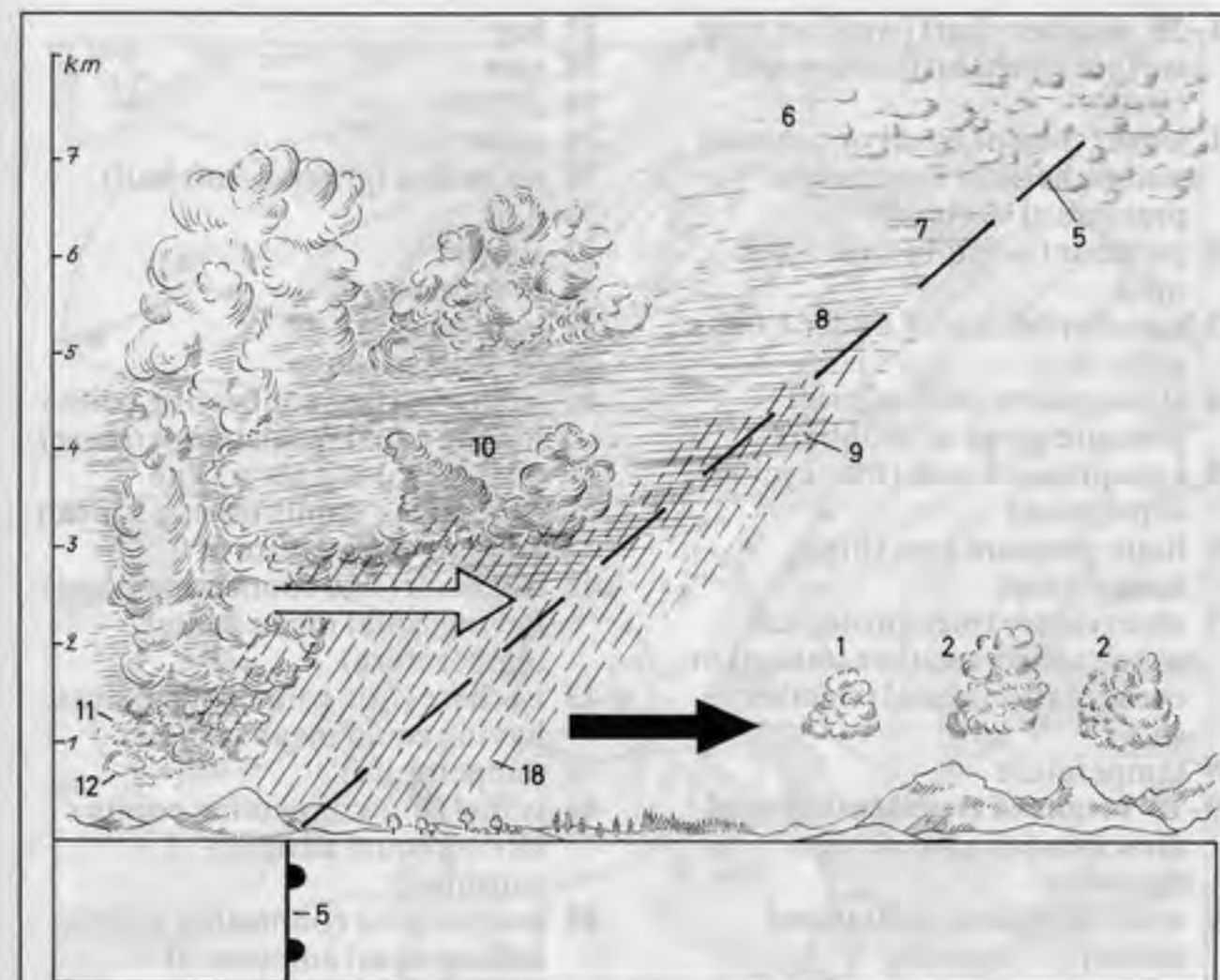

black arrow = cold air      white arrow = warm air



- 1-39 weather chart (weather map, surface chart, surface synoptic chart)
- 1 isobar (line of equal or constant atmospheric or barometric pressure at sea level)
- 2 pleiobar (isobar of over 1,000 mb)
- 3 meiobar (isobar of under 1,000 mb)
- 4 atmospheric (barometric) pressure given in millibars
- 5 low-pressure area (low, cyclone, depression)
- 6 high-pressure area (high, anticyclone)
- 7 observatory (meteorological watch office, weather station) or ocean station vessel (weather ship)
- 8 temperature
- 9-19 means of representing wind direction (wind-direction symbols)
- 9 wind-direction shaft (wind arrow)
- 10 wind-speed barb (wind-speed feather) indicating wind speed
- 11 calm
- 12 1-2 knots (1 knot = 1.852 kph)
- 13 3-7 knots
- 14 8-12 knots
- 15 13-17 knots
- 16 18-22 knots
- 17 23-27 knots
- 18 28-32 knots
- 19 58-62 knots
- 20-24 state of the sky (distribution of the cloud cover)
- 20 clear (cloudless)
- 21 fair
- 22 partly cloudy
- 23 cloudy
- 24 overcast (sky mostly or completely covered)
- 25-29 fronts and air currents
- 25 occlusion (occluded front)
- 26 warm front
- 27 cold front
- 28 warm airstream (warm current)
- 29 cold airstream (cold current)
- 30-39 meteorological phenomena
- 30 precipitation area

- 31 fog
- 32 rain
- 33 drizzle
- 34 snow
- 35 ice pellets (graupel, soft hail)
- 36 hail
- 37 shower
- 38 thunderstorm
- 39 lightning
- 40-58 climatic map
- 40 isotherm (line connecting points having equal mean temperature)
- 41 0 °C (zero) isotherm (line connecting points having a mean annual temperature of 0 °C)
- 42 isocheim (line connecting points having equal mean winter temperature)
- 43 isothere (line connecting points having equal mean summer temperature)
- 44 isohel (line connecting points having equal duration of sunshine)
- 45 isohyet (line connecting points having equal amounts of precipitation)
- 46-52 atmospheric circulation (wind systems)
- 46-47 calm belts
- 46 equatorial trough (equatorial calms, doldrums)
- 47 subtropical high-pressure belts (horse latitudes)
- 48 north-east trade winds (north-east trades, tropical easterlies)
- 49 south-east trade winds (south-east trades, tropical easterlies)
- 50 zones of the variable westerlies
- 51 polar wind zones
- 52 summer monsoon
- 53-58 earth's climates
- 53 equatorial climate: tropical zone (tropical rain zone)
- 54 the two arid zones (equatorial dry zones): desert and steppe zones
- 55 the two temperate rain zones
- 56 boreal climate (snow forest climate)
- 57-58 polar climates
- 57 tundra climate
- 58 perpetual frost climate

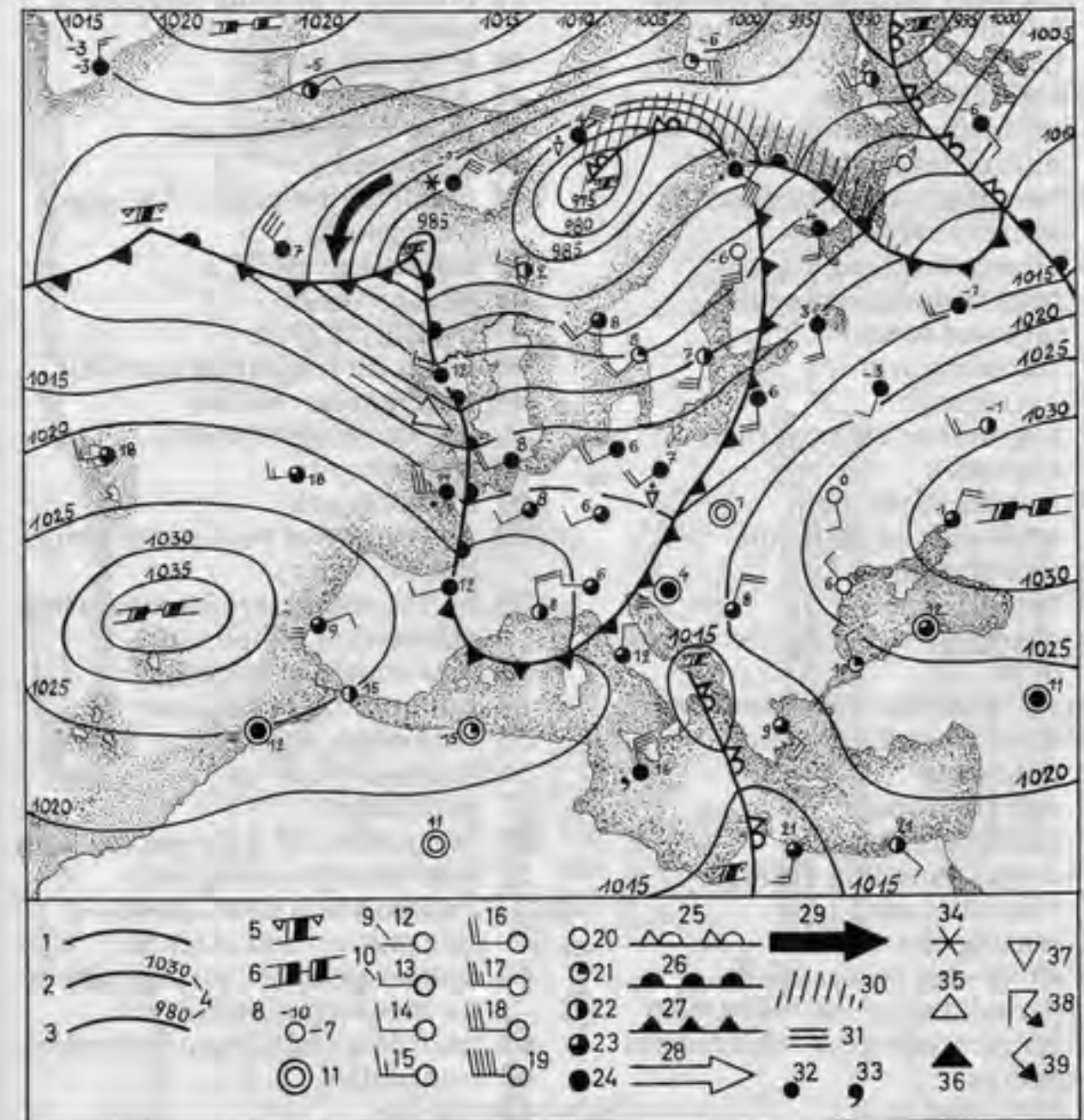



- |  |  |
|--|--|
| 1 mercury barometer, a siphon barometer, a liquid-column barometer                               | 39 protective housing (protective casing)                                    |
| 2 mercury column   | 40 collecting vessel   |
| 3 millibar scale (millimetre, <i>Am.</i> millimeter, scale)                                      | 41 rain cover  |
| 4 barograph, a self-registering aneroid barometer  | 42 recording mechanism   |
| 5 drum (recording drum)  | 43 siphon tube   |
| 6 bank of aneroid capsules (aneroid boxes)   | 44 precipitation gauge ( <i>Am.</i> gage) (rain gauge)                       |
| 7 recording arm  | 45 collecting vessel   |
| 8 hygrograph   | 46 storage vessel  |
| 9 hygrometer element (hair element)  | 47 measuring glass   |
| 10 reading adjustment  | 48 insert for measuring snowfall   |
| 11 amplitude adjustment  | 49 thermometer screen (thermometer shelter)                                  |
| 12 recording arm   | 50 hygrograph  |
| 13 recording pen   | 51 thermograph   |
| 14 change gears for the clockwork drive  | 52 psychrometer (wet and dry bulb thermometer)                               |
| 15 off switch for the recording arm  | 53-54 thermometers for measuring extremes of temperature                     |
| 16 drum (recording drum)   | 53 maximum thermometer   |
| 17 time scale  | 54 minimum thermometer   |
| 18 case (housing)  | 55 radiosonde assembly   |
| 19 thermograph   | 56 hydrogen balloon  |
| 20 drum (recording drum)   | 57 parachute   |
| 21 recording arm   | 58 radar reflector with spacing lines  |
| 22 sensing element   | 59 instrument housing with radiosonde (a short-wave transmitter) and antenna |
| 23 silver-disc (silver-disk) pyrheliometer, an instrument for measuring the sun's radiant energy | 60 transmissometer, an instrument for measuring visibility                   |
| 24 silver disc (disk)  | 61 recording instrument (recorder)   |
| 25 thermometer   | 62 transmitter   |
| 26 wooden insulating casing  | 63 receiver  |
| 27 tube with diaphragm (diaphragmed tube)  | 64 weather satellite (ITOS satellite)  |
| 28 wind gauge ( <i>Am.</i> gage) (anemometer)  | 65 temperature regulation flaps  |
| 29 wind-speed indicator (wind-speed meter)   | 66 solar panel   |
| 30 cross arms with hemispherical cups  | 67 television camera   |
| 31 wind-direction indicator  | 68 antenna   |
| 32 wind vane   | 69 solar sensor (sun sensor)   |
| 33 aspiration psychrometer   | 70 telemetry antenna   |
| 34 dry bulb thermometer  | 71 radiometer  |
| 35 wet bulb thermometer  |  |
| 36 solar radiation shielding   |  |
| 37 suction tube  |  |
| 38 recording rain gauge ( <i>Am.</i> gage)   |  |

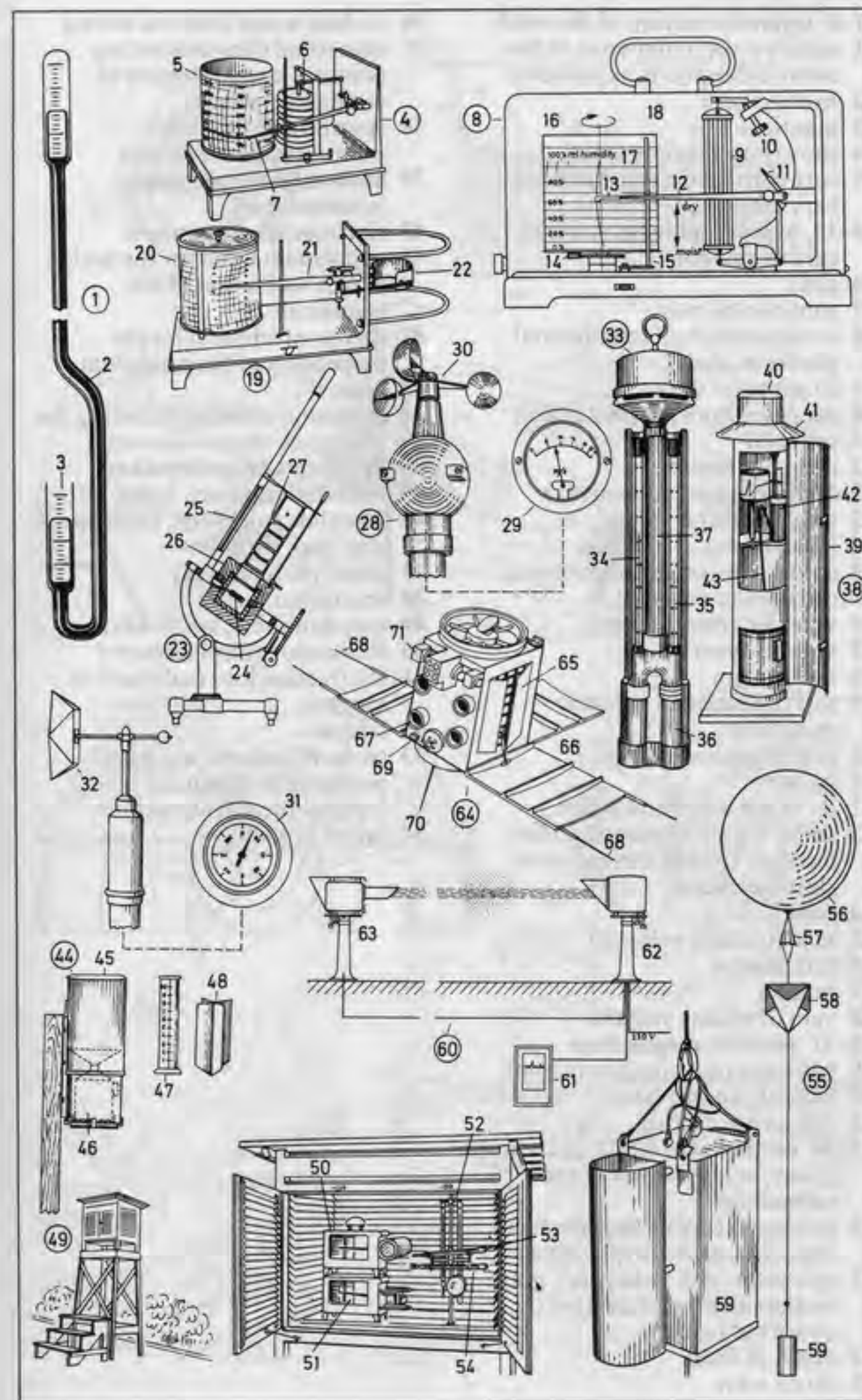



- 1-5 layered structure of the earth
- 1 earth's crust (outer crust of the earth, lithosphere, oxysphere)
- 2 hydrosphere
- 3 mantle
- 4 sima (intermediate layer)
- 5 core (earth core, centrosphere, barysphere)
- 6-12 hypsographic curve of the earth's surface
- 6 peak
- 7 continental mass
- 8 continental shelf (continental platform, shelf)
- 9 continental slope
- 10 deep-sea floor (abyssal plane)
- 11 sea level
- 12 deep-sea trench
- 13-28 volcanism (vulcanicity)
- 13 shield volcano
- 14 lava plateau
- 15 active volcano, a stratovolcano (composite volcano)
- 16 volcanic crater (crater)
- 17 volcanic vent
- 18 lava stream
- 19 tuff (fragmented volcanic material)
- 20 subterranean volcano
- 21 geyser
- 22 jet of hot water and steam
- 23 sinter terraces (siliceous sinter terraces, fiorite terraces, pearl sinter terraces)
- 24 cone
- 25 maar (extinct volcano)
- 26 tuff deposit
- 27 breccia
- 28 vent of extinct volcano
- 29-31 plutonic magmatism
- 29 batholite (massive protrusion)
- 30 lacolith, an intrusion
- 31 sill, an ore deposit
- 32-38 earthquake (kinds: tectonic quake, volcanic quake) and seismology
- 32 earthquake focus (seismic focus, hypocentre, *Am.* hypocenter)
- 33 epicentre (*Am.* epicenter), point on the earth's surface directly above the focus
- 34 depth of focus
- 35 shock wave

- 36 surface waves (seismic waves)
- 37 isoseismal (line connecting points of equal intensity of earthquake shock)
- 38 epicentral area (area of macroseismic vibration)
- 39 horizontal seismograph (seismometer)
- 40 electromagnetic damper
- 41 adjustment knob for the period of free oscillation of the pendulum
- 42 spring attachment for the suspension of the pendulum
- 43 mass
- 44 induction coils for recording the voltage of the galvanometer
- 45-54 effects of earthquakes
- 45 waterfall (cataract, falls)
- 46 landslide (rockslide, landslip, *Am.* rock slip)
- 47 talus (rubble, scree)
- 48 scar (scaur, scaw)
- 49 sink (sinkhole, swallowhole)
- 50 dislocation (displacement)
- 51 solifluction lobe (solifluction tongue)
- 52 fissure
- 53 tsunami (seismic sea wave) produced by seaquake (submarine earthquake)
- 54 raised beach

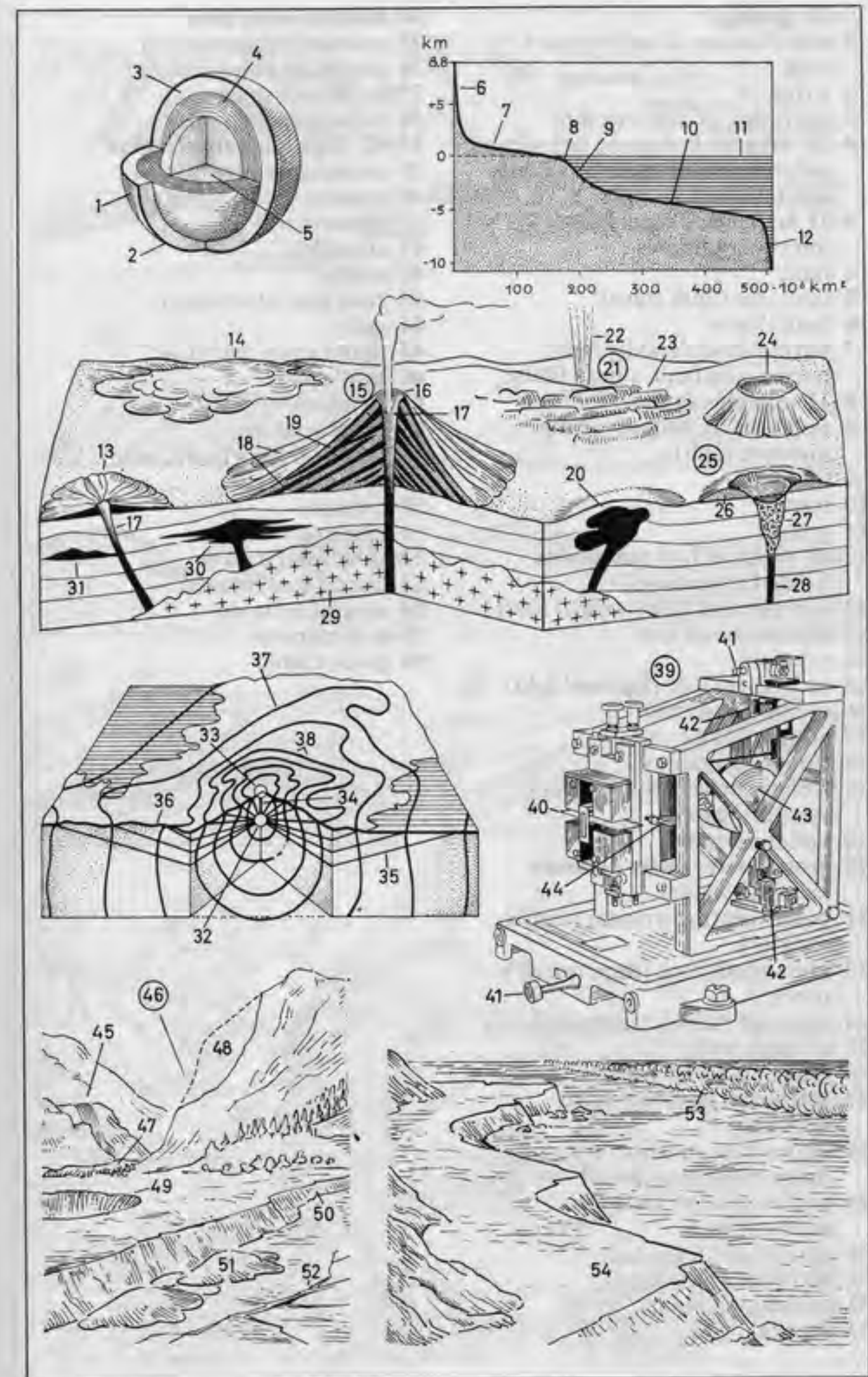



1-33 geology

- 1 stratification of sedimentary rock
- 2 strike
- 3 dip (angle of dip, true dip)
- 4-20 orogeny (orogenesis, tectogenesis, deformation of rocks by folding and faulting)
- 4-11 fault-block mountains (block mountains)
- 4 fault
- 5 fault line (fault trace)
- 6 fault throw
- 7 normal fault (gravity fault, normal slip fault, slump fault)
- 8-11 complex faults
- 8 step fault (distributive fault, multiple fault)
- 9 tilt block
- 10 horst
- 11 graben
- 12-20 range of fold mountains (folded mountains)
- 12 symmetrical fold (normal fold)
- 13 asymmetrical fold
- 14 overfold
- 15 recumbent fold (reclined fold)
- 16 saddle (anticline)
- 17 anticlinal axis
- 18 trough (syncline)
- 19 trough surface (trough plane, synclinal axis)
- 20 anticlinorium
- 21 groundwater under pressure (artesian water)
- 22 water-bearing stratum (aquifer, aquifer)
- 23 impervious rock (impermeable rock)
- 24 drainage basin (catchment area)
- 25 artesian well
- 26 rising water, an artesian spring
- 27 petroleum reservoir in an anticline
- 28 impervious stratum (impermeable stratum)
- 29 porous stratum acting as reservoir rock
- 30 natural gas, a gas cap
- 31 petroleum (crude oil)
- 32 underlying water
- 33 derrick

34 mountainous area

- 35 rounded mountain top
- 36 mountain ridge (ridge)
- 37 mountain slope
- 38 hillside spring
- 39-47 high-mountain region
- 39 mountain range, a massif
- 40 summit (peak, top of the mountain)
- 41 shoulder
- 42 saddle
- 43 rock face (steep face)
- 44 gully
- 45 talus (scree, detritus)
- 46 bridle path
- 47 pass (col)
- 48-56 glacial ice
- 48 firn field (firn basin, nevé)
- 49 valley glacier
- 50 crevasse
- 51 glacier snout
- 52 subglacial stream
- 53 lateral moraine
- 54 medial moraine
- 55 end moraine
- 56 glacier table

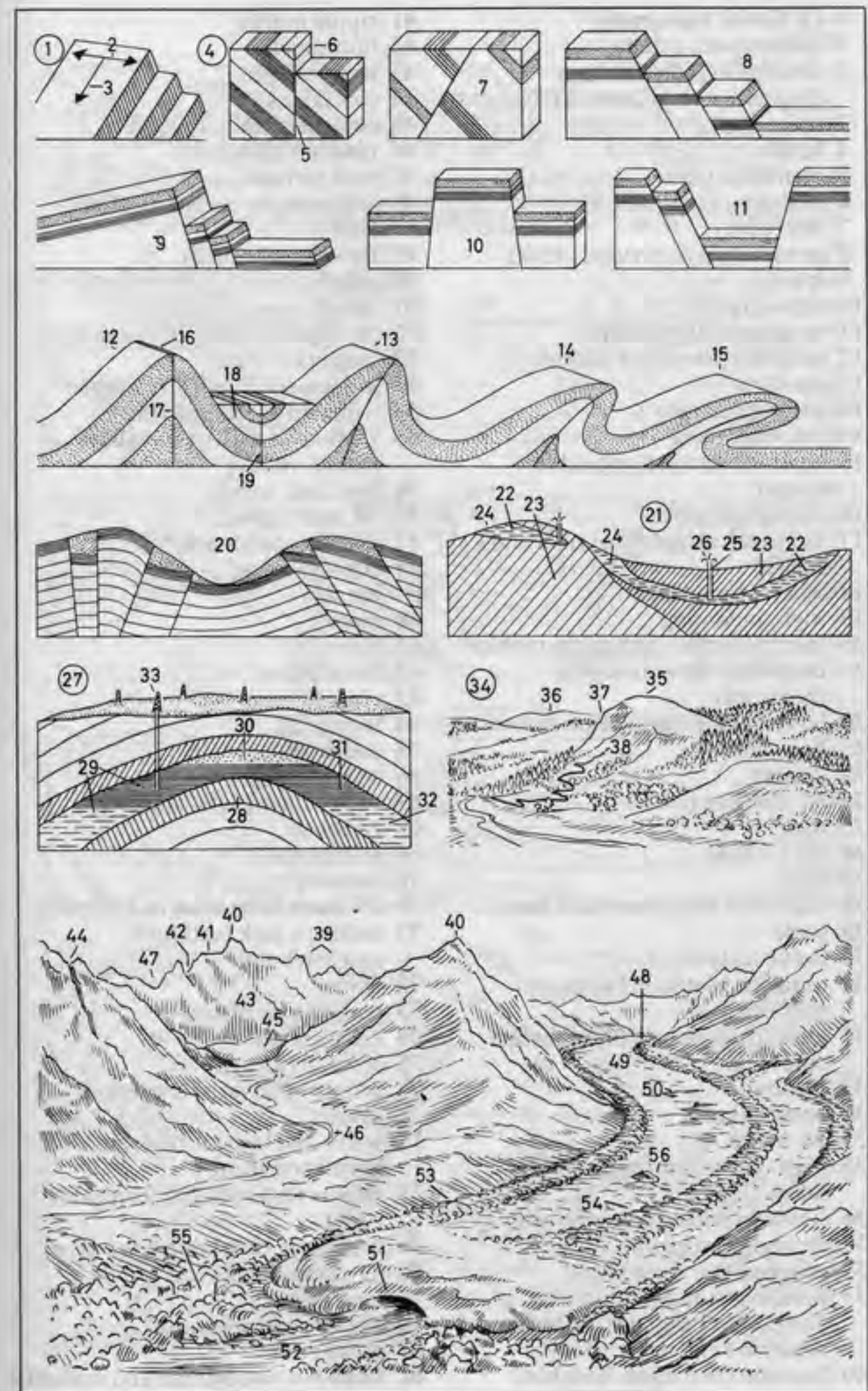



1-13 fluvial topography

- 1 river mouth, a delta
- 2 distributary (distributary channel), a river branch (river arm)
- 3 lake
- 4 bank
- 5 peninsula (spit)
- 6 island
- 7 bay (cove)
- 8 stream (brook, rivulet, creek)
- 9 levee
- 10 alluvial plain
- 11 meander (river bend)
- 12 meander core (rock island)
- 13 meadow
- 14-24 bog (marsh)
- 14 low-moor bog
- 15 layers of decayed vegetable matter
- 16 entrapped water
- 17 fen peat [consisting of rush and sedge]
- 18 alder-swamp peat
- 19 high-moor bog
- 20 layer of recent sphagnum mosses
- 21 boundary between layers (horizons)
- 22 layer of older sphagnum mosses
- 23 bog pool
- 24 swamp
- 25-31 cliffline (cliffs)
- 25 rock
- 26 sea (ocean)
- 27 surf
- 28 cliff (cliff face, steep rock face)
- 29 scree
- 30 [wave-cut] notch
- 31 abrasion platform (wave-cut platform)
- 32 atoll (ring-shaped coral reef), a coral reef
- 33 lagoon
- 34 breach (hole)
- 35-44 beach
- 35 high-water line (high-water mark, tidemark)
- 36 waves breaking on the shore
- 37 groyne (Am. groin)
- 38 groyne (Am. groin) head
- 39 wandering dune (migratory dune, travelling, Am. traveling dune), a dune
- 40 barchan (barchane, barkhan, crescentic dune)

- 41 ripple marks
- 42 hummock
- 43 wind cripple
- 44 coastal lake
- 45 canyon (cañon, coulee)
- 46 plateau (tableland)
- 47 rock terrace
- 48 sedimentary rock (stratified rock)
- 49 river terrace (bed)
- 50 joint
- 51 canyon river
- 52-56 types of valley [cross section]
- 52 gorge (ravine)
- 53 V-shaped valley (V-valley)
- 54 widened V-shaped valley
- 55 U-shaped valley (U-valley, trough valley)
- 56 synclinal valley
- 57-70 river valley
- 57 scarp (escarpment)
- 58 slip-off slope
- 59 mesa
- 60 ridge
- 61 river
- 62 flood plain
- 63 river terrace
- 64 terracette
- 65 pediment
- 66 hill
- 67 valley floor (valley bottom)
- 68 riverbed
- 69 sediment
- 70 bedrock
- 71-83 karst formation in limestone
- 71 dolina, a sink (sinkhole, swallowhole)
- 72 polje
- 73 percolation of a river
- 74 karst spring
- 75 dry valley
- 76 system of caverns (system of caves)
- 77 water level (water table) in a karst formation
- 78 impervious rock (impermeable rock)
- 79 limestone cave (dripstone cave)
- 80-81 speleothems (cave formations)
- 80 stalactite (dripstone)
- 81 stalagmite
- 82 linked-up stalagmite and stalactite
- 83 subterranean river

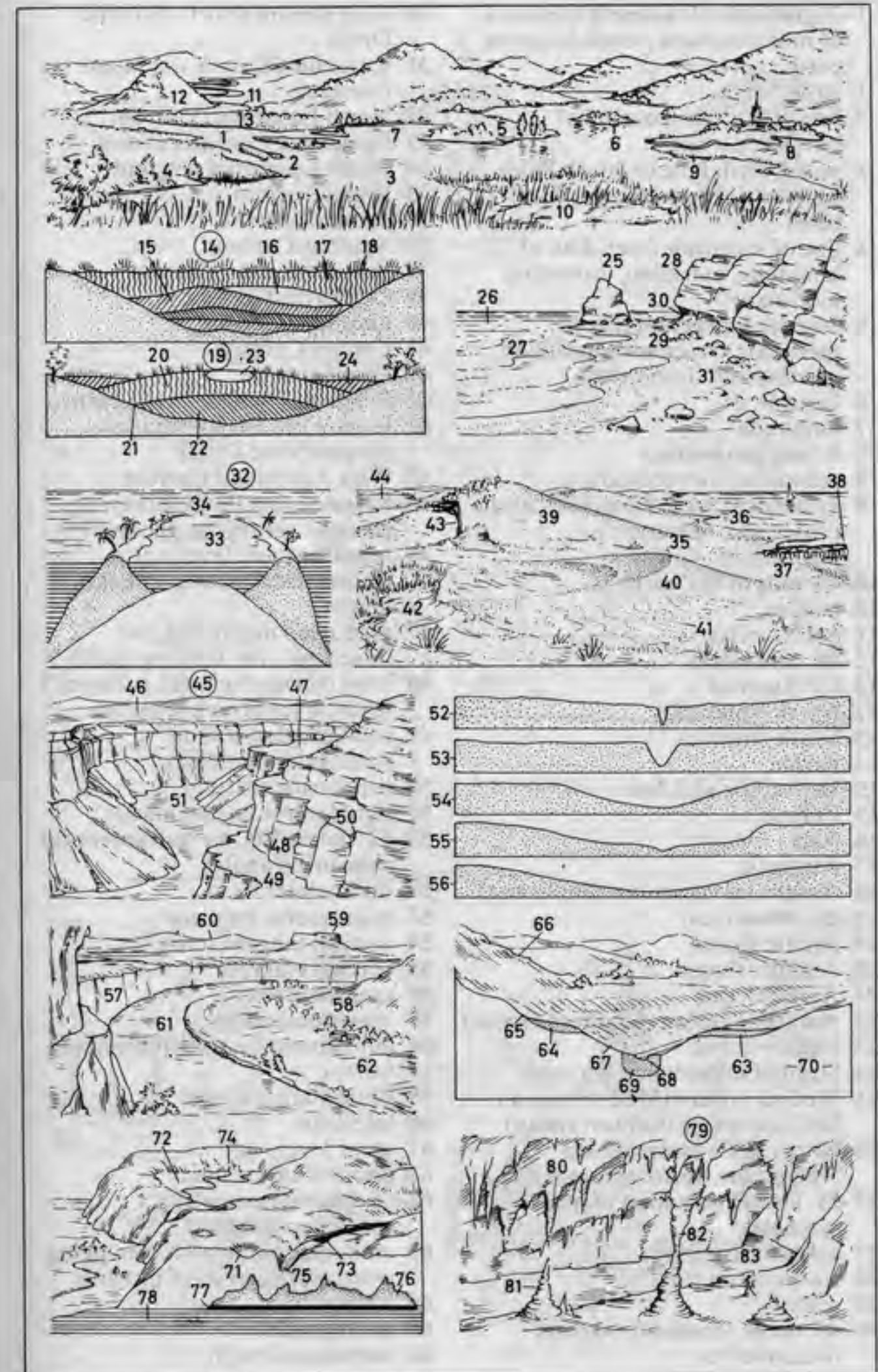



- 1-7 **graticule of the earth** (network of meridians and parallels on the earth's surface)
- 1 equator
  - 2 line of latitude (parallel of latitude, parallel)
  - 3 pole (North Pole or South Pole), a terrestrial pole (geographical pole)
  - 4 line of longitude (meridian of longitude, meridian, terrestrial meridian)
  - 5 Standard meridian (Prime meridian, Greenwich meridian, meridian of Greenwich)
  - 6 latitude
  - 7 longitude
- 8-9 **map projections**
- 8 conical (conic) projection
  - 9 cylindrical projection (Mercator projection, Mercator's projection)
- 10-45 **map of the world**
- 10 tropics
  - 11 polar circles
  - 12-18 **continents**
  - 12-13 America
  - 12 North America
  - 13 South America
  - 14 Africa
  - 15-16 Europe and Asia
  - 15 Europe
  - 16 Asia
  - 17 Australia
  - 18 Antarctica (Antarctic Continent)
  - 19-26 **ocean (sea)**
  - 19 Pacific Ocean
  - 20 Atlantic Ocean
  - 21 Arctic Ocean
  - 22 Antarctic Ocean (Southern Ocean)
  - 23 Indian Ocean
  - 24 Strait of Gibraltar, a sea strait
  - 25 Mediterranean (Mediterranean Sea, European Mediterranean)
  - 26 North Sea, a marginal sea (epieiric sea, epicontinental sea)
  - 27-29 **key (explanation of map symbols)**
  - 27 cold ocean current
  - 28 warm ocean current
  - 29 scale
  - 30-45 **ocean (oceanic) currents (ocean drifts)**
  - 30 Gulf Stream (North Atlantic Drift)
  - 31 Kuroshio (Kuro Siwo, Japan Current)
  - 32 North Equatorial Current
  - 33 Equatorial Countercurrent
  - 34 South Equatorial Current
  - 35 Brazil Current
  - 36 Somali Current
  - 37 Agulhas Current
  - 38 East Australian Current
  - 39 California Current
  - 40 Labrador Current
  - 41 Canary Current
  - 42 Peru Current
  - 43 Benguela (Benguella) Current
  - 44 West Wind Drift (Antarctic Circumpolar Drift)
  - 45 West Australian Current
  - 46-62 **surveying (land surveying, geodetic surveying, geodesy)**
  - 46 levelling (*Am.* leveling) (geometrical measurement of height)
  - 47 graduated measuring rod (levelling, *Am.* leveling, staff)
  - 48 level (surveying level, surveyor's level), a surveyor's telescope
  - 49 triangulation station (triangulation point)
  - 50 supporting scaffold
  - 51 signal tower (signal mast)
  - 52-62 **theodolite, an instrument for measuring angles**
  - 52 micrometer head
  - 53 micrometer eyepiece
  - 54 vertical tangent screw
  - 55 vertical clamp
  - 56 tangent screw
  - 57 horizontal clamp
  - 58 adjustment for the illuminating mirror
  - 59 illuminating mirror
  - 60 telescope
  - 61 spirit level
  - 62 circular adjustment
  - 63-66 **photogrammetry (phototopography)**
  - 63 air survey camera for producing overlapping series of pictures
  - 64 stereoscope
  - 65 pantograph
  - 66 stereoplanigraph

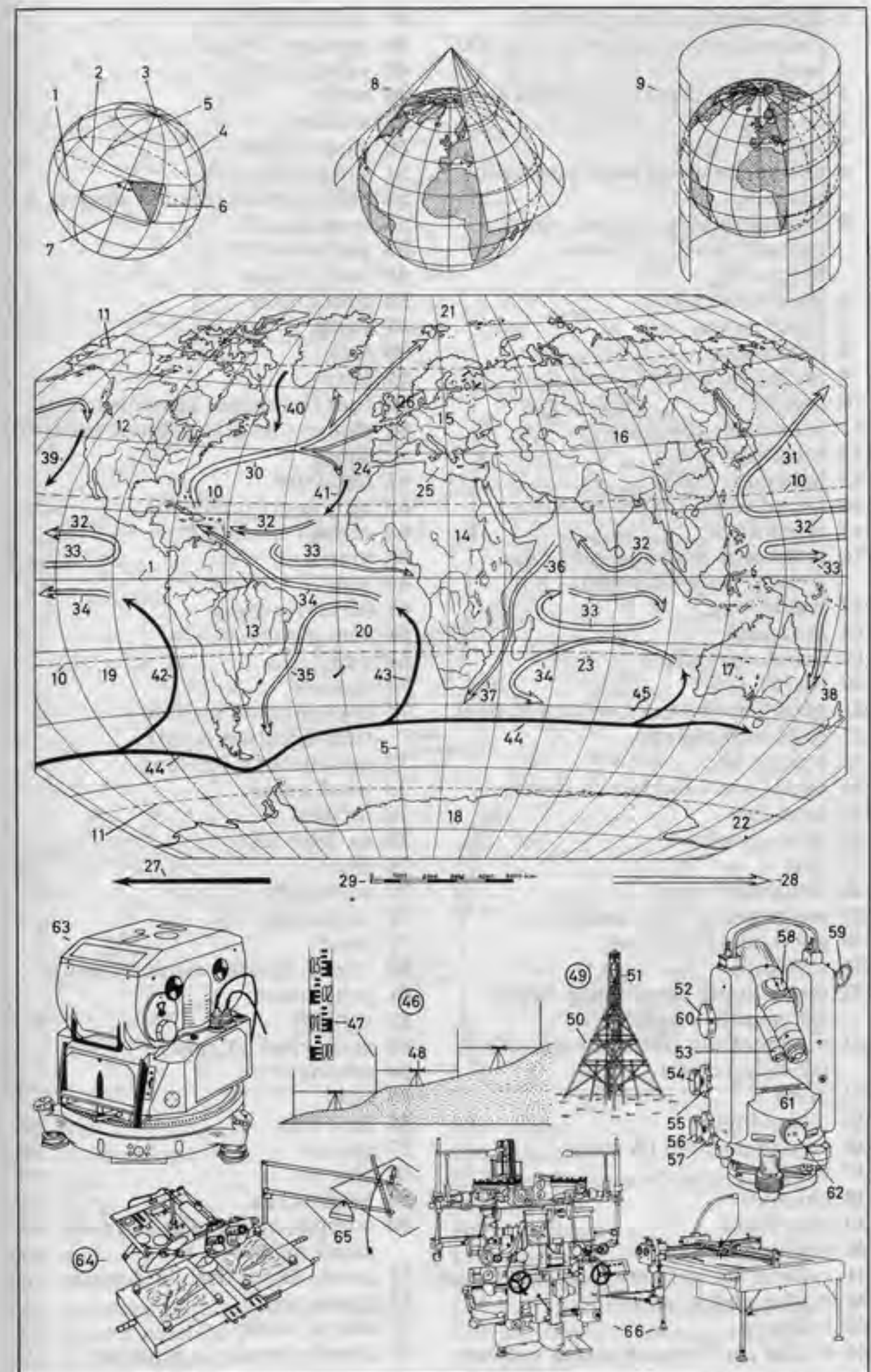



- |   |   |
|---|---|
| 1-114 map signs (map symbols, conventional signs) on a 1:25 000 map | 45 navigable river                                |
| 1 coniferous wood (coniferous trees)                                | 46 pontoon bridge                                 |
| 2 clearing  | 47 vehicle ferry                                  |
| 3 forestry office   | 48 mole   |
| 4 deciduous wood (non-coniferous trees)                             | 49 beacon   |
| 5 heath (rough grassland, rough pasture, heath and moor, bracken)   | 50 stone bridge                                   |
| 6 sand (sand hills)   | 51 town (city)                                    |
| 7 beach grass   | 52 market place (market square)                   |
| 8 lighthouse  | 53 large church                                   |
| 9 mean low water  | 54 public building                                |
| 10 beacon   | 55 road bridge                                    |
| 11 submarine contours   | 56 iron bridge                                    |
| 12 train ferry  | 57 canal  |
| 13 lightship  | 58 lock   |
| 14 mixed wood (mixed trees)   | 59 jetty  |
| 15 brushwood  | 60 foot ferry (foot passenger ferry)              |
| 16 motorway with slip road ( <i>Am.</i> freeway with on-ramp)       | 61 chapel (church) without tower or spire         |
| 17 trunk road   | 62 contours                                       |
| 18 grassland  | 63 monastery (convent)                            |
| 19 marshy grassland   | 64 church landmark                                |
| 20 marsh  | 65 vineyard                                       |
| 21 main line railway ( <i>Am.</i> trunk line)                       | 66 weir   |
| 22 road over railway  | 67 aerial ropeway                                 |
| 23 branch line  | 68 view point                                     |
| 24 signal box ( <i>Am.</i> switch tower)                            | 69 dam  |
| 25 local line   | 70 tunnel   |
| 26 level crossing   | 71 triangulation station (triangulation point)    |
| 27 halt   | 72 remains of a building                          |
| 28 residential area   | 73 wind pump                                      |
| 29 water gauge ( <i>Am.</i> gage)                                   | 74 fortress                                       |
| 30 good, metalled road  | 75 ox-bow lake                                    |
| 31 windmill   | 76 river  |
| 32 thorn house (graduation house, salina, salt-works)               | 77 watermill                                      |
| 33 broadcasting station (wireless or television mast)               | 78 footbridge                                     |
| 34 mine   | 79 pond   |
| 35 disused mine   | 80 stream (brook, rivulet, creek)                 |
| 36 secondary road (B road)  | 81 water tower                                    |
| 37 works  | 82 spring   |
| 38 chimney  | 83 main road (A road)                             |
| 39 wire fence   | 84 cutting  |
| 40 bridge over railway  | 85 cave   |
| 41 railway station ( <i>Am.</i> railroad station)                   | 86 lime kiln                                      |
| 42 bridge under railway   | 87 quarry   |
| 43 footpath   | 88 clay pit                                       |
| 44 bridge for footpath under railway                                | 89 brickworks                                     |
|   | 90 narrow-gauge ( <i>Am.</i> narrow gage) railway |
|   | 91 goods depot (freight depot)                    |
|   | 92 monument                                       |
|   | 93 site of battle                                 |
|   | 94 country estate, a demesne                      |

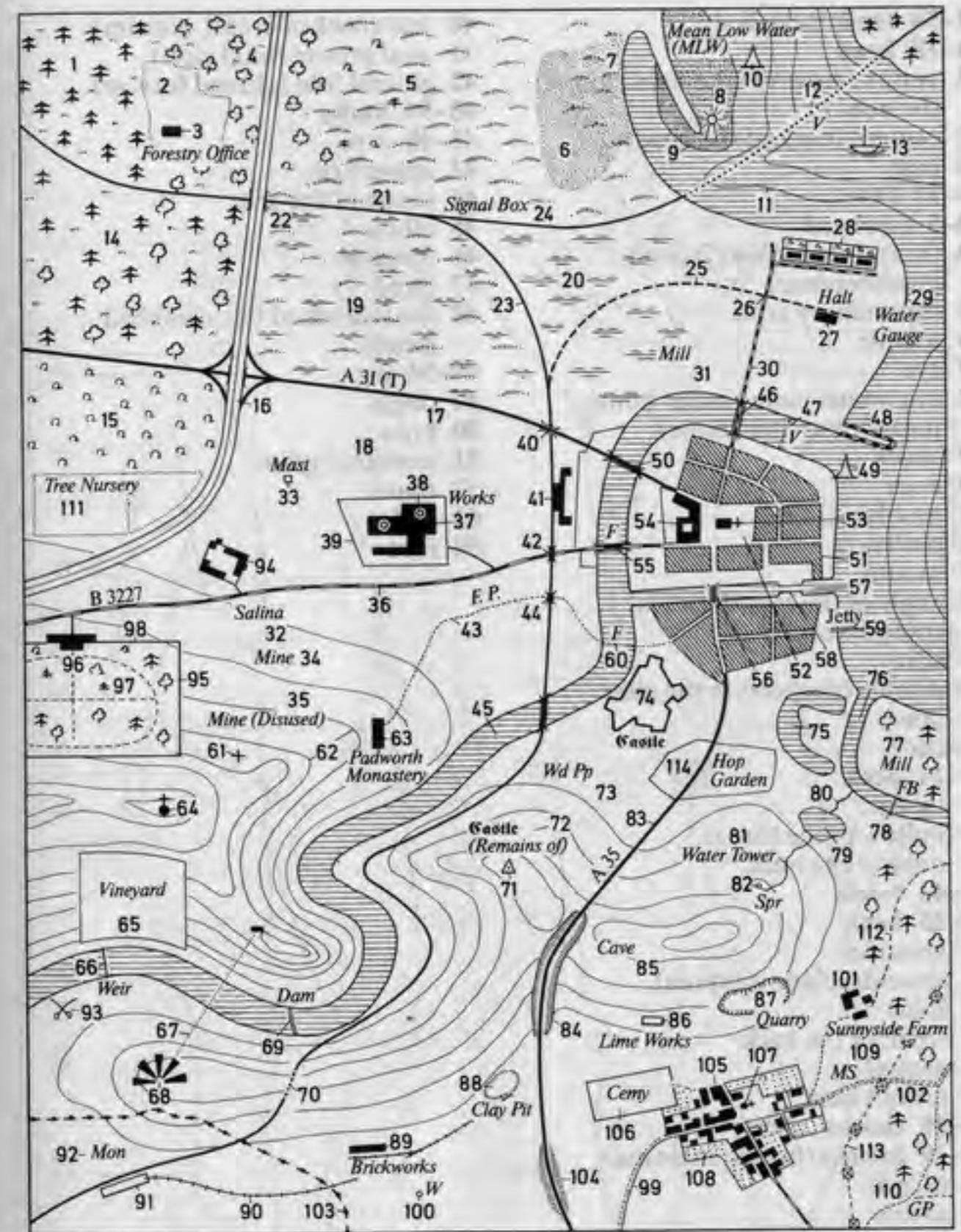

- |                                    |                                      |
|------------------------------------|--------------------------------------|
| 95 wall                            | 105 village                          |
| 96 stately home                    | 106 cemetery                         |
| 97 park                            | 107 church (chapel) with spire       |
| 98 hedge                           | 108 orchard                          |
| 99 poor or unmetalled road         | 109 milestone                        |
| 100 well                           | 110 guide post                       |
| 101 farm                           | 111 tree nursery                     |
| 102 unfenced path (unfenced track) | 112 ride (aisle, lane, section line) |
| 103 district boundary              | 113 electricity transmission line    |
| 104 embankment                     | 114 hop garden                       |



- 1-54 the human body**  
**1-18 head**  
 1 vertex (crown of the head, top of the head)  
 2 occiput (back of the head)  
 3 hair  
**4-17 face**  
 4-5 forehead  
 4 frontal eminence (frontal protuberance)  
 5 superciliary arch  
 6 temple  
 7 eye  
 8 zygomatic bone (malar bone, jugal bone, cheekbone)  
 9 cheek  
 10 nose  
 11 nasolabial fold  
 12 philtrum  
 13 mouth  
 14 angle of the mouth (labial commissure)  
 15 chin  
 16 dimple (fossette) in the chin  
 17 jaw  
 18 ear  
**19-21 neck**  
 19 throat  
 20 hollow of the throat  
 21 nape of the neck  
**22-41 trunk**  
**22-25 back**  
 22 shoulder  
 23 shoulderblade (scapula)  
 24 loins  
 25 small of the back  
 26 armpit  
 27 armpit hair  
**28-30 thorax (chest)**  
 28-29 breasts (breast, mamma)  
 28 nipple  
 29 areola  
 30 bosom  
 31 waist  
 32 flank (side)  
 33 hip  
 34 navel  
**35-37 abdomen (stomach)**  
 35 upper abdomen  
 36 abdomen  
 37 lower abdomen  
 38 groin  
 39 pudenda (vulva)

- 40 seat (backside, *coll.* bottom)  
 41 anal groove (anal cleft)  
 42 gluteal fold (gluteal furrow)  
**43-54 limbs**  
**43-48 arm**  
 43 upper arm  
 44 crook of the arm  
 45 elbow  
 46 forearm  
 47 hand  
 48 fist (clenched fist, clenched hand)  
**49-54 leg**  
 49 thigh  
 50 knee  
 51 popliteal space  
 52 shank  
 53 calf  
 54 foot

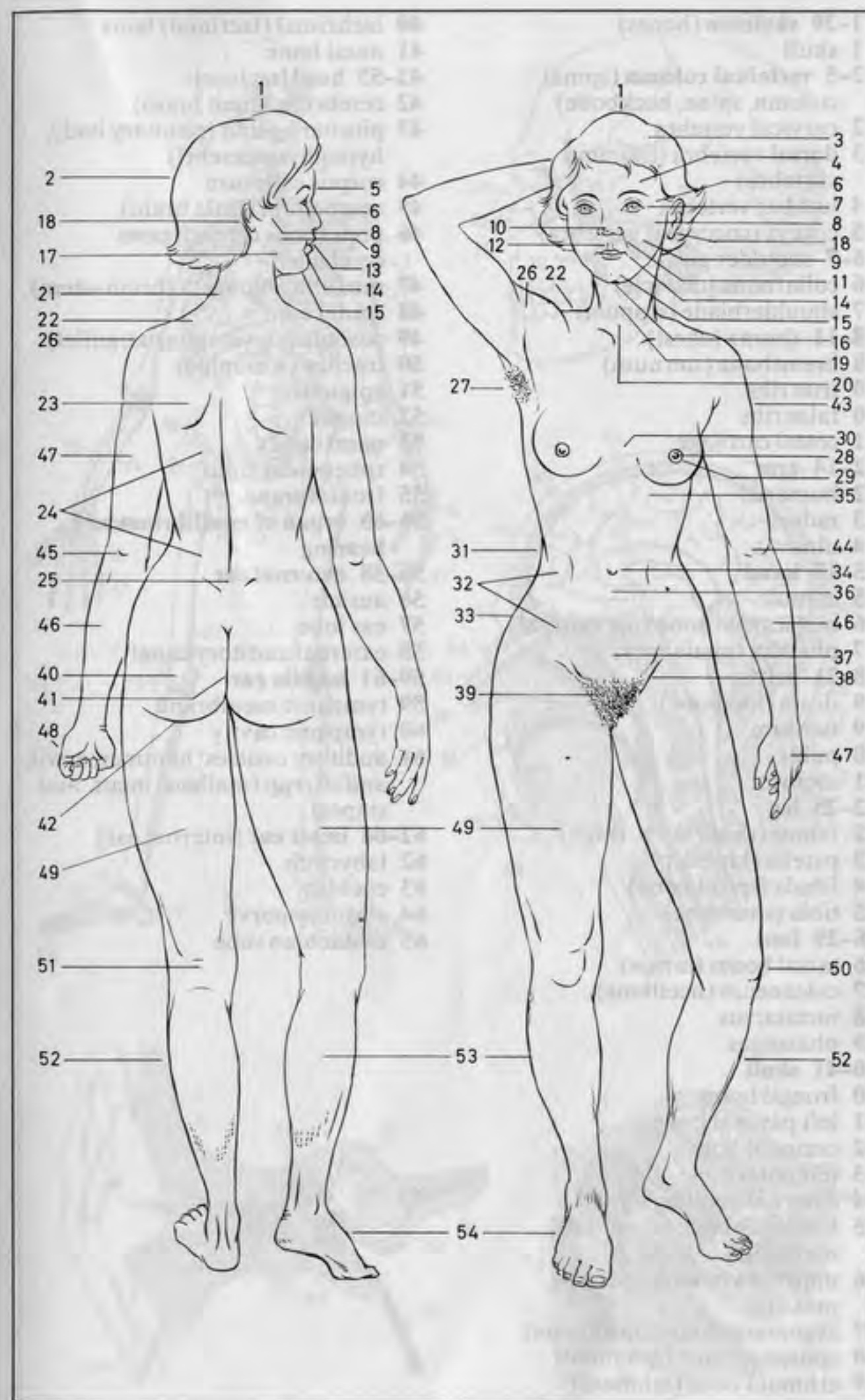



- 1-29 skeleton (bones)**  
 1 skull  
**2-5 vertebral column** (spinal column, spine, backbone)  
 2 cervical vertebra  
 3 dorsal vertebra (thoracic vertebra)  
 4 lumbar vertebra  
 5 coccyx (coccygeal vertebra)  
**6-7 shoulder girdle**  
 6 collarbone (clavicle)  
 7 shoulderblade (scapula)  
**8-11 thorax** (chest)  
 8 breastbone (sternum)  
 9 true ribs  
 10 false ribs  
 11 costal cartilage  
**12-14 arm**  
 12 humerus  
 13 radius  
 14 ulna  
**15-17 hand**  
 15 carpus  
 16 metacarpal bone (metacarpal)  
 17 phalanx (phalange)  
**18-21 pelvis**  
 18 ilium (hip bone)  
 19 ischium  
 20 pubis  
 21 sacrum  
**22-25 leg**  
 22 femur (thigh bone, thigh)  
 23 patella (kneecap)  
 24 fibula (splint bone)  
 25 tibia (shinbone)  
**26-29 foot**  
 26 tarsal bones (tarsus)  
 27 calcaneum (heelbone)  
 28 metatarsus  
 29 phalanges  
**30-41 skull**  
 30 frontal bone  
 31 left parietal bone  
 32 occipital bone  
 33 temporal bone  
 34 external auditory canal  
 35 lower jawbone (lower jaw, mandible)  
 36 upper jawbone (upper jaw, maxilla)  
 37 zygomatic bone (cheekbone)  
 38 sphenoid bone (sphenoid)  
 39 ethmoid bone (ethmoid)  
 40 lacrimal (lacrimal) bone  
 41 nasal bone  
**42-55 head [section]**  
 42 cerebrum (great brain)  
 43 pituitary gland (pituitary body, hypophysis cerebri)  
 44 corpus callosum  
 45 cerebellum (little brain)  
 46 pons (pons cerebri, pons cerebelli)  
 47 medulla oblongata (brain-stem)  
 48 spinal cord  
 49 oesophagus (esophagus, gullet)  
 50 trachea (windpipe)  
 51 epiglottis  
 52 tongue  
 53 nasal cavity  
 54 sphenoidal sinus  
 55 frontal sinus  
**56-65 organ of equilibrium and hearing**  
**56-58 external ear**  
 56 auricle  
 57 ear lobe  
 58 external auditory canal  
**59-61 middle ear**  
 59 tympanic membrane  
 60 tympanic cavity  
 61 auditory ossicles: hammer, anvil, and stirrup (malleus, incus, and stapes)  
**62-64 inner ear (internal ear)**  
 62 labyrinth  
 63 cochlea  
 64 auditory nerve  
 65 eustachian tube

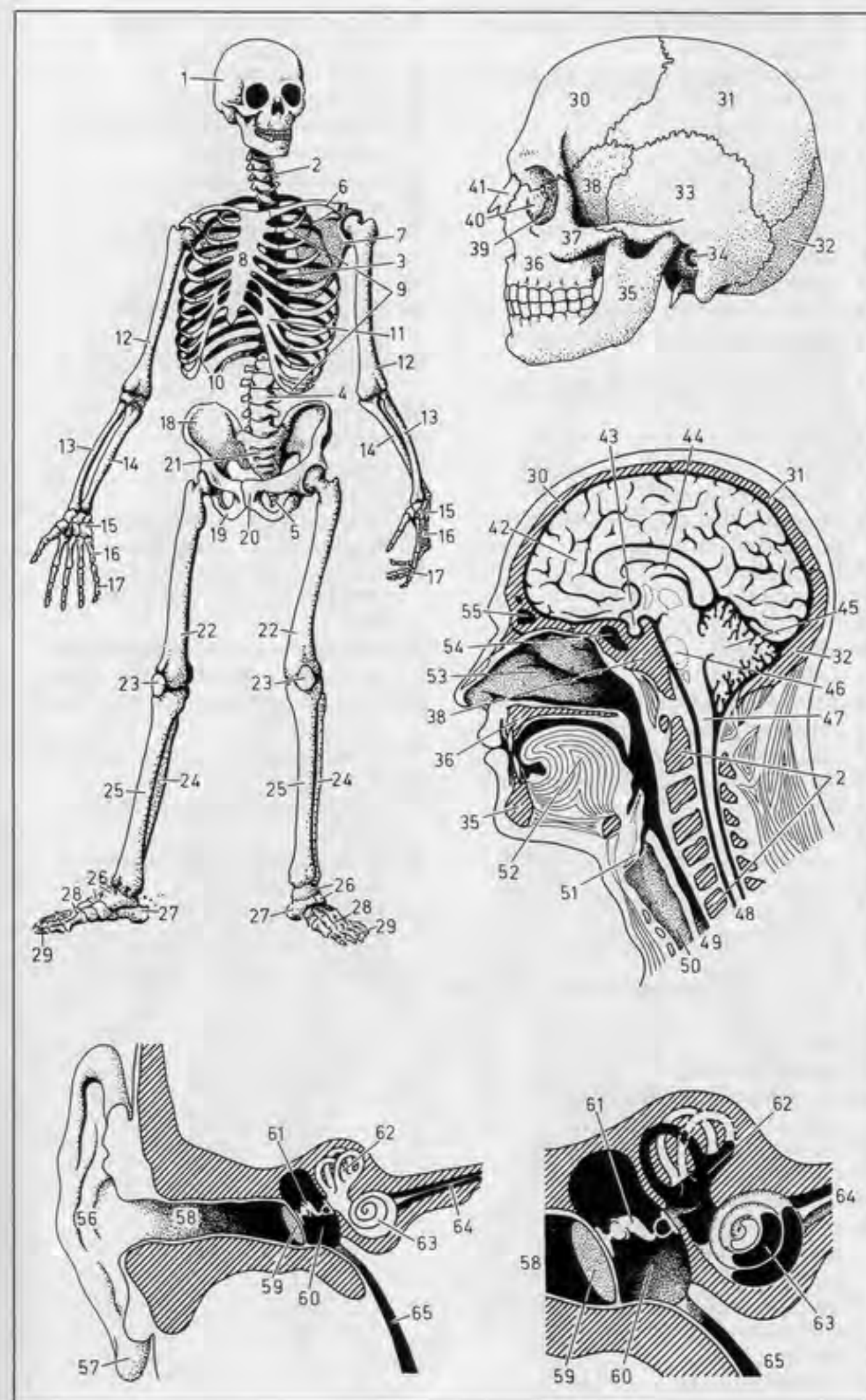



- 1-21 blood circulation** (circulatory system)
- 1 common carotid artery, an artery
  - 2 jugular vein, a vein
  - 3 temporal artery
  - 4 temporal vein
  - 5 frontal artery
  - 6 frontal vein
  - 7 subclavian artery
  - 8 subclavian vein
  - 9 superior vena cava
  - 10 arch of the aorta (aorta)
  - 11 pulmonary artery [with venous blood]
  - 12 pulmonary vein [with arterial blood]
  - 13 lungs
  - 14 heart
  - 15 inferior vena cava
  - 16 abdominal aorta (descending portion of the aorta)
  - 17 iliac artery
  - 18 iliac vein
  - 19 femoral artery
  - 20 tibial artery
  - 21 radial artery
- 22-33 nervous system**
- 22 cerebrum (great brain)
  - 23 cerebellum (little brain)
  - 24 medulla oblongata (brain-stem)
  - 25 spinal cord
  - 26 thoracic nerves
  - 27 brachial plexus
  - 28 radial nerve
  - 29 ulnar nerve
  - 30 great sciatic nerve [lying posteriorly]
  - 31 femoral nerve (anterior crural nerve)
  - 32 tibial nerve
  - 33 peroneal nerve
- 34-64 musculature** (muscular system)
- 34 sternocleidomastoid muscle (sternomastoid muscle)
  - 35 deltoid muscle
  - 36 pectoralis major (greater pectoralis muscle, greater pectoralis)
  - 37 biceps brachii (biceps of the arm)
  - 38 triceps brachii (triceps of the arm)
  - 39 brachioradialis

- 40 flexor carpi radialis (radial flexor of the wrist)
- 41 thenar muscle
- 42 serratus anterior
- 43 obliquus externus abdominis (external oblique)
- 44 rectus abdominis
- 45 sartorius
- 46 vastus lateralis and vastus medialis
- 47 tibialis anterior
- 48 tendo calcaneus (Achilles' tendon)
- 49 abductor hallucis (abductor of the hallux), a foot muscle
- 50 occipitalis
- 51 splenius of the neck
- 52 trapezius
- 53 infraspinatus
- 54 teres minor (lesser teres)
- 55 teres major (greater teres)
- 56 extensor carpi radialis longus (long radial extensor of the wrist)
- 57 extensor communis digitorum (common extensor of the digits)
- 58 flexor carpi ulnaris (ulnar flexor of the wrist)
- 59 latissimus dorsi
- 60 gluteus maximus
- 61 biceps femoris (biceps of the thigh)
- 62 gastrocnemius, medial and lateral heads
- 63 extensor communis digitorum (common extensor of the digits)
- 64 peroneus longus (long peroneus)

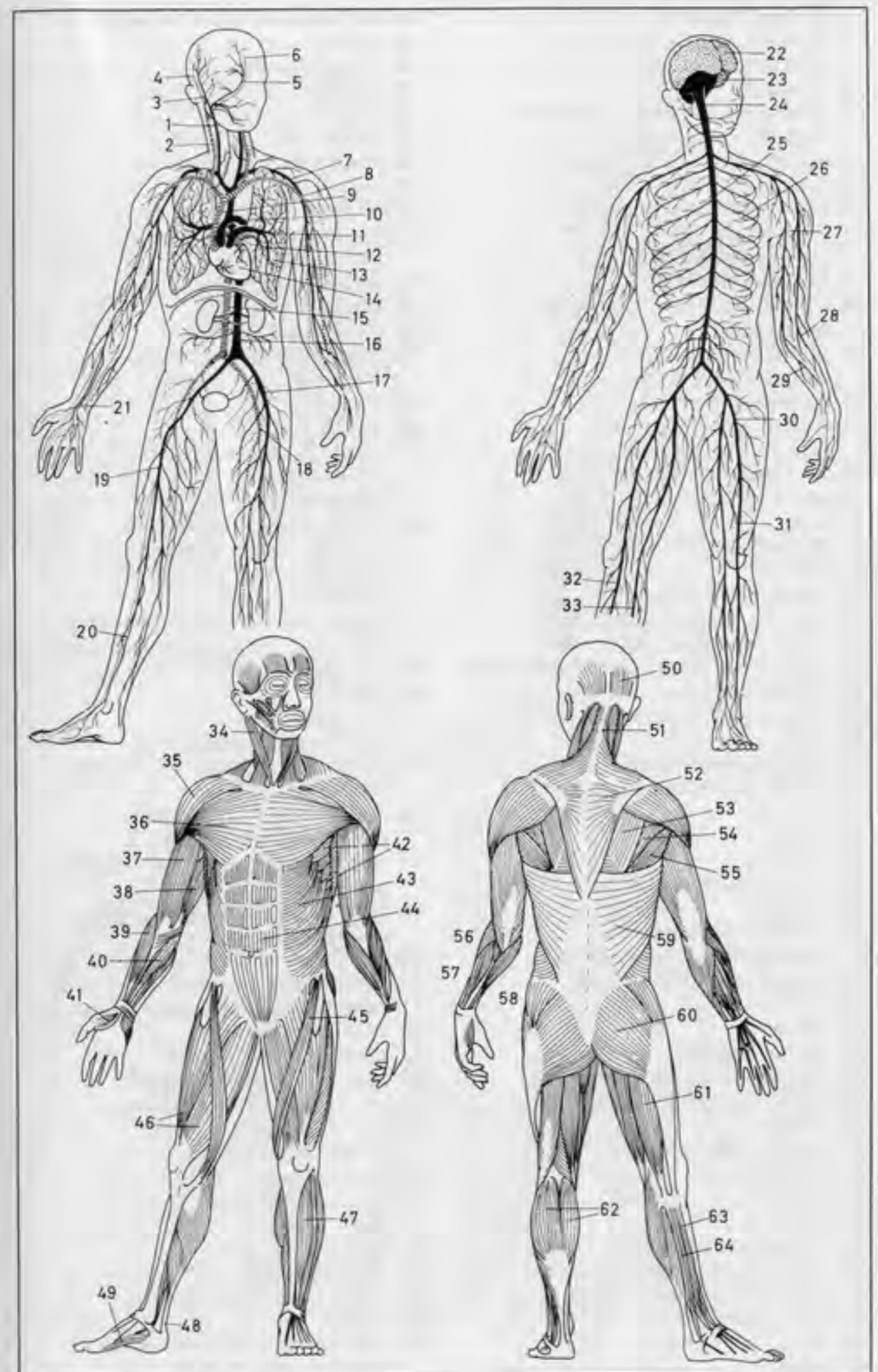



## 1-13 head and neck

- 1 sternocleidomastoid muscle (sternomastoid muscle)  
 2 occipitalis  
 3 temporalis (temporal, temporal muscle)  
 4 occipito frontalis (frontalis)  
 5 orbicularis oculi  
 6 muscles of facial expression  
 7 masseter  
 8 orbicularis oris  
 9 parotid gland  
 10 lymph node (submandibular lymph gland)  
 11 submandibular gland (submaxillary gland)  
 12 muscles of the neck  
 13 Adam's apple (laryngeal prominence) [in men only]
- 14-37 mouth and throat  
 14 upper lip  
 15 gum  
 16-18 teeth (set of teeth)  
 16 incisors  
 17 canine tooth (canine)  
 18 premolar (bicuspid) and molar teeth (premolars and molars)  
 19 angle of the mouth (labial commissure)  
 20 hard palate  
 21 soft palate (velum palati, velum)  
 22 uvula  
 23 palatine tonsil (tonsil)  
 24 pharyngeal opening (pharynx, throat)  
 25 tongue  
 26 lower lip  
 27 upper jaw (maxilla)
- 28-37 tooth  
 28 periodontal membrane (periodontium, pericementum)  
 29 cement (dental cementum, crusta petrosa)  
 30 enamel  
 31 dentine (dentin)  
 32 dental pulp (tooth pulp, pulp)  
 33 nerves and blood vessels  
 34 incisor  
 35 molar tooth (molar)  
 36 root (fang)  
 37 crown
- 38-51 eye  
 38 eyebrow (supercilium)  
 39 upper eyelid (upper palpebra)  
 40 lower eyelid (lower palpebra)  
 41 eyelash (cilium)  
 42 iris  
 43 pupil

- 44 eye muscles (ocular muscles)  
 45 eyeball  
 46 vitreous body  
 47 cornea  
 48 lens  
 49 retina  
 50 blind spot  
 51 optic nerve
- 52-63 foot  
 52 big toe (great toe, first toe, hallux, digitus I)  
 53 second toe (digitus II)  
 54 third toe (digitus III)  
 55 fourth toe (digitus IV)  
 56 little toe (digitus minimus, digitus V)  
 57 toenail  
 58 ball of the foot  
 59 lateral malleolus (external malleolus, outer malleolus, malleolus fibulae)  
 60 medial malleolus (internal malleolus, inner malleolus, malleolus tibiae, malleolus medialis)  
 61 instep (medial longitudinal arch, dorsum of the foot, dorsum pedis)  
 62 sole of the foot  
 63 heel
- 64-83 hand  
 64 thumb (pollex, digitus I)  
 65 index finger (forefinger, second finger, digitus II)  
 66 middle finger (third finger, digitus medius, digitus III)  
 67 ring finger (fourth finger, digitus anularis, digitus IV)  
 68 little finger (fifth finger, digitus minimus, digitus V)  
 69 radial side of the hand  
 70 ulnar side of the hand  
 71 palm of the hand (palma manus)  
 72-74 lines of the hand  
 72 life line (line of life)  
 73 head line (line of the head)  
 74 heart line (line of the heart)  
 75 ball of the thumb (thenar eminence)  
 76 wrist (carpus)  
 77 phalanx (phalange)  
 78 finger pad  
 79 fingertip  
 80 fingernail (nail)  
 81 lunule (lunula) of the nail  
 82 knuckle  
 83 back of the hand (dorsum of the hand, dorsum manus)

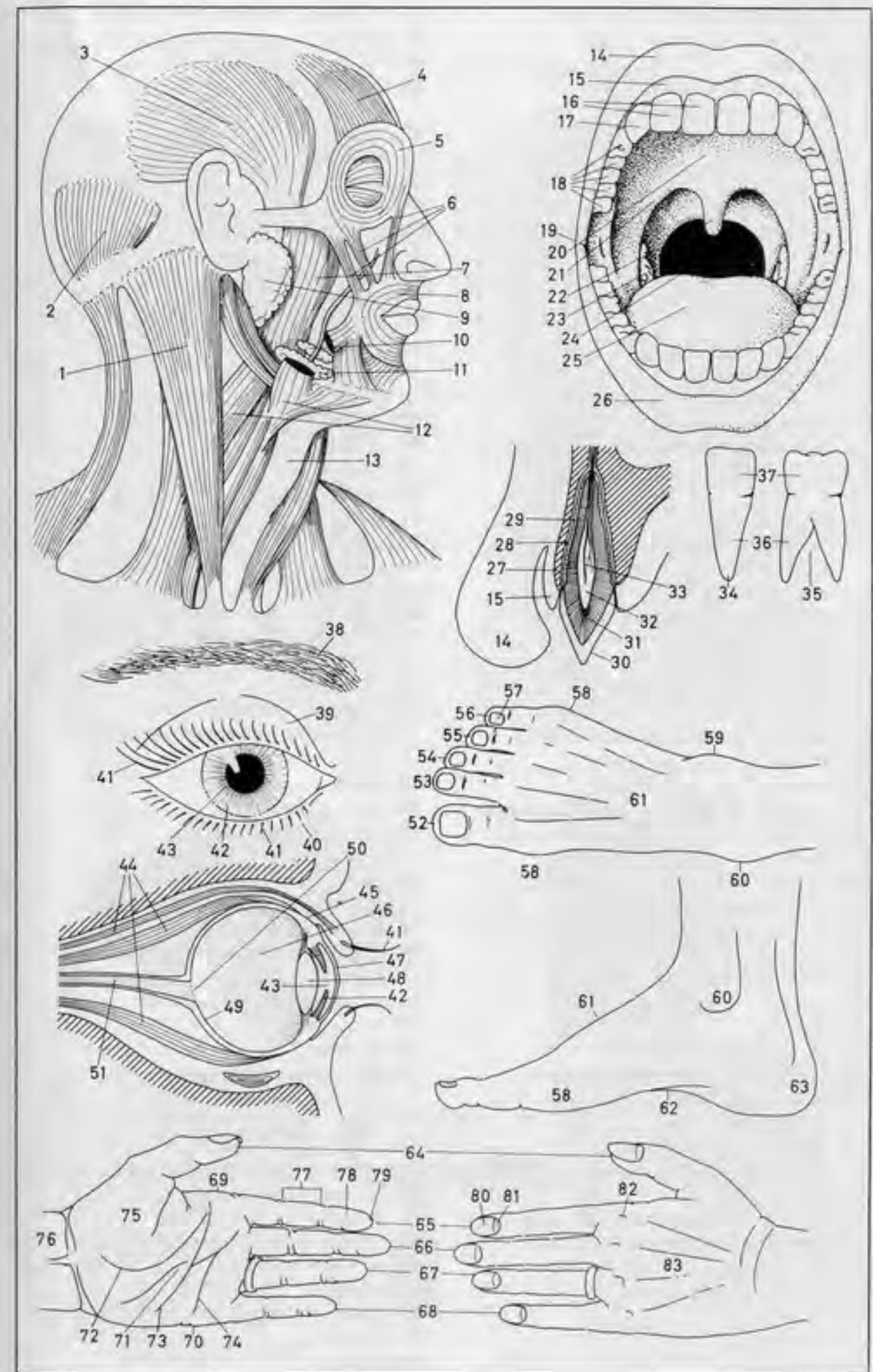



**1-57 internal organs [front view]**

- 1 thyroid gland
- 2-3 larynx
- 2 hyoid bone (hyoid)
- 3 thyroid cartilage
- 4 trachea (windpipe)
- 5 bronchus
- 6-7 lung
- 6 right lung
- 7 upper pulmonary lobe (upper lobe of the lung) [section]
- 8 heart
- 9 diaphragm
- 10 liver
- 11 gall bladder
- 12 spleen
- 13 stomach
- 14-22 intestines (bowel)
- 14-16 small intestine (intestinum tenue)
- 14 duodenum
- 15 jejunum
- 16 ileum
- 17-22 large intestine (intestinum crassum)
- 17 caecum (cecum)
- 18 appendix (vermiform appendix)
- 19 ascending colon
- 20 transverse colon
- 21 descending colon
- 22 rectum
- 23 oesophagus (esophagus, gullet)
- 24-25 heart
- 24 auricle
- 25 anterior longitudinal cardiac sulcus
- 26 diaphragm
- 27 spleen
- 28 right kidney
- 29 suprarenal gland
- 30-31 left kidney [longitudinal section]
- 30 calyx (renal calyx)
- 31 renal pelvis
- 32 ureter
- 33 bladder
- 34-35 liver [from behind]
- 34 falciform ligament of the liver
- 35 lobe of the liver
- 36 gall bladder
- 37-38 common bile duct
- 37 hepatic duct (common hepatic duct)
- 38 cystic duct
- 39 portal vein (hepatic portal vein)
- 40 oesophagus (esophagus, gullet)
- 41-42 stomach
- 41 cardiac orifice
- 42 pylorus
- 43 duodenum
- 44 pancreas

**45-57 heart (longitudinal section)**

- 45 atrium
- 46-47 valves of the heart
- 46 tricuspid valve (right atrioventricular valve)
- 47 bicuspid valve (mitral valve, left atrioventricular valve)
- 48 cusp
- 49 aortic valve
- 50 pulmonary valve
- 51 ventricle
- 52 ventricular septum (interventricular septum)
- 53 superior vena cava
- 54 aorta
- 55 pulmonary artery
- 56 pulmonary vein
- 57 inferior vena cava
- 58 peritoneum
- 59 sacrum
- 60 coccyx (coccygeal vertebra)
- 61 rectum
- 62 anus
- 63 anal sphincter
- 64 perineum
- 65 pubic symphysis (symphysis pubis)

**66-77 male sex organs [longitudinal section]**

- 66 penis
- 67 corpus cavernosum and spongiosum of the penis (erectile tissue of the penis)
- 68 urethra
- 69 glans penis
- 70 prepuce (foreskin)
- 71 scrotum
- 72 right testicle (testis)
- 73 epididymis
- 74 spermatic duct (vas deferens)
- 75 Cowper's gland (bulbourethral gland)
- 76 prostate (prostate gland)
- 77 seminal vesicle
- 78 bladder

**79-88 female sex organs [longitudinal section]**

- 79 uterus (matrix, womb)
- 80 cavity of the uterus
- 81 fallopian tube (uterine tube, oviduct)
- 82 fimbria (fimbriated extremity)
- 83 ovary
- 84 follicle with ovum (egg)
- 85 os uteri externum
- 86 vagina
- 87 lip of the pudendum (lip of the vulva)
- 88 clitoris

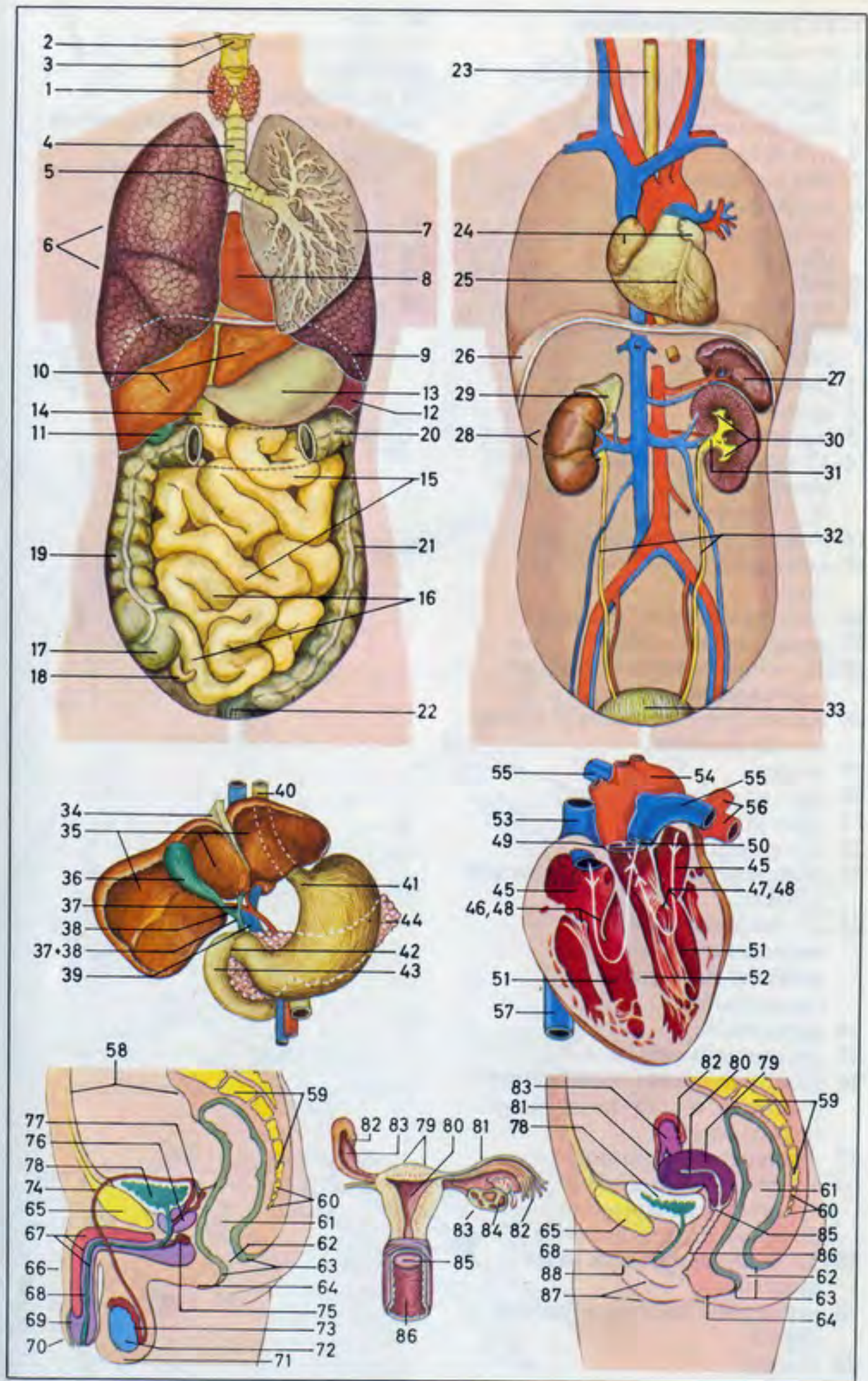



- 1-13 emergency bandages  
 1 arm bandage  
 2 triangular cloth used as a sling (an arm sling)  
 3 head bandage (capeline)  
 4 first aid kit  
 5 first aid dressing  
 6 sterile gauze dressing  
 7 adhesive plaster (sticking plaster)  
 8 wound  
 9 bandage  
 10 emergency splint for a broken limb (fractured limb)  
 11 fractured leg (broken leg)  
 12 splint  
 13 headrest  
 14-17 measures for stanching the blood flow (tying up of, ligature of, a blood vessel)  
 14 pressure points of the arteries  
 15 emergency tourniquet on the thigh  
 16 walking stick used as a screw  
 17 compression bandage  
 18-23 rescue and transport of an injured person  
 18 Rautek grip (for rescue of victim of a car accident)  
 19 helper  
 20 injured person (casualty)  
 21 chair grip  
 22 carrying grip  
 23 emergency stretcher of sticks and a jacket  
 24-27 the positioning of an unconscious person and artificial respiration (resuscitation)  
 24 coma position  
 25 unconscious person  
 26 mouth-to-mouth resuscitation (variation: mouth-to-nose resuscitation)  
 27 resuscitator (respiratory apparatus, resuscitation apparatus), a respirator (artificial breathing device)  
 28-33 methods of rescue in ice accidents  
 28 person who has fallen through the ice  
 29 rescuer  
 30 rope  
 31 table (or similar device)  
 32 ladder  
 33 self-rescue  
 34-38 rescue of a drowning person  
 34 method of release (release grip, release) to free rescuer from the clutch of a drowning person  
 35 drowning person  
 36 lifesaver  
 37 chest grip, a towing grip  
 38 tired swimmer grip (hip grip)

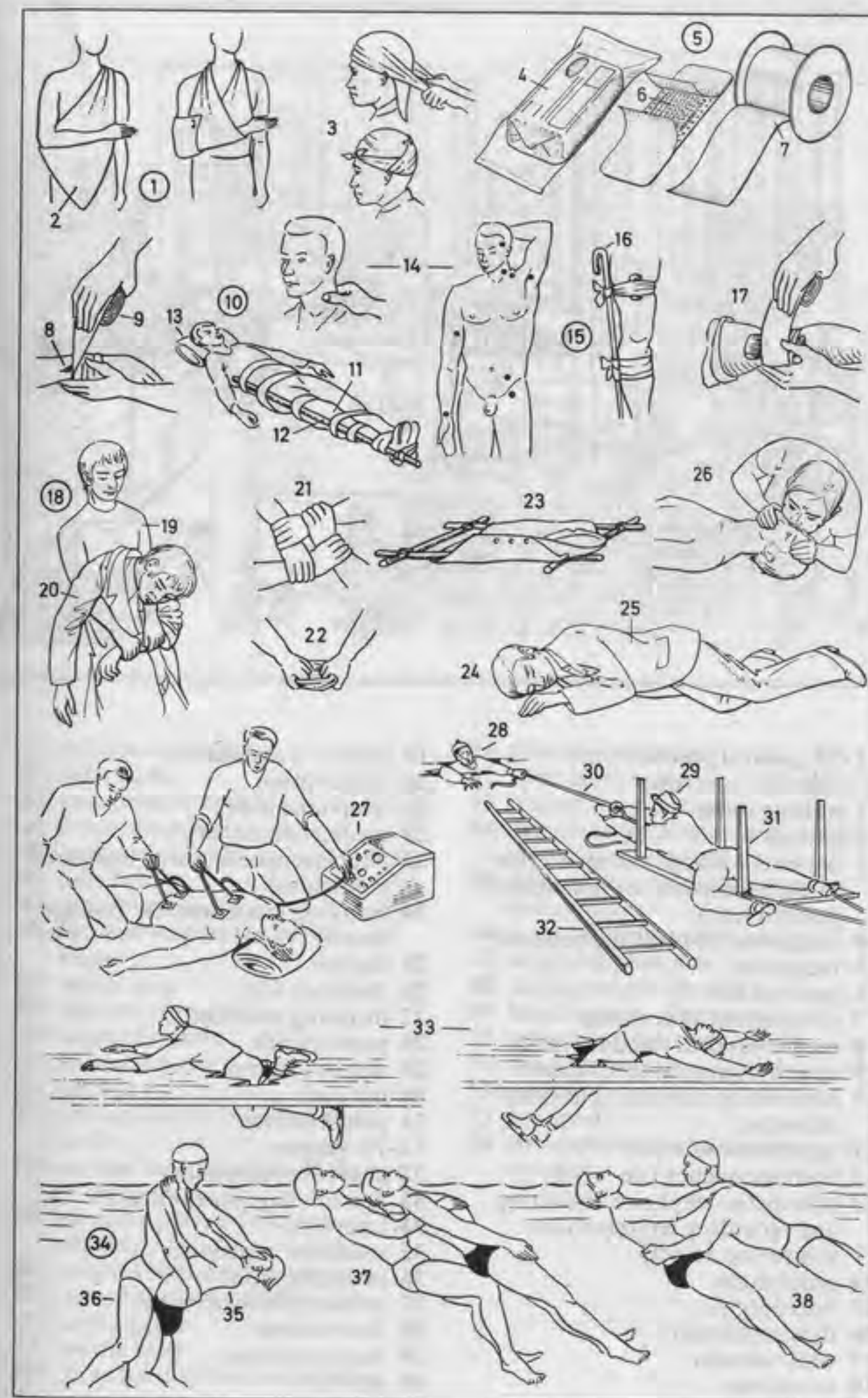



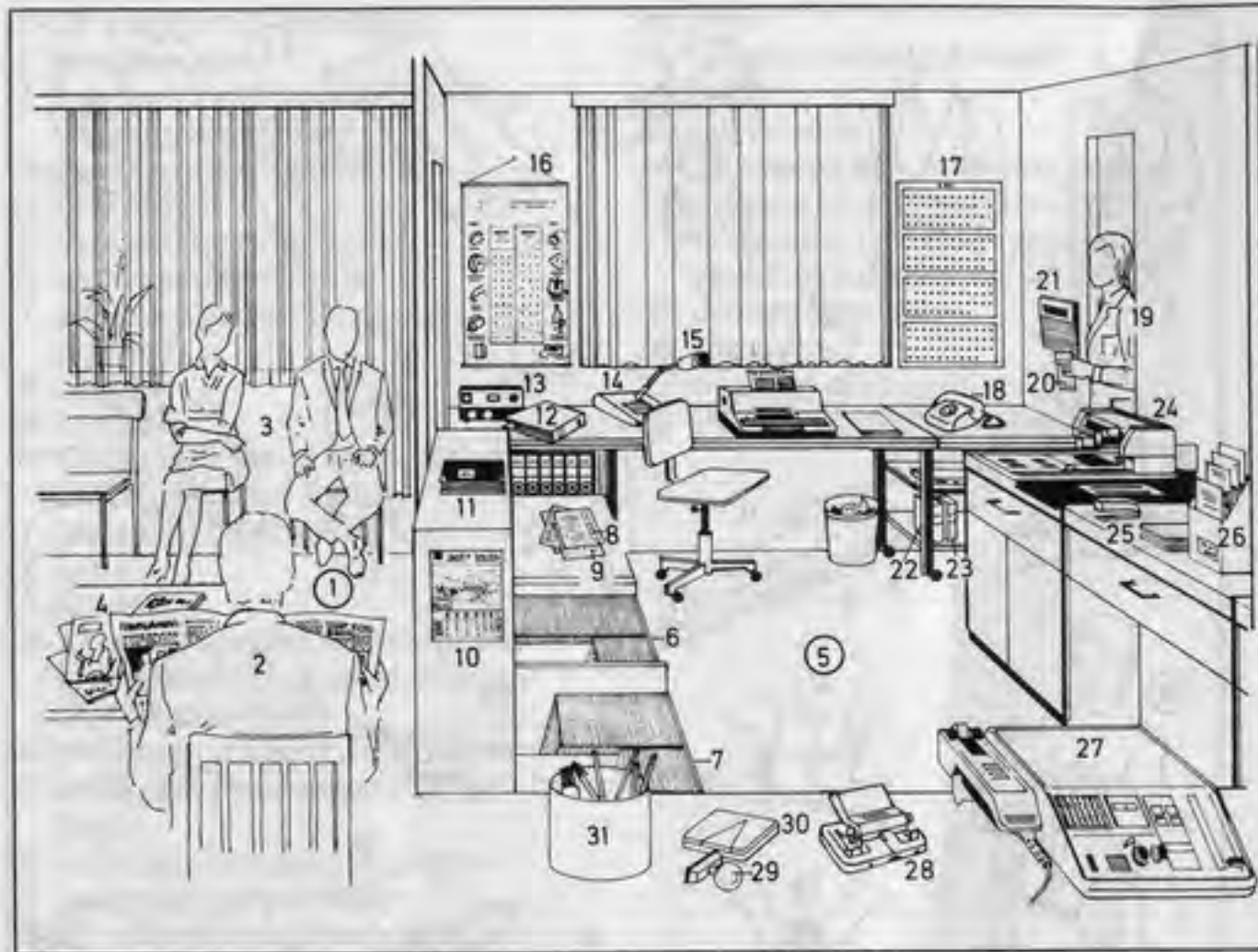

**1-74 general practice (Am. physician's office)**

**1 waiting room**

- 2 patient
- 3 patients with appointments (for a routine checkup or renewal of prescription)
- 4 magazines [for waiting patients]
- 5 reception
- 6 patients file
- 7 eliminated index cards
- 8 medical record (medical card)
- 9 health insurance certificate
- 10 advertising calendar (publicity calendar)
- 11 appointments book
- 12 correspondence file
- 13 automatic telephone answering and recording set (telephone answering device)
- 14 radiophone
- 15 microphone
- 16 illustrated chart
- 17 wall calendar
- 18 telephone

**19 [doctor's] assistant**

- 20 prescription
- 21 telephone index
- 22 medical dictionary
- 23 pharmacopoeia (list of registered medicines)
- 24 franking machine (Am. postage meter)
- 25 stapler
- 26 diabetics file
- 27 dictating machine
- 28 paper punch
- 29 doctor's stamp
- 30 ink pad
- 31 pencil holder

**32-74 surgery**

- 32 chart of eyegrounds
- 33 doctor's bag (doctor's case)
- 34 intercom
- 35 medicine cupboard
- 36 swab dispenser
- 37 inflator (Poltzer bag)
- 38 electrotome
- 39 steam sterilizer
- 40 cabinet

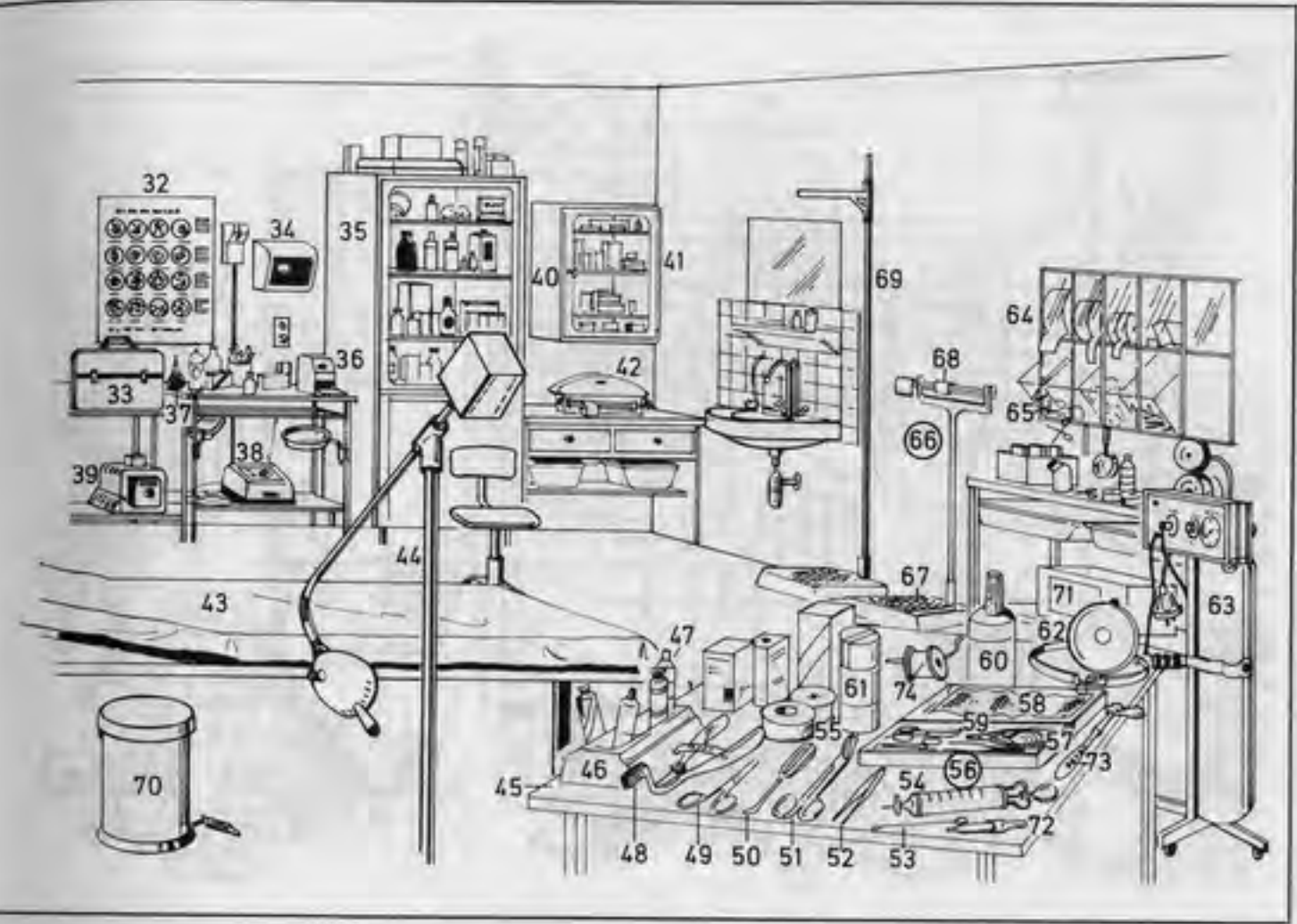

**41 medicine samples**

- 42 baby scales
- 43 examination couch
- 44 directional lamp
- 45 instrument table
- 46 tube holder
- 47 tube of ointment
- 48-50 instruments for minor surgery**
- 48 mouth gag
- 49 Kocher's forceps
- 50 scoop (curette)
- 51 angled scissors
- 52 forceps
- 53 olive-pointed (bulb-headed) probe
- 54 syringe for irrigations of the ear or bladder
- 55 adhesive plaster (sticking plaster)
- 56 surgical suture material
- 57 curved surgical needle
- 58 sterile gauze
- 59 needle holder
- 60 spray for disinfecting the skin
- 61 thread container
- 62 ophthalmoscope
- 63 freezer for cryosurgery
- 64 dispenser for plasters and small pieces of equipment
- 65 disposable hypodermic needles and syringes
- 66 scales, sliding-weight scales
- 67 weighing platform
- 68 sliding weight (jockey)
- 69 height gauge (Am. gage)
- 70 waste bin (Am. trash bin)
- 71 hot-air sterilizer
- 72 pipette
- 73 percussor
- 74 aural speculum (auriscope, aural syringe)



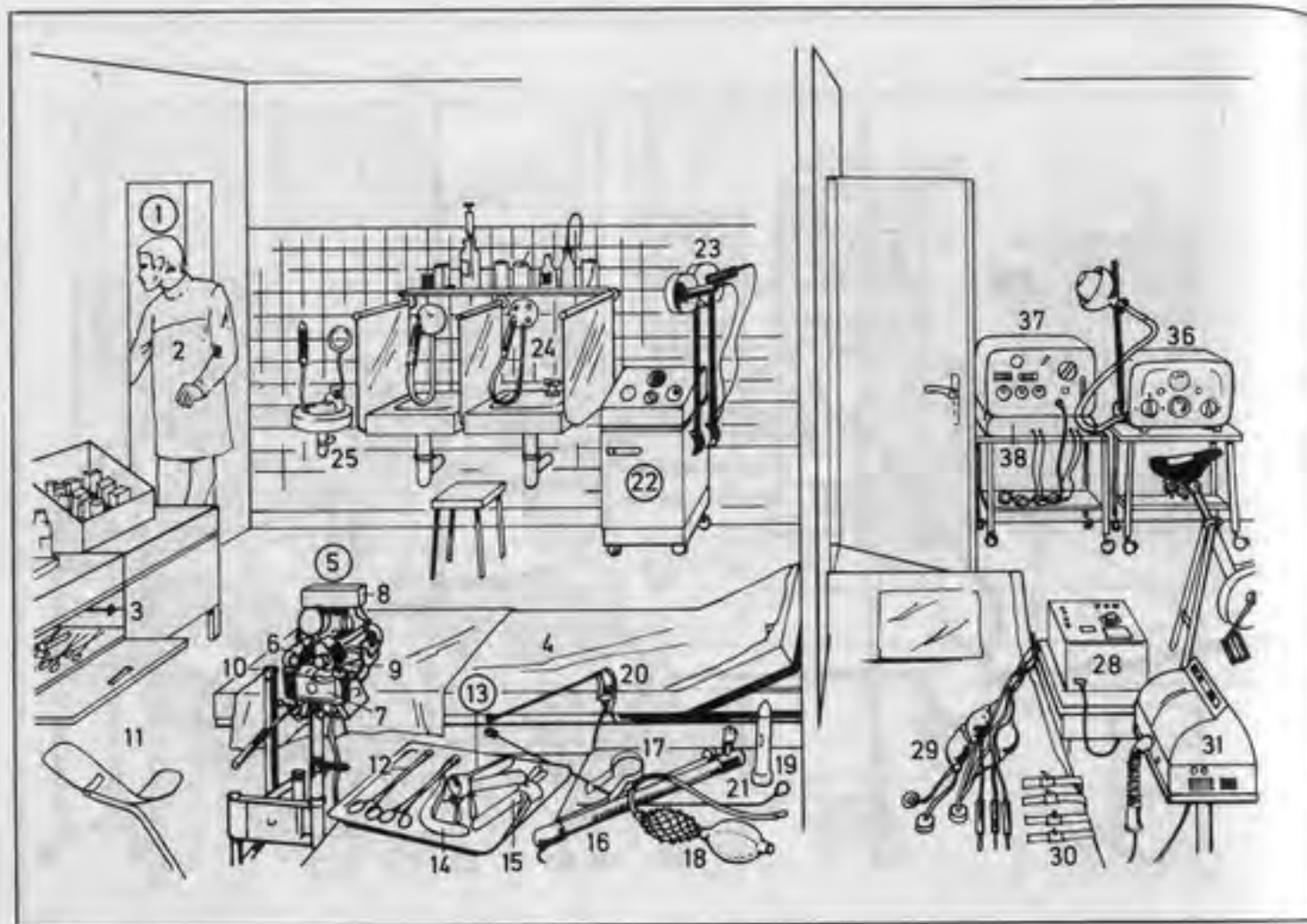

- |   |  |
|---|--|
| 1 consulting room   | 18 insufflator for proctoscopy (rectoscopy)  |
| 2 general practitioner  | 19 proctoscope (rectal speculum)   |
| 3-21 instruments for gynecological and proctological examinations | 20 urethroscope  |
| 3 warming the instruments up to body temperature                  | 21 guide for inserting the proctoscope   |
| 4 examination couch   | 22 diathermy unit (short-wave therapy apparatus)   |
| 5 colposcope  | 23 radiator  |
| 6 binocular eyepiece  | 24 inhaling apparatus (inhalator)  |
| 7 miniature camera  | 25 basin (for sputum)  |
| 8 cold light source   | 26-31 ergometry  |
| 9 cable release   | 26 bicycle ergometer   |
| 10 bracket for the leg support                                    | 27 monitor (visual display of the ECG and of pulse and respiratory rates when performing work) |
| 11 leg support (leg holder)                                       | 28 ECG (electrocardiograph)  |
| 12 holding forceps (sponge holder)                                | 29 suction electrodes  |
| 13 vaginal speculum   | 30 strap-on electrodes for the limbs   |
| 14 lower blade of the vaginal speculum                            | 31 spirometer (for measuring respiratory functions)  |
| 15 platinum loop (for smears)                                     | 32 measuring the blood pressure  |
| 16 rectoscope   |  |
| 17 biopsy forceps used with the rectoscope (proctoscope)          |  |



- |  |  |
|--|--|
| 33 sphygmomanometer  | 50 staining dish (for staining blood smears, sediments and other smears) |
| 34 inflatable cuff   | 51 binocular research microscope   |
| 35 stethoscope   | 52 pipette stand for photometry  |
| 36 microwave treatment unit  | 53 computer and analyser for photometry                                  |
| 37 faradization unit (application of low-frequency currents with different pulse shapes) | 54 photometer  |
| 38 automatic tuner   | 55 potentiometric recorder   |
| 39 short-wave therapy apparatus  | 56 transforming section  |
| 40 timer   | 57 laboratory apparatus (laboratory equipment)                           |
| 41-59 laboratory   | 58 urine sediment chart  |
| 41 medical laboratory technician   | 59 centrifuge  |
| 42 capillary tube stand for blood sedimentation  |  |
| 43 measuring cylinder  |  |
| 44 automatic pipette   |  |
| 45 kidney dish   |  |
| 46 portable ECG machine for emergency use  |  |
| 47 automatic pipetting device  |  |
| 48 constant temperature water bath   |  |
| 49 tap with water jet pump   |  |



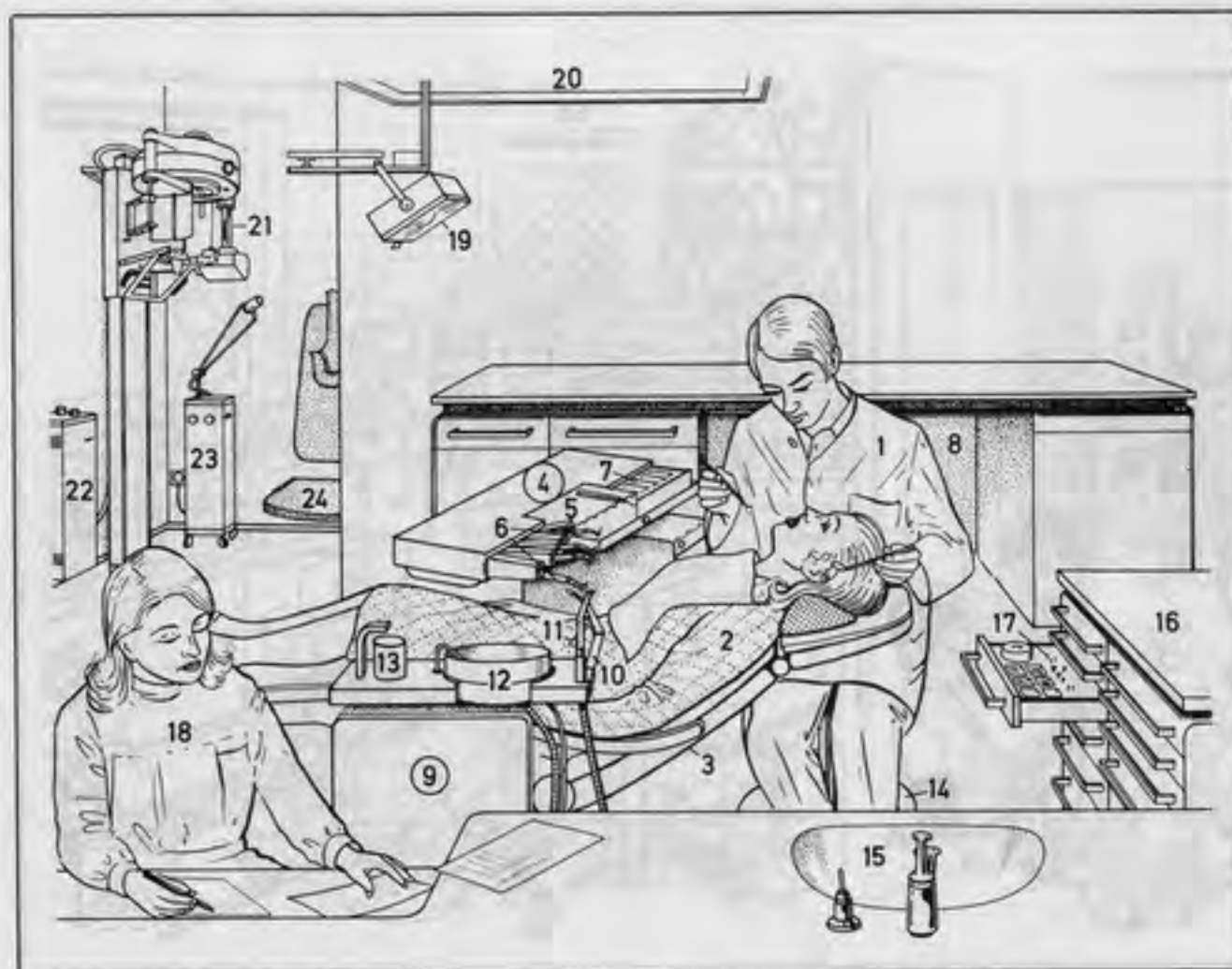

- |  |   |
|--|---|
| 1 dentist (dental surgeon)                                       | 22 X-ray generator                                  |
| 2 patient  | 23 microwave treatment unit, a radiation unit       |
| 3 dentist's chair  | 24 seat   |
| 4 dental instruments   | 25 denture (set of false teeth)                     |
| 5 instrument tray  | 26 bridge (dental bridge)                           |
| 6 drills with different handpieces                               | 27 prepared stump of the tooth                      |
| 7 medicine case  | 28 crown ( <i>kinds</i> : gold crown, jacket crown) |
| 8 storage unit (for dental instruments)                          | 29 porcelain tooth (porcelain pontic)               |
| 9 assistant's unit   | 30 filling  |
| 10 multi-purpose syringe (for cold and warm water, spray or air) | 31 post crown                                       |
| 11 suction apparatus   | 32 facing   |
| 12 basin   | 33 diaphragm  |
| 13 water glass, filled automatically                             | 34 post   |
| 14 stool   | 35 carborundum disc (disk)                          |
| 15 washbasin   | 36 grinding wheel                                   |
| 16 instrument cabinet  | 37 burs   |
| 17 drawer for drills   | 38 flame-shaped finishing bur                       |
| 18 dentist's assistant   | 39 fissure burs                                     |
| 19 dentist's lamp  | 40 diamond point                                    |
| 20 ceiling light   | 41 mouth mirror                                     |
| 21 X-ray apparatus for panoramic pictures                        | 42 mouth lamp                                       |

- |  |
|--|
| 43 cautery   |
| 44 platinum-iridium electrode                            |
| 45 tooth scalers   |
| 46 probe   |
| 47 extraction forceps                                    |
| 48 tooth-root elevator                                   |
| 49 bone chisel   |
| 50 spatula   |
| 51 mixer for filling material                            |
| 52 synchronous timer                                     |
| 53 hypodermic syringe for injection of local anaesthetic |
| 54 hypodermic needle                                     |
| 55 matrix holder   |
| 56 impression tray                                       |
| 57 spirit lamp   |

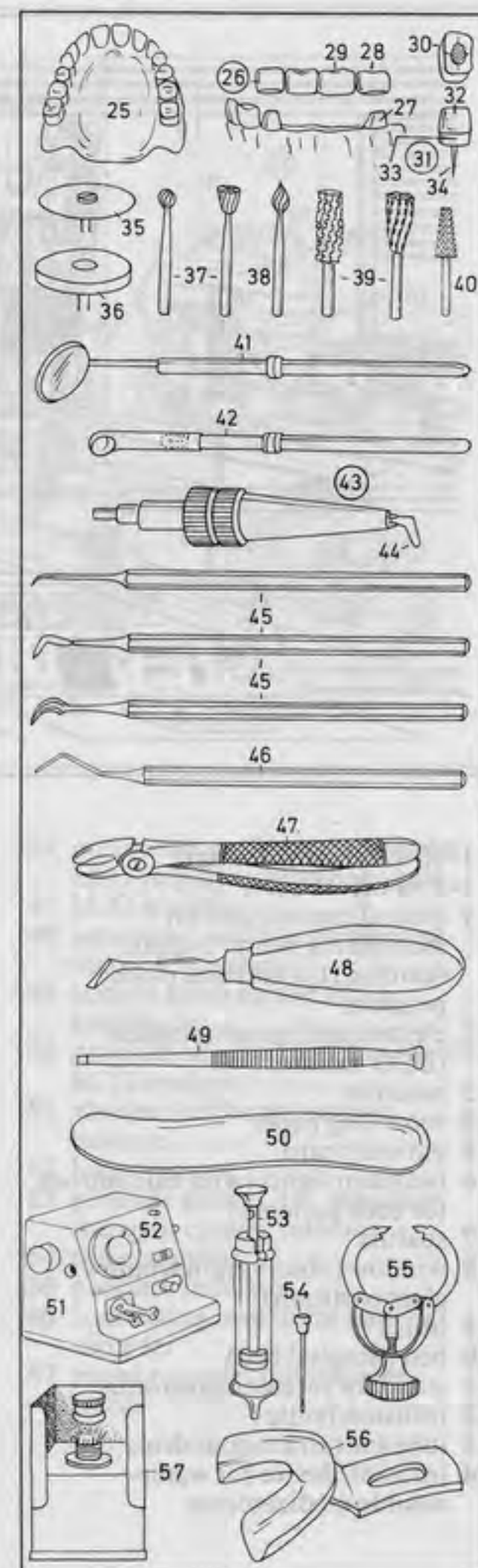

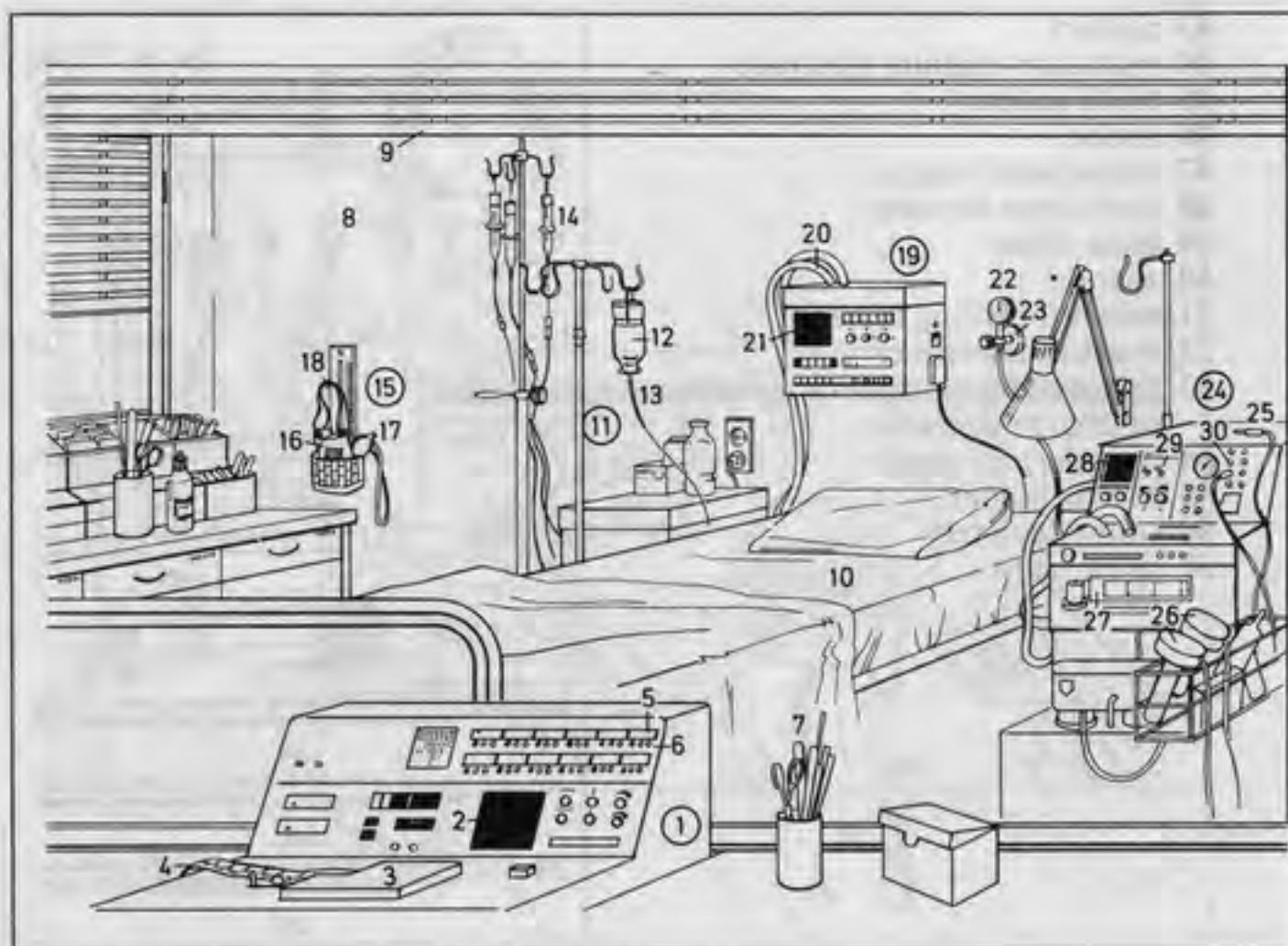

**1-30 intensive care unit****1-9 control room**

- 1 central control unit for monitoring heart rhythm (cardiac rhythm) and blood pressure
- 2 electrocardiogram monitor (ECG monitor)
- 3 recorder
- 4 recording paper
- 5 patient's card
- 6 indicator lights (with call buttons for each patient)
- 7 spatula
- 8 window (observation window, glass partition)
- 9 blind
- 10 bed (hospital bed)
- 11 stand for infusion apparatus
- 12 infusion bottle
- 13 tube for intravenous drips
- 14 infusion device for water-soluble medicaments
- 15 sphygmomanometer
- 16 cuff
- 17 inflating bulb
- 18 mercury manometer
- 19 bed monitor
- 20 connecting lead to the central control unit
- 21 electrocardiogram monitor (ECG monitor)
- 22 manometer for the oxygen supply
- 23 wall connection for oxygen treatment
- 24 mobile monitoring unit
- 25 electrode lead to the short-term pacemaker
- 26 electrodes for shock treatment
- 27 ECG recording unit
- 28 electrocardiogram monitor (ECG monitor)
- 29 control switches and knobs (controls) for adjusting the monitor

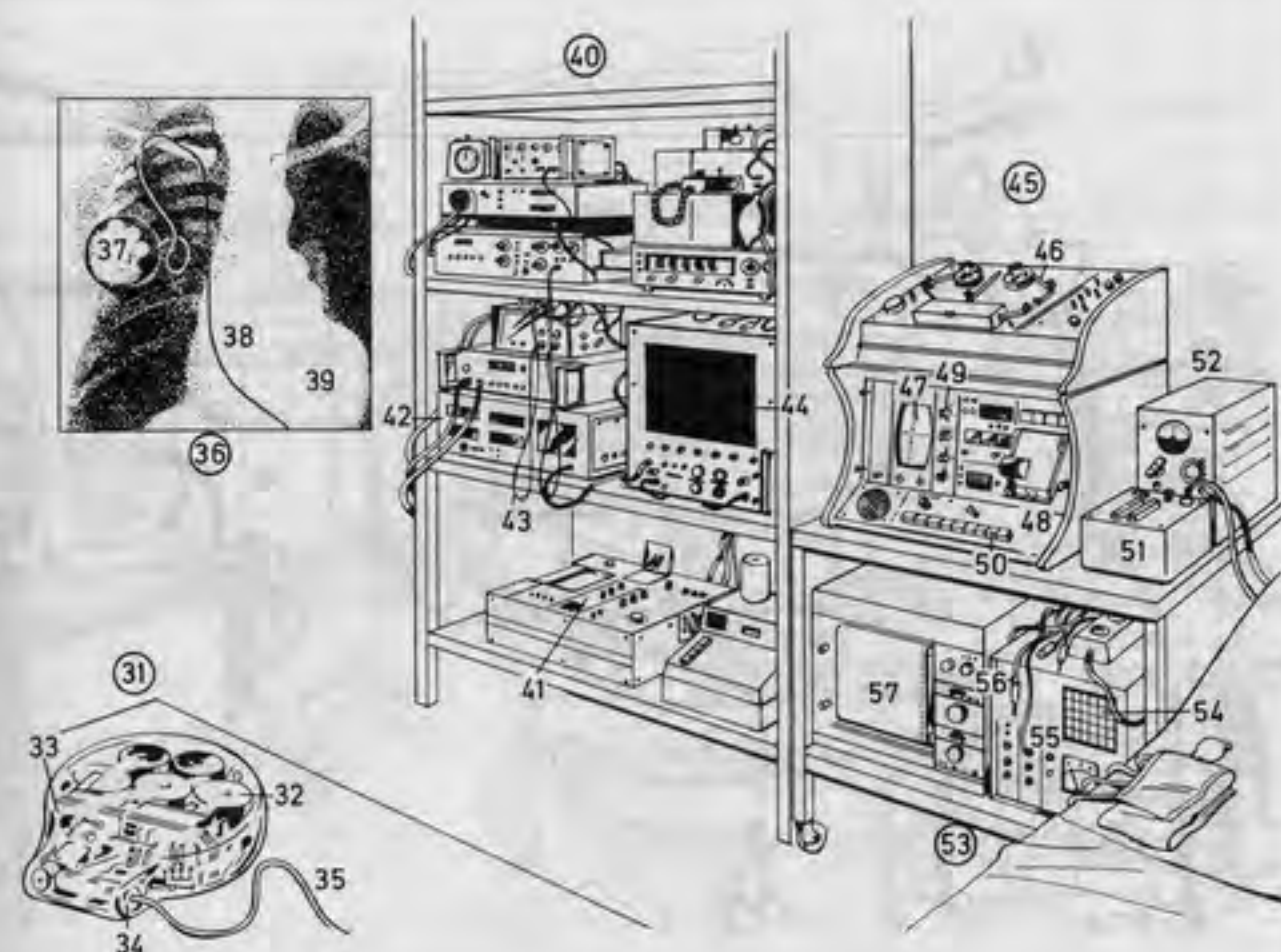

- 30 control buttons for the pacemaker unit
- 31 **pacemaker** (cardiac pacemaker)
- 32 mercury battery
- 33 programmed impulse generator
- 34 electrode exit point
- 35 electrode
- 36 implantation of the pacemaker
- 37 internal cardiac pacemaker (internal pacemaker, pacemaker)
- 38 electrode inserted through the vein
- 39 cardiac silhouette on the X-ray
- 40 **pacemaker control unit**
- 41 electrocardiograph (ECG recorder)
- 42 automatic impulse meter
- 43 ECG lead to the patient
- 44 monitor unit for visual monitoring of the pacemaker impulses
- 45 long-term ECG analyser
- 46 magnetic tape for recording the ECG impulses during analysis
- 47 ECG monitor
- 48 automatic analysis on paper of the ECG rhythm
- 49 control knob for the ECG amplitude
- 50 program selector switches for the ECG analysis
- 51 charger for the pacemaker batteries
- 52 battery tester
- 53 pressure gauge (*Am. gage*) for the right cardiac catheter
- 54 trace monitor
- 55 pressure indicator
- 56 connecting lead to the paper recorder
- 57 paper recorder for pressure traces

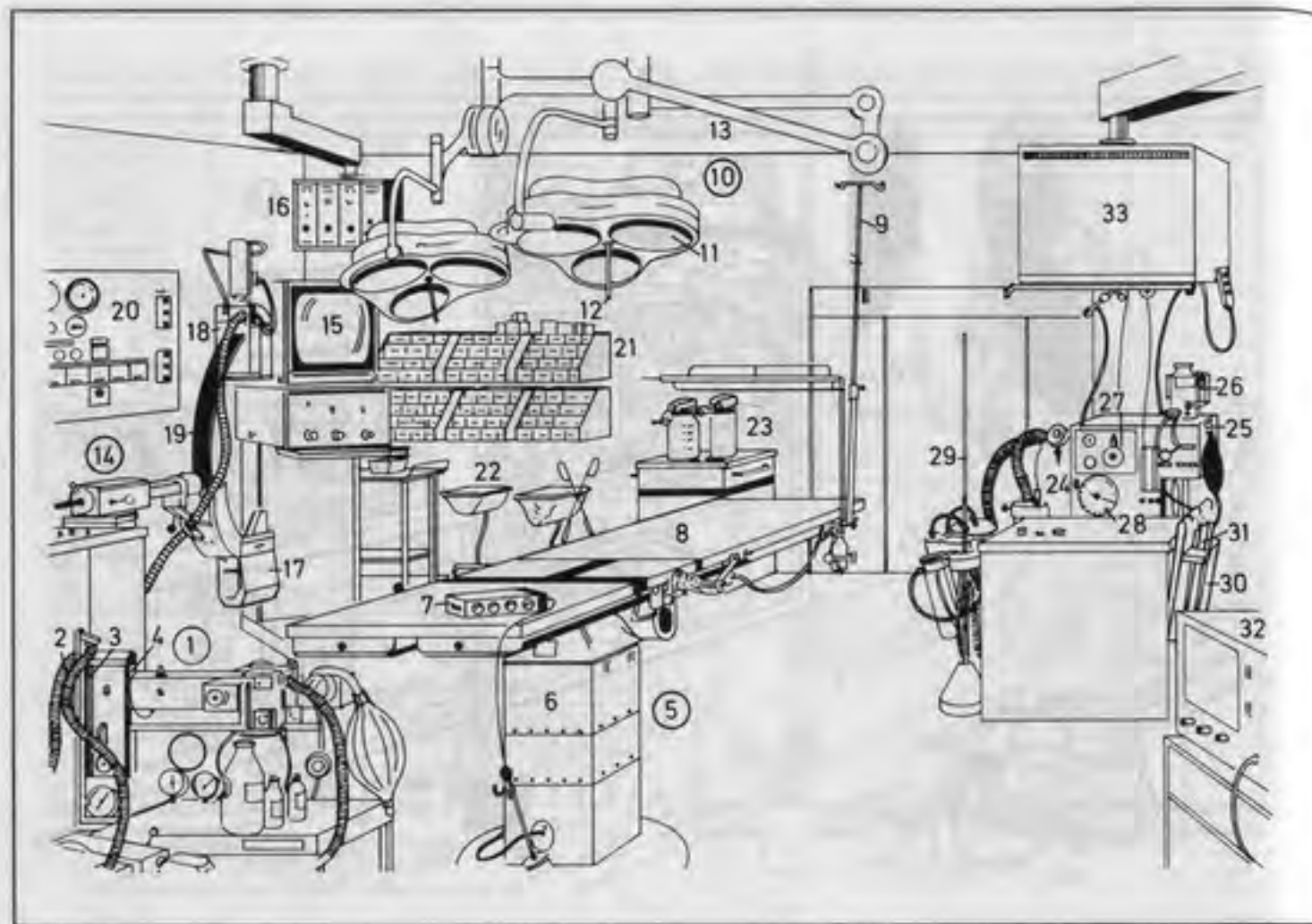

**1-54 surgical unit****1-33 operating theatre (Am. theater)**

- |   |   |
|---|---|
| 1 anaesthesia and breathing apparatus (respiratory machine) | 17 tube   |
| 2 inhalers (inhaling tubes)                                 | 18 image converter  |
| 3 flowmeter for nitrous oxide                               | 19 C-shaped frame   |
| 4 oxygen flow meter   | 20 control panel for the air-conditioning                               |
| 5 pedestal operating table                                  | 21 surgical suture material   |
| 6 table pedestal  | 22 mobile waste tray  |
| 7 control device (control unit)                             | 23 containers for unsterile (unsterilized) pads                         |
| 8 adjustable top of the operating table                     | 24 anaesthesia and respiratory apparatus                                |
| 9 stand for intravenous drips                               | 25 respirator   |
| 10 swivel-mounted shadow-free operating lamp                | 26 fluothane container (halothane container)                            |
| 11 individual lamp  | 27 ventilation control knob   |
| 12 handle   | 28 indicator with pointer for respiratory volume                        |
| 13 swivel arm   | 29 stand with inhalers (inhaling tubes) and pressure gauges (Am. gages) |
| 14 mobile fluoroscope                                       | 30 catheter holder  |
| 15 monitor of the image converter                           | 31 catheter in sterile packing  |
| 16 monitor [back]   |   |

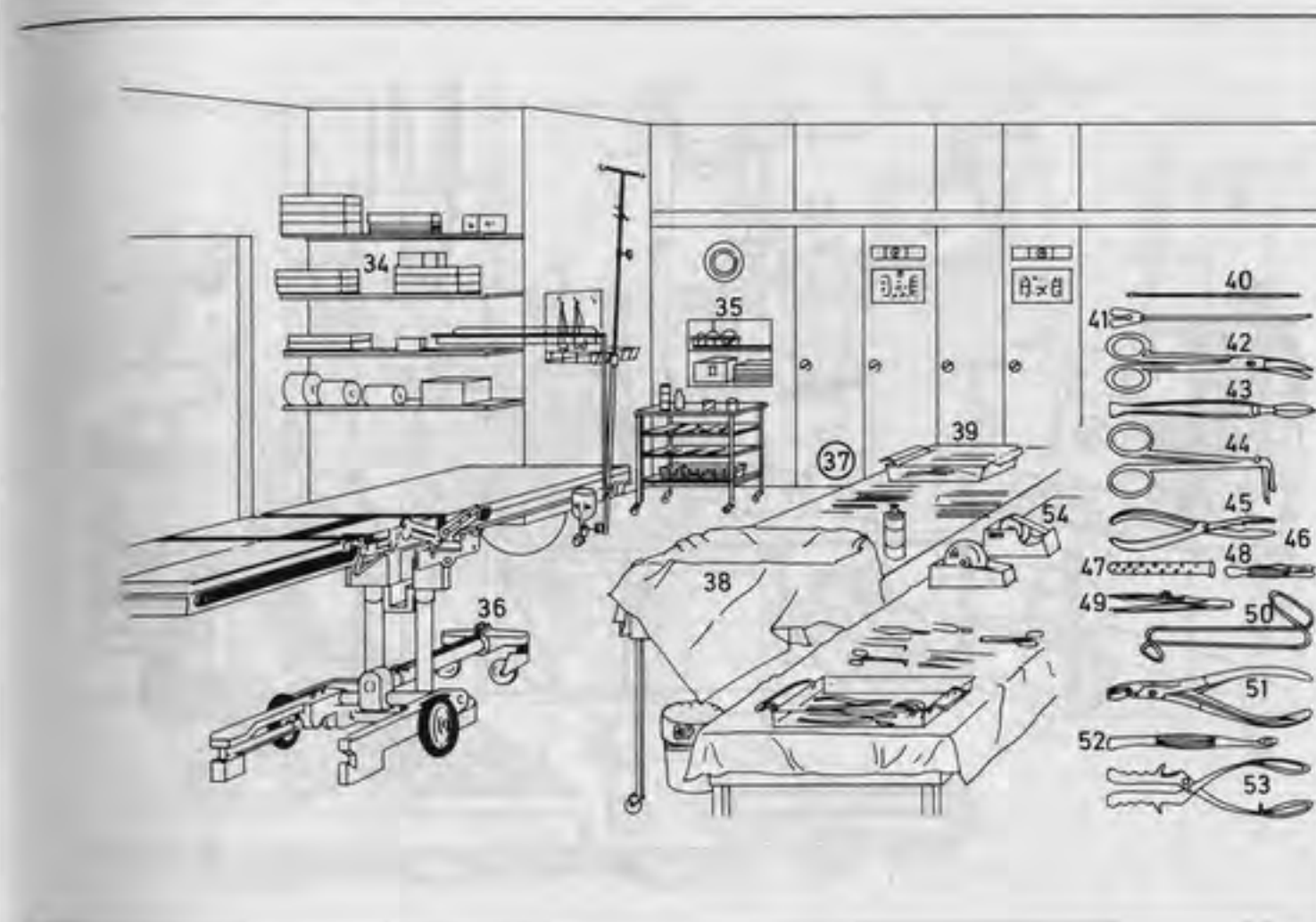
**32 sphygmograph****33 monitor****34-54 preparation and sterilization room****34 dressing material****35 small sterilizer****36 carriage of the operating table****37 mobile instrument table****38 sterile cloth****39 instrument tray****40-53 surgical instruments****40 olive-pointed (bulb-headed) probe****41 hollow probe****42 curved scissors****43 scalpel (surgical knife)****44 ligature-holding forceps****45 sequestrum forceps****46 jaw****47 drainage tube****48 surgeon's tourniquet****49 artery forceps****50 blunt hook****51 bone nippers (bone-cutting forceps)****52 scoop (curette) for erosion (curettage)****53 obstetrical forceps****54 roll of plaster**

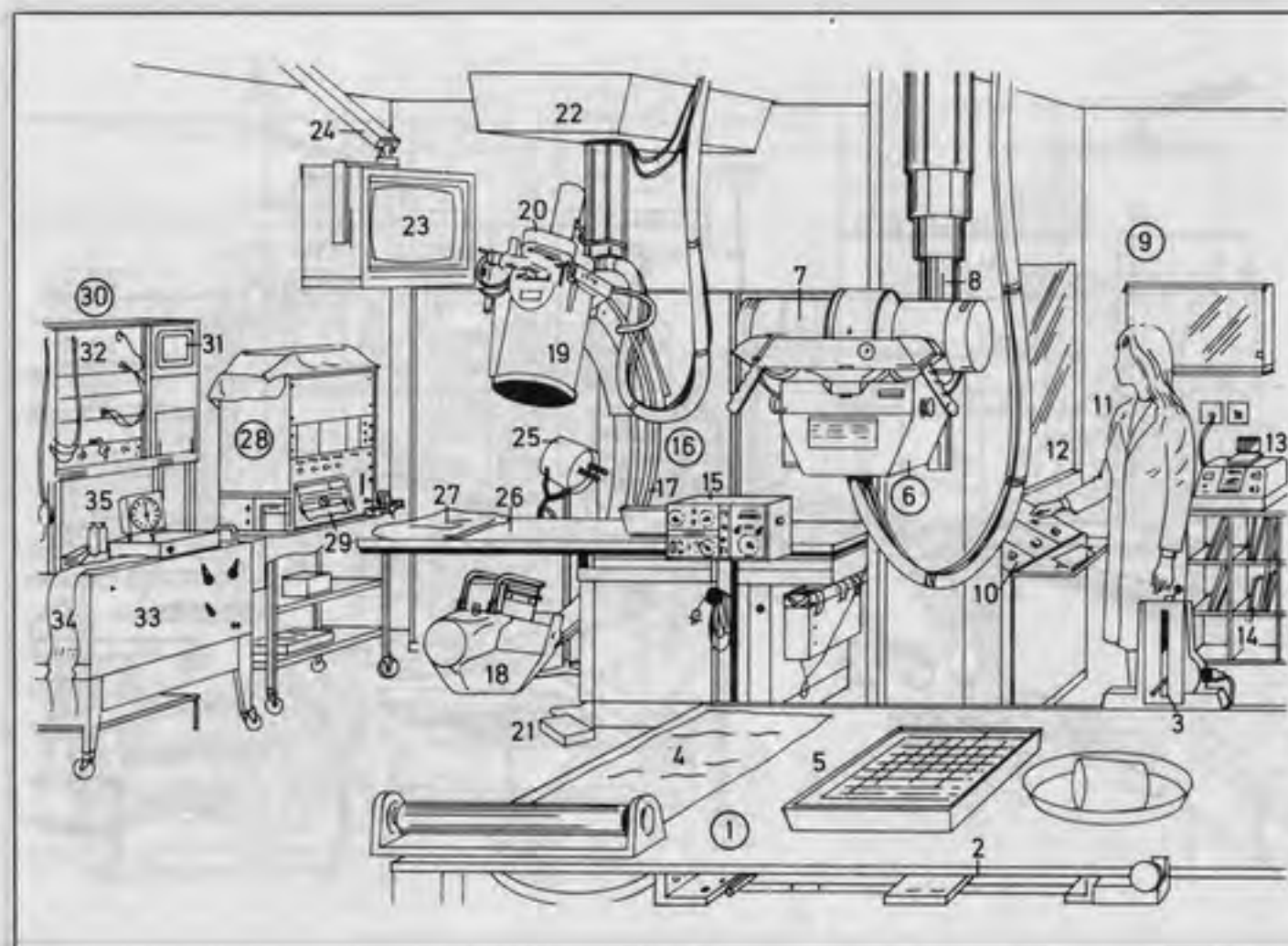

**1-35 X-ray unit**

- |   |   |
|---|---|
| 1 X-ray examination table                                 | 20 film camera  |
| 2 support for X-ray cassettes                             | 21 foot switch  |
| 3 height adjustment of the central beam for lateral views | 22 mobile mounting  |
| 4 compress for pyelography and cholecystography           | 23 monitor  |
| 5 instrument basin  | 24 swivel-mounted monitor support   |
| 6 X-ray apparatus for pyelograms                          | 25 operating lamp   |
| 7 X-ray tube  | 26 angiographic examination table   |
| 8 telescopic X-ray support                                | 27 pillow   |
| 9 central X-ray control unit                              | 28 eight-channel recorder   |
| 10 control panel (control desk)                           | 29 recording paper  |
| 11 radiographer (X-ray technician)                        | 30 catheter gauge ( <i>Am. gage</i> ) unit for catheterization of the heart |
| 12 window to the angiography room                         | 31 six-channel monitor for pressure graphs and ECG                          |
| 13 oxymeter   | 32 slide-in units of the pressure transducer                                |
| 14 pyelogram cassettes                                    | 33 paper recorder unit with developer for photographic recording            |
| 15 contrast medium injector                               | 34 recording paper  |
| 16 X-ray image intensifier                                | 35 timer  |
| 17 C-shaped frame   |   |
| 18 X-ray head with X-ray tube                             |   |
| 19 image converter with converter tube                    |   |

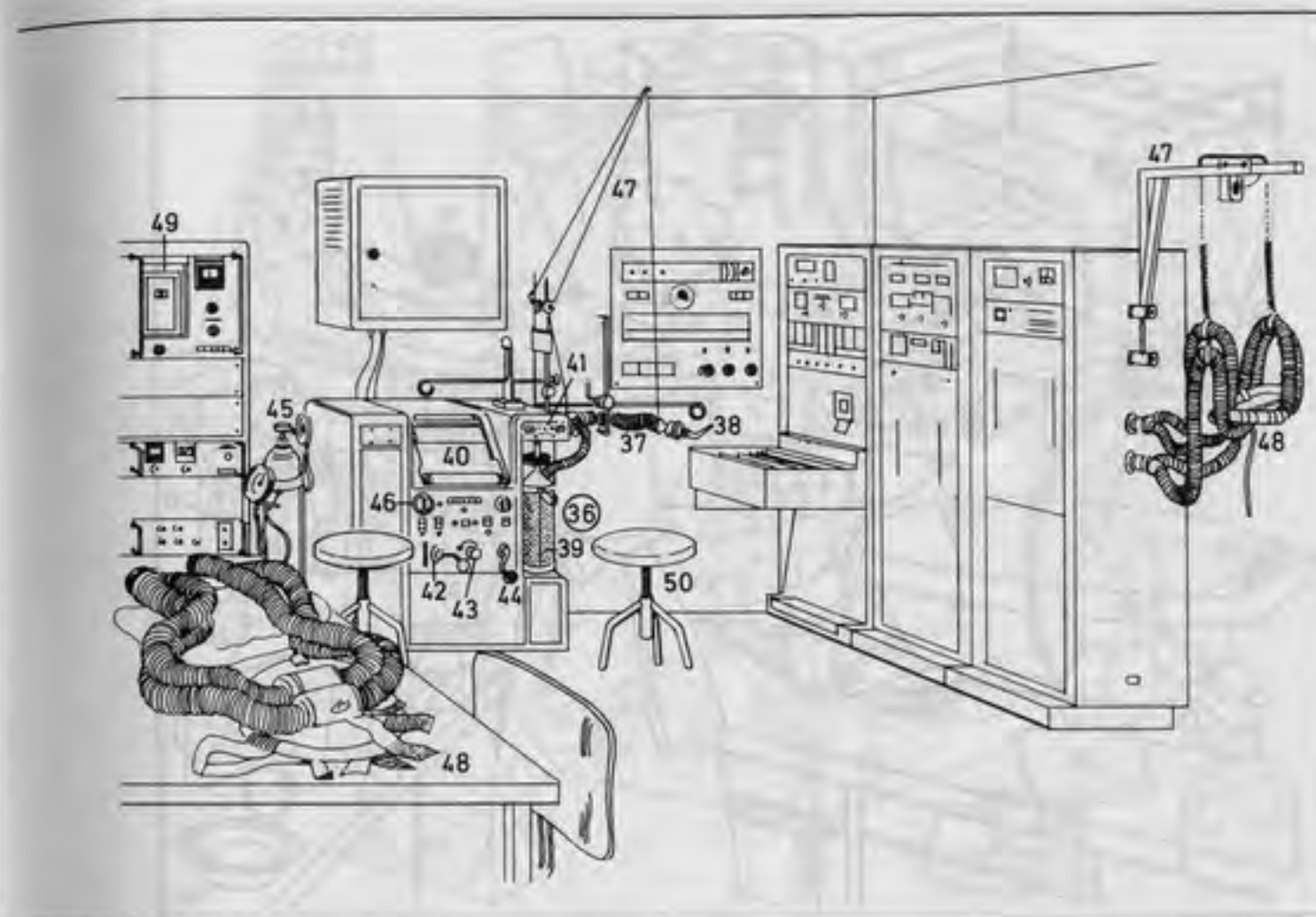
**36-50 spirometry**

- |  |
|--|
| 36 spirometer for pulmonary function tests |
| 37 breathing tube                          |
| 38 mouthpiece                              |
| 39 soda-lime absorber                      |
| 40 recording paper                         |
| 41 control knobs for gas supply            |
| 42 O <sub>2</sub> -stabilizer              |
| 43 throttle valve                          |
| 44 absorber attachment                     |
| 45 oxygen cylinder                         |
| 46 water supply                            |
| 47 tube support                            |
| 48 mask                                    |
| 49 CO <sub>2</sub> consumption meter       |
| 50 stool for the patient                   |



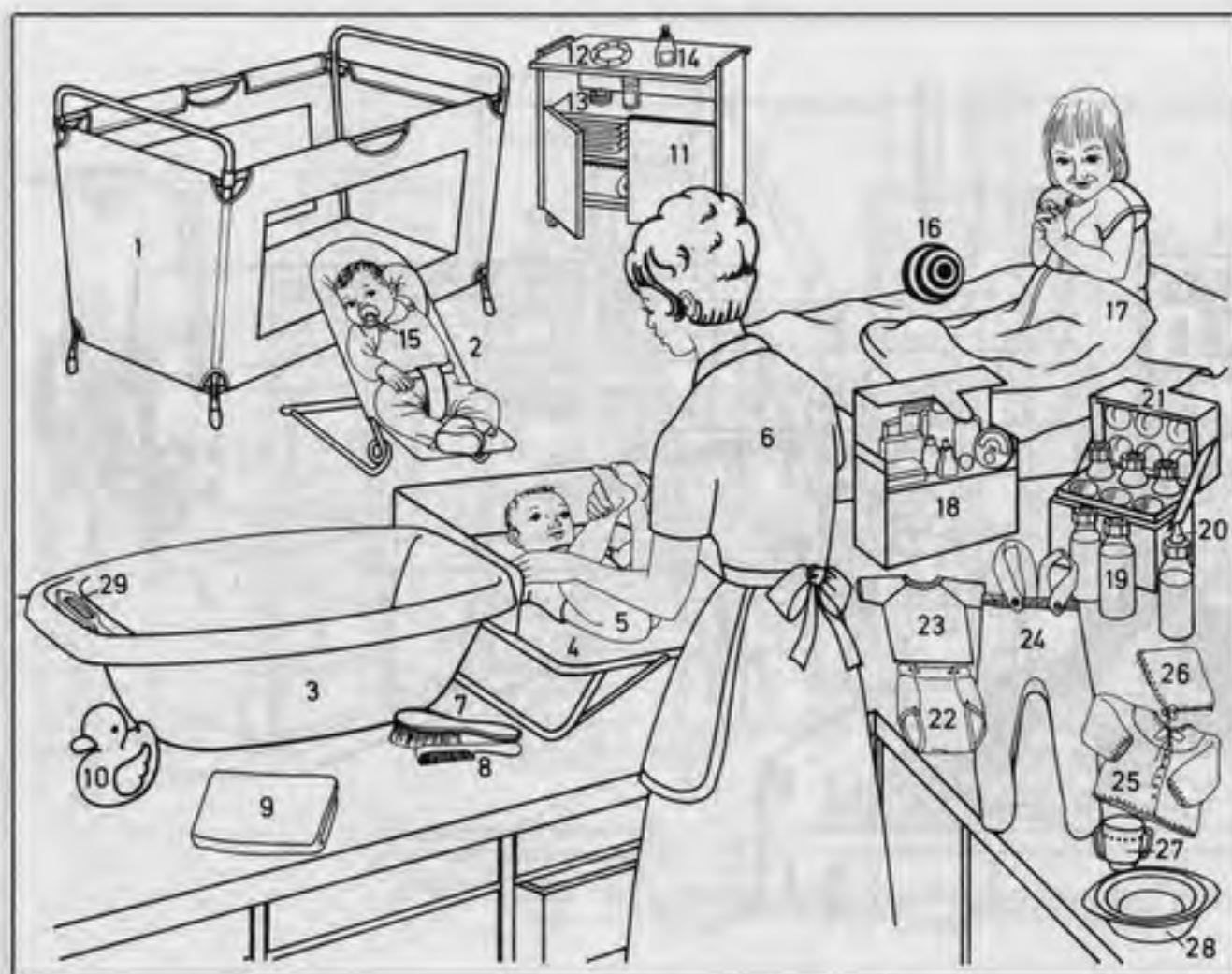

- 1 collapsible cot
- 2 bouncing cradle
- 3 baby bath
- 4 changing top
- 5 baby (new-born baby)
- 6 mother
- 7 hairbrush
- 8 comb
- 9 hand towel
- 10 toy duck
- 11 changing unit
- 12 teething ring
- 13 cream jar
- 14 box of baby powder
- 15 dummy
- 16 ball
- 17 sleeping bag
- 18 layette box
- 19 feeding bottle
- 20 teat
- 21 bottle warmer
- 22 rubber baby pants for disposable nappies (*Am.* diapers)
- 23 vest
- 24 leggings

- 25 baby's jacket
- 26 hood
- 27 baby's cup
- 28 baby's plate, a stay-warm plate
- 29 thermometer



- 30 bassinet, a wicker pram
- 31 set of bassinet covers
- 32 canopy
- 33 baby's high chair, a folding chair
- 34 pram (baby-carriage)[with windows]
- 35 folding hood
- 36 window
- 37 pushchair (*Am.* stroller)
- 38 foot-muff (*Am.* foot-bag)
- 39 play pen
- 40 floor of the play pen
- 41 building blocks (building bricks)
- 42 small child
- 43 bib
- 44 rattle (baby's rattle)
- 45 booties
- 46 teddy bear
- 47 potty (baby's pot)
- 48 carrycot
- 49 window
- 50 handles



## 1-12 baby clothes

- 1 pram suit
- 2 hood
- 3 pram jacket (matinée coat)
- 4 pompon (bobble)
- 5 bootees
- 6 sleeveless vest
- 7 envelope-neck vest
- 8 wrapover vest
- 9 baby's jacket
- 10 rubber baby pants
- 11 playsuit
- 12 two-piece suit

- 13-30 infants' wear
- 13 child's sundress, a pinafore dress
- 14 frilled shoulder strap
- 15 Shirred top
- 16 sun hat
- 17 one-piece jersey suit
- 18 front zip
- 19 catsuit (playsuit)
- 20 motif (appliqué)
- 21 romper
- 22 playsuit (romper suit)
- 23 coverall (sleeper and strampler)
- 24 dressing gown (bath robe)
- 25 children's shorts
- 26 braces (Am. suspenders)
- 27 children's T-shirt
- 28 jersey dress (knitted dress)
- 29 embroidery
- 30 children's ankle socks

## 31-47 school children's wear

- 31 raincoat (loden coat)
- 32 leather shorts (lederhosen)
- 33 staghorn button
- 34 braces (Am. suspenders)
- 35 flap
- 36 girl's dirndl
- 37 cross lacing
- 38 snow suit (quilted suit)
- 39 quilt stitching (quilting)
- 40 dungarees (bib and brace)
- 41 bib skirt (bib top pinafore)
- 42 tights
- 43 sweater (jumper)
- 44 pile jacket
- 45 leggings
- 46 girl's skirt
- 47 child's jumper

## 48-68 teenagers' clothes

- 48 girl's overblouse (overtop)
- 49 slacks

- 50 girl's skirt suit
- 51 jacket
- 52 skirt
- 53 knee-length socks
- 54 girl's coat
- 55 tie belt
- 56 girl's bag
- 57 woollen (Am. woolen) hat
- 58 girl's blouse
- 59 culottes
- 60 boy's trousers
- 61 boy's shirt
- 62 anorak
- 63 inset pockets
- 64 hood drawstring (drawstring)
- 65 knitted welt
- 66 parka coat (parka)
- 67 drawstring (draw cord)
- 68 patch pockets





- 1 mink jacket
- 2 cowl neck jumper
- 3 cowl collar
- 4 knitted overtop
- 5 turndown collar
- 6 turn-up (turnover) sleeve
- 7 polo neck jumper
- 8 pinafore dress
- 9 blouse with revers collar
- 10 shirt-waister dress, a button-through dress
- 11 belt
- 12 winter dress
- 13 piping
- 14 cuff
- 15 long sleeve
- 16 quilted waistcoat
- 17 quilt stitching (quilting)
- 18 leather trimming
- 19 winter slacks
- 20 striped polo jumper
- 21 boiler suit (dungarees, bib and brace)
- 22 patch pocket
- 23 front pocket
- 24 bib
- 25 wrapover dress (wrap-around dress)
- 26 shirt
- 27 peasant-style dress
- 28 floral braid
- 29 tunic (tunic top, tunic dress)
- 30 ribbed cuff
- 31 quilted design
- 32 pleated skirt
- 33 two-piece knitted dress
- 34 boat neck, a neckline
- 35 turn-up
- 36 kimono sleeve
- 37 knitted design
- 38 lumber-jacket
- 39 cable pattern
- 40 shirt-blouse
- 41 loop fastening
- 42 embroidery
- 43 stand-up collar
- 44 cossack trousers
- 45 two-piece combination (shirt top and long skirt)
- 46 tie (bow)
- 47 decorative facing
- 48 cuff slit
- 49 side slit

- 50 tabard
- 51 inverted pleat skirt
- 52 godet
- 53 evening gown
- 54 pleated bell sleeve
- 55 party blouse
- 56 party skirt
- 57 trouser suit (slack suit)
- 58 suede jacket
- 59 fur trimming
- 60 fur coat (*kinds: Persian lamb, broadtail, mink, sable*)
- 61 winter coat (cloth coat)
- 62 fur cuff (fur-trimmed cuff)
- 63 fur collar (fur-trimmed collar)
- 64 loden coat
- 65 cape
- 66 toggle fastenings
- 67 loden skirt
- 68 poncho-style coat
- 69 hood





- 1 skirt suit
- 2 jacket
- 3 skirt
- 4 inset pocket
- 5 decorative stitching
- 6 dress and jacket combination
- 7 piping
- 8 pinafore dress
- 9 summer dress
- 10 belt
- 11 two-piece dress
- 12 belt buckle
- 13 wrapover (wrap-around) skirt
- 14 pencil silhouette
- 15 shoulder buttons
- 16 batwing sleeve
- 17 overdress
- 18 kimono yoke
- 19 tie belt
- 20 summer coat
- 21 detachable hood
- 22 summer blouse
- 23 lapel
- 24 skirt
- 25 front pleat
- 26 dirndl (dirndl dress)
- 27 puffed sleeve
- 28 dirndl necklace
- 29 dirndl blouse
- 30 bodice
- 31 dirndl apron
- 32 lace trimming (lace), cotton lace
- 33 frilled apron
- 34 frill
- 35 smock overall
- 36 house frock (house dress)
- 37 poplin jacket
- 38 T-shirt
- 39 ladies' shorts
- 40 trouser turn-up
- 41 waistband
- 42 bomber jacket
- 43 stretch welt
- 44 Bermuda shorts
- 45 saddle stitching
- 46 frill collar
- 47 knot
- 48 culotte
- 49 twin set
- 50 cardigan
- 51 sweater
- 52 summer (lightweight) slacks
- 53 jumpsuit

- 54 turn-up
- 55 zip
- 56 patch pocket
- 57 scarf (neckerchief)
- 58 denim suit
- 59 denim waistcoat
- 60 jeans (denims)
- 61 overblouse
- 62 turned-up sleeve
- 63 stretch belt
- 64 halter top
- 65 knitted overtop
- 66 drawstring waist
- 67 short-sleeved jumper
- 68 V-neck (vee-neck)
- 69 turndown collar
- 70 knitted welt
- 71 shawl





- 1-15 ladies' underwear (ladies' underclothes, lingerie)
- 1 brassière (bra)
- 2 pantie-girdle
- 3 pantie-corsette
- 4 longline brassière (longline bra)
- 5 stretch girdle
- 6 suspender
- 7 vest
- 8 pantie briefs
- 9 ladies' knee-high stocking
- 10 long-legged (long leg) panties
- 11 long pants
- 12 tights (pantie-hose)
- 13 slip
- 14 waist slip
- 15 bikini briefs
- 16-21 ladies' nightwear
- 16 nightdress (nightgown, nightie)
- 17 pyjamas (Am. pajamas)
- 18 pyjama top
- 19 pyjama trousers
- 20 housecoat
- 21 vest and shorts set [for leisure wear and as nightwear]
- 22-29 men's underwear (men's underclothes)
- 22 string vest
- 23 string briefs
- 24 front panel
- 25 sleeveless vest
- 26 briefs
- 27 trunks
- 28 short-sleeved vest
- 29 long johns
- 30 braces (Am. suspenders)
- 31 braces clip
- 32-34 men's socks
- 32 knee-length sock
- 33 elasticated top
- 34 long sock
- 35-37 men's nightwear
- 35 dressing gown
- 36 pyjamas (Am. pajamas)
- 37 nightshirt

- 38-47 men's shirts
- 38 casual shirt
- 39 belt
- 40 cravat
- 41 tie
- 42 knot
- 43 dress shirt
- 44 frill (frill front)
- 45 cuff
- 46 cuff link
- 47 bow-tie





## 1-67 men's fashion

- 1 single-breasted suit, a men's suit
- 2 jacket
- 3 suit trousers
- 4 waistcoat (vest)
- 5 lapel
- 6 trouser leg with crease
- 7 dinner dress, an evening suit
- 8 silk lapel
- 9 breast pocket
- 10 dress handkerchief
- 11 bow-tie
- 12 side pocket
- 13 tailcoat (tails), evening dress
- 14 coat-tail
- 15 white waistcoat (vest)
- 16 white bow-tie
- 17 casual suit
- 18 pocket flap
- 19 front yoke
- 20 denim suit
- 21 denim jacket
- 22 jeans (denims)
- 23 waistband
- 24 beach suit
- 25 shorts
- 26 short-sleeved jacket
- 27 tracksuit
- 28 tracksuit top with zip
- 29 tracksuit bottoms
- 30 cardigan
- 31 knitted collar
- 32 men's short-sleeved pullover  
(men's short-sleeved sweater)
- 33 short-sleeved shirt
- 34 shirt button
- 35 turn-up
- 36 knitted shirt
- 37 casual shirt
- 38 patch pocket
- 39 casual jacket
- 40 knee-breeches
- 41 knee strap
- 42 knee-length sock
- 43 leather jacket
- 44 bib and brace overalls
- 45 adjustable braces (*Am.*  
suspenders)
- 46 front pocket
- 47 trouser pocket
- 48 fly
- 49 rule pocket
- 50 check shirt

- 51 men's pullover
- 52 heavy pullover
- 53 knitted waistcoat (vest)
- 54 blazer
- 55 jacket button
- 56 overall
- 57 trenchcoat
- 58 coat collar
- 59 coat belt
- 60 poplin coat
- 61 coat pocket
- 62 fly front
- 63 car coat
- 64 coat button
- 65 scarf
- 66 cloth coat
- 67 glove





1-25 men's beards and hairstyles  
(haircuts)

- 1 long hair worn loose
- 2 allonge periwig (full-bottomed wig), a wig; *shorter and smoother*: bob wig, toupet
- 3 curls
- 4 bag wig (purse wig)
- 5 pigtail wig
- 6 queue (pigtail)
- 7 bow (ribbon)
- 8 handlebars (handlebar moustache, *Am.* mustache)
- 9 centre (*Am.* center) parting
- 10 goatee (goatee beard), chintuft
- 11 closely-cropped head of hair (crew cut)
- 12 whiskers
- 13 Vandyke beard (stiletto beard, bodkin beard), with waxed moustache (*Am.* mustache)
- 14 side parting
- 15 full beard (circular beard, round beard)
- 16 tile beard
- 17 shadow
- 18 head of curly hair
- 19 military moustache (*Am.* mustache) (*English-style* moustache)
- 20 partly bald head
- 21 bald patch
- 22 bald head
- 23 stubble beard (stubble, short beard bristles)
- 24 side-whiskers (sideboards, sideburns)
- 25 clean shave
- 26 Afro look (for men and women)
- 27-38 ladies' hairstyles (coiffures, women's and girls' hairstyles)
- 27 ponytail
- 28 swept-back hair (swept-up hair, pinned-up hair)
- 29 bun (chignon)
- 30 plaits (bunches)
- 31 chaplet hairstyle (Gretchen style)
- 32 chaplet (coiled plaits)
- 33 curled hair

## 34 shingle (shingled hair, bobbed hair)

- 35 pageboy style
- 36 fringe (*Am.* bangs)
- 37 earphones
- 38 earphone (coiled plait)

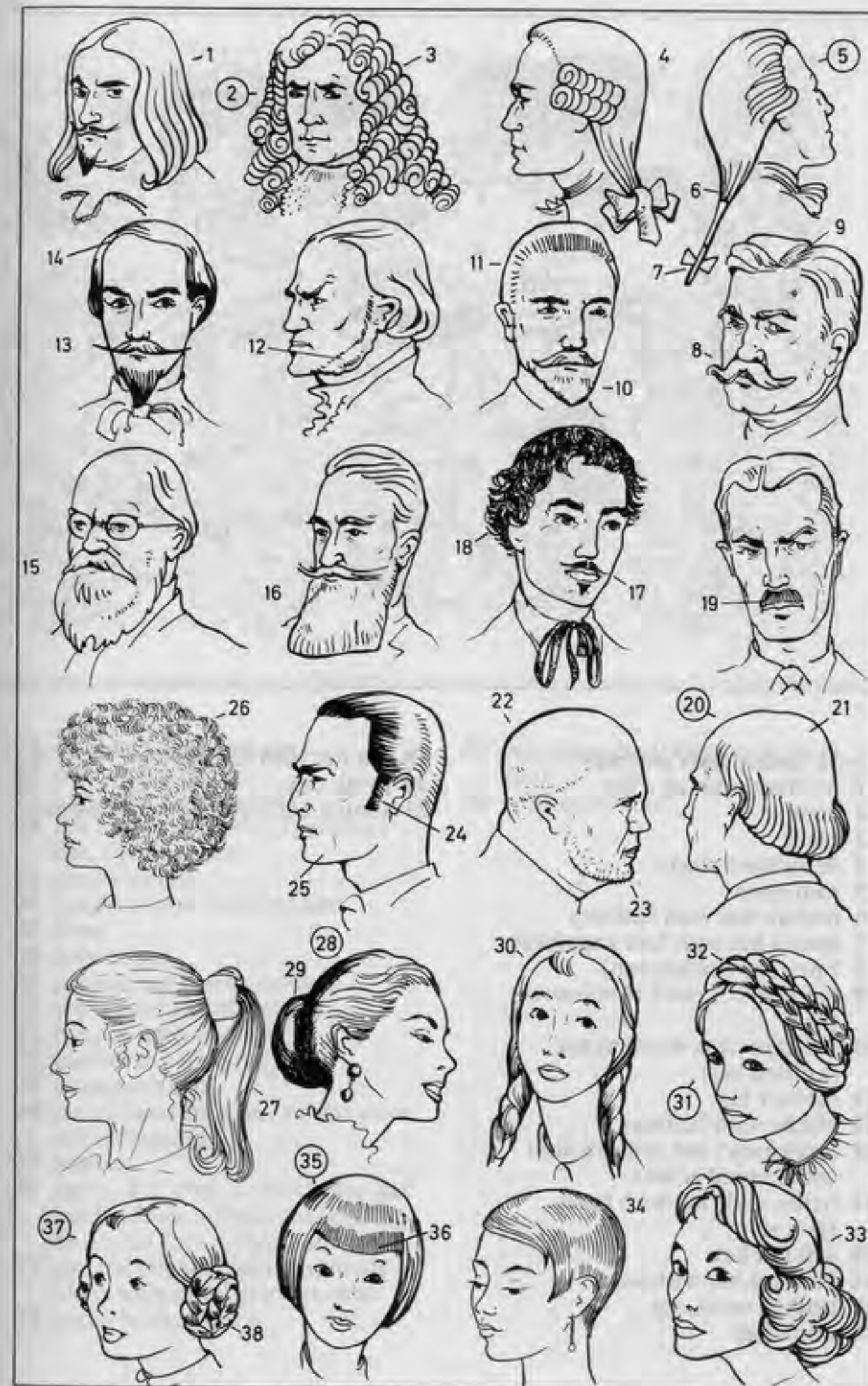



**1-21 ladies' hats and caps**

- 1 milliner making a hat
- 2 hood
- 3 block
- 4 decorative pieces
- 5 sombrero
- 6 mohair hat with feathers
- 7 model hat with fancy appliqué
- 8 linen cap (jockey cap)
- 9 hat made of thick candlewick yarn
- 10 woollen (*Am.* woolen) hat (knitted hat)
- 11 mohair hat
- 12 cloche with feathers
- 13 large men's hat made of sisal with corded ribbon
- 14 trilby-style hat with fancy ribbon
- 15 soft felt hat
- 16 Panama hat with scarf
- 17 peaked mink cap
- 18 mink hat

**19 fox hat with leather top**

- 20 mink cap
- 21 slouch hat trimmed with flowers

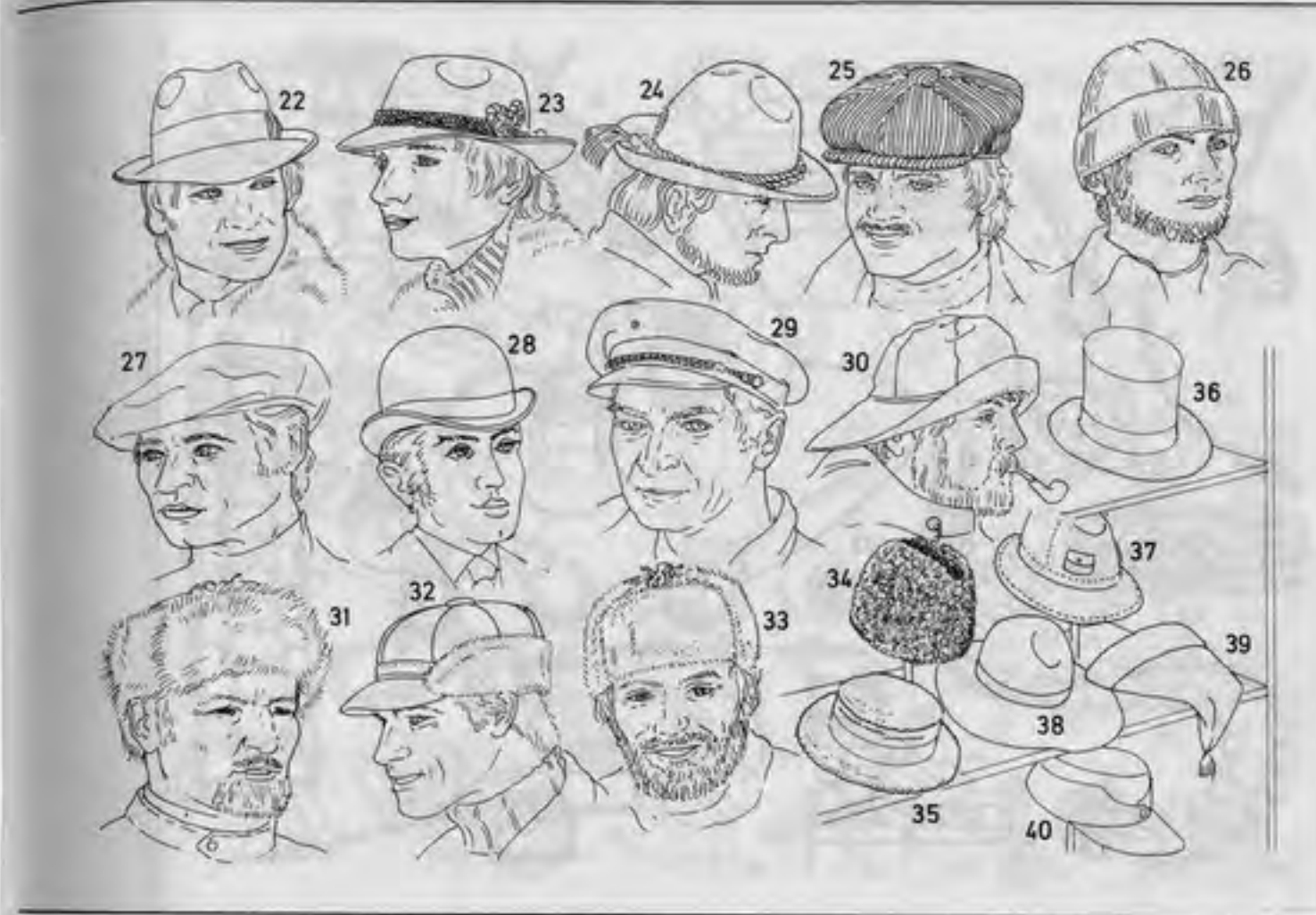
**22-40 men's hats and caps**

- 22 trilby hat (trilby)
- 23 loden hat (Alpine hat)
- 24 felt hat with tassels (Tyrolean hat, Tyrolese hat)
- 25 corduroy cap
- 26 woollen (*Am.* woolen) hat
- 27 beret
- 28 bowler hat
- 29 peaked cap (yachting cap)
- 30 sou'wester (southwester)
- 31 fox cap with earflaps
- 32 leather cap with fur flaps
- 33 musquash cap
- 34 astrakhan cap, a real or imitation astrakhan cap
- 35 boater
- 36 (grey, *Am.* gray, or black) top hat made of silk taffeta; *collapsible*: crush hat (opera hat, claque)
- 37 sun hat (lightweight hat) made of cloth with small patch pocket
- 38 wide-brimmed hat

**39 toboggan cap (skiing cap, ski cap)**

- 40 workman's cap



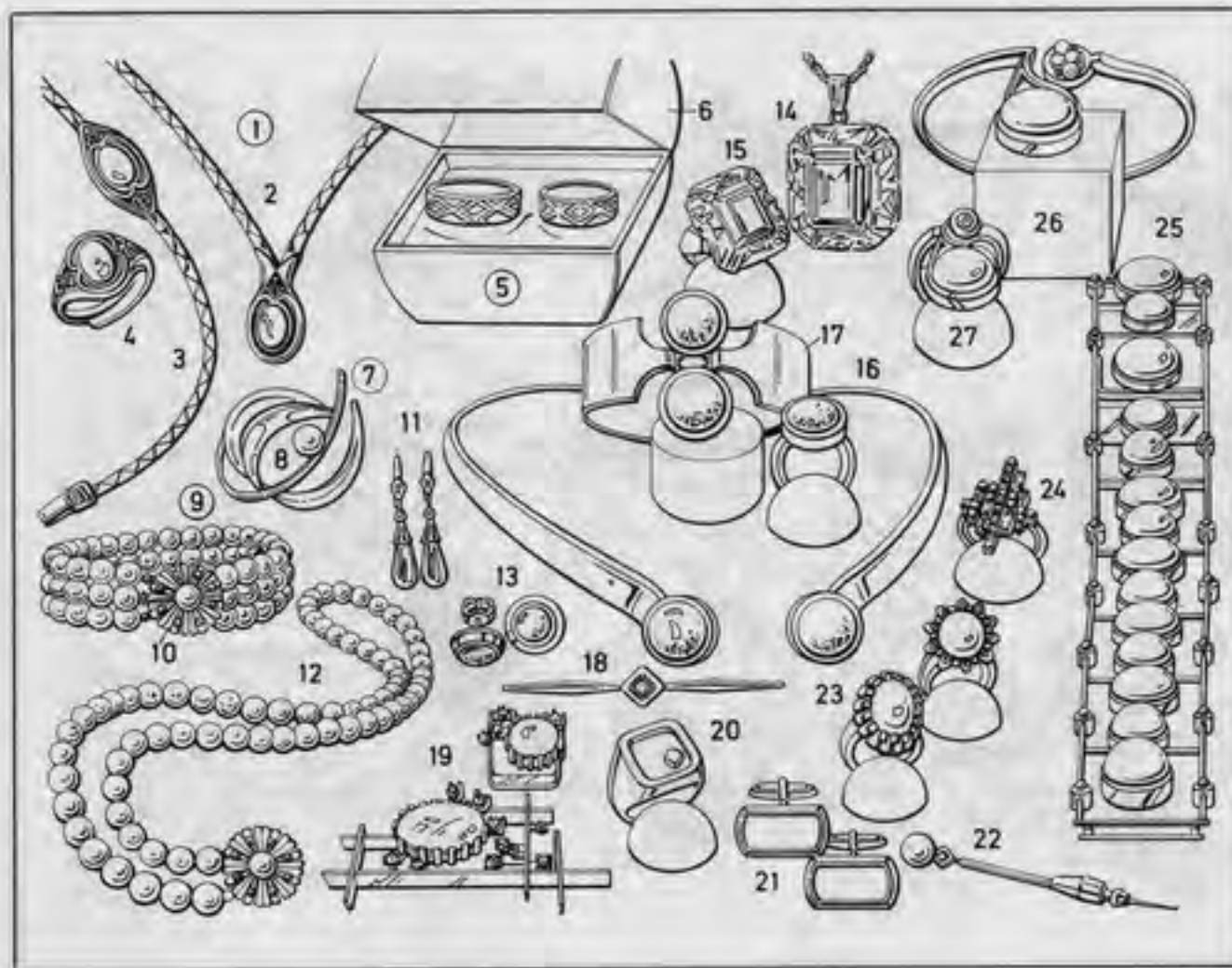

- |   |                           |
|---|---------------------------|
| 1 set of jewellery ( <i>Am. jewelry</i> ) | 26 asymmetrical bangle    |
| 2 necklace                                | 27 asymmetrical ring      |
| 3 bracelet                                | 28 ivory necklace         |
| 4 ring                                    | 29 ivory rose             |
| 5 wedding rings                           | 30 ivory brooch           |
| 6 wedding ring box                        | 31 jewel box (jewel case) |
| 7 brooch, a pearl brooch                  | 32 pearl necklace         |
| 8 pearl                                   | 33 bracelet watch         |
| 9 cultured pearl bracelet                 | 34 coral necklace         |
| 10 clasp, a white gold clasp              | 35 charms                 |
| 11 pendant earrings (drop earrings)       | 36 coin bracelet          |
| 12 cultured pearl necklace                | 37 gold coin              |
| 13 earrings                               | 38 coin setting           |
| 14 gemstone pendant                       | 39 link                   |
| 15 gemstone ring                          | 40 signet ring            |
| 16 choker (collar, neckband)              | 41 engraving (monogram)   |
| 17 bangle                                 | 42-86 cuts and forms      |
| 18 diamond pin                            |                           |
| 19 modern-style brooches                  |                           |
| 20 man's ring                             |                           |
| 21 cuff links                             |                           |
| 22 tiepin                                 |                           |
| 23 diamond ring with pearl                |                           |
| 24 modern-style diamond ring              |                           |
| 25 gemstone bracelet                      |                           |

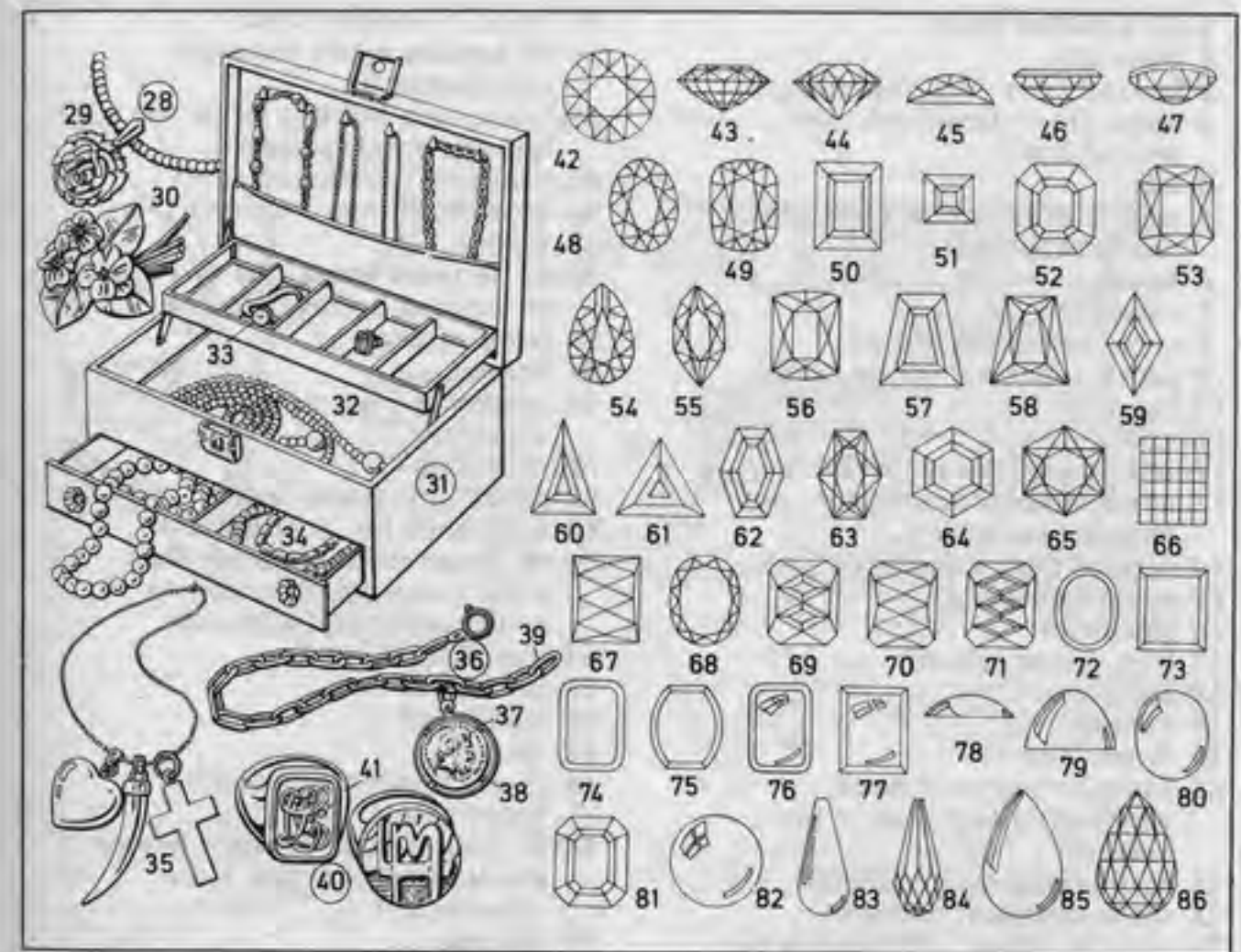

- |                          |                              |                                  |                                     |                              |                             |                             |                              |                      |                       |                        |                                     |                           |                          |
|--------------------------|------------------------------|----------------------------------|-------------------------------------|------------------------------|-----------------------------|-----------------------------|------------------------------|----------------------|-----------------------|------------------------|-------------------------------------|---------------------------|--------------------------|
| 28                       | 29                           | 30                               | 31                                  | 32                           | 33                          | 34                          | 35                           | 36                   | 37                    | 38                     | 39                                  | 40                        | 41                       |
| 42-71 faceted stones     | 72-77 ring gemstones         | 78-81 cabochons                  | 82-86 spheres and pear-shapes       | 82 plain sphere              | 83 plain pear-shape         | 84 faceted pear-shape       | 85 plain drop                | 86 faceted briolette |                       |                        |                                     |                           |                          |
| 42-43 standard round cut | 44 brilliant cut             | 45 rose cut                      | 46 flat table                       | 47 table en cabochon         | 48 standard cut             | 49 standard antique cut     | 50 rectangular step-cut      | 51 square step-cut   | 52 octagonal step-cut | 53 octagonal cross-cut | 54 standard pear-shape (pendeloque) | 55 marquise (navette)     | 56 standard barrel-shape |
| 57 trapezium step-cut    | 58 trapezium cross-cut       | 59 rhombus step-cut              | 60-61 triangular step-cut           | 62 hexagonal step-cut        | 63 oval hexagonal cross-cut | 64 round hexagonal step-cut | 65 round hexagonal cross-cut | 66 chequer-board cut | 67 triangle cut       | 68-71 fancy cuts       | 72 oval flat table                  | 73 rectangular flat table | 74 octagonal flat table  |
| 75 barrel-shape          | 76 antique table en cabochon | 77 rectangular table en cabochon | 78 round cabochon (simple cabochon) | 79 high dome (high cabochon) | 80 oval cabochon            | 81 octagonal cabochon       |                              |                      |                       |                        |                                     |                           |                          |



- 1-53 detached house
- 1 basement
- 2 ground floor (*Am.* first floor)
- 3 upper floor (first floor, *Am.* second floor)
- 4 loft
- 5 roof, a gable roof (saddle roof, saddleback roof)
- 6 gutter
- 7 ridge
- 8 verge with bargeboards
- 9 eaves, rafter-supported eaves
- 10 chimney
- 11 gutter
- 12 swan's neck (swan-neck)
- 13 rainwater pipe (downpipe, *Am.* downspout, leader)
- 14 vertical pipe, a cast-iron pipe
- 15 gable (gable end)
- 16 glass wall
- 17 base course (plinth)
- 18 balcony
- 19 parapet
- 20 flower box
- 21 French window (French windows) opening on to the balcony
- 22 double casement window
- 23 single casement window
- 24 window breast with window sill
- 25 lintel (window head)
- 26 reveal
- 27 cellar window (basement window)
- 28 rolling shutter
- 29 rolling shutter frame
- 30 window shutter (folding shutter)
- 31 shutter catch
- 32 garage with tool shed
- 33 espalier
- 34 batten door (ledged door)
- 35 fanlight with mullion and transom
- 36 terrace
- 37 garden wall with coping stones
- 38 garden light
- 39 steps
- 40 rockery (rock garden)
- 41 outside tap (*Am.* faucet) for the hose
- 42 garden hose
- 43 lawn sprinkler
- 44 paddling pool
- 45 stepping stones
- 46 sunbathing area (lawn)
- 47 deck-chair
- 48 sunshade (garden parasol)
- 49 garden chair
- 50 garden table
- 51 frame for beating carpets
- 52 garage driveway
- 53 fence, a wooden fence
- 54-57 housing estate (housing development)
- 54 house on a housing estate (on a housing development)
- 55 pent roof (penthouse roof)
- 56 dormer (dormer window)
- 57 garden
- 58-63 terraced house [one of a row of terraced houses], stepped
- 58 front garden
- 59 hedge
- 60 pavement (*Am.* sidewalk, walkway)
- 61 street (road)
- 62 street lamp (street light)
- 63 litter bin (*Am.* litter basket)
- 64-68 house divided into two flats (*Am.* house divided into two apartments, duplex house)
- 64 hip (hipped) roof
- 65 front door
- 66 front steps
- 67 canopy
- 68 flower window (window for house plants)
- 69-71 pair of semi-detached houses divided into four flats (*Am.* apartments)
- 69 balcony
- 70 sun lounge (*Am.* sun parlor)
- 71 awning (sun blind, sunshade)
- 72-76 block of flats (*Am.* apartment building, apartment house) with access balconies
- 72 staircase
- 73 balcony
- 74 studio flat (*Am.* studio apartment)
- 75 sun roof, a sun terrace
- 76 open space
- 77-81 multi-storey block of flats (*Am.* multistorey apartment building, multistorey apartment house)
- 77 flat roof
- 78 pent roof (shed roof, lean-to roof)
- 79 garage
- 80 pergola
- 81 staircase window
- 82 high-rise block of flats (*Am.* high-rise apartment building, high-rise apartment house)
- 83 penthouse
- 84-86 weekend house, a timber house
- 84 horizontal boarding
- 85 natural stone base course (natural stone plinth)
- 86 strip windows (ribbon windows)

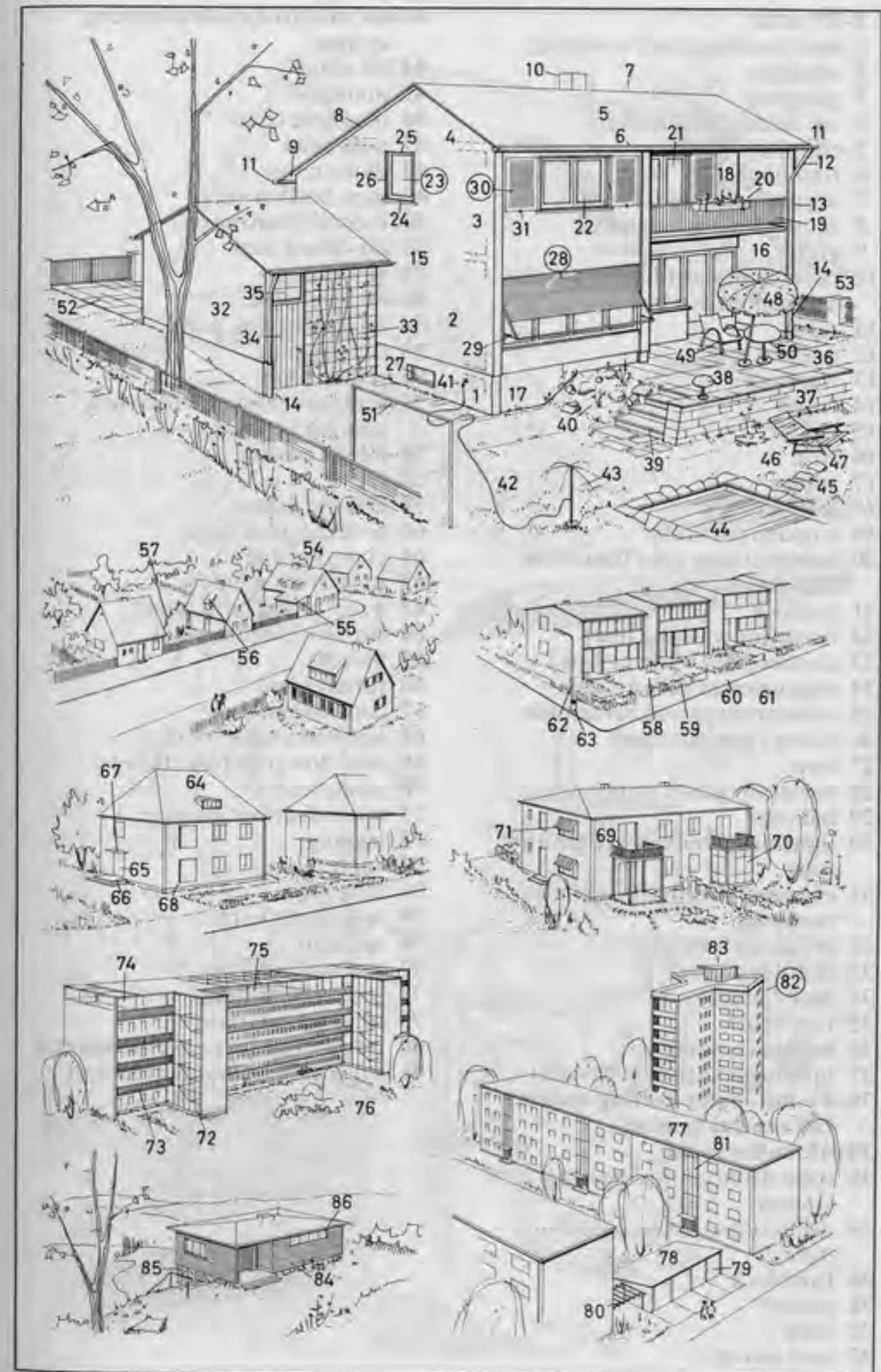



- 1-29 attic
- 1 roof cladding (roof covering)
- 2 skylight
- 3 gangway
- 4 cat ladder (roof ladder)
- 5 chimney
- 6 roof hook
- 7 dormer window (dormer)
- 8 snow guard (roof guard)
- 9 gutter
- 10 rainwater pipe (downpipe, *Am.* downspout, leader)
- 11 eaves
- 12 pitched roof
- 13 trapdoor
- 14 hatch
- 15 ladder
- 16 stile
- 17 rung
- 18 loft (attic)
- 19 wooden partition
- 20 lumber room door (boxroom door)
- 21 padlock
- 22 hook [for washing line]
- 23 clothes line (washing line)
- 24 expansion tank for boiler
- 25 wooden steps and balustrade
- 26 string (*Am.* stringer)
- 27 step
- 28 handrail (guard rail)
- 29 baluster
- 30 lightning conductor (lightning rod)
- 31 chimney sweep (*Am.* chimney sweeper)
- 32 brush with weight
- 33 shoulder iron
- 34 sack for soot
- 35 flue brush
- 36 broom (besom)
- 37 broomstick (broom handle)
- 38-81 hot-water heating system, full central heating
- 38-43 boiler room
- 38 coke-fired central heating system
- 39 ash box door (*Am.* cleanout door)
- 40 flueblock
- 41 poker
- 42 rake
- 43 coal shovel

- 44-60 oil-fired central heating system
- 44 oil tank
- 45 manhole
- 46 manhole cover
- 47 tank inlet
- 48 dome cover
- 49 tank bottom valve
- 50 fuel oil (heating oil)
- 51 air-bleed duct
- 52 air vent cap
- 53 oil level pipe
- 54 oil gauge (*Am.* gage)
- 55 suction pipe
- 56 return pipe
- 57 central heating furnace (oil heating furnace)
- 58-60 oil burner
- 58 fan
- 59 electric motor
- 60 covered pilot light
- 61 charging door
- 62 inspection window
- 63 water gauge (*Am.* gage)
- 64 furnace thermometer
- 65 bleeder
- 66 furnace bed
- 67 control panel
- 68 hot water tank (boiler)
- 69 overflow pipe (overflow)
- 70 safety valve
- 71 main distribution pipe
- 72 lagging
- 73 valve
- 74 flow pipe
- 75 regulating valve
- 76 radiator
- 77 radiator rib
- 78 room thermostat
- 79 return pipe (return)
- 80 return pipe [in two-pipe system]
- 81 smoke outlet (smoke extract)

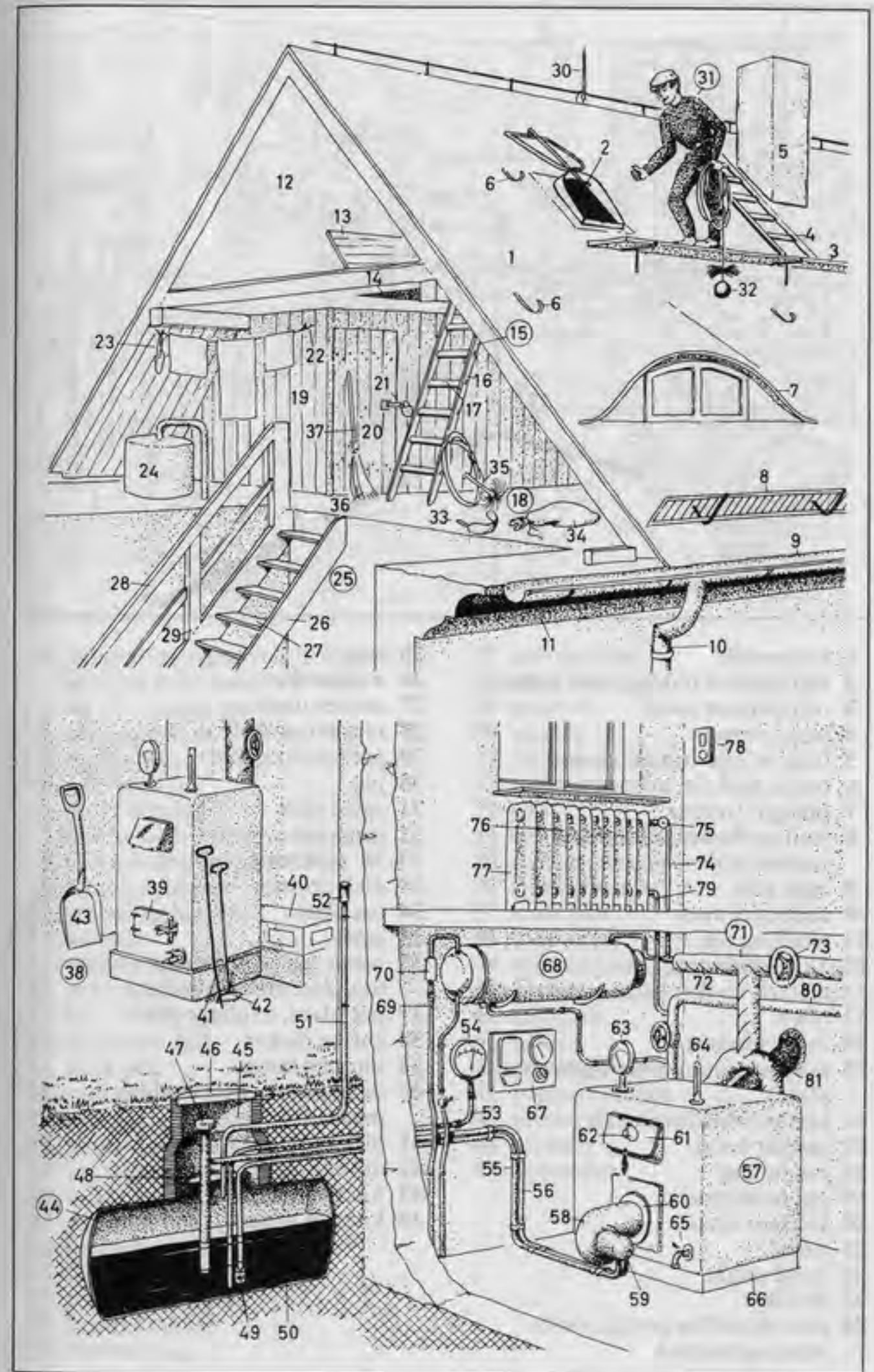





- |   |   |
|---|---|
| 1 housewife                                       | 25 lead   |
| 2 refrigerator (fridge, <i>Am.</i> icebox)        | 26 wall socket  |
| 3 refrigerator shelf                              | 27 corner unit  |
| 4 salad drawer                                    | 28 revolving shelf  |
| 5 frozen food compartment                         | 29 pot (cooking pot)  |
| 6 bottle rack (in storage door)                   | 30 jug  |
| 7 upright freezer                                 | 31 spice rack   |
| 8 wall cupboard, a kitchen cupboard               | 32 spice jar  |
| 9 base unit                                       | 33-36 sink unit   |
| 10 cutlery drawer                                 | 33 dish drainer   |
| 11 working top                                    | 34 tea plate  |
| 12-17 cooker unit                                 | 35 sink   |
| 12 electric cooker ( <i>also:</i> gas cooker)     | 36 water tap ( <i>Am.</i> faucet) (mixer tap, <i>Am.</i> mixing faucet) |
| 13 oven   | 37 pot plant, a foliage plant   |
| 14 oven window                                    | 38 coffee maker   |
| 15 hotplate (automatic high-speed plate)          | 39 kitchen lamp   |
| 16 kettle (whistling kettle)                      | 40 dishwasher (dishwashing machine)                                     |
| 17 cooker hood                                    | 41 dish rack  |
| 18 pot holder                                     | 42 dinner plate   |
| 19 pot holder rack                                | 43 kitchen chair  |
| 20 kitchen clock                                  | 44 kitchen table  |
| 21 timer  |   |
| 22 hand mixer                                     |   |
| 23 whisk  |   |
| 24 electric coffee grinder (with rotating blades) |   |

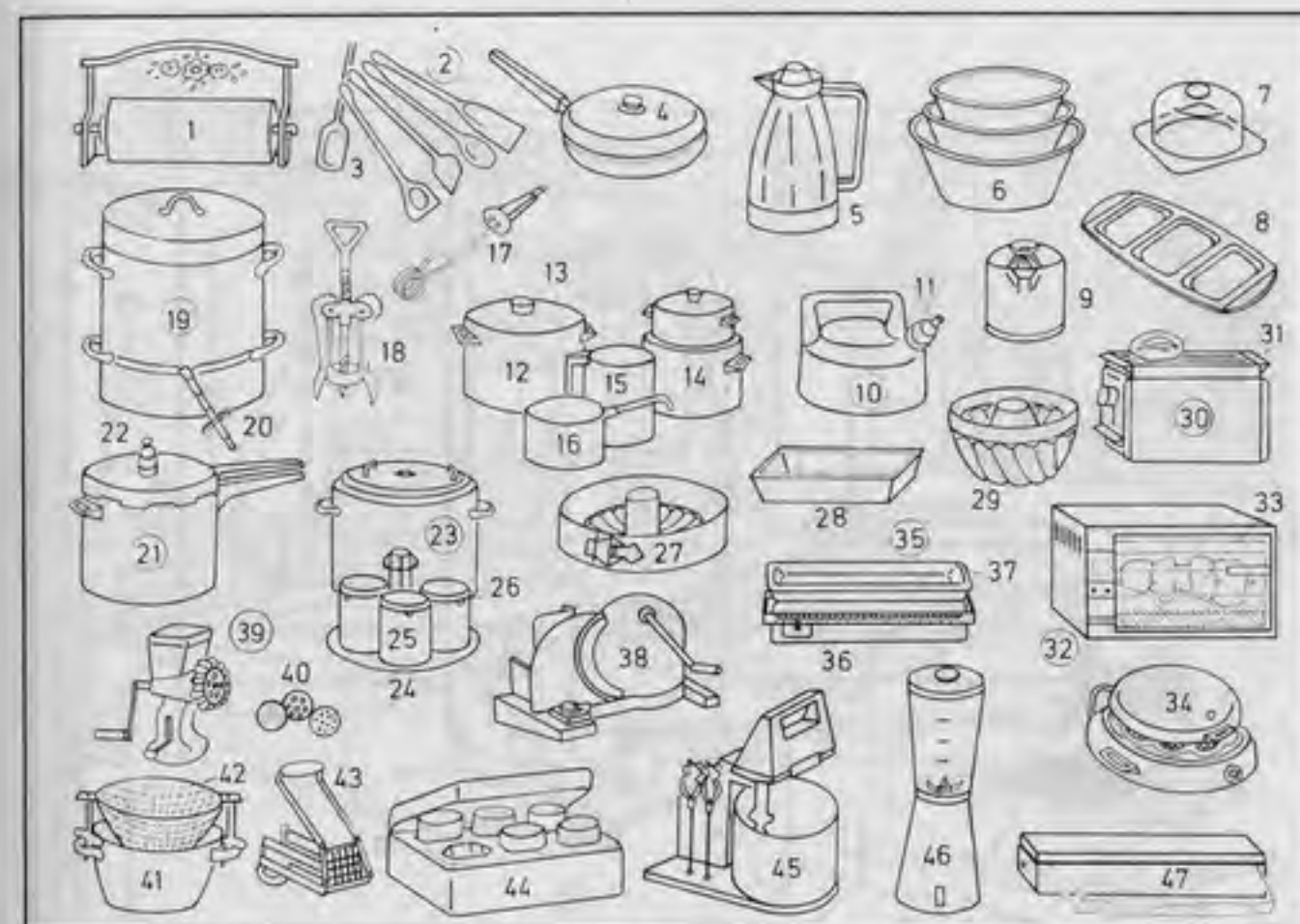

- |  |                                      |
|--|--------------------------------------|
| 1 general-purpose roll holder with kitchen roll (paper towels) | 27 spring form                       |
| 2 set of wooden spoons   | 28 cake tin                          |
| 3 mixing spoon   | 29 cake tin                          |
| 4 frying pan   | 30 toaster                           |
| 5 Thermos jug  | 31 rack for rolls                    |
| 6 set of bowls   | 32 rotisserie                        |
| 7 cheese dish with glass cover                                 | 33 spit                              |
| 8 three-compartment dish                                       | 34 electric waffle iron              |
| 9 lemon squeezer   | 35 sliding-weight scales             |
| 10 whistling kettle  | 36 sliding weight                    |
| 11 whistle   | 37 scale pan                         |
| 12-16 pan set  | 38 food slicer                       |
| 12 pot (cooking pot)   | 39 mincer ( <i>Am.</i> meat chopper) |
| 13 lid   | 40 blades                            |
| 14 casserole dish  | 41 chip pan                          |
| 15 milk pot  | 42 basket                            |
| 16 saucepan  | 43 potato chipper                    |
| 17 immersion heater  | 44 yoghurt maker                     |
| 18 corkscrew [with levers]                                     | 45 mixer                             |
| 19 juice extractor   | 46 blender                           |
| 20 tube clamp (tube clip)                                      | 47 bag sealer                        |
| 21 pressure cooker   |                                      |
| 22 pressure valve  |                                      |
| 23 fruit preserver   |                                      |
| 24 removable rack  |                                      |
| 25 preserving jar  |                                      |
| 26 rubber ring   |                                      |

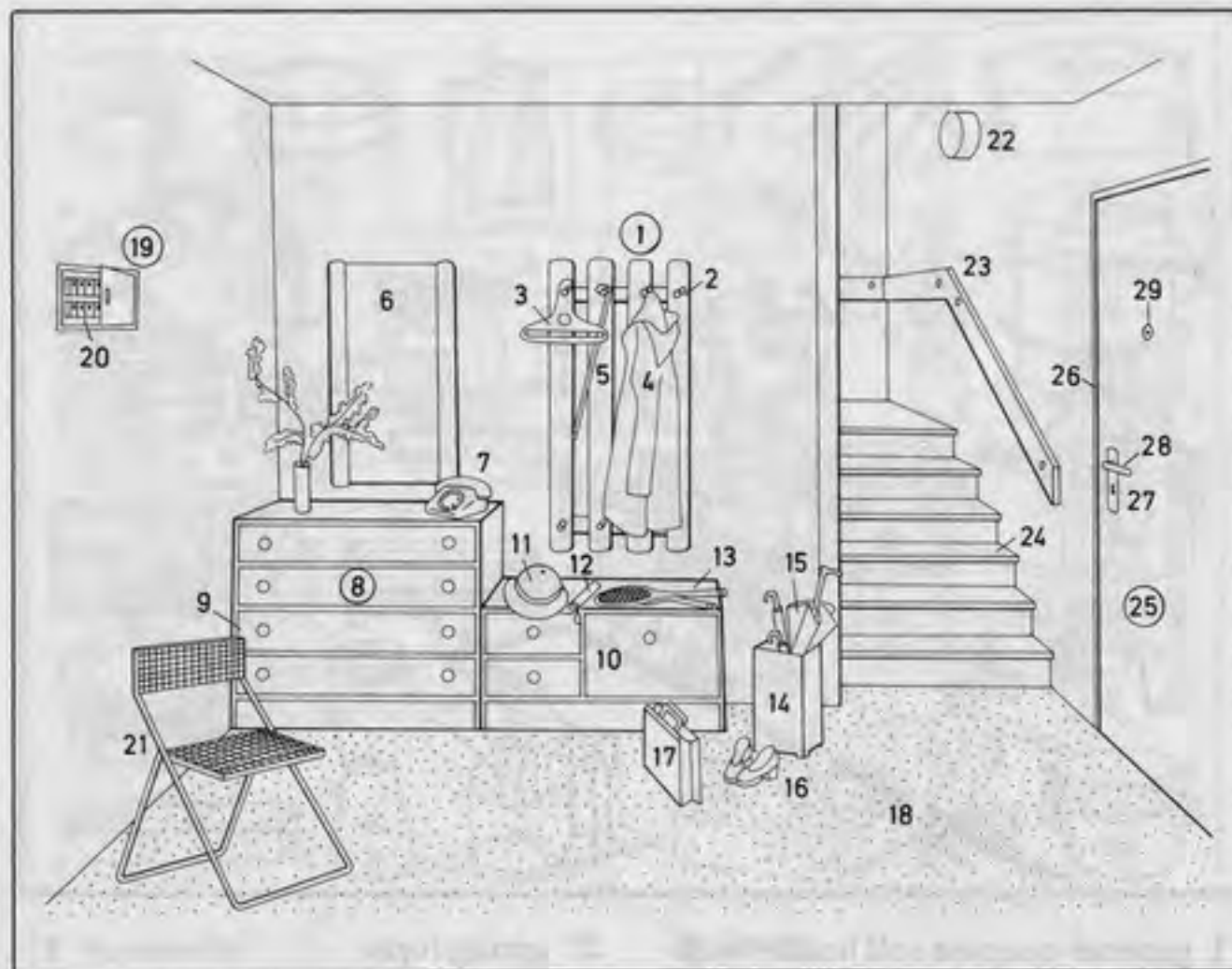

**1-29 hall (entrance hall)**

- 1 coat rack
- 2 coat hook
- 3 coat hanger
- 4 rain cape
- 5 walking stick
- 6 hall mirror
- 7 telephone
- 8 chest of drawers for shoes, etc.
- 9 drawer
- 10 seat
- 11 ladies' hat
- 12 telescopic umbrella
- 13 tennis rackets (tennis racquets)
- 14 umbrella stand
- 15 umbrella
- 16 shoes
- 17 briefcase
- 18 fitted carpet
- 19 fuse box
- 20 miniature circuit breaker
- 21 tubular steel chair
- 22 stair light
- 23 handrail
- 24 step

- 25 front door
- 26 door frame
- 27 door lock
- 28 door handle
- 29 spyhole



- 1 wall units
- 2 side wall
- 3 bookshelf
- 4 row of books
- 5 display cabinet unit
- 6 cupboard base unit
- 7 cupboard unit
- 8 television set (TV set)
- 9 stereo system (stereo equipment)
- 10 speaker (loudspeaker)
- 11 pipe rack
- 12 pipe
- 13 globe
- 14 brass kettle
- 15 telescope
- 16 mantle clock
- 17 bust
- 18 encyclopaedia [in several volumes]
- 19 room divider
- 20 drinks cupboard
- 21-26 upholstered suite (seating group)
- 21 armchair
- 22 arm

- 23 seat cushion (cushion)
- 24 settee
- 25 back cushion
- 26 [round] corner section
- 27 scatter cushion
- 28 coffee table
- 29 ashtray
- 30 tray
- 31 whisky (whiskey) bottle
- 32 soda water bottle (soda bottle)
- 33-34 dining set
- 33 dining table
- 34 chair
- 35 net curtain
- 36 indoor plants (houseplants)





- |  |                                   |
|--|-----------------------------------|
| 1 wardrobe ( <i>Am.</i> clothes closet)              | 20 picture                        |
| 2 linen shelf  | 21 picture frame                  |
| 3 cane chair   | 22 bedside rug                    |
| 4-13 <b>double bed</b> ( <i>sim.</i> : double divan) | 23 fitted carpet                  |
| 4-6 <b>bedstead</b>                                  | 24 dressing stool                 |
| 4 foot of the bed                                    | 25 dressing table                 |
| 5 bed frame  | 26 perfume spray                  |
| 6 headboard  | 27 perfume bottle                 |
| 7 bedspread  | 28 powder box                     |
| 8 duvet, a quilted duvet                             | 29 dressing-table mirror (mirror) |
| 9 sheet, a linen sheet                               |                                   |
| 10 mattress, a foam mattress with drill tick         |                                   |
| 11 [wedge-shaped] bolster                            |                                   |
| 12-13 pillow   |                                   |
| 12 pillowcase (pillowslip)                           |                                   |
| 13 tick  |                                   |
| 14 bookshelf [attached to the headboard]             |                                   |
| 15 reading lamp                                      |                                   |
| 16 electric alarm clock                              |                                   |
| 17 bedside cabinet                                   |                                   |
| 18 drawer  |                                   |
| 19 bedroom lamp                                      |                                   |

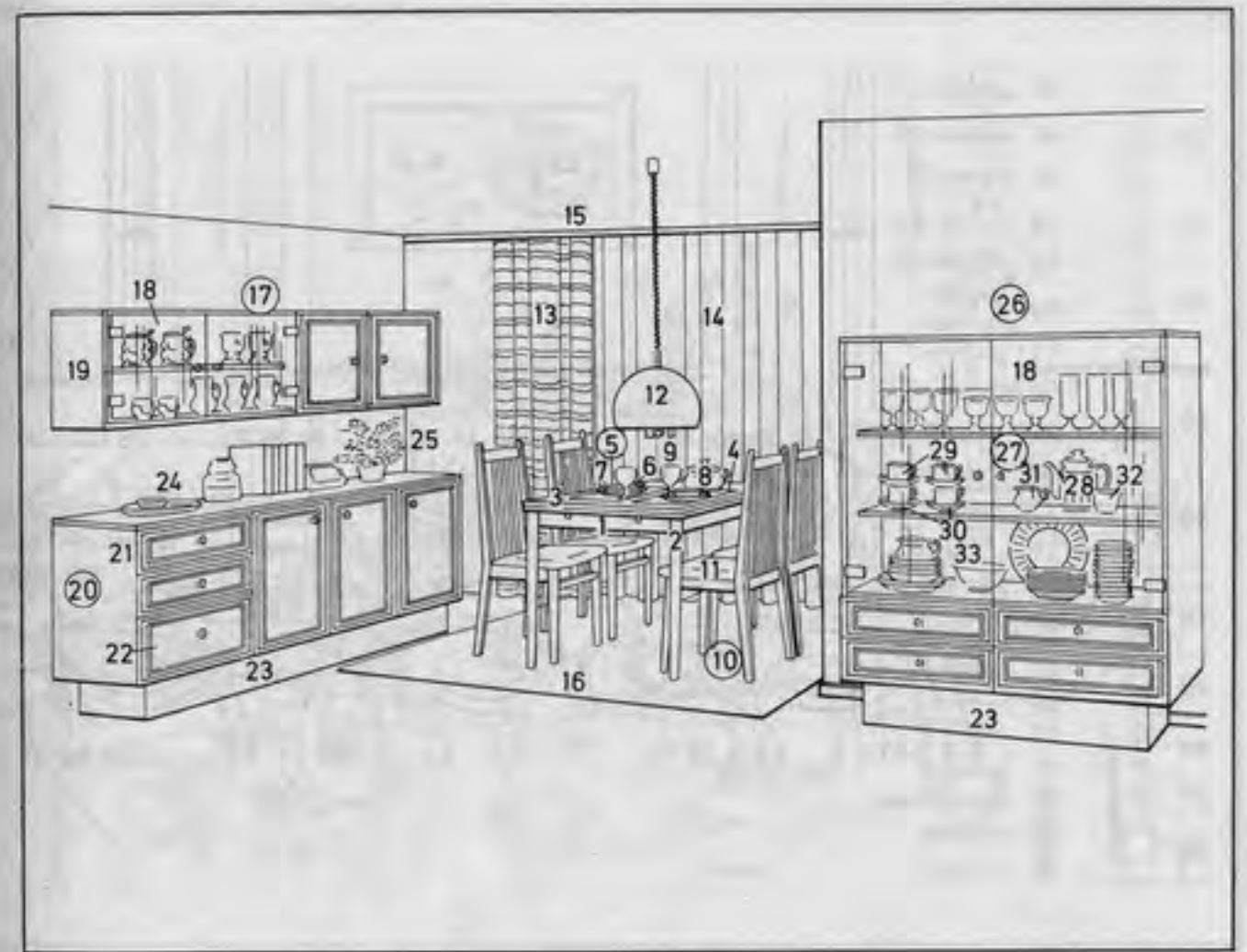

- |                                |                                    |
|--------------------------------|------------------------------------|
| <b>1-11 dining set</b>         | 25 pot plant                       |
| 1 dining table                 | 26 china cabinet (display cabinet) |
| 2 table leg                    | 27 coffee set (coffee service)     |
| 3 table top                    | 28 coffee pot                      |
| 4 place mat                    | 29 coffee cup                      |
| 5 place (place setting, cover) | 30 saucer                          |
| 6 soup plate (deep plate)      | 31 milk jug                        |
| 7 dinner plate                 | 32 sugar bowl                      |
| 8 soup tureen                  | 33 dinner set (dinner service)     |
| 9 wineglass                    |                                    |
| 10 dining chair                |                                    |
| 11 seat                        |                                    |
| 12 lamp (pendant lamp)         |                                    |
| 13 curtains                    |                                    |
| 14 net curtain                 |                                    |
| 15 curtain rail                |                                    |
| 16 carpet                      |                                    |
| 17 wall unit                   |                                    |
| 18 glass door                  |                                    |
| 19 shelf                       |                                    |
| 20 sideboard                   |                                    |
| 21 cutlery drawer              |                                    |
| 22 linen drawer                |                                    |
| 23 base                        |                                    |
| 24 round tray                  |                                    |



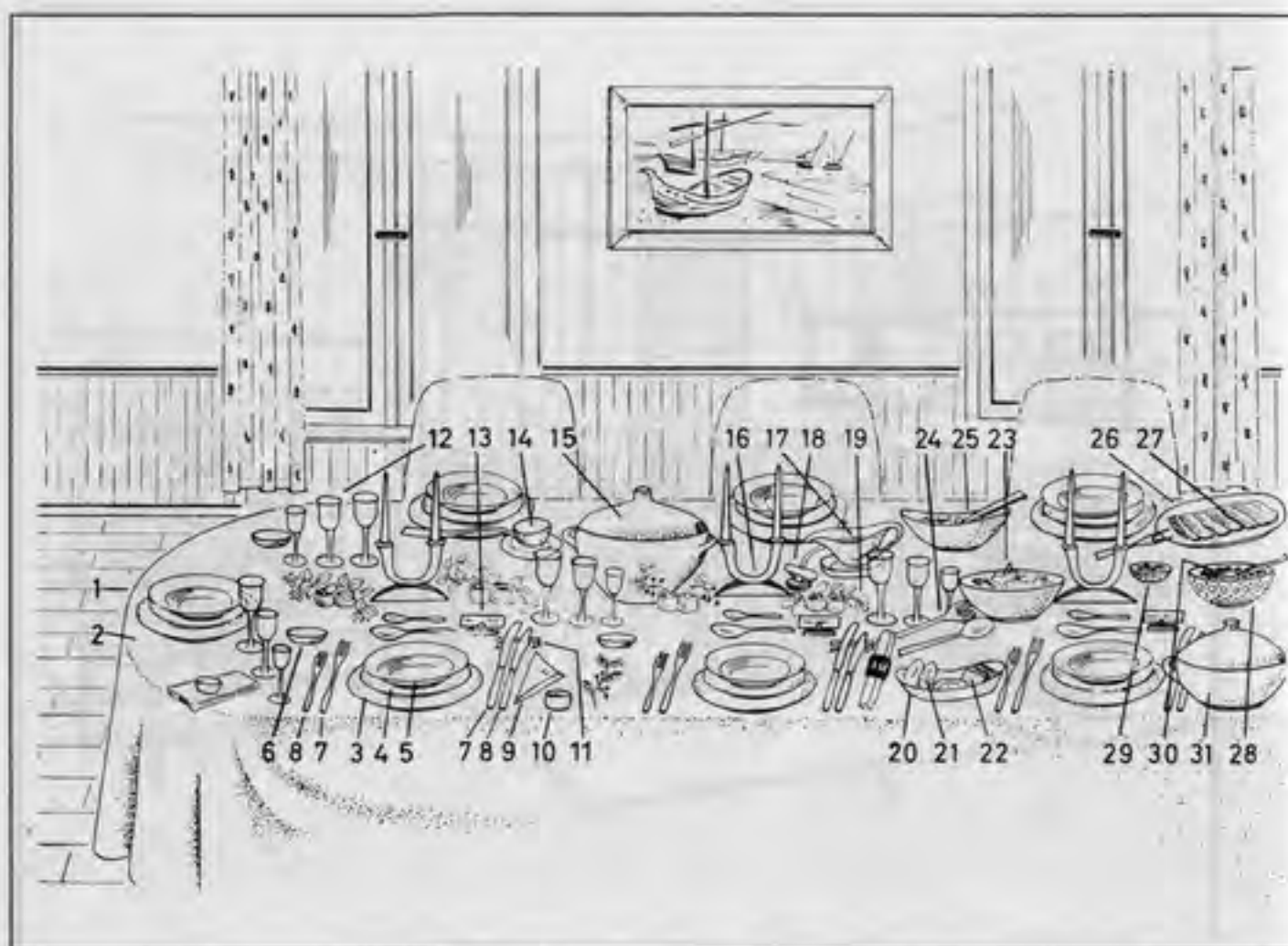

- |  |  |
|--|--|
| 1 dining table                           | 26 meat plate ( <i>Am.</i> meat platter)                         |
| 2 tablecloth, a damask cloth             | 27 roast meat (roast)  |
| 3-12 <b>place</b> (place setting, cover) | 28 fruit dish  |
| 3 bottom plate                           | 29 fruit bowl  |
| 4 dinner plate                           | 30 fruit (stewed fruit)  |
| 5 deep plate (soup plate)                | 31 potato dish   |
| 6 dessert plate (dessert bowl)           | 32 serving trolley   |
| 7 knife and fork                         | 33 vegetable plate ( <i>Am.</i> vegetable platter)               |
| 8 fish knife and fork                    | 34 toast   |
| 9 serviette (napkin, table napkin)       | 35 cheeseboard   |
| 10 serviette ring (napkin ring)          | 36 butter dish   |
| 11 knife rest                            | 37 open sandwich   |
| 12 wineglasses                           | 38 filling   |
| 13 place card                            | 39 sandwich  |
| 14 soup ladle                            | 40 fruit bowl  |
| 15 soup tureen (tureen)                  | 41 almonds ( <i>also</i> : potato crisps, peanuts)               |
| 16 candelabra                            | 42 oil and vinegar bottle  |
| 17 sauceboat (gravy boat)                | 43 ketchup (catchup, catsup)                                     |
| 18 sauce ladle (gravy ladle)             | 44 sideboard   |
| 19 table decoration                      | 45 electric hotplate   |
| 20 bread basket                          | 46 corkscrew   |
| 21 roll                                  | 47 crown cork bottle-opener (crown cork opener), a bottle-opener |
| 22 slice of bread                        |  |
| 23 salad bowl                            |  |
| 24 salad servers                         |  |
| 25 vegetable dish                        |  |

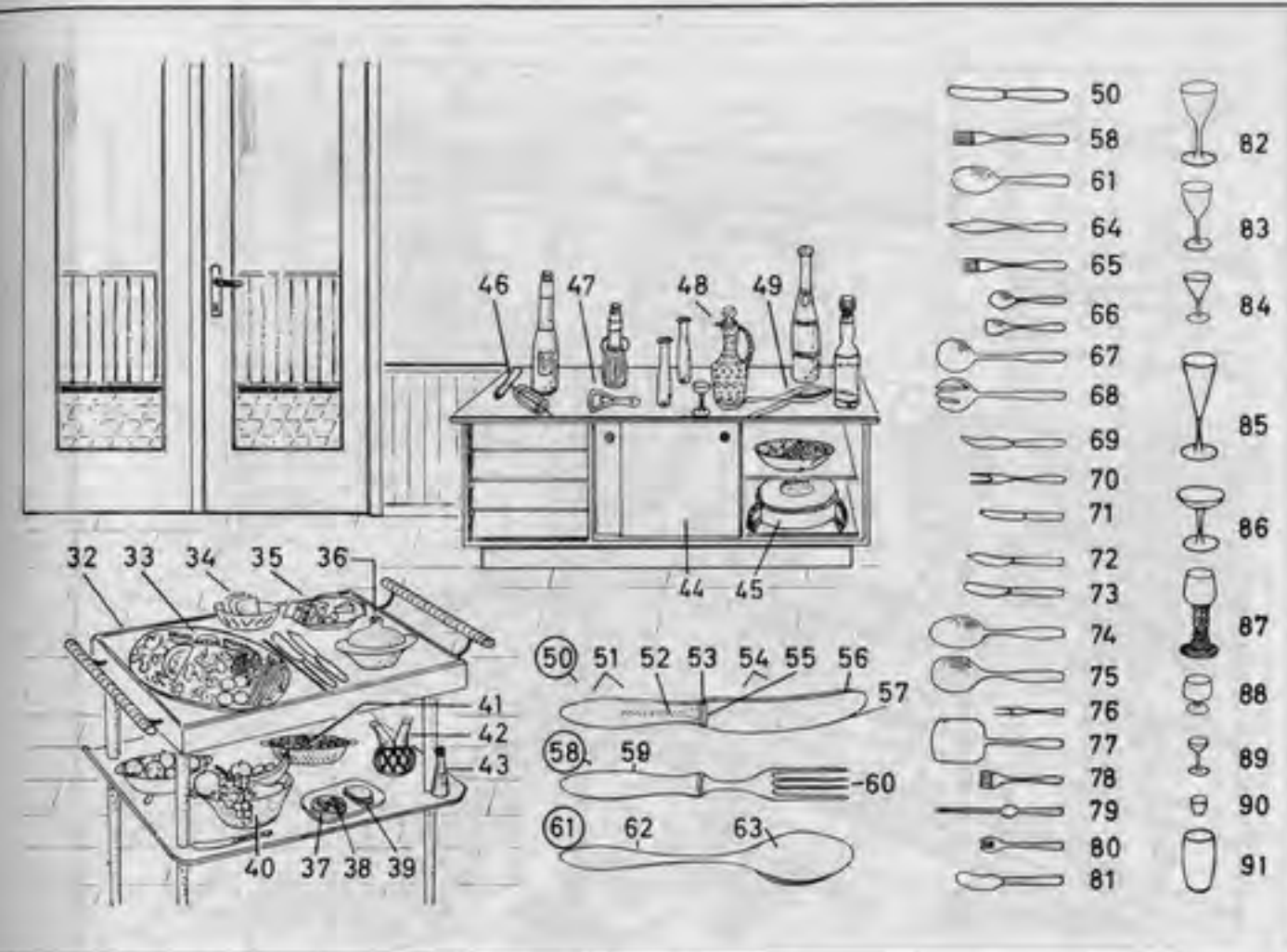

- |                                       |   |
|---------------------------------------|---|
| 48 liqueur decanter                   | 73 butter knife                               |
| 49 nutcrackers (nutcracker)           | 74 vegetable spoon, a serving spoon           |
| 50 knife                              | 75 potato server (serving spoon for potatoes) |
| 51 handle                             | 76 cocktail fork                              |
| 52 tang (tongue)                      | 77 asparagus server (asparagus slice)         |
| 53 ferrule                            | 78 sardine server                             |
| 54 blade                              | 79 lobster fork                               |
| 55 bolster                            | 80 oyster fork                                |
| 56 back                               | 81 caviare knife                              |
| 57 edge (cutting edge)                | 82 white wine glass                           |
| 58 fork                               | 83 red wine glass                             |
| 59 handle                             | 84 sherry glass (madeira glass)               |
| 60 prong (tang, tine)                 | 85-86 champagne glasses                       |
| 61 spoon; <i>here</i> : dessert spoon | 85 tapered glass                              |
| 62 handle                             | 86 champagne glass, a crystal glass           |
| 63 bowl                               | 87 rummer                                     |
| 64 fish knife                         | 88 brandy glass                               |
| 65 fish fork                          | 89 liqueur glass                              |
| 66 dessert spoon (fruit spoon)        | 90 spirit glass                               |
| 67 salad spoon                        | 91 beer glass                                 |
| 68 salad fork                         |   |
| 69-70 carving set (serving cutlery)   |   |
| 69 carving knife                      |   |
| 70 serving fork                       |   |
| 71 fruit knife                        |   |
| 72 cheese knife                       |   |



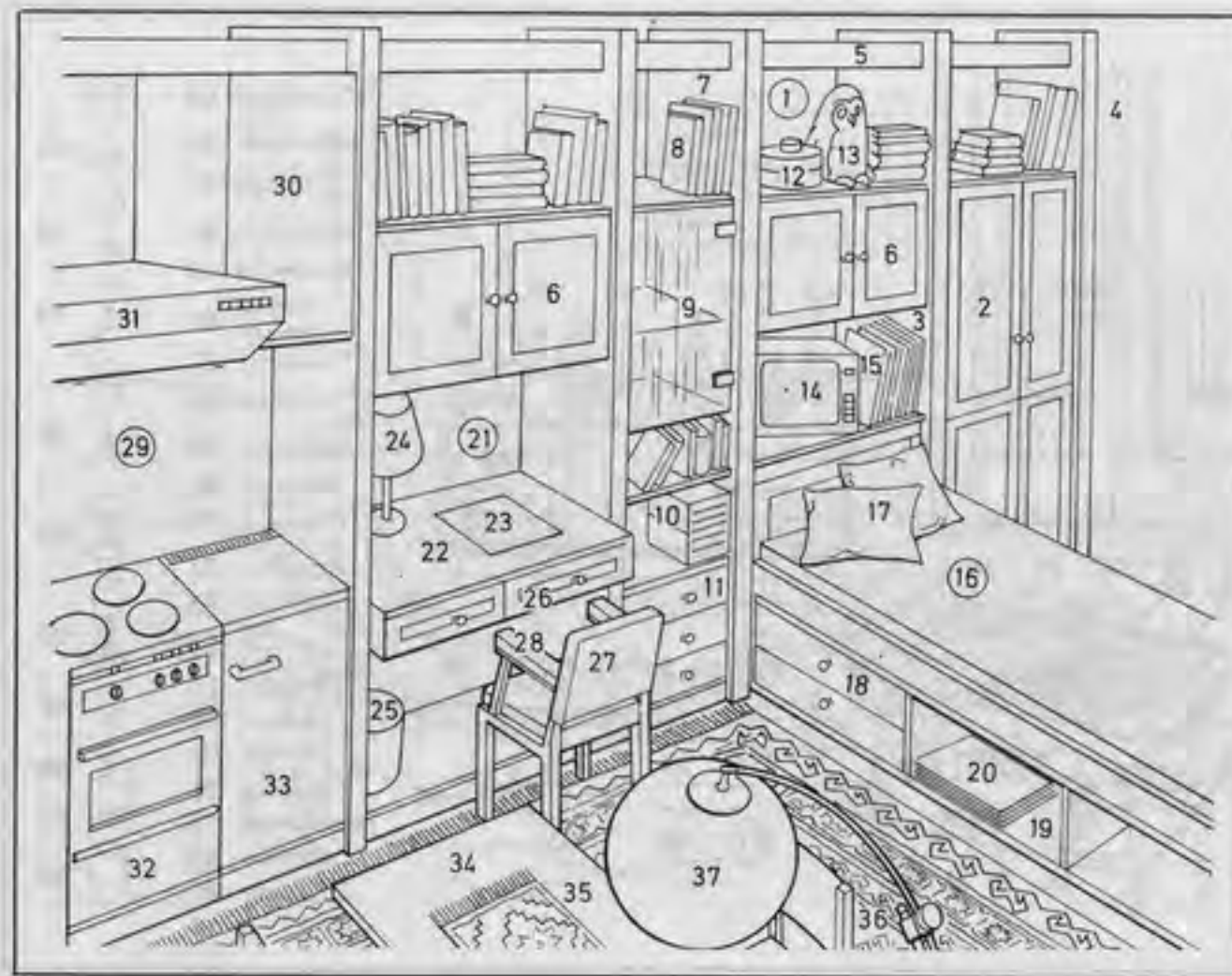

- |  |   |
|--|---|
| 1 wall units (shelf units)                         | 24 table lamp                                 |
| 2 wardrobe door ( <i>Am.</i> clothes closet door)  | 25 wastepaper basket                          |
| 3 body   | 26 desk drawer                                |
| 4 side wall  | 27 desk chair                                 |
| 5 trim   | 28 arm  |
| 6 two-door cupboard unit                           | 29 kitchen unit                               |
| 7 bookshelf unit (bookcase unit) [with glass door] | 30 wall cupboard                              |
| 8 books  | 31 cooker hood                                |
| 9 display cabinet                                  | 32 electric cooker                            |
| 10 card index boxes                                | 33 refrigerator ( <i>fridge, Am. icebox</i> ) |
| 11 drawer  | 34 dining table                               |
| 12 decorative biscuit tin                          | 35 table runner                               |
| 13 soft toy animal                                 | 36 oriental carpet                            |
| 14 television set (TV set)                         | 37 standard lamp                              |
| 15 records (discs)                                 |   |
| 16 bed unit  |   |
| 17 scatter cushion                                 |   |
| 18 bed unit drawer                                 |   |
| 19 bed unit shelf                                  |   |
| 20 magazines                                       |   |
| 21 desk unit (writing unit)                        |   |
| 22 desk  |   |
| 23 desk mat (blotter)                              |   |



- |  |  |
|--|--|
| 1 children's bed, a bunk-bed             | 25 school books  |
| 2 storage box                            | 26 pencil ( <i>also: crayon, felt tip pen, ballpoint pen</i> ) |
| 3 mattress                               | 27 toy shop  |
| 4 pillow                                 | 28 counter   |
| 5 ladder                                 | 29 spice rack  |
| 6 soft toy elephant, a cuddly toy animal | 30 display   |
| 7 soft toy dog                           | 31 assortment of sweets ( <i>Am. candies</i> )                 |
| 8 cushion                                | 32 bag of sweets ( <i>Am. candies</i> )                        |
| 9 fashion doll                           | 33 scales  |
| 10 doll's pram                           | 34 cash register   |
| 11 sleeping doll                         | 35 toy telephone   |
| 12 canopy                                | 36 shop shelves (goods shelves)                                |
| 13 blackboard                            | 37 wooden train set  |
| 14 counting beads                        | 38 dump truck, a toy lorry (toy truck)                         |
| 15 toy horse for rocking and pulling     | 39 tower crane   |
| 16 rockers                               | 40 concrete mixer  |
| 17 children's book                       | 41 large soft toy dog  |
| 18 compendium of games                   | 42 dice cup  |
| 19 ludo                                  |  |
| 20 chessboard                            |  |
| 21 children's cupboard                   |  |
| 22 linen drawer                          |  |
| 23 drop-flap writing surface             |  |
| 24 notebook (exercise book)              |  |



**1-20 pre-school education**

(nursery education)

- 1 nursery teacher
- 2 nursery child
- 3 handicraft
- 4 glue
- 5 watercolour (*Am.* watercolor) painting
- 6 paintbox
- 7 paintbrush
- 8 glass of water
- 9 jigsaw puzzle (puzzle)
- 10 jigsaw puzzle piece
- 11 coloured (*Am.* colored) pencils (wax crayons)
- 12 modelling (*Am.* modeling) clay (plasticine)
- 13 clay figures (plasticine figures)
- 14 modelling (*Am.* modeling) board
- 15 chalk (blackboard chalk)
- 16 blackboard
- 17 counting blocks
- 18 felt pen (felt tip pen)
- 19 shapes game
- 20 group of players

**21-32 toys**

- 21 building and filling cupes
- 22 construction set

- 23 children's books
- 24 doll's pram, a wicker pram
- 25 baby doll
- 26 canopy
- 27 building bricks (building blocks)
- 28 wooden model building
- 29 wooden train set
- 30 rocking teddy bear
- 31 doll's pushchair
- 32 fashion doll
- 33 child of nursery school age
- 34 cloakroom

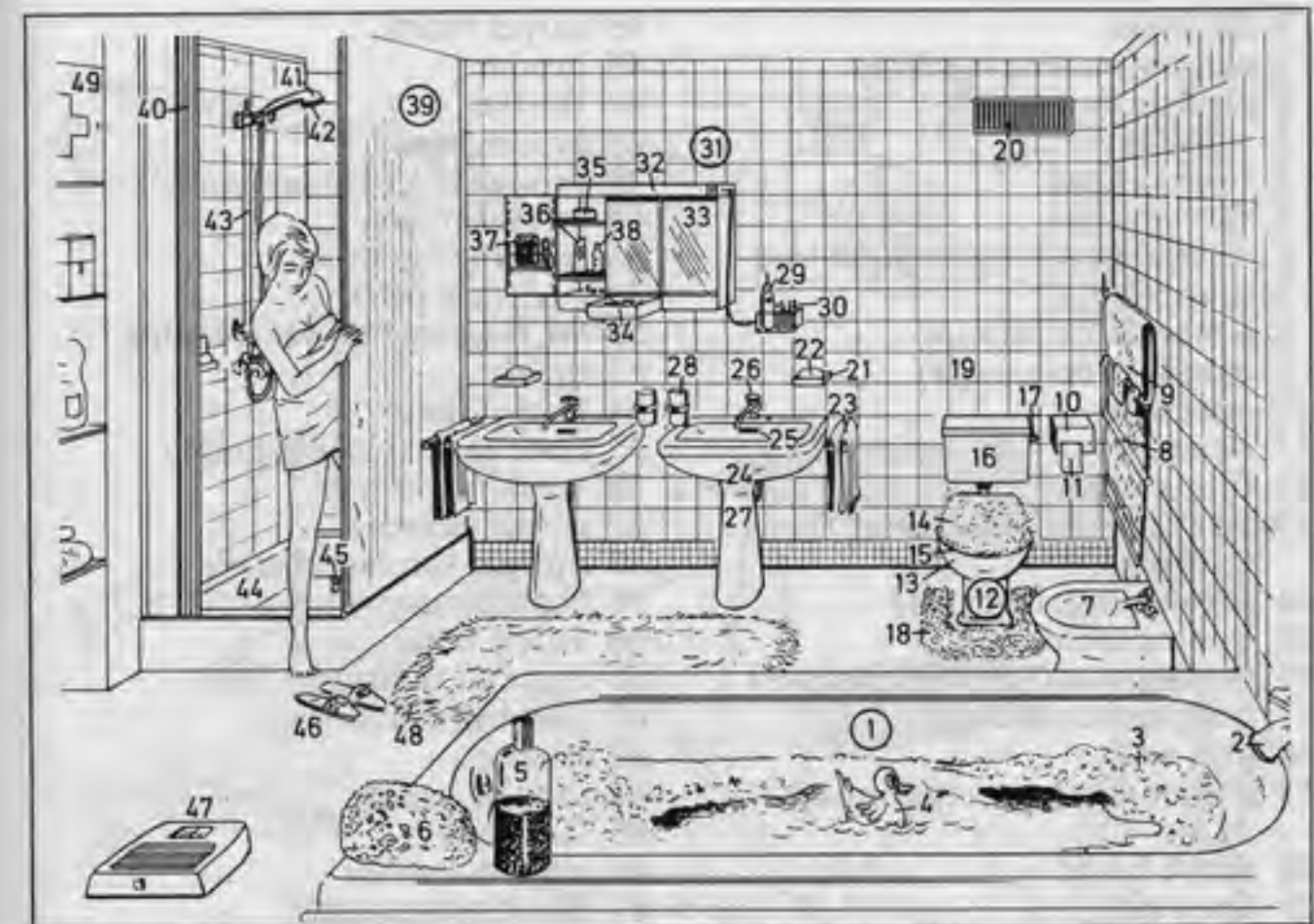

- 1 bath
- 2 mixer tap (*Am.* mixing faucet) for hot and cold water
- 3 foam bath (bubble bath)
- 4 toy duck
- 5 bath salts
- 6 bath sponge (sponge)
- 7 bidet
- 8 towel rail
- 9 terry towel
- 10 toilet roll holder (*Am.* bathroom tissue holder)
- 11 toilet paper (*coll.* loo paper, *Am.* bathroom tissue), a roll of crepe paper
- 12 toilet (lavatory, W.C., *coll.* loo)
- 13 toilet pan (toilet bowl)
- 14 toilet lid with terry cover
- 15 toilet seat
- 16 cistern
- 17 flushing lever
- 18 pedestal mat
- 19 tile
- 20 ventilator (extraction vent)
- 21 soap dish
- 22 soap
- 23 hand towel
- 24 washbasin
- 25 overflow
- 26 hot and cold water tap
- 27 washbasin pedestal with trap (anti-syphon trap)
- 28 tooth glass (tooth mug)
- 29 electric toothbrush
- 30 detachable brush heads
- 31 mirrored bathroom cabinet
- 32 fluorescent lamp
- 33 mirror
- 34 drawer
- 35 powder box
- 36 mouthwash
- 37 electric shaver
- 38 aftershave lotion
- 39 shower cubicle
- 40 shower curtain
- 41 adjustable shower head
- 42 shower nozzle
- 43 shower adjustment rail
- 44 shower base
- 45 waste pipe (overflow)
- 46 bathroom mat
- 47 bathroom scales
- 48 bath mat
- 49 medicine cabinet



- 1-20 irons  
 1 electric ironing machine  
 2 electric foot switch  
 3 roller covering  
 4 ironing head  
 5 sheet  
 6 electric iron, a lightweight iron  
 7 sole-plate  
 8 temperature selector  
 9 handle (iron handle)  
 10 pilot light  
 11 steam, spray, and dry iron  
 12 filling inlet  
 13 spray nozzle for damping the washing  
 14 steam hole (steam slit)  
 15 ironing table  
 16 ironing board (ironing surface)  
 17 ironing-board cover  
 18 iron well  
 19 aluminium (*Am.* aluminum) frame  
 20 sleeve board  
 21 linen bin  
 22 dirty linen  
 23-34 washing machines and driers  
 23 washing machine (automatic washing machine)  
 24 washing drum  
 25 safety latch (safety catch)  
 26 program selector control  
 27 front soap dispenser [with several compartments]  
 28 tumble drier  
 29 drum  
 30 front door with ventilation slits  
 31 work top  
 32 ailer  
 33 clothes line (washing line)  
 34 extending ailer  
 35 stepladder (steps), an aluminium (*Am.* aluminum) ladder  
 36 stile  
 37 prop  
 38 tread (rung)  
 39-43 shoe care utensils  
 39 tin of shoe polish  
 40 shoe spray, an impregnating spray  
 41 shoe brush  
 42 brush for applying polish  
 43 tube of shoe polish  
 44 clothes brush  
 45 carpet brush  
 46 broom  
 47 bristles  
 48 broom head  
 49 broomstick (broom handle)  
 50 screw thread  
 51 washing-up brush  
 52 pan (dust pan)  
 53-86 floor and carpet cleaning  
 53 brush  
 54 bucket (pail)  
 55 floor cloth (cleaning rag)  
 56 scrubbing brush  
 57 carpet sweeper  
 58 upright vacuum cleaner  
 59 changeover switch  
 60 swivel head  
 61 bag-full indicator  
 62 dust bag container  
 63 handle  
 64 tubular handle  
 65 flex hook  
 66 wound-up flex  
 67 all-purpose nozzle  
 68 cylinder vacuum cleaner  
 69 swivel coupling  
 70 extension tube  
 71 floor nozzle (*sim.*: carpet beater nozzle)  
 72 suction control  
 73 bag-full indicator  
 74 sliding fingertip suction control  
 75 hose (suction hose)  
 76 combined carpet sweeper and shampooer  
 77 electric lead (flex)  
 78 plug socket  
 79 carpet beater head (*sim.*: shampooing head, brush head)  
 80 all-purpose vacuum cleaner (dry and wet operation)  
 81 castor  
 82 motor unit  
 83 lid clip  
 84 coarse dirt hose  
 85 special accessory (special attachment) for coarse dirt  
 86 dust container  
 87 shopper (shopping trolley)

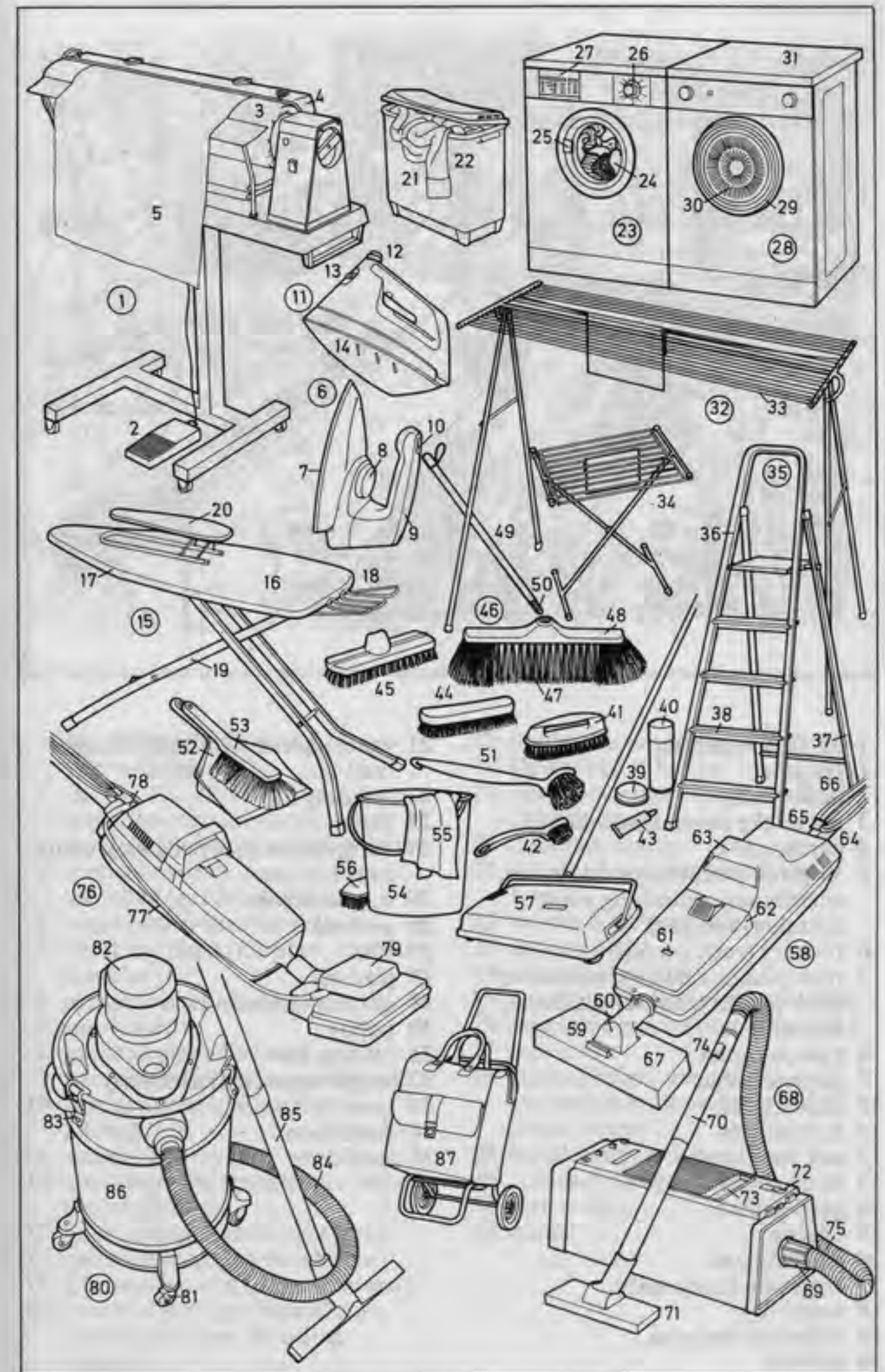



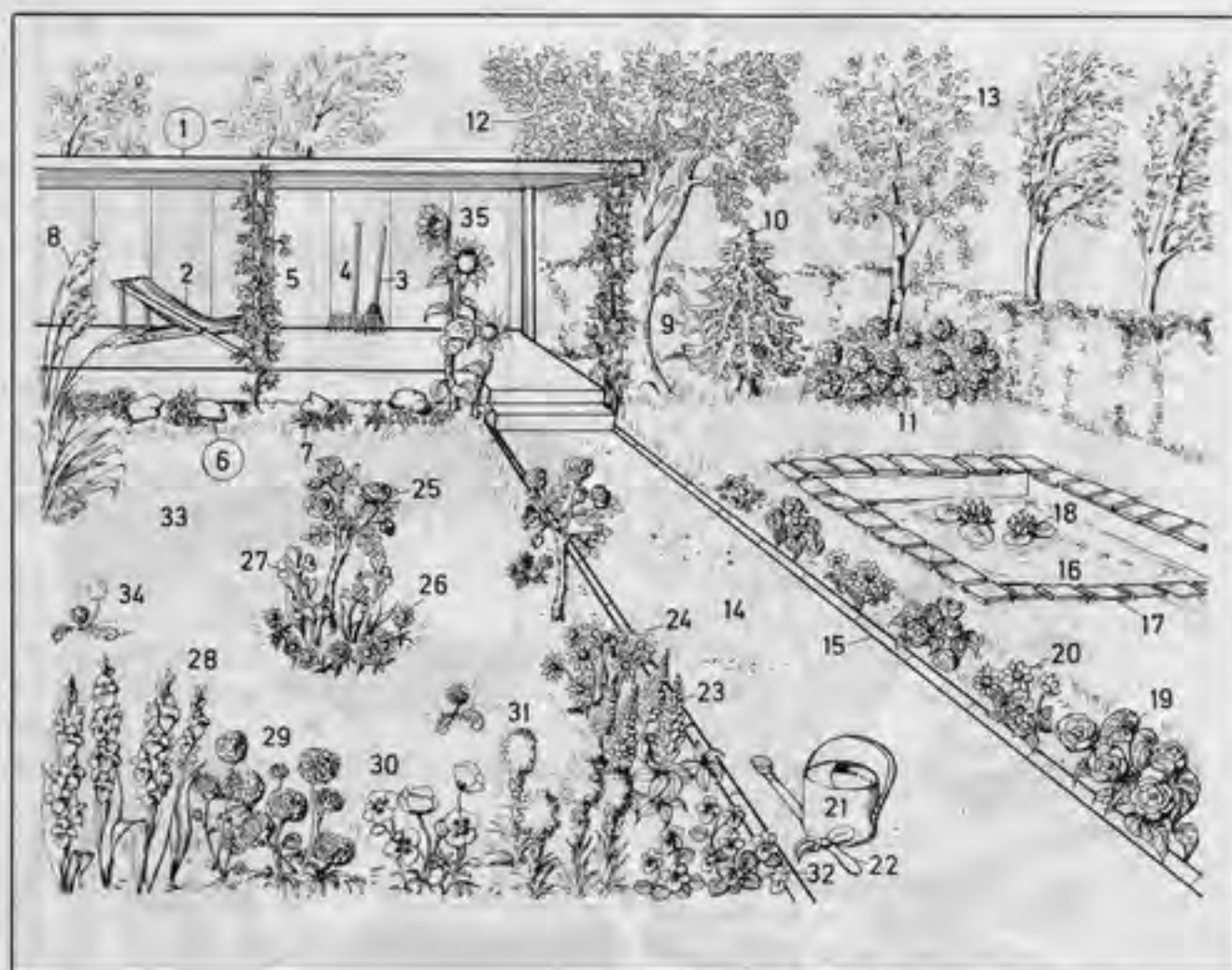

## 1-35 flower garden

- |   |   |
|---|---|
| 1 pergola   | 21 watering can ( <i>Am.</i> sprinkling can)        |
| 2 deck-chair  | 22 weeding hoe                                      |
| 3 lawn rake (wire-tooth rake)   | 23 lupin  |
| 4 garden rake   | 24 marguerites (oxeye daisies, white oxeye daisies) |
| 5 Virginia creeper (American ivy, woodbine), a climbing plant (climber, creeper)      | 25 standard rose                                    |
| 6 rockery (rock garden)   | 26 gerbera  |
| 7 rock plants; <i>varieties</i> : stonecrop (wall pepper), houseleek, dryas, aubretia | 27 iris   |
| 8 pampas grass  | 28 gladioli   |
| 9 garden hedge  | 29 chrysanthemums                                   |
| 10 blue spruce  | 30 poppy  |
| 11 hydrangeas   | 31 blazing star                                     |
| 12 oak (oak tree)   | 32 snapdragon ( <i>antirrhinum</i> )                |
| 13 birch (birch tree)   |   |
| 14 garden path  |   |
| 15 edging   |   |
| 16 garden pond  |   |
| 17 flagstone (stone slab)   |   |
| 18 water lily   |   |
| 19 tuberous begonias  |   |
| 20 dahlias  |   |

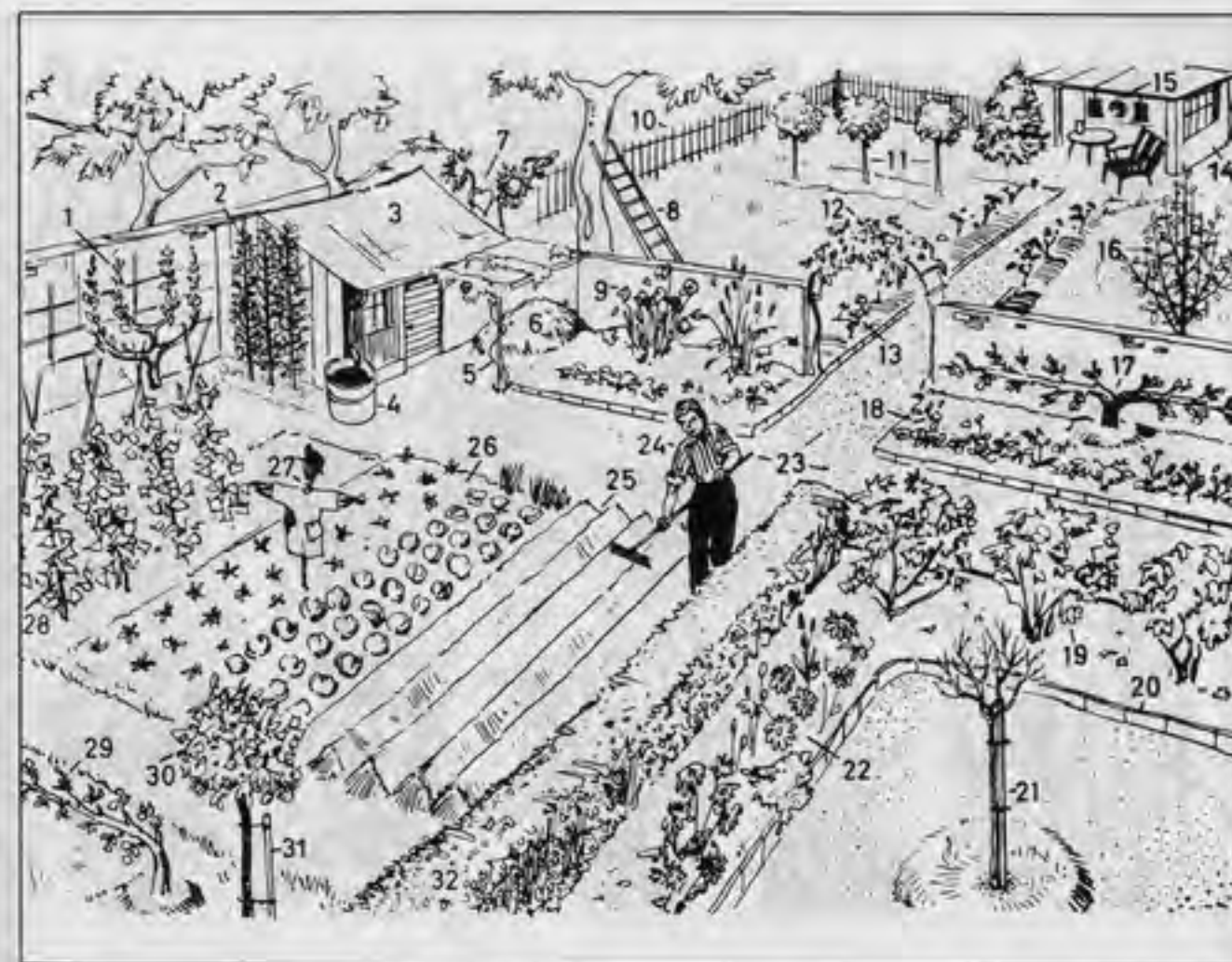

## 1-32 allotment (fruit and vegetable garden)

- |  |   |
|--|---|
| 1, 2, 16, 17, 29 dwarf fruit trees (espaliers, espalier fruit trees) | 17 double horizontal cordon   |
| 1 quadruple cordon, a wall espalier                                  | 18 flower bed, a border   |
| 2 vertical cordon  | 19 berry bush (gooseberry bush, currant bush)                                   |
| 3 tool shed (garden shed)  | 20 concrete edging  |
| 4 water butt (water barrel)  | 21 standard rose (standard rose tree)   |
| 5 climbing plant (climber, creeper, rambler)                         | 22 border with perennials   |
| 6 compost heap   | 23 garden path  |
| 7 sunflower  | 24 allotment holder   |
| 8 garden ladder (ladder)   | 25 asparagus patch (asparagus bed)  |
| 9 perennial (flowering perennial)                                    | 26 vegetable patch (vegetable plot)   |
| 10 garden fence (paling fence, paling)                               | 27 scarecrow  |
| 11 standard berry tree   | 28 runner bean ( <i>Am.</i> scarlet runner), a bean plant on poles (bean poles) |
| 12 climbing rose (rambling rose) on the trellis arch                 | 29 horizontal cordon  |
| 13 bush rose (standard rose tree)                                    | 30 standard fruit tree  |
| 14 summerhouse (garden house)  | 31 tree stake   |
| 15 Chinese lantern (paper lantern)                                   | 32 hedge  |
| 16 pyramid tree (pyramidal tree, pyramid), a free-standing espalier  |   |



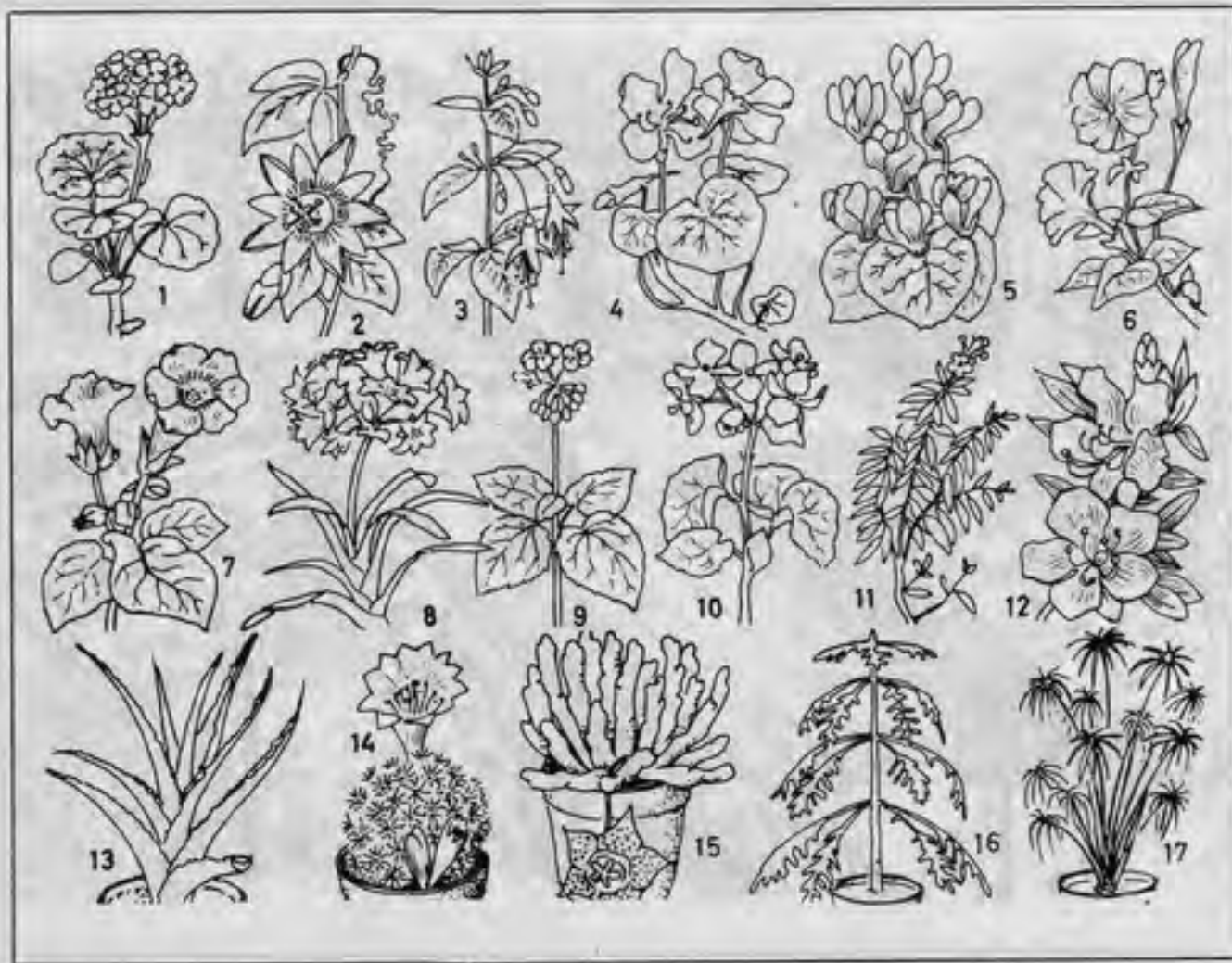

- 1 pelargonium (crane's bill), a geranium
- 2 passion flower (*Passiflora*), a climbing plant (climber, creeper)
- 3 fuchsia, an anagraceous plant
- 4 nasturtium (*Indian cress*, *tropaeolum*)
- 5 cyclamen, a primulaceous herb
- 6 petunia, a solanaceous herb
- 7 gloxinia (*Sinningia*), a gesneriaceous plant
- 8 *Clivia minata*, an amaryllis (narcissus)
- 9 African hemp (*Sparmannia*), a tiliaceous plant, a linden plant
- 10 begonia
- 11 myrtle (common myrtle, *Myrtus*)
- 12 azalea, an ericaceous plant
- 13 aloe, a liliaceous plant
- 14 globe thistle (*Echinops*)
- 15 stapelia (carrion flower), an asclepiadaceous plant
- 16 Norfolk Island Pine (an *araucaria*, grown as an ornamental)
- 17 galingale, a cyperaceous plant of the sedge family

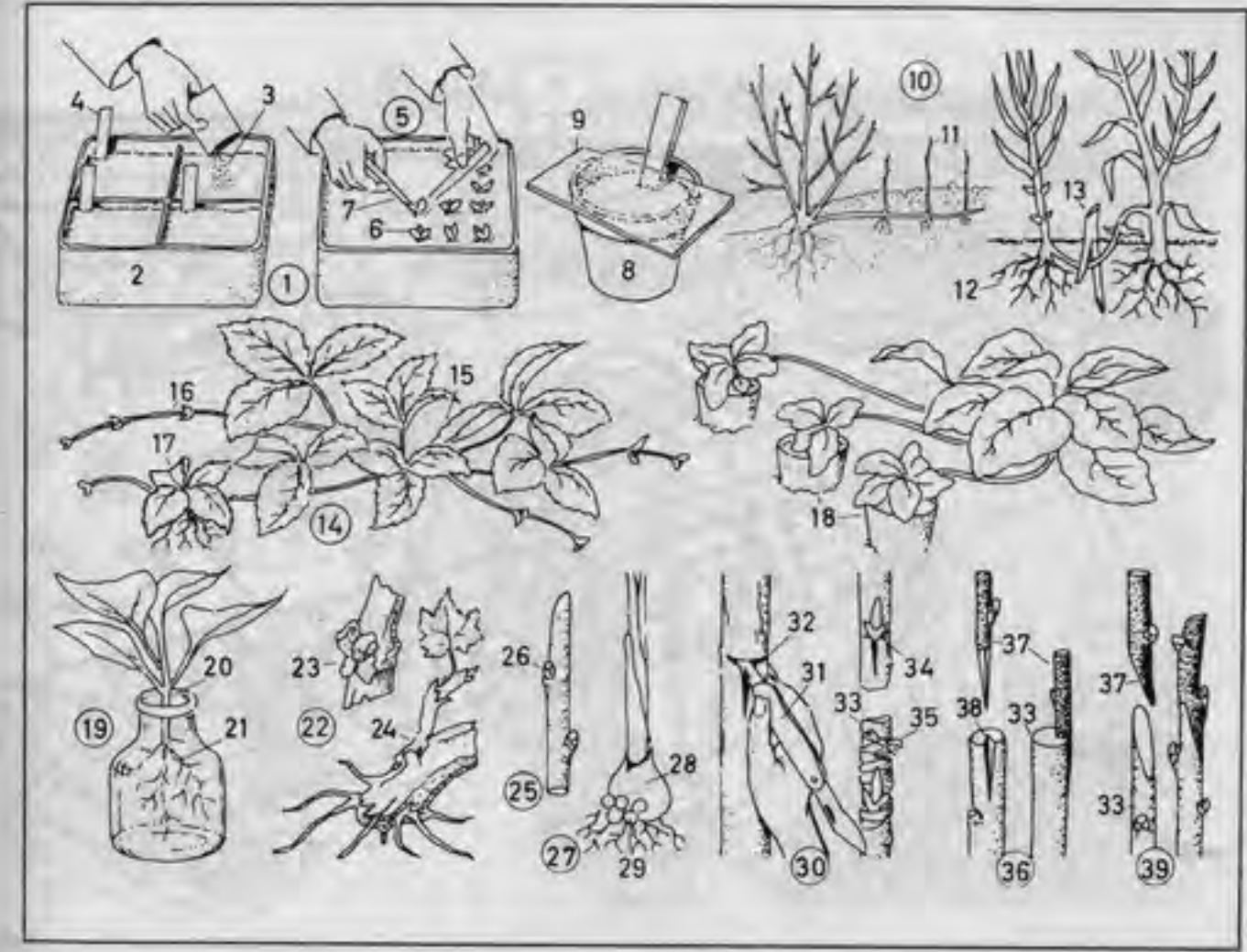

- 1 seed sowing (sowing)
- 2 seed pan
- 3 seed
- 4 label
- 5 pricking out (pricking off, transplanting)
- 6 seedling (seedling plant)
- 7 dibber (dibble)
- 8 flower pot (pot)
- 9 sheet of glass
- 10 propagation by layering
- 11 layer
- 12 layer with roots
- 13 forked stick used for fastening
- 14 propagation by runners
- 15 parent (parent plant)
- 16 runner
- 17 small rooted leaf cluster
- 18 setting in pots
- 19 cutting in water
- 20 cutting (slip, set)
- 21 root
- 22 bud cutting on vine tendril
- 23 scion bud, a bud
- 24 sprouting (shooting) cutting
- 25 stem cutting (hardwood cutting)
- 26 bud
- 27 propagation by bulbils (brood bud bulblets)
- 28 old bulb
- 29 bulbil (brood bud bulblet)
- 30-39 grafting (graftage)
- 30 budding (shield budding)
- 31 budding knife
- 32 T-cut
- 33 support (stock, rootstock)
- 34 inserted scion bud
- 35 raffia layer (bast layer)
- 36 side grafting
- 37 scion (shoot)
- 38 wedge-shaped notch
- 39 splice graft (splice grafting)



**1-51 market garden** (*Am. truck garden, truck farm*)

- |   |  |
|---|--|
| 1 tool shed   | 15 heap of earth (composted earth, prepared earth, garden mould, <i>Am. mold</i> ) |
| 2 water tower (water tank)  | 16 hotbed (forcing bed, heated frame)  |
| 3 market garden ( <i>Am. truck garden, truck farm</i> ), a tree nursery | 17 hotbed vent (frame vent)  |
| 4 hothouse (forcing house, warm house)                                  | 18 vent prop   |
| 5 glass roof  | 19 sprinkler (sprinkling device)   |
| 6 matting, e.g. straw matting, reed matting                             | 20 gardener (nursery gardener, grower, commercial grower)                          |
| 7 boiler room (boiler house)  | 21 cultivator (hand cultivator, grubber)   |
| 8 heating pipe (pressure pipe)  | 22 plank   |
| 9 shading panel (shutter)   | 23 pricked-out seedlings (pricked-off seedlings)                                   |
| 10-11 ventilators (vents)   | 24 forced flowers [forcing]  |
| 10 ventilation window (window vent, hinged ventilator)                  | 25 potted plants (plants in pots, pot plants)                                      |
| 11 ridge vent   | 26 watering can ( <i>Am. sprinkling can</i> )                                      |
| 12 potting table (potting bench)  | 27 handle  |
| 13 riddle (sieve, garden sieve, upright sieve)                          | 28 rose  |
| 14 garden shovel (shovel)   | 29 water tank  |



- |  |                 |
|--|-----------------|
| 30 water pipe  | 49 orange tree  |
| 31 bale of peat  | 50 wire basket  |
| 32 warm house (heated greenhouse)                          | 51 seedling box |
| 33 cold house (unheated greenhouse)                        |                 |
| 34 wind pump; <i>sim.</i> : wind generator (aerogenerator) |                 |
| 35 wind wheel  |                 |
| 36 wind vane   |                 |
| 37 shrub bed, a flower bed                                 |                 |
| 38 hoop edging   |                 |
| 39 vegetable plot  |                 |
| 40 plastic tunnel (polythene greenhouse)                   |                 |
| 41 ventilation flap  |                 |
| 42 central path  |                 |
| 43 vegetable crate   |                 |
| 44 tomato plant  |                 |
| 45 nursery hand  |                 |
| 46 nursery hand  |                 |
| 47 tub plant   |                 |
| 48 tub   |                 |



- 1 dibber (dibble)
- 2 spade
- 3 lawn rake (wire-tooth rake)
- 4 rake
- 5 ridging hoe
- 6 trowel
- 7 combined hoe and fork
- 8 sickle
- 9 gardener's knife (pruning knife, billhook)
- 10 asparagus cutter (asparagus knife)
- 11 tree pruner (long-handled pruner)
- 12 semi-automatic spade
- 13 three-pronged cultivator
- 14 tree scraper (bark scraper)
- 15 lawn aerator (aerator)
- 16 pruning saw (saw for cutting branches)
- 17 battery-operated hedge trimmer
- 18 motor cultivator
- 19 electric drill
- 20 gear
- 21 cultivator attachment
- 22 fruit picker
- 23 tree brush (bark brush)
- 24 sprayer for pest control
- 25 lance
- 26 hose reel (reel and carrying cart)
- 27 garden hose
- 28 motor lawn mower (motor mower)
- 29 grassbox
- 30 two-stroke motor
- 31 electric lawn mower (electric mower)
- 32 electric lead (electric cable)
- 33 cutting unit
- 34 hand mower
- 35 cutting cylinder
- 36 blade
- 37 riding mower
- 38 brake lock
- 39 electric starter
- 40 brake pedal
- 41 cutting unit
- 42 tip-up trailer
- 43 revolving sprinkler, a lawn sprinkler
- 44 revolving nozzle
- 45 hose connector
- 46 oscillating sprinkler
- 47 wheelbarrow
- 48 grass shears
- 49 hedge shears
- 50 secateurs (pruning shears)

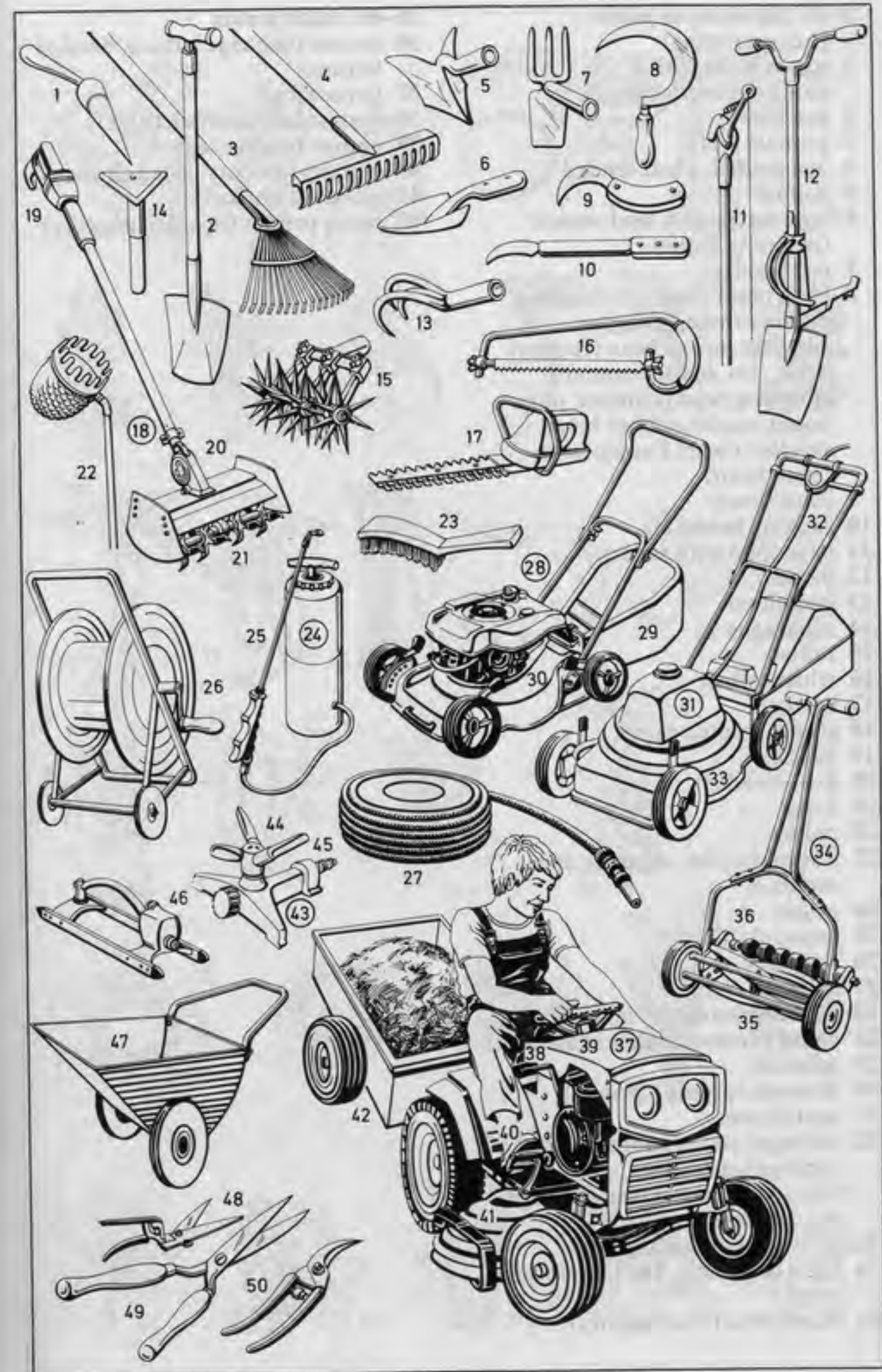



## 1-11 leguminous plants

(Leguminosae)

- 1 pea, a plant with a papilionaceous corolla
- 2 pea flower
- 3 pinnate leaf
- 4 pea tendril, a leaf tendril
- 5 stipule
- 6 legume (pod), a seed vessel (pericarp, legume)
- 7 pea [seed]
- 8 bean plant (bean), a climbing plant (climber, creeper); *varieties*: broad bean (runner bean, *Am.* scarlet runner), climbing bean (climber, pole bean), scarlet runner bean; *smaller*: dwarf French bean (bush bean)
- 9 bean flower
- 10 twining beanstalk
- 11 bean [pod with seeds]
- 12 tomato
- 13 cucumber
- 14 asparagus
- 15 radish
- 16 white radish
- 17 carrot
- 18 stump-rooted carrot
- 19 parsley
- 20 horse-radish
- 21 leeks
- 22 chives
- 23 pumpkin (*Am.* squash); *sim.*: melon
- 24 onion
- 25 onion skin
- 26 kohlrabi
- 27 celeriac
- 28-34 brassicas (leaf vegetables)
- 28 chard (Swiss chard, seakale beet)
- 29 spinach
- 30 Brussels sprouts (sprouts)
- 31 cauliflower
- 32 cabbage (round cabbage, head of cabbage), a brassica; *cultivated races (cultivars)*: green cabbage, red cabbage
- 33 savoy (savoy cabbage)
- 34 kale (curly kale, kail), a winter green
- 35 scorzonera (black salsify)

## 36-40 salad plants

- 36 lettuce (cabbage lettuce, head of lettuce)
- 37 lettuce leaf
- 38 corn salad (lamb's lettuce)
- 39 endive (endive leaves)
- 40 chicory (succory, salad chicory)
- 41 globe artichoke
- 42 sweet pepper (Spanish paprika)

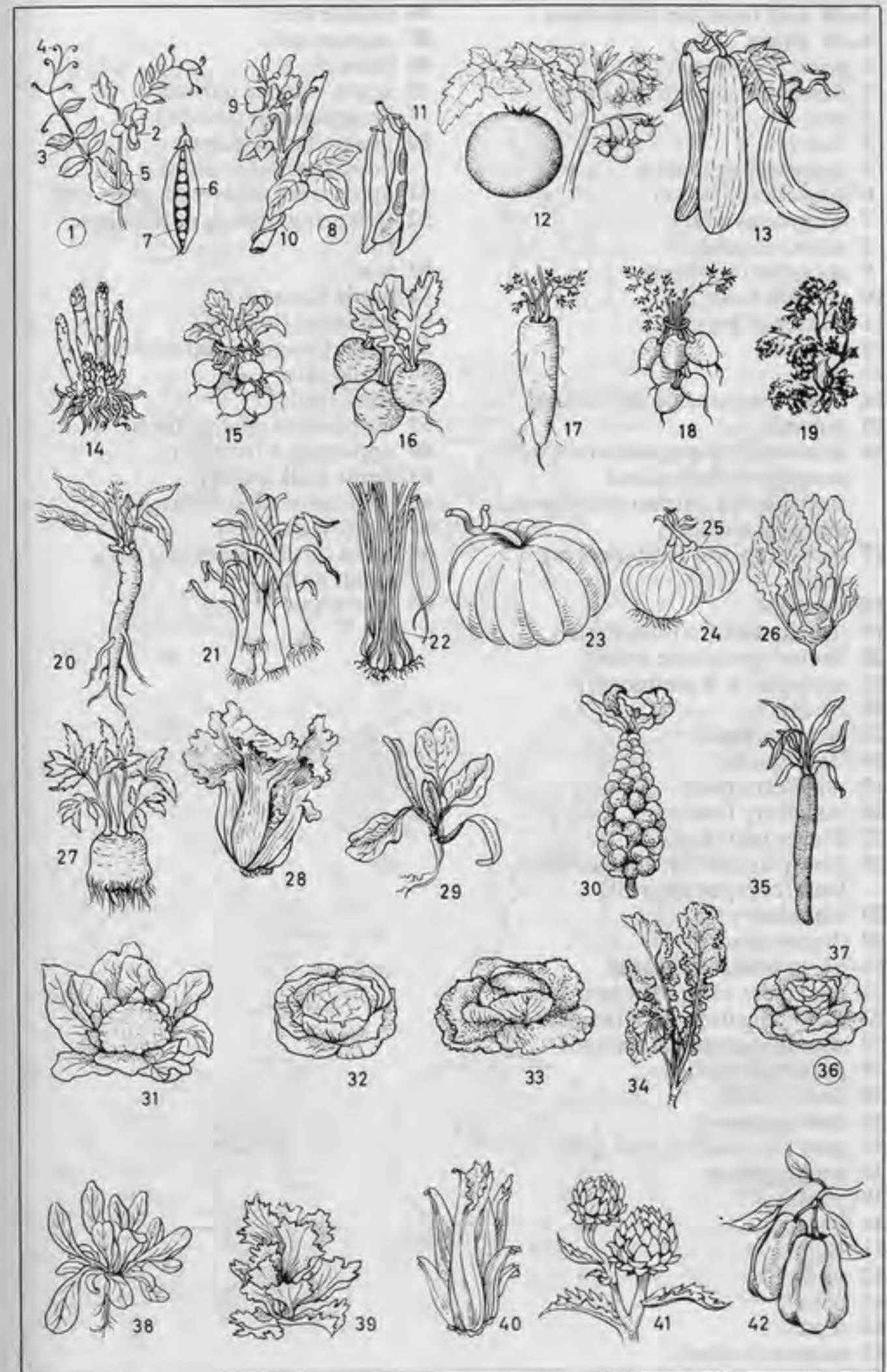



## 1-30 soft fruit (berry bushes)

## 1-15 Ribes

- 1 gooseberry bush
- 2 flowering gooseberry cane
- 3 leaf
- 4 flower
- 5 magpie moth larva
- 6 gooseberry flower
- 7 epigynous ovary
- 8 calyx (sepals)
- 9 gooseberry, a berry
- 10 currant bush
- 11 cluster of berries
- 12 currant
- 13 stalk
- 14 flowering cane of the currant
- 15 raceme
- 16 strawberry plant; *varieties*: wild strawberry (woodland strawberry), garden strawberry, alpine strawberry
- 17 flowering and fruit-bearing plant
- 18 rhizome
- 19 ternate leaf (trifoliate leaf)
- 20 runner (prostrate stem)
- 21 strawberry, a pseudocarp
- 22 epicalyx
- 23 achene (seed)
- 24 flesh (pulp)
- 25 raspberry bush
- 26 raspberry flower
- 27 flower bud (bud)
- 28 fruit (raspberry), an aggregate fruit (compound fruit)
- 29 blackberry
- 30 thorny tendril

## 31-61 pomiferous plants

- 31 pear tree; *wild*: wild pear tree
- 32 flowering branch of the pear tree
- 33 pear [longitudinal section]
- 34 pear stalk (stalk)
- 35 flesh (pulp)
- 36 core (carpels)
- 37 pear pip (seed), a fruit pip
- 38 pear blossom
- 39 ovules
- 40 ovary
- 41 stigma
- 42 style
- 43 petal
- 44 sepal
- 45 stamen (anther)

- 46 quince tree
- 47 quince leaf
- 48 stipule
- 49 apple-shaped quince [longitudinal section]
- 50 pear-shaped quince [longitudinal section]
- 51 apple tree; *wild*: crab apple tree
- 52 flowering branch of the apple tree
- 53 leaf
- 54 apple blossom
- 55 withered flower
- 56 apple [longitudinal section]
- 57 apple skin
- 58 flesh (pulp)
- 59 core (apple core, carpels)
- 60 apple pip, a fruit pip
- 61 apple stalk (stalk)
- 62 codling moth (codlin moth)
- 63 burrow (tunnel)
- 64 larva (grub, caterpillar) of a small moth
- 65 wormhole

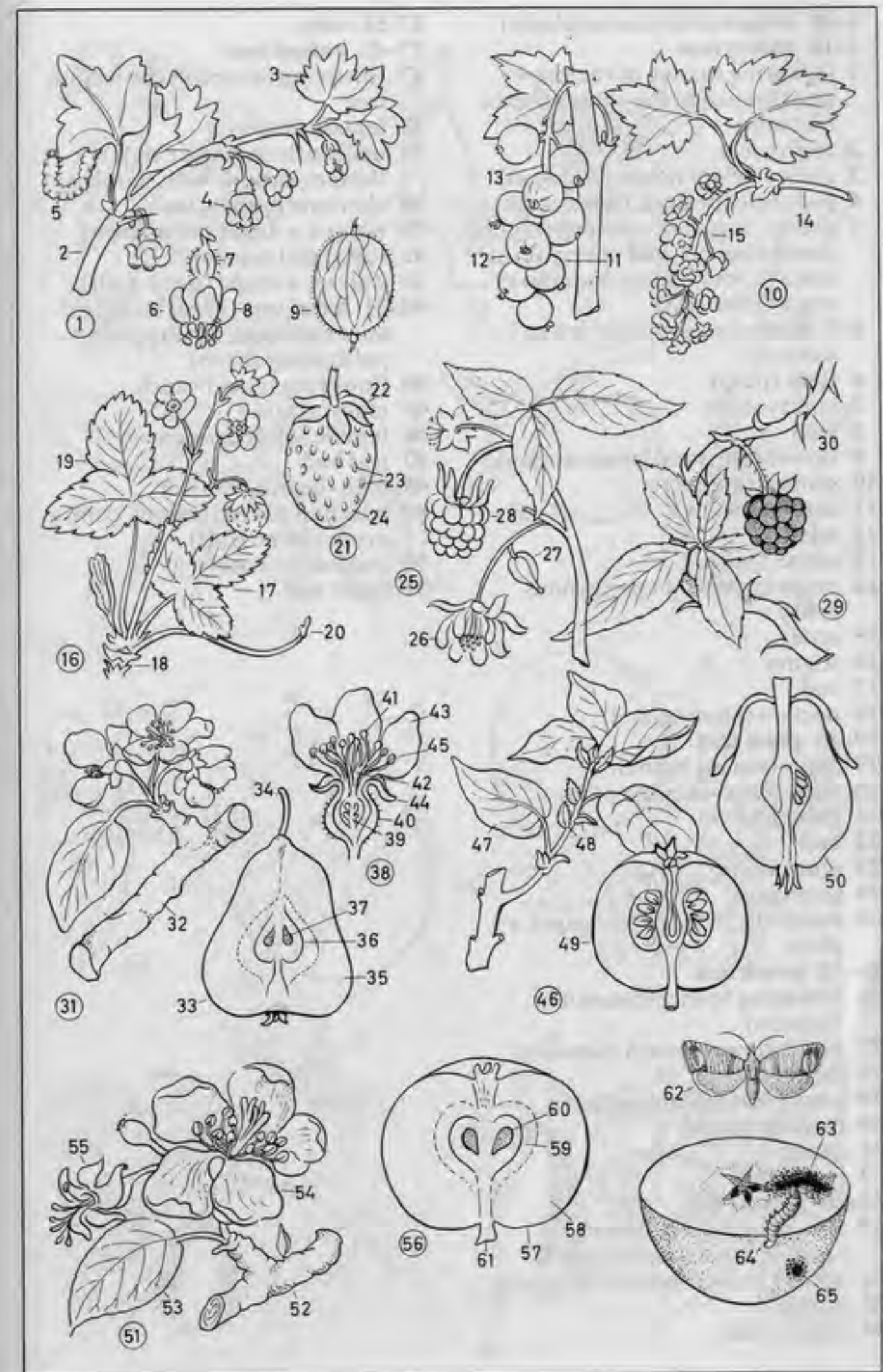



- 1-36 drupes (drupaceous plants)  
 1-18 cherry tree  
 1 flowering branch of the cherry tree (branch of the cherry tree in blossom)  
 2 cherry leaf  
 3 cherry flower (cherry blossom)  
 4 peduncle (pedicel, flower stalk)  
 5 cherry; *varieties*: sweet cherry (heart cherry), wild cherry (bird cherry), sour cherry, morello cherry (morello)  
 6-8 cherry (cherry fruit) [cross section]  
 6 flesh (pulp)  
 7 cherry stone  
 8 seed  
 9 flower (blossom) [cross section]  
 10 stamen (anther)  
 11 corolla (petals)  
 12 sepal  
 13 carpel (pistil)  
 14 ovule enclosed in perigynous ovary  
 15 style  
 16 stigma  
 17 leaf  
 18 nectary (honey gland)  
 19-23 plum tree  
 19 fruit-bearing branch  
 20 oval, black-skinned plum  
 21 plum leaf  
 22 bud  
 23 plum stone  
 24 greengage  
 25 mirabelle (transparent gage), a plum  
 26-32 peach tree  
 26 flowering branch (branch in blossom)  
 27 peach flower (peach blossom)  
 28 flower shoot  
 29 young leaf (sprouting leaf)  
 30 fruiting branch  
 31 peach  
 32 peach leaf  
 33-36 apricot tree  
 33 flowering apricot branch (apricot branch in blossom)  
 34 apricot flower (apricot blossom)  
 35 apricot  
 36 apricot leaf

- 37-51 nuts  
 37-43 walnut tree  
 37 flowering branch of the walnut tree  
 38 female flower  
 39 male inflorescence (male flowers, catkins with stamens)  
 40 alternate pinnate leaf  
 41 walnut, a drupe (stone fruit)  
 42 soft shell (cupule)  
 43 walnut, a drupe (stone fruit)  
 44-51 hazel tree (hazel bush), an anemophilous shrub (a wind-pollinating shrub)  
 44 flowering hazel branch  
 45 male catkin  
 46 female inflorescence  
 47 leaf bud  
 48 fruit-bearing branch  
 49 hazelnut (hazel, cobnut, cob), a drupe (stone fruit)  
 50 involucre (husk)  
 51 hazel leaf

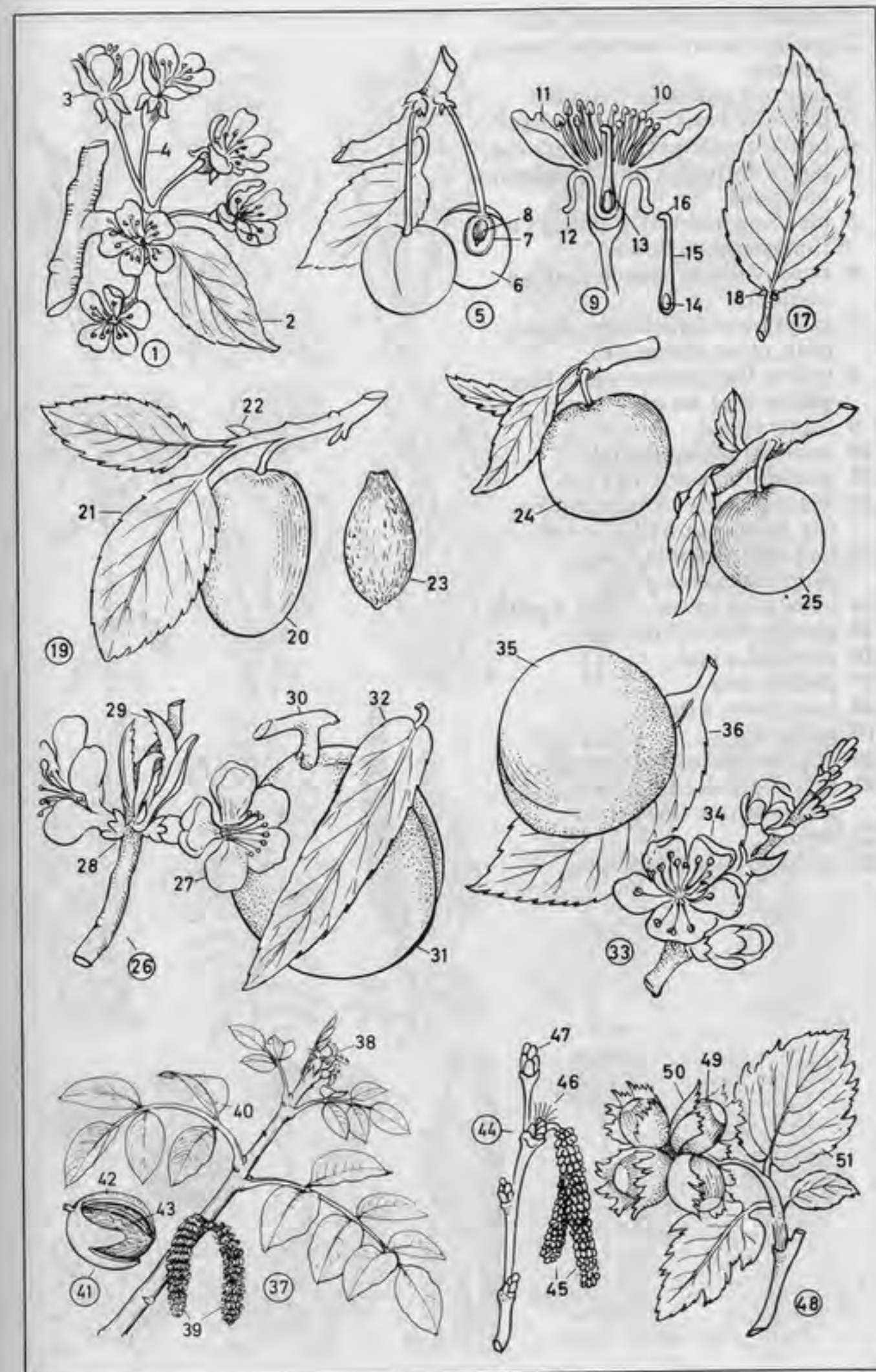



- 1 snowdrop (spring snowflake)
- 2 garden pansy (heartsease pansy), a pansy
- 3 trumpet narcissus (trumpet daffodil, Lent lily), a narcissus
- 4 poet's narcissus (pheasant's eye, poet's daffodil); *sim.*: polyanthus narcissus
- 5 bleeding heart (lyre flower), a fumariaceous flower
- 6 sweet william (bunch pink), a carnation
- 7 gillyflower (gilliflower, clove pink, clove carnation)
- 8 yellow flag (yellow water flag, yellow iris), an iris
- 9 tuberose
- 10 columbine (aquilegia)
- 11 gladiolus (sword lily)
- 12 Madonna lily (Annunciation lily, Lent lily), a lily
- 13 larkspur (delphinium), a ranunculaceous plant
- 14 moss pink (moss phlox), a phlox
- 15 garden rose (China rose)
- 16 rosebud, a bud
- 17 double rose
- 18 rose thorn, a thorn
- 19 gaillardia
- 20 African marigold (tagetes)
- 21 love-lies-bleeding, an amaranthine flower
- 22 zinnia
- 23 pompon dahlia, a dahlia

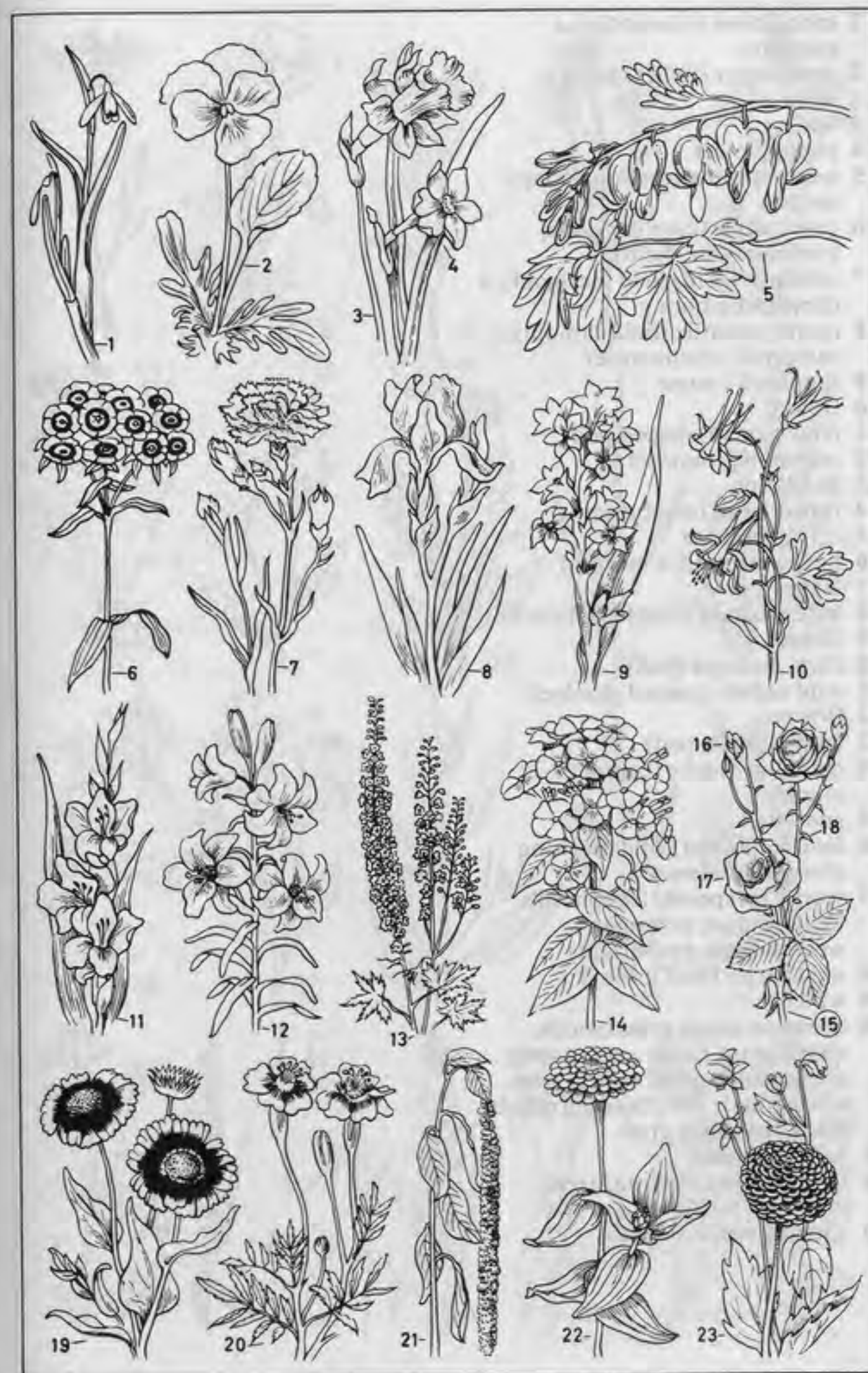



- 1 corn flower (bluebottle), a centaury
- 2 corn poppy (field poppy), a poppy
- 3 bud
- 4 poppy flower
- 5 seed capsule containing poppy seeds
- 6 corn cockle (corn campion, crown-of-the-field)
- 7 corn marigold (field marigold), a chrysanthemum
- 8 corn camomile (field camomile, camomile, chamomile)
- 9 shepherd's purse
- 10 flower
- 11 fruit (pouch-shaped pod)
- 12 common groundsel
- 13 dandelion
- 14 flower head (capitulum)
- 15 infructescence
- 16 hedge mustard, a mustard
- 17 stonecrop
- 18 wild mustard (charlock, runch)
- 19 flower
- 20 fruit, a siliqua (pod)
- 21 wild radish (jointed charlock)
- 22 flower
- 23 fruit (siliqua, pod)
- 24 common orache (common orach)
- 25 goosefoot
- 26 field bindweed (wild morning glory), a bindweed
- 27 scarlet pimpernel (shepherd's weatherglass, poor man's weatherglass, eye-bright)
- 28 wild barley (wall barley)
- 29 wild oat
- 30 common couch grass (couch, quack grass, quick grass, quitch grass, scutch grass, twitch grass, witchgrass); *sim.*: bearded couch grass, sea couch grass
- 31 gallant soldier
- 32 field eryngo (Watling Street thistle), a thistle
- 33 stinging nettle, a nettle





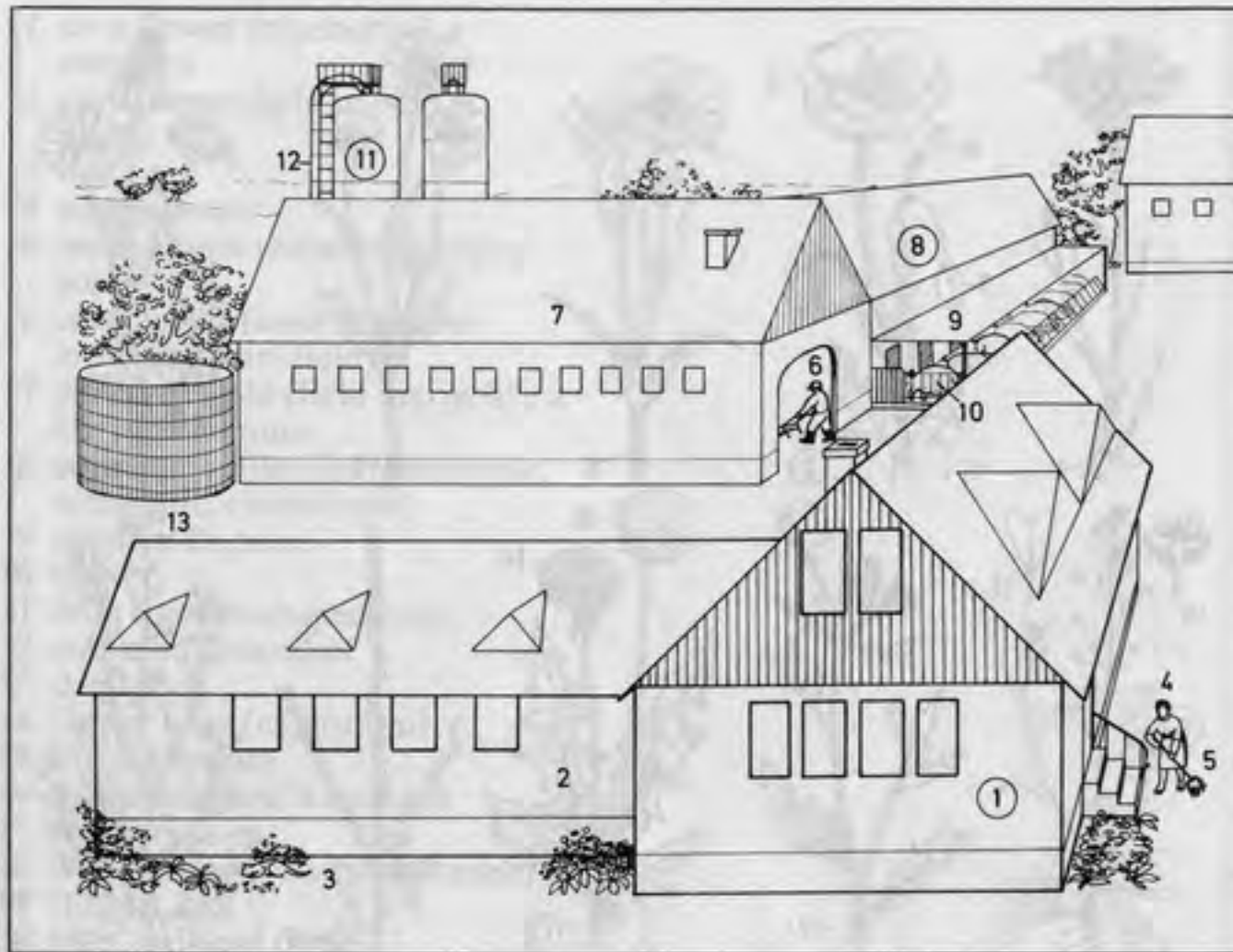

- |  |   |
|--|---|
| 1 house  | 22 spreader unit (distributor unit)         |
| 2 stable   | 23 spreader cylinder (distributor cylinder) |
| 3 house cat (cat)  | 24 movable scraper floor                    |
| 4 farmer's wife  | 25 side planking (side board)               |
| 5 broom  | 26 wire mesh front                          |
| 6 farmer   | 27 sprinkler cart                           |
| 7 cowshed  | 28 sprinkler stand                          |
| 8 pigsty (sty, <i>Am.</i> pigpen, hogpen)                    | 29 sprinkler, a revolving sprinkler         |
| 9 outdoor trough   | 30 sprinkler hoses                          |
| 10 pig   | 31 farmyard                                 |
| 11 above-ground silo (fodder silo)                           | 32 watchdog                                 |
| 12 silo pipe (standpipe for filling the silo)                | 33 calf                                     |
| 13 liquid manure silo  | 34 dairy cow (milch-cow, milker)            |
| 14 outhouse  | 35 farmyard hedge                           |
| 15 machinery shed  | 36 chicken (hen)                            |
| 16 sliding door  | 37 cock ( <i>Am.</i> rooster)               |
| 17 door to the workshop                                      | 38 tractor                                  |
| 18 three-way tip-cart, a transport vehicle                   | 39 tractor driver                           |
| 19 tipping cylinder  | 40 all-purpose trailer                      |
| 20 shafts  | 41 [folded] pickup attachment               |
| 21 manure spreader (fertilizer spreader, manure distributor) | 42 unloading unit                           |

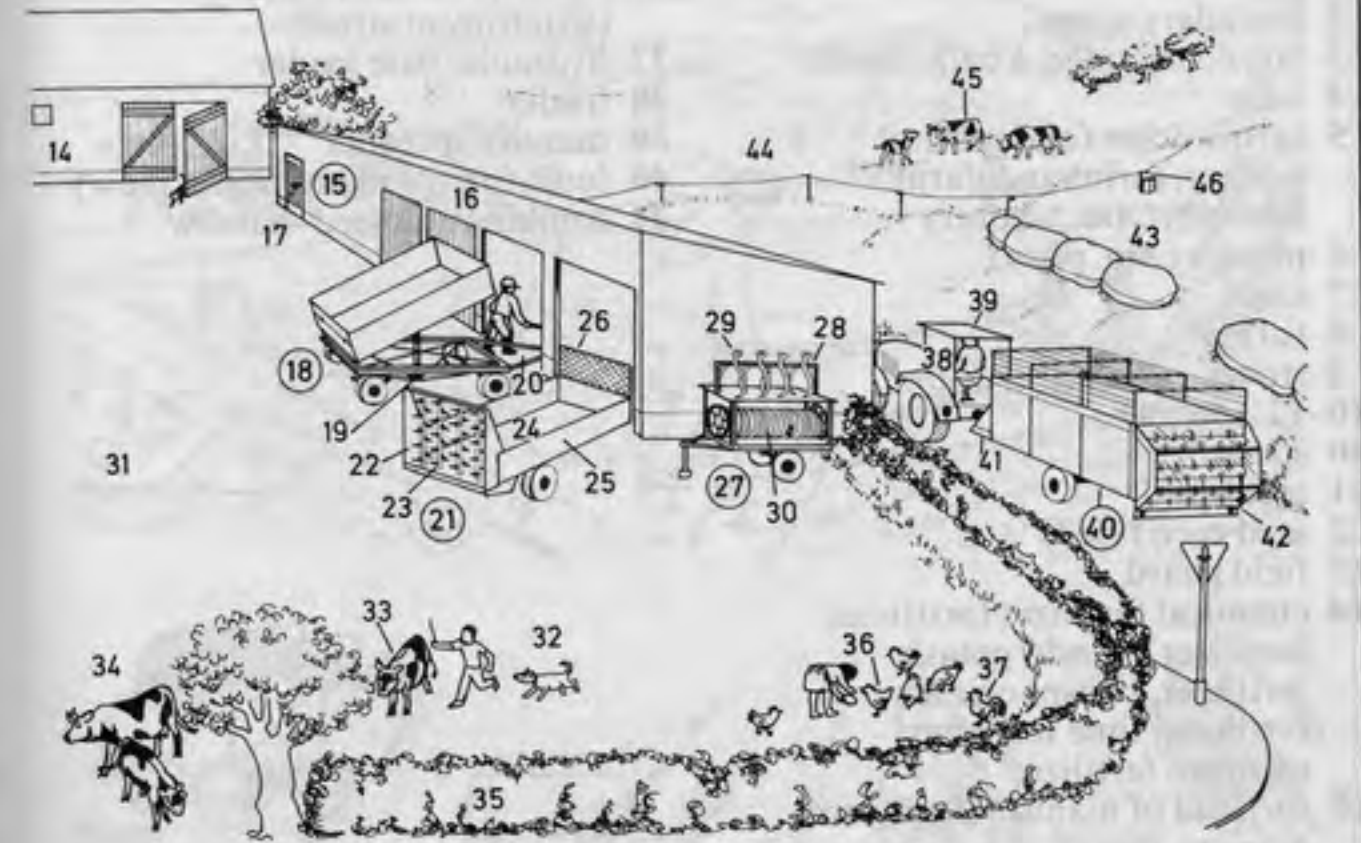

- |                                  |
|----------------------------------|
| 43 polythene silo, a fodder silo |
| 44 meadow                        |
| 45 grazing cattle                |
| 46 electrified fence             |



- 1-41 work in the fields
- 1 fallow (fallow field, fallow ground)
  - 2 boundary stone
  - 3 boundary ridge, a balk (balk)
  - 4 field
  - 5 farmworker (agricultural worker, farmhand, farm labourer, *Am.* laborer)
  - 6 plough (*Am.* plow)
  - 7 clod
  - 8 furrow
  - 9 stone
  - 10-12 sowing
  - 10 sower
  - 11 seedlip
  - 12 seed corn (seed)
  - 13 field guard
  - 14 chemical fertilizer (artificial fertilizer); *kinds*: potash fertilizer, phosphoric acid fertilizer, lime fertilizer, nitrogen fertilizer
  - 15 cartload of manure (farmyard manure, dung)
  - 16 oxteam (team of oxen, *Am.* span of oxen)
  - 17 fields (farmland)
  - 18 farm track (farm road)
  - 19-30 hay harvest (haymaking)
  - 19 rotary mower with swather (swath reaper)
  - 20 connecting shaft (connecting rod)
  - 21 power take-off (power take-off shaft)
  - 22 meadow
  - 23 swath (swathe)
  - 24 tedder (rotary tedder)
  - 25 teded hay
  - 26 rotary swather
  - 27 trailer with pickup attachment
  - 28 fence rack (rickstand), a drying rack for hay
  - 29 rickstand, a drying rack for hay
  - 30 hay tripod
  - 31-41 grain harvest and seedbed preparation
  - 31 combine harvester
  - 32 cornfield
  - 33 stubble field
  - 34 bale of straw
  - 35 straw baler (straw press), a high-pressure baler
  - 36 swath (swathe) of straw (windrow of straw)
  - 37 hydraulic bale loader
  - 38 trailer
  - 39 manure spreader
  - 40 four-furrow plough (*Am.* plow)
  - 41 combination seed-harrow

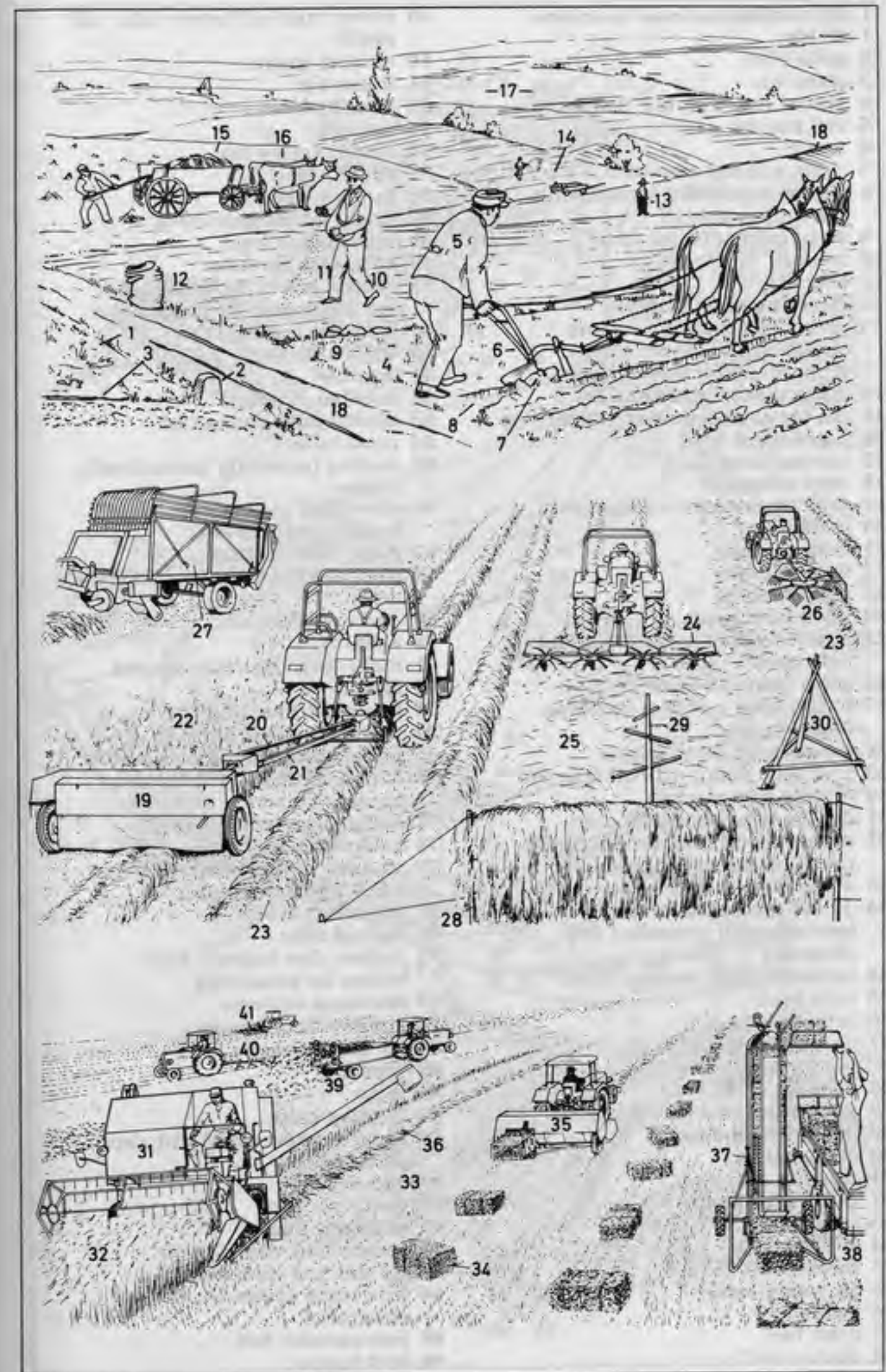



- 1-33 combine harvester (combine)  
 1 divider  
 2 grain lifter  
 3 cutter bar  
 4 pickup reel, a spring-tine reel  
 5 reel gearing  
 6 auger  
 7 chain and slat elevator  
 8 hydraulic cylinder for adjusting the cutting unit  
 9 stone catcher (stone trap)  
 10 awner  
 11 concave  
 12 threshing drum (drum)  
 13 revolving beater [for freeing straw from the drum and preparing it for the shakers]  
 14 straw shaker (strawwalker)  
 15 fan for compressed-air winnowing  
 16 preparation level  
 17 louvred-type sieve  
 18 sieve extension  
 19 shoe sieve (reciprocating sieve)  
 20 grain auger  
 21 tailings auger  
 22 tailings outlet  
 23 grain tank  
 24 grain tank auger  
 25 augers feeding to the grain tank unloader  
 26 grain unloader spout  
 27 observation ports for checking tank contents  
 28 six-cylinder diesel engine  
 29 hydraulic pump with oil reservoir  
 30 driving axle gearing  
 31 driving wheel tyre (Am. tire)  
 32 rubber-tyred (Am. rubber-tired) wheel on the steering axle  
 33 driver's position  
 34-39 self-propelled forage harvester (self-propelled field chopper)  
 34 cutting drum (chopper drum)  
 35 corn head  
 36 cab (driver's cab)  
 37 swivel-mounted spout (discharge pipe)  
 38 exhaust  
 39 rear-wheel steering system  
 40-45 rotary swather  
 40 cardan shaft  
 41 running wheel  
 42 double spring tine  
 43 crank  
 44 swath rake  
 45 three-point linkage  
 46-58 rotary tedder  
 46 tractor  
 47 draw bar  
 48 cardan shaft  
 49 power take-off (power take-off shaft)  
 50 gearing (gears)  
 51 frame bar  
 52 rotating head  
 53 tine bar  
 54 double spring tine  
 55 guard rail  
 56 running wheel  
 57 height adjustment crank  
 58 wheel adjustment  
 59-84 potato harvester  
 59 control levers for the lifters of the digger and the hopper and for adjusting the shaft  
 60 adjustable hitch  
 61 drawbar  
 62 drawbar support  
 63 cardan shaft connection  
 64 press roller  
 65 gearing (gears) for the hydraulic system  
 66 disc (disk) coulter (Am. colter) (rolling coulter)  
 67 three-bladed share  
 68 disc (disk) coulter (Am. colter) drive  
 69 open-web elevator  
 70 agitator  
 71 multi-step reduction gearing  
 72 feeder  
 73 haulm stripper (flail rotor)  
 74 rotary elevating drum  
 75 mechanical tumbling separator  
 76 haulm conveyor with flexible haulm strippers  
 77 haulm conveyor agitator  
 78 haulm conveyor drive with V-belt  
 79 studded rubber belt for sorting vines, clods and stones  
 80 trash conveyor  
 81 sorting table  
 82 rubber-disc (rubber-disk) rollers for presorting  
 83 discharge conveyor  
 84 endless-floor hopper  
 85-96 beet harvester  
 85 topper  
 86 feeler  
 87 topping knife  
 88 feeler support wheel with depth adjustment  
 89 beet cleaner  
 90 haulm elevator  
 91 hydraulic pump  
 92 compressed-air reservoir  
 93 oil tank (oil reservoir)  
 94 tensioning device for the beet elevator  
 95 beet elevator belt  
 96 beet hopper

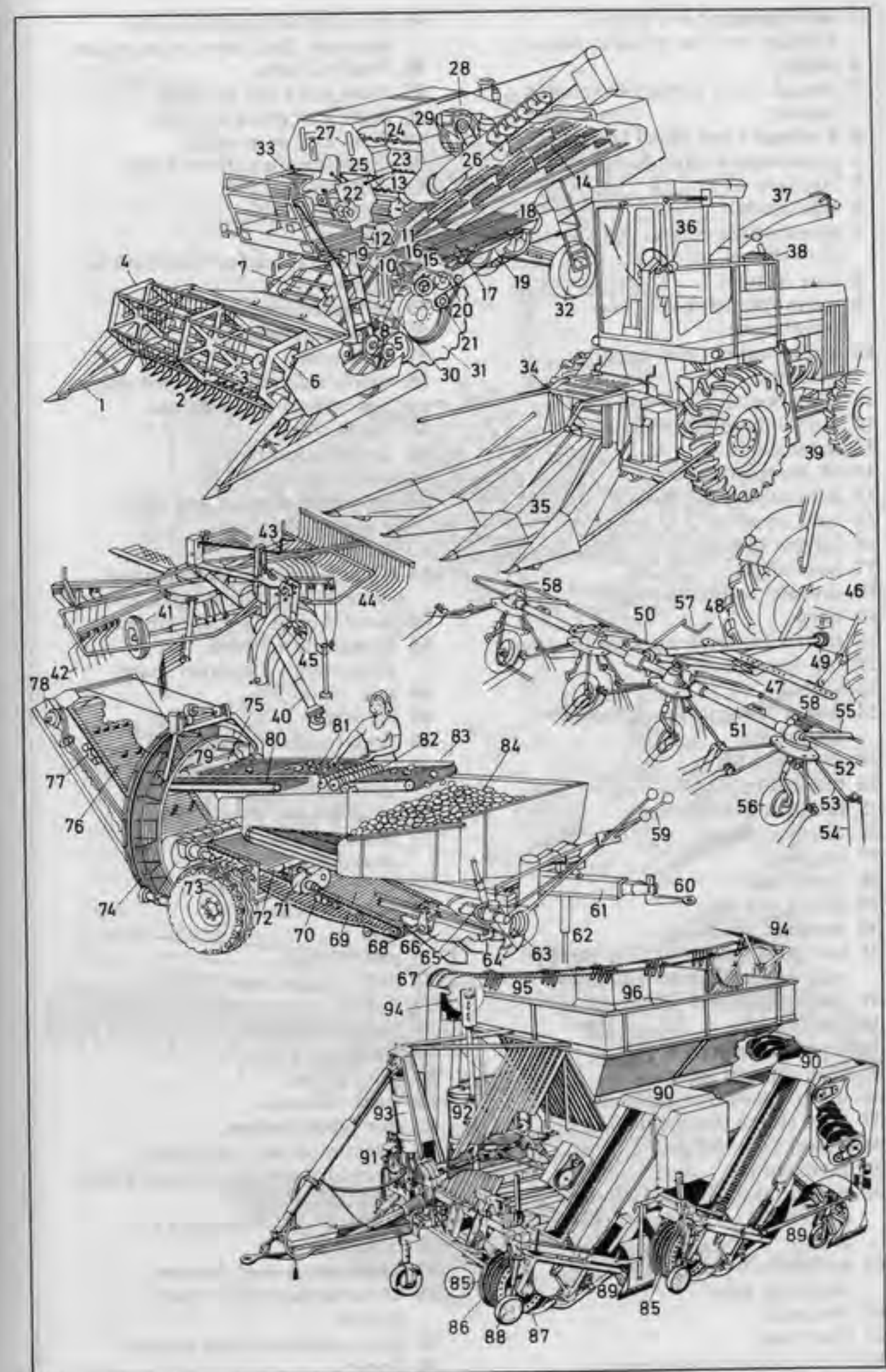



- 1 wheel plough (*Am. plow*),  
a single-bottom plough [*form.*]
- 2 handle
- 3 plough (*Am. plow*) stilt (plough handle)
- 4-8 plough (*Am. plow*) bottom
- 4 mouldboard (*Am. moldboard*)
- 5 landside
- 6 sole (slade)
- 7 ploughshare (share, *Am. plowshare*)
- 8 frog (frame)
- 9 beam (plough beam, *Am. plowbeam*)
- 10 knife coulter (*Am. colter*),  
a coulter
- 11 skim coulter (*Am. colter*)
- 12 guide-chain crossbar
- 13 guide chain
- 14-19 forecarriage
- 14 adjustable yoke (yoke)
- 15 land wheel
- 16 furrow wheel
- 17 hake chain
- 18 draught beam (drawbar)
- 19 hake
- 20 tractor (general-purpose tractor)
- 21 cab frame (roll bar)
- 22 seat
- 23 power take-off gear-change  
(gearshift)
- 24-29 power lift
- 24 ram piston
- 25 lifting rod adjustment
- 26 drawbar frame
- 27 top link
- 28 lower link
- 29 lifting rod
- 30 drawbar coupling
- 31 live power take-off (live power take-off shaft, take-off shaft)
- 32 differential gear (differential)
- 33 floating axle
- 34 torque converter lever
- 35 gear-change (gearshift)
- 36 multi-speed transmission
- 37 fluid clutch (fluid drive)
- 38 power take-off gear
- 39 main clutch
- 40 power take-off gear-change  
(gearshift) with power take-off clutch
- 41 hydraulic power steering and reversing gears
- 42 fuel tank
- 43 float lever
- 44 four-cylinder diesel engine
- 45 oil sump and pump for the pressure-feed lubrication system
- 46 fresh oil tank
- 47 track rod (*Am. tie rod*)
- 48 front axle pivot pin
- 49 front axle suspension
- 50 front coupling (front hitch)
- 51 radiator
- 52 fan
- 53 battery
- 54 oil bath air cleaner (oil bath air filter)
- 55 cultivator (grubber)
- 56 sectional frame
- 57 spring tine
- 58 share, a diamond-shaped share;  
*sim.*: chisel-shaped share
- 59 depth wheel
- 60 depth adjustment
- 61 coupling (hitch)
- 62 reversible plough (*Am. plow*),  
a mounted plough
- 63 depth wheel
- 64-67 plough (*Am. plow*) bottom,  
a general-purpose plough bottom
- 64 mouldboard (*Am. moldboard*)
- 65 ploughshare (share, *Am. plowshare*), a pointed share
- 66 sole (slade)
- 67 landside
- 68 skim coulter (*Am. colter*)
- 69 disc (disk) coulter (*Am. colter*)  
(rolling coulter)
- 70 plough (*Am. plow*) frame
- 71 beam (plough beam, *Am. plowbeam*)
- 72 three-point linkage
- 73 swivel mechanism
- 74 drill
- 75 seed hopper
- 76 drill coulter (*Am. colter*)
- 77 delivery tube, a telescopic tube
- 78 feed mechanism
- 79 gearbox
- 80 drive wheel
- 81 track indicator
- 82 disc (disk) harrow,  
a semimounted implement
- 83 discs (disks) in X-configuration
- 84 plain disc (disk)
- 85 serrated-edge disc (disk)
- 86 quick hitch
- 87 combination seed-harrow
- 88 three-section spike-tooth harrow
- 89 three-section rotary harrow
- 90 frame

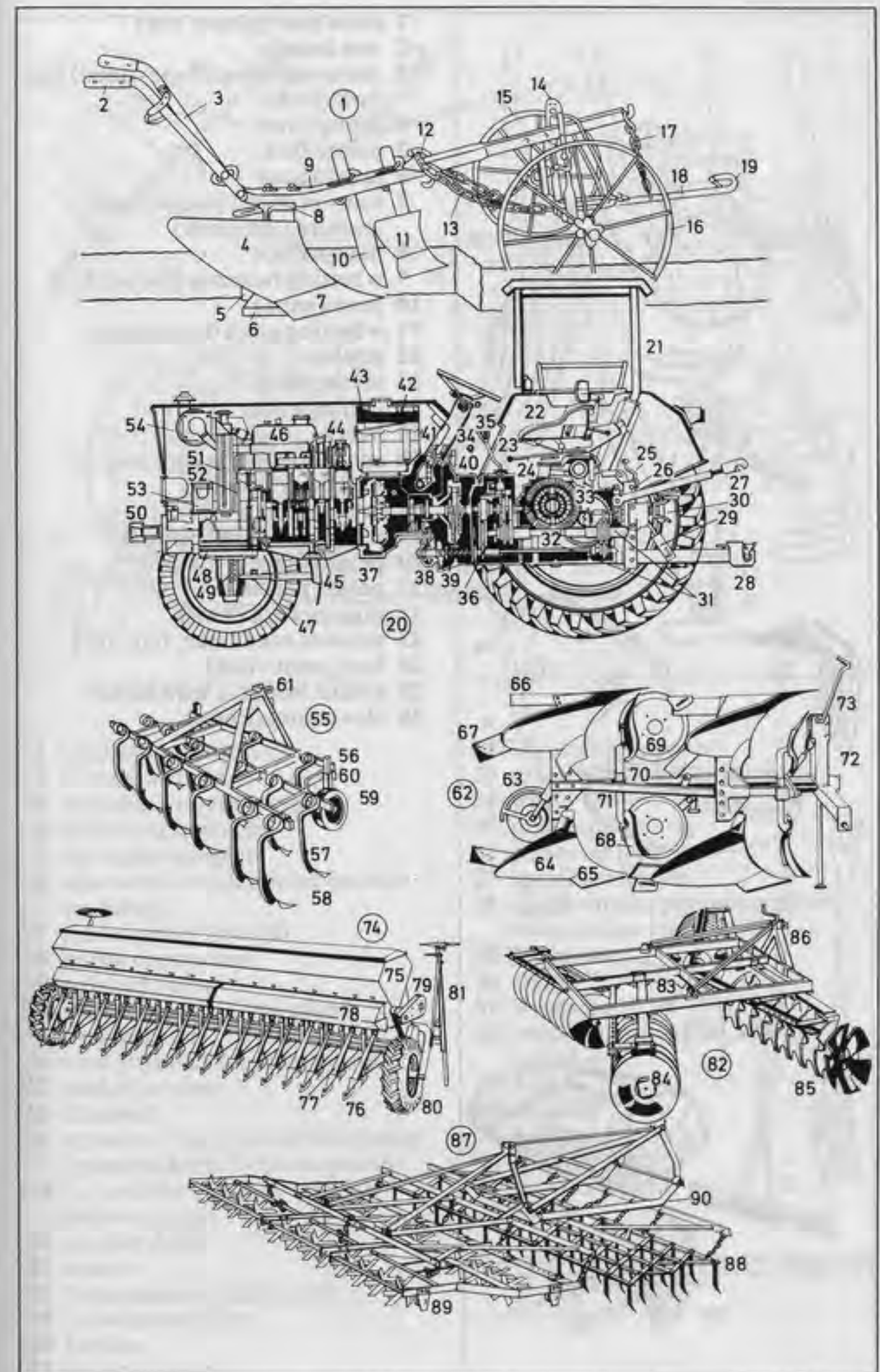





- 1 draw hoe (garden hoe)
- 2 hoe handle
- 3 three-pronged (three-tined) hay fork (fork)
- 4 prong (tine)
- 5 potato fork
- 6 potato hook
- 7 four-pronged (four-tined) manure fork (fork)
- 8 manure hoe
- 9 whetting hammer [for scythes]
- 10 peen (pane)
- 11 whetting anvil [for scythes]
- 12 scythe
- 13 scythe blade
- 14 cutting edge
- 15 heel
- 16 snath (snathe, snead, sneath)
- 17 handle
- 18 scythe sheath
- 19 whetstone (scythestone)
- 20 potato rake
- 21 potato planter
- 22 digging fork (fork)
- 23 wooden rake (rake, hayrake)
- 24 hoe (potato hoe)
- 25 potato basket, a wire basket
- 26 clover broadcaster

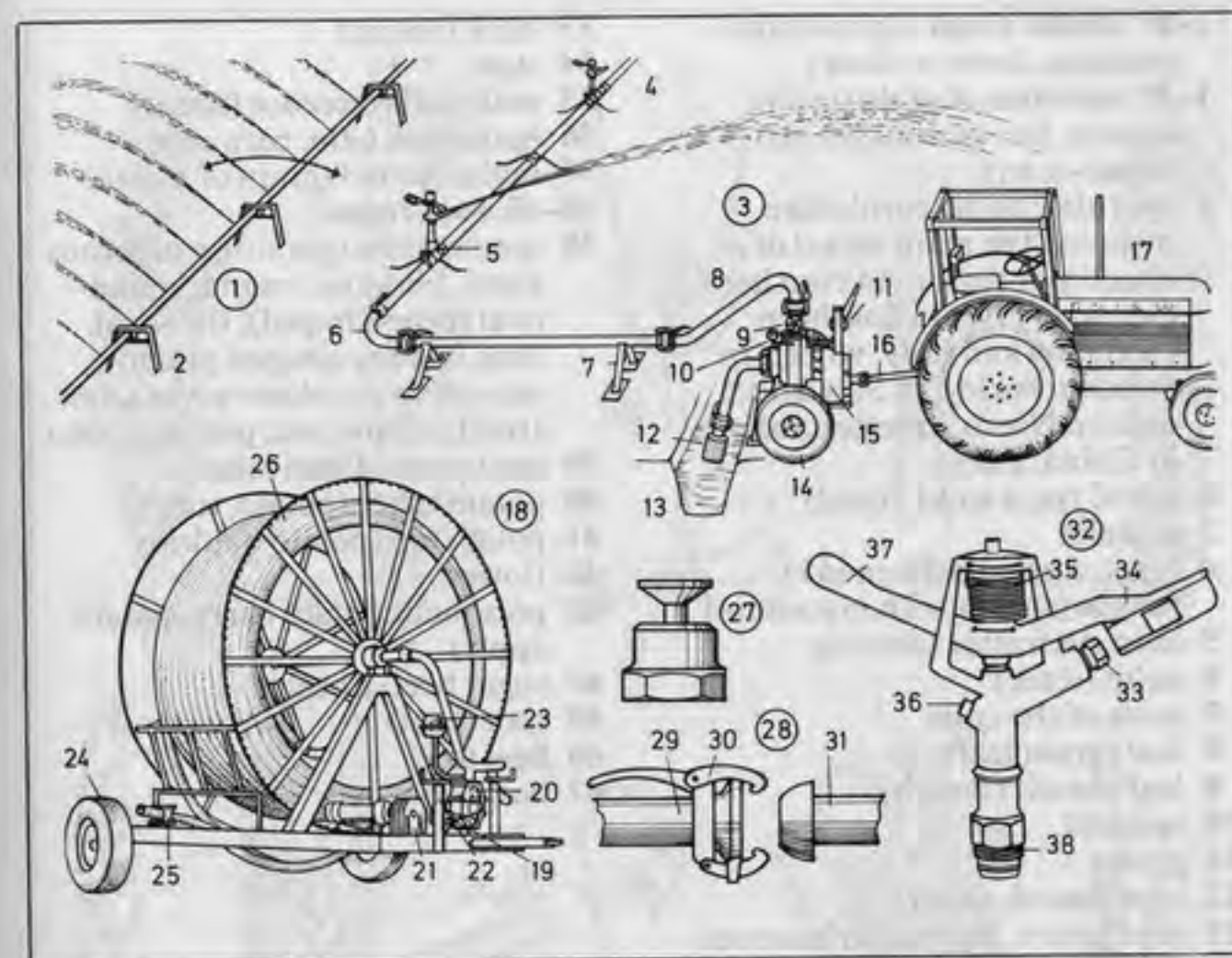

- 1 oscillating spray line
- 2 stand (steel chair)
- 3 portable irrigation system
- 4 revolving sprinkler
- 5 standpipe coupler
- 6 elbow with cardan joint (cardan coupling)
- 7 pipe support (trestle)
- 8 pump connection
- 9 delivery valve
- 10 pressure gauge (*Am. gage*) (manometer)
- 11 centrifugal evacuating pump
- 12 basket strainer
- 13 channel
- 14 chassis of the p.t.o.-driven pump (power take-off-driven pump)
- 15 p.t.o.-driven (power take-off-driven) pump
- 16 cardan shaft
- 17 tractor
- 18 long-range irrigation unit
- 19 drive connection
- 20 turbine
- 21 gearing (gears)
- 22 adjustable support
- 23 centrifugal evacuating pump
- 24 wheel
- 25 pipe support
- 26 polyester pipe
- 27 sprinkler nozzle
- 28 quick-fitting pipe connection with cardan joint
- 29 M-cardan
- 30 clamp
- 31 V-cardan
- 32 revolving sprinkler, a field sprinkler
- 33 nozzle
- 34 breaker
- 35 breaker spring
- 36 stopper
- 37 counterweight
- 38 thread



- 1-47 arable crops (agricultural produce, farm produce)
- 1-37 varieties of grain (grain, cereals, farinaceous plants, bread-corn)
- 1 rye (*also*: corn, 'corn' often meaning the main cereal of a country or region; in Northern Germany: rye; in Southern Germany and Italy: wheat; in Sweden: barley; in Scotland: oats; in North America: maize; in China: rice)
- 2 ear of rye, a spike (head)
- 3 spikelet
- 4 ergot, a grain deformed by fungus [shown with mycelium]
- 5 corn stem after tillering
- 6 culm (stalk)
- 7 node of the culm
- 8 leaf (grain leaf)
- 9 leaf sheath (sheath)
- 10 spikelet
- 11 glume
- 12 awn (beard, arista)
- 13 seed (grain, kernel, farinaceous grain)
- 14 embryo plant
- 15 seed
- 16 embryo
- 17 root
- 18 root hair
- 19 grain leaf
- 20 leaf blade (blade, lamina)
- 21 leaf sheath
- 22 ligule (ligula)
- 23 wheat
- 24 spelt
- 25 seed; *unripe*: green spelt, a soup vegetable
- 26 barley
- 27 oat panicle, a panicle
- 28 millet
- 29 rice
- 30 rice grain
- 31 maize (Indian corn, *Am. corn*); *varieties*: popcorn, dent corn, flint corn (flint maize, *Am. Yankee corn*), pod corn (*Am. cow corn*, husk corn), soft corn (*Am. flour corn*, squaw corn), sweet corn
- 32 female inflorescence

- 33 husk (shuck)
- 34 style
- 35 male inflorescence (tassel)
- 36 maize cob (*Am. corn cob*)
- 37 maize kernel (grain of maize)
- 38-45 root crops
- 38 potato plant (potato), a tuberous plant; *varieties*: round, round-oval (pear-shaped), flat-oval, long, kidney-shaped potato; *according to colour*: white (*Am. Irish*), yellow, red, purple potato
- 39 seed potato (seed tuber)
- 40 potato tuber (potato, tuber)
- 41 potato top (potato haulm)
- 42 flower
- 43 poisonous potato berry (potato apple)
- 44 sugar beet, a beet
- 45 root (beet)
- 46 beet top
- 47 beet leaf

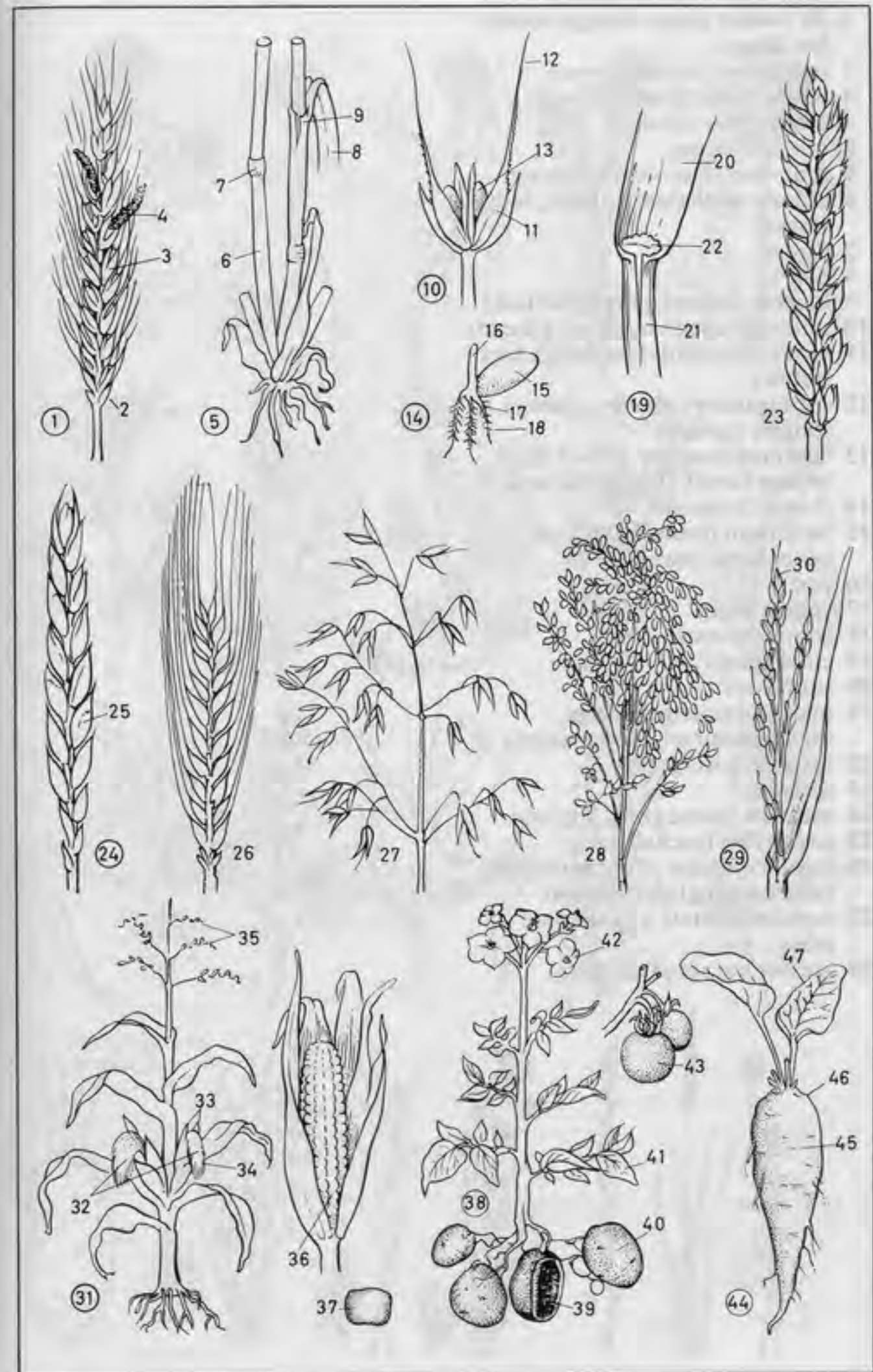



## 1-28 fodder plants (forage plants)

- for tillage
- 1 red clover (purple clover)
  - 2 white clover (Dutch clover)
  - 3 alsike clover (alsike)
  - 4 crimson clover
  - 5 four-leaf (four-leaved) clover
  - 6 kidney vetch (lady's finger, lady-finger)
  - 7 flower
  - 8 pod
  - 9 lucerne (lucerne, purple medick)
  - 10 sainfoin (cock's head, cockshead)
  - 11 bird's foot (bird-foot, bird's foot trefoil)
  - 12 corn spurrey (spurrey, spurry), a spurrey (spurry)
  - 13 common comfrey, one of the borage family (Boraginaceae)
  - 14 flower (blossom)
  - 15 field bean (broad bean, tick bean, horse bean)
  - 16 pod
  - 17 yellow lupin
  - 18 common vetch
  - 19 chick-pea
  - 20 sunflower
  - 21 mangold (mangelwurzel, mangoldwurzel, field mangel)
  - 22 false oat (oat-grass)
  - 23 spikelet
  - 24 meadow fescue grass, a fescue
  - 25 cock's foot (cocksfoot)
  - 26 Italian ryegrass; *sim.*: perennial ryegrass (English ryegrass)
  - 27 meadow foxtail, a paniculate grass
  - 28 greater burnet saxifrage







- 1 bulldog  
 2 ear, a rose-ear  
 3 muzzle  
 4 nose  
 5 foreleg  
 6 forepaw  
 7 hind leg  
 8 hind paw  
 9 pug (pug dog)  
 10 boxer  
 11 withers  
 12 tail, a docked tail  
 13 collar  
 14 Great Dane  
 15 wire-haired fox terrier  
 16 bull terrier  
 17 Scottish terrier  
 18 Bedlington terrier  
 19 Pekinese (Pekingese, Pekinese dog, Pekingese dog)  
 20 spitz (Pomeranian)  
 21 chow (chow-chow)  
 22 husky  
 23 Afghan (Afghan hound)  
 24 greyhound (*Am.* grayhound), a courser  
 25 Alsatian (German sheepdog, *Am.* German shepherd), a police dog, watch dog, and guide dog  
 26 flews (chaps)  
 27 Dobermann terrier

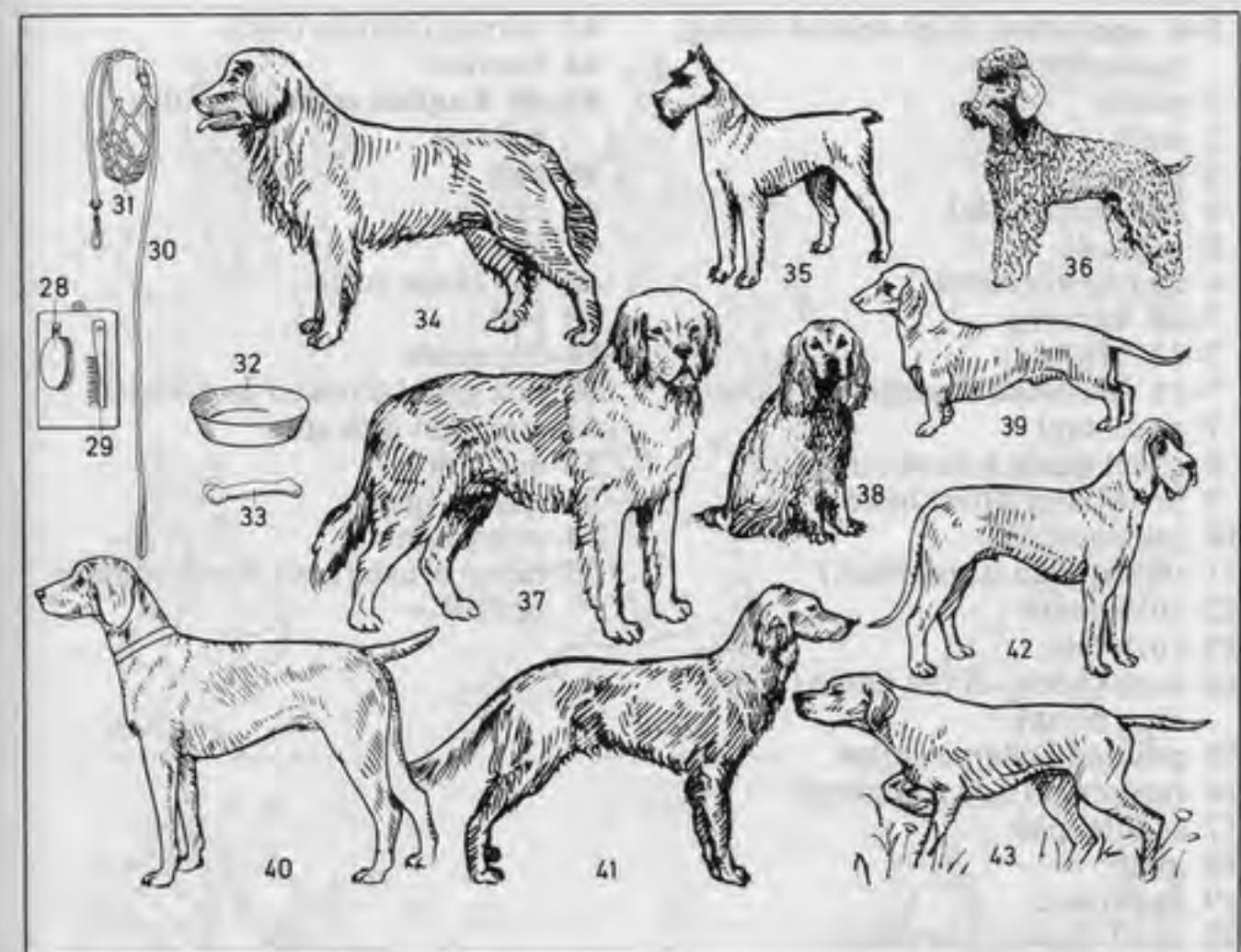

- 28 dog brush  
 29 dog comb  
 30 lead (dog lead, leash); *for hunting*: leash  
 31 muzzle  
 32 feeding bowl (dog bowl)  
 33 bone  
 34 Newfoundland dog  
 35 schnauzer  
 36 poodle; *sim. and smaller*: pygmy (pigmy) poodle  
 37 St. Bernard (St. Bernard dog)  
 38 cocker spaniel  
 39 dachshund, a terrier  
 40 German pointer  
 41 English setter  
 42 trackhound  
 43 pointer, a trackhound



- 1-6 **equitation** (high school riding, haute école)
- 1 piaffe
  - 2 walk
  - 3 passage
  - 4 levade (pesade)
  - 5 capriole
  - 6 courbette (curvet)
- 7-25 **harness**
- 7-13 **bridle**
  - 7-11 **headstall** (headpiece, halter)
  - 7 noseband
  - 8 cheek piece (cheek strap)
  - 9 browband (front band)
  - 10 crownpiece
  - 11 throatlatch (throatlash)
  - 12 curb chain
  - 13 curb bit
  - 14 hasp (hook) of the hame (*Am.* drag hook)
  - 15 pointed collar, a collar
  - 16 trappings (side trappings)
  - 17 saddle-pad
  - 18 girth
  - 19 backband
  - 20 shaft chain (pole chain)
  - 21 pole
  - 22 trace
  - 23 second girth (emergency girth)
  - 24 trace
  - 25 reins (*Am.* lines)
- 26-36 **breast harness**
- 26 blinker (*Am.* blinder, winker)
  - 27 breast collar ring
  - 28 breast collar (Dutch collar)
  - 29 fork
  - 30 neck strap
  - 31 saddle-pad
  - 32 loin strap
  - 33 reins (rein, *Am.* line)
  - 34 crupper (crupper-strap)
  - 35 trace
  - 36 girth (belly-band)
- 37-49 **saddles**
- 37-44 **stock saddle** (*Am.* western saddle)
  - 37 saddle seat
  - 38 pommel horn (horn)
  - 39 cantle
  - 40 flap (*Am.* fender)
  - 41 bar
  - 42 stirrup leather
  - 43 stirrup (stirrup iron)
  - 44 blanket
- 45-49 **English saddle** (cavalry saddle)
- 45 seat
  - 46 cantle
  - 47 flap
  - 48 roll (knee roll)
  - 49 pad
- 50-51 **spurs**
- 50 box spur (screwed jack spur)
  - 51 strapped jack spur
- 52 curb bit
- 53 gag bit (gag)
- 54 currycomb
- 55 horse brush (body brush, dandy brush)

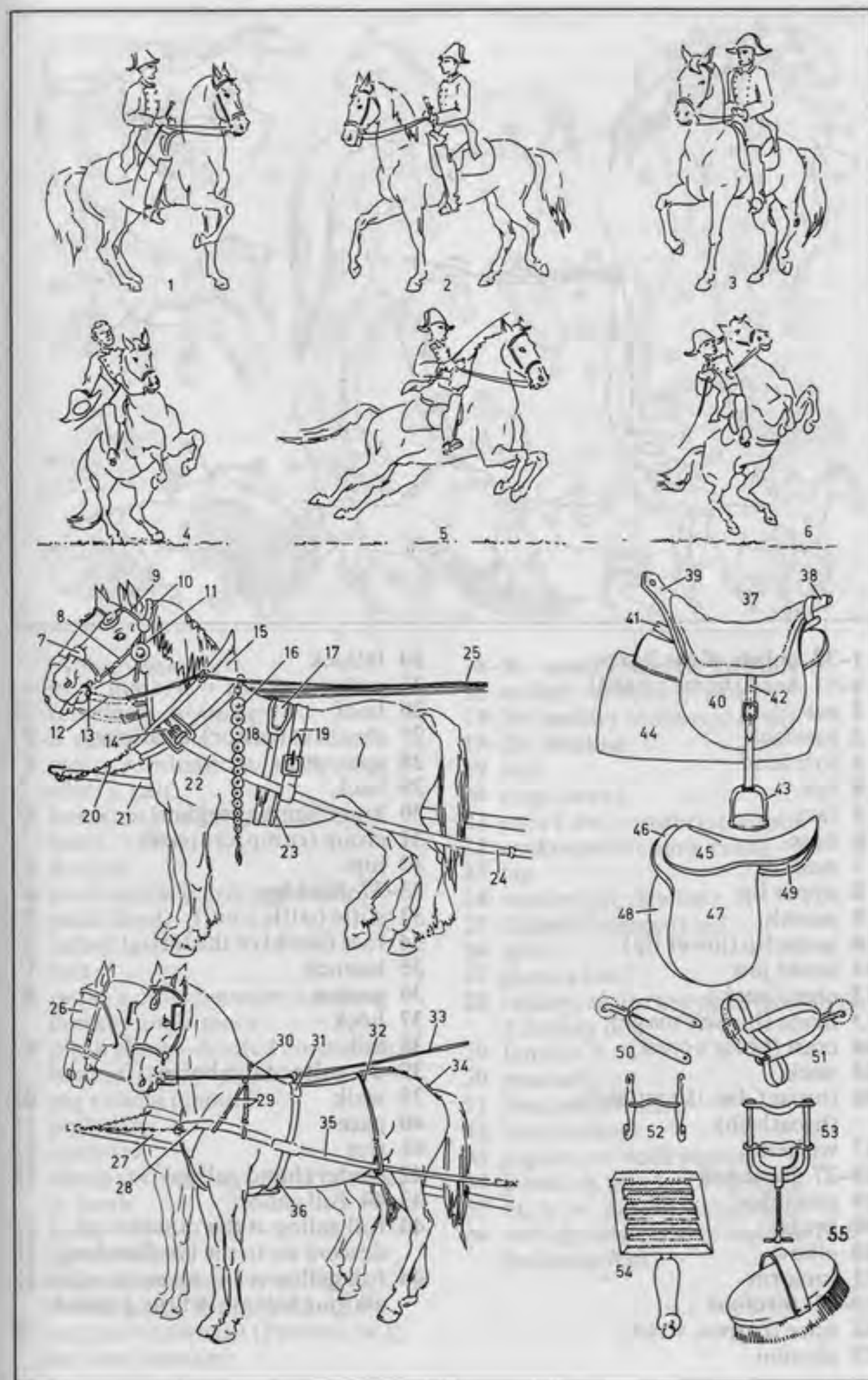

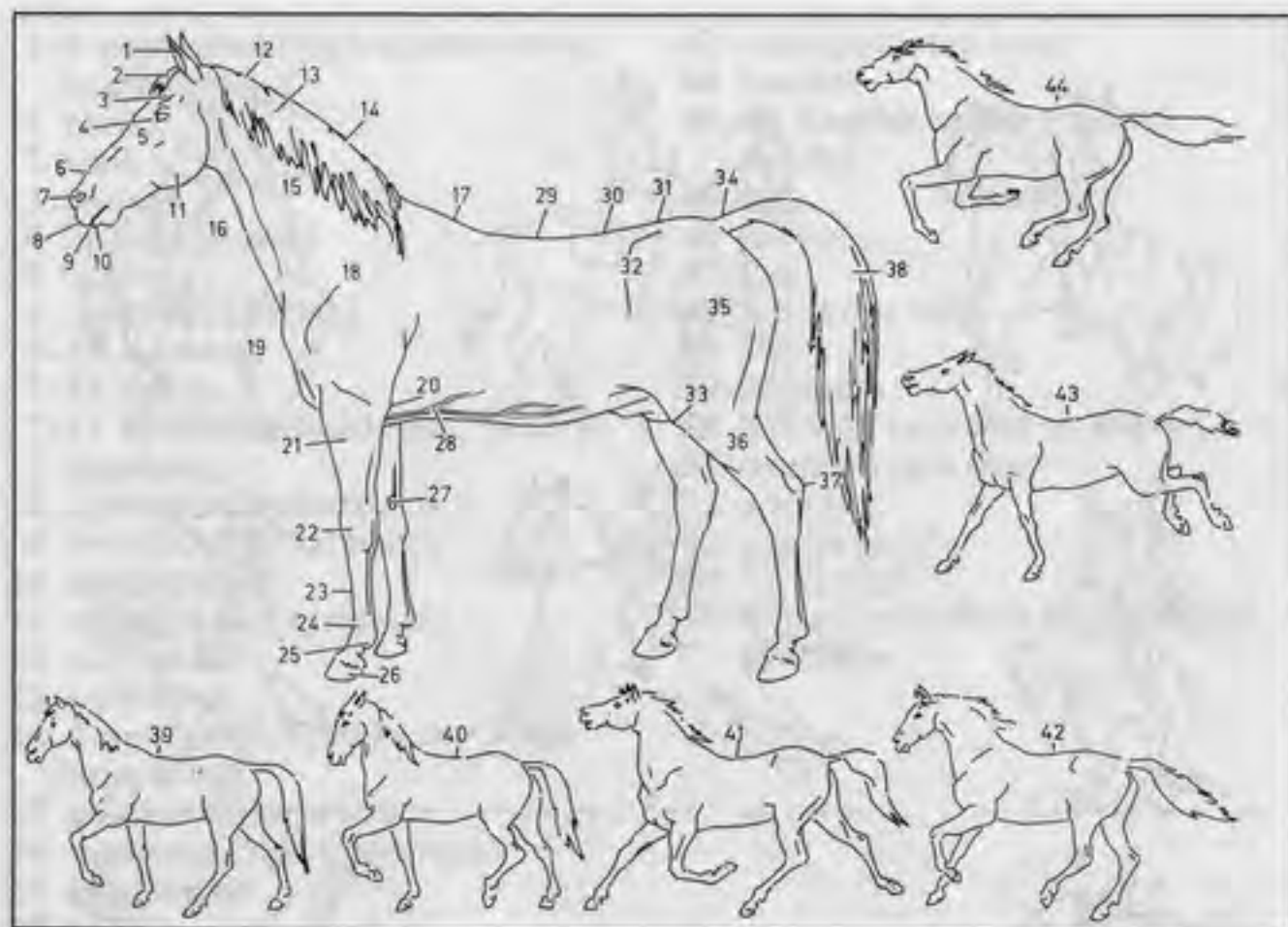

**1-38 points of the horse****1-11 head (horse's head)**

- 1 ear
- 2 forelock
- 3 forehead
- 4 eye
- 5 face
- 6 nose
- 7 nostril
- 8 upper lip
- 9 mouth
- 10 underlip (lower lip)
- 11 lower jaw
- 12 crest (neck)
- 13 mane (horse's mane)
- 14 crest (horse's crest)
- 15 neck
- 16 throat (*Am.* throatlatch, throatlash)
- 17 withers
- 18-27 forehand
- 18 shoulder
- 19 breast
- 20 elbow
- 21 forearm
- 22-26 forefoot
- 22 knee (carpus, wrist)
- 23 cannon

**24 fetlock**

- 25 pastern
- 26 hoof
- 27 chestnut (castor), a callosity
- 28 spur vein
- 29 back
- 30 loins (lumbar region)
- 31 croup (rump, crupper)
- 32 hip

**33-37 hind leg**

- 33 stifle (stifle joint)
- 34 root (dock) of the tail
- 35 haunch
- 36 gaskin
- 37 hock
- 38 tail

**39-44 gaits of the horse**

- 39 walk
- 40 pace
- 41 trot
- 42 canter (hand gallop)
- 43-44 full gallop
- 43 full gallop at the moment of descent on to the two forefeet
- 44 full gallop at the moment when all four feet are off the ground

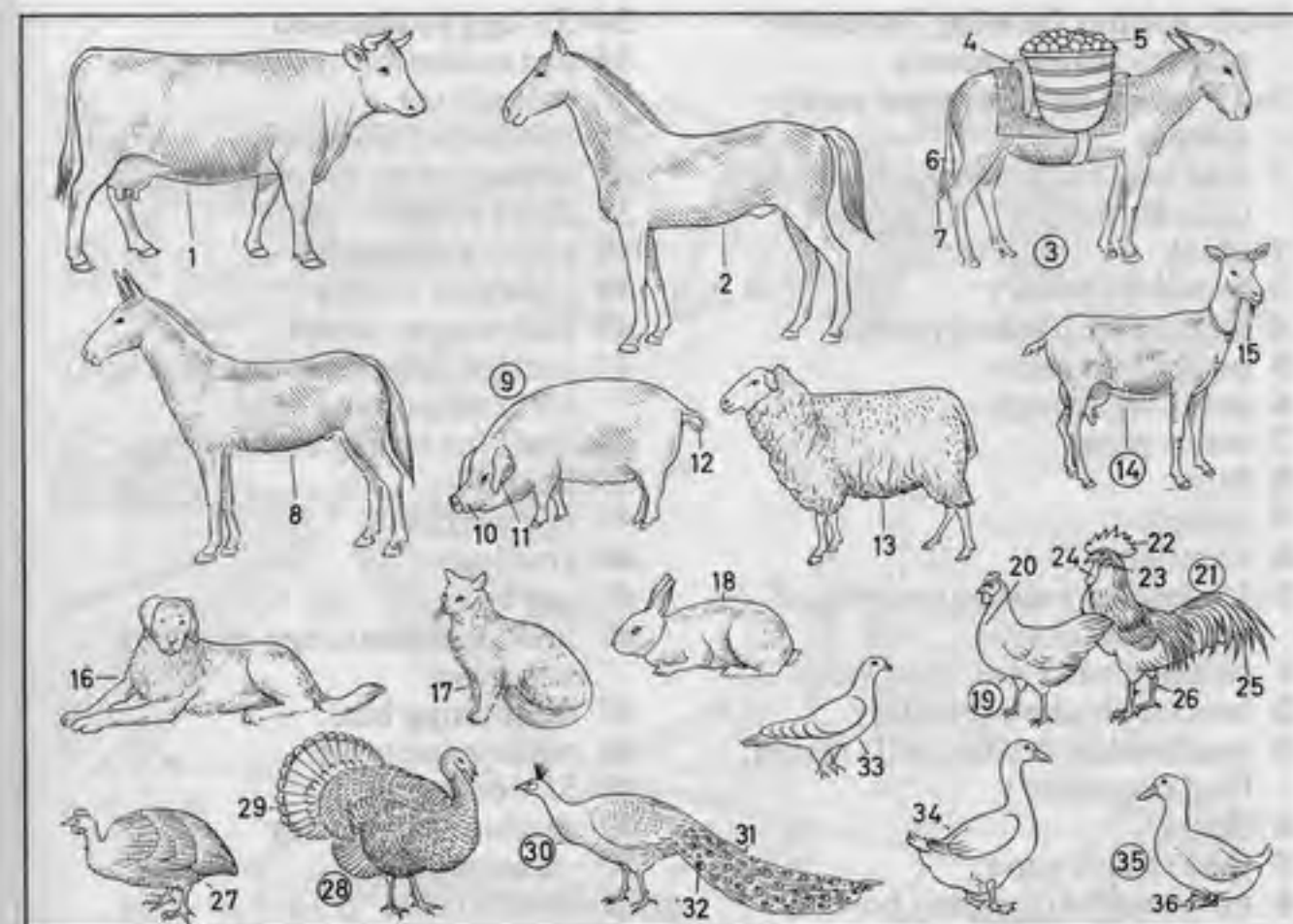
**Abbreviations:**

- *m.* = male; *c.* = castrated; *f.* = female; *y.* = young
- 1-2 cattle
- 1 cow, a ruminant; *m.* bull; *c.* ox; *f.* cow; *y.* calf
- 2 horse; *m.* stallion; *c.* gelding; *f.* mare; *y.* foal
- 3 donkey
- 4 pack saddle (carrying saddle)
- 5 pack (load)
- 6 tufted tail
- 7 tuft
- 8 mule, a cross between a male donkey and a mare
- 9 pig, a cloven-hoofed animal; *m.* boar; *f.* sow; *y.* piglet
- 10 pig's snout (snout)
- 11 pig's ear
- 12 curly tail
- 13 sheep; *m.* ram; *c.* wether; *f.* ewe; *y.* lamb
- 14 goat
- 15 goat's beard
- 16 dog, a Leonberger; *m.* dog; *f.* bitch; *y.* pup (puppy, whelp)
- 17 cat, an Angora cat (Persian cat); *m.* tom (tom cat)

**18-36 small domestic animals**

- 18 rabbit; *m.* buck; *f.* doe
- 19-36 poultry (domestic fowl)
- 19-26 chicken
- 19 hen
- 20 crop (crop)
- 21 cock (*Am.* rooster); *c.* capon
- 22 cockscomb (comb, crest)
- 23 lap
- 24 wattle (gill, dewlap)
- 25 falcate (falcated) tail
- 26 spur
- 27 guinea fowl
- 28 turkey; *m.* turkey cock (gobbler); *f.* turkey hen
- 29 fan tail
- 30 peacock
- 31 peacock's feather
- 32 eye (ocellus)
- 33 pigeon; *m.* cock pigeon
- 34 goose; *m.* gander; *y.* gosling
- 35 duck; *m.* drake; *y.* duckling
- 36 web (palmations) of webbed foot (palmate foot)



## 1-27 poultry farming (intensive poultry management)

## 1-17 straw yard (strawed yard) system

- 1 fold unit for growing stock (chick unit)
- 2 chick
- 3 brooder (hover)
- 4 adjustable feeding trough
- 5 pullet fold unit
- 6 drinking trough
- 7 water pipe
- 8 litter
- 9 pullet
- 10 ventilator
- 11-17 broiler rearing (rearing of broiler chickens)
- 11 chicken run (*Am.* fowl run)
- 12 broiler chicken (broiler)
- 13 mechanical feeder (self-feeder, feed dispenser)
- 14 chain
- 15 feed supply pipe
- 16 mechanical drinking bowl (mechanical drinker)
- 17 ventilator
- 18 battery system (cage system)
- 19 battery (laying battery)
- 20 tiered cage (battery cage, stepped cage)
- 21 feeding trough
- 22 egg collection by conveyor
- 23-27 mechanical feeding and dunging (manure removal, droppings removal)
- 23 rapid feeding system for battery feeding (mechanical feeder)
- 24 feed hopper
- 25 endless-chain conveyor (chain feeder)
- 26 water pipe (liquid feed pipe)
- 27 dunging chain (dunging conveyor)
- 28 [cabinet type] setting and hatching machine
- 29 ventilation drum [for the setting compartment]
- 30 hatching compartment (hatcher)
- 31 metal trolley for hatching trays
- 32 hatching tray
- 33 ventilation drum motor

## 34-53 egg production

- 34 egg collection system (egg collection)
- 35 multi-tier transport
- 36 collection by pivoted fingers
- 37 drive motor
- 38 sorting machine
- 39 conveyor trolley
- 40 fluorescent screen
- 41 suction apparatus (suction box) for transporting eggs
- 42 shelf for empty and full egg boxes
- 43 egg weighers
- 44 grading
- 45 egg box
- 46 fully automatic egg-packing machine
- 47 radioscope box
- 48 radioscope table
- 49-51 feeder
- 49 suction transporter
- 50 vacuum line
- 51 supply table
- 52 automatic counting and grading
- 53 packing box dispenser
- 54 leg ring
- 55 wing tally (identification tally)
- 56 bantam
- 57 laying hen
- 58 hen's egg (egg)
- 59 eggshell, an egg integument
- 60 shell membrane
- 61 air space
- 62 white [of the egg] (albumen)
- 63 chalaza (*Am.* treadle)
- 64 vitelline membrane (yolk sac)
- 65 blastodisc (germinal disc, cock's tread, cock's treadle)
- 66 germinal vesicle
- 67 white
- 68 yolk

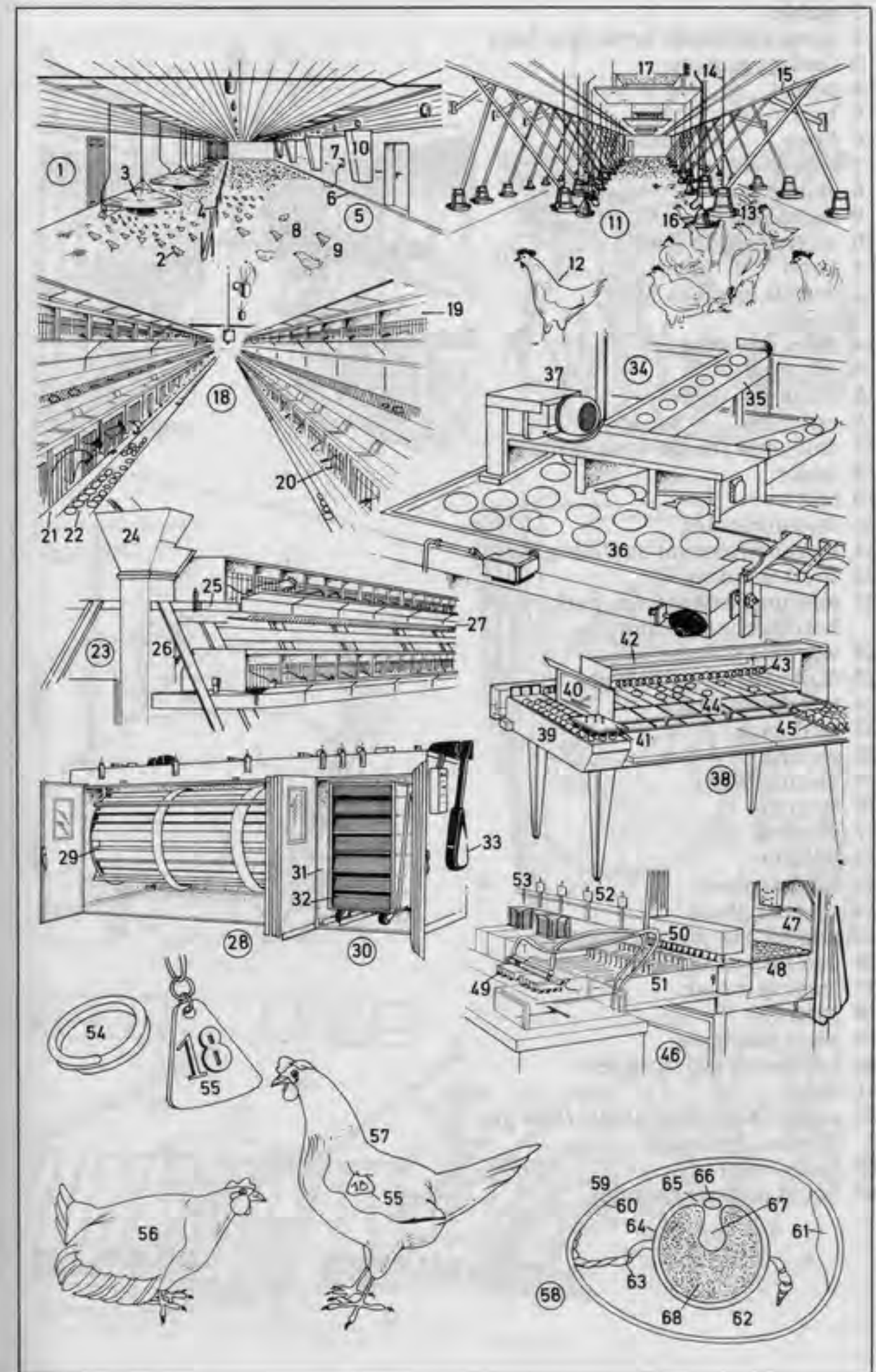



- 1 stable
- 2 horse stall (stall, horse box, box)
- 3 feeding passage
- 4 pony
- 5 bars
- 6 litter
- 7 bale of straw
- 8 ceiling light
- 9 sheep pen
- 10 mother sheep (ewe)
- 11 lamb
- 12 double hay rack
- 13 hay
- 14 dairy cow shed
- 15-16 tether
- 15 chain
- 16 rail
- 17 dairy cow (milch-cow, milker)
- 18 udder
- 19 teat
- 20 manure gutter
- 21 manure removal by sliding bars
- 22 short standing
- 23 milking parlour (*Am.* parlor), a herringbone parlour
- 24 working passage
- 25 milker (*Am.* milkman)
- 26 teat cup cluster
- 27 milk pipe
- 28 air line
- 29 vacuum line
- 30 teat cup
- 31 window
- 32 pulsator
- 33 release phase
- 34 squeeze phase
- 35 pigsty (*Am.* pigpen, hogpen)
- 36 pen for young pigs
- 37 feeding trough
- 38 partition
- 39 pig, a young pig
- 40 farrowing and store pen
- 41 sow
- 42 piglet (*Am.* shoat, shote) (sow pig [for first 8 weeks])
- 43 farrowing rails
- 44 liquid manure channel

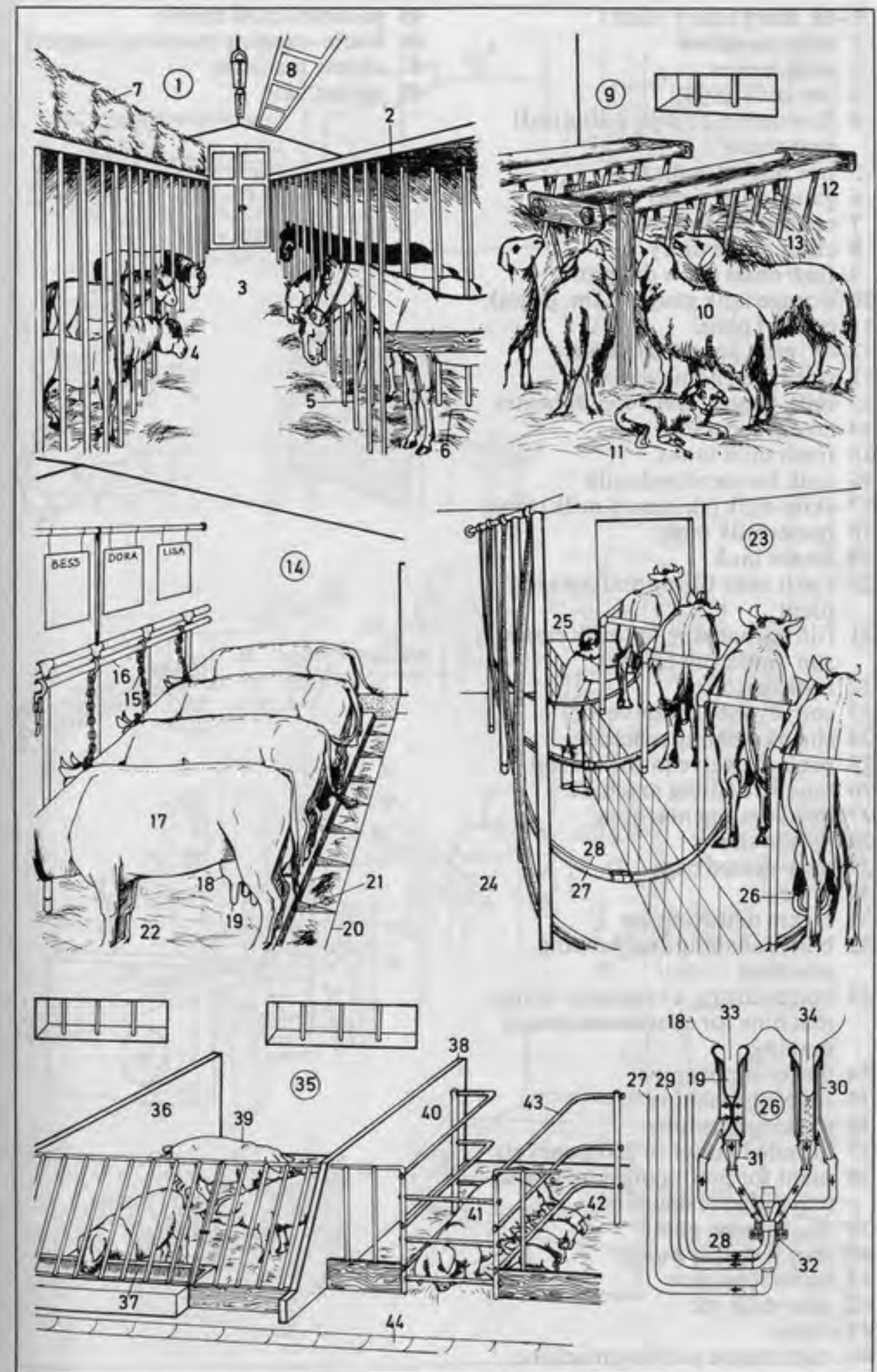



- 1-48 dairy (dairy plant)
- 1 milk reception
  - 2 milk tanker
  - 3 raw milk pump
  - 4 flowmeter, an oval (elliptical) gear meter
  - 5 raw milk storage tank
  - 6 gauge (Am. gage)
  - 7 central control room
  - 8 chart of the dairy
  - 9 flow chart (flow diagram)
  - 10 storage tank gauges (Am. gages)
  - 11 control panel
  - 12-48 milk processing area
  - 12 sterilizer (homogenizer)
  - 13 milk heater; *sim.*: cream heater
  - 14 cream separator
  - 15 fresh milk tanks
  - 16 tank for sterilized milk
  - 17 skim milk (skimmed milk) tank
  - 18 buttermilk tank
  - 19 cream tank
  - 20 fresh milk filling and packing plant
  - 21 filling machine for milk cartons; *sim.*: milk tub filler
  - 22 milk carton
  - 23 conveyor belt (conveyor)
  - 24 shrink-sealing machine
  - 25 pack of twelve in shrink foil
  - 26 ten-litre filling machine
  - 27 heat-sealing machine
  - 28 plastic sheets
  - 29 heat-sealed bag
  - 30 crate
  - 31 cream maturing vat
  - 32 butter shaping and packing machine
  - 33 butter churn, a creamery butter machine for continuous butter making
  - 34 butter supply pipe
  - 35 shaping machine
  - 36 packing machine
  - 37 branded butter in 250 g packets
  - 38 plant for producing curd cheese (curd cheese machine)
  - 39 curd cheese pump
  - 40 cream supply pump
  - 41 curds separator
  - 42 sour milk vat
  - 43 stirrer
  - 44 curd cheese packing machine

- 45 packeted curd cheese
- 46 bottle-capping machine (capper)
- 47 cheese machine
- 48 rennet vat

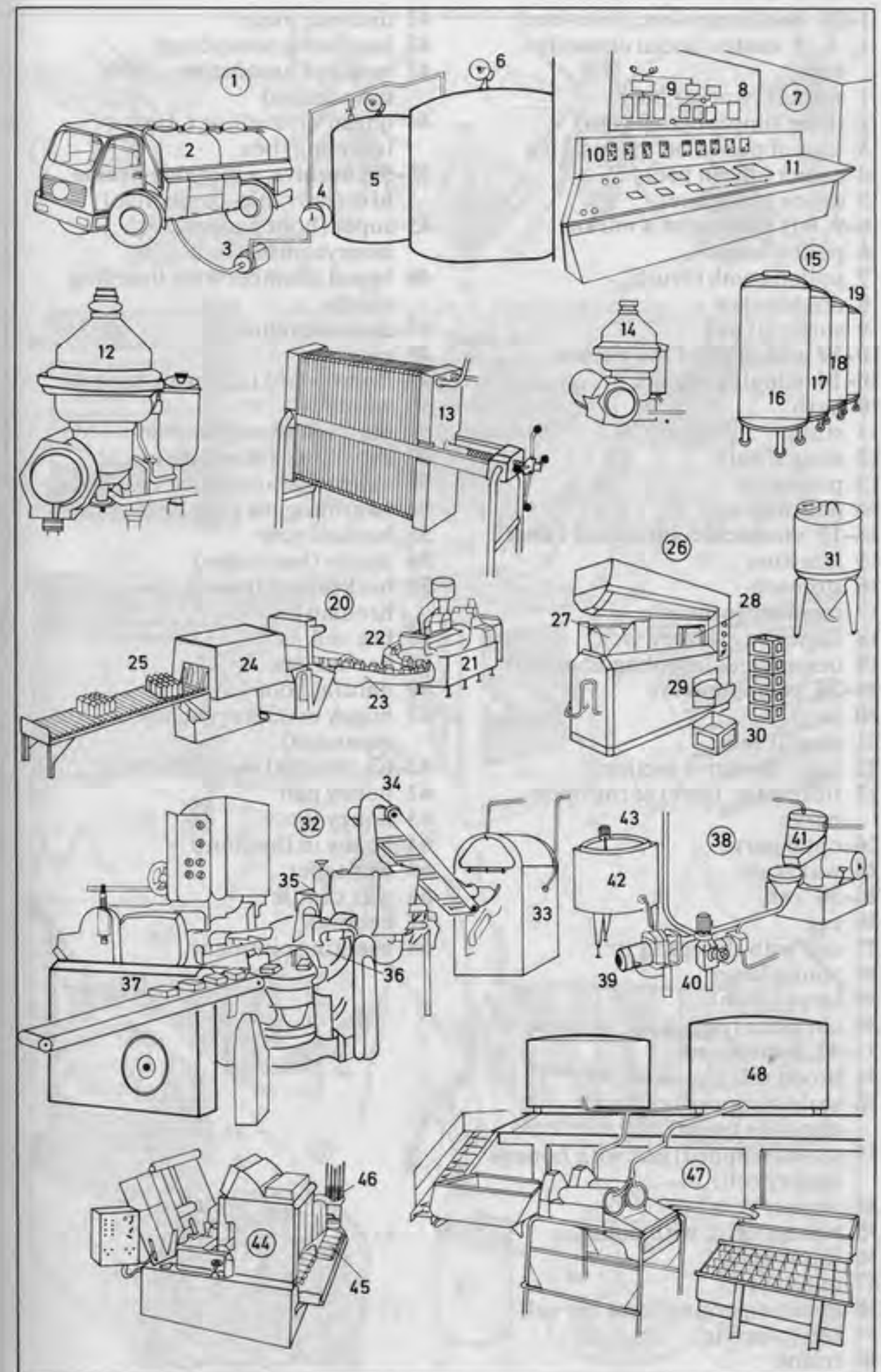



- 1-25 bee (honey-bee, hive-bee)  
 1, 4, 5 castes (social classes) of bees  
 1 worker (worker bee)  
 2 three simple eyes (ocelli)  
 3 load of pollen on the hind leg  
 4 queen (queen bee)  
 5 drone (male bee)  
 6-9 left hind leg of a worker  
 6 pollen basket  
 7 pollen comb (brush)  
 8 double claw  
 9 suctorial pad  
 10-19 abdomen of the worker  
 10-14 stinging organs  
 10 barb  
 11 sting  
 12 sting sheath  
 13 poison sac  
 14 poison gland  
 15-19 stomachic-intestinal canal  
 15 intestine  
 16 stomach  
 17 contractile muscle  
 18 honey bag (honey sac)  
 19 oesophagus (esophagus, gullet)  
 20-24 compound eye  
 20 facet  
 21 crystal cone  
 22 light-sensitive section  
 23 fibre (*Am.* fiber) of the optic nerve  
 24 optic nerve  
 25 wax scale  
 26-30 cell  
 26 egg  
 27 cell with the egg in it  
 28 young larva  
 29 larva (grub)  
 30 chrysalis (pupa)  
 31-43 honeycomb  
 31 brood cell  
 32 sealed (capped) cell with chrysalis (pupa)  
 33 sealed (capped) cell with honey (honey cell)  
 34 worker cells  
 35 storage cells, with pollen  
 36 drone cells  
 37 queen cell  
 38 queen emerging from her cell  
 39 cap (capping)  
 40 frame

- 41 distance piece  
 42 [artificial] honeycomb  
 43 septum (foundation, comb foundation)  
 44 queen's travelling (*Am.* traveling) box  
 45-50 beehive, a movable-frame hive (movable-comb hive)  
 45 super (honey super) with honeycombs  
 46 brood chamber with breeding combs  
 47 queen-excluder  
 48 entrance  
 49 flight board (alighting board)  
 50 window  
 51 old-fashioned bee shed  
 52 straw hive (skep), a hive  
 53 swarm (swarm cluster) of bees  
 54 swarming net (bag net)  
 55 hooked pole  
 56 apiary (bee house)  
 57 beekeeper (apiarist, *Am.* beeman)  
 58 bee veil  
 59 bee smoker  
 60 natural honeycomb  
 61 honey extractor (honey separator)  
 62-63 strained honey (honey)  
 62 honey pail  
 63 honey jar  
 64 honey in the comb  
 65 wax taper  
 66 wax candle  
 67 beeswax  
 68 bee sting ointment

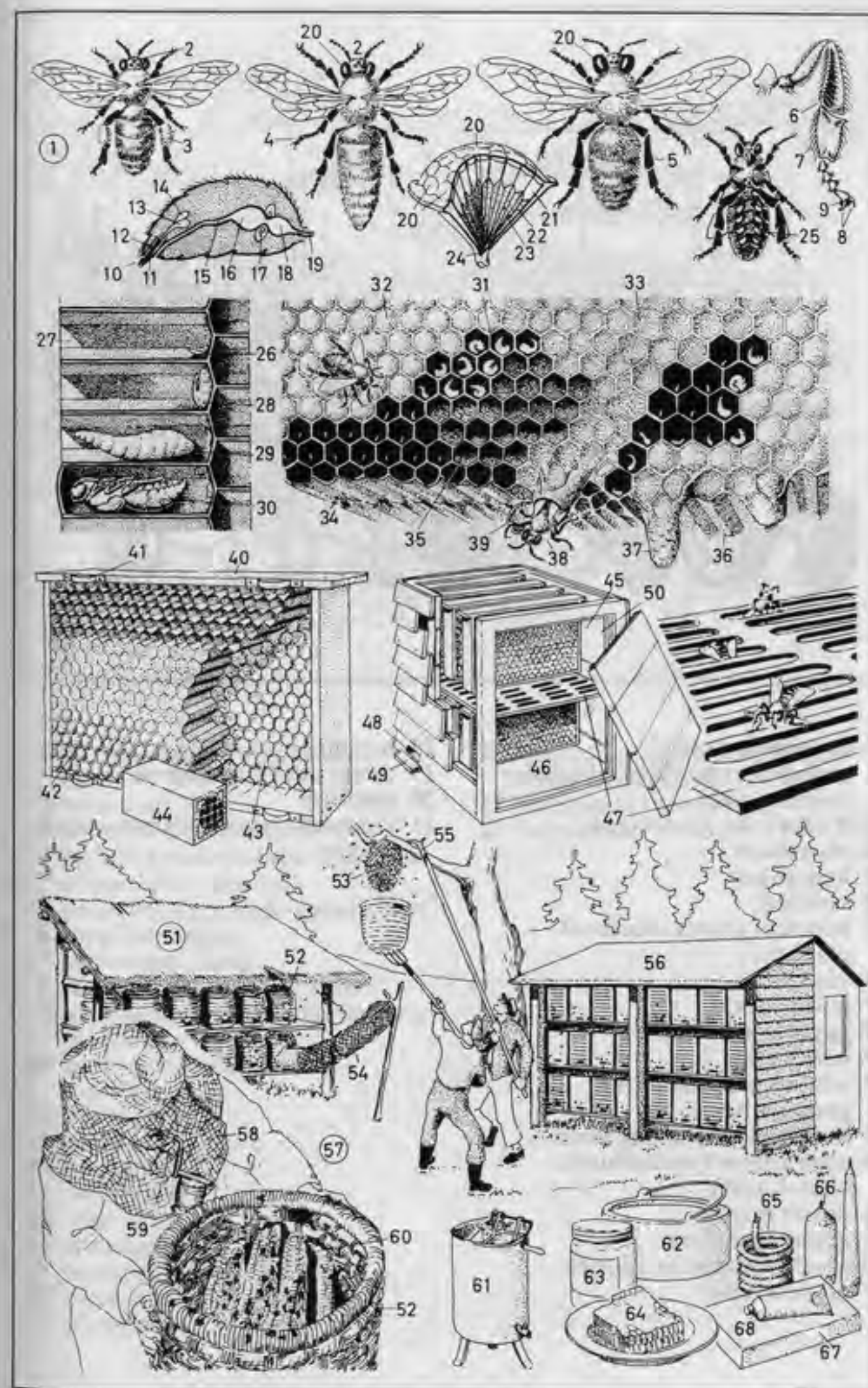



**1-21 vineyard area**

- 1 vineyard using wire trellises for training vines
- 2-9 **vine** (*Am.* grapevine)
  - 2 vine shoot
  - 3 long shoot
  - 4 vine leaf
  - 5 bunch of grapes (cluster of grapes)
  - 6 vine stem
  - 7 post (stake)
  - 8 guy (guy wire)
  - 9 wire trellis
- 10 tub for grape gathering
- 11 grape gatherer
- 12 secateurs for pruning vines
- 13 wine grower (viniculturist, viticulturist)
- 14 dossier carrier
- 15 dossier (pannier)
- 16 crushed grape transporter
- 17 grape crusher
- 18 hopper
- 19 three-sided flap extension
- 20 platform
- 21 vineyard tractor, a narrow-track tractor

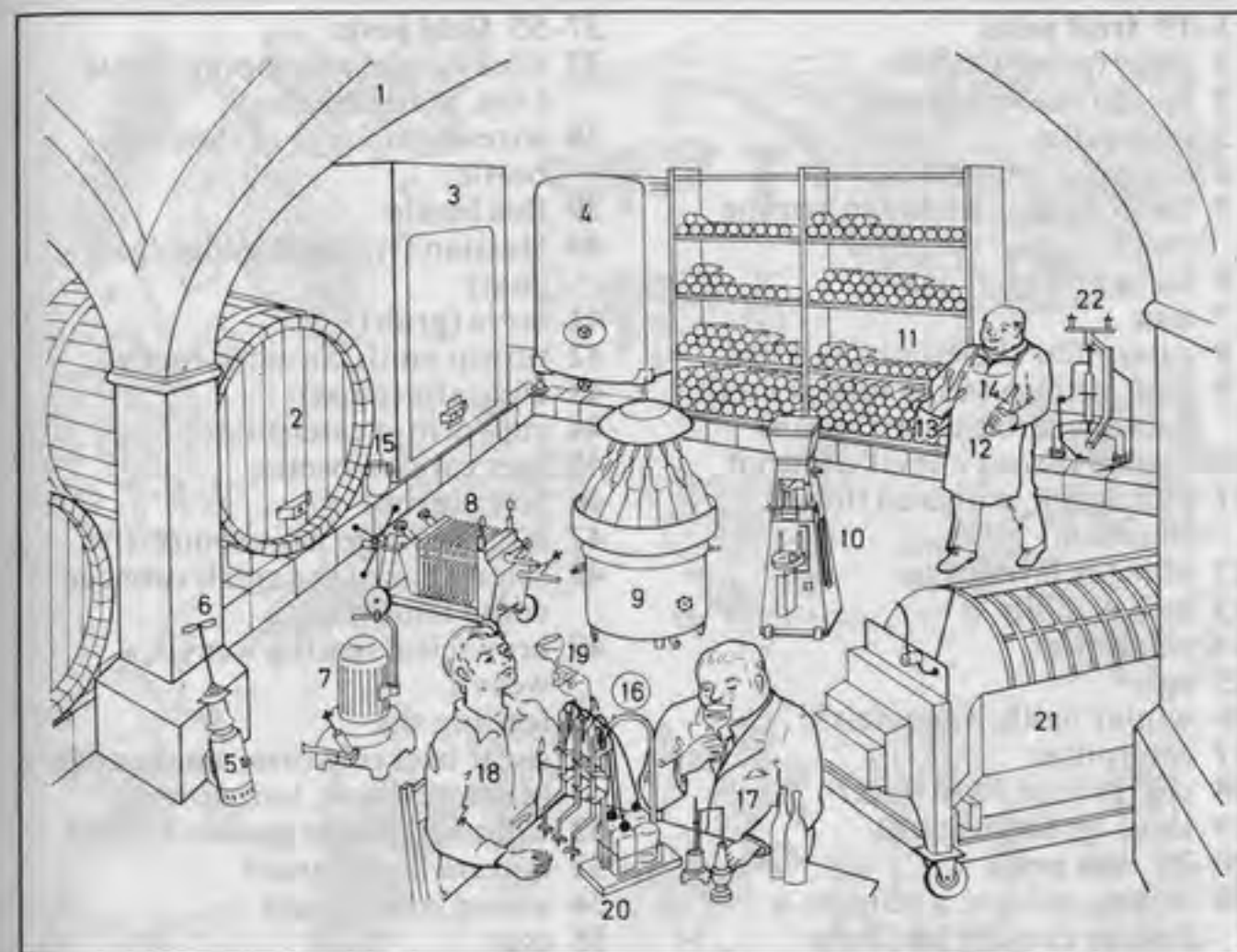
**1-22 wine cellar (wine vault)**

- 1 vault
- 2 wine cask
- 3 wine vat, a concrete vat
- 4 stainless steel vat (*also*: vat made of synthetic material)
- 5 propeller-type high-speed mixer
- 6 propeller mixer
- 7 centrifugal pump
- 8 stainless steel sediment filter
- 9 semi-automatic circular bottling machine
- 10 semi-automatic corking machine
- 11 bottle rack
- 12 cellarer's assistant
- 13 bottle basket
- 14 wine bottle
- 15 wine jug
- 16 wine tasting
- 17 head cellarman
- 18 cellarman
- 19 wineglass
- 20 inspection apparatus [for spot-checking samples]
- 21 horizontal wine press
- 22 humidifier



## 1-19 fruit pests

- 1 gipsy (gypsy) moth
- 2 batch (cluster) of eggs
- 3 caterpillar
- 4 chrysalis (pupa)
- 5 small ermine moth, an ermine moth
- 6 larva (grub)
- 7 tent
- 8 caterpillar skeletonizing a leaf
- 9 fruit surface eating tortrix moth (summer fruit tortrix moth)
- 10 appleblossom weevil, a weevil
- 11 punctured, withered flower (blossom)
- 12 hole for laying eggs
- 13 lackey moth
- 14 caterpillar
- 15 eggs
- 16 winter moth, a geometrid
- 17 caterpillar
- 18 cherry fruit fly, a borer
- 19 larva (grub, maggot)

## 37-55 field pests

- 20-27 vine pests
- 20 downy mildew, a mildew, a disease causing leaf drop
- 21 grape affected with downy mildew
- 22 grape-berry moth
- 23 first-generation larva of the grape-berry moth (*Am. grape worm*)
- 24 second-generation larva of the grape-berry moth (*Am. grape worm*)
- 25 chrysalis (pupa)
- 26 root louse, a grape phylloxera
- 27 root gall (knotty swelling of the root, nodosity, tuberosity)
- 28 brown-tail moth
- 29 caterpillar
- 30 batch (cluster) of eggs
- 31 hibernation cocoon
- 32 woolly apple aphid (*American blight*), an aphid
- 33 gall caused by the woolly apple aphid
- 34 woolly apple aphid colony
- 35 San-José scale, a scale insect (scale louse)
- 36 larvae (grubs) [*male elongated, female round*]
- 37 click beetle, a snapping beetle (*Am. snapping bug*)
- 38 wireworm, larva of the click beetle
- 39 flea beetle
- 40 Hessian fly, a gall midge (gall gnat)
- 41 larva (grub)
- 42 turnip moth, an earth moth
- 43 chrysalis (pupa)
- 44 cutworm, a caterpillar
- 45 beet carrion beetle
- 46 larva (grub)
- 47 large cabbage white butterfly
- 48 caterpillar of the small cabbage white butterfly
- 49 brown leaf-eating weevil, a weevil
- 50 feeding site
- 51 sugar beet eelworm, a nematode (a threadworm, hairworm)
- 52 Colorado beetle (potato beetle)
- 53 mature larva (grub)
- 54 young larva (grub)
- 55 eggs

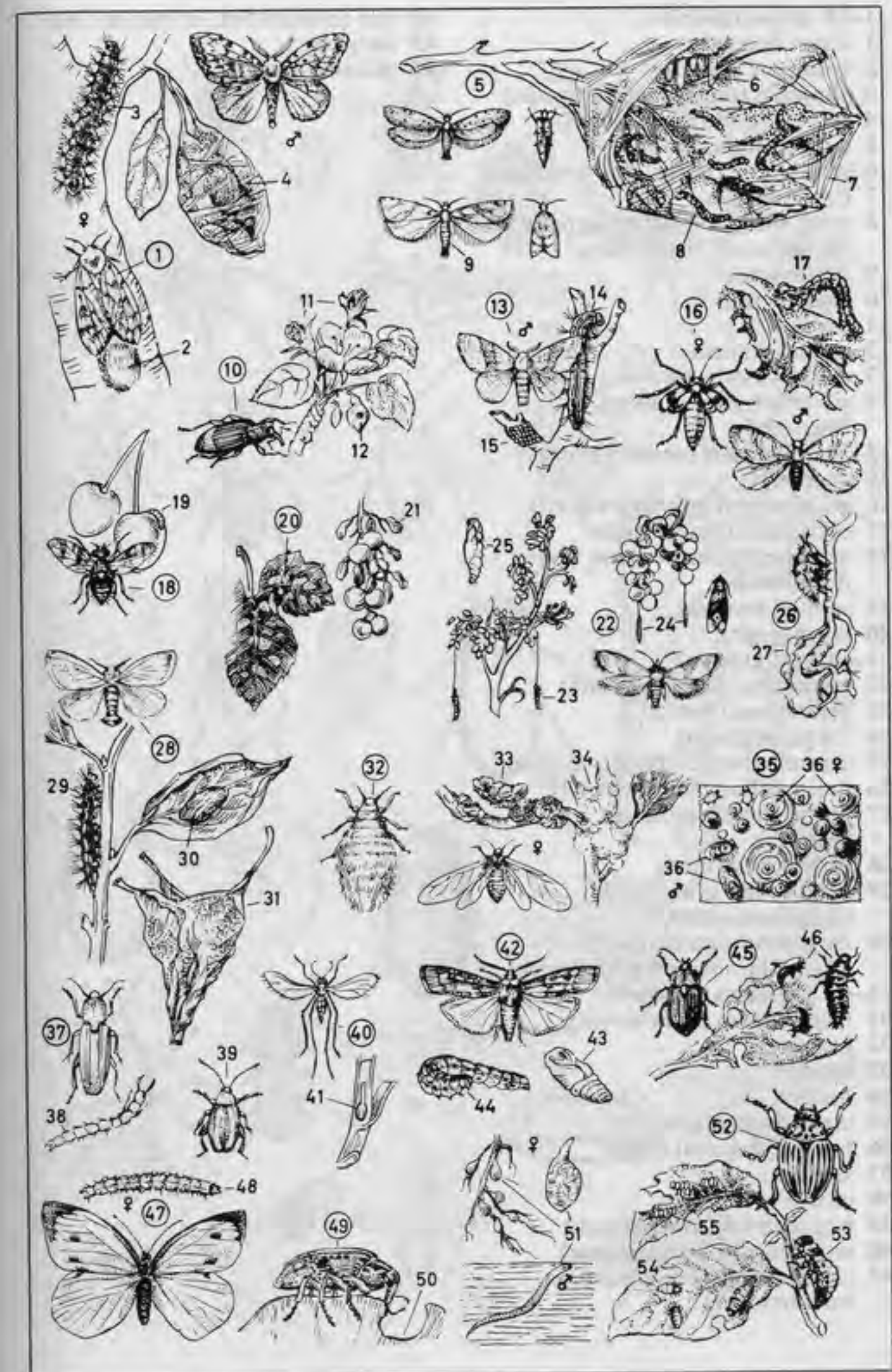



## 1-14 house insects

- 1 lesser housefly
- 2 common housefly
- 3 chrysalis (pupa, coarctate pupa)
- 4 stable fly (biting housefly)
- 5 trichotomous antenna
- 6 wood louse (slater, *Am.* sow bug)
- 7 house cricket
- 8 wing with stridulating apparatus (stridulating mechanism)
- 9 house spider
- 10 spider's web
- 11 earwig
- 12 caudal pincers
- 13 clothes moth, a moth
- 14 silverfish (*Am.* slicker), a bristletail

## 15-30 food pests (pests to stores)

- 15 cheese fly
- 16 grain weevil (granary weevil)
- 17 cockroach (black beetle)
- 18 meal beetle (meal worm beetle, flour beetle)
- 19 spotted bruchus
- 20 larva (grub)
- 21 chrysalis (pupa)
- 22 leather beetle (hide beetle)
- 23 yellow meal beetle
- 24 chrysalis (pupa)
- 25 cigarette beetle (tobacco beetle)
- 26 maize billbug (corn weevil)
- 27 one of the *Cryptolestes*, a grain pest
- 28 Indian meal moth
- 29 Angoumois grain moth (Angoumois moth)
- 30 Angoumois grain moth caterpillar inside a grain kernel

## 31-42 parasites of man

- 31 round worm (maw worm)
- 32 female
- 33 head
- 34 male
- 35 tapeworm, a flatworm
- 36 head, a suckorial organ
- 37 sucker
- 38 crown of hooks
- 39 bug (bed bug, *Am.* chinch)
- 40 crab louse (a human louse)
- 41 clothes louse (body louse, a human louse)

## 42 flea (human flea, common flea)

- 43 tsetse fly
- 44 malaria mosquito

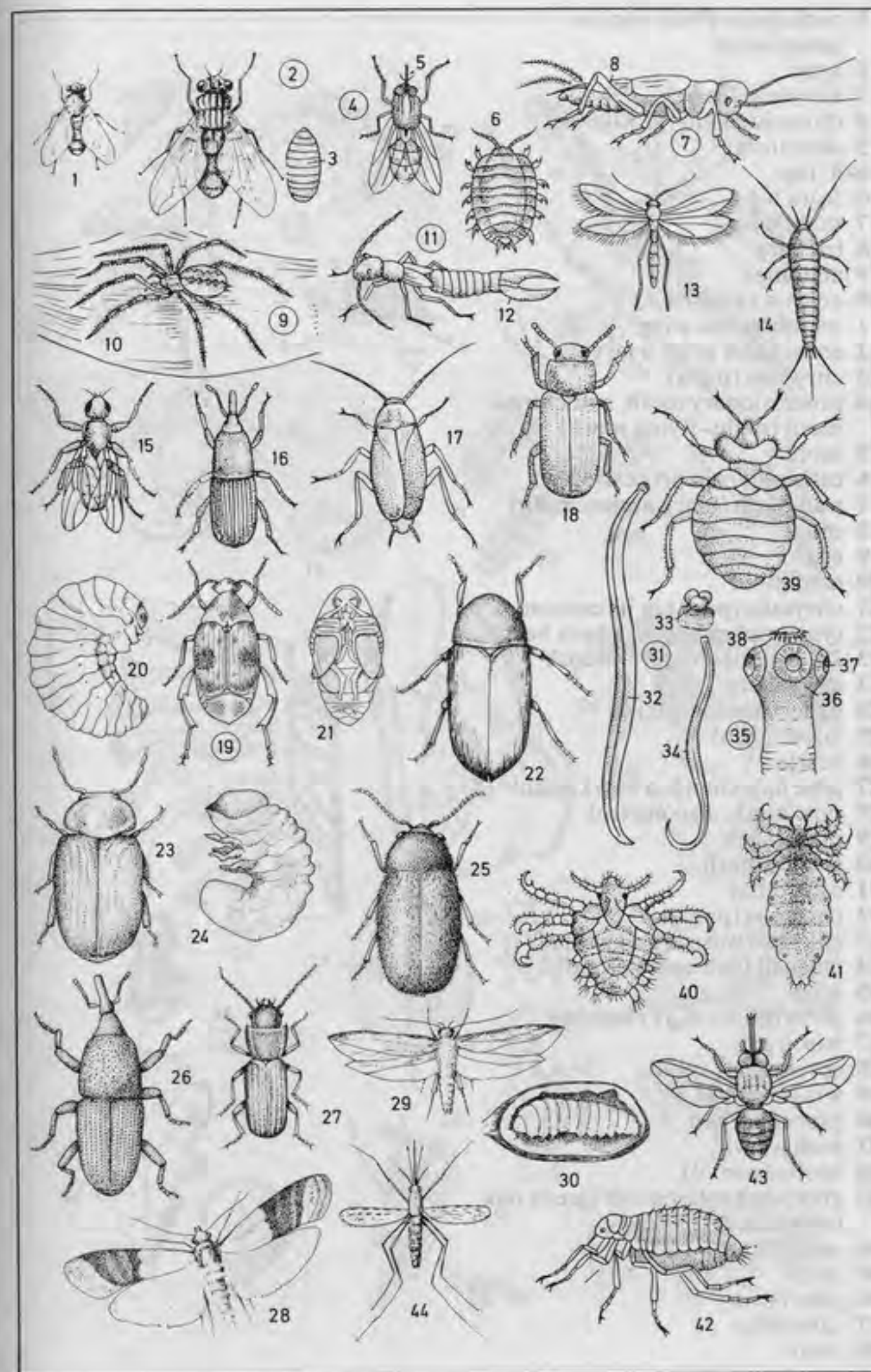



- 1 cockchafer (May bug), a lamellicorn
- 2 head
- 3 antenna (feeler)
- 4 thoracic shield (prothorax)
- 5 scutellum
- 6-8 legs
- 6 front leg
- 7 middle leg
- 8 back leg
- 9 abdomen
- 10 elytron (wing case)
- 11 membranous wing
- 12 cockchafer grub, a larva
- 13 chrysalis (pupa)
- 14 processionary moth, a nocturnal moth (night-flying moth)
- 15 moth
- 16 caterpillars in procession
- 17 nun moth (black arches moth)
- 18 moth
- 19 eggs
- 20 caterpillar
- 21 chrysalis (pupa) in its cocoon
- 22 typographer beetle, a bark beetle
- 23-24 galleries under the bark
- 23 egg gallery
- 24 gallery made by larva
- 25 larva (grub)
- 26 beetle
- 27 pine hawkmoth, a hawkmoth
- 28 pine moth, a geometrid
- 29 male moth
- 30 female moth
- 31 caterpillar
- 32 chrysalis (pupa)
- 33 oak-gall wasp, a gall wasp
- 34 oak gall (oak apple), a gall
- 35 wasp
- 36 larva (grub) in its chamber
- 37 beech gall
- 38 spruce-gall aphid
- 39 winged aphid
- 40 pineapple gall
- 41 pine weevil
- 42 beetle (weevil)
- 43 green oak roller moth (green oak tortrix), a leaf roller
- 44 caterpillar
- 45 moth
- 46 pine beauty
- 47 caterpillar
- 48 moth

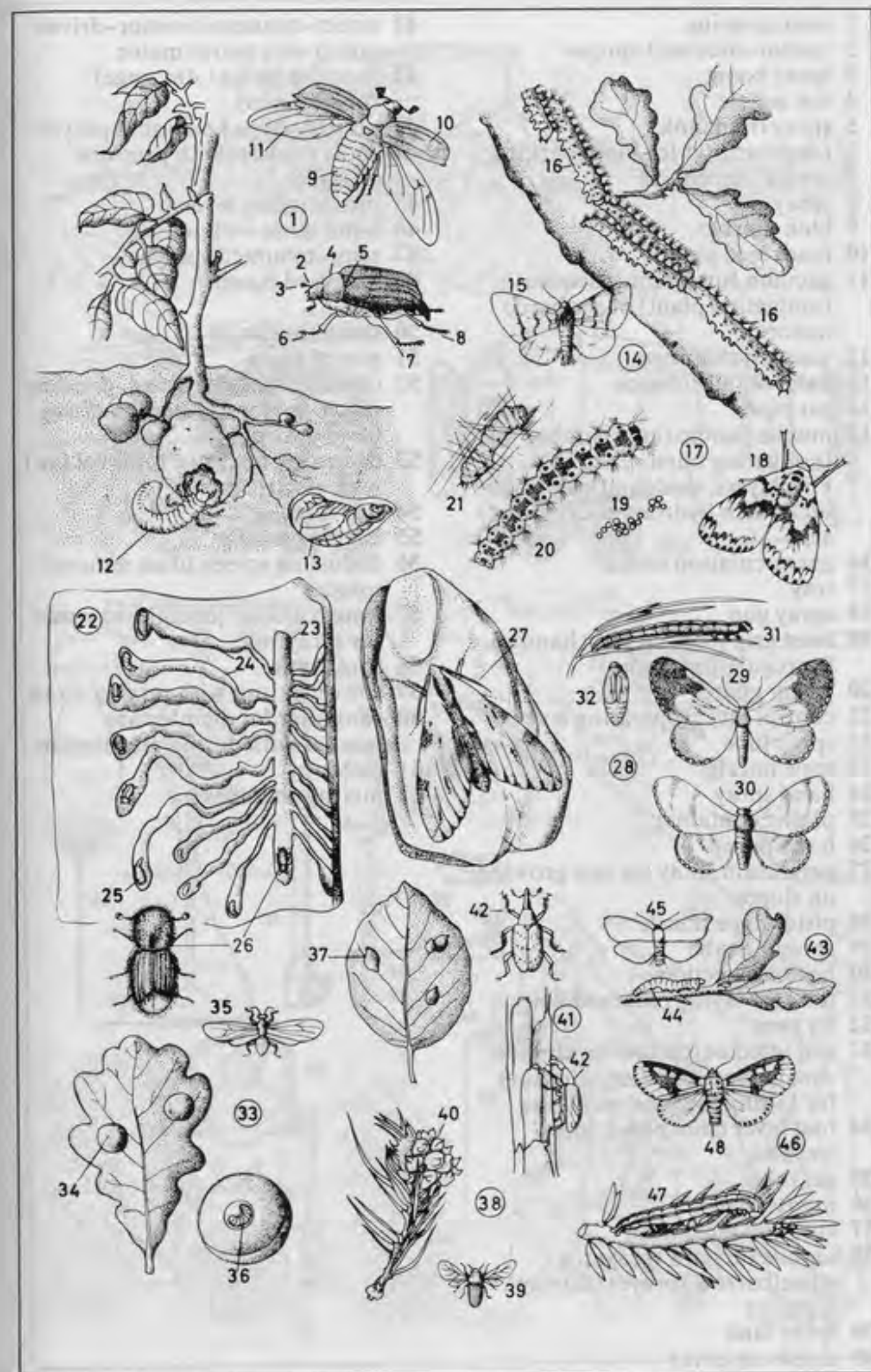



- 1 area spraying
- 2 tractor-mounted sprayer
- 3 spray boom
- 4 fan nozzle
- 5 spray fluid tank
- 6 foam canister for blob marking
- 7 spring suspension
- 8 spray
- 9 blob marker
- 10 foam feed pipe
- 11 vacuum fumigator (vacuum fumigation plant) of a tobacco factory
- 12 vacuum chamber
- 13 bales of raw tobacco
- 14 gas pipe
- 15 mobile fumigation chamber for fumigating nursery saplings, vine layers, seeds, and empty sacks with hydrocyanic (prussic) acid
- 16 gas circulation unit
- 17 tray
- 18 spray gun
- 19 twist grip (control grip, handle) for regulating the jet
- 20 finger guard
- 21 control lever (operating lever)
- 22 spray tube
- 23 cone nozzle
- 24 hand spray
- 25 plastic container
- 26 hand pump
- 27 pendulum spray for hop growing on slopes
- 28 pistol-type nozzle
- 29 spraying tube
- 30 hose connection
- 31 tube for laying poisoned bait
- 32 fly swat
- 33 soil injector (carbon disulphide, *Am.* carbon disulfide, injector) for killing the vine root louse
- 34 foot lever (foot pedal, foot treadle)
- 35 gas tube
- 36 mousetrap
- 37 vole and mole trap
- 38 mobile orchard sprayer, a wheelbarrow sprayer (carriage sprayer)
- 39 spray tank
- 40 screw-on cover
- 41 direct-connected motor-driven pump with petrol motor
- 42 pressure gauge (*Am.* gage) (manometer)
- 43 plunger-type knapsack sprayer
- 44 spray canister with pressure chamber
- 45 piston pump lever
- 46 hand lance with nozzle
- 47 semi-mounted sprayer
- 48 vineyard tractor
- 49 fan
- 50 spray fluid tank
- 51 row of vines
- 52 dressing machine (seed-dressing machine) for dry-seed dressing (seed dusting)
- 53 dedusting fan (dust removal fan) with electric motor
- 54 bag filter
- 55 bagging nozzle
- 56 dedusting screen (dust removal screen)
- 57 water canister [containing water for spraying]
- 58 spray unit
- 59 conveyor unit with mixing screw
- 60 container for disinfectant powder with dosing mechanism
- 61 castor
- 62 mixing chamber

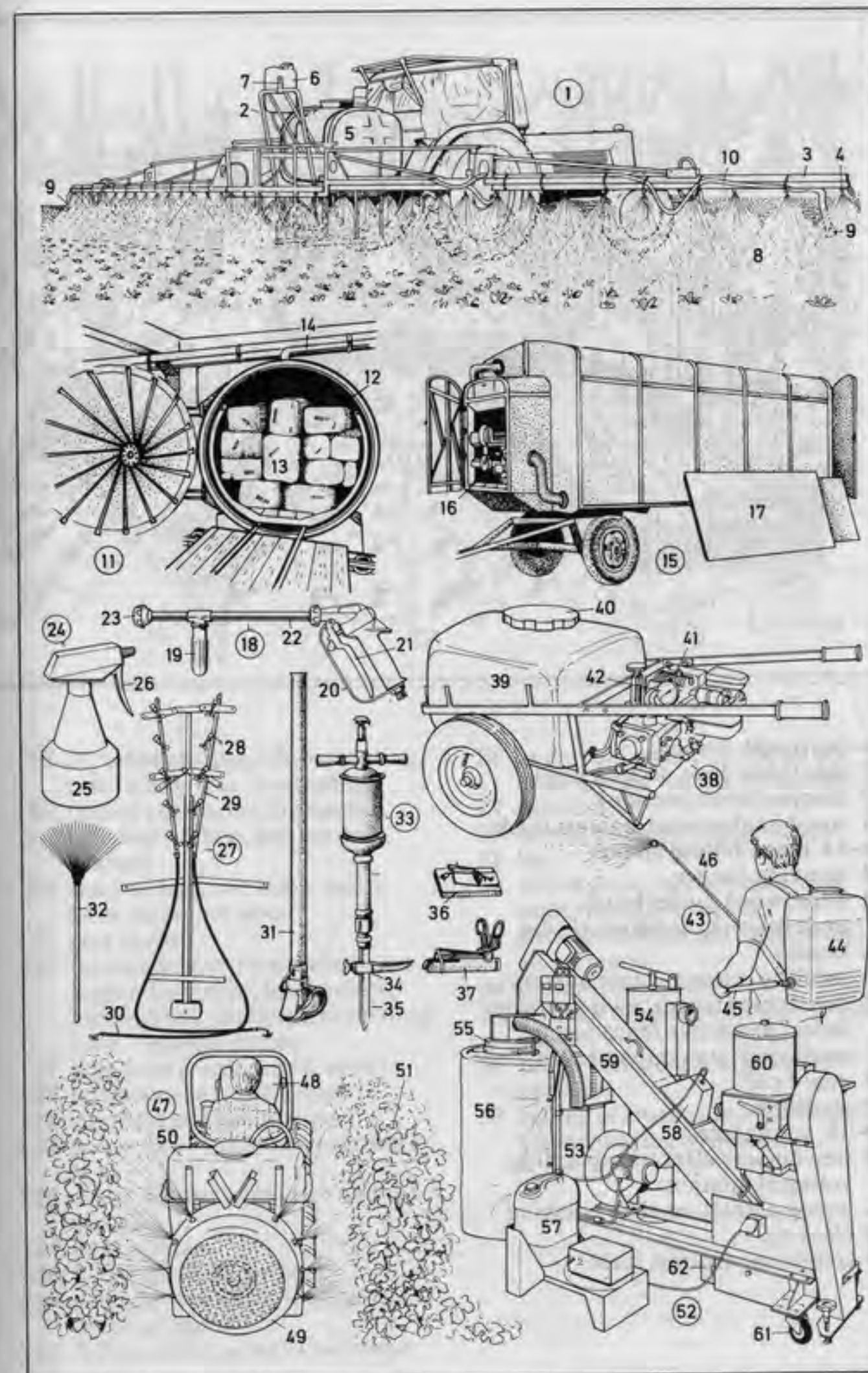







- 1 axe (*Am.* ax)
- 2 edge (cutting edge)
- 3 handle (helve)
- 4 felling wedge (falling wedge) with wood insert and ring
- 5 riving hammer (cleaving hammer, splitting hammer)
- 6 lifting hook
- 7 cant hook
- 8 barking iron (bark spud)
- 9 peavy
- 10 slide calliper (caliper) (calliper square)
- 11 billhook, a knife for lopping
- 12 revolving die hammer (marking hammer, marking iron, *Am.* marker)
- 13 power saw (motor saw)
- 14 saw chain
- 15 safety brake for the saw chain, with finger guard
- 16 saw guide
- 17 accelerator lock
- 18 snedding machine (trimming machine, *Am.* knotting machine, limbing machine)
- 19 feed rolls
- 20 flexible blade
- 21 hydraulic arm
- 22 trimming blade
- 23 debarking (barking, bark stripping) of boles
- 24 feed roller
- 25 cylinder trimmer
- 26 rotary cutter
- 27 short-haul skidder
- 28 loading crane
- 29 log grips
- 30 post
- 31 Ackermann steering system
- 32 log dump
- 33 number (identification number)
- 34 skidder
- 35 front blade (front plate)
- 36 crush-proof safety bonnet (*Am.* safety hood)
- 37 Ackermann steering system
- 38 cable winch
- 39 cable drum
- 40 rear blade (rear plate)
- 41 boles with butt ends held off the ground
- 42 haulage of timber by road
- 43 tractor (tractor unit)
- 44 loading crane
- 45 hydraulic jack
- 46 cable winch
- 47 post
- 48 bolster plate
- 49 rear bed (rear bunk)

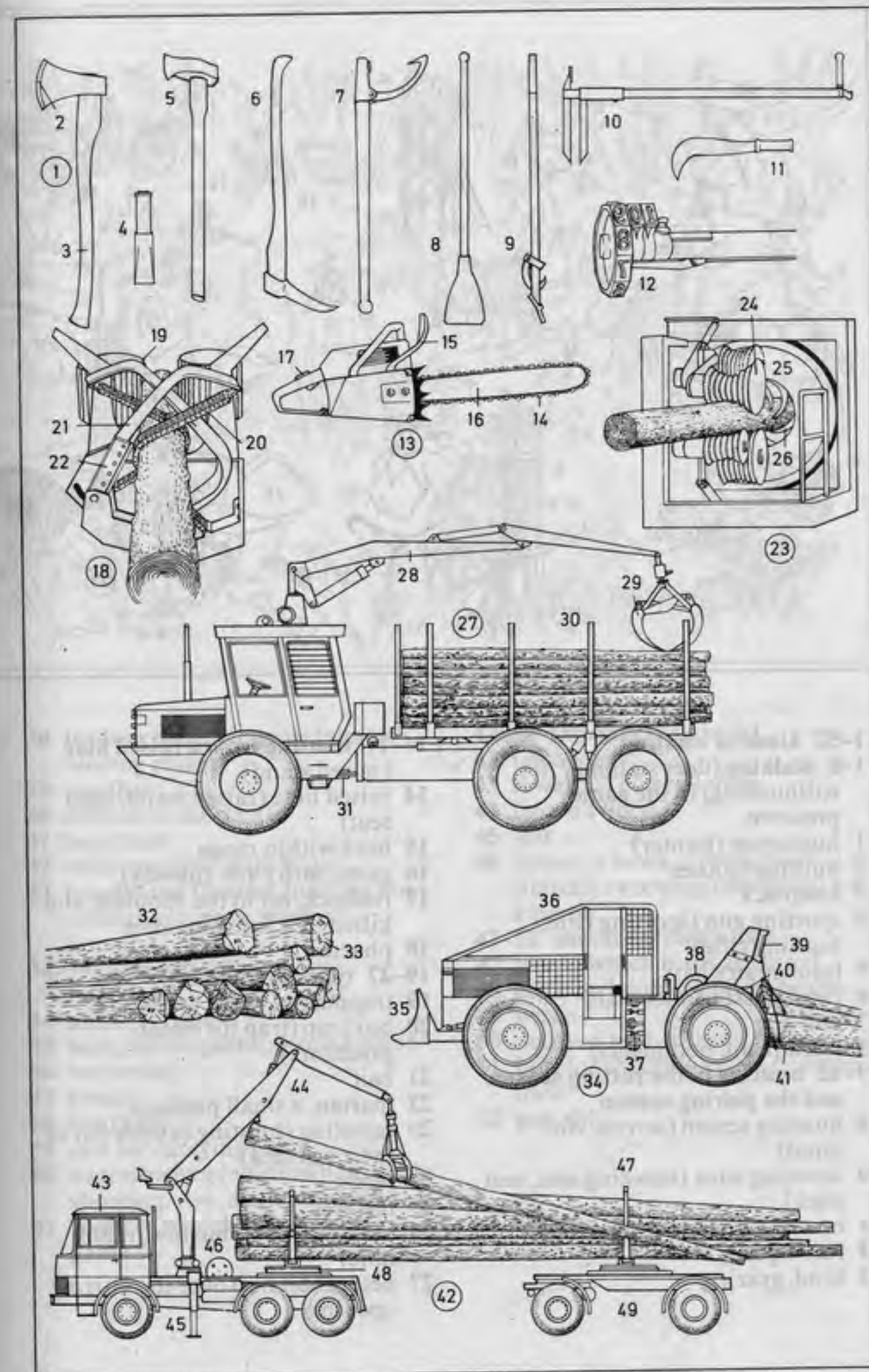



**1-52 kinds of hunting**

**1-8 stalking** (deer stalking, *Am.* stillhunting) in the game preserve

1 huntsman (hunter)

2 hunting clothes

3 knapsack

4 sporting gun (sporting rifle, hunting rifle)

5 huntsman's hat

6 field glasses, binoculars

7 gun dog

8 track (trail, hoofprints)

**9-12 hunting in the rutting season and the pairing season**

9 hunting screen (screen, *Am.* blind)

10 shooting stick (shooting seat, seat stick)

11 blackcock, displaying

12 rutting stag

13 hind, grazing

**14-17 hunting from a raised hide** (raised stand)

14 raised hide (raised stand, high seat)

15 herd within range

16 game path (*Am.* runway)

17 roebuck, hit in the shoulder and killed by a finishing shot

18 phaeton

**19-27 types of trapping**

19 trapping of small predators

20 box trap (trap for small predators)

21 bait

22 marten, a small predator

23 ferreting (hunting rabbits out of their warrens)

24 ferret

25 ferreter

26 burrow (rabbit burrow, rabbit hole)

27 net (rabbit net) over the burrow opening



28 feeding place for game (winter feeding place)

29 poacher

30 carbine, a short rifle

31 boar hunt

32 wild sow (sow, wild boar)

33 boarhound (hound, hunting dog; collectively: pack, pack of hounds)

**34-39 beating** (driving, hare hunting)

34 aiming position

35 hare, furred game, ground game

36 retrieving

37 beater

38 bag (kill)

39 cart for carrying game

40 waterfowling (wildfowling, duck shooting, *Am.* duck hunting)

41 flight of wild ducks, winged game

**42-46 falconry** (hawking)

42 falconer

43 reward, a piece of meat

44 falcon's hood

45 jess

46 falcon, a hawk, a male hawk (tiercel) swooping (stooping) on a heron

**47-52 shooting from a butt**

47 tree to which birds are lured

48 eagle owl, a decoy bird (decoy)

49 perch

50 decoyed bird, a crow

51 butt for shooting crows or eagle owls

52 gun slit

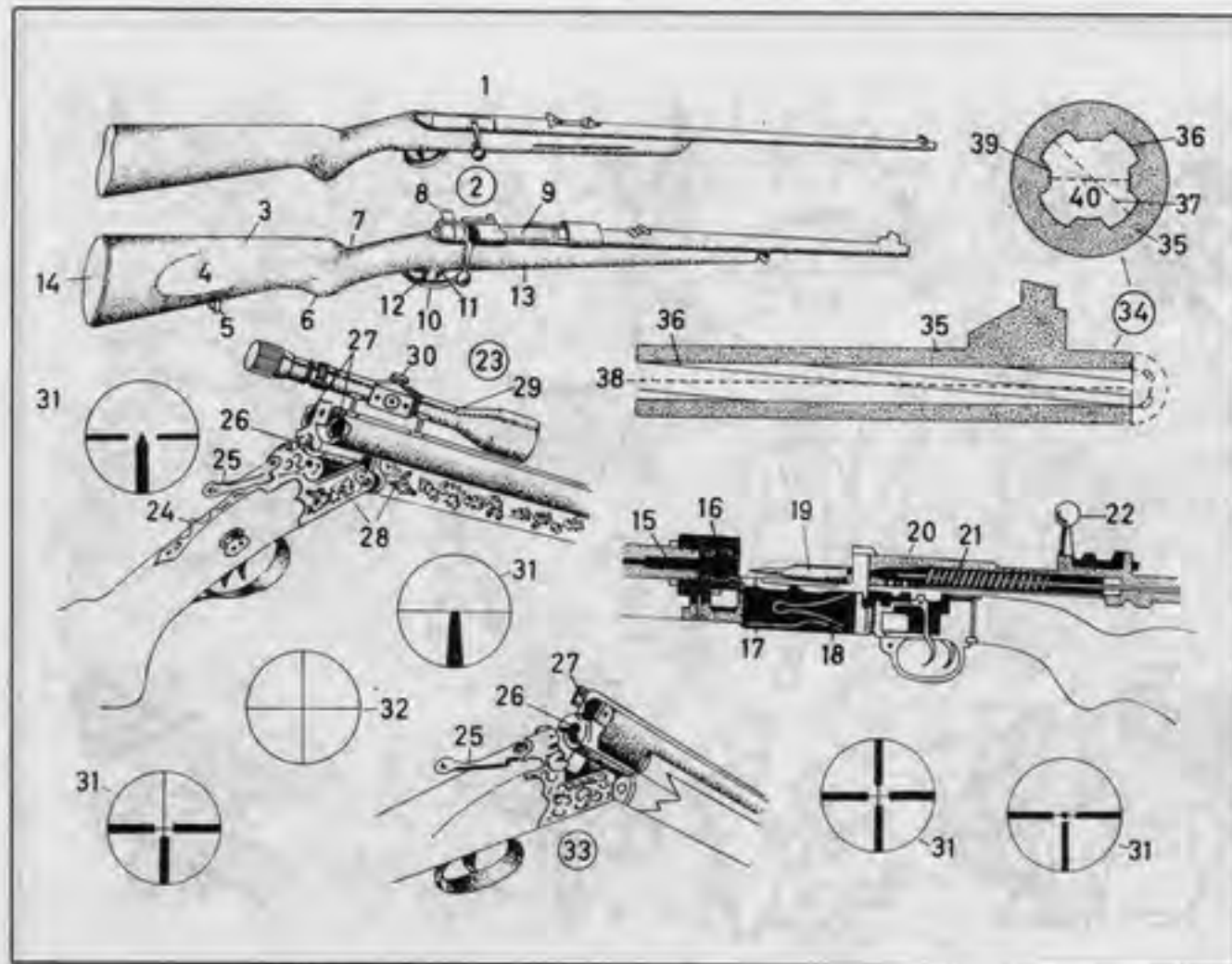

**1-40 sporting guns** (sporting rifles, hunting rifles)

- |   |   |
|---|---|
| 1 single-loader (single-loading rifle)  | 21 firing pin (striker)   |
| 2 repeating rifle, a small-arm (fire-arm), a repeater (magazine rifle, magazine repeater) | 22 bolt handle (bolt lever)                                     |
| 3, 4, 6, 13 stock   | 23 triple-barrelled (triple-barreled) rifle, a self-cocking gun |
| 3 butt  | 24 reversing catch ( <i>in various guns</i> : safety catch)     |
| 4 cheek [on the left side]  | 25 sliding safety catch   |
| 5 sling ring  | 26 rifle barrel (rifled barrel)                                 |
| 6 pistol grip   | 27 smooth-bore barrel   |
| 7 small of the butt   | 28 chasing  |
| 8 safety catch  | 29 telescopic sight (riflescope, telescope sight)               |
| 9 lock  | 30 graticule adjuster screws                                    |
| 10 trigger guard  | 31-32 graticule (sight graticule)                               |
| 11 second set trigger (firing trigger)  | 31 various graticule systems                                    |
| 12 hair trigger (set trigger)   | 32 cross wires ( <i>Am.</i> cross hairs)                        |
| 13 foregrip   | 33 over-and-under shotgun                                       |
| 14 butt plate   | 34 rifled gun barrel  |
| 15 cartridge chamber  | 35 barrel casing  |
| 16 receiver   | 36 rifling  |
| 17 magazine   | 37 rifling calibre ( <i>Am.</i> caliber)                        |
| 18 magazine spring  | 38 bore axis  |
| 19 ammunition (cartridge)   | 39 land   |
| 20 chamber  | 40 calibre (bore diameter, <i>Am.</i> caliber)                  |

**41-48 hunting equipment**

- |   |
|---|
| 41 double-edged hunting knife                               |
| 42 [single-edged] hunting knife                             |
| 43-47 calls for luring game (for calling game)              |
| 43 roe call   |
| 44 hare call  |
| 45 quail call   |
| 46 stag call  |
| 47 partridge call   |
| 48 bow trap (bow gin), a jaw trap                           |
| 49 small-shot cartridge                                     |
| 50 cardboard case   |
| 51 small-shot charge  |
| 52 felt wad   |
| 53 smokeless powder ( <i>different kind</i> : black powder) |
| 54 cartridge  |
| 55 full-jacketed cartridge                                  |
| 56 soft-lead core   |
| 57 powder charge  |
| 58 detonator cap  |
| 59 percussion cap   |
| 60 hunting horn   |
| 61-64 rifle cleaning kit                                    |
| 61 cleaning rod   |
| 62 cleaning brush   |
| 63 cleaning tow   |
| 64 pull-through ( <i>Am.</i> pull-thru)                     |
| 65 sights   |
| 66 notch (sighting notch)                                   |
| 67 back sight leaf  |
| 68 sight scale division                                     |
| 69 back sight slide   |
| 70 notch [to hold the spring]                               |
| 71 front sight (foresight)                                  |
| 72 bead   |
| 73 ballistics   |
| 74 azimuth  |
| 75 angle of departure                                       |
| 76 angle of elevation                                       |
| 77 apex (zenith)  |
| 78 angle of descent   |
| 79 ballistic curve  |

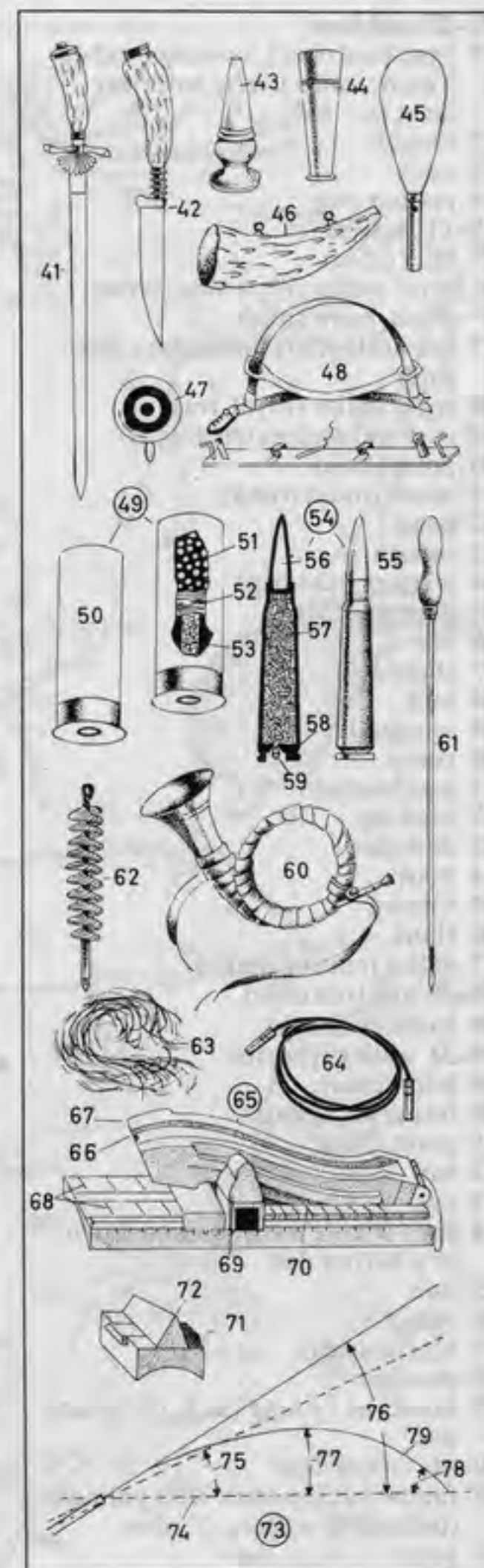



- 1-27 red deer  
 1 hind (red deer), a young hind or a dam; *collectively*: anterless deer, (*y.*) calf  
 2 tongue  
 3 neck  
 4 rutting stag  
 5-11 antlers  
 5 burr (rose)  
 6 brow antler (brow tine, brow point, brow snag)  
 7 bez antler (bay antler, bay, bez tine)  
 8 royal antler (royal, tray)  
 9 surroyal antlers (surroyals)  
 10 point (tine)  
 11 beam (main trunk)  
 12 head  
 13 mouth  
 14 larmier (tear bag)  
 15 eye  
 16 ear  
 17 shoulder  
 18 loin  
 19 scut (tail)  
 20 rump  
 21 leg (haunch)  
 22 hind leg  
 23 dew claw  
 24 hoof  
 25 foreleg  
 26 flank  
 27 collar (rutting mane)  
 28-39 roe (roe deer)  
 28 roebuck (buck)  
 29-31 antlers (horns)  
 29 burr (rose)  
 30 beam with pearls  
 31 point (tine)  
 32 ear  
 33 eye  
 34 doe (female roe), a female fawn or a barren doe  
 35 loin  
 36 rump  
 37 leg (haunch)  
 38 shoulder  
 39 fawn, (*m.*) young buck, (*f.*) young doe  
 40-41 fallow deer  
 40 fallow buck, a buck with palmate (palmated) antlers, (*f.*) doe  
 41 palm  
 42 red fox, (*m.*) dog, (*f.*) vixen, (*y.*) cub  
 43 eyes  
 44 ear  
 45 muzzle (mouth)  
 46 pads (paws)  
 47 brush (tail)  
 48 badger, (*f.*) sow  
 49 tail  
 50 paws  
 51 wild boar, (*m.*) boar, (*f.*) wild sow (sow), (*y.*) young boar  
 52 bristles  
 53 snout  
 54 tusk  
 55 shield  
 56 hide  
 57 dew claw  
 58 tail  
 59 hare, (*m.*) buck, (*f.*) doe  
 60 eye  
 61 ear  
 62 scut (tail)  
 63 hind leg  
 64 foreleg  
 65 rabbit  
 66 blackcock  
 67 tail  
 68 falcate (falcated) feathers  
 69 hazel grouse (hazel hen)  
 70 partridge  
 71 horseshoe (horseshoe marking)  
 72 wood grouse (capercaillie)  
 73 beard  
 74 axillary marking  
 75 tail (fan)  
 76 wing (pinion)  
 77 common pheasant, a pheasant, (*m.*) cock pheasant (pheasant cock), (*f.*) hen pheasant (pheasant hen)  
 78 plumicorn (feathered ear, ear tuft, ear, horn)  
 79 wing  
 80 tail  
 81 leg  
 82 spur  
 83 snipe  
 84 bill (beak)

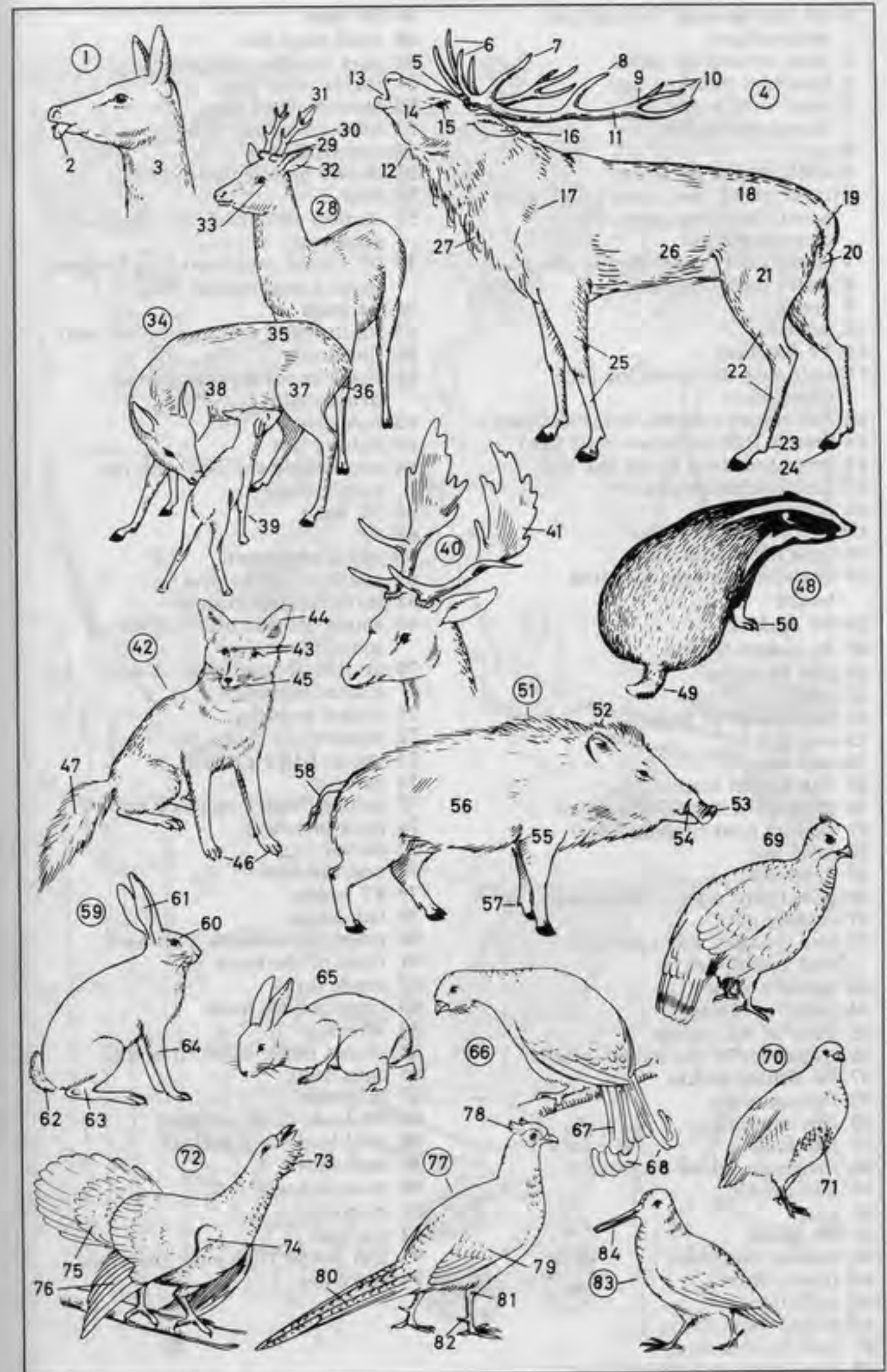



- 1-19 fish farming (fish culture, pisciculture)
- 1 cage in running water
- 2 hand net (landing net)
- 3 semi-oval barrel for transporting fish
- 4 vat
- 5 trellis in the overflow
- 6 trout pond; *sim.*: carp pond, a fry pond, fattening pond, or cleansing pond
- 7 water inlet (water supply pipe)
- 8 water outlet (outlet pipe)
- 9 monk
- 10 screen
- 11-19 hatchery
- 11 stripping the spawning pike (seed pike)
- 12 fish spawn (spawn, roe, fish eggs)
- 13 female fish (spawner, seed fish)
- 14 trout breeding (trout rearing)
- 15 Californian incubator
- 16 trout fry
- 17 hatching jar for pike
- 18 long incubation tank
- 19 Brandstetter egg-counting board
- 20-94 angling
- 20-31 coarse fishing
- 20 line shooting
- 21 coils
- 22 cloth (rag) or paper
- 23 rod rest
- 24 bait tin
- 25 fish basket (creel)
- 26 fishing for carp from a boat
- 27 rowing boat (fishing boat)
- 28 keep net
- 29 drop net
- 30 pole (punt pole, quant pole)
- 31 casting net
- 32 two-handed side cast with fixed-spool reel
- 33 initial position
- 34 point of release
- 35 path of the rod tip
- 36 trajectory of the baited weight
- 37-94 fishing tackle
- 37 fishing pliers
- 38 filleting knife
- 39 fish knife
- 40 disgorging (hook disgorging)
- 41 bait needle
- 42 gag
- 43-48 floats
- 43 sliding cork float
- 44 plastic float
- 45 quill float
- 46 polystyrene float
- 47 oval bubble float
- 48 lead-weighted sliding float

- 49-58 rods
- 49 solid glass rod
- 50 cork handle (cork butt)
- 51 spring-steel ring
- 52 top ring (end ring)
- 53 telescopic rod
- 54 rod section
- 55 bound handle (bound butt)
- 56 ring
- 57 carbon-fibre rod; *sim.*: hollow glass rod
- 58 all-round ring (butt ring for long cast), a steel bridge ring
- 59-64 reels
- 59 multiplying reel (multiplier reel)
- 60 line guide
- 61 fixed-spool reel (stationary-drum reel)
- 62 bale arm
- 63 fishing line
- 64 controlling the cast with the index finger
- 65-76 baits
- 65 fly
- 66 artificial nymph
- 67 artificial earthworm
- 68 artificial grasshopper
- 69 single-jointed plug (single-jointed wobbler)
- 70 double-jointed plug (double-jointed wobbler)
- 71 round wobbler
- 72 wiggler
- 73 spoon bait (spoon)
- 74 spinner
- 75 spinner with concealed hook
- 76 long spinner
- 77 swivel
- 78 cast (leader)
- 79-87 hooks
- 79 fish hook
- 80 point of the hook with barb
- 81 bend of the hook
- 82 spade (eye)
- 83 open double hook
- 84 limerick
- 85 closed treble hook (triangle)
- 86 carp hook
- 87 eel hook
- 88-92 leads (lead weights)
- 88 oval lead (oval sinker)
- 89 lead shot
- 90 pear-shaped lead
- 81 plummet
- 92 sea lead
- 93 fish ladder (fish pass, fish way)
- 94 stake net

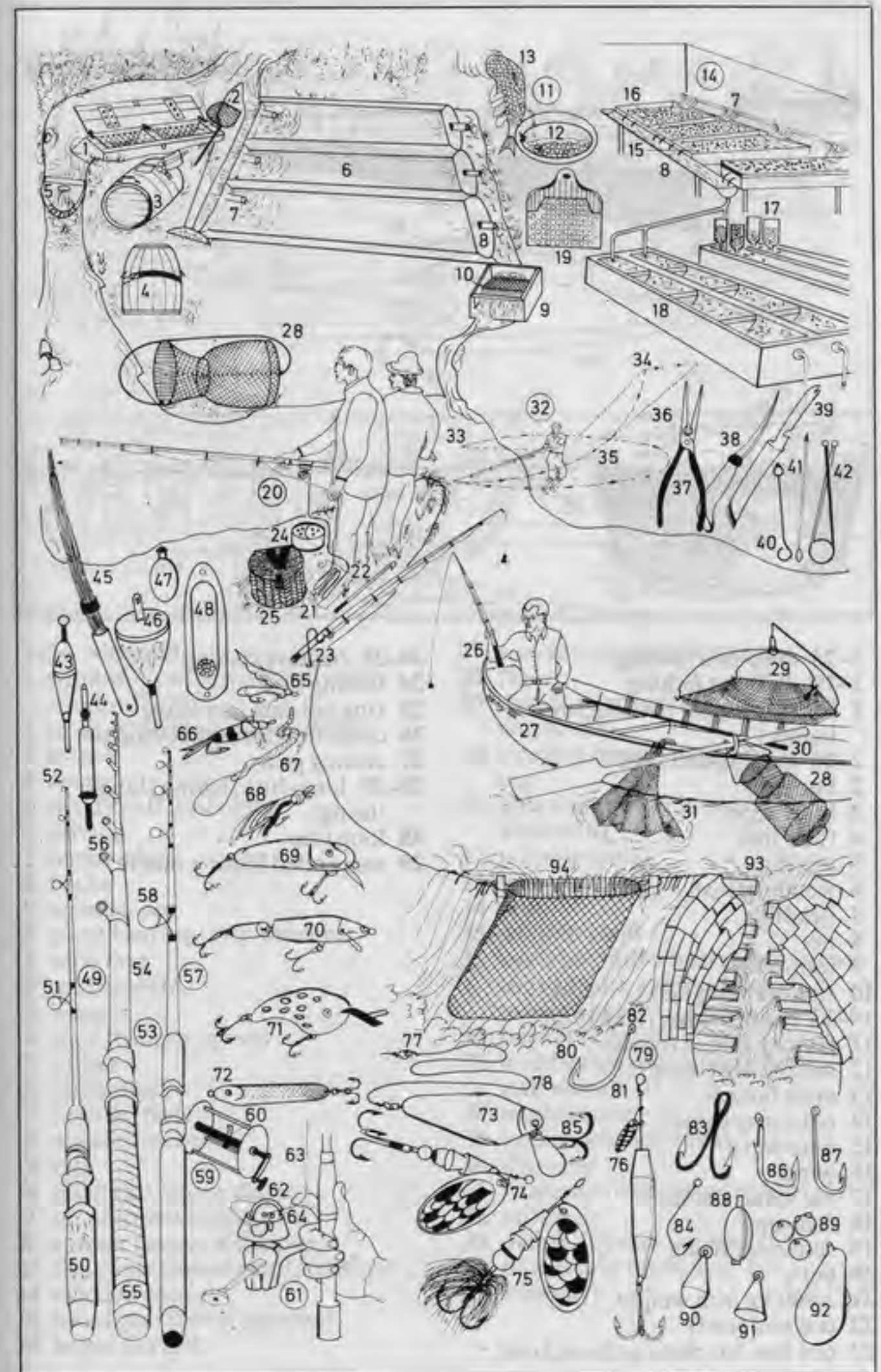

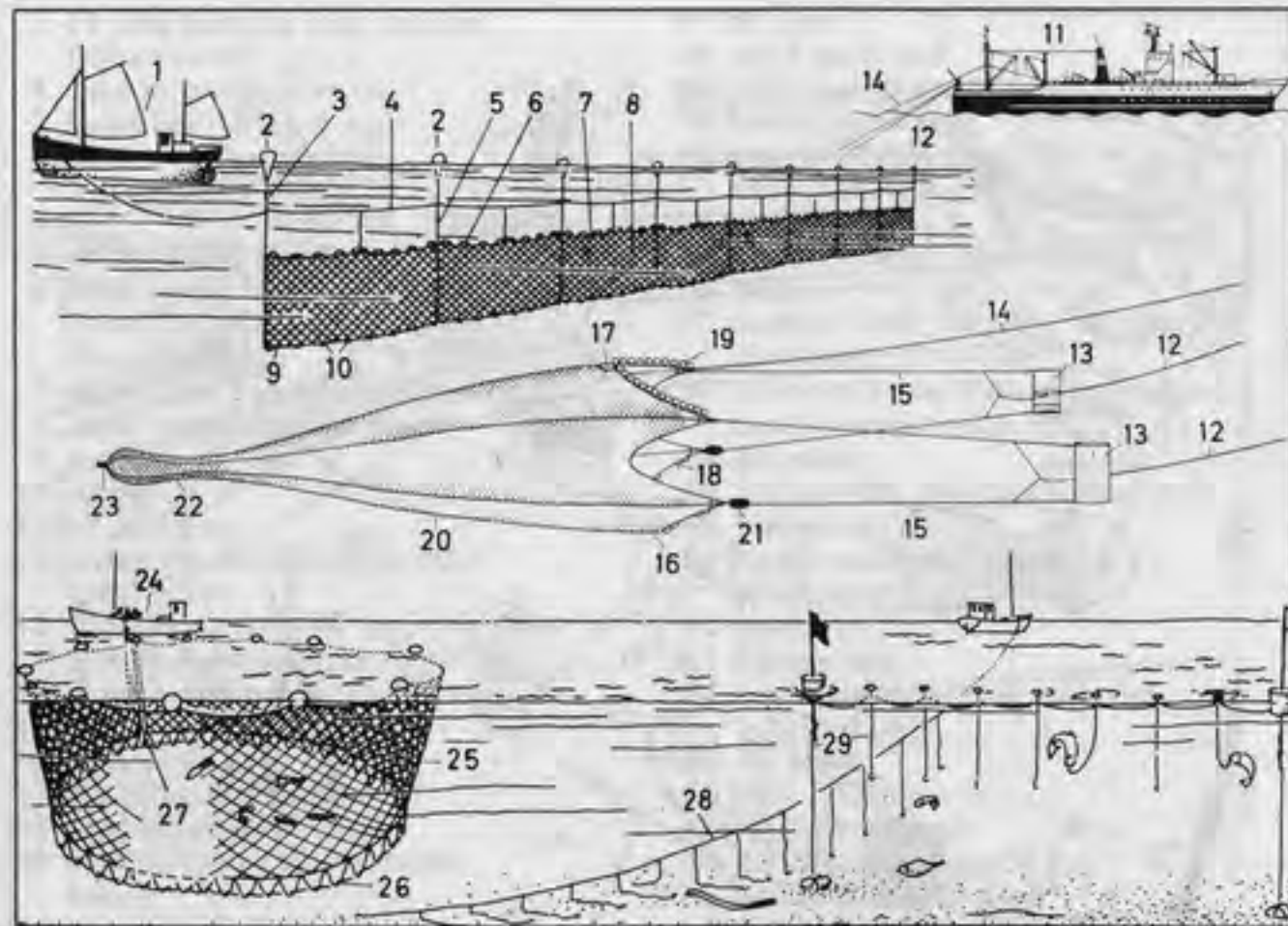

**1-23 deep-sea fishing****1-10 drift net fishing**

1 herring lugger (fishing lugger, lugger)

**2-10 herring drift net**

2 buoy

3 buoy rope

4 float line

5 seizing

6 wooden float

7 headline

8 net

9 footrope

10 sinkers (weights)

**11-23 trawl fishing (trawling)**

11 factory ship, a trawler

12 warp (trawl warp)

13 otter boards

14 net sonar cable

15 wire warp

16 wing

17 net sonar device

18 footrope

19 spherical floats

20 belly

21 1,800 kg iron weight

22 cod end (cod)

23 cod line for closing the cod end

**24-29 inshore fishing**

24 fishing boat

25 ring net cast in a circle

26 cable for closing the ring net

27 closing gear

28-29 long-line fishing (long-lining)

28 long line

29 suspended fishing tackle

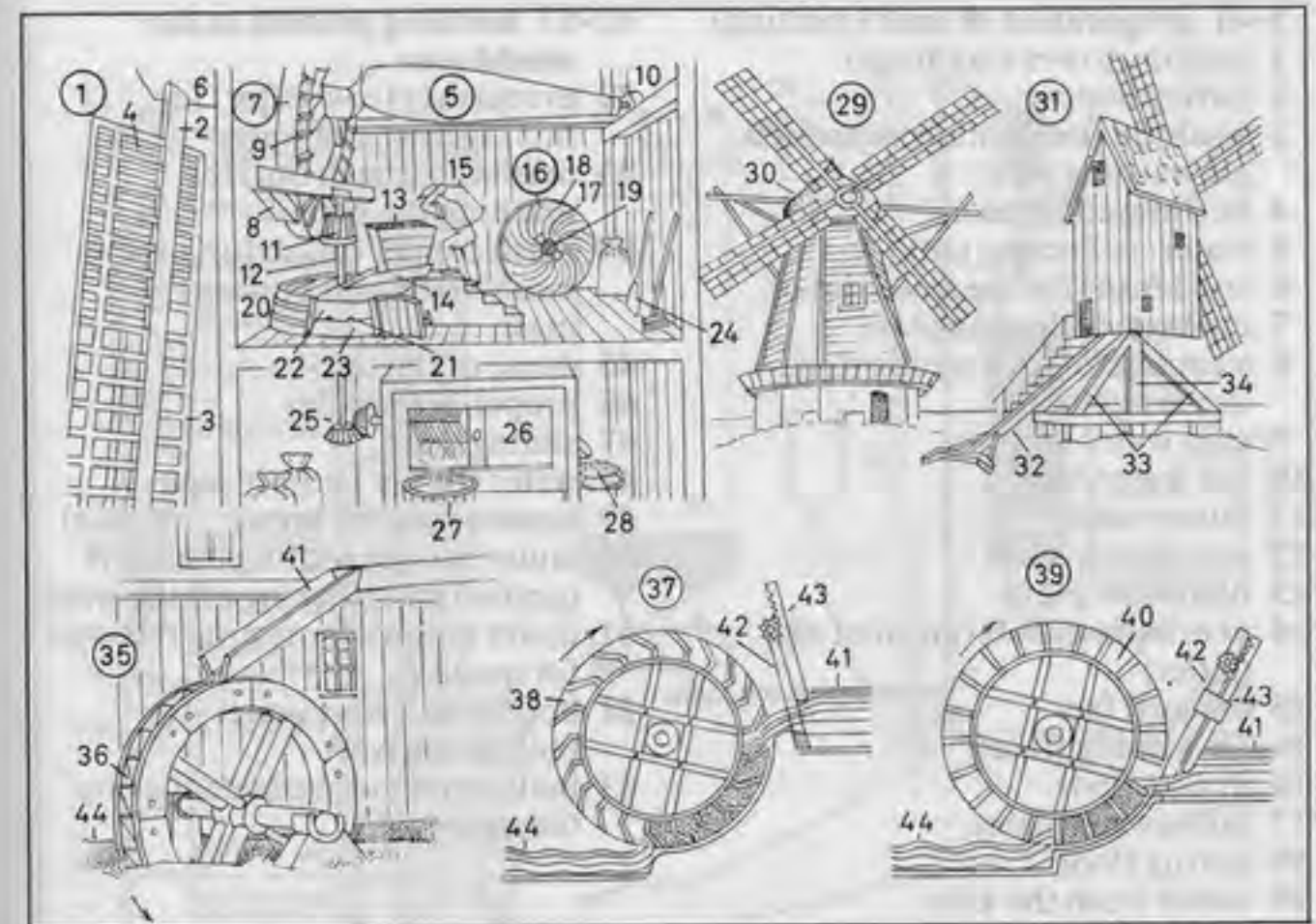
**1-34 windmill**

1 windmill vane (windmill sail, windmill arm)

2 stock (middling, back, radius)

3 frame

4 shutter

5 wind shaft (sail axle)

6 sail top

7 brake wheel

8 brake

9 wooden cog

10 pivot bearing (step bearing)

11 wallower

12 mill spindle

13 hopper

14 shoe (trough, spout)

15 miller

16 millstone

17 furrow (flute)

18 master furrow

19 eye

20 hurst (millstone casing)

21 set of stones (millstones)

22 runner (upper millstone)

23 bed stone (lower stone, bedder)

24 wooden shovel

25 bevel gear (bevel gearing)

26 bolter (sifter)

27 wooden tub (wooden tun)

28 flour

29 smock windmill (Dutch windmill)

30 rotating (revolving) windmill cap

31 post windmill (German windmill)

32 tailpole (pole)

33 base

34 post

**35-44 watermill**

35 overshot mill wheel (high-breast mill wheel), a mill wheel (waterwheel)

36 bucket (cavity)

37 middleshot mill wheel (breast mill wheel)

38 curved vane

39 undershot mill wheel

40 flat vane

41 headrace (discharge flume)

42 mill weir

43 overfall (water overfall)

44 millstream (millrace, *Am.* raceway)



- 1-41 preparation of malt (malting)**
- 1 malting tower (maltings)
  - 2 barley hopper
  - 3 washing floor with compressed-air washing unit
  - 4 outflow condenser
  - 5 water-collecting tank
  - 6 condenser for the steep liquor
  - 7 coolant-collecting plant
  - 8 steeping floor (steeping tank, dressing floor)
  - 9 cold water tank
  - 10 hot water tank
  - 11 pump room
  - 12 pneumatic plant
  - 13 hydraulic plant
  - 14 ventilation shaft (air inlet and outlet)
  - 15 exhaust fan
  - 16-18 kilning floors**
  - 16 drying floor
  - 17 burner ventilator
  - 18 curing floor
  - 19 outlet from the kiln
  - 20 finished malt collecting hopper
  - 21 transformer station
  - 22 cooling compressors
  - 23 green malt (germinated barley)
  - 24 turner (plough)
  - 25 central control room with flow diagram
  - 26 screw conveyor
  - 27 washing floor
  - 28 steeping floor
  - 29 drying kiln
  - 30 curing kiln
  - 31 barley silo
  - 32 weighing apparatus
  - 33 barley elevator
  - 34 three-way chute (three-way tippler)
  - 35 malt elevator
  - 36 cleaning machine
  - 37 malt silo
  - 38 corn removal by suction
  - 39 sacker
  - 40 dust extractor
  - 41 barley reception

- 42-53 mashing process in the mashhouse**
- 42 premasher (converter) for mixing grist and water
  - 43 mash tub (mash tun) for mashing the malt
  - 44 mash copper (mash tun, *Am.* mash kettle) for boiling the mash
  - 45 dome of the tun
  - 46 propeller (paddle)
  - 47 sliding door
  - 48 water (liquor) supply pipe
  - 49 brewer (master brewer, masher)
  - 50 lauter tun for settling the draff (grains) and filtering off the wort for quality
  - 51 lauter battery for testing the wort for quality
  - 52 hop boiler (wort boiler) for boiling the wort
  - 53 ladle-type thermometer (scoop thermometer)

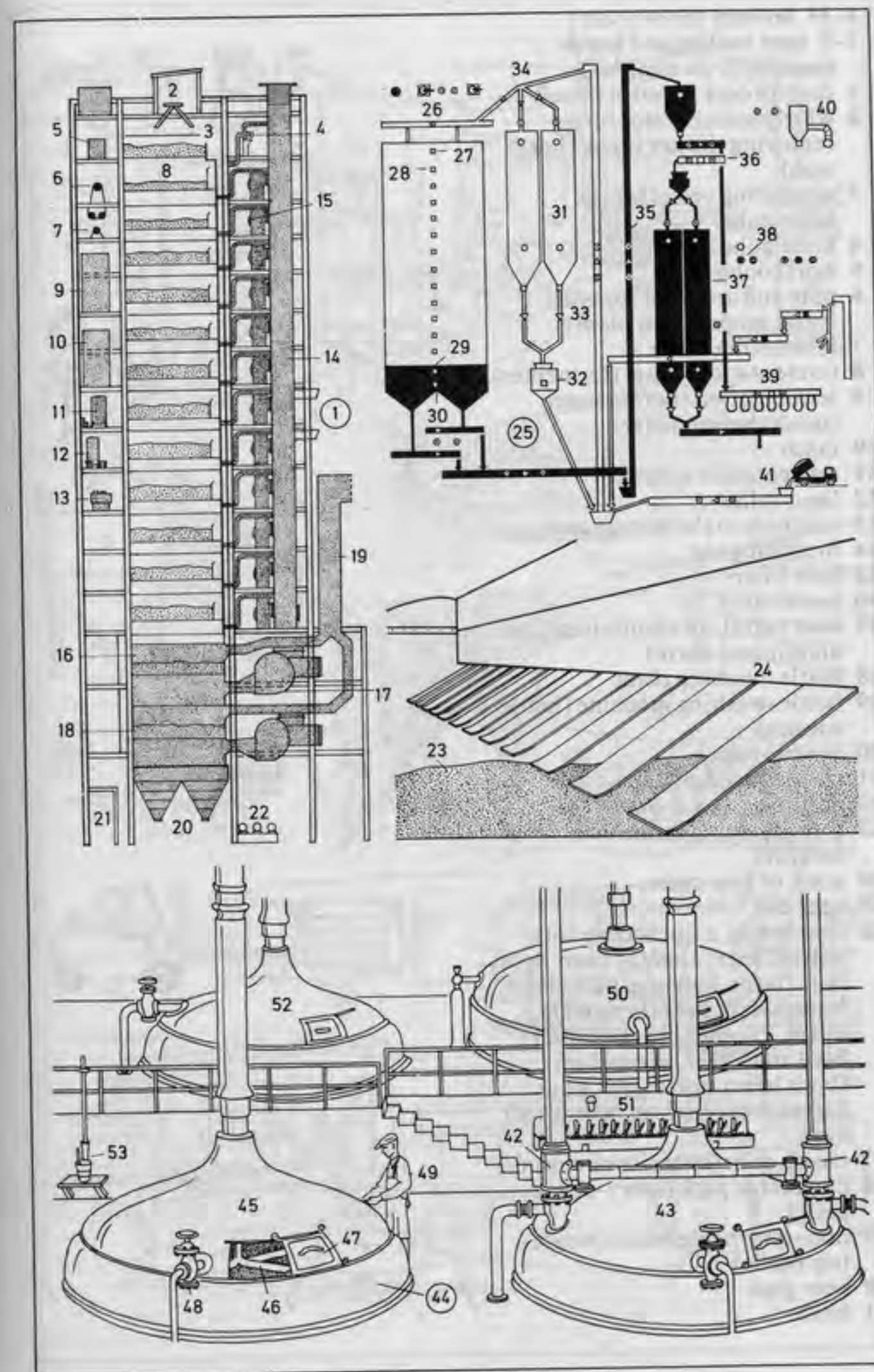



- 1-31 brewery (brewhouse)
- 1-5 wort cooling and break removal (trub removal)
- 1 control desk (control panel)
- 2 whirlpool separator for removing the hot break (hot trub)
- 3 measuring vessel for the kieselguhr
- 4 kieselguhr filter
- 5 wort cooler
- 6 pure culture plant for yeast (yeast propagation plant)
- 7 fermenting cellar
- 8 fermentation vessel (fermenter)
- 9 fermentation thermometer (mash thermometer)
- 10 mash
- 11 refrigeration system
- 12 lager cellar
- 13 manhole to the storage tank
- 14 broaching tap
- 15 beer filter
- 16 barrel store
- 17 beer barrel, an aluminium (*Am.* aluminum) barrel
- 18 bottle-washing plant
- 19 bottle-washing machine (bottle washer)
- 20 control panel
- 21 cleaned bottles
- 22 bottling
- 23 forklift truck (fork truck, forklift)
- 24 stack of beer crates
- 25 beer can
- 26 beer bottle, a Eurobottle with bottled beer; *kinds of beer*: light beer (lager, light ale, pale ale or bitter), dark beer (brown ale, mild), Pilsener beer, Munich beer, malt beer, strong beer (bock beer), porter, ale, stout, Salvator beer, wheat beer, small beer
- 27 crown cork (crown cork closure)
- 28 disposable pack (carry-home pack)
- 29 non-returnable bottle (single-trip bottle)
- 30 beer glass
- 31 head

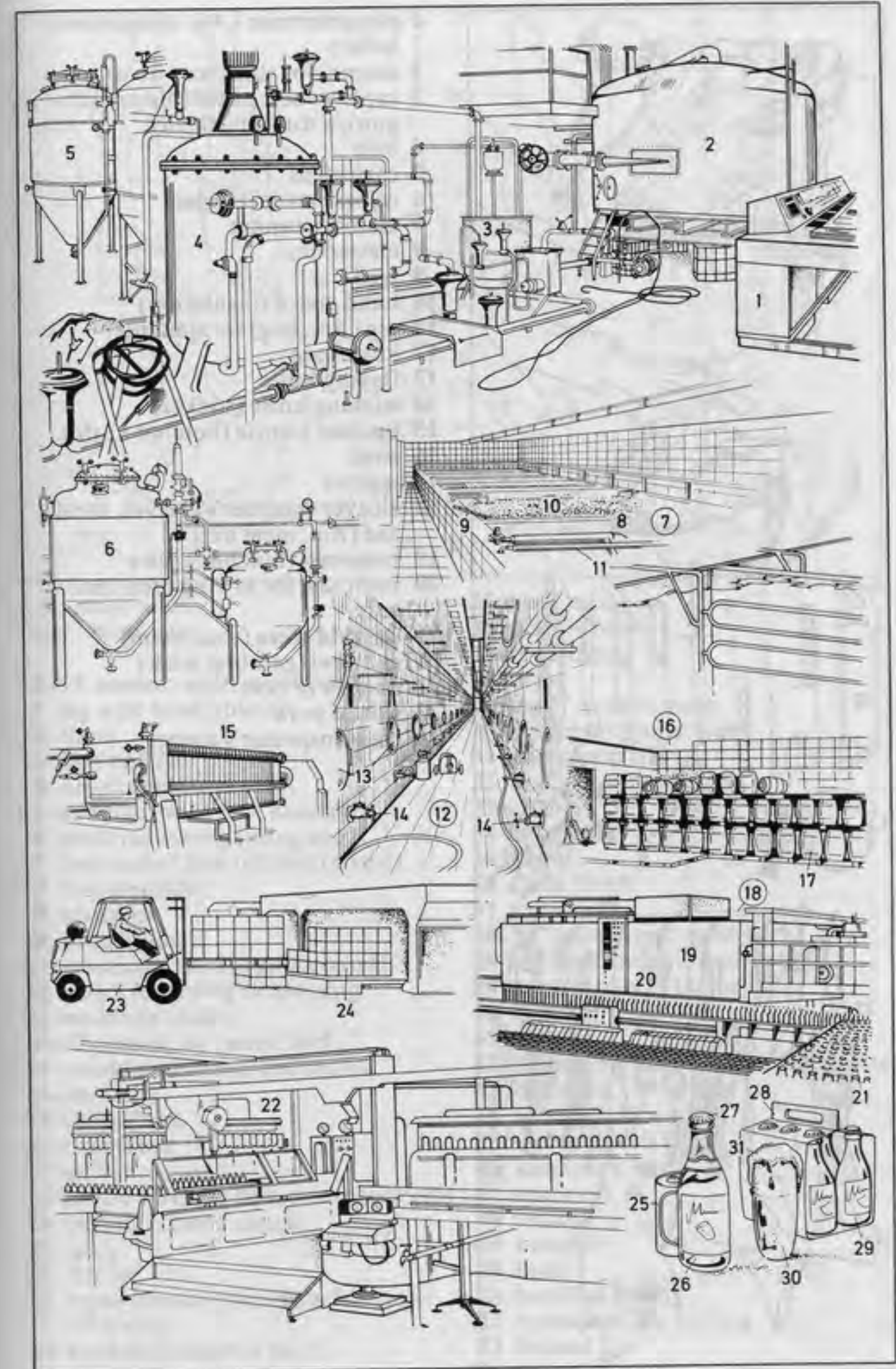



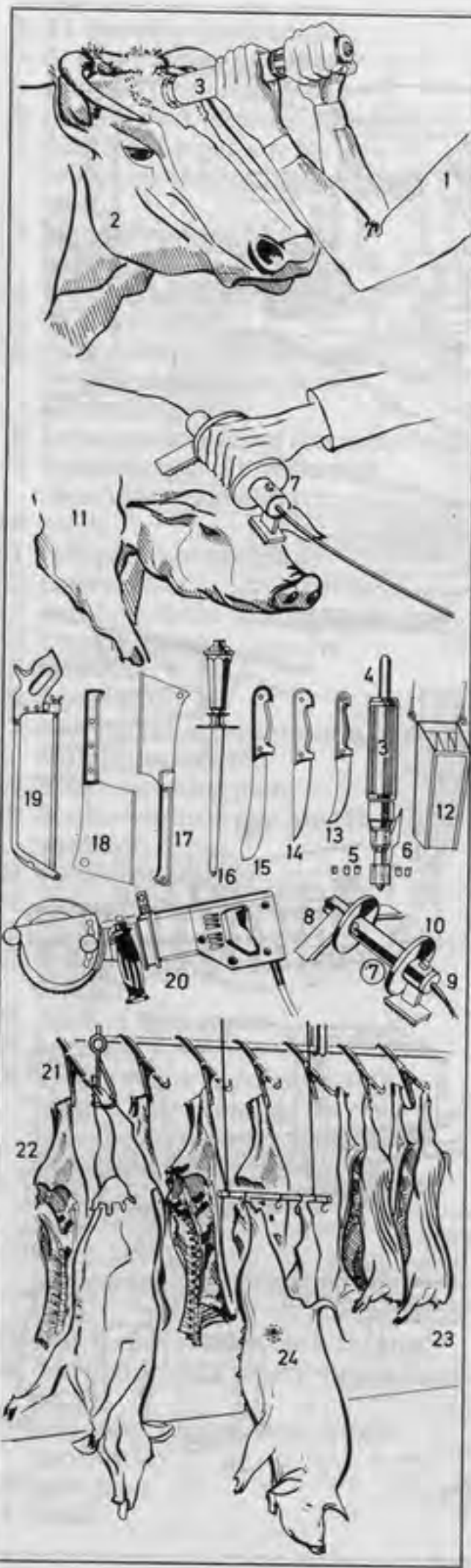

- 1 slaughterman (*Am.* slaughterer, killer)
- 2 animal for slaughter, an ox
- 3 captive-bolt pistol (pneumatic gun), a stunning device
- 4 bolt
- 5 cartridges
- 6 release lever (trigger)
- 7 electric stunner
- 8 electrode
- 9 lead
- 10 hand guard (insulation)
- 11 pig (*Am.* hog) for slaughter
- 12 knife case
- 13 flaying knife
- 14 sticking knife (sticker)
- 15 butcher's knife (butcher knife)
- 16 steel
- 17 splitter
- 18 cleaver (butcher's cleaver, meat axe (*Am.* meat ax))
- 19 bone saw (butcher's saw)
- 20 meat saw for sawing meat into cuts
- 21-24 cold store (cold room)
- 21 gambrel (gambrel stick)
- 22 quarter of beef
- 23 side of pork
- 24 meat inspector's stamp

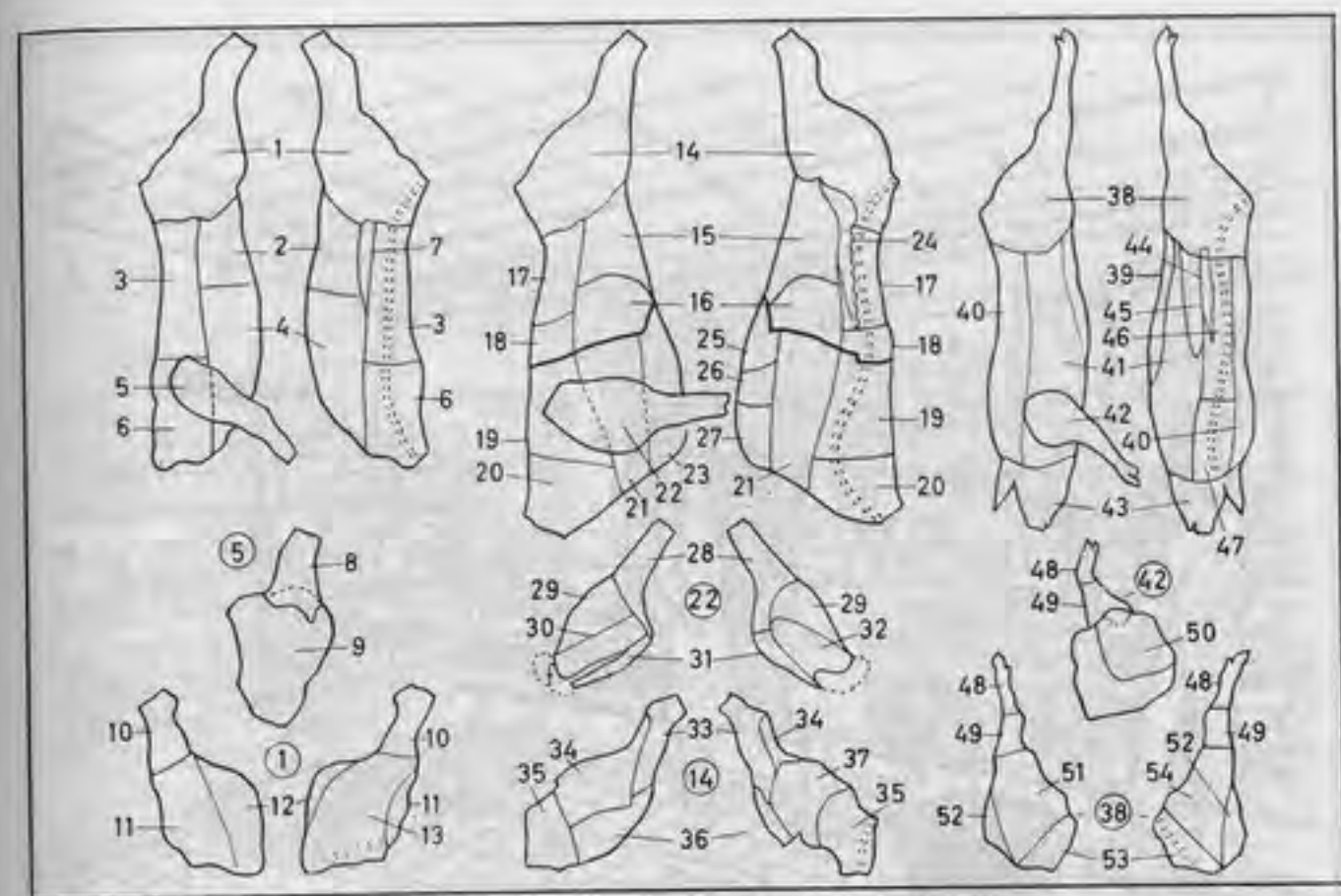

left: meat side;  
right: bone side

- 1-13 *animal: calf; meat: veal*
- 1 leg with hind knuckle
- 2 flank
- 3 loin and rib
- 4 breast (breast of veal)
- 5 shoulder with fore knuckle
- 6 neck with scrag (scrag end)
- 7 best end of loin (of loin of veal)
- 8 fore knuckle
- 9 shoulder
- 10 hind knuckle
- 11 roasting round (oyster round)
- 12 cutlet for frying or braising
- 13 undercut (fillet)
- 14-37 *animal: ox; meat: beef*
- 14 round with rump and shank
- 15-16 flank
- 15 thick flank
- 16 thin flank
- 17 sirloin
- 18 prime rib (fore ribs, prime fore rib)
- 19 middle rib and chuck
- 20 neck
- 21 flat rib
- 22 leg of mutton piece (bladebone) with shin
- 23 brisket (brisket of beef)
- 24 fillet (fillet of beef)
- 25 hind brisket
- 26 middle brisket
- 27 breastbone
- 28 shin
- 29 leg of mutton piece
- 30 bladebone [meat side]
- 31 part of top rib
- 32 bladebone [bone side]
- 33 shank
- 34 silverside
- 35 rump
- 36 thick flank
- 37 top side
- 38-54 *animal: pig; meat: pork*
- 38 leg with knuckle and trotter
- 39 ventral part of the belly
- 40 back fat
- 41 belly
- 42 bladebone with knuckle and trotter
- 43 head (pig's head)
- 44 fillet (fillet of pork)
- 45 leaf fat (pork flare)
- 46 loin (pork loin)
- 47 spare rib
- 48 trotter
- 49 knuckle
- 50 butt
- 51 fore end (ham)
- 52 round end for boiling
- 53 fat end
- 54 gammon steak



**1-30 butcher's shop****1-4 meat**

- 1 ham on the bone
- 2 flitch of bacon
- 3 smoked meat
- 4 piece of loin (piece of sirloin)
- 5 lard
- 6-11 sausages**
- 6 price label
- 7 mortadella
- 8 scalded sausage; *kinds*: Vienna sausage (Wiener), Frankfurter sausage (Frankfurter)
- 9 collared pork (*Am.* headcheese)
- 10 ring of Lyoner sausage
- 11 pork sausages; *also*: beef sausages
- 12 cold shelves
- 13 meat salad (diced meat salad)
- 14 cold meats (*Am.* cold cuts)
- 15 pâté
- 16 mince (mincemeat, minced meat)
- 17 knuckle of pork

- 18 basket for special offers
- 19 price list for special offers
- 20 special offer
- 21 freezer
- 22 pre-packed joints
- 23 deep-frozen ready-to-eat meal
- 24 chicken
- 25 canned food
- 26 can
- 27 canned vegetables
- 28 canned fish
- 29 salad cream
- 30 soft drinks

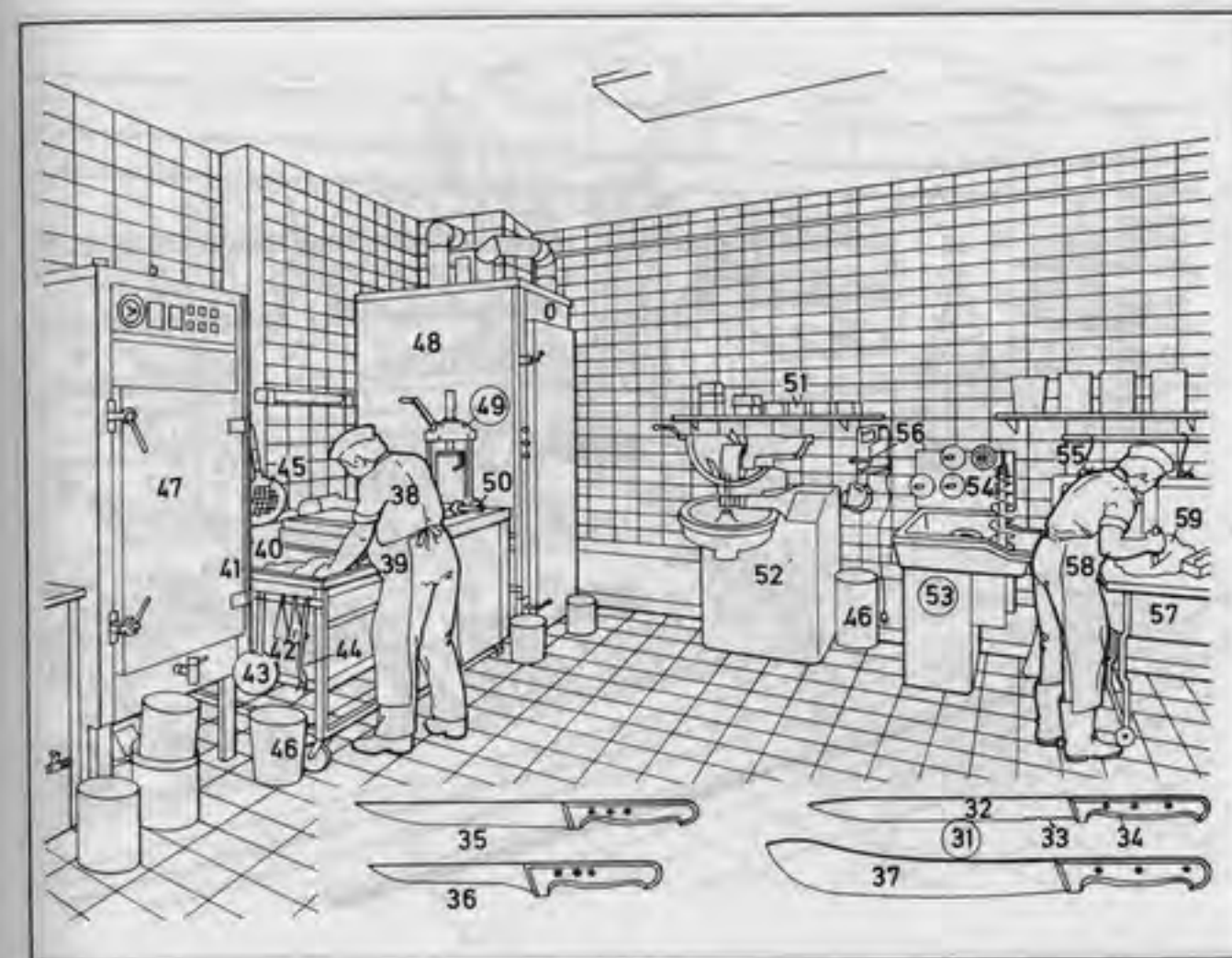
**31-59 manufacture of sausages****31-37 butcher's knives**

- 31 slicer
- 32 knife blade
- 33 saw teeth
- 34 knife handle
- 35 carver (carving knife)
- 36 boning knife
- 37 butcher's knife (butcher knife)
- 38 butcher (master butcher)
- 39 butcher's apron
- 40 meat-mixing trough
- 41 sausage meat
- 42 scraper
- 43 skimmer
- 44 sausage fork
- 45 scalding colander
- 46 waste bin (*Am.* trash bin)
- 47 cooker, for cooking with steam or hot air
- 48 smoke house
- 49 sausage filler (sausage stuffer)
- 50 feed pipe (supply pipe)
- 51 containers for vegetables

**52 mincing machine for sausage meat**

- 53 mincing machine (meat mincer, mincer, *Am.* meat grinder)
- 54 plates (steel plates)
- 55 meathook (butcher's hook)
- 56 bone saw
- 57 chopping board
- 58 butcher, cutting meat
- 59 piece of meat

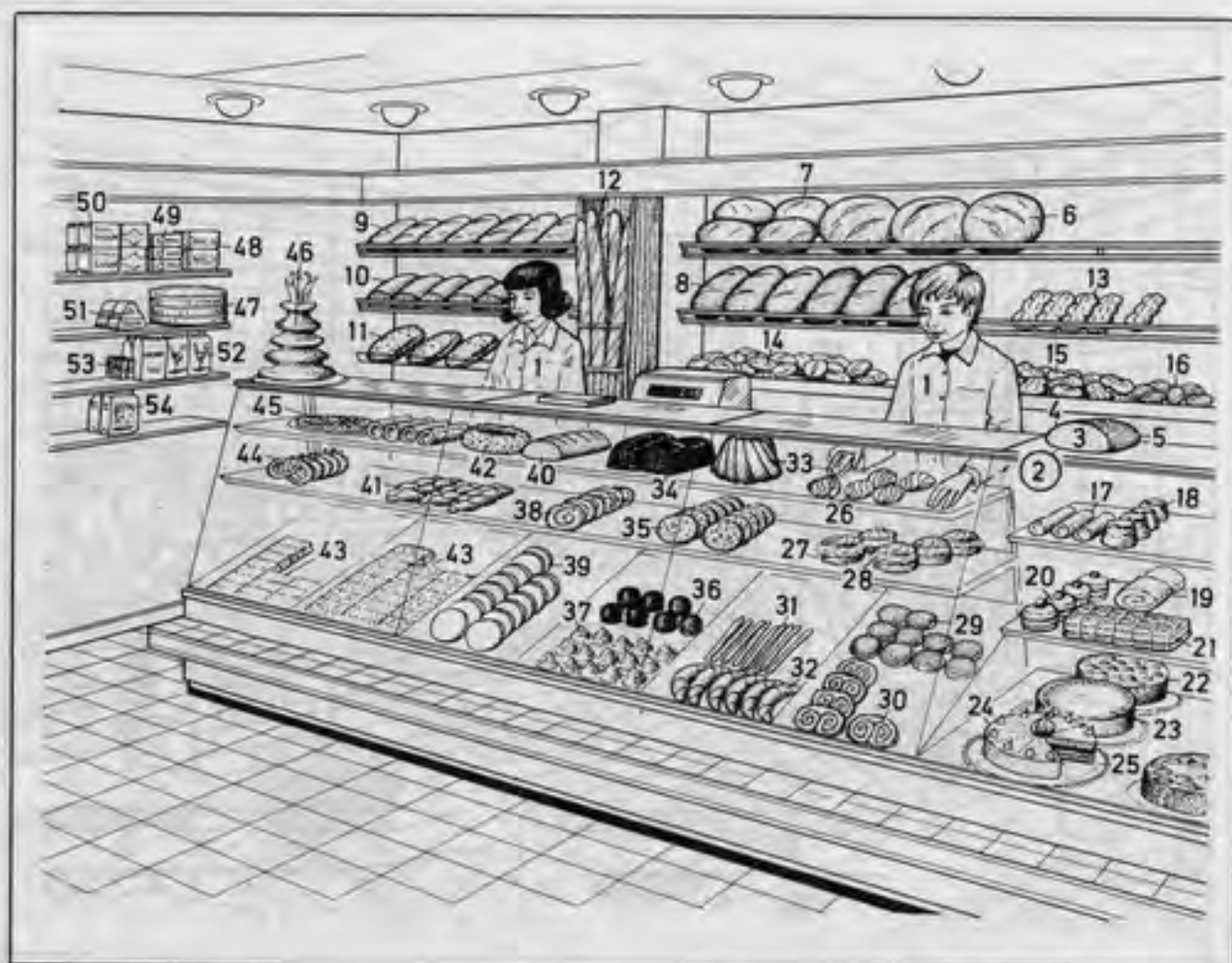

**1-54 baker's shop**

- 1 shop assistant (*Am.* salesgirl, saleslady)
- 2 bread (loaf of bread, loaf)
- 3 crumb
- 4 crust (bread crust)
- 5 crust (*Am.* heel)
- 6-12 kinds of bread (breads)**
- 6 round loaf, a wheat and rye bread
- 7 small round loaf
- 8 long loaf (bloomer), a wheat and rye bread
- 9 white loaf
- 10 pan loaf, a wholemeal rye bread
- 11 yeast bread (*Am.* stollen)
- 12 French loaf (baguette, French stick)
- 13-16 rolls**
- 13 brown roll
- 14 white roll
- 15 finger roll
- 16 rye-bread roll
- 17-47 cakes (confectionery)**
- 17 cream roll
- 18 vol-au-vent, a puff pastry (*Am.* puff paste)
- 19 Swiss roll (*Am.* jelly roll)
- 20 tartlet
- 21 slice of cream cake
- 22-24 flans (*Am.* pies) and gateaux (torten)**
- 22 fruit flan (*kinds:* strawberry flan, cherry flan, gooseberry flan, peach flan, rhubarb flan)
- 23 cheesecake
- 24 cream cake (*Am.* cream pie) (*kinds:* butter-cream cake, Black Forest gateau)
- 25 cake plate
- 26 meringue
- 27 cream puff
- 28 whipped cream
- 29 doughnut (*Am.* bismarck)
- 30 Danish pastry
- 31 saltstick (saltzstange) (*also:* caraway roll, caraway stick)
- 32 croissant (crescent roll, *Am.* crescent)
- 33 ring cake (gugelhupf)
- 34 slab cake with chocolate icing
- 35 streusel cakes
- 36 marshmallow

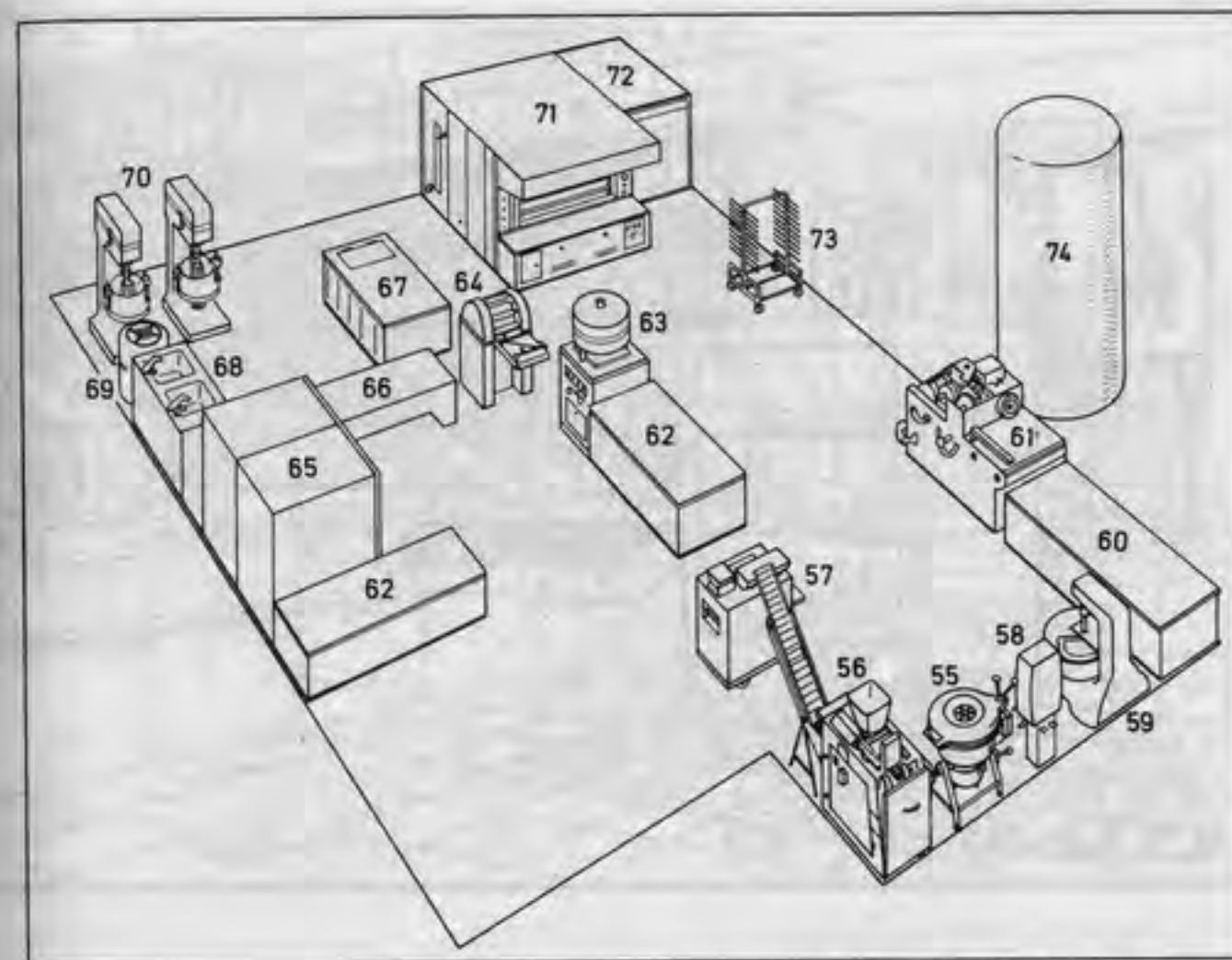

- 37 coconut macaroon
- 38 pastry whirl
- 39 iced bun
- 40 sweet bread
- 41 plaited bun (plait)
- 42 Frankfurter garland cake
- 43 slices (*kinds:* streusel slices, sugared slices, plum slices)
- 44 pretzel
- 45 wafer (*Am.* waffle)
- 46 tree cake (baumkuchen)
- 47 flan case
- 48-50 wrapped bread**
- 48 wholemeal bread (*also:* wheatgerm bread)
- 49 pumpernickel (wholemeal rye bread)
- 50 crispbread
- 51 gingerbread (*Am.* lebkuchen)
- 52 flour (*kinds:* wheat flour, rye flour)
- 53 yeast (baker's yeast)
- 54 rusks (French toast)
- 55-74 bakery (bakehouse)**
- 55 kneading machine (dough mixer)
- 56-57 bread unit**
- 56 divider
- 57 moulder (*Am.* molder)
- 58 premixer
- 59 dough mixer
- 60 workbench
- 61 roll unit
- 62 workbench
- 63 divider and rounder (rounding machine)
- 64 crescent-forming machine
- 65 freezers
- 66 oven [for baking with fat]
- 67-70 confectionery unit**
- 67 cooling table
- 68 sink
- 69 boiler
- 70 whipping unit [with beater]
- 71 reel oven (oven)
- 72 fermentation room
- 73 fermentation trolley
- 74 flour silo



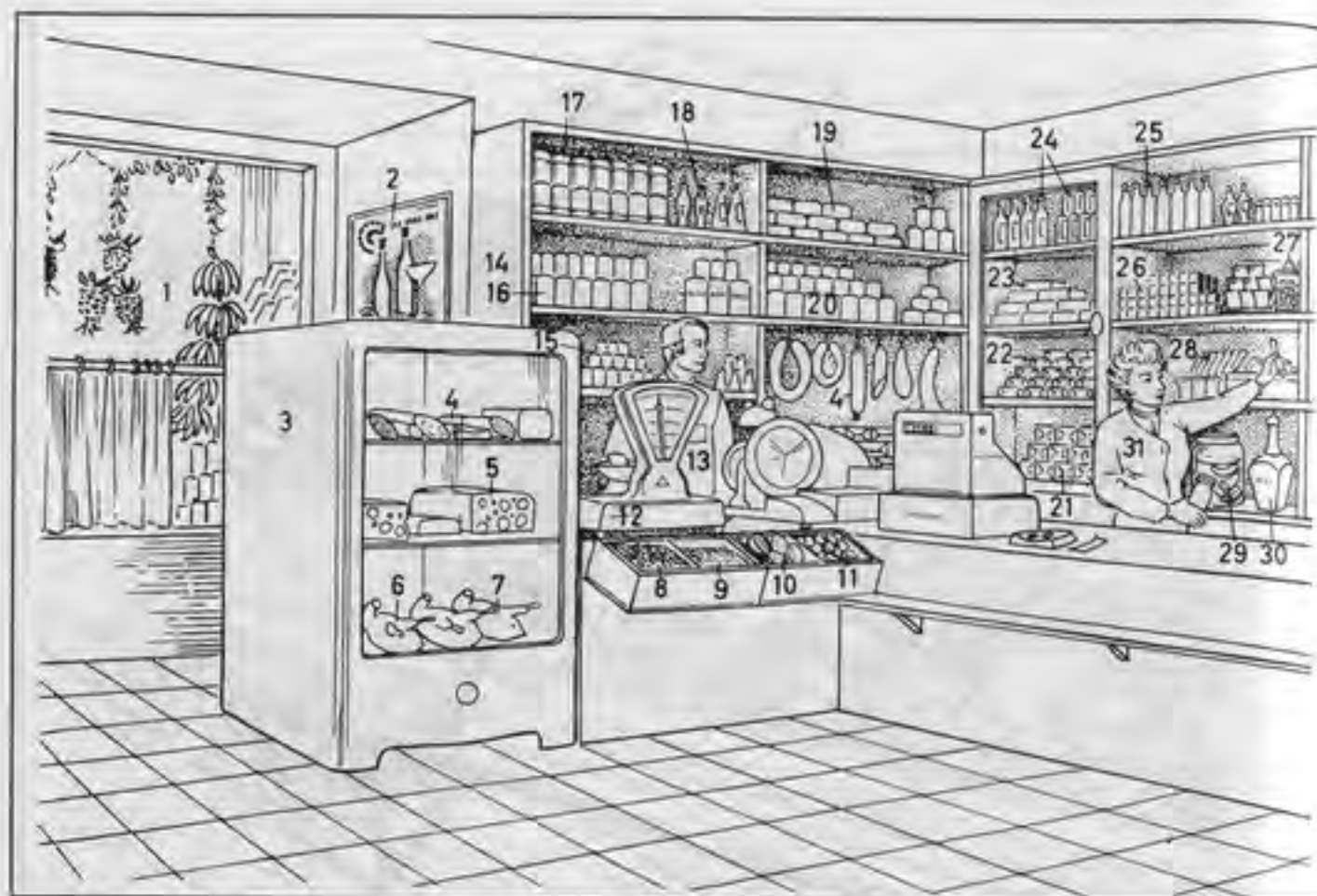

1-87 grocer's shop (grocer's, delicatessen shop, *Am. grocery store*, delicatessen store), a retail shop (*Am. retail store*)

- 1 window display
- 2 poster (advertisement)
- 3 cold shelves
- 4 sausages
- 5 cheese
- 6 roasting chicken (broiler)
- 7 poulard, a fattened hen
- 8-11 baking ingredients
- 8 raisins; *sim.*: sultanas
- 9 currants
- 10 candied lemon peel
- 11 candied orange peel
- 12 computing scale, a rapid scale
- 13 shop assistant (*Am. salesclerk*)
- 14 goods shelves (shelves)
- 15-20 canned food
- 15 canned milk
- 16 canned fruit (cans of fruit)
- 17 canned vegetables
- 18 fruit juice
- 19 sardines in oil, a can of fish
- 20 canned meat (cans of meat)
- 21 margarine

- 22 butter
- 23 coconut oil, a vegetable oil
- 24 oil; *kinds*: salad oil, olive oil, sunflower oil, wheatgerm oil, ground-nut oil
- 25 vinegar
- 26 stock cube
- 27 bouillon cube
- 28 mustard
- 29 gherkin (pickled gherkin)
- 30 soup seasoning
- 31 shop assistant (*Am. salesgirl*, saleslady)
- 32-34 pastas
- 32 spaghetti
- 33 macaroni
- 34 noodles
- 35-39 cereal products
- 35 pearl barley
- 36 semolina
- 37 rolled oats (porridge oats, oats)
- 38 rice
- 39 sago
- 40 salt
- 41 grocer (*Am. groceryman*), a shopkeeper (tradesman, retailer, *Am. storekeeper*)



- 42 capers
- 43 customer
- 44 receipt (sales check)
- 45 shopping bag
- 46-49 wrapping material
- 46 wrapping paper
- 47 adhesive tape
- 48 paper bag
- 49 cone-shaped paper bag
- 50 blancmange powder
- 51 whole-fruit jam (preserve)
- 52 jam
- 53-55 sugar
- 53 cube sugar
- 54 icing sugar (*Am. confectioner's sugar*)
- 55 refined sugar in crystals
- 56-59 spirits
- 56 whisky (whiskey)
- 57 rum
- 58 liqueur
- 59 brandy (cognac)
- 60-64 wine in bottles (bottled wine)
- 60 white wine
- 61 Chianti
- 62 vermouth
- 63 sparkling wine

- 64 red wine
- 65-68 tea, coffee, etc.
- 65 coffee (pure coffee)
- 66 cocoa
- 67 coffee
- 68 tea bag
- 69 electric coffee grinder
- 70 coffee roaster
- 71 roasting drum
- 72 sample scoop
- 73 price list
- 74 freezer
- 75-86 confectionery (*Am. candies*)
- 75 sweet (*Am. candy*)
- 76 drops
- 77 toffees
- 78 bar of chocolate
- 79 chocolate box
- 80 chocolate, a sweet
- 81 nougat
- 82 marzipan
- 83 chocolate liqueur
- 84 Turkish delight
- 85 croquant
- 86 truffle
- 87 soda water



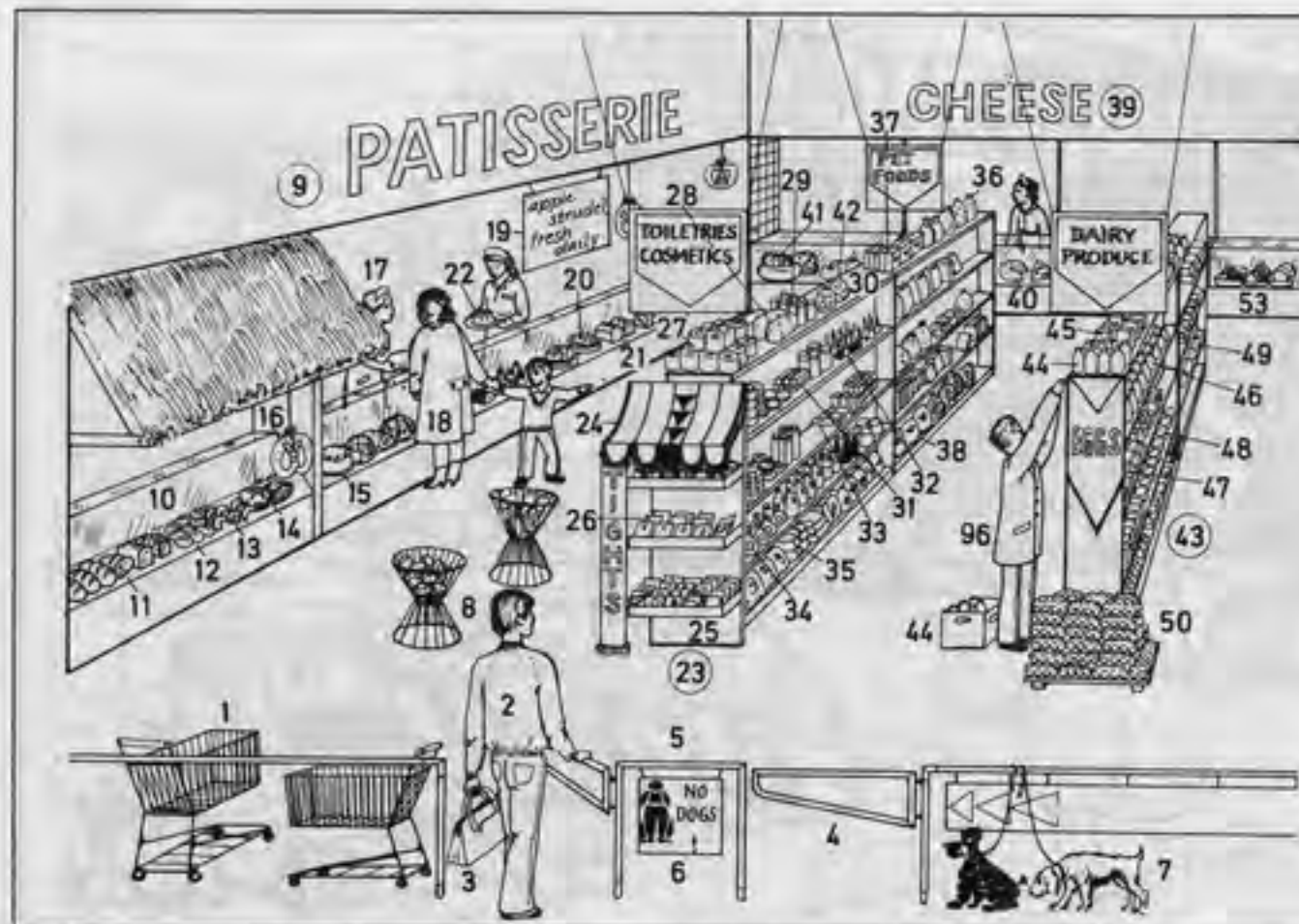

1-96 supermarket, a self-service food store

- 1 shopping trolley
- 2 customer
- 3 shopping bag
- 4 entrance to the sales area
- 5 barrier
- 6 sign (notice) banning dogs
- 7 dogs tied by their leads
- 8 basket
- 9 **bread and cake counter** (bread counter, cake counter)
- 10 display counter for bread and cakes
- 11 kinds of bread (breads)
- 12 rolls
- 13 croissants (crescent rolls, *Am.* crescents)
- 14 round loaf
- 15 gateau
- 16 pretzel [made with yeast dough]
- 17 shop assistant (*Am.* salesgirl, saleslady)
- 18 customer
- 19 sign listing goods
- 20 fruit flan
- 21 slab cake
- 22 ring cake
- 23 **cosmetics gondola**, a gondola (sales shelves)

- 24 canopy
- 25 hosiery shelf
- 26 stockings (nylons)
- 27-35 **toiletries (cosmetics)**
- 27 jar of cream (*kinds*: moisturising cream, day cream, night-care cream, hand cream)
- 28 packet of cotton wool
- 29 talcum powder
- 30 packet of cotton wool balls
- 31 toothpaste
- 32 nail varnish (nail polish)
- 33 shaving cream
- 34 bath salts
- 35 sanitary articles
- 36-37 **pet foods**
- 36 complete dog food
- 37 packet of dog biscuits
- 38 bag of cat litter
- 39 **cheese counter**
- 40 whole cheese
- 41 Swiss cheese (Emmental cheese) with holes
- 42 Edam cheese, a round cheese
- 43 gondola for dairy products
- 44 long-life milk; *also*: pasteurized milk, homogenized milk
- 45 plastic milk bag
- 46 cream

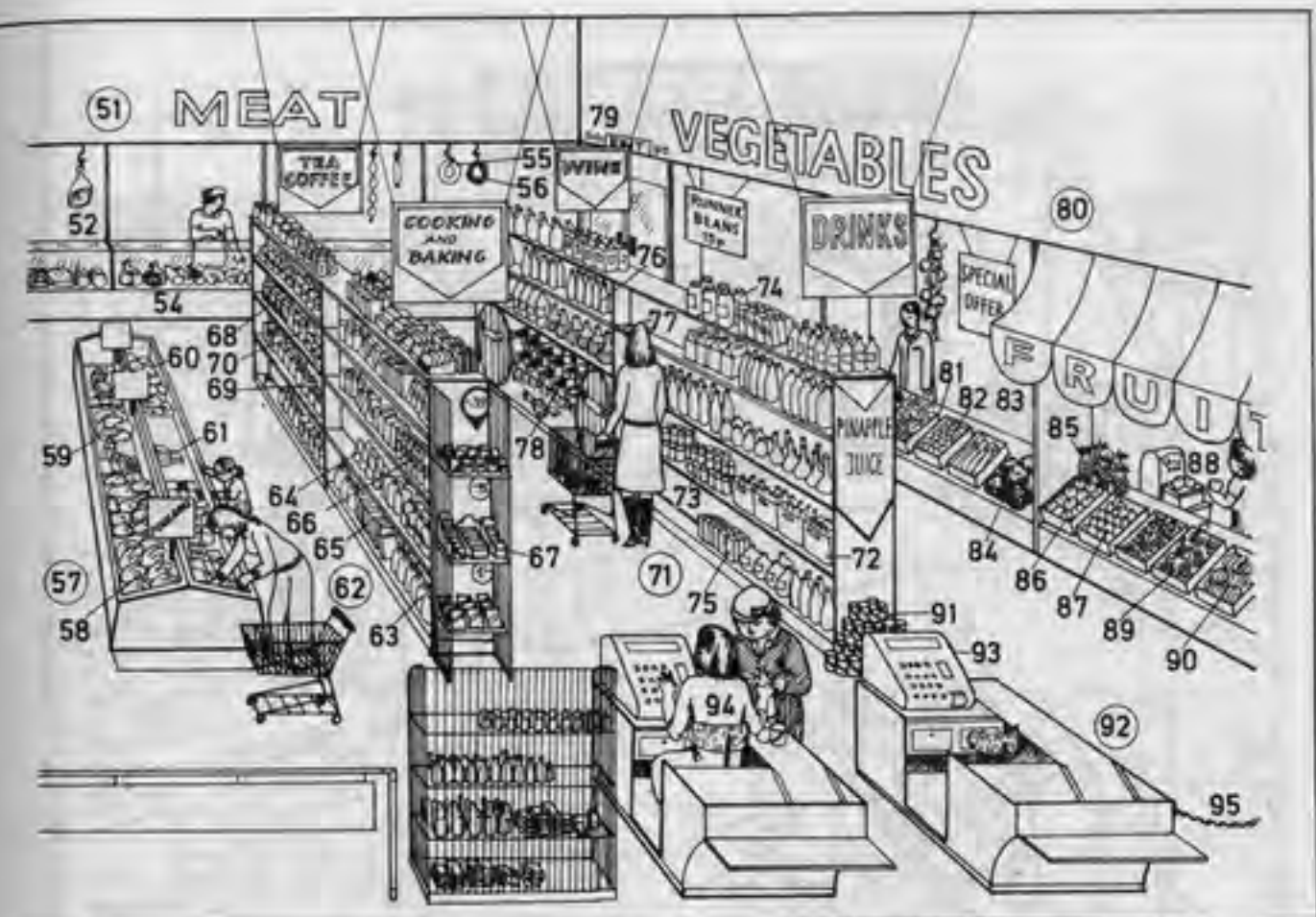

- 47 butter
- 48 margarine
- 49 box of cheeses
- 50 box of eggs
- 51 **fresh meat counter** (meat counter)
- 52 ham on the bone
- 53 meat (meat products)
- 54 sausages
- 55 ring of pork sausage
- 56 ring of blood sausage
- 57 freezer
- 58-61 **frozen food**
- 58 poulard
- 59 turkey leg (drumstick)
- 60 boiling fowl
- 61 frozen vegetables
- 62 **gondola for baking ingredients and cereal products**
- 63 wheat flour
- 64 sugar loaf
- 65 packet of noodles
- 66 salad oil
- 67 packet of spice
- 68-70 **tea, coffee, etc.**
- 68 coffee
- 69 packet of tea
- 70 instant coffee

- 71 **drinks gondola**
- 72 soft drinks
- 73 can of beer (canned beer)
- 74 bottle of fruit juice (bottled fruit juice)
- 75 can of fruit juice (canned fruit juice)
- 76 bottle of wine
- 77 bottle of Chianti
- 78 bottle of champagne
- 79 emergency exit
- 80 **fruit and vegetable counter**
- 81 vegetable basket
- 82 tomatoes
- 83 cucumbers
- 84 cauliflower
- 85 pineapple
- 86 apples
- 87 pears
- 88 scales for weighing fruit
- 89 grapes (bunches of grapes)
- 90 bananas
- 91 can
- 92 **checkout**
- 93 cash register
- 94 cashier
- 95 chain



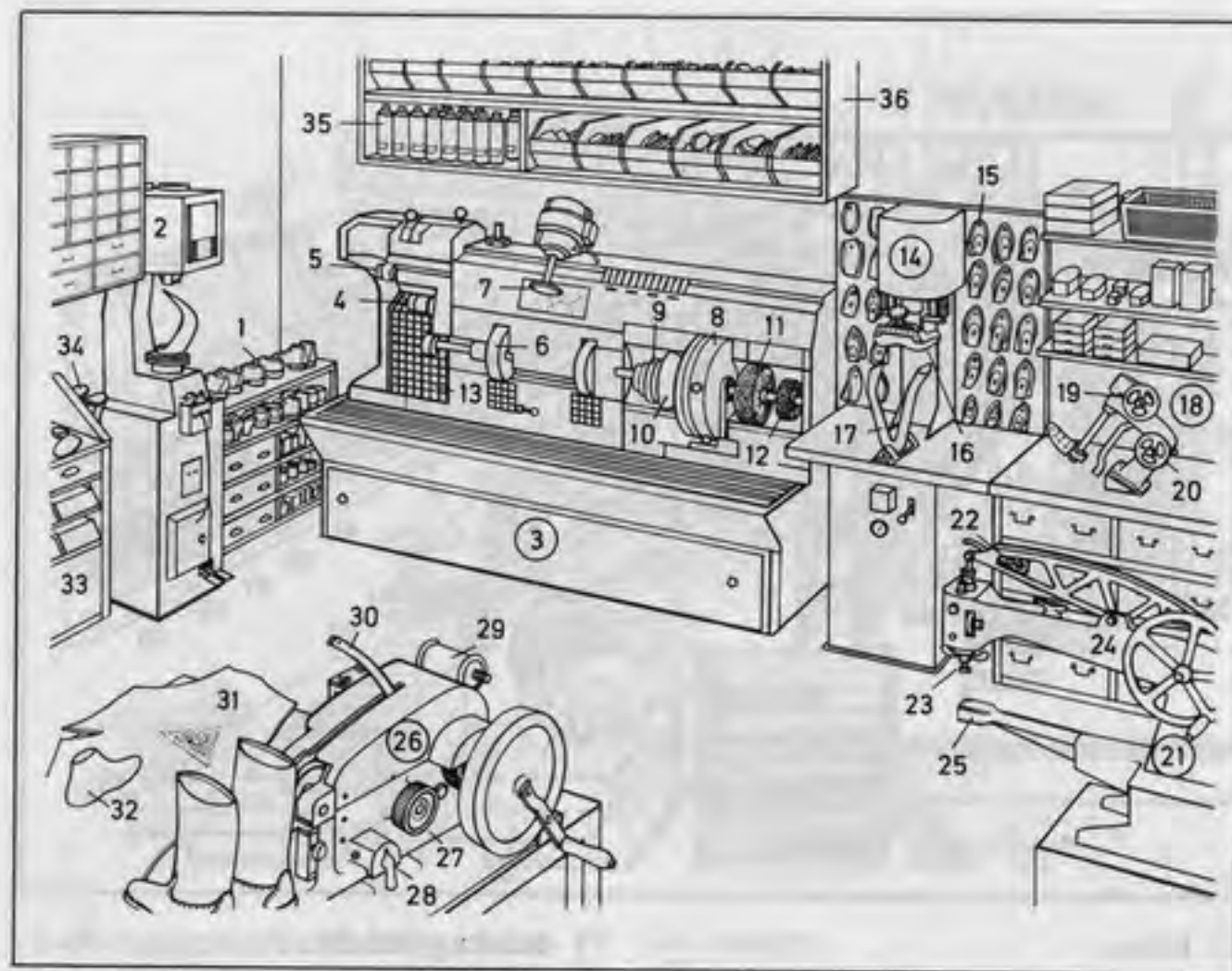

- 1-68 shoemaker's workshop (bootmaker's workshop)
- 1 finished (repaired) shoes
- 2 auto-soling machine
- 3 finishing machine
- 4 heel trimmer
- 5 sole trimmer
- 6 scouring wheel
- 7 naum keag
- 8 drive unit (drive wheel)
- 9 iron
- 10 buffing wheel
- 11 polishing brush
- 12 horsehair brush
- 13 extractor grid
- 14 automatic sole press
- 15 press attachment
- 16 pad
- 17 press bar
- 18 stretching machine
- 19 width adjustment
- 20 length adjustment
- 21 stitching machine
- 22 power regulator (power control)
- 23 foot
- 24 handwheel
- 25 arm
- 26 sole stitcher (sole-stitching machine)
- 27 foot bar lever
- 28 feed adjustment (feed setting)
- 29 bobbin (cotton bobbin)
- 30 thread guide (yarn guide)
- 31 sole leather
- 32 [wooden] last
- 33 workbench
- 34 last
- 35 dye spray
- 36 shelves for materials

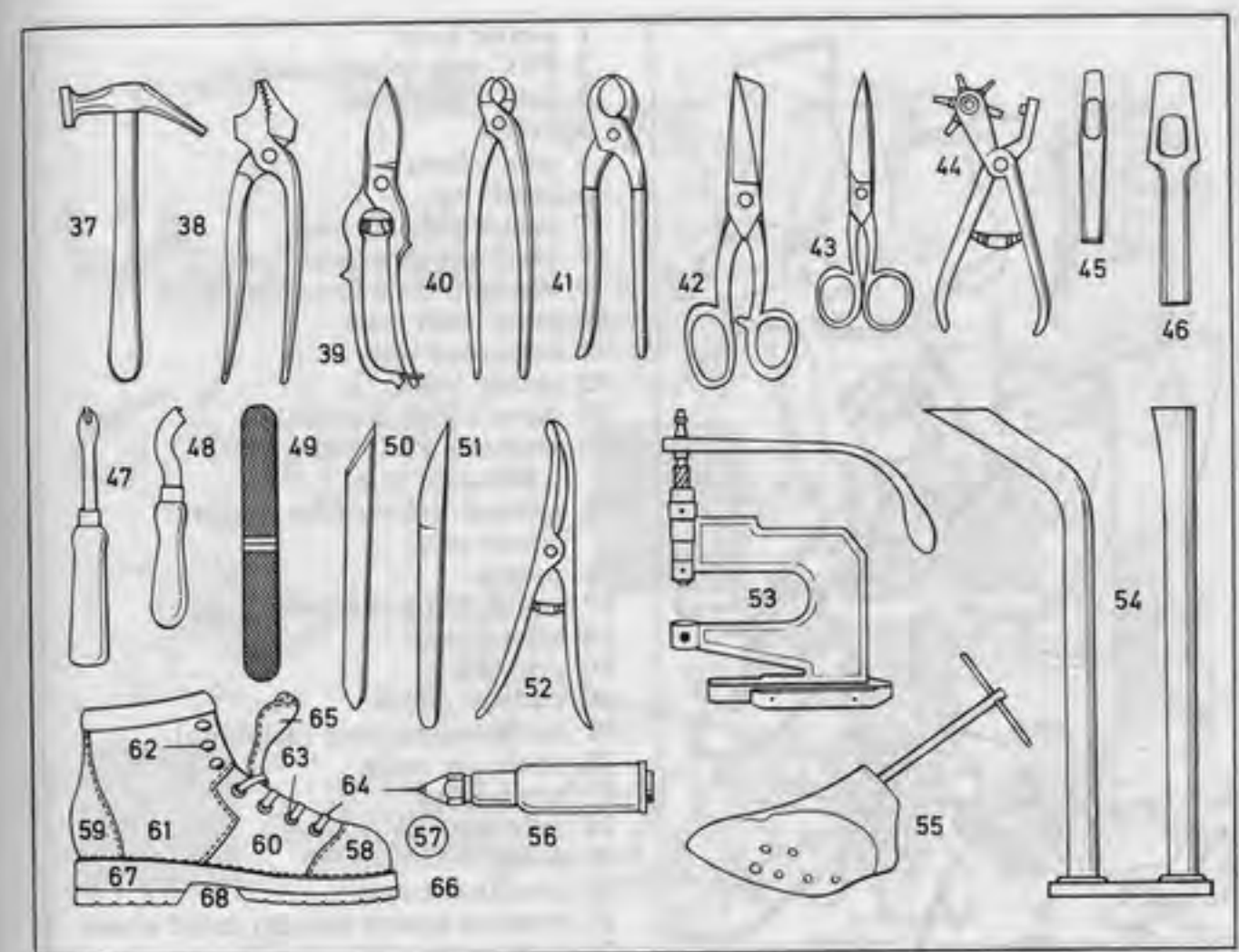

- 37 shoemaker's hammer
- 38 shoemaker's pliers (welt pincers)
- 39 sole-leather shears
- 40 small pincers (nippers)
- 41 large pincers (nippers)
- 42 upper-leather shears
- 43 scissors
- 44 revolving punch (rotary punch)
- 45 punch
- 46 punch with handle
- 47 nail puller
- 48 welt cutter
- 49 shoemaker's rasp
- 50 cobbler's knife (shoemaker's knife)
- 51 skiving knife (skife knife, paring knife)
- 52 toecap remover
- 53 eyelet, hook, and press-stud setter
- 54 stand with iron lasts
- 55 width-setting tree
- 56 nail grip
- 57 boot
- 58 toecap
- 59 counter
- 60 vamp
- 61 quarter
- 62 hook
- 63 eyelet
- 64 lace (shoelace, bootlace)
- 65 tongue
- 66 sole
- 67 heel
- 68 shank (waist)





- 1 winter boot
- 2 PVC sole (plastic sole)
- 3 high-pile lining
- 4 nylon
- 5 men's boot
- 6 inside zip
- 7 men's high leg boot
- 8 platform sole (platform)
- 9 Western boot (cowboy boot)
- 10 pony-skin boot
- 11 cemented sole
- 12 ladies' boot
- 13 mens's high leg boot
- 14 seamless PVC waterproof wellington boot
- 15 natural-colour (*Am.* natural-color) sole
- 16 toecap
- 17 tricot lining (knitwear lining)
- 18 hiking boot
- 19 grip sole
- 20 padded collar
- 21 tie fastening (lace fastening)
- 22 open-toe mule
- 23 terry upper
- 24 polo outsole
- 25 mule
- 26 corduroy upper
- 27 evening sandal (sandal court shoe)
- 28 high heel (stiletto heel)
- 29 court shoe (*Am.* pump)
- 30 moccasin
- 31 shoe, a tie shoe (laced shoe, Oxford shoe, *Am.* Oxford)
- 32 tongue
- 33 high-heeled shoe (shoe with raised heel)
- 34 casual
- 35 trainer (training shoe)
- 36 tennis shoe
- 37 counter (stiffening)
- 38 natural-colour (*Am.* natural-color) rubber sole
- 39 heavy-duty boot (*Am.* stogy, stogie)
- 40 toecap
- 41 slipper
- 42 woollen (*Am.* woolen) slip sock
- 43 knit stitch (knit)
- 44 clog
- 45 wooden sole
- 46 soft-leather upper
- 47 sabot
- 48 toe post sandal
- 49 ladies' sandal
- 50 surgical footbed (sock)
- 51 sandal
- 52 shoe buckle (buckle)
- 53 sling-back court shoe (*Am.* sling pump)
- 54 fabric court shoe
- 55 wedge heel
- 56 baby's first walking boot

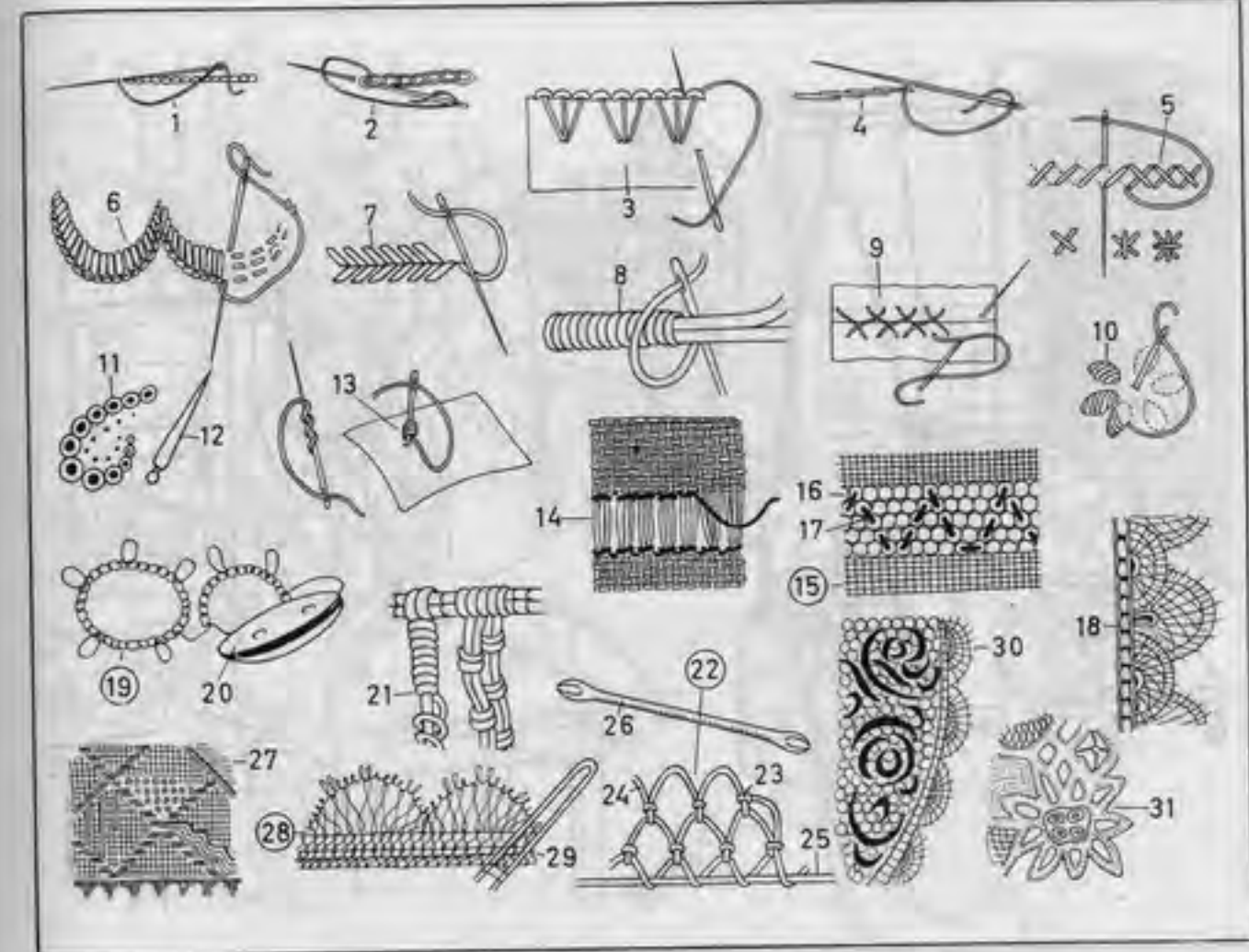

- 1 backstitch seam
- 2 chain stitch
- 3 ornamental stitch
- 4 stem stitch
- 5 cross stitch
- 6 buttonhole stitch (button stitch)
- 7 fishbone stitch
- 8 overcast stitch
- 9 herringbone stitch (Russian stitch, Russian cross stitch)
- 10 satin stitch (flat stitch)
- 11 eyelet embroidery (broderie anglaise)
- 12 stiletto
- 13 French knot (French dot, knotted stitch, twisted knot stitch)
- 14 hem stitch work
- 15 tulle work (tulle lace)
- 16 tulle background (net background)
- 17 darning stitch
- 18 pillow lace (bobbin lace, bone lace); *kinds:* Valenciennes, Brussels lace
- 19 tatting
- 20 tatting shuttle (shuttle)
- 21 knotted work (macramé)
- 22 filet (netting)
- 23 netting loop
- 24 netting thread
- 25 mesh pin (mesh gauge)
- 26 netting needle
- 27 open work
- 28 gimping (hairpin work)
- 29 gimping needle (hairpin)
- 30 needlepoint lace (point lace, needlepoint); *kinds:* reticella lace, Venetian lace, Alençon lace; *sim.* with metal thread: filigree work
- 31 braid embroidery (braid work)

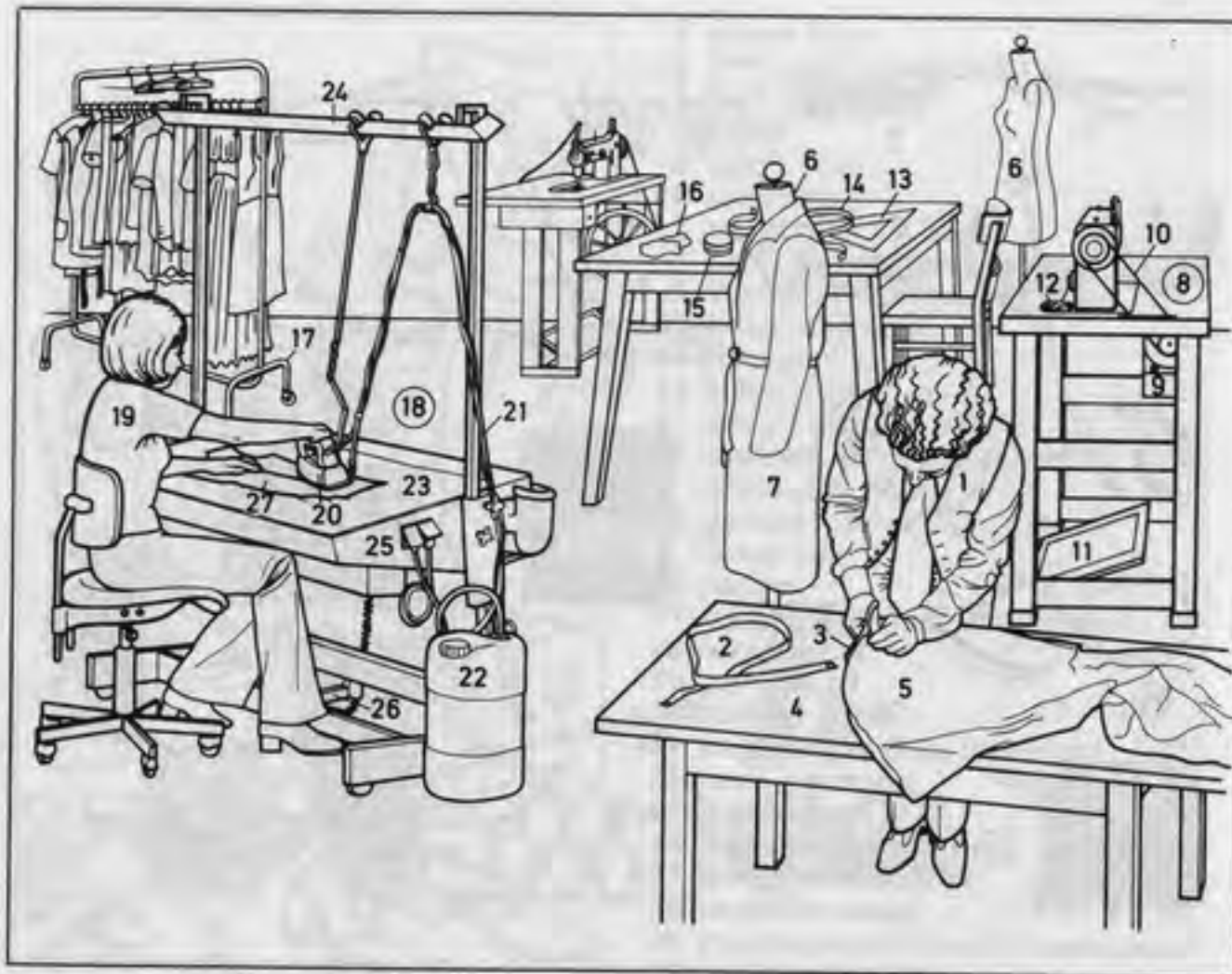

**1-27 dressmaker's workroom**

- 1 dressmaker
- 2 tape measure (measuring tape), a metre (*Am.* meter) tape measure
- 3 cutting shears
- 4 cutting table
- 5 model dress
- 6 dressmaker's model (dressmaker's dummy, dress form)
- 7 model coat
- 8 sewing machine
- 9 drive motor
- 10 drive belt
- 11 treadle
- 12 sewing machine cotton (sewing machine thread) [on bobbin]
- 13 cutting template
- 14 seam binding
- 15 button box
- 16 remnant
- 17 movable clothes rack
- 18 hand-iron press
- 19 presser (ironer)
- 20 steam iron
- 21 water feed pipe
- 22 water container
- 23 adjustable-tilt ironing surface
- 24 lift device for the iron
- 25 steam extractor
- 26 foot switch controlling steam extraction
- 27 pressed non-woven woollen (*Am.* woolen) fabric

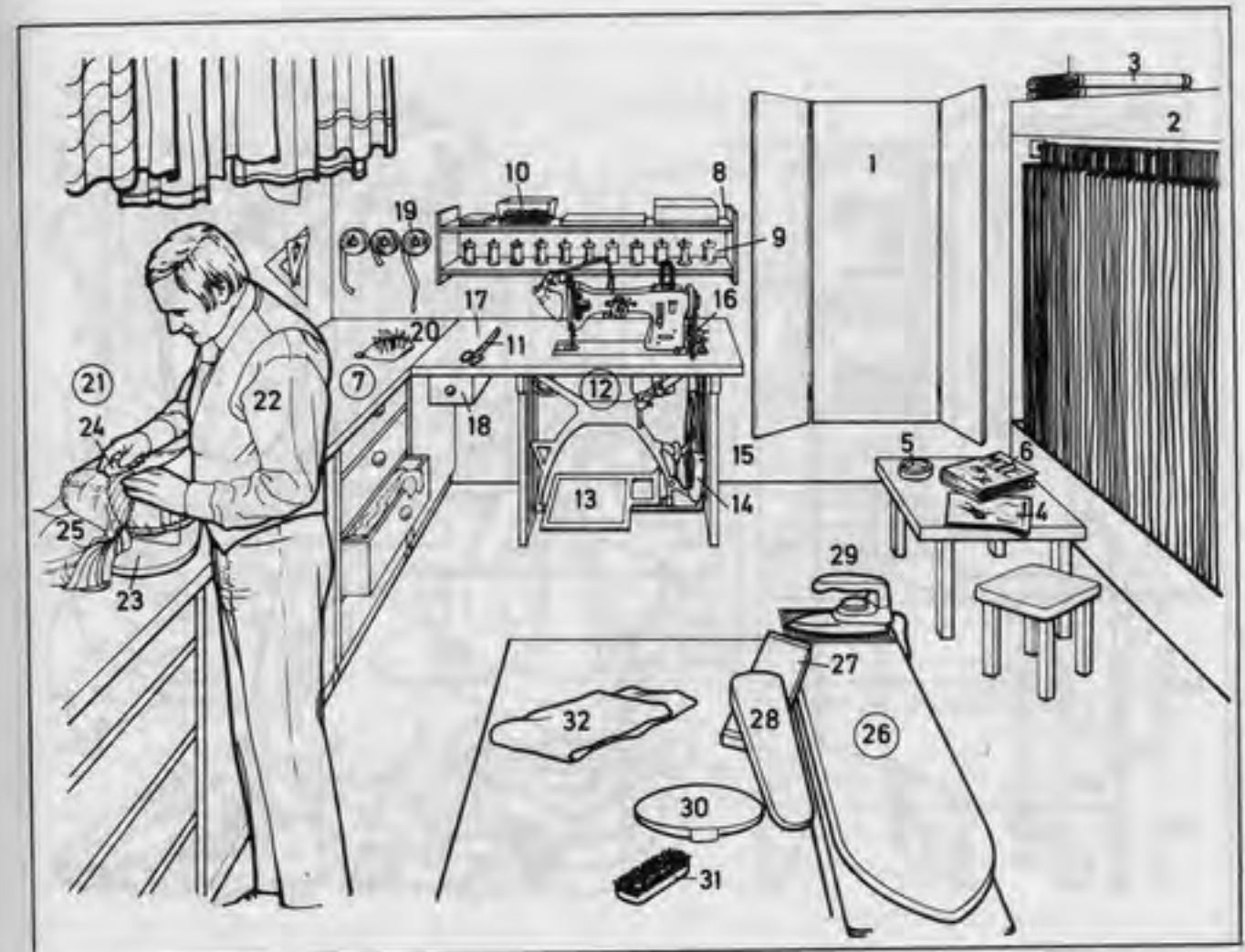
**1-32 tailor's workroom**

- 1 triple mirror
- 2 lengths of material
- 3 suiting
- 4 fashion journal (fashion magazine)
- 5 ashtray
- 6 fashion catalogue
- 7 workbench
- 8 wall shelves (wall shelf unit)
- 9 cotton reel
- 10 small reels of sewing silk
- 11 hand shears
- 12 combined electric and treadle sewing machine
- 13 treadle
- 14 dress guard
- 15 band wheel
- 16 bobbin thread
- 17 sewing machine table
- 18 sewing machine drawer
- 19 seam binding
- 20 pincushion
- 21 marking out
- 22 tailor
- 23 shaping pad
- 24 tailor's chalk (French chalk)
- 25 workpiece
- 26 steam press (steam pressing unit)
- 27 swivel arm
- 28 pressing cushion (pressing pad)
- 29 iron
- 30 hand-ironing pad
- 31 clothes brush
- 32 pressing cloth



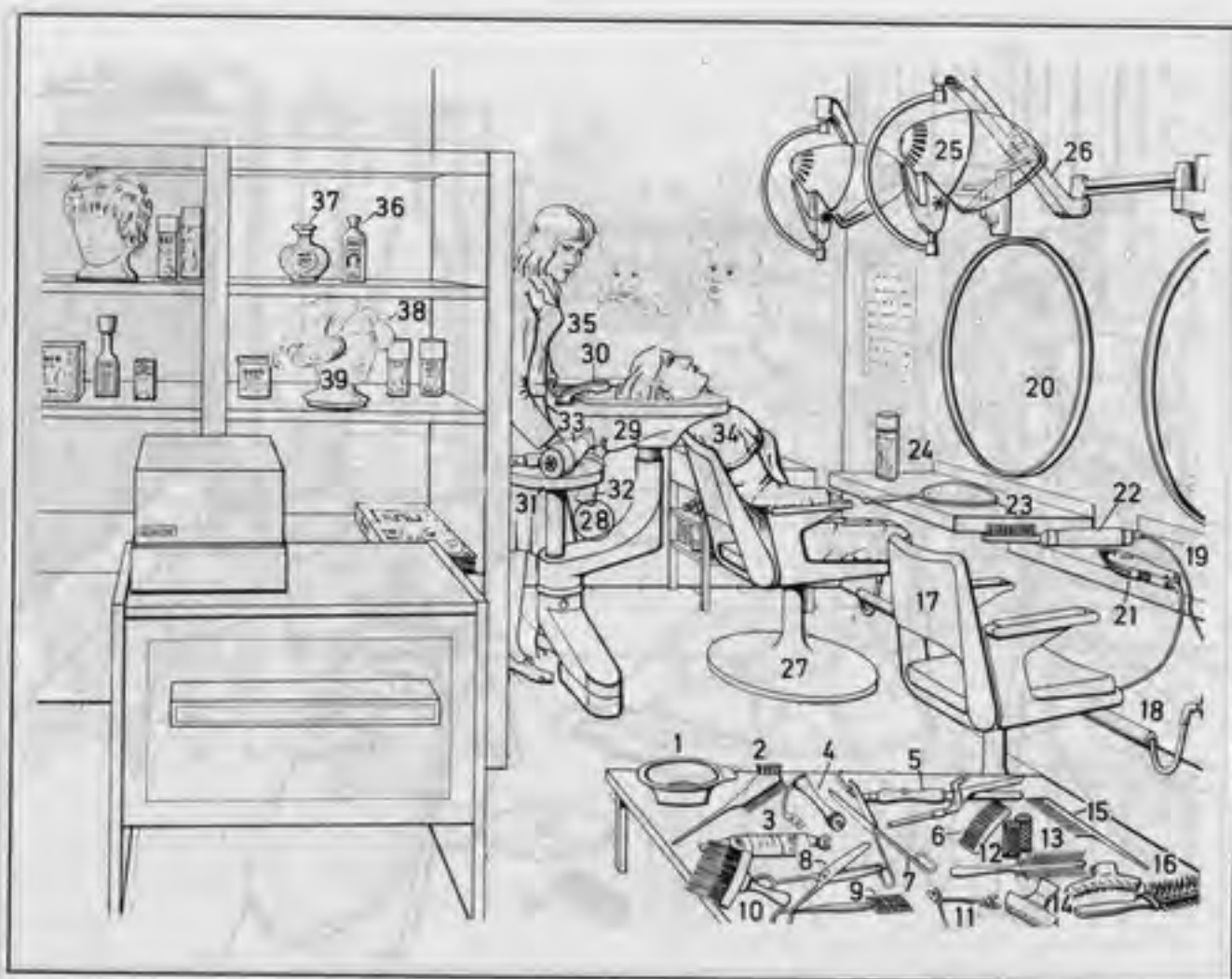

**1-39 ladies' hairdressing salon and beauty salon** (*Am.* beauty parlor, beauty shop)

**1-16 hairdresser's tools**

- 1 bowl containing bleach
- 2 detangling brush
- 3 bleach tube
- 4 curler [used in dyeing]
- 5 curling tongs (curling iron)
- 6 comb (back comb, side comb)
- 7 haircutting scissors
- 8 thinning scissors (*Am.* thinning shears)
- 9 thinning razor
- 10 hairbrush
- 11 hair clip
- 12 roller
- 13 curl brush
- 14 curl clip
- 15 dressing comb
- 16 stiff-bristle brush
- 17 adjustable hairdresser's chair
- 18 footrest
- 19 dressing table
- 20 salon mirror (mirror)
- 21 electric clippers

- 22 warm-air comb
- 23 hand mirror (hand glass)
- 24 hair spray (hair-fixing spray)
- 25 drier, a swivel-mounted drier
- 26 swivel arm of the drier
- 27 round base
- 28 shampoo unit
- 29 shampoo basin
- 30 hand spray (shampoo spray)
- 31 service tray
- 32 shampoo bottle
- 33 hair drier (hand hair drier, hand-held hair drier)
- 34 cape (gown)
- 35 hairdresser
- 36 perfume bottle
- 37 bottle of toilet water
- 38 wig
- 39 wig block



- 1-42 men's salon** (men's hairdressing salon, barber's shop, *Am.* barbershop)
- 1 hairdresser (barber)
  - 2 overalls (hairdresser's overalls)
  - 3 hairstyle (haircut)
  - 4 cape (gown)
  - 5 paper towel
  - 6 salon mirror (mirror)
  - 7 hand mirror (hand glass)
  - 8 light
  - 9 toilet water
  - 10 hair tonic
  - 11 shampoo unit
  - 12 shampoo basin
  - 13 hand spray (shampoo spray)
  - 14 mixer tap (*Am.* mixing faucet)
  - 15 sockets, e.g. for hair drier
  - 16 adjustable hairdresser's chair (barber's chair)
  - 17 height-adjuster bar (height adjuster)
  - 18 armrest
  - 19 footrest
  - 20 shampoo
  - 21 perfume spray

- 22 hair drier (hand hair drier, hand-held hair drier)
- 23 setting lotion in a spray can
- 24 hand towels for drying hair
- 25 towels for face compresses
- 26 crimping iron
- 27 neck brush
- 28 dressing comb
- 29 warm-air comb
- 30 warm-air brush
- 31 curling tongs (hair curler, curling iron)
- 32 electric clippers
- 33 thinning scissors (*Am.* thinning shears)
- 34 haircutting scissors; *sim.*: styling scissors
- 35 scissor-blade
- 36 pivot
- 37 handle
- 38 open razor (straight razor)
- 39 razor handle
- 40 edge (cutting edge, razor's edge, razor's cutting edge)
- 41 thinning razor
- 42 diploma



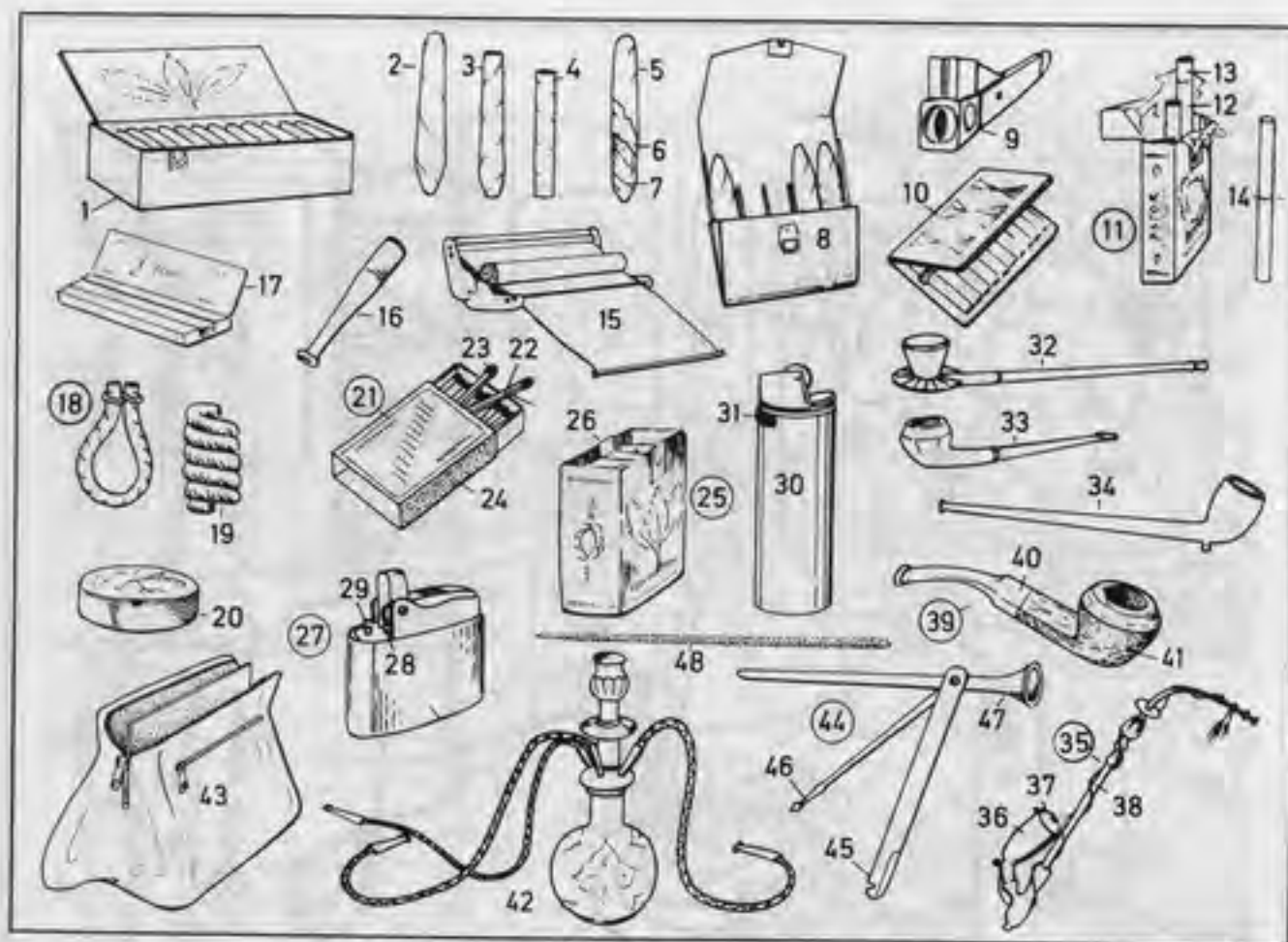

- |   |  |
|---|--|
| 1 cigar box   | 25 packet of tobacco; <i>kinds</i> : fine cut, shag, navy plug |
| 2 cigar; <i>kinds</i> : Havana cigar (Havana), Brazilian cigar, Sumatra cigar | 26 revenue stamp   |
| 3 cigarillo   | 27 petrol cigarette lighter (petrol lighter)                   |
| 4 cheroot   | 28 flint   |
| 5 wrapper   | 29 wick  |
| 6 binder  | 30 gas cigarette lighter (gas lighter), a disposable lighter   |
| 7 filler  | 31 flame regulator   |
| 8 cigar case  | 32 chibonk (chibonque)   |
| 9 cigar cutter  | 33 short pipe  |
| 10 cigarette case   | 34 clay pipe (Dutch pipe)                                      |
| 11 cigarette packet ( <i>Am. pack</i> )                                       | 35 long pipe   |
| 12 cigarette, a filter-tipped cigarette                                       | 36 pipe bowl (bowl)  |
| 13 cigarette tip; <i>kinds</i> : cork tip, gold tip                           | 37 bowl lid  |
| 14 Russian cigarette  | 38 pipe stem (stem)  |
| 15 cigarette roller   | 39 briar pipe  |
| 16 cigarette holder   | 40 mouthpiece  |
| 17 packet of cigarette papers   | 41 sand-blast finished or polished briar grain                 |
| 18 pigtail (twist of tobacco)   | 42 hookah (narghile, narghileh), a water pipe                  |
| 19 chewing tobacco; <i>a piece</i> : plug (quid, chew)                        | 43 tobacco pouch   |
| 20 snuff box, containing snuff  | 44 smoker's companion  |
| 21 matchbox   | 45 pipe scraper  |
| 22 match  | 46 pipe cleaner  |
| 23 head (match head)  | 47 tobacco presser   |
| 24 striking surface   | 48 pipe cleaner  |

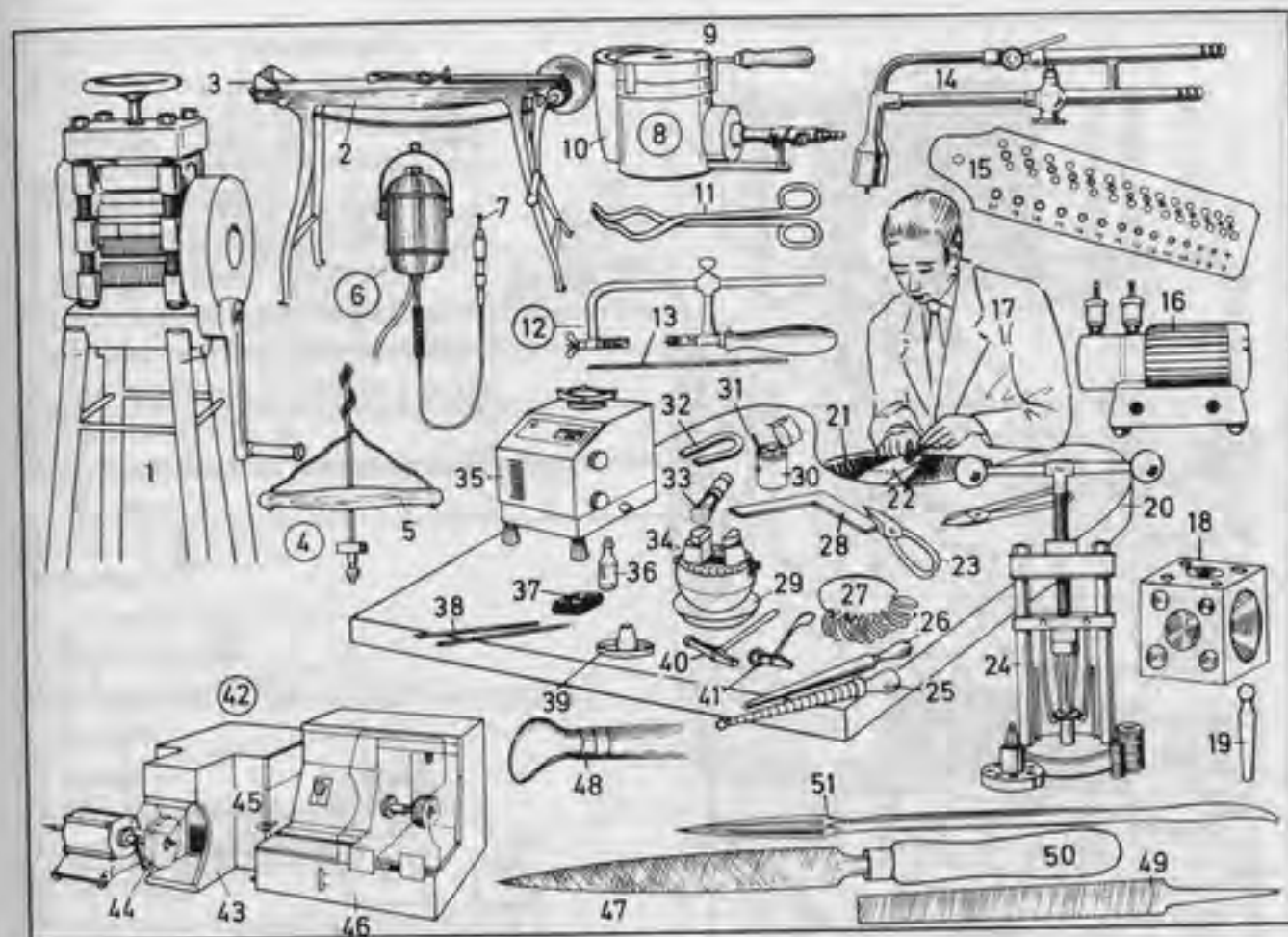

- |   |   |
|---|---|
| 1 wire and sheet roller                         | 27 ring gauge ( <i>Am. gage</i> )                               |
| 2 drawbench (drawing bench)                     | 28 steel set-square   |
| 3 wire (gold or silver wire)                    | 29 leather pad  |
| 4 archimedes drill (drill)                      | 30 box of punches   |
| 5 crossbar                                      | 31 punch  |
| 6 suspended (pendant) electric drilling machine | 32 magnet   |
| 7 spherical cutter (cherry)                     | 33 bench brush  |
| 8 melting pot                                   | 34 engraving ball (joint vice, clamp)                           |
| 9 fireclay top                                  | 35 gold and silver balance (assay balance), a precision balance |
| 10 graphite crucible                            | 36 soldering flux (flux)  |
| 11 crucible tongs                               | 37 charcoal block   |
| 12 piercing saw (jig saw)                       | 38 stick of solder  |
| 13 piercing saw blade                           | 39 soldering borax  |
| 14 soldering gun                                | 40 shaping hammer   |
| 15 thread tapper                                | 41 chasing (enchasing) hammer                                   |
| 16 blast burner (blast lamp) for soldering      | 42 polishing and burnishing machine                             |
| 17 goldsmith                                    | 43 dust exhaustor (vacuum cleaner)                              |
| 18 swage block                                  | 44 polishing wheel  |
| 19 punch  | 45 dust collector (dust catcher)                                |
| 20 workbench (bench)                            | 46 buffing machine  |
| 21 bench apron                                  | 47 round file   |
| 22 needle file                                  | 48 bloodstone (haematite, hematite)                             |
| 23 metal shears                                 | 49 flat file  |
| 24 wedding ring sizing machine                  | 50 file handle  |
| 25 ring gauge ( <i>Am. gage</i> )               | 51 polishing iron (burnisher)                                   |
| 26 ring-rounding tool                           |   |



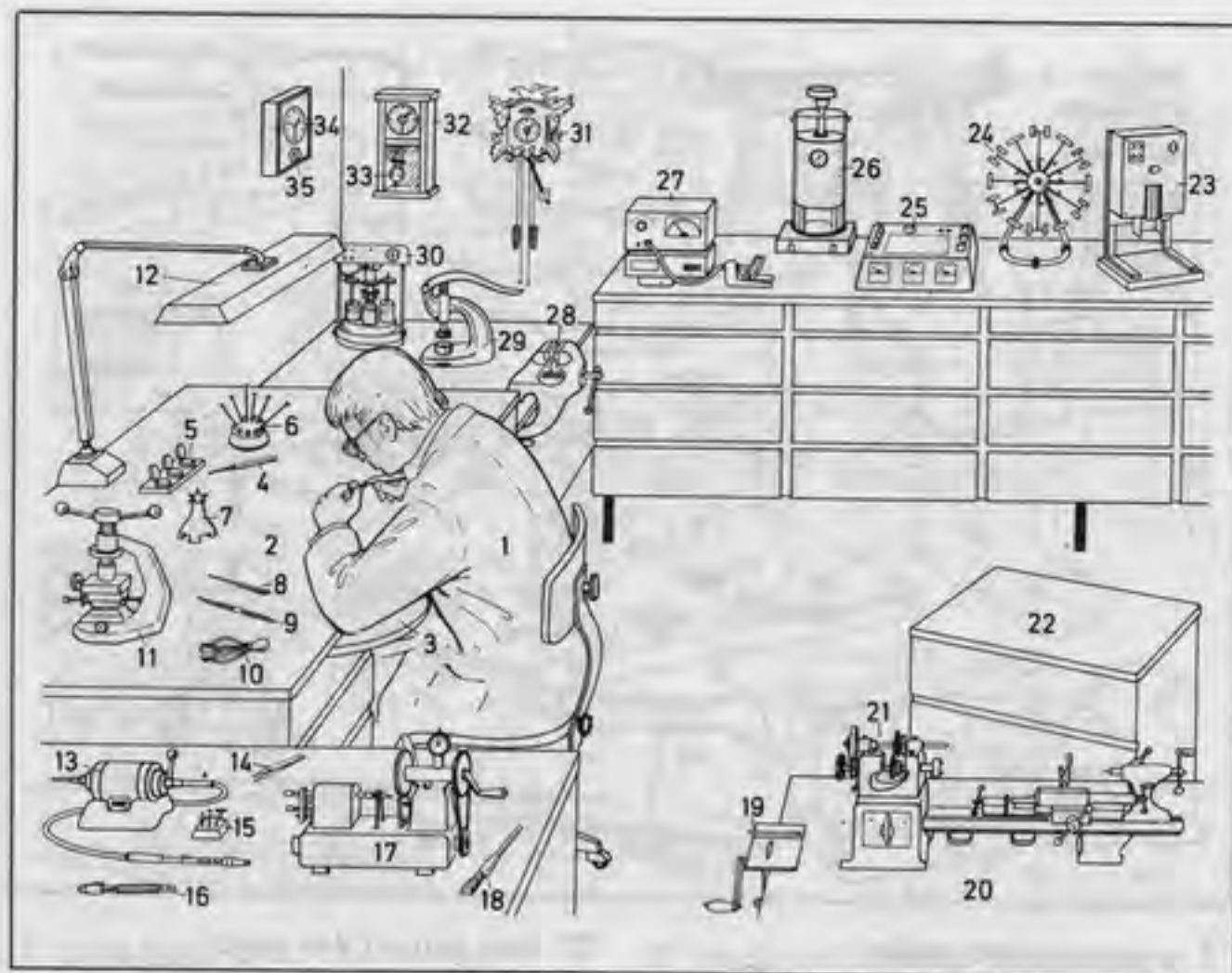

- 1 watchmaker; *also*: clockmaker
- 2 workbench
- 3 armrest
- 4 oiler
- 5 oil stand
- 6 set of screwdrivers
- 7 clockmaker's anvil
- 8 broach, a reamer
- 9 spring pin tool
- 10 hand-removing tool
- 11 watchglass-fitting tool
- 12 workbench lamp, a multi-purpose lamp
- 13 multi-purpose motor
- 14 tweezers
- 15 polishing machine attachments
- 16 pin vice (pin holder)
- 17 burnisher, for burnishing, polishing, and shortening of spindles
- 18 dust brush
- 19 cutter for metal watch straps
- 20 precision bench lathe (watchmaker's lathe)
- 21 drive-belt gear

- 22 workshop trolley for spare parts
- 23 ultrasonic cleaner
- 24 rotating watch-testing machine for automatic watches
- 25 watch-timing machine for electronic components
- 26 testing device for waterproof watches
- 27 electronic timing machine
- 28 vice (*Am.* vise)
- 29 watchglass-fitting tool for armoured (*Am.* armored) glasses
- 30 [automatic] cleaning machine for conventional cleaning
- 31 cuckoo clock (Black Forest clock)
- 32 wall clock (regulator)
- 33 compensation pendulum
- 34 kitchen clock
- 35 timer

- 1 electronic wristwatch
- 2 digital readout, a light-emitting diode (LED) readout; *also*: liquid crystal readout
- 3 hour and minute button
- 4 date and second button
- 5 strap (watch strap)
- 6 tuning fork principle (principle of the tuning fork watch)
- 7 power source (battery cell)
- 8 transformer
- 9 tuning fork element (oscillating element)
- 10 wheel ratchet
- 11 wheels
- 12 minute hand
- 13 hour hand
- 14 principle of the electronic quartz watch
- 15 quartz
- 16 integrated circuit
- 17 oscillation counter
- 18 decoder
- 19 calendar clock (alarm clock)
- 20 digital display with flip-over numerals
- 21 second indicator
- 22 stop button
- 23 forward and backward wind knob
- 24 grandfather clock
- 25 face
- 26 clock case
- 27 pendulum
- 28 striking weight
- 29 time weight
- 30 sundial
- 31 hourglass (egg timer)
- 32-43 **components of an automatic watch** (automatic wristwatch)
- 32 weight (rotor)
- 33 stone (jewel, jewelled bearing), a synthetic ruby
- 34 click
- 35 click wheel
- 36 clockwork (clockwork mechanism)
- 37 bottom train plate
- 38 spring barrel
- 39 balance wheel
- 40 escape wheel
- 41 crown wheel
- 42 winding crown
- 43 drive mechanism

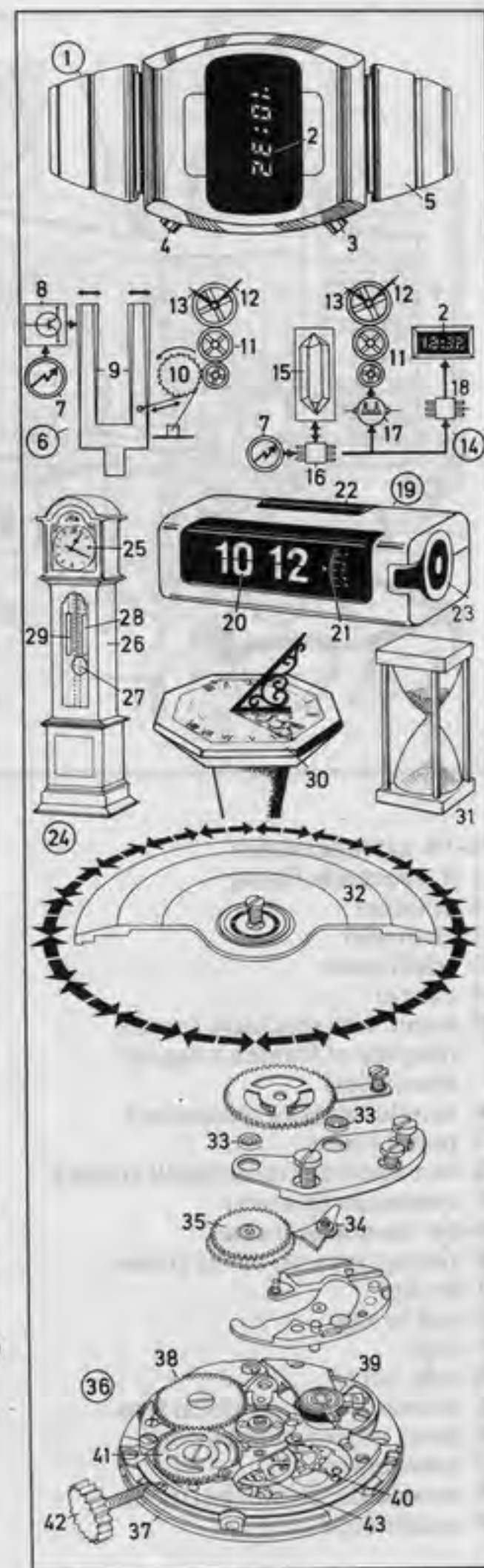

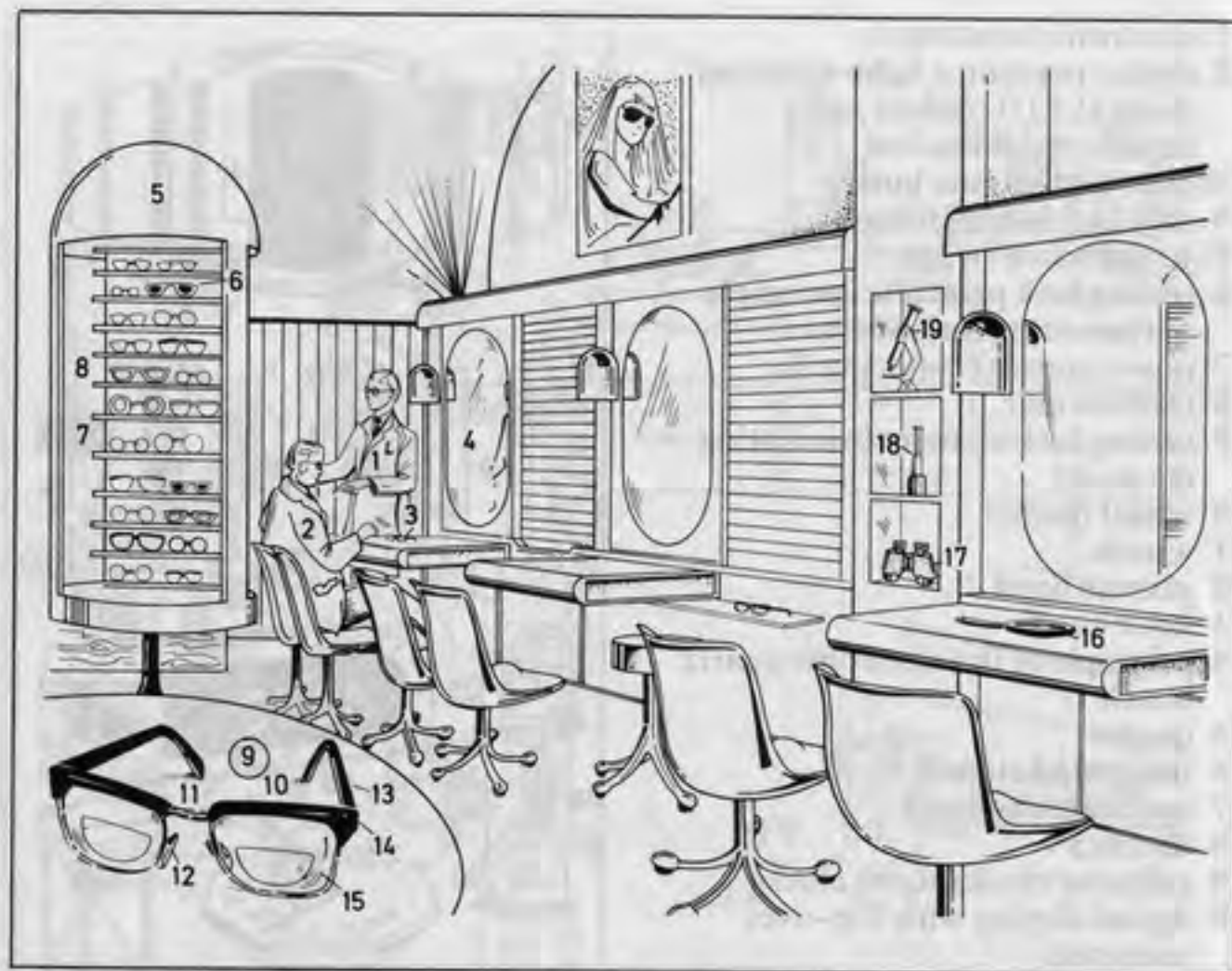

**1-19 sales premises****1-4 spectacle fitting**

- 1 optician
- 2 customer
- 3 trial frame
- 4 mirror
- 5 stand with spectacle frames (display of frames, range of spectacles)
- 6 sunglasses (sun spectacles)
- 7 metal frame
- 8 tortoiseshell frame (shell frame)
- 9 spectacles (glasses)

**10-14 spectacle frame**

- 10 fitting (mount) of the frame
- 11 bridge
- 12 pad bridge
- 13 side
- 14 side joint
- 15 spectacle lens, a bifocal lens

**20-47 optician's workshop**

- 20 workbench
- 21 universal centring (centering) apparatus
- 22 centring (centering) suction holder
- 23 sucker
- 24 edging machine
- 25 formers for the lens edging machine
- 26 inserted former
- 27 rotating printer
- 28 abrasive wheel combination
- 29 control unit
- 30 machine part
- 31 cooling water pipe
- 32 cleaning fluid
- 33 focimeter (vertex refractionometer)
- 34 metal-blocking device
- 35 abrasive wheel combination and forms of edging
- 36 roughing wheel for preliminary surfacing

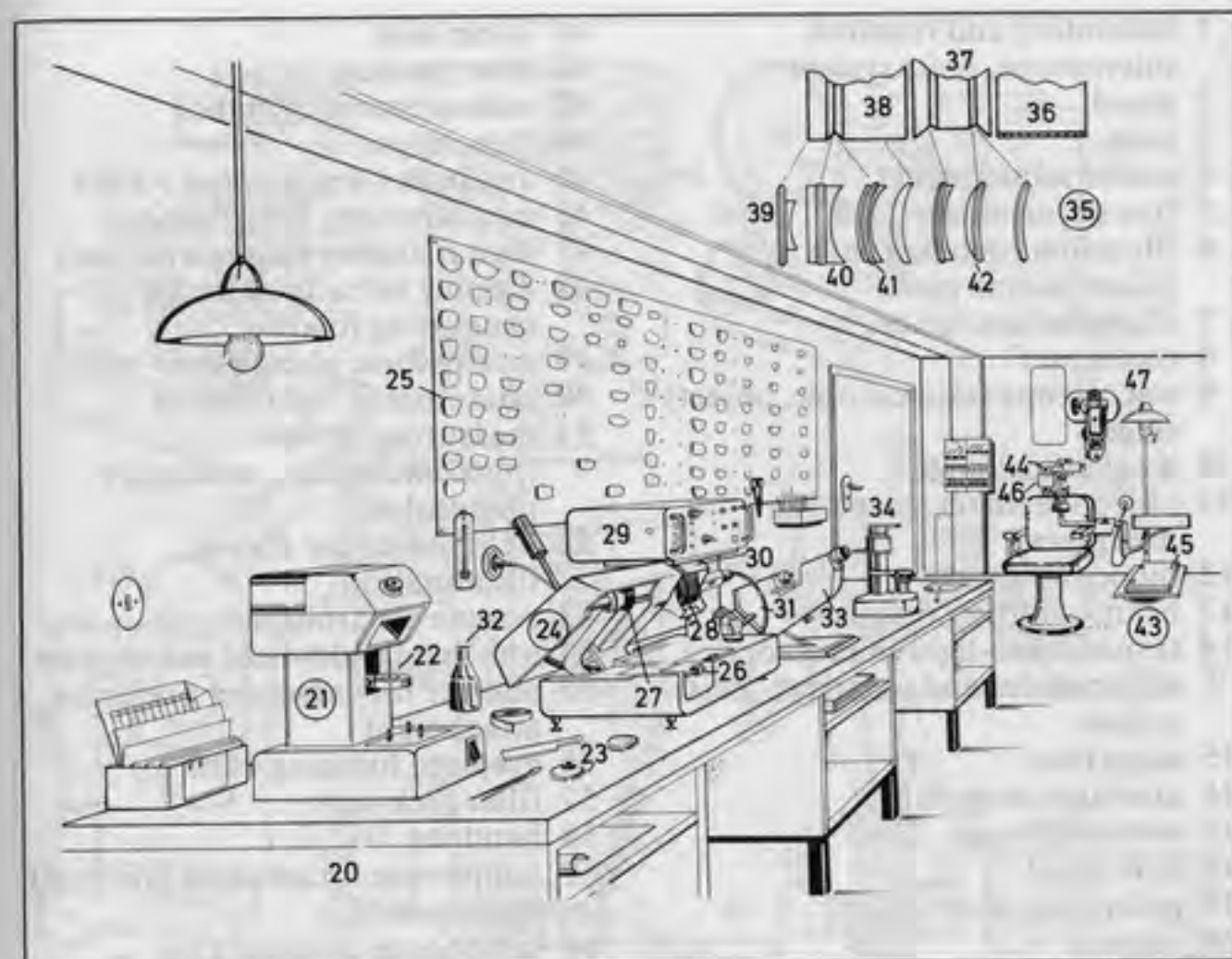

- 37 fining lap for positive and negative lens surfaces
- 38 fining lap for special and flat lenses
- 39 plano-concave lens with a flat surface
- 40 plano-concave lens with a special surface
- 41 concave and convex lens with a special surface
- 42 convex and concave lens with a special surface
- 43 ophthalmic test stand
- 44 phoropter with ophthalmometer and optometer (refractometer)
- 45 trial lens case
- 46 collimator
- 47 acuity projector



- 1 laboratory and research microscope, *Leitz system*
- 2 stand
- 3 base
- 4 coarse adjustment
- 5 fine adjustment
- 6 illumination beam path (illumination path)
- 7 illumination optics
- 8 condenser
- 9 microscope (microscopic, object) stage
- 10 mechanical stage
- 11 objective turret (revolving nosepiece)
- 12 binocular head
- 13 beam-splitting prisms
- 14 transmitted-light microscope with camera and polarizer, *Zeiss system*
- 15 stage base
- 16 aperture-stop slide
- 17 universal stage
- 18 lens panel
- 19 polarizing filter
- 20 camera
- 21 focusing screen
- 22 discussion tube arrangement
- 23 wide-field metallurgical microscope, a reflected-light microscope (microscope for reflected light)
- 24 matt screen (ground glass screen, projection screen)
- 25 large-format camera
- 26 miniature camera
- 27 base plate
- 28 lamphouse
- 29 mechanical stage
- 30 objective turret (revolving nosepiece)
- 31 surgical microscope
- 32 pillar stand
- 33 field illumination
- 34 photomicroscope
- 35 miniature film cassette
- 36 photomicrographic camera attachment for large-format or television camera
- 37 surface-finish microscope
- 38 light section tube
- 39 rack and pinion
- 40 zoom stereomicroscope
- 41 zoom lens
- 42 dust counter
- 43 measurement chamber
- 44 data output
- 45 analogue (*Am.* analog) output
- 46 measurement range selector
- 47 digital display (digital readout)
- 48 dipping refractometer for examining food
- 49 microscopic photometer
- 50 photometric light source
- 51 measuring device (photomultiplier, multiplier phototube)
- 52 light source for survey illumination
- 53 remote electronics
- 54 universal wide-field microscope
- 55 adapter for camera or projector attachment
- 56 eyepiece focusing knob
- 57 filter pick-up
- 58 handrest
- 59 lamphouse for incident (vertical) illumination
- 60 lamphouse connector for transillumination
- 61 wide-field stereomicroscope
- 62 interchangeable lenses (objectives)
- 63 incident (vertical) illumination (incident top lighting)
- 64 fully automatic microscope camera, a camera with photomicro mount adapter
- 65 film cassette
- 66 universal condenser for research microscope I
- 67 universal-type measuring machine for photogrammetry (phototheodolite)
- 68 photogrammetric camera
- 69 motor-driven level, a compensator level
- 70 electro-optical distance-measuring instrument
- 71 stereometric camera
- 72 horizontal base
- 73 one-second theodolite

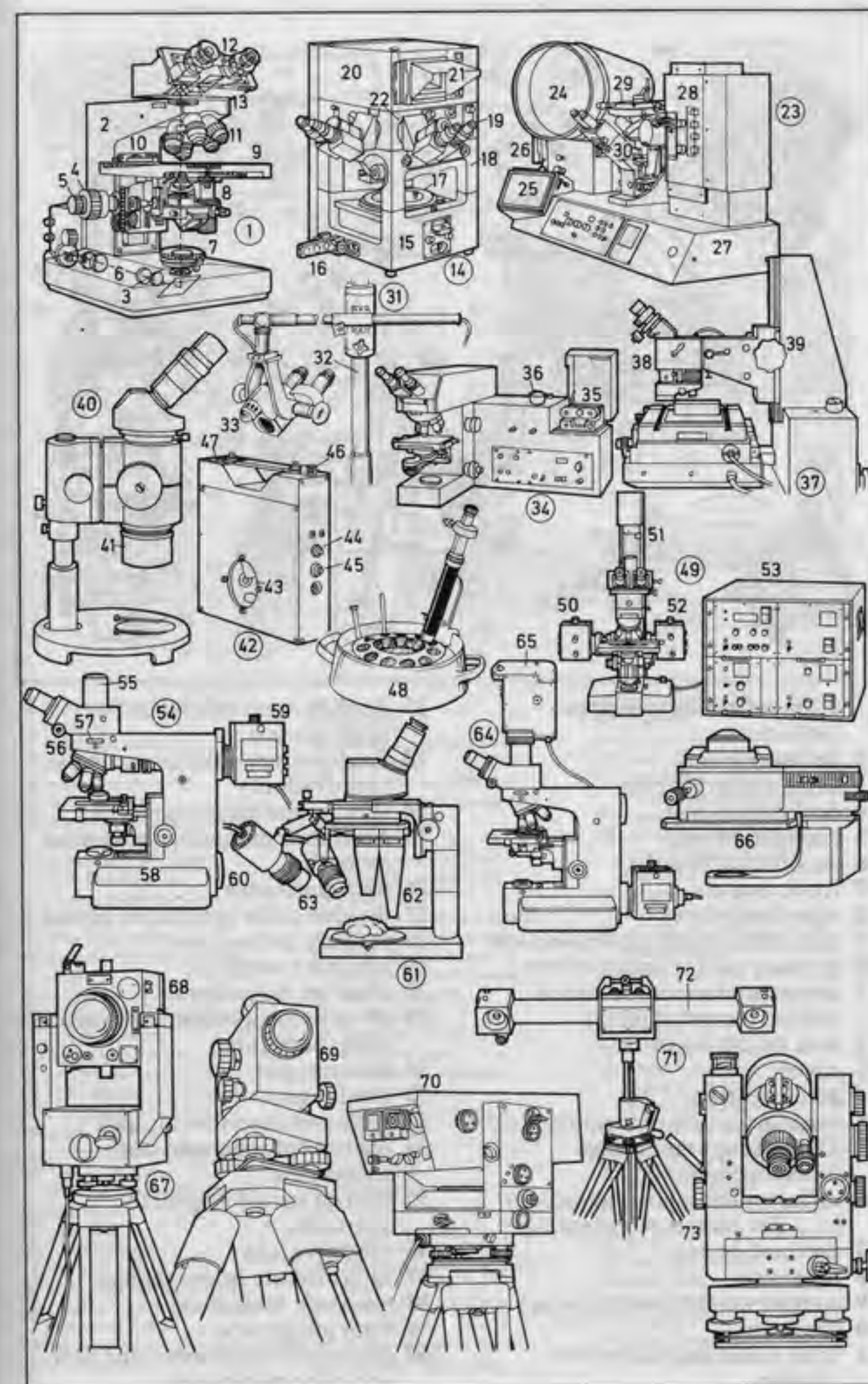



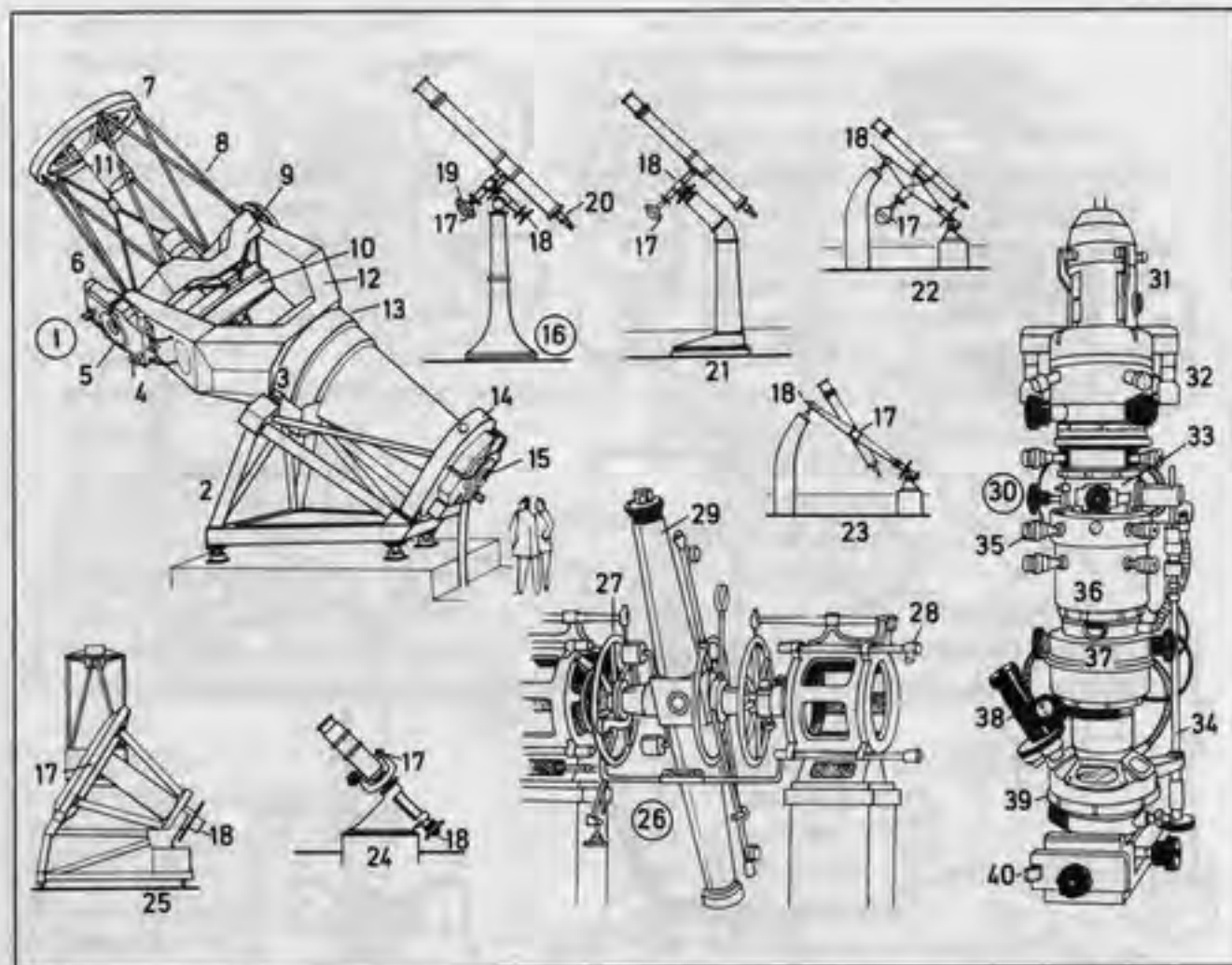

- |   |  |
|---|--|
| 1 2.2 m reflecting telescope (reflector)                      | 22 English-type axis mounting (axis mount)           |
| 2 pedestal (base)   | 23 English-type yoke mounting (yoke mount)           |
| 3 axial-radial bearing  | 24 fork mounting (fork mount)                        |
| 4 declination gear  | 25 horseshoe mounting (horseshoe mount)              |
| 5 declination axis  | 26 meridian circle                                   |
| 6 declination bearing   | 27 divided circle (graduated circle)                 |
| 7 front ring  | 28 reading microscope                                |
| 8 tube (body tube)  | 29 meridian telescope                                |
| 9 tube centre ( <i>Am.</i> center) section                    | 30 electron microscope                               |
| 10 primary mirror (main mirror)                               | 31-39 microscope tube (microscope body, body tube)   |
| 11 secondary mirror (deviation mirror, corrector plate)       | 31 electron gun                                      |
| 12 fork mounting (fork)                                       | 32 condensers  |
| 13 cover  | 33 specimen insertion air lock                       |
| 14 guide bearing  | 34 control for specimen stage adjustment             |
| 15 main drive unit of the polar axis                          | 35 control for the objective apertures               |
| 16-25 telescope mountings (telescope mounts)                  | 36 objective lens                                    |
| 16 refractor (refracting telescope) on a German-type mounting | 37 intermediate image screen                         |
| 17 declination axis   | 38 telescope magnifier                               |
| 18 polar axis   | 39 final image tube                                  |
| 19 counterweight (counterpoise)                               | 40 photographic chamber for film and plate magazines |
| 20 eyepiece   |  |
| 21 knee mounting with a bent column                           |  |

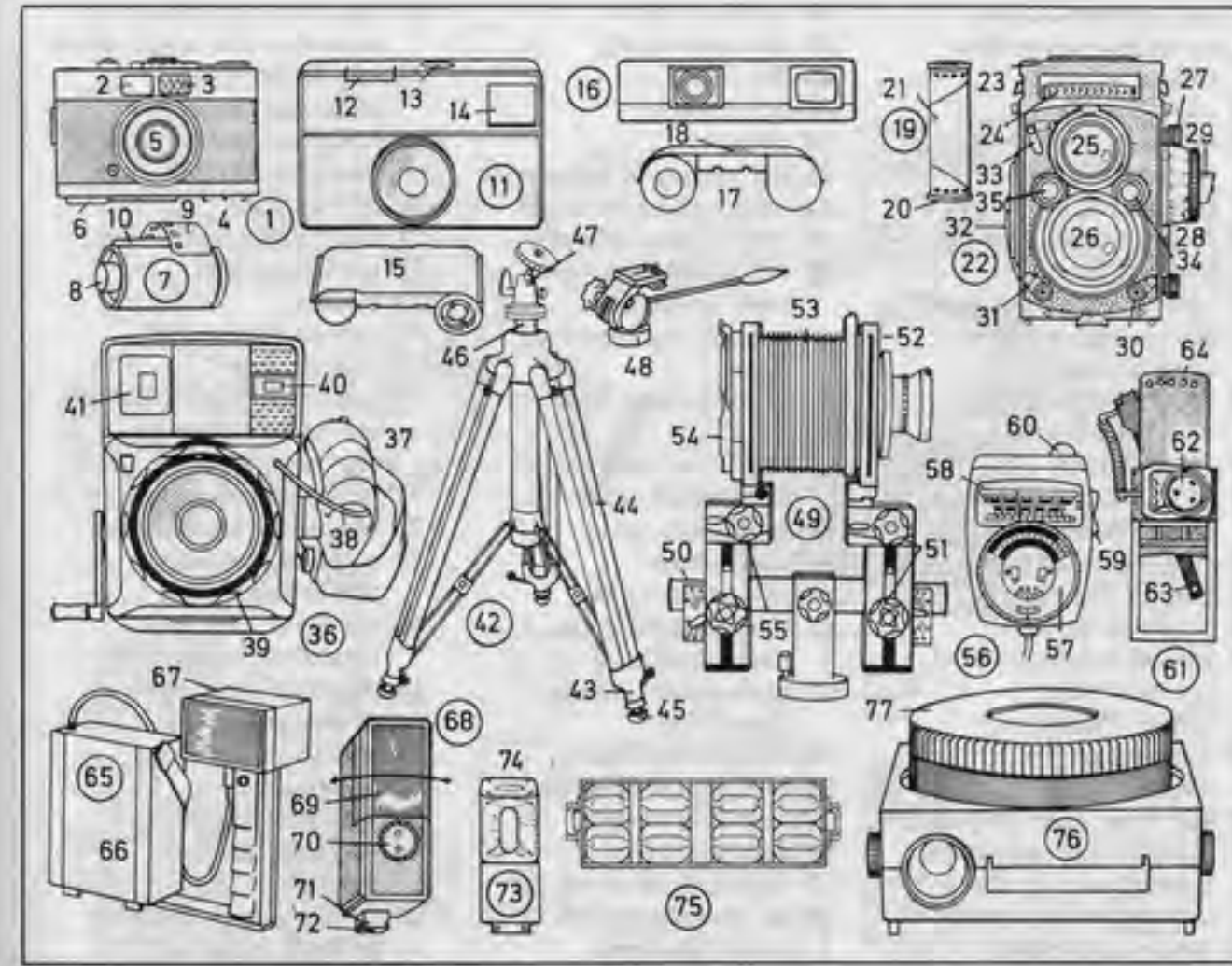

- |   |   |   |
|---|---|---|
| 1 miniature camera (35 mm camera)                             | 26 object lens                                      | 52 lens standard  |
| 2 viewfinder eyepiece   | 27 spool knob                                       | 53 bellows  |
| 3 meter cell  | 28 distance setting (focus setting)                 | 54 camera back  |
| 4 accessory shoe  | 29 exposure meter using needle-matching system      | 55 back standard adjustment   |
| 5 flush lens  | 30 flash contact                                    | 56 hand-held exposure meter (exposure meter)                                  |
| 6 rewind handle (rewind, rewind crank)                        | 31 shutter release                                  | 57 calculator dial  |
| 7 miniature film cassette (135 film cassette, 35 mm cassette) | 32 film transport (film advance, film wind)         | 58 scales (indicator scales) with indicator needle (pointer)                  |
| 8 film spool  | 33 flash switch                                     | 59 range switch (high/low range selector)                                     |
| 9 film with leader  | 34 aperture-setting control                         | 60 diffuser for incident light measurement                                    |
| 10 cassette slit (cassette exit slot)                         | 35 shutter speed control                            | 61 probe exposure meter for large-format cameras                              |
| 11 cartridge-loading camera                                   | 36 large-format hand camera (press camera)          | 62 meter  |
| 12 shutter release (shutter release button)                   | 37 grip (handgrip)                                  | 63 probe  |
| 13 flash cube contact   | 38 cable release                                    | 64 dark slide   |
| 14 rectangular viewfinder                                     | 39 distance-setting ring (focusing ring)            | 65 battery-portable electronic flash (battery-portable electronic flash unit) |
| 15 126 cartridge (instamatic cartridge)                       | 40 rangefinder window                               | 66 powerpack unit (battery)   |
| 16 pocket camera (subminiature camera)                        | 41 multiple-frame viewfinder (universal viewfinder) | 67 flash head   |
| 17 110 cartridge (subminiature cartridge)                     | 42 tripod   | 68 single-unit electronic flash (flashgun)                                    |
| 18 film window  | 43 tripod leg                                       | 69 swivel-mounted reflector   |
| 19 120 rollfilm   | 44 tubular leg                                      | 70 photodiode   |
| 20 rollfilm spool   | 45 rubber foot                                      | 71 foot   |
| 21 backing paper  | 46 central column                                   | 72 hot-shoe contact   |
| 22 twin-lens reflex camera                                    | 47 ball and socket head                             | 73 flash cube unit  |
| 23 folding viewfinder hood (focusing hood)                    | 48 cine camera pan and tilt head                    | 74 flash cube   |
| 24 meter cell   | 49 large-format folding camera                      | 75 flash bar  |
| 25 viewing lens   | 50 optical bench                                    | 76 slide projector  |
|   | 51 standard adjustment                              | 77 rotary magazine  |



- 1-105 system camera  
 1 miniature single-lens reflex camera  
 2 camera body  
 3-8 lens, a normal lens (standard lens)  
 3 lens barrel  
 4 distance scale in metres and feet  
 5 aperture ring (aperture-setting ring, aperture control ring)  
 6 front element mount with filter mount  
 7 front element  
 8 focusing ring (distance-setting ring)  
 9 ring for the carrying strap  
 10 battery chamber  
 11 screw-in cover  
 12 rewind handle (rewind, rewind crank)  
 13 battery switch  
 14 flash socket for F and X contact  
 15 self-time lever (setting lever for the self-timer, setting lever for the delayed-action release)  
 16 single-stroke film advance lever  
 17 exposure counter (frame counter)  
 18 shutter release (shutter release button)  
 19 shutter speed setting knob (shutter speed control)  
 20 accessory shoe  
 21 hot-shoe flash contact  
 22 viewfinder eyepiece with correcting lens  
 23 camera back  
 24 pressure plate  
 25 take-up spool of the rapid-loading system  
 26 transport sprocket  
 27 rewind release button (reversing clutch)  
 28 film window  
 29 rewind cam  
 30 tripod socket (tripod bush)  
 31 reflex system (mirror reflex system)  
 32 lens  
 33 reflex mirror  
 34 film window  
 35 path of the image beam  
 36 path of the sample beam  
 37 meter cell  
 38 auxiliary mirror  
 39 focusing screen  
 40 field lens  
 41 pentaprism  
 42 eyepiece  
 43-105 system of accessories  
 43 interchangeable lenses  
 44 fisheye lens (fisheye)  
 45 wide-angle lens (short focal length lens)  
 46 normal lens (standard lens)  
 47 medium focal length lens  
 48 telephoto lens (long focal length lens)  
 49 long-focus lens  
 50 mirror lens  
 51 viewfinder image  
 52 signal to switch to manual control  
 53 matt collar (ground glass collar)  
 54 microprism collar  
 55 split-image rangefinder (focusing wedges)  
 56 aperture scale  
 57 exposure meter needle  
 58-66 interchangeable focusing screens  
 58 all-matt screen (ground glass screen) with microprism spot  
 59 all-matt screen (ground glass screen) with microprism spot and split-image rangefinder  
 60 all-matt screen (ground glass screen) without focusing aids  
 61 matt screen (ground glass screen) with reticule  
 62 microprism spot for lenses with a large aperture  
 63 microprism spot for lenses with an aperture of  $f = 1:3.5$  or larger  
 64 Fresnel lens with matt collar (ground glass collar) and split-image rangefinder  
 65 all-matt screen (ground glass screen) with finely matted central spot and graduated markings  
 66 matt screen (ground glass screen) with clear spot and double cross hairs

- 67 data recording back for exposing data about shots  
 68 viewfinder hood (focusing hood)  
 69 interchangeable pentaprism viewfinder  
 70 pentaprism  
 71 right-angle viewfinder  
 72 correction lens  
 73 eyecup  
 74 focusing telescope  
 75 battery unit  
 76 combined battery holder and control grip for the motor drive  
 77 rapid-sequence camera  
 78 attachable motor drive  
 79 external (outside) power supply  
 80 ten meter film back (magazine back)  
 81-98 close-up and macro equipment  
 81 extension tube  
 82 adapter ring  
 83 reversing ring  
 84 lens in retrofocus position  
 85 bellows unit (extension bellows, close-up bellows attachment)  
 86 focusing stage  
 87 slide-copying attachment  
 88 slide-copying adapter  
 89 micro attachment (photomicroscope adapter)  
 90 copying stand (copy stand, copypod)  
 91 spider legs  
 92 copying stand (copy stand)  
 93 arm of the copying stand (copy stand)  
 94 macrophoto stand  
 95 stage plates for the macrophoto stand  
 96 insertable disc (disk)  
 97 Lieberkühn reflector  
 98 mechanical stage  
 99 table tripod (table-top tripod)  
 100 rifle grip  
 101 cable release  
 102 double cable release  
 103 camera case (ever-ready case)  
 104 lens case  
 105 soft-leather lens pouch

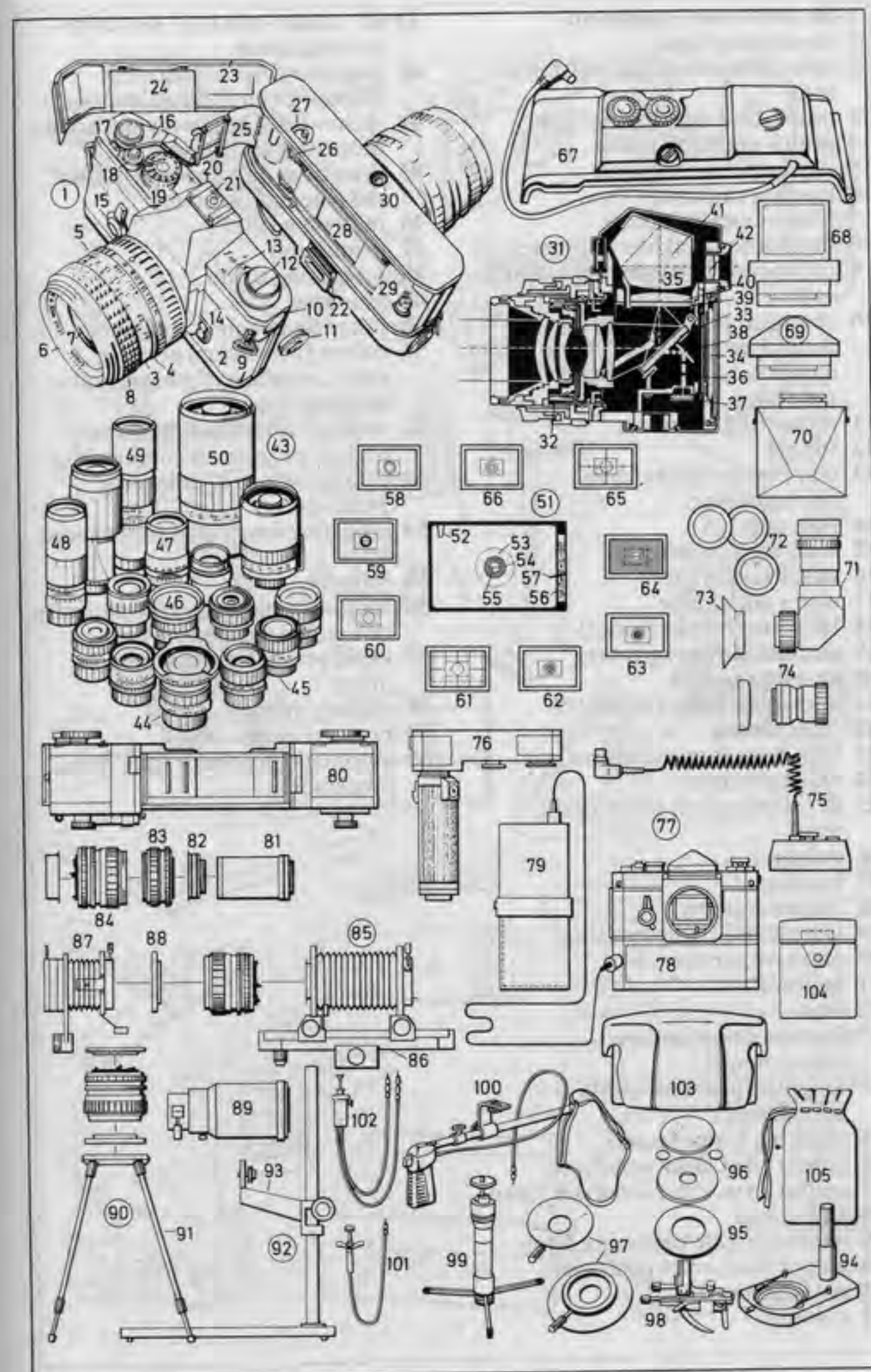



## 1-60 darkroom equipment

- 1 developing tank
- 2 spiral (developing spiral, tank reel)
- 3 multi-unit developing tank
- 4 multi-unit tank spiral
- 5 daylight-loading tank
- 6 loading chamber
- 7 film transport handle
- 8 developing tank thermometer
- 9 collapsible bottle for developing solution
- 10 chemical bottles for first developer, stop bath, colour developer, bleach-hardener, stabilizer
- 11 measuring cylinders
- 12 funnel
- 13 tray thermometer (dish thermometer)
- 14 film clip
- 15 wash tank (washer)
- 16 water supply pipe
- 17 water outlet pipe
- 18 laboratory timer (timer)
- 19 automatic film agitator
- 20 developing tank
- 21 darkroom lamp (safelight)
- 22 filter screen
- 23 film drier (drying cabinet)
- 24 exposure timer
- 25 developing dish (developing tray)
- 26 enlarger
- 27 baseboard
- 28 angled column
- 29 lamphouse (lamp housing)
- 30 negative carrier
- 31 bellows
- 32 lens
- 33 friction drive for fine adjustment
- 34 height adjustment (scale adjustment)
- 35 masking frame (easel)
- 36 colour (*Am. color*) analyser
- 37 colour (*Am. color*) analyser lamp
- 38 probe lead
- 39 exposure time balancing knob
- 40 colour (*Am. color*) enlarger
- 41 enlarger head
- 42 column
- 43-45 colour-mixing (*Am. color-mixing*) knob
- 43 magenta filter adjustment (minus green filter adjustment)
- 44 yellow filter adjustment (minus blue filter adjustment)
- 45 cyan filter adjustment (minus red filter adjustment)
- 46 red swing filter
- 47 print tongs
- 48 processing drum
- 49 squeegee
- 50 range (assortment) of papers
- 51 colour (*Am. color*) printing paper, a packet of photographic printing paper
- 52 colour (*Am. color*) chemicals (colour processing chemicals)
- 53 enlarging meter (enlarging photometer)
- 54 adjusting knob with paper speed scale
- 55 probe
- 56 semi-automatic thermostatically controlled developing dish
- 57 rapid print drier (heated print drier)
- 58 glazing sheet
- 59 pressure cloth
- 60 automatic processor (machine processor)

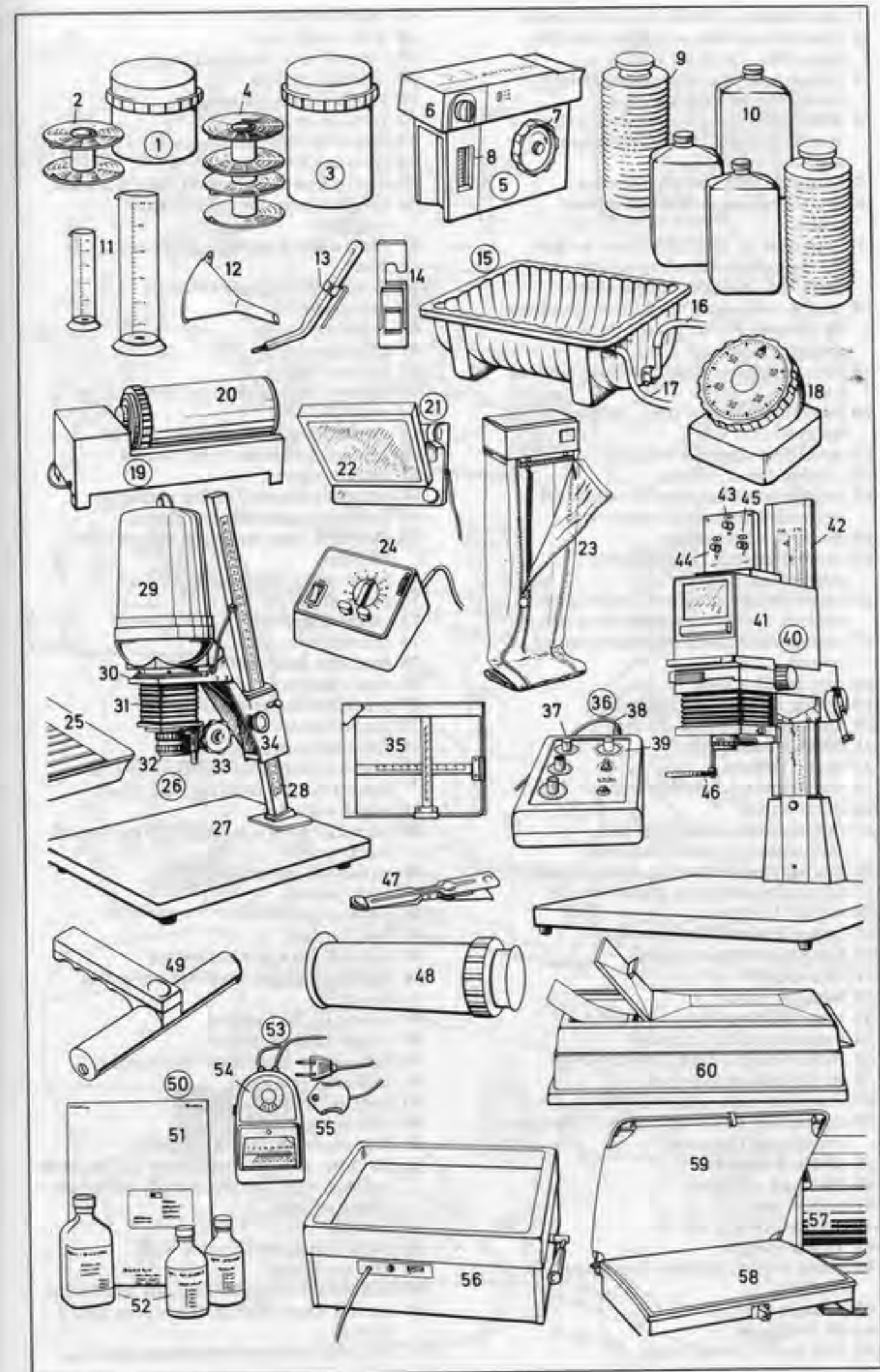



- 1 cine camera, a Super-8 sound camera
- 2 interchangeable zoom lens (variable focus lens, varifocal lens)
- 3 distance setting (focus setting) and manual focal length setting
- 4 aperture ring (aperture-setting ring, aperture control ring) for manual aperture setting
- 5 handgrip with battery chamber
- 6 shutter release with cable release socket
- 7 pilot tone or pulse generator socket for the sound recording equipment (with the dual film-tape system)
- 8 sound connecting cord for microphone or external sound source (in single-system recording)
- 9 remote control socket (remote control jack)
- 10 headphone socket (*sim.*: earphone socket)
- 11 autofocus override switch
- 12 filming speed selector
- 13 sound recording selector switch for automatic or manual operation
- 14 eyepiece with eyecup
- 15 diopter control ring (dioptric adjustment ring)
- 16 recording level control (audio level control, recording sensitivity selector)
- 17 manual/automatic exposure control switch
- 18 film speed setting
- 19 power zooming arrangement
- 20 automatic aperture control
- 21 sound track system
- 22 sound camera
- 23 telescopic microphone boom
- 24 microphone
- 25 microphone connecting lead (microphone connecting cord)
- 26 mixing console (mixing desk, mixer)
- 27 inputs from various sound sources
- 28 output to camera
- 29 Super-8 sound film cartridge
- 30 film gate of the cartridge
- 31 feed spool
- 32 take-up spool
- 33 recording head (sound head)
- 34 transport roller (capstan)
- 35 rubber pinch roller (capstan idler)
- 36 guide step (guide notch)
- 37 exposure meter control step
- 38 conversion filter step (colour, *Am.* color, conversion filter step)
- 39 single-8 cassette
- 40 film gate opening
- 41 unexposed film
- 42 exposed film
- 43 16 mm camera
- 44 reflex finder (through-the-lens reflex finder)
- 45 magazine
- 46-49 lens head
- 46 lens turret (turret head)

- 47 telephoto lens
- 48 wide-angle lens
- 49 normal lens (standard lens)
- 50 winding handle
- 51 compact Super-8 camera
- 52 footage counter
- 53 macro zoom lens
- 54 zooming lever
- 55 macro lens attachment (close-up lens)
- 56 macro frame (mount for small originals)
- 57 underwater housing (underwater case)
- 58 direct-vision frame finder
- 59 measuring rod
- 60 stabilizing wing
- 61 grip (handgrip)
- 62 locking bolt
- 63 control lever (operating lever)
- 64 porthole
- 65 synchronization start (sync start)
- 66 professional press-type camera
- 67 cameraman
- 68 camera assistant (sound assistant)
- 69 handclap marking sync start
- 70 dual film-tape recording using a tape recorder
- 71 pulse-generating camera
- 72 pulse cable
- 73 cassette recorder
- 74 microphone
- 75 dual film-tape reproduction
- 76 tape cassette
- 77 synchronization unit
- 78 cine projector
- 79 film feed spool
- 80 take-up reel (take-up spool), an automatic take-up reel (take-up spool)
- 81 sound projector
- 82 sound film with magnetic stripe (sound track, track)
- 83 automatic-threading button
- 84 trick button
- 85 volume control
- 86 reset button
- 87 fast and slow motion switch
- 88 forward, reverse, and still projection switch
- 89 splicer for wet splices
- 90 hinged clamping plate
- 91 film viewer (animated viewer editor)
- 92 foldaway reel arm
- 93 rewind handle (rewinder)
- 94 viewing screen
- 95 film perforator (film marker)
- 96 six-turn-able film and sound cutting table (editing table, cutting bench, animated sound editor)
- 97 monitor
- 98 control buttons (control well)
- 99 film turntable
- 100 first sound turntable, e.g. for live sound
- 101 second sound turntable for post-sync sound
- 102 film and tape synchronizing head

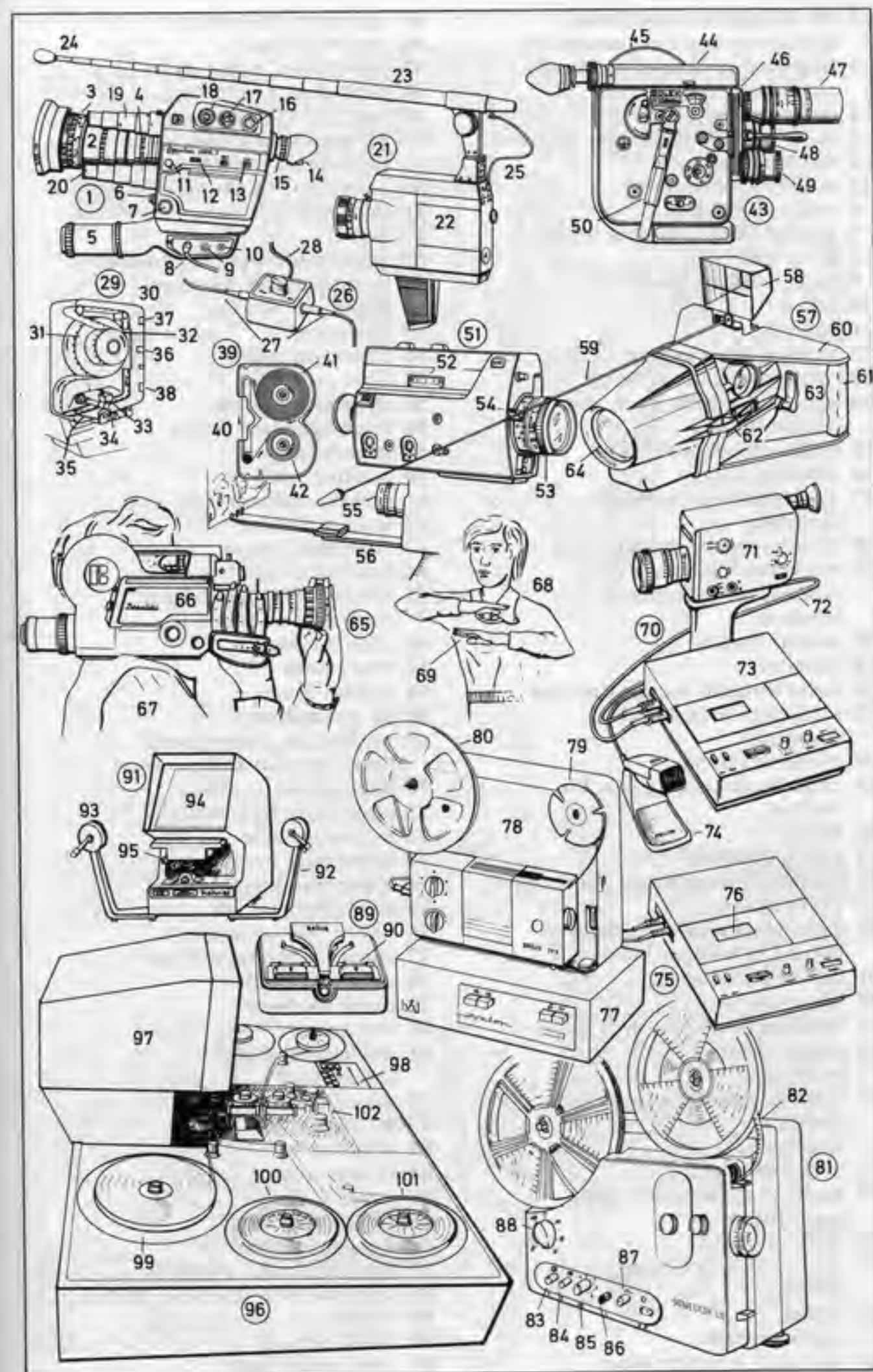



- 1-49 carcass (carcass, fabric)  
[house construction, carcassing]
- 1 basement of tamped (rammed) concrete
- 2 concrete base course
- 3 cellar window (basement window)
- 4 outside cellar steps
- 5 utility room window
- 6 utility room door
- 7 ground floor (*Am.* first floor)
- 8 brick wall
- 9 lintel (window head)
- 10 reveal
- 11 jamb
- 12 window ledge (window sill)
- 13 reinforced concrete lintel
- 14 upper floor (first floor, *Am.* second floor)
- 15 hollow-block wall
- 16 concrete floor
- 17 work platform (working platform)
- 18 bricklayer (*Am.* brickmason)
- 19 bricklayer's labourer (*Am.* laborer); *also*: builder's labourer
- 20 mortar trough
- 21 chimney
- 22 cover (boards) for the staircase
- 23 scaffold pole (scaffold standard)
- 24 platform railing
- 25 angle brace (angle tie) in the scaffold
- 26 ledger
- 27 putlog (putlock)
- 28 plank platform (board platform)
- 29 guard board
- 30 scaffolding joint with chain or lashing or whip or bond
- 31 builder's hoist
- 32 mixer operator
- 33 concrete mixer, a gravity mixer
- 34 mixing drum
- 35 feeder skip
- 36 concrete aggregate [sand and gravel]
- 37 wheelbarrow
- 38 hose (hosepipe)
- 39 mortar pan (mortar trough, mortar tub)
- 40 stack of bricks
- 41 stacked shutter boards (lining boards)
- 42 ladder
- 43 bag of cement
- 44 site fence, a timber fence
- 45 signboard (billboard)
- 46 removable gate
- 47 contractors' name plates
- 48 site hut (site office)
- 49 building site latrine
- 50-57 bricklayer's (*Am.* brickmason's) tools
- 50 plumb bob (plummet)
- 51 thick lead pencil
- 52 trowel
- 53 bricklayer's (*Am.* brickmason's) hammer (brick hammer)
- 54 mallet
- 55 spirit level
- 56 laying-on trowel
- 57 float
- 58-68 masonry bonds
- 58 brick (standard brick)
- 59 stretching bond
- 60 heading bond
- 61 racking (raking) back
- 62 English bond
- 63 stretching course
- 64 heading course
- 65 English cross bond (Saint Andrew's cross bond)
- 66 chimney bond
- 67 first course
- 68 second course
- 69-82 excavation
- 69 profile (*Am.* batterboard) [fixed on edge at the corner]
- 70 intersection of strings
- 71 plumb bob (plummet)
- 72 excavation side
- 73 upper edge board
- 74 lower edge board
- 75 foundation trench
- 76 navy (*Am.* excavator)
- 77 conveyor belt (conveyor)
- 78 excavated earth
- 79 plank roadway
- 80 tree guard
- 81 mechanical shovel (excavator)
- 82 shovel bucket (bucket)
- 83-91 plastering
- 83 plasterer
- 84 mortar trough
- 85 screen
- 86-89 ladder scaffold
- 86 standard ladder
- 87 boards (planks, platform)
- 88 diagonal strut (diagonal brace)
- 89 railing
- 90 guard netting
- 91 rope-pulley hoist

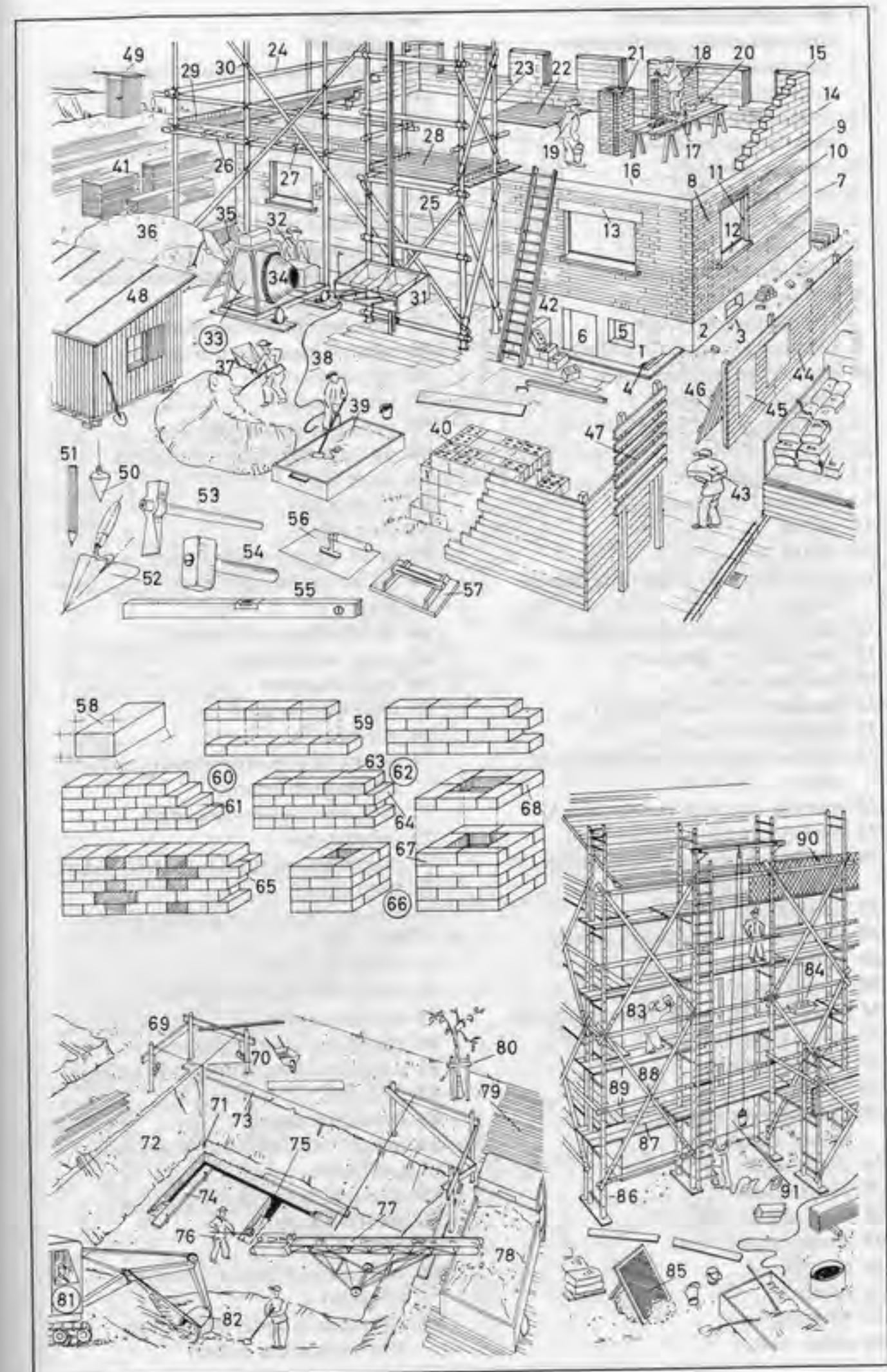



- 1-89 reinforced concrete (ferroconcrete) construction
- 1 reinforced concrete (ferroconcrete) skeleton construction
- 2 reinforced concrete (ferroconcrete) frame
- 3 inferior purlin
- 4 concrete purlin
- 5 ceiling joist
- 6 arch (flank)
- 7 rubble concrete wall
- 8 reinforced concrete (ferroconcrete) floor
- 9 concreter (concretor), flattening out
- 10 projecting reinforcement (Am. connection rebars)
- 11 column box
- 12 joist shuttering
- 13 shuttering strut
- 14 diagonal bracing
- 15 wedge
- 16 board
- 17 sheet pile wall (sheet pile, sheet piling)
- 18 shutter boards (lining boards)
- 19 circular saw (buzz saw)
- 20 bending table
- 21 bar bender (steel bender)
- 22 hand steel shears
- 23 reinforcing steel (reinforcement rods)
- 24 pumice concrete hollow block
- 25 partition wall, a timber wall
- 26 concrete aggregate [gravel and sand of various grades]
- 27 crane track
- 28 tipping wagon (tipping truck)
- 29 concrete mixer
- 30 cement silo
- 31 tower crane (tower slewing crane)
- 32 bogie (Am. truck)
- 33 counterweight
- 34 tower
- 35 crane driver's cabin (crane driver's cage)
- 36 jib (boom)
- 37 bearer cable
- 38 concrete bucket
- 39 sleepers (Am. ties)
- 40 chock
- 41 ramp
- 42 wheelbarrow
- 43 safety rail

- 44 site hut
- 45 canteen
- 46 tubular steel scaffold (scaffolding)
- 47 standard
- 48 ledger tube
- 49 tie tube
- 50 shoe
- 51 diagonal brace
- 52 planking (platform)
- 53 coupling (coupler)
- 54-76 formwork (shuttering) and reinforcement
- 54 bottom shuttering (lining)
- 55 side shutter of a purlin
- 56 cut-in bottom
- 57 cross beam
- 58 cramp iron (cramp, dog)
- 59 upright member, a standard
- 60 strap
- 61 cross piece
- 62 stop fillet
- 63 strut (brace, angle brace)
- 64 frame timber (yoke)
- 65 strap
- 66 reinforcement binding
- 67 cross strut (strut)
- 68 reinforcement
- 69 distribution steel
- 70 stirrup
- 71 projecting reinforcement (Am. connection rebars)
- 72 concrete (heavy concrete)
- 73 column box
- 74 bolted frame timber (bolted yoke)
- 75 nut (thumb nut)
- 76 shutter board (shuttering board)
- 77-89 tools
- 77 bending iron
- 78 adjustable service girder
- 79 adjusting screw
- 80 round bar reinforcement
- 81 distance piece (separator, spacer)
- 82 Torsteel
- 83 concrete tamper
- 84 mould (Am. mold) for concrete test cubes
- 85 concreter's tongs
- 86 sheeting support
- 87 hand shears
- 88 immersion vibrator (concrete vibrator)
- 89 vibrating cylinder (vibrating head, vibrating poker)

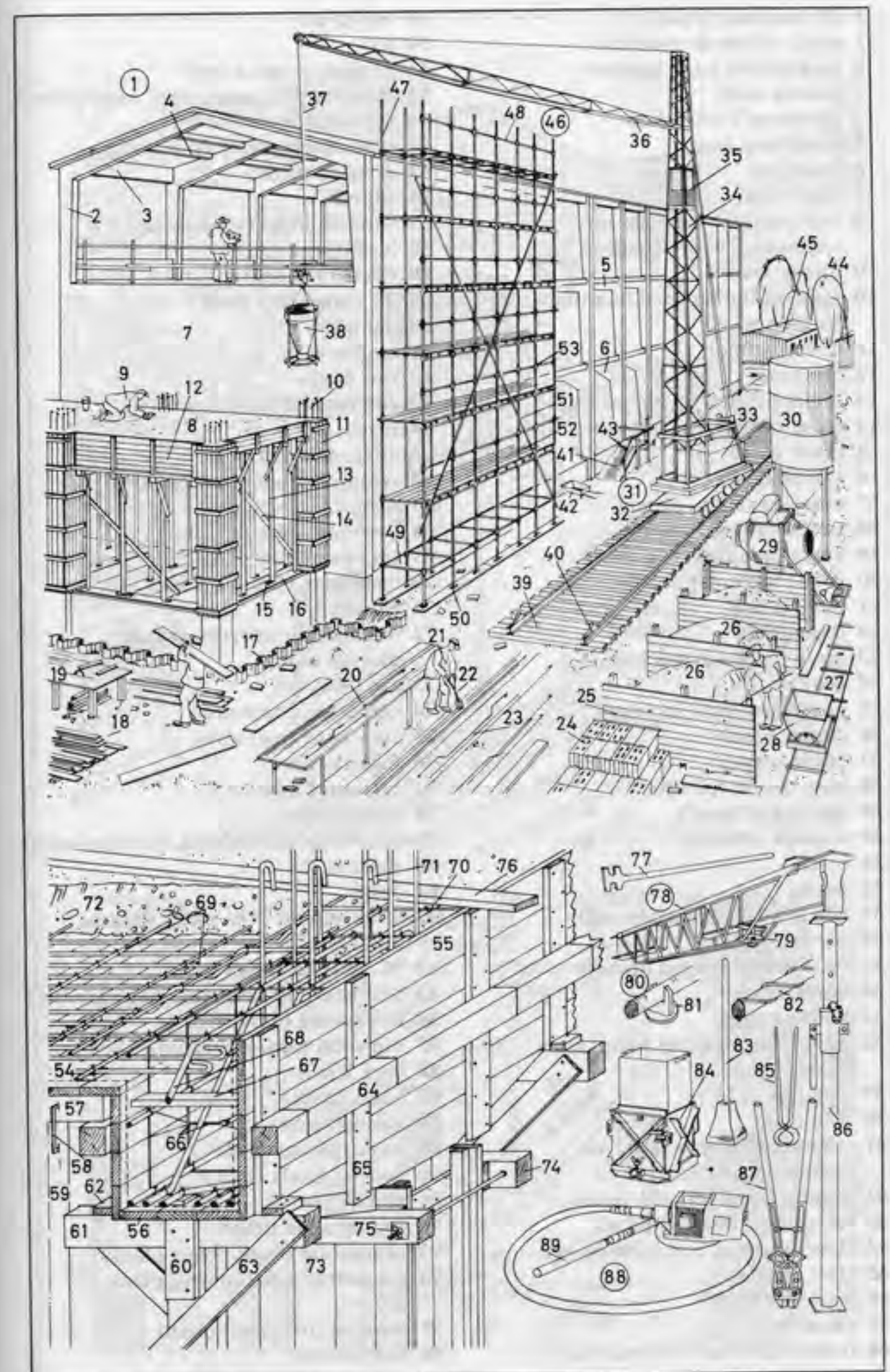



- 1-59 carpenter's yard
- 1 stack of boards (planks)
- 2 long timber (*Am.* lumber)
- 3 sawing shed
- 4 carpenter's workshop
- 5 workshop door
- 6 handcart
- 7 roof truss
- 8 tree [used for topping out ceremony], with wreath
- 9 timber wall
- 10 squared timber (building timber, scantlings)
- 11 drawing floor
- 12 carpenter
- 13 safety helmet
- 14 cross-cut saw, a chain saw
- 15 chain guide
- 16 saw chain
- 17 mortiser (chain cutter)
- 18 trestle (horse)
- 19 beam mounted on a trestle
- 20 set of carpenter's tools
- 21 electric drill
- 22 dowel hole
- 23 mark for the dowel hole
- 24 beams
- 25 post (stile, stud, quarter)
- 26 corner brace
- 27 brace (strut)
- 28 base course (plinth)
- 29 house wall (wall)
- 30 window opening
- 31 reveal
- 32 jamb
- 33 window ledge (window sill)
- 34 cornice
- 35 roundwood (round timber)
- 36 floorboards
- 37 hoisting rope
- 38 ceiling joist (ceiling beam, main beam)
- 39 wall joist
- 40 wall plate
- 41 trimmer (trimmer joist, *Am.* header, header joist)
- 42 dragon beam (dragon piece)
- 43 false floor (inserted floor)
- 44 floor filling of breeze, loam, etc.
- 45 fillet (cleat)
- 46 stair well (well)
- 47 chimney
- 48 framed partition (framed wall)
- 49 wall plate
- 50 girt
- 51 window jamb, a jamb
- 52 corner stile (corner strut, corner stud)
- 53 principal post
- 54 brace (strut) with skew notch
- 55 nogging piece
- 56 sill rail
- 57 window lintel (window head)
- 58 head (head rail)
- 59 filled-in panel (bay, pan)
- 60-82 carpenter's tools
- 60 hand saw
- 61 bucksaw
- 62 saw blade
- 63 compass saw (keyhole saw)
- 64 plane
- 65 auger (gimlet)
- 66 screw clamp (cramp, holdfast)
- 67 mallet
- 68 two-handed saw
- 69 try square
- 70 broad axe (*Am.* broadax)
- 71 chisel
- 72 mortise axe (mortice axe, *Am.* mortise ax)
- 73 axe (*Am.* ax)
- 74 carpenter's hammer
- 75 claw head (nail claw)
- 76 folding rule
- 77 carpenter's pencil
- 78 iron square
- 79 drawknife (drawshave, drawing knife)
- 80 shaving
- 81 bevel
- 82 mitre square (*Am.* miter square, miter angle)
- 83-96 building timber
- 83 undressed timber (*Am.* rough lumber)
- 84 heartwood (duramen)
- 85 sapwood (sap, alburnum)
- 86 bark (rind)
- 87 baulk (balk)
- 88 halved timber
- 89 wane (waney edge)
- 90 quarter baulk (balk)
- 91 plank (board)
- 92 end-grained timber
- 93 heartwood plank (heart plank)
- 94 unsquared (untrimmed) plank (board)
- 95 squared (trimmed) board
- 96 slab (offcut)

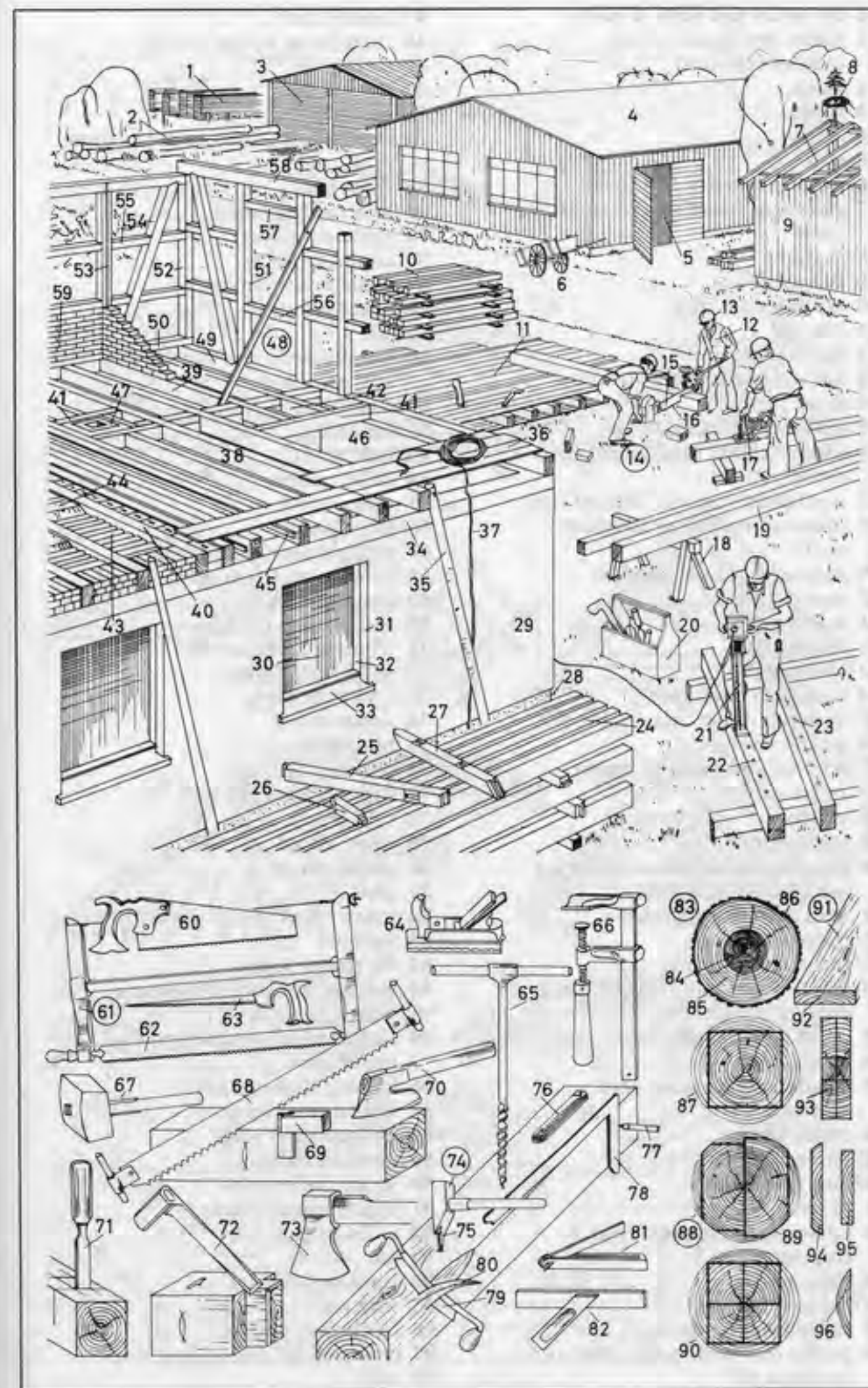



- 1-26 styles and parts of roofs
- 1 gable roof (saddle roof, saddleback roof)
- 2 ridge
- 3 verge
- 4 eaves
- 5 gable
- 6 dormer window (dormer)
- 7 pent roof (shed roof, lean-to roof)
- 8 skylight
- 9 fire gable
- 10 hip (hipped) roof
- 11 hip end
- 12 hip (arris)
- 13 hip (hipped) dormer window
- 14 ridge turret
- 15 valley (roof valley)
- 16 hipped-gable roof (jerkin head roof)
- 17 partial-hip (partial-hipped) end
- 18 mansard roof (*Am.* gambrel roof)
- 19 mansard dormer window
- 20 sawtooth roof
- 21 north light
- 22 broach roof
- 23 eyebrow
- 24 conical broach roof
- 25 imperial dome (imperial roof)
- 26 weather vane
- 27-83 roof structures of timber
- 27 rafter roof
- 28 rafter
- 29 roof beam
- 30 diagonal tie (cross tie, sprocket piece, cocking piece)
- 31 arris fillet (tilting fillet)
- 32 outer wall
- 33 beam head
- 34 collar beam roof (trussed-rafter roof)
- 35 collar beam (collar)
- 36 rafter
- 37 strutted collar beam roof structure
- 38 collar beams
- 39 purlin
- 40 post (stile, stud)
- 41 brace
- 42 unstrutted (king pin) roof structure
- 43 ridge purlin
- 44 inferior purlin
- 45 rafter head (rafter end)
- 46 purlin roof with queen post and pointing sill
- 47 pointing sill
- 48 ridge beam (ridge board)
- 49 simple tie
- 50 double tie
- 51 purlin
- 52 purlin roof structure with queen post
- 53 tie beam
- 54 joist (ceiling joist)
- 55 principal rafter
- 56 common rafter
- 57 angle brace (angle tie)
- 58 brace (strut)
- 59 ties
- 60 hip (hipped) roof with purlin roof structure
- 61 jack rafter
- 62 hip rafter
- 63 jack rafter
- 64 valley rafter
- 65 queen truss
- 66 main beam
- 67 summer (summer beam)
- 68 queen post (truss post)
- 69 brace (strut)
- 70 collar beam (collar)
- 71 trimmer (*Am.* header)
- 72 solid-web girder
- 73 lower chord
- 74 upper chord
- 75 boarding
- 76 purlin
- 77 supporting outer wall
- 78 roof truss
- 79 lower chord
- 80 upper chord
- 81 post
- 82 brace (strut)
- 83 support
- 84-98 timber joints
- 84 mortise (mortice) and tenon joint
- 85 forked mortise (mortice) and tenon joint
- 86 halving (halved) joint
- 87 simple scarf joint
- 88 oblique scarf joint
- 89 dovetail halving
- 90 single skew notch
- 91 double skew notch
- 92 wooden nail
- 93 pin
- 94 clout nail (clout)
- 95 wire nail
- 96 hardwood wedges
- 97 cramp iron (timber dog, dog)
- 98 bolt

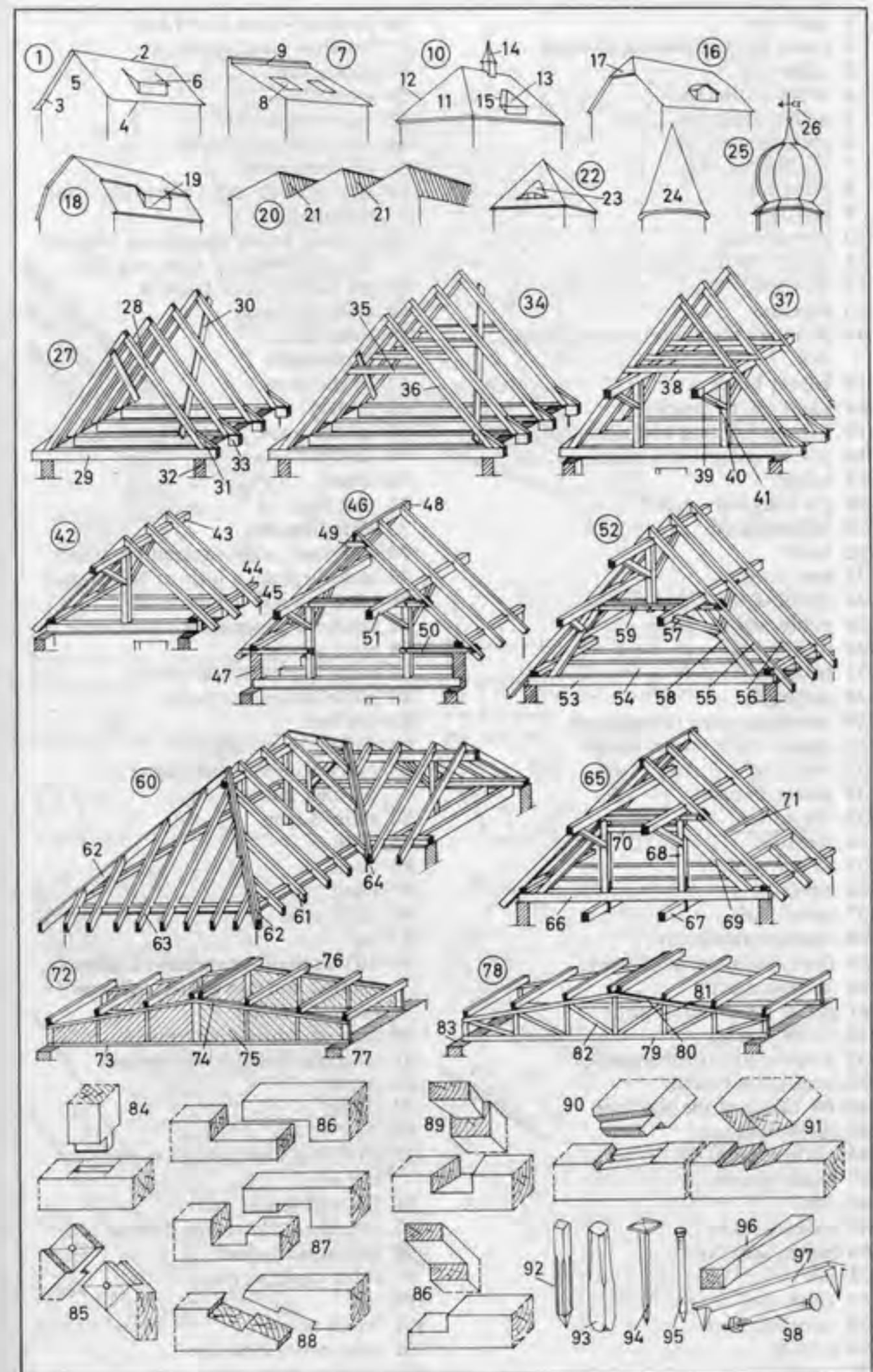



- 1 tiled roof
- 2 plain-tile double-lap roofing
- 3 ridge tile
- 4 ridge course tile
- 5 under-ridge tile
- 6 plain (plane) tile
- 7 ventilating tile
- 8 ridge tile
- 9 hip tile
- 10 hipped end
- 11 valley (roof valley)
- 12 skylight
- 13 chimney
- 14 chimney flashing, made of sheet zinc
- 15 ladder hook
- 16 snow guard bracket
- 17 battens (slating and tiling battens)
- 18 batten gauge (Am. gage)
- 19 rafter
- 20 tile hammer
- 21 lath axe (Am. ax)
- 22 hod
- 23 hod hook
- 24 opening (hatch)
- 25 gable (gable end)
- 26 toothed lath
- 27 soffit
- 28 gutter
- 29 rainwater pipe (downpipe)
- 30 swan's neck (swan-neck)
- 31 pipe clip
- 32 gutter bracket
- 33 tile cutter
- 34 scaffold
- 35 safety wall
- 36 eaves
- 37 outer wall
- 38 exterior rendering
- 39 frost-resistant brickwork
- 40 inferior purlin
- 41 rafter head (rafter end)
- 42 eaves fascia
- 43 double lath (tilting lath)
- 44 insulating boards
- 45-60 tiles and tile roofings
- 45 split-tiled roof
- 46 plain (plane) tile
- 47 ridge course
- 48 slip
- 49 eaves course
- 50 plain-tiled roof
- 51 nib
- 52 ridge tile
- 53 pantiled roof
- 54 pantile
- 55 pointing

- 56 Spanish-tiled roof (Am. mission-tiled roof)
- 57 under tile
- 58 over tile
- 59 interlocking tile
- 60 flat interlocking tile
- 61-89 slate roof
- 61 roof boards (roof boarding, roof sheathing)
- 62 roofing paper (sheathing paper); also: roofing felt (Am. rag felt)
- 63 cat ladder (roof ladder)
- 64 coupling hook
- 65 ridge hook
- 66 roof trestle
- 67 trestle rope
- 68 knot
- 69 ladder hook
- 70 scaffold board
- 71 slater
- 72 nail bag
- 73 slate hammer
- 74 slate nail, a galvanized wire nail
- 75 slater's shoe, a bast or hemp shoe
- 76 eaves course (eaves joint)
- 77 corner bottom slate
- 78 roof course
- 79 ridge course (ridge joint)
- 80 gable slate
- 81 tail line
- 82 valley (roof valley)
- 83 box gutter (trough gutter, parallel gutter)
- 84 slater's iron
- 85 slate
- 86 back
- 87 head
- 88 front edge
- 89 tail
- 90-103 asphalt-impregnated paper roofing and corrugated asbestos cement roofing
- 90 asphalt-impregnated paper roof
- 91 width [parallel to the gutter]
- 92 gutter
- 93 ridge
- 94 join
- 95 width [at right angles to the gutter]
- 96 felt nail (clout nail)
- 97 corrugated asbestos cement roof
- 98 corrugated sheet
- 99 ridge capping piece
- 100 lap
- 101 wood screw
- 102 rust-proof zinc cup
- 103 lead washer

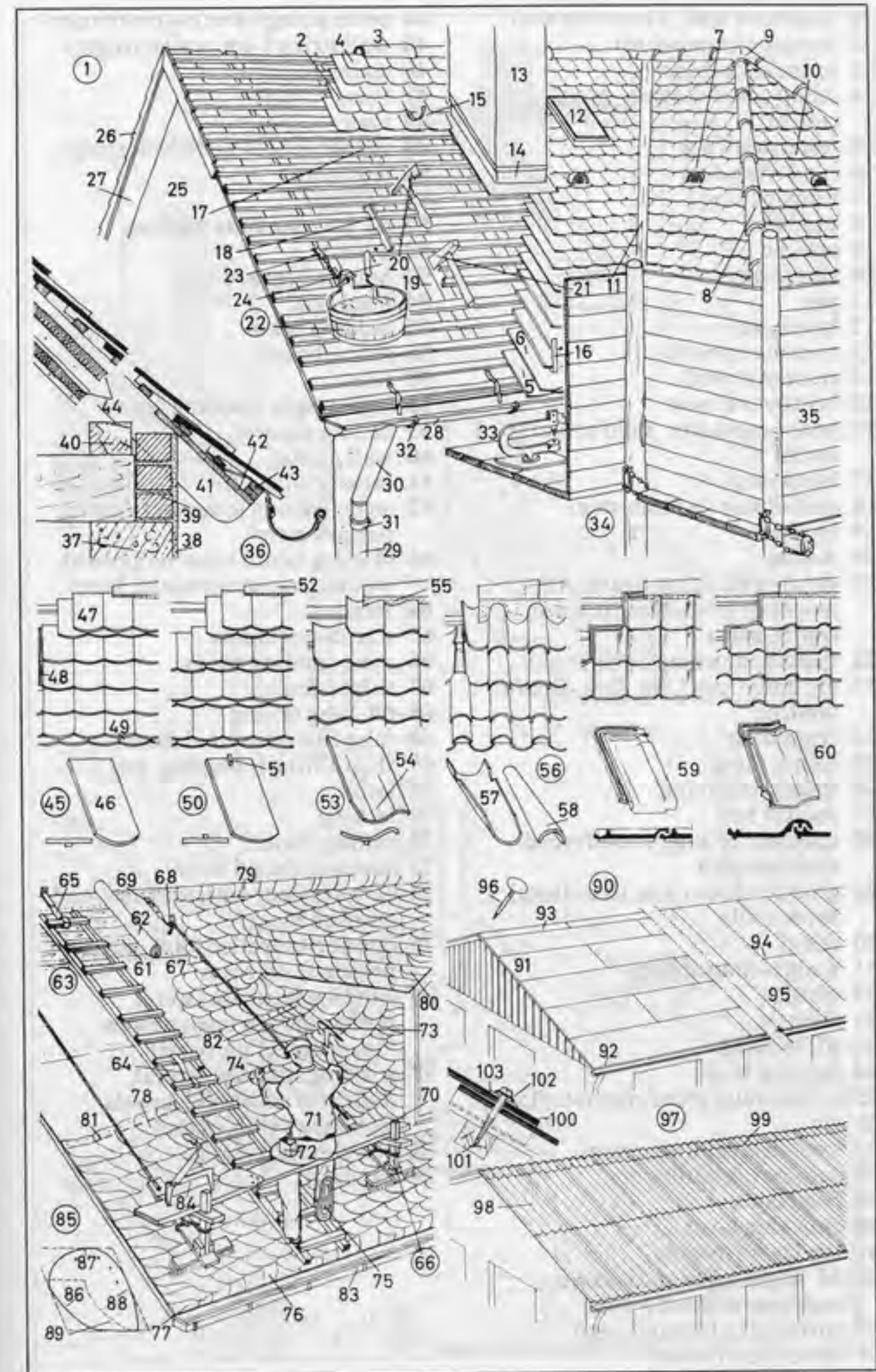



- 1 basement wall, a concrete wall
- 2 footing (foundation)
- 3 foundation base
- 4 damp course (damp-proof course)
- 5 waterproofing
- 6 rendering coat
- 7 brick paving
- 8 sand bed
- 9 ground
- 10 shuttering
- 11 peg
- 12 hardcore
- 13 oversite concrete
- 14 cement screed
- 15 brickwork base
- 16 basement stairs, solid concrete stairs
- 17 block step
- 18 curtail step (bottom step)
- 19 top step
- 20 nosing
- 21 skirting (skirting board, *Am.* mopboard, washboard, scrub board, base)
- 22 balustrade of metal bars
- 23 ground-floor (*Am.* first-floor) landing
- 24 front door
- 25 foot scraper
- 26 flagstone paving
- 27 mortar bed
- 28 concrete ceiling, a reinforced concrete slab
- 29 ground-floor (*Am.* first-floor) brick wall
- 30 ramp
- 31 wedge-shaped step
- 32 tread
- 33 riser
- 34-41 landing**
- 34 landing beam
- 35 ribbed reinforced concrete floor
- 36 rib
- 37 steel-bar reinforcement
- 38 subfloor (blind floor)
- 39 level layer
- 40 finishing layer
- 41 top layer (screed)
- 42-44 dog-legged staircase, a staircase without a well**
- 42 curtail step (bottom step)
- 43 newel post (newel)
- 44 outer string (*Am.* outer stringer)
- 45 wall string (*Am.* wall stringer)
- 46 staircase bolt
- 47 tread
- 48 riser
- 49 wreath piece (wreathed string)
- 50 balustrade
- 51 baluster
- 52-62 intermediate landing**
- 52 wreath
- 53 handrail (guard rail)
- 54 head post
- 55 landing beam
- 56 lining board
- 57 fillet
- 58 lightweight building board
- 59 ceiling plaster
- 60 wall plaster
- 61 false ceiling
- 62 strip flooring (overlay flooring, parquet strip)
- 63 skirting board (*Am.* mopboard, washboard, scrub board, base)
- 64 beading
- 65 staircase window
- 66 main landing beam
- 67 fillet (cleat)
- 68-69 false ceiling**
- 68 false floor (inserted floor)
- 69 floor filling (plugging, pug)
- 70 laths
- 71 lathing
- 72 ceiling plaster
- 73 subfloor (blind floor)
- 74 parquet floor with tongued-and-grooved blocks
- 75 quarter-newelled (*Am.* quarter-neweled) staircase
- 76 winding staircase (spiral staircase) with open newels (open-newel staircase)
- 77 winding staircase (spiral staircase) with solid newels (solid-newel staircase)
- 78 newel (solid newel)
- 79 handrail

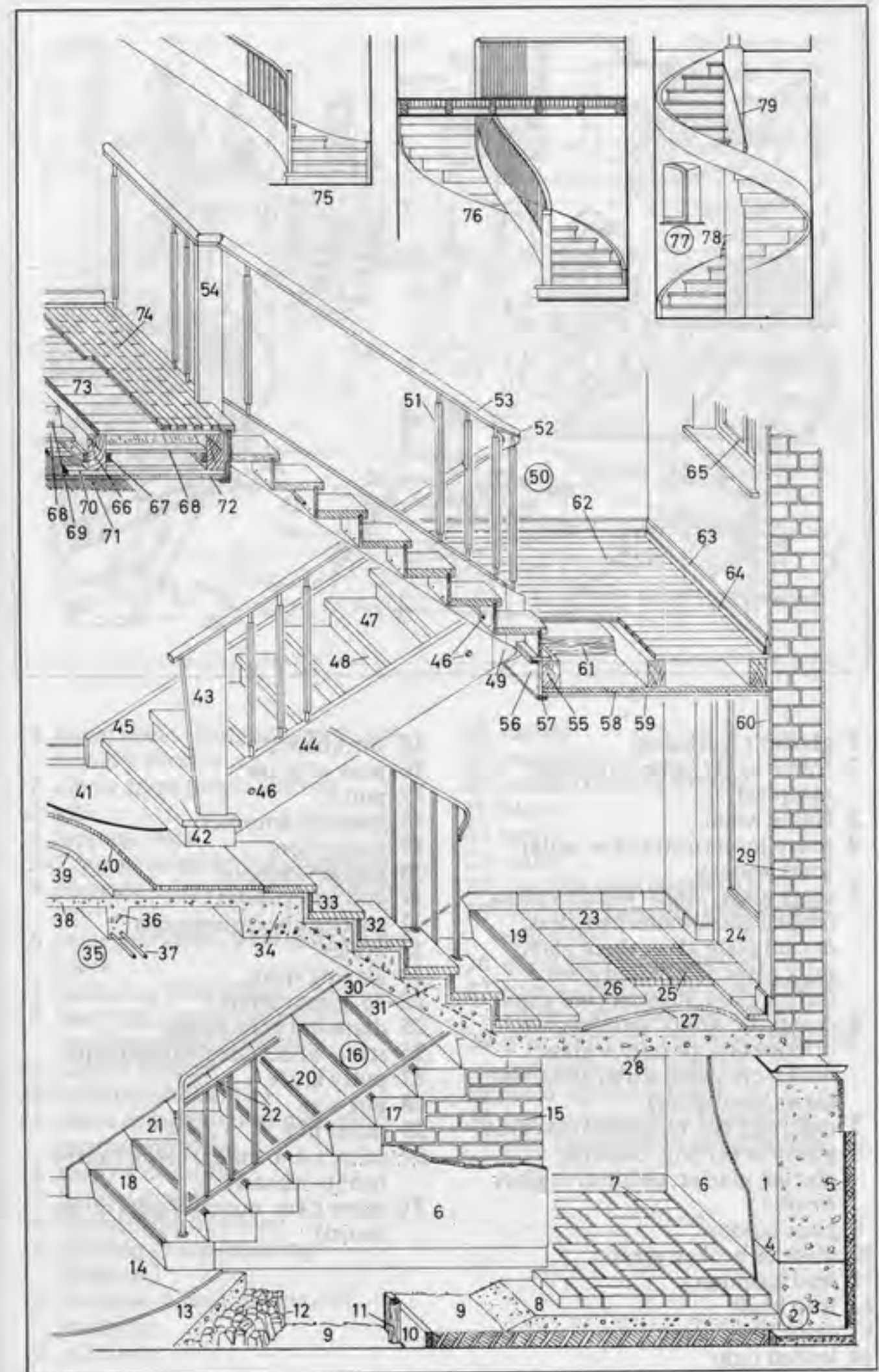



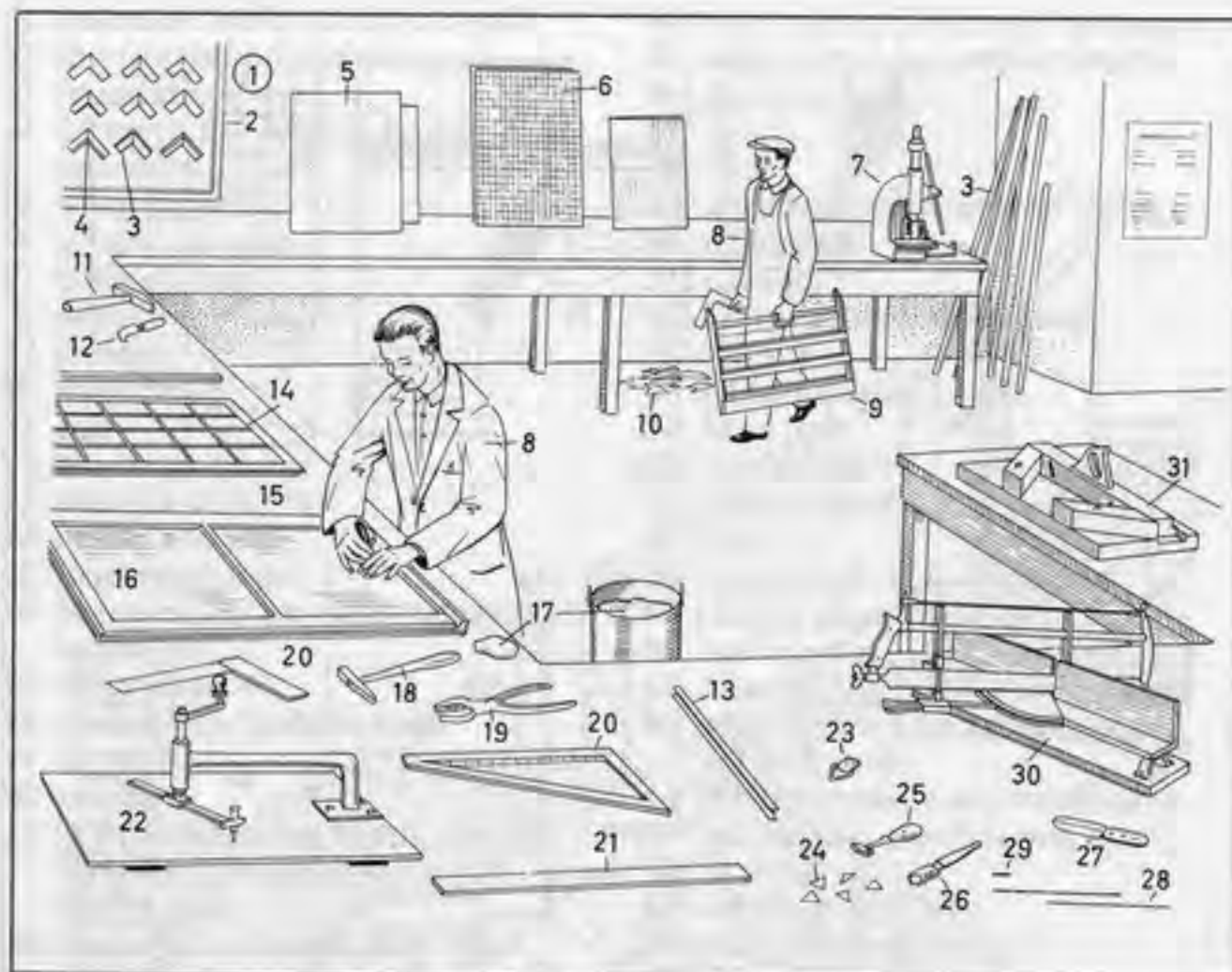

- 1 glazier's workshop
- 2 frame wood samples (frame samples)
- 3 frame wood
- 4 mitre joint (mitre, *Am.* miter joint, miter)
- 5 sheet glass; *kinds*: window glass, frosted glass, patterned glass, crystal plate glass, thick glass, milk glass, laminated glass (safety glass, shatterproof glass)
- 6 cast glass; *kinds*: stained glass, ornamental glass, raw glass, bull's-eye glass, wired glass, line glass (lined glass)
- 7 mitring (*Am.* mitering) machine
- 8 glassworker (e.g. building glazier, glazier, decorative glass worker)
- 9 glass holder
- 10 piece of broken glass
- 11 lead hammer
- 12 lead knife
- 13 came (lead came)
- 14 leaded light
- 15 workbench
- 16 pane of glass
- 17 putty
- 18 glazier's hammer
- 19 glass pliers
- 20 glazier's square
- 21 glazier's rule
- 22 glazier's beam compass
- 23 eyelet
- 24 glazing sprig
- 25-26 glass cutters
- 25 diamond glass cutter
- 26 steel-wheel (steel) glass cutter
- 27 putty knife
- 28 pin wire
- 29 panel pin
- 30 mitre (*Am.* miter) block (mitre box) [with saw]
- 31 mitre (*Am.* miter) shoot (mitre board)

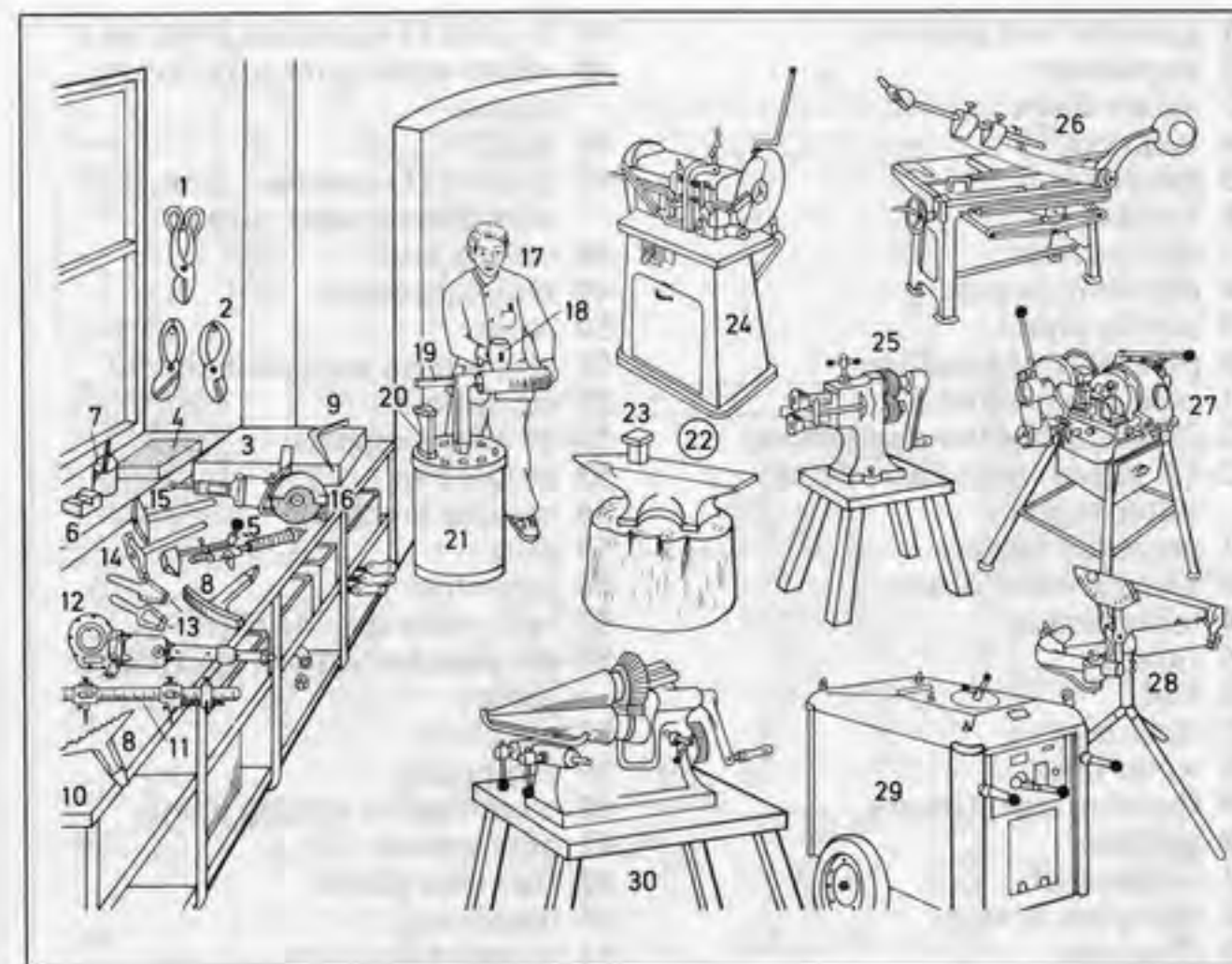

- 1 metal shears (tinner's snips, *Am.* tinner's shears)
- 2 elbow snips (angle shears)
- 3 gib
- 4 lapping plate
- 5-7 propane soldering apparatus
- 5 propane soldering iron, a hatchet iron
- 6 soldering stone, a sal-ammoniac block
- 7 soldering fluid (flux)
- 8 beading iron for forming reinforcement beading
- 9 angled reamer
- 10 workbench (bench)
- 11 beam compass (trammel, *Am.* beam trammel)
- 12 electric hand die
- 13 hollow punch
- 14 chamfering hammer
- 15 beading swage (beading hammer)
- 16 abrasive-wheel cutting-off machine
- 17 plumber
- 18 mallet
- 19 mandrel
- 20 socket (tinner's socket)
- 21 block
- 22 anvil
- 23 stake
- 24 circular saw (buzz saw)
- 25 flanging, swaging, and wiring machine
- 26 sheet shears (guillotine)
- 27 screw-cutting machine (thread-cutting machine, die stocks)
- 28 pipe-bending machine (bending machine, pipe bender)
- 29 welding transformer
- 30 bending machine (rounding machine) for shaping funnels



- 1 gas fitter and plumber
- 2 stepladder
- 3 safety chain
- 4 stopcock
- 5 gas meter
- 6 bracket
- 7 service riser
- 8 distributing pipe
- 9 supply pipe
- 10 pipe-cutting machine
- 11 pipe repair stand
- 12-25 gas and water appliances
- 12-13 geyser, an instantaneous water heater
- 12 gas water heater
- 13 electric water heater
- 14 toilet cistern
- 15 float
- 16 bell
- 17 flush pipe
- 18 water inlet
- 19 flushing lever (lever)
- 20 radiator
- 21 radiator rib
- 22 two-pipe system
- 23 flow pipe
- 24 return pipe
- 25 gas heater
- 26-37 plumbing fixtures
- 26 trap (anti-syphon trap)
- 27 mixer tap (Am. mixing faucet) for washbasins
- 28 hot tap
- 29 cold tap
- 30 extendible shower attachment
- 31 water tap (pillar tap) for washbasins
- 32 spindle top
- 33 shield
- 34 draw-off tap (Am. faucet)
- 35 supatap
- 36 swivel tap
- 37 flushing valve
- 38-52 fittings
- 38 joint with male thread
- 39 reducing socket (reducing coupler)
- 40 elbow screw joint (elbow coupling)
- 41 reducing socket (reducing coupler) with female thread
- 42 screw joint
- 43 coupler (socket)

- 44 T-joint (T-junction joint, tee)
- 45 elbow screw joint with female thread
- 46 bend
- 47 T-joint (T-junction joint, tee) with female taper thread
- 48 ceiling joint
- 49 reducing elbow
- 50 cross
- 51 elbow joint with male thread
- 52 elbow joint
- 53-57 pipe supports
- 53 saddle clip
- 54 spacing bracket
- 55 plug
- 56 pipe clips
- 57 two-piece spacing clip
- 58-86 plumber's tools, gas fitter's tools
- 58 gas pliers
- 59 footprints
- 60 combination cutting pliers
- 61 pipe wrench
- 62 flat-nose pliers
- 63 nipple key
- 64 round-nose pliers
- 65 pincers
- 66 adjustable S-wrench
- 67 screw wrench
- 68 shifting spanner
- 69 screwdriver
- 70 compass saw (keyhole saw)
- 71 hacksaw frame
- 72 hand saw
- 73 soldering iron
- 74 blowlamp (blowtorch) [for soldering]
- 75 sealing tape
- 76 tin-lead solder
- 77 club hammer
- 78 hammer
- 79 spirit level
- 80 steel-leg vice (Am. vise)
- 81 pipe vice (Am. vise)
- 82 pipe-bending machine
- 83 former (template)
- 84 pipe cutter
- 85 hand die
- 86 screw-cutting machine (thread-cutting machine)

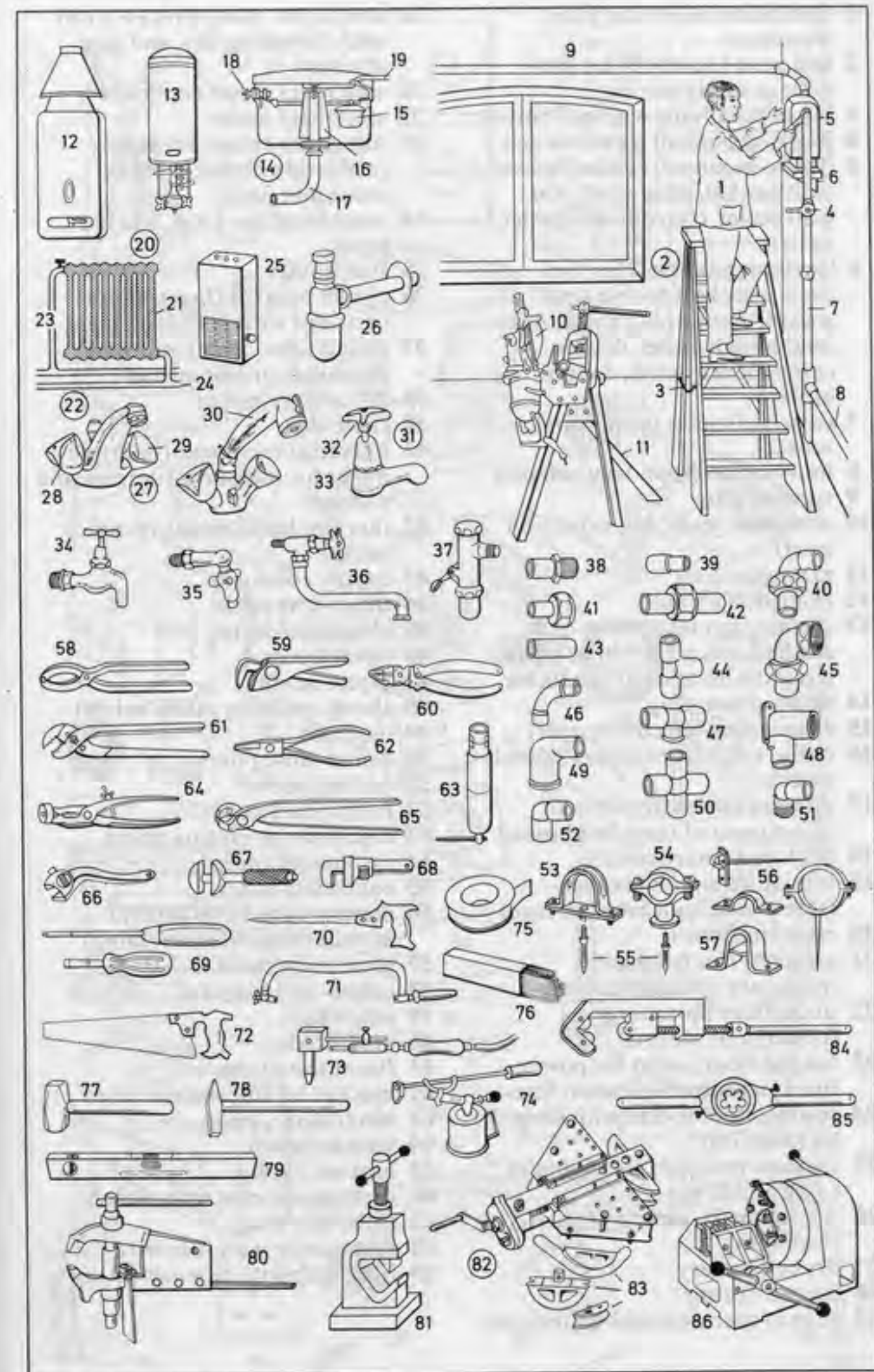



- 1 electrician (electrical fitter, wireman)
- 2 bell push (doorbell) for low-voltage safety current
- 3 house telephone with call button
- 4 [flush-mounted] rocker switch
- 5 [flush-mounted] earthed socket (wall socket, plug point, *Am.* wall outlet, convenience outlet, outlet)
- 6 [surface-mounted] earthed double socket (double wall socket, double plug point, *Am.* double wall outlet, double convenience outlet, double outlet)
- 7 switched socket (switch and socket)
- 8 four-socket (four-way) adapter
- 9 earthed plug
- 10 extension lead (*Am.* extension cord)
- 11 extension plug
- 12 extension socket
- 13 surface-mounted three-pole earthed socket [for three-phase circuit] with neutral conductor
- 14 three-phase plug
- 15 electric bell (electric buzzer)
- 16 pull-switch (cord-operated wall switch)
- 17 dimmer switch [for smooth adjustment of lamp brightness]
- 18 drill-cast rotary switch
- 19 miniature circuit breaker (screw-in circuit breaker, fuse)
- 20 resetting button
- 21 set screw [for fuses and miniature circuit breakers]
- 22 underfloor mounting (underfloor sockets)
- 23 hinged floor socket for power lines and communication lines
- 24 sunken floor socket with hinged lid (snap lid)
- 25 surface-mounted socket outlet (plug point) box
- 26 pocket torch, a torch (*Am.* flashlight)
- 27 dry cell battery
- 28 contact spring
- 29 strip of thermoplastic connectors
- 30 steel draw-in wire (draw wire) with threading key, and ring attached
- 31 electricity meter cupboard
- 32 electricity meter
- 33 miniature circuit breakers (miniature circuit breaker consumer unit)
- 34 insulating tape (*Am.* friction tape)
- 35 fuse holder
- 36 circuit breaker (fuse), a fuse cartridge with fusible element
- 37 colour (*Am.* color) indicator [showing current rating]
- 38-39 contact maker
- 40 cable clip
- 41 universal test meter (multiple meter for measuring current and voltage)
- 42 thermoplastic moisture-proof cable
- 43 copper conductor
- 44 three-core cable
- 45 electric soldering iron
- 46 screwdriver
- 47 pipe wrench
- 48 shock-resisting safety helmet
- 49 tool case
- 50 round-nose pliers
- 51 cutting pliers
- 52 junior hacksaw
- 53 combination cutting pliers
- 54 insulated handle
- 55 continuity tester
- 56 electric light bulb (general service lamp, filament lamp)
- 57 glass bulb (bulb)
- 58 coiled-coil filament
- 59 screw base
- 60 lampholder
- 61 fluorescent tube
- 62 bracket for fluorescent tubes
- 63 electrician's knife
- 64 wire strippers
- 65 bayonet fitting
- 66 three-pin socket with switch
- 67 three-pin plug
- 68 fuse carrier with fuse wire
- 69 light bulb with bayonet fitting

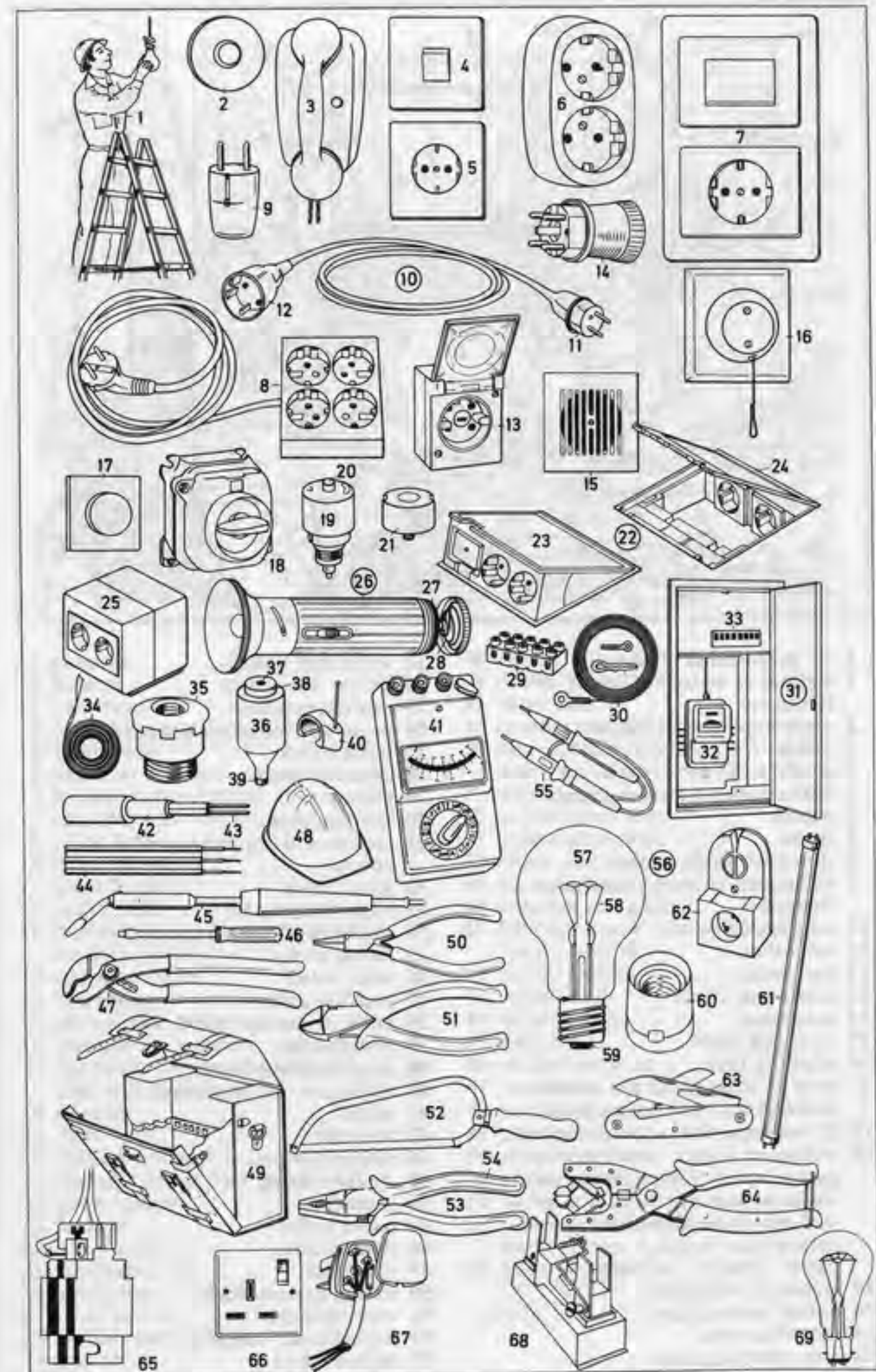

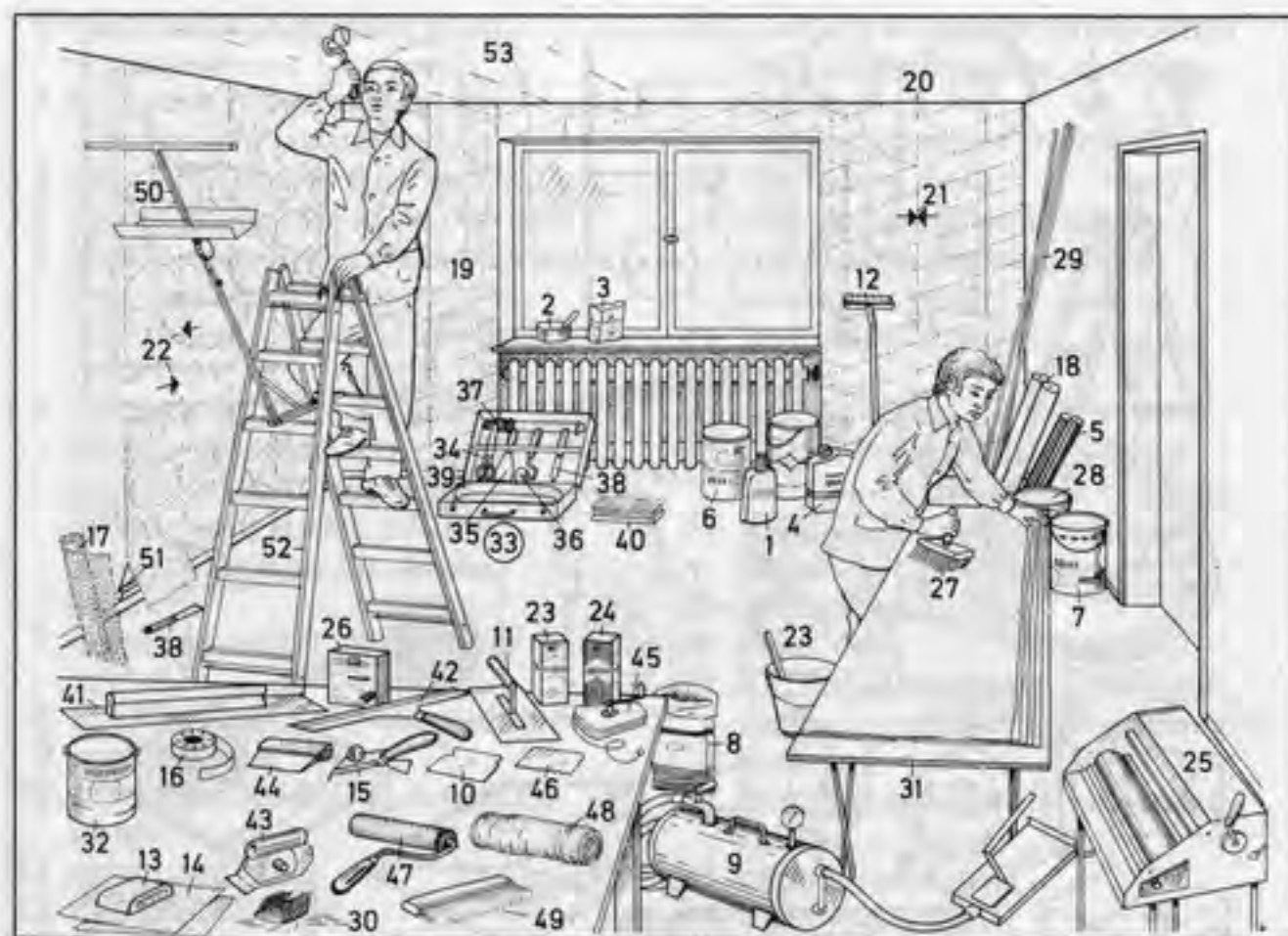

**1-17 preparation of surfaces**

- 1 wallpaper-stripping liquid (stripper)
- 2 plaster (plaster of Paris)
- 3 filler
- 4 glue size (size)
- 5 lining paper, a backing paper
- 6 primer
- 7 fluate
- 8 shredded lining paper
- 9 wallpaper-stripping machine (stripper)
- 10 scraper
- 11 smoother
- 12 perforator
- 13 sandpaper block
- 14 sandpaper
- 15 stripping knife
- 16 masking tape
- 17 strip of sheet metal [on which wallpaper is laid for cutting]
- 18-53 wallpapering (paper hanging)
- 18 wallpaper (*kinds*: wood pulp paper, wood chip paper, fabric wallhangings, synthetic wallpaper, metallic paper, natural (e.g. wood or cork) paper, tapestry wallpaper)
- 19 length of wallpaper
- 20 butted paper edges
- 21 matching edge
- 22 non-matching edge

- 23 wallpaper paste
- 24 heavy-duty paste
- 25 pasting machine
- 26 paste [for the pasting machine]
- 27 paste brush
- 28 emulsion paste
- 29 picture rail
- 30 beading pins
- 31 pasteboard (paperhanger's bench)
- 32 gloss finish
- 33 paperhanging kit
- 34 shears (bull-nosed scissors)
- 35 filling knife
- 36 seam roller
- 37 hacking knife
- 38 knife (trimming knife)
- 39 straightedge
- 40 paperhanging brush
- 41 wallpaper-cutting board
- 42 cutter
- 43 trimmer
- 44 plastic spatula
- 45 chalked string
- 46 spreader
- 47 paper roller
- 48 flannel cloth
- 49 dry brush
- 50 ceiling paperhanger
- 51 overlap angle
- 52 paperhanger's trestles
- 53 ceiling paper

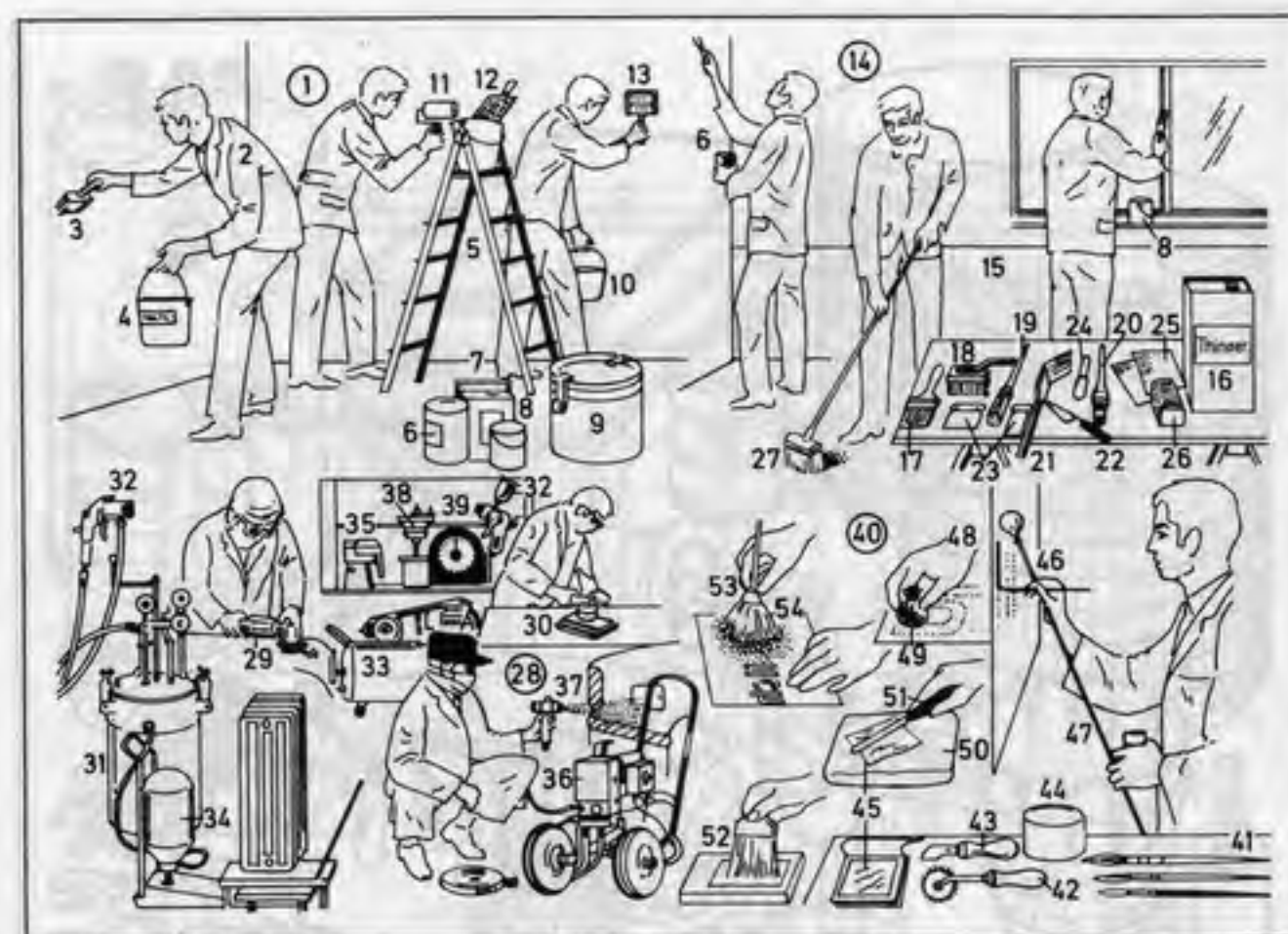

- 1 painting
- 2 painter
- 3 paintbrush
- 4 emulsion paint (emulsion)
- 5 stepladder
- 6 can (tin) of paint
- 7-8 cans (tins) of paint
- 7 can (tin) with fixed handle
- 8 paint kettle
- 9 drum of paint
- 10 paint bucket
- 11 paint roller
- 12 grill [for removing excess paint from the roller]
- 13 stippling roller
- 14 varnishing
- 15 oil-painted dado
- 16 canister for thinner
- 17 flat brush for larger surfaces (flat wall brush)
- 18 stippler
- 19 fitch
- 20 cutting-in brush
- 21 radiator brush (flay brush)
- 22 paint scraper
- 23 scraper
- 24 putty knife
- 25 sandpaper
- 26 sandpaper block
- 27 floor brush
- 28 sanding and spraying
- 29 grinder

- 30 sander
- 31 pressure pot
- 32 spray gun
- 33 compressor (air compressor)
- 34 flow coating machine for flow coating radiators, etc.
- 35 hand spray
- 36 airless spray unit
- 37 airless spray gun
- 38 efflux viscometer
- 39 seconds timer
- 40 lettering and gilding
- 41 lettering brush (signwriting brush, pencil)
- 42 tracing wheel
- 43 stencil knife
- 44 oil gold size
- 45 gold leaf
- 46 outline drawing
- 47 mahlstick
- 48 pouncing
- 49 pounce bag
- 50 gilder's cushion
- 51 gilder's knife
- 52 sizing gold leaf
- 53 filling in the letters with stipple paint
- 54 gilder's mop



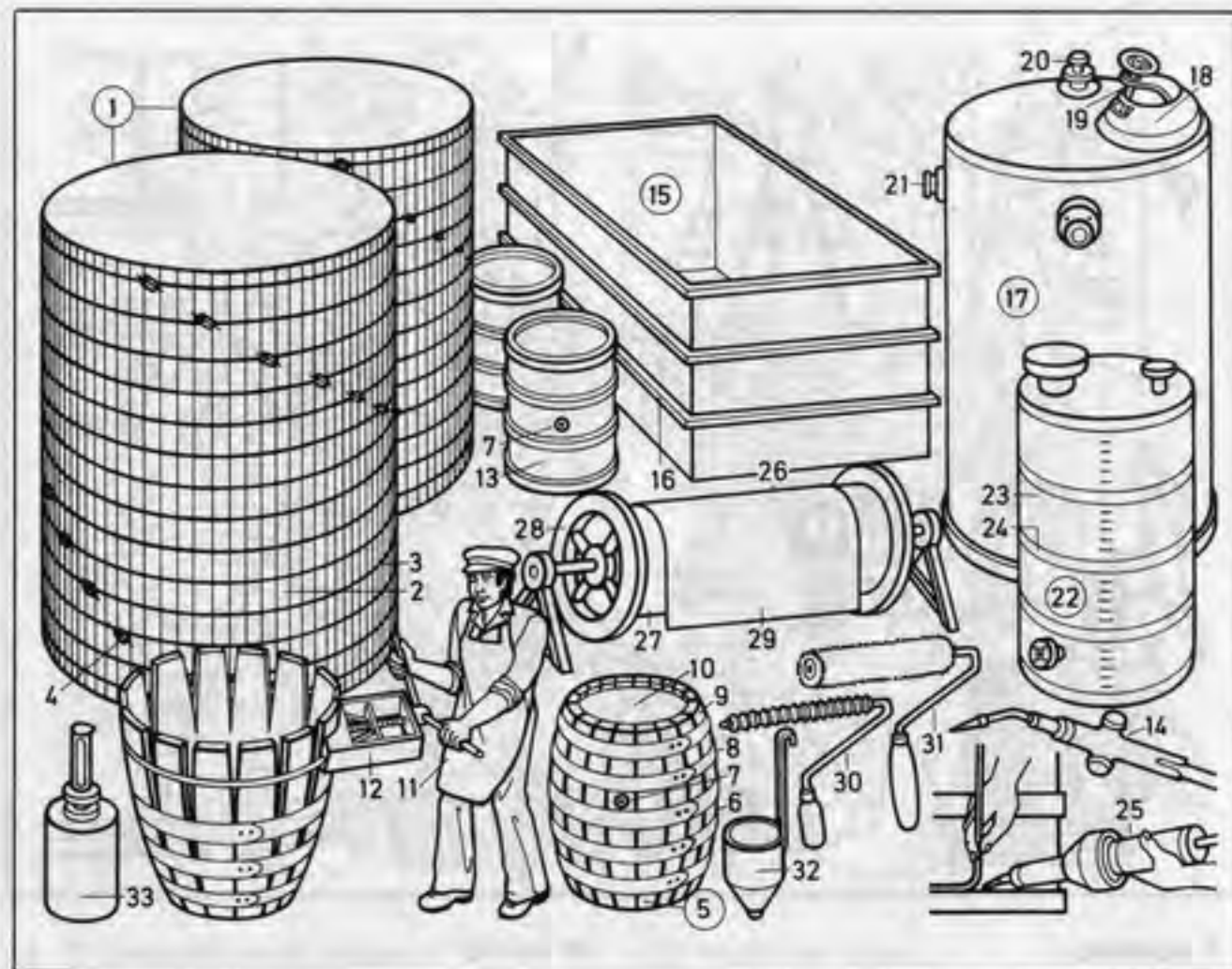

**1-33 cooper's and tank construction engineer's workshops**

- 1 tank
- 2 circumference made of staves (staved circumference)
- 3 iron rod
- 4 turnbuckle
- 5 barrel (cask)
- 6 body of barrel (of cask)
- 7 bunghole
- 8 band (hoop) of barrel
- 9 barrel stave
- 10 barrelhead (heading)
- 11 cooper
- 12 trusser
- 13 drum
- 14 gas welding torch
- 15 staining vat, made of thermoplastics
- 16 iron reinforcing bands
- 17 storage container, made of glass fibre (*Am.* glass fiber) reinforced polyester resin
- 18 manhole

- 19 manhole cover with handwheel
- 20 flange mount
- 21 flange-type stopcock
- 22 measuring tank
- 23 shell (circumference)
- 24 shrink ring
- 25 hot-air gun
- 26 roller made of glass fibre (*Am.* glass fiber) reinforced synthetic resin
- 27 cylinder
- 28 flange
- 29 glass cloth
- 30 grooved roller
- 31 lambskin roller
- 32 ladle for testing viscosity
- 33 measuring vessel for hardener

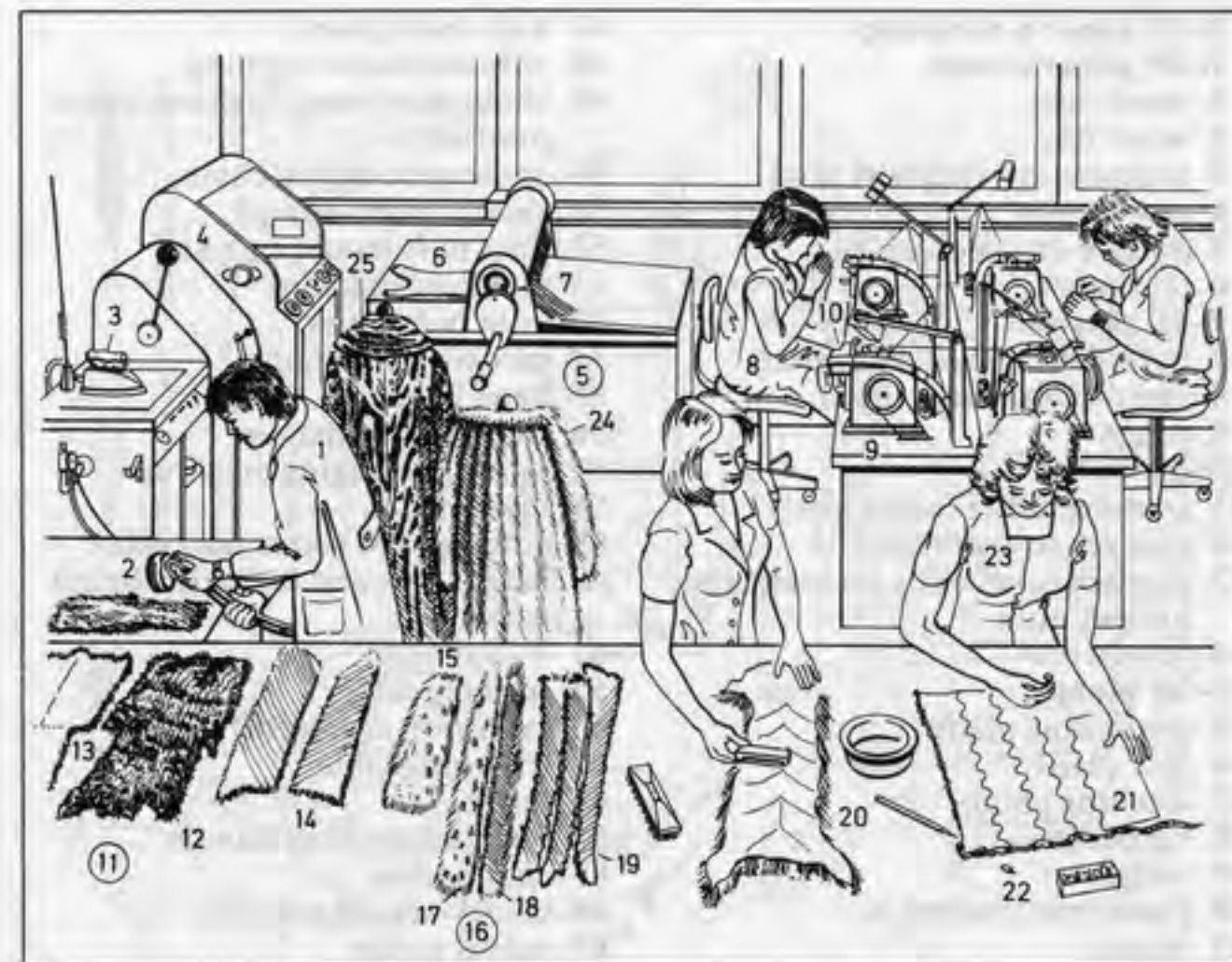

**1-25 furrier's workroom**

- 1 furrier
- 2 steam spray gun
- 3 steam iron
- 4 beating machine
- 5 cutting machine for letting out furskins
- 6 uncut furskin
- 7 let-out strips (let-out sections)
- 8 fur worker
- 9 fur-sewing machine
- 10 blower for letting out
- 11-21 furskins
- 11 mink skin
- 12 fur side
- 13 leather side
- 14 cut furskin
- 15 lynx skin before letting out
- 16 let-out lynx skin
- 17 fur side
- 18 leather side
- 19 let-out mink skin
- 20 lynx fur, sewn together (sewn)
- 21 broadtail

- 22 fur marker
- 23 fur worker
- 24 mink coat
- 25 ocelot coat



- 1-73 joiner's workshop
- 1-28 joiner's tools
- 1 wood rasp
- 2 wood file
- 3 compass saw (keyhole saw)
- 4 saw handle
- 5 [square-headed] mallet
- 6 try square
- 7-11 chisels
- 7 bevelled-edge chisel (chisel)
- 8 mortise (mortice) chisel
- 9 gouge
- 10 handle
- 11 framing chisel (cant chisel)
- 12 glue pot in water bath
- 13 glue pot (glue well), an insert for joiner's glue
- 14 handscrew
- 15-28 planes
- 15 smoothing plane
- 16 jack plane
- 17 tothing plane
- 18 handle (toat)
- 19 wedge
- 20 plane iron (cutter)
- 21 mouth
- 22 sole
- 23 side
- 24 stock (body)
- 25 rebate (rabbet) plane
- 26 router plane (old woman's tooth)
- 27 spokeshave
- 28 compass plane
- 29-37 woodworker's bench
- 29 foot
- 30 front vice (*Am. vise*)
- 31 vice (*Am. vise*) handle
- 32 vice (*Am. vise*) screw
- 33 jaw
- 34 bench top
- 35 well
- 36 bench stop (bench holdfast)
- 37 tail vice (*Am. vise*)
- 38 cabinet maker (joiner)
- 39 trying plane
- 40 shavings
- 41 wood screw
- 42 saw set
- 43 mitre (*Am. miter*) box
- 44 tenon saw
- 45 thicknesser (thicknessing machine)
- 46 thicknessing table with rollers

- 47 kick-back guard
- 48 chip-extractor opening
- 49 chain mortising machine (chain mortiser)
- 50 endless mortising chain
- 51 clamp (work clamp)
- 52 knot hole moulding (*Am. molding*) machine
- 53 knot hole cutter
- 54 quick-action chuck
- 55 hand lever
- 56 change-gear handle
- 57 sizing and edging machine
- 58 main switch
- 59 circular-saw (buzz saw) blade
- 60 height (rise and fall) adjustment wheel
- 61 V-way
- 62 framing table
- 63 extension arm (arm)
- 64 trimming table
- 65 fence
- 66 fence adjustment handle
- 67 clamp lever
- 68 board-sawing machine
- 69 swivel motor
- 70 board support
- 71 saw carriage
- 72 pedal for raising the transport rollers
- 73 block board

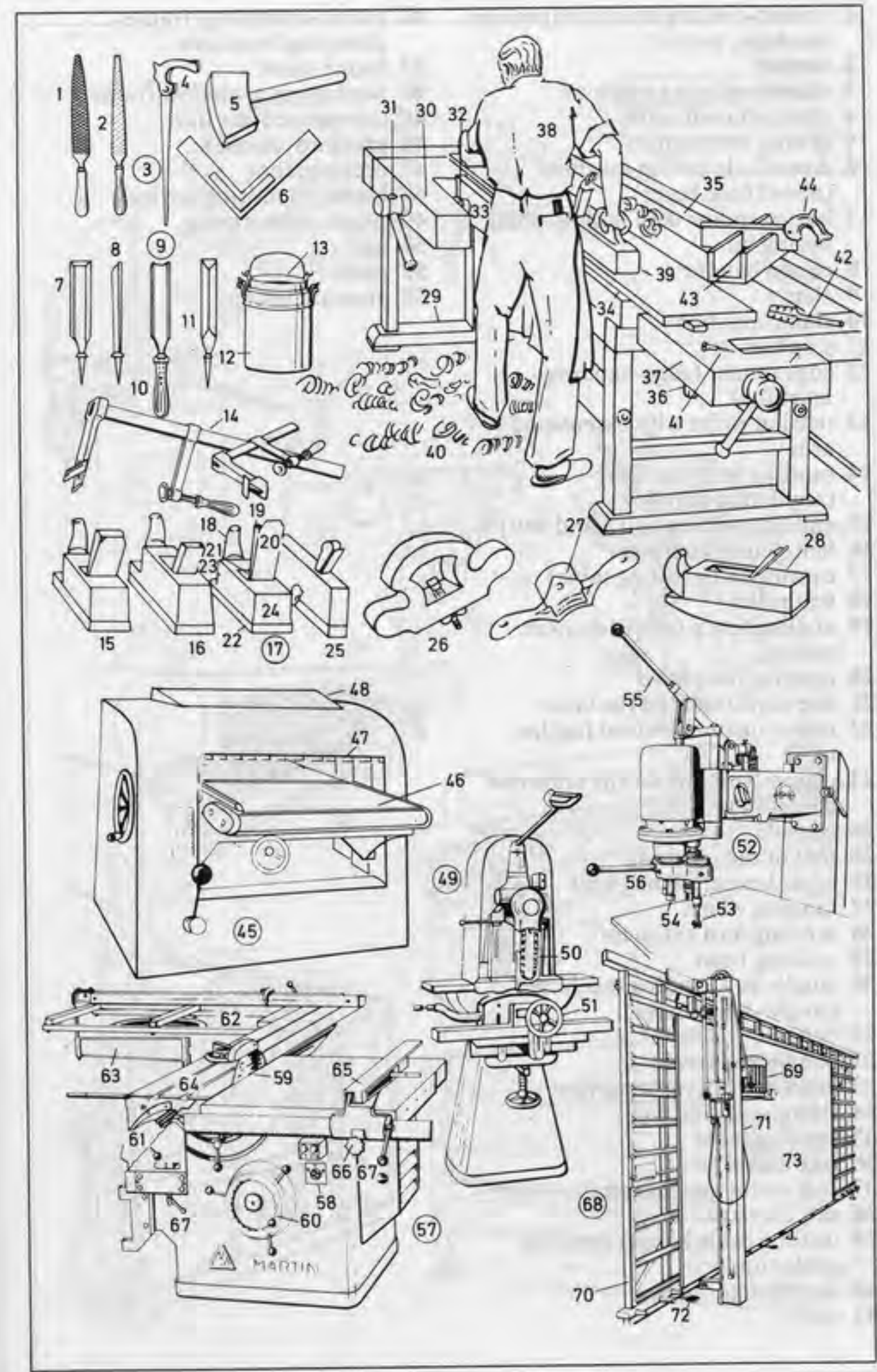



- |   |  |
|---|--|
| 1 veneer-peeling machine (peeling machine, peeler)  | 42 frame-cramping (frame-clamping) machine |
| 2 veneer  | 43 frame stand                             |
| 3 veneer-splicing machine                           | 44 workpiece, a window frame               |
| 4 nylon-thread cop                                  | 45 compressed-air line                     |
| 5 sewing mechanism                                  | 46 pressure cylinder                       |
| 6 dowel hole boring machine (dowel hole borer)      | 47 pressure foot                           |
| 7 boring motor with hollow-shaft boring bit         | 48 frame-mounting device                   |
| 8 clamp handle                                      | 49 rapid-veneer press                      |
| 9 clamp   | 50 bed                                     |
| 10 clamping shoe                                    | 51 press                                   |
| 11 stop bar   | 52 pressure piston                         |
| 12 edge sander (edge-sanding machine)               |  |
| 13 tension roller with extension arm                |  |
| 14 sanding belt regulator (regulating handle)       |  |
| 15 endless sanding belt (sand belt)                 |  |
| 16 belt-tensioning lever                            |  |
| 17 canting table (tilting table)                    |  |
| 18 belt roller                                      |  |
| 19 angling fence for mitres ( <i>Am.</i> miters)    |  |
| 20 opening dust hood                                |  |
| 21 rise adjustment of the table                     |  |
| 22 rise adjustment wheel for the table              |  |
| 23 clamping screw for the table rise adjustment     |  |
| 24 console  |  |
| 25 foot of the machine                              |  |
| 26 edge-veneering machine                           |  |
| 27 sanding wheel                                    |  |
| 28 sanding dust extractor                           |  |
| 29 splicing head                                    |  |
| 30 single-belt sanding machine (single-belt sander) |  |
| 31 belt guard                                       |  |
| 32 bandwheel cover                                  |  |
| 33 extractor fan (exhaust fan)                      |  |
| 34 frame-sanding pad                                |  |
| 35 sanding table                                    |  |
| 36 fine adjustment                                  |  |
| 37 fine cutter and jointer                          |  |
| 38 saw carriage                                     |  |
| 39 trailing cable hanger (trailing cable support)   |  |
| 40 air extractor pipe                               |  |
| 41 rail   |  |

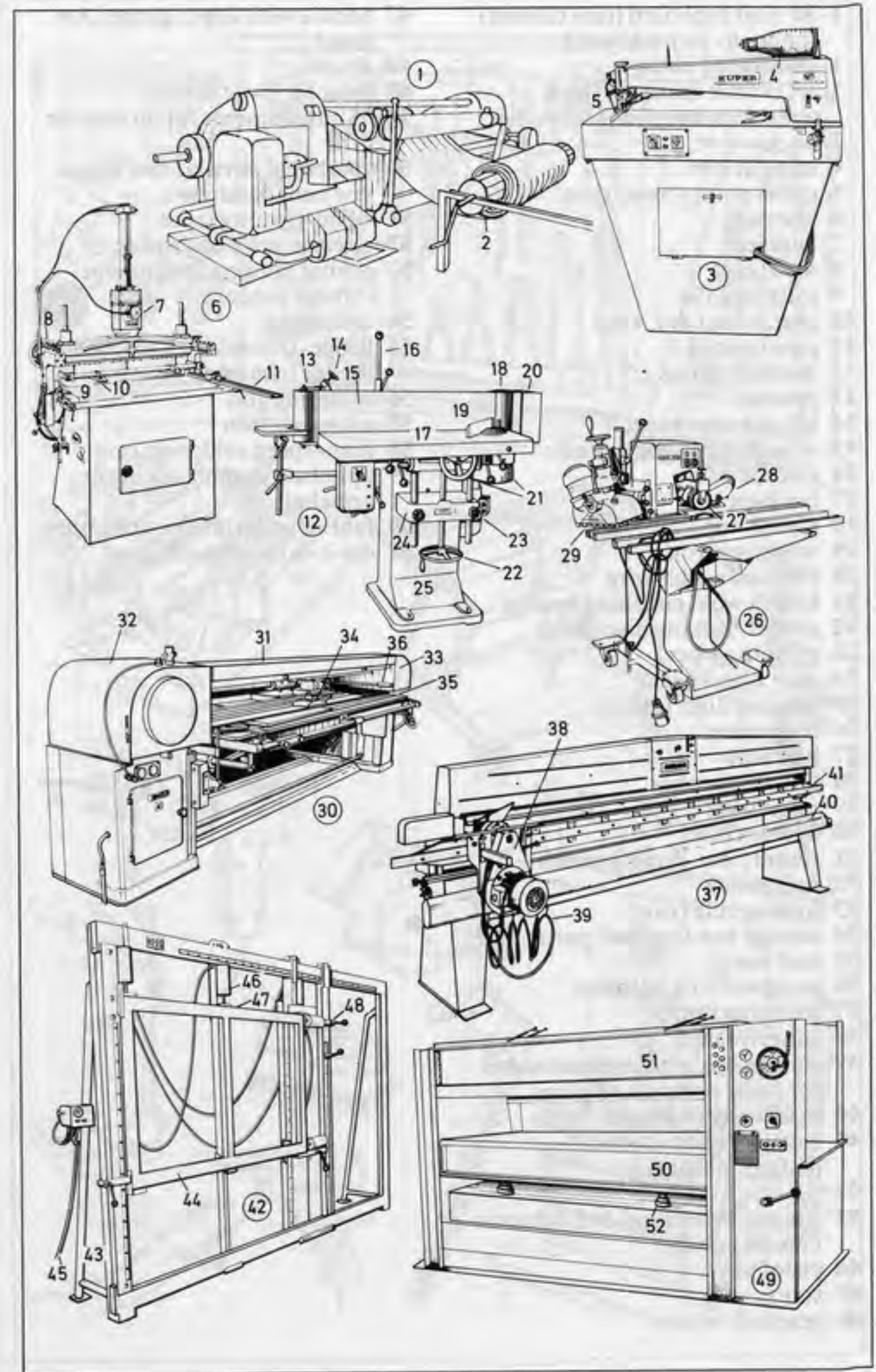



- 1-34 tool cupboard (tool cabinet) for do-it-yourself work
- 1 smoothing plane
  - 2 set of fork spanners (fork wrenches, open-end wrenches)
  - 3 hacksaw
  - 4 screwdriver
  - 5 cross-point screwdriver
  - 6 saw rasp
  - 7 hammer
  - 8 wood rasp
  - 9 roughing file
  - 10 small vice (*Am. vise*)
  - 11 pipe wrench
  - 12 multiple pliers
  - 13 pincers
  - 14 all-purpose wrench
  - 15 wire stripper and cutter
  - 16 electric drill
  - 17 hacksaw
  - 18 plaster cup
  - 19 soldering iron
  - 20 tin-lead solder wire
  - 21 lamb's wool polishing bonnet
  - 22 rubber backing disc (disk)
  - 23 grinding wheel
  - 24 wire wheel brush
  - 25 sanding discs (disks)
  - 26 try square
  - 27 hand saw
  - 28 universal cutter
  - 29 spirit level
  - 30 firmer chisel
  - 31 centre (*Am. center*) punch
  - 32 nail punch
  - 33 folding rule (rule)
  - 34 storage box for small parts
  - 35 tool box
  - 36 woodworking adhesive
  - 37 stripping knife
  - 38 adhesive tape
  - 39 storage box with compartments for nails, screws, and plugs
  - 40 machinist's hammer
  - 41 collapsible workbench (collapsible bench)
  - 42 jig
  - 43 electric percussion drill (electric hammer drill)
  - 44 pistol grip
  - 45 side grip
  - 46 gearshift switch
  - 47 handle with depth gauge (*Am. gage*)
  - 48 chuck
  - 49 twist bit (twist drill)
  - 50-55 attachments for an electric drill
  - 50 combined circular saw (buzz saw) and bandsaw
  - 51 wood-turning lathe
  - 52 circular saw attachment
  - 53 orbital sanding attachment (orbital sander)
  - 54 drill stand
  - 55 hedge-trimming attachment (hedge trimmer)
  - 56 soldering gun
  - 57 soldering iron
  - 58 high-speed soldering iron
  - 59 upholstery, upholstering an armchair
  - 60 fabric (material) for upholstery
  - 61 do-it-yourself enthusiast

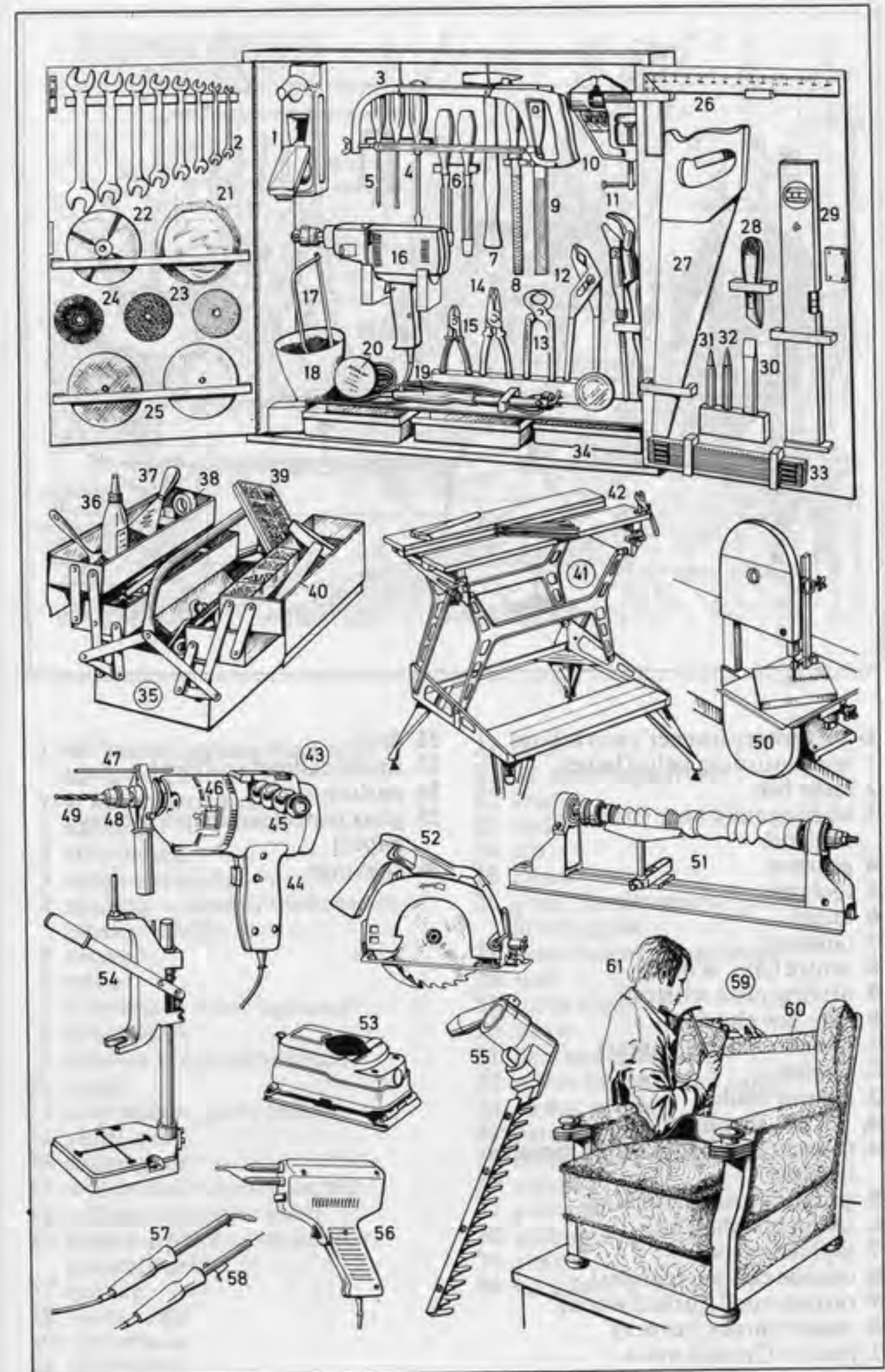

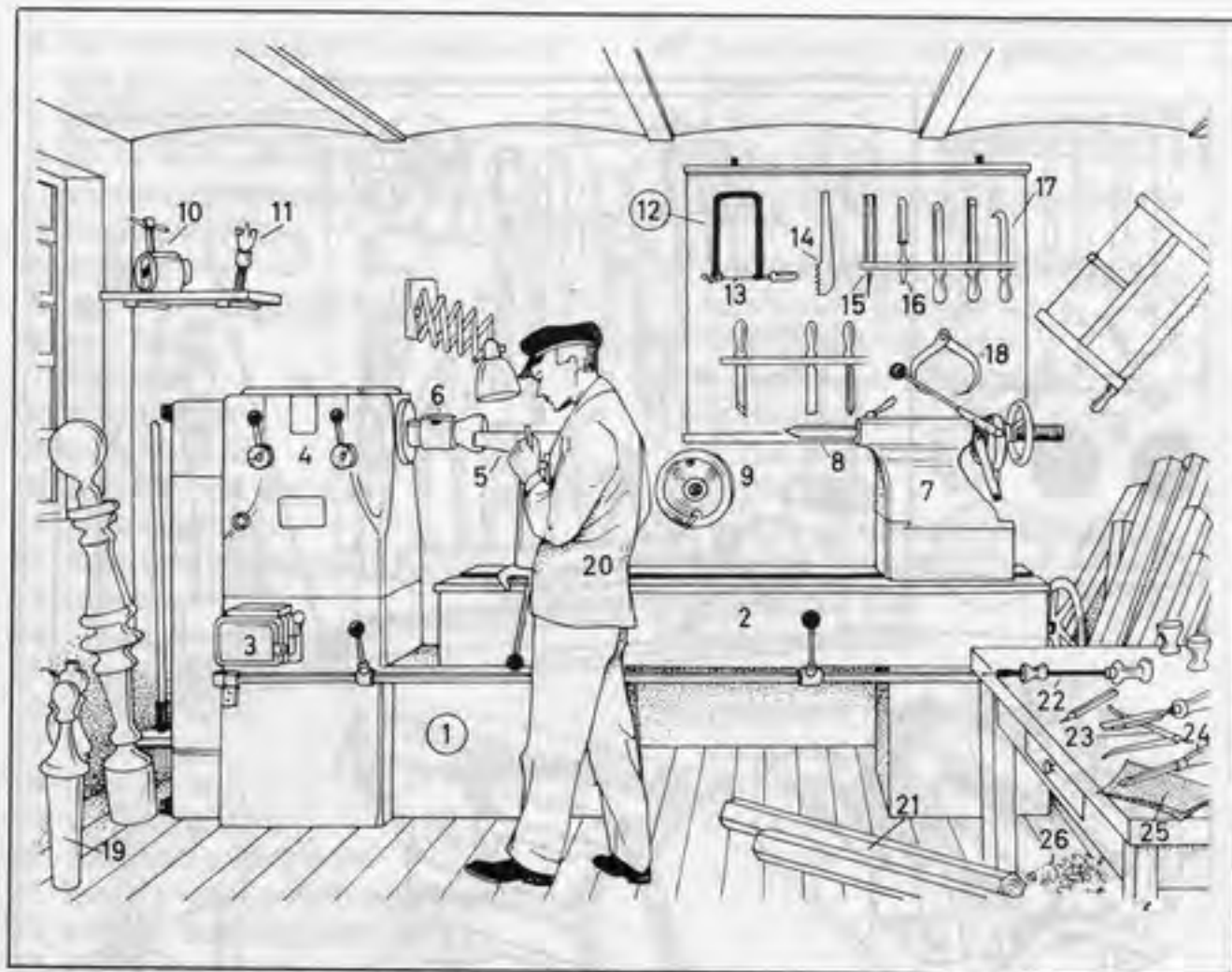

**1-26 turnery (turner's workshop)**

- |   |   |
|---|---|
| 1 wood-turning lathe (lathe)                  | 22 drill                                |
| 2 lathe bed                                   | 23 inside calliper (caliper)            |
| 3 starting resistance (starting resistor)     | 24 parting tool                         |
| 4 gearbox                                     | 25 glass paper (sandpaper, emery paper) |
| 5 tool rest                                   | 26 shavings                             |
| 6 chuck                                       |   |
| 7 tailstock                                   |   |
| 8 centre ( <i>Am.</i> center)                 |   |
| 9 driving plate with pin                      |   |
| 10 two-jaw chuck                              |   |
| 11 live centre ( <i>Am.</i> center)           |   |
| 12 fretsaw                                    |   |
| 13 fretsaw blade                              |   |
| 14, 15, 24 turning tools                      |   |
| 14 thread chaser, for cutting threads in wood |   |
| 15 gouge, for rough turning                   |   |
| 16 spoon bit (shell bit)                      |   |
| 17 hollowing tool                             |   |
| 18 outside calliper (caliper)                 |   |
| 19 turned work (turned wood)                  |   |
| 20 master turner (turner)                     |   |
| 21 [piece of] rough wood                      |   |

**1-40 basket making (basketry, basketwork)**

- |  |   |
|--|---|
| 1-4 weaves (strokes)                           | 21 slath  |
| 1 randing                                      | 22-24 covering a frame                                |
| 2 rib randing                                  | 22 frame  |
| 3 oblique randing                              | 23 end  |
| 4 randing, a piece of wickerwork (screen work) | 24 rib  |
| 5 weaver                                       | 25 upsett   |
| 6 stake  | 26 grass; <i>kinds</i> : esparto grass, alfalfa grass |
| 7 workboard; <i>also</i> : lapboard            | 27 rush (bulrush, reed mace)                          |
| 8 screw block                                  | 28 reed   |
| 9 hole for holding the block                   | 29 raffia (bast)                                      |
| 10 stand                                       | 30 straw  |
| 11 chip basket (spale basket)                  | 31 bamboo cane  |
| 12 chip (spale)                                | 32 rattan (ratan) chair cane                          |
| 13 soaking tub                                 | 33 basket maker                                       |
| 14 willow stakes (osier stakes)                | 34 bending tool                                       |
| 15 willow rods (osier rods)                    | 35 cutting point (bodkin)                             |
| 16 basket, a piece of wickerwork (basketwork)  | 36 rapping iron                                       |
| 17 border                                      | 37 pincers  |
| 18 woven side                                  | 38 picking knife                                      |
| 19 round base                                  | 39 shave  |
| 20 woven base                                  | 40 hacksaw  |



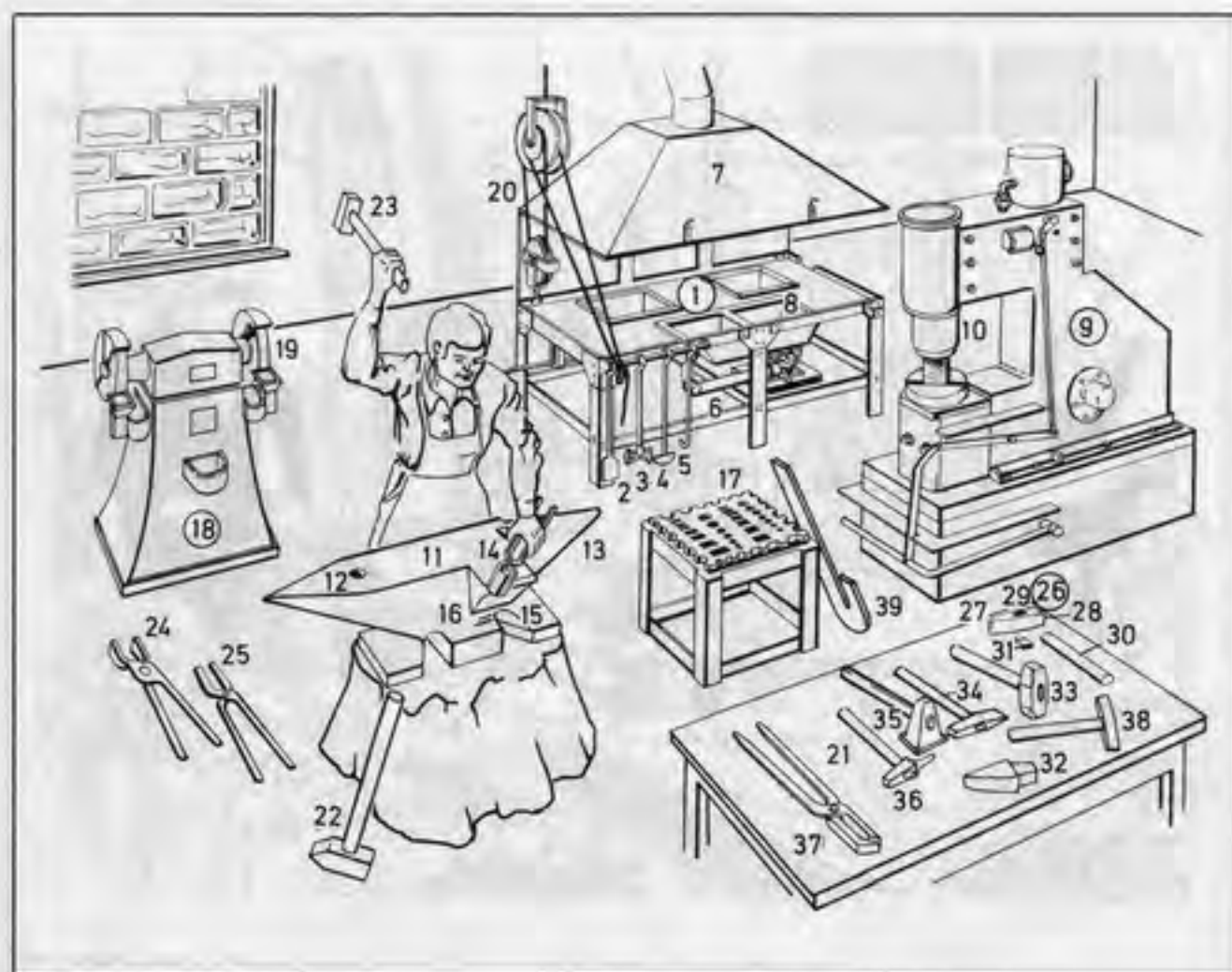

**1-8 hearth (forge) with blacksmith's fire**

- 1 hearth (forge)
- 2 shovel (slice)
- 3 swab
- 4 rake
- 5 poker
- 6 blast pipe (tue iron)
- 7 chimney (cowl, hood)
- 8 water trough (quenching trough, bosh)
- 9 power hammer
- 10 ram (tup)
- 11-16 anvil**
- 11 anvil
- 12 flat beak (beck, bick)
- 13 round beak (beck, bick)
- 14 auxiliary table
- 15 foot
- 16 upsetting block
- 17 swage block
- 18 tool-grinding machine (tool grinder)
- 19 grinding wheel
- 20 block and tackle

**21 workbench (bench)**

**22-39 blacksmith's tools**

- 22 sledge hammer
- 23 blacksmith's hand hammer
- 24 flat tongs
- 25 round tongs
- 26 parts of the hammer
- 27 peen (pane, pein)
- 28 face
- 29 eye
- 30 haft
- 31 cotter punch
- 32 hardy (hardie)
- 33 set hammer
- 34 sett (set, sate)
- 35 flat-face hammer (flatter)
- 36 round punch
- 37 angle tongs
- 38 blacksmith's chisel (scaling hammer, chipping hammer)
- 39 moving iron (bending iron)

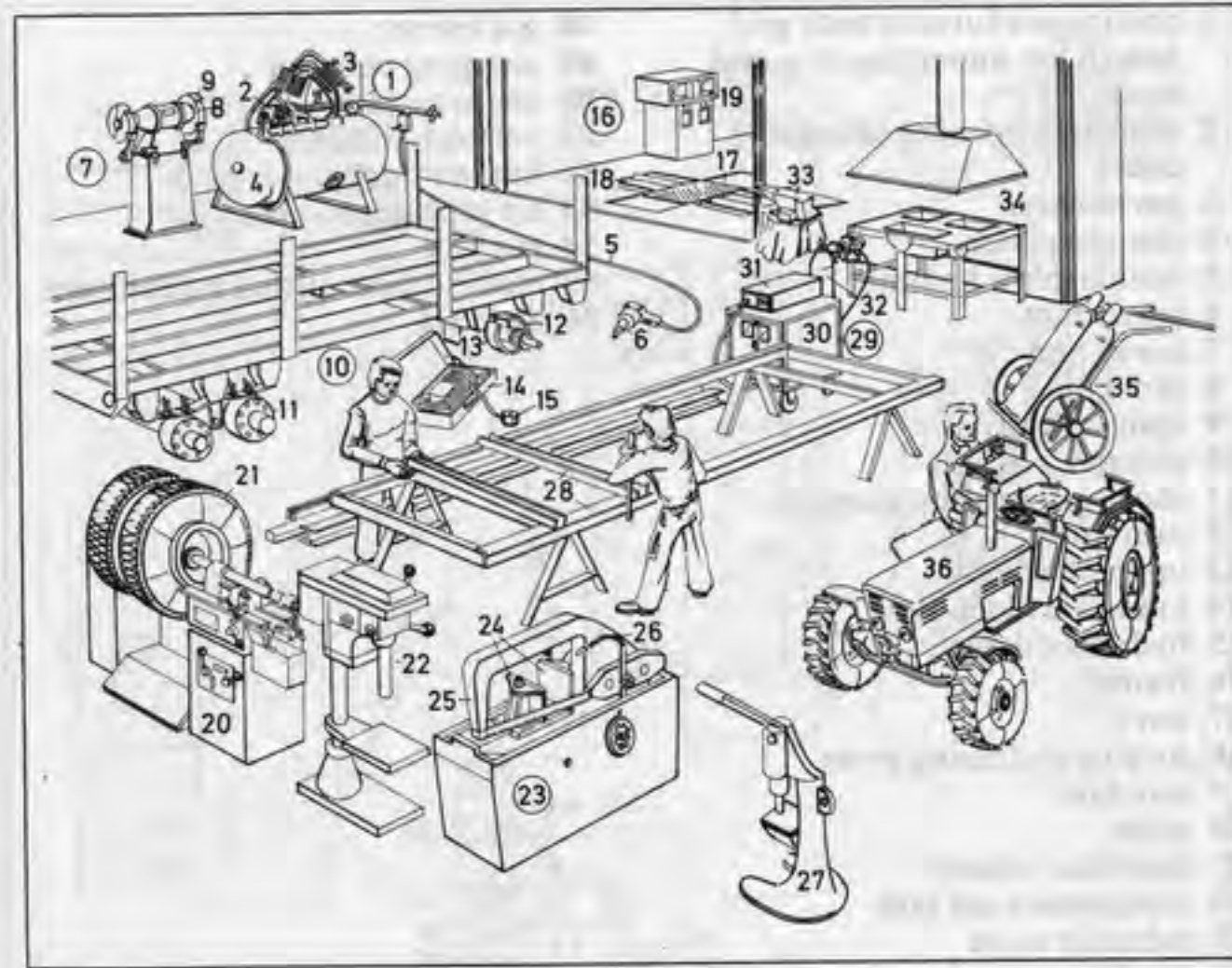

**1 compressed-air system**

- 2 electric motor
- 3 compressor
- 4 compressed-air tank
- 5 compressed-air line
- 6 percussion screwdriver
- 7 pedestal grinding machine (floor grinding machine)
- 8 grinding wheel
- 9 guard
- 10 trailer
- 11 brake drum
- 12 brake shoe
- 13 brake lining
- 14 testing kit
- 15 pressure gauge (*Am. gage*)
- 16 brake-testing equipment, a rolling road
- 17 pit
- 18 braking roller
- 19 meter (recording meter)
- 20 precision lathe for brake drums
- 21 lorry wheel
- 22 boring mill

**23 power saw, a hacksaw (power hacksaw)**

- 24 vice (*Am. vise*)
- 25 saw frame
- 26 coolant supply pipe
- 27 riveting machine
- 28 trailer frame (chassis) under construction
- 29 inert-gas welding equipment
- 30 rectifier
- 31 control unit
- 32 CO<sub>2</sub> cylinder
- 33 anvil
- 34 hearth (forge) with blacksmith's fire
- 35 trolley for gas cylinders
- 36 vehicle under repair, a tractor



- 1 continuous furnace with grid hearth for annealing of round stock
- 2 discharge opening (discharge door)
- 3 gas burners
- 4 charging door
- 5 counterblow hammer
- 6 upper ram
- 7 lower ram
- 8 ram guide
- 9 hydraulic drive
- 10 column
- 11 short-stroke drop hammer
- 12 ram (tup)
- 13 upper die block
- 14 lower die block
- 15 hydraulic drive
- 16 frame
- 17 anvil
- 18 forging and sizing press
- 19 standard
- 20 table
- 21 disc (disk) clutch
- 22 compressed-air pipe
- 23 solenoid valve
- 24 air-lift gravity hammer (air-lift drop hammer)
- 25 drive motor
- 26 hammer (tup)
- 27 foot control (foot pedal)
- 28 preshaped (blocked) workpiece
- 29 hammer guide
- 30 hammer cylinder
- 31 anvil
- 32 mechanical manipulator to move the workpiece in hammer forging
- 33 dogs
- 34 counterweight
- 35 hydraulic forging press
- 36 crown
- 37 cross head
- 38 upper die block
- 39 lower die block
- 40 anvil
- 41 hydraulic piston
- 42 pillar guide
- 43 rollover device
- 44 burden chain (chain sling)
- 45 crane hook
- 46 workpiece
- 47 gas furnace (gas-fired furnace)

- 48 gas burner
- 49 charging opening
- 50 chain curtain
- 51 vertical-lift door
- 52 hot-air duct
- 53 air preheater
- 54 gas pipe
- 55 electric door-lifting mechanism
- 56 air blast

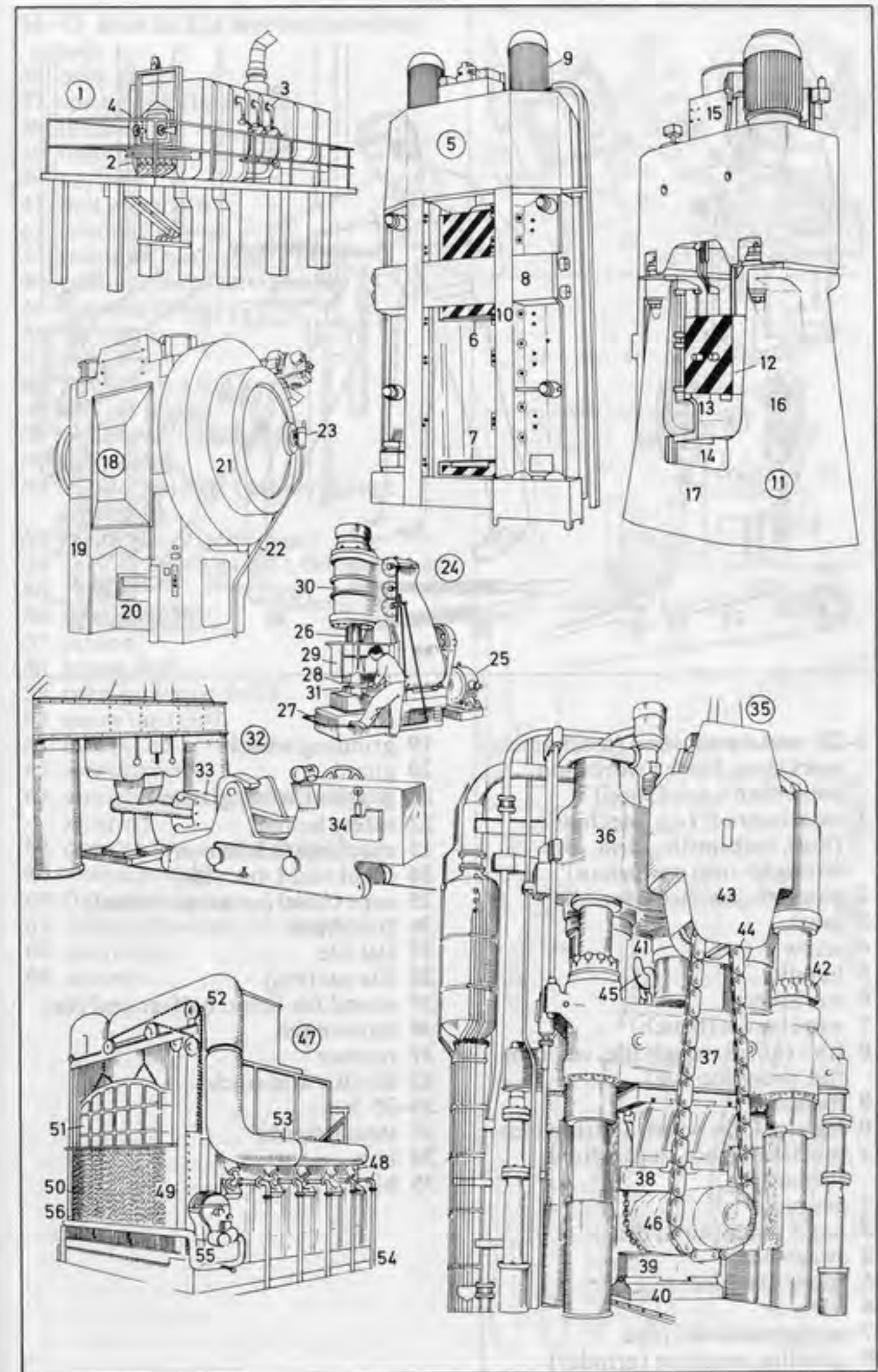



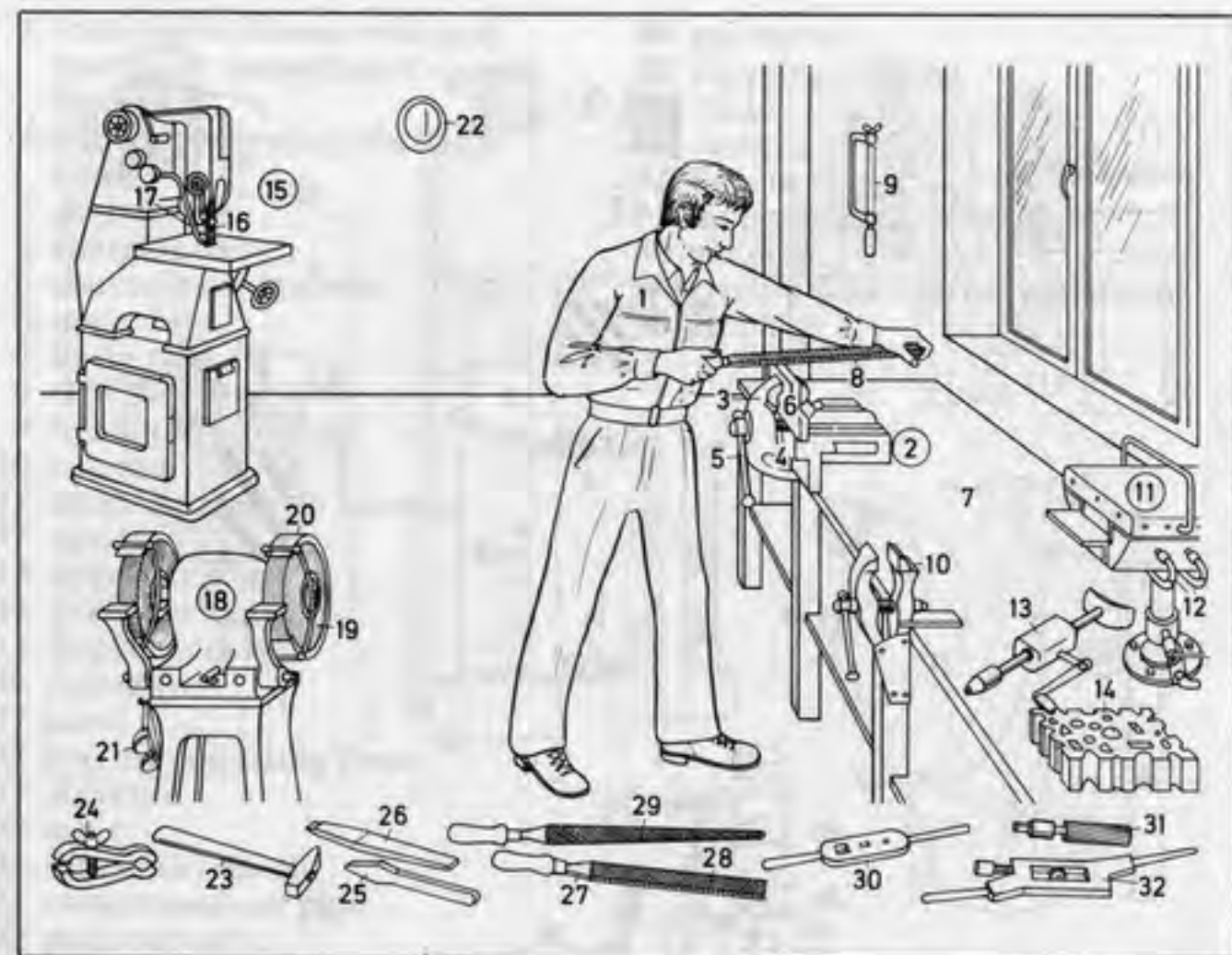

**1-22 metalwork shop** (mechanic's workshop, fitter's workshop, locksmith's workshop)

- 1 metalworker (e.g. mechanic, fitter, locksmith; *form. also:* wrought-iron craftsman)  
 2 parallel-jaw vice (*Am. vise*)  
 3 jaw  
 4 screw  
 5 handle  
 6 workpiece  
 7 workbench (bench)  
 8 files (*kinds:* rough file, smooth file, precision file)  
 9 hacksaw  
 10 leg vice (*Am. vise*), a spring vice  
 11 muffle furnace, a gas-fired furnace  
 12 gas pipe  
 13 hand brace (hand drill)  
 14 swage block  
 15 filing machine  
 16 file  
 17 compressed-air pipe  
 18 grinding machine (grinder)

- 19 grinding wheel  
 20 guard  
 21 goggles (safety glasses)  
 22 safety helmet  
 23 machinist's hammer  
 24 hand vice (*Am. vise*)  
 25 cape chisel (cross-cut chisel)  
 26 flat chisel  
 27 flat file  
 28 file cut (cut)  
 29 round file (*also:* half-round file)  
 30 tap wrench  
 31 reamer  
 32 die (die and stock)  
**33-35 key**  
 33 stem (shank)  
 34 bow  
 35 bit

**36-43 door lock, a mortise (mortice) lock**

- 36 back plate  
 37 spring bolt (latch bolt)  
 38 tumbler  
 39 bolt  
 40 keyhole  
 41 bolt guide pin  
 42 tumbler spring  
 43 follower, with square hole  
 44 cylinder lock (safety lock)  
 45 cylinder (plug)  
 46 spring  
 47 pin  
 48 safety key, a flat key  
 49 lift-off hinge  
 50 hook-and-ride band  
 51 strap hinge  
 52 vernier calliper (caliper) gauge (*Am. gage*)  
 53 feeler gauge (*Am. gage*)  
 54 vernier depth gauge (*Am. gage*)  
 55 vernier  
 56 straightedge  
 57 square  
 58 breast drill  
 59 twist bit (twist drill)  
 60 screw tap (tap)  
 61 halves of a screw die  
 62 screwdriver  
 63 scraper (*also:* pointed triangle scraper)  
 64 centre (*Am. center*) punch  
 65 round punch  
 66 flat-nose pliers  
 67 detachable-jaw cut nippers  
 68 gas pliers  
 69 pincers

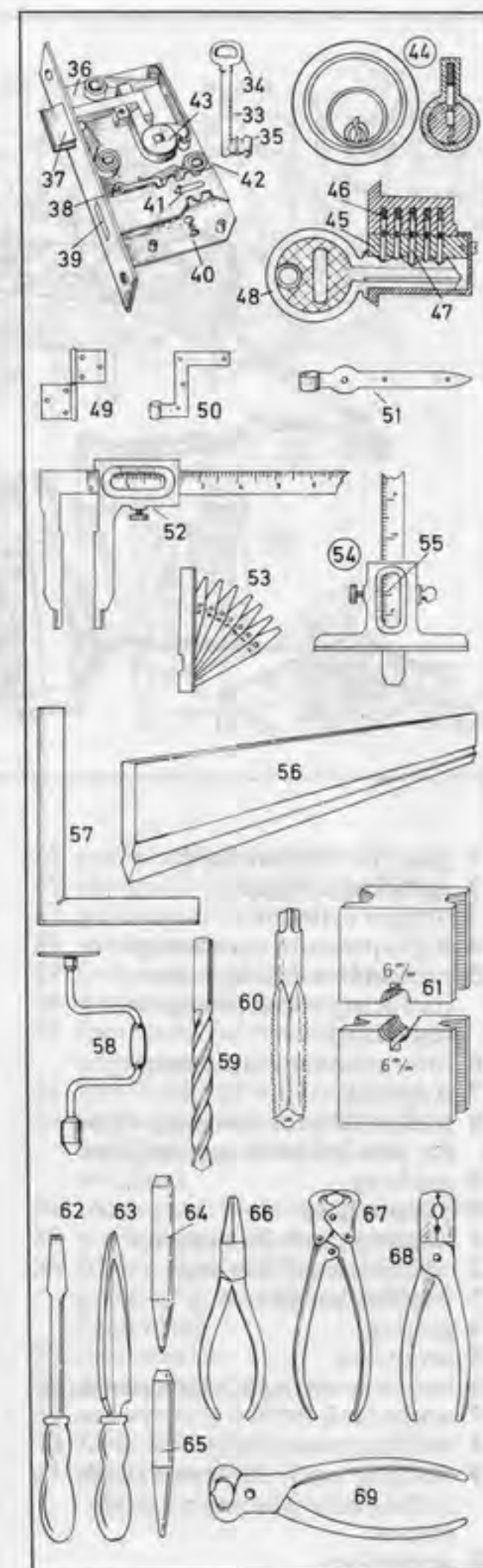



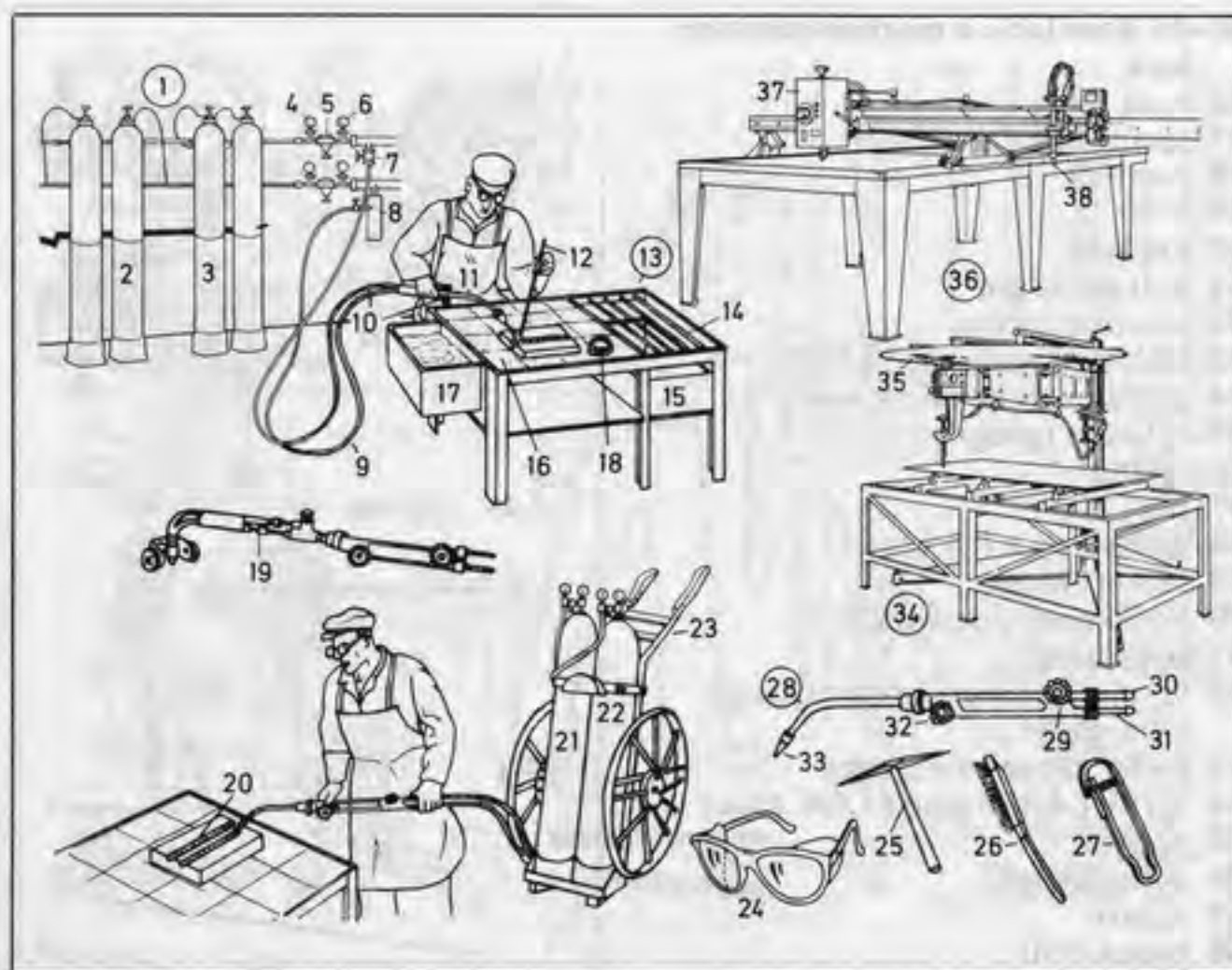

- |   |  |
|---|--|
| 1 gas cylinder manifold   | 21 oxygen cylinder                       |
| 2 acetylene cylinder  | 22 acetylene cylinder                    |
| 3 oxygen cylinder   | 23 cylinder trolley                      |
| 4 high-pressure manometer   | 24 welding goggles                       |
| 5 pressure-reducing valve (reducing valve, pressure regulator)        | 25 chipping hammer                       |
| 6 low-pressure manometer  | 26 wire brush                            |
| 7 stopcock  | 27 torch lighter (blowpipe lighter)      |
| 8 hydraulic back-pressure valve for low-pressure installations        | 28 welding torch (blowpipe)              |
| 9 gas hose  | 29 oxygen control                        |
| 10 oxygen hose  | 30 oxygen connection                     |
| 11 welding torch (blowpipe)   | 31 gas connection (acetylene connection) |
| 12 welding rod (filler rod)   | 32 gas control (acetylene control)       |
| 13 welding bench  | 33 welding nozzle                        |
| 14 grating  | 34 cutting machine                       |
| 15 scrap box  | 35 circular template                     |
| 16 bench covering of chamotte slabs                                   | 36 universal cutting machine             |
| 17 water tank   | 37 tracing head                          |
| 18 welding paste (flux)   | 38 cutting nozzle                        |
| 19 welding torch (blowpipe) with cutting attachment and guide tractor |  |
| 20 workpiece  |  |

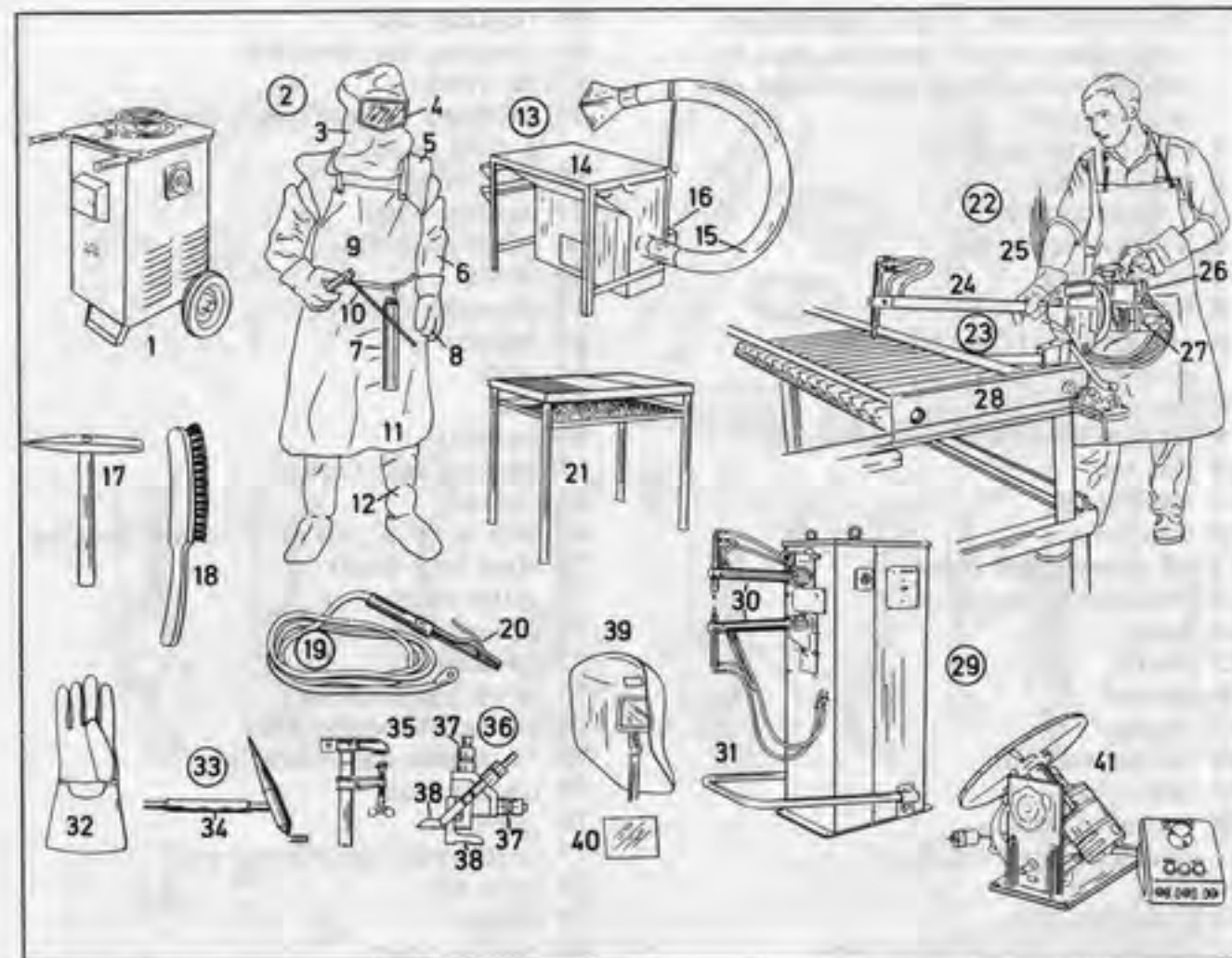

- |   |   |
|---|---|
| 1 welding transformer                           | 25 power supply (lead)  |
| 2 arc welder                                    | 26 electrode-pressure cylinder  |
| 3 arc welding helmet                            | 27 welding transformer  |
| 4 flip-up window                                | 28 workpiece  |
| 5 shoulder guard                                | 29 foot-operated spot welder  |
| 6 protective sleeve                             | 30 welder electrode arms  |
| 7 electrode case                                | 31 foot pedal for welding pressure adjustment                                     |
| 8 three-fingered welding glove                  | 32 five-fingered welding glove  |
| 9 electrode holder                              | 33 inert-gas torch for inert-gas welding (gas-shielded arc welding)               |
| 10 electrode                                    | 34 inert-gas (shielding-gas) supply   |
| 11 leather apron                                | 35 work clamp (earthing clamp)  |
| 12 shin guard                                   | 36 fillet gauge ( <i>Am. gage</i> ) (weld gauge) [for measuring throat thickness] |
| 13 welding table with fume extraction equipment | 37 micrometer   |
| 14 table top                                    | 38 measuring arm  |
| 15 movable extractor duct                       | 39 arc welding helmet   |
| 16 extractor support                            | 40 filter lens  |
| 17 chipping hammer                              | 41 small turntable  |
| 18 wire brush                                   |   |
| 19 welding lead                                 |   |
| 20 electrode holder                             |   |
| 21 welding bench                                |   |
| 22 spot welding                                 |   |
| 23 spot welding electrode holder                |   |
| 24 electrode arm                                |   |



[material: steel, brass, aluminium (Am. aluminum), plastics, etc.; in the following, steel was chosen as an example]

- 1 angle iron (angle)
- 2 leg (flange)
- 3-7 steel girders
- 3 T-iron (tee-iron)
- 4 vertical leg
- 5 flange
- 6 H-girder (H-beam)
- 7 E-channel (channel iron)
- 8 round bar
- 9 square iron (Am. square stock)
- 10 flat bar
- 11 strip steel
- 12 iron wire
- 13-50 screws and bolts
- 13 hexagonal-head bolt
- 14 head
- 15 shank
- 16 thread
- 17 washer
- 18 hexagonal nut
- 19 split pin
- 20 rounded end
- 21 width of head (of flats)
- 22 stud
- 23 point (end)
- 24 castle nut (castellated nut)
- 25 hole for the split pin
- 26 cross-head screw, a sheet-metal screw (self-tapping screw)
- 27 hexagonal socket head screw
- 28 countersunk-head bolt
- 29 catch
- 30 locknut (locking nut)
- 31 bolt (pin)
- 32 collar-head bolt
- 33 set collar (integral collar)
- 34 spring washer (washer)
- 35 round nut, an adjusting nut
- 36 cheese-head screw, a slotted screw
- 37 tapered pin
- 38 screw slot (screw slit, screw groove)
- 39 square-head bolt
- 40 grooved pin, a cylindrical pin
- 41 T-head bolt
- 42 wing nut (fly nut, butterfly nut)
- 43 rag bolt
- 44 barb
- 45 wood screw
- 46 countersunk head
- 47 wood screw thread
- 48 grub screw
- 49 pin slot (pin slit, pin groove)
- 50 round end
- 51 nail (wire nail)
- 52 head
- 53 shank
- 54 point

- 55 roofing nail
- 56 riveting (lap riveting)
- 57-60 rivet
- 57 set head (swage head, die head), a rivet head
- 58 rivet shank
- 59 closing head
- 60 pitch of rivets
- 61 shaft
- 62 chamfer (bevel)
- 63 journal
- 64 neck
- 65 seat
- 66 keyway
- 67 conical seat (cone)
- 68 thread
- 69 ball bearing, an antifriction bearing
- 70 steel ball (ball)
- 71 outer race
- 72 inner race
- 73-74 keys
- 73 sunk key (feather)
- 74 gib (gib-headed key)
- 75-76 needle roller bearing
- 75 needle cage
- 76 needle
- 77 castle nut (castellated nut)
- 78 split pin
- 79 casing
- 80 casing cover
- 81 grease nipple (lubricating nipple)
- 82-96 gear wheels, cog wheels
- 82 stepped gear wheel
- 83 cog (tooth)
- 84 space between teeth
- 85 keyway (key seat, key slot)
- 86 bore
- 87 herringbone gear wheel
- 88 spokes (arms)
- 89 helical gearing (helical spur wheel)
- 90 sprocket
- 91 bevel gear wheel (bevel wheel)
- 92-93 spiral tothing
- 92 pinion
- 93 crown wheel
- 94 epicyclic gear (planetary gear)
- 95 internal tothing
- 96 external tothing
- 97-107 absorption dynamometer
- 97 shoe brake (check brake, block brake)
- 98 brake pulley
- 99 brake shaft (brake axle)
- 100 brake block (brake shoe)
- 101 pull rod
- 102 brake magnet
- 103 brake weight
- 104 band brake
- 105 brake band
- 106 brake lining
- 107 adjusting screw, for even application of the brake

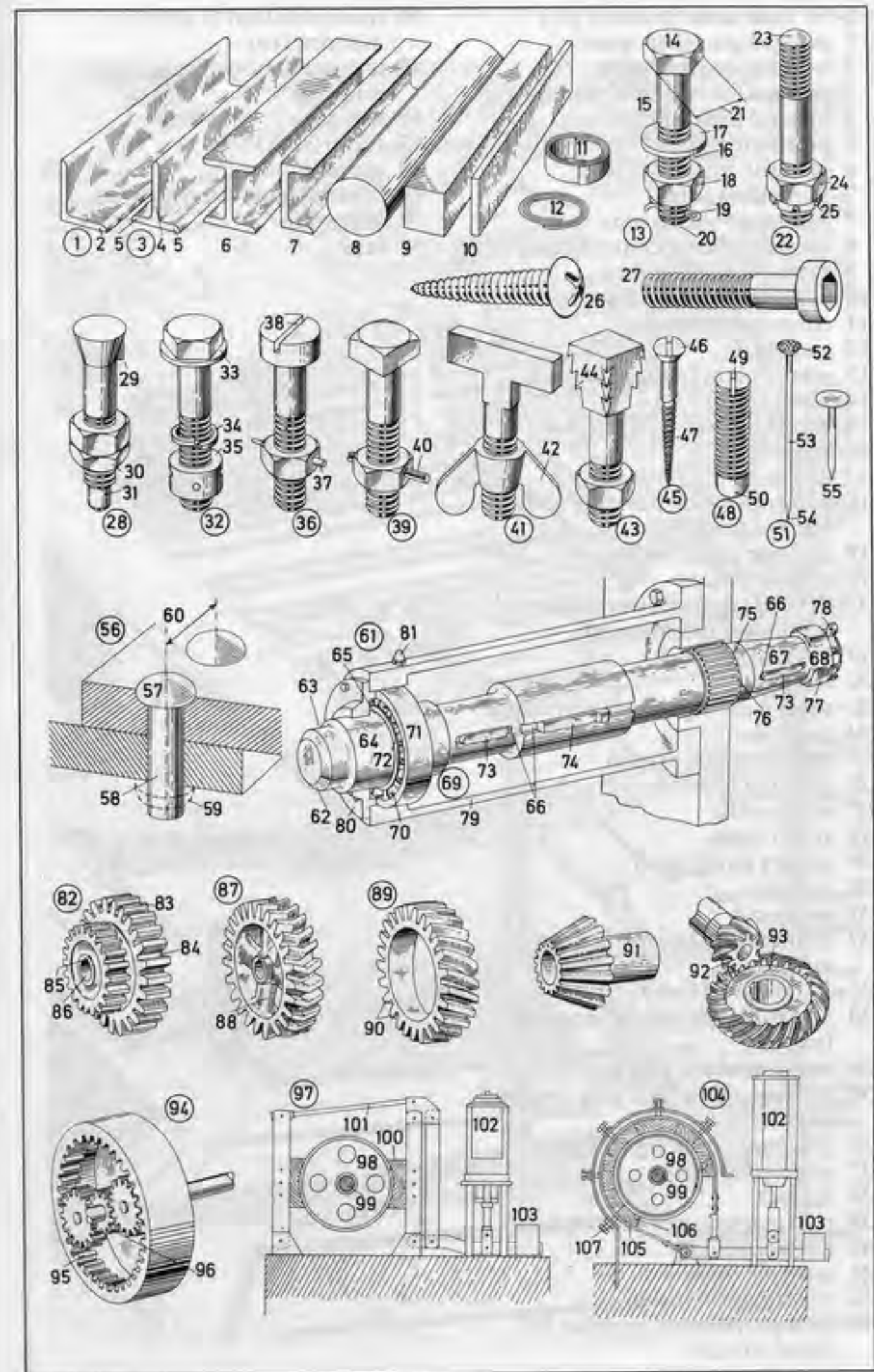



- 1-51 coal mine (colliery, pit)
- 1 pithead gear (headgear)
- 2 winding engine house
- 3 pithead frame (head frame)
- 4 pithead building
- 5 processing plant
- 6 sawmill
- 7-11 coking plant
- 7 battery of coke ovens
- 8 larry car (larry, charging car)
- 9 coking coal tower
- 10 coke-quenching tower
- 11 coke-quenching car
- 12 gasometer
- 13 power plant (power station)
- 14 water tower
- 15 cooling tower
- 16 mine fan
- 17 depot
- 18 administration building (office building, offices)
- 19 tip heap (spoil heap)
- 20 cleaning plant
- 21-51 underground workings (underground mining)
- 21 ventilation shaft
- 22 fan drift
- 23 cage-winding system with cages
- 24 main shaft
- 25 skip-winding system
- 26 winding inset
- 27 staple shaft
- 28 spiral chute
- 29 gallery along seam
- 30 lateral
- 31 cross-cut
- 32 tunnelling (*Am.* tunneling) machine
- 33-37 longwall faces
- 33 horizontal ploughed longwall face
- 34 horizontal cut longwall face
- 35 vertical pneumatic pick longwall face
- 36 diagonal ram longwall face
- 37 goaf (gob, waste)
- 38 air lock
- 39 transportation of men by cars
- 40 belt conveying
- 41 raw coal bunker
- 42 charging conveyor
- 43 transportation of supplies by monorail car
- 44 transportation of men by monorail car
- 45 transportation of supplies by mine car
- 46 drainage
- 47 sump (sink)
- 48 capping
- 49 [layer of] coal-bearing rock
- 50 coal seam
- 51 fault

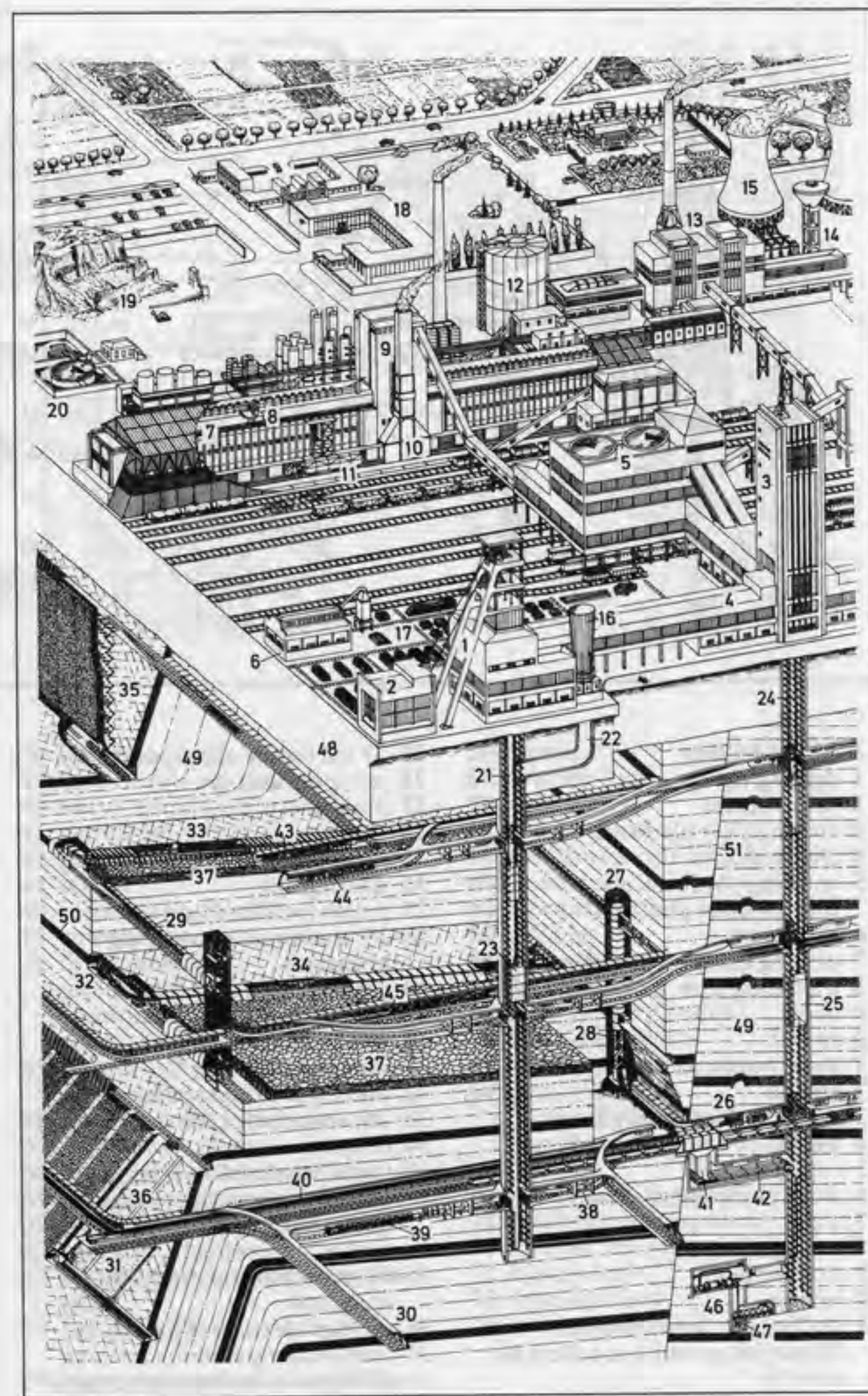

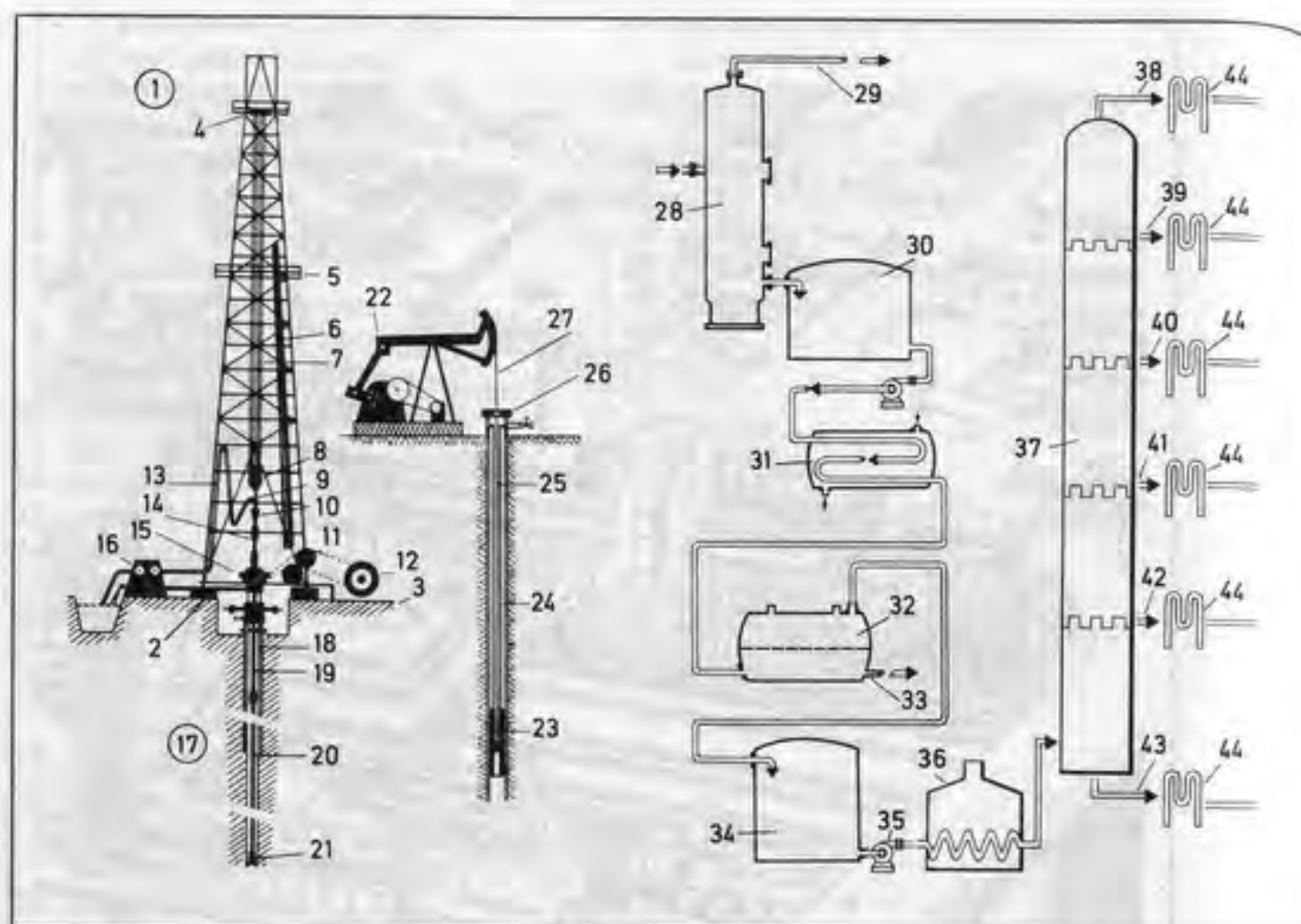

**1-21 oil drilling**

- 1 drilling rig
- 2 substructure
- 3 crown safety platform
- 4 crown blocks
- 5 working platform, an intermediate platform
- 6 drill pipes
- 7 drilling cable (drilling line)
- 8 travelling (*Am.* traveling) block
- 9 hook
- 10 swivel
- 11 draw works, a hoist
- 12 engine
- 13 standpipe and rotary hose
- 14 kelly
- 15 rotary table
- 16 slush pump (mud pump)
- 17 well
- 18 casing
- 19 drilling pipe
- 20 tubing
- 21 drilling bit; *kinds:* fishtail (blade) bit, rock (*Am.* roller) bit, core bit

**22-27 oil (crude oil) production**

- 22 pumping unit (pump)
- 23 plunger
- 24 tubing
- 25 sucker rods (pumping rods)
- 26 stuffing box
- 27 polish (polished) rod

**28-35 treatment of crude oil [diagram]**

- 28 gas separator
- 29 gas pipe (gas outlet)
- 30 wet oil tank (wash tank)
- 31 water heater
- 32 water and brine separator
- 33 salt water pipe (salt water outlet)
- 34 oil tank
- 35 trunk pipeline for oil [to the refinery or transport by tanker lorry (*Am.* tank truck), oil tanker, or pipeline]

**36-64 processing of crude oil [diagram]**

- 36 oil furnace (pipe still)
- 37 fractionating column (distillation column) with trays

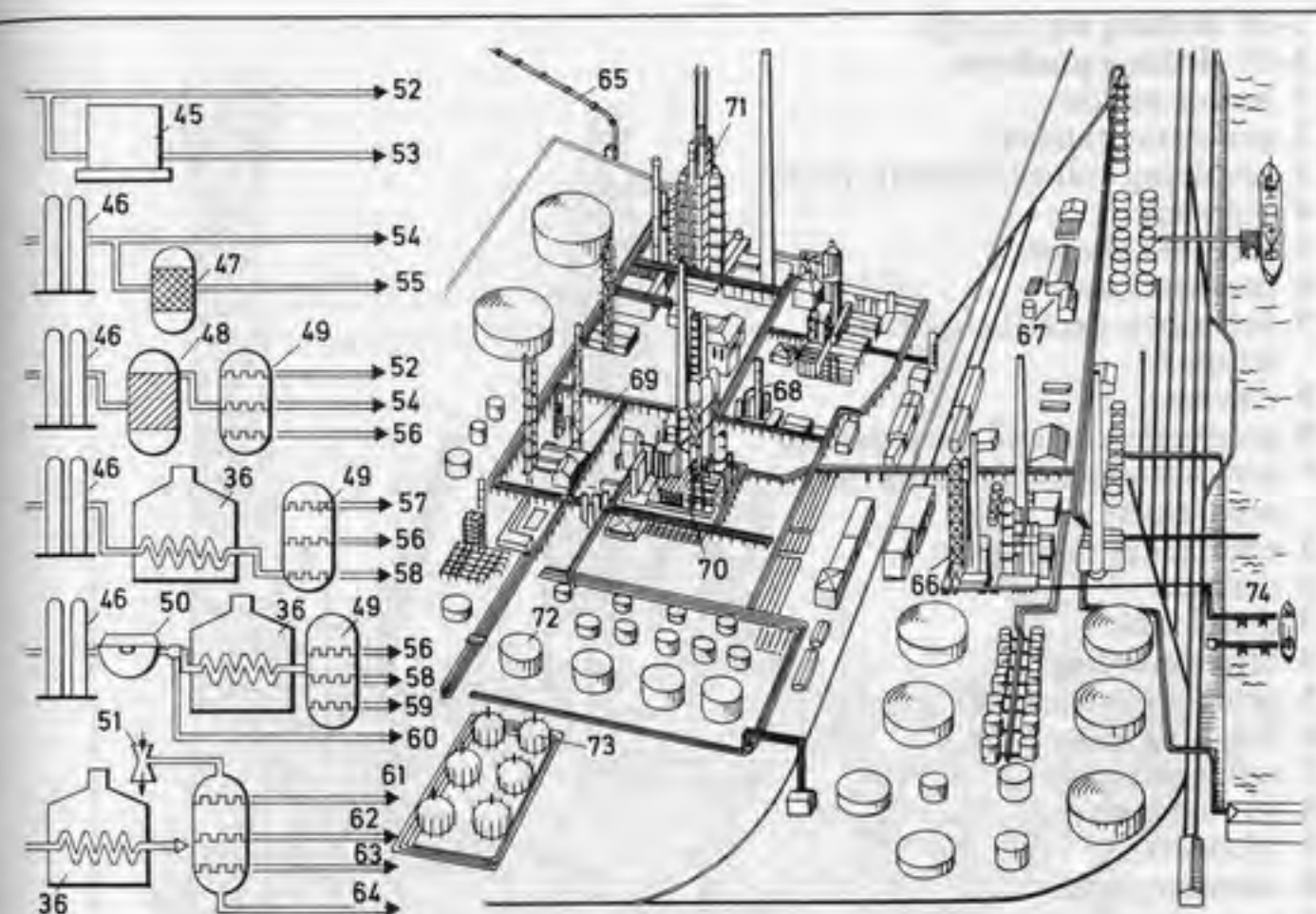

- 38 top gases (tops)
- 39 light distillation products
- 40 heavy distillation products
- 41 petroleum
- 42 gas oil component
- 43 residue
- 44 condenser (cooler)
- 45 compressor
- 46 desulphurizing (desulphurization, *Am.* desulfurizing, desulfurization) plant
- 47 reformer (hydroformer, platformer)
- 48 catalytic cracker (cat cracker)
- 49 distillation column
- 50 de-waxing (wax separation)
- 51 vacuum equipment
- 52-64 oil products
- 52 fuel gas
- 53 liquefied petroleum gas (liquid gas)
- 54 regular grade petrol (*Am.* gasoline)
- 55 super grade petrol (*Am.* gasoline)

- 56 diesel oil
- 57 aviation fuel
- 58 light fuel oil
- 59 heavy fuel oil
- 60 paraffin (paraffin oil, kerosene)
- 61 spindle oil
- 62 lubricating oil
- 63 cylinder oil
- 64 bitumen
- 65-74 oil refinery
- 65 pipeline (oil pipeline)
- 66 distillation plants
- 67 lubricating oil refinery
- 68 desulphurizing (desulphurization, *Am.* desulfurizing, desulfurization) plant
- 69 gas-separating plant
- 70 catalytic cracking plant
- 71 catalytic reformer
- 72 storage tank
- 73 spherical tank
- 74 tanker terminal



- 1-39 drilling rig (oil rig)  
 1-37 drilling platform
- 1 power station
  - 2 generator exhausts
  - 3 revolving crane (pedestal crane)
  - 4 piperack
  - 5 turbine exhausts
  - 6 materials store
  - 7 helicopter deck (heliport deck, heliport)
  - 8 elevator
  - 9 production oil and gas separator
  - 10 test oil and gas separators (test separators)
  - 11 emergency flare stack
  - 12 derrick
  - 13 diesel tank
  - 14 office building
  - 15 cement storage tanks
  - 16 drinking water tank
  - 17 salt water tank
  - 18 jet fuel tanks
  - 19 lifeboats
  - 20 elevator shaft
  - 21 compressed-air reservoir
  - 22 pumping station
  - 23 air compressor
  - 24 air lock
  - 25 seawater desalination plant
  - 26 inlet filters for diesel fuel
  - 27 gas cooler
  - 28 control panel for the separators
  - 29 toilets (lavatories)
  - 30 workshop
  - 31 pig trap [the 'pig' is used to clean the oil pipeline]
  - 32 control room
  - 33 accommodation modules (accommodation)
  - 34 high-pressure cementing pumps
  - 35 lower deck
  - 36 middle deck
  - 37 top deck (main deck)
  - 38 substructure
  - 39 mean sea level

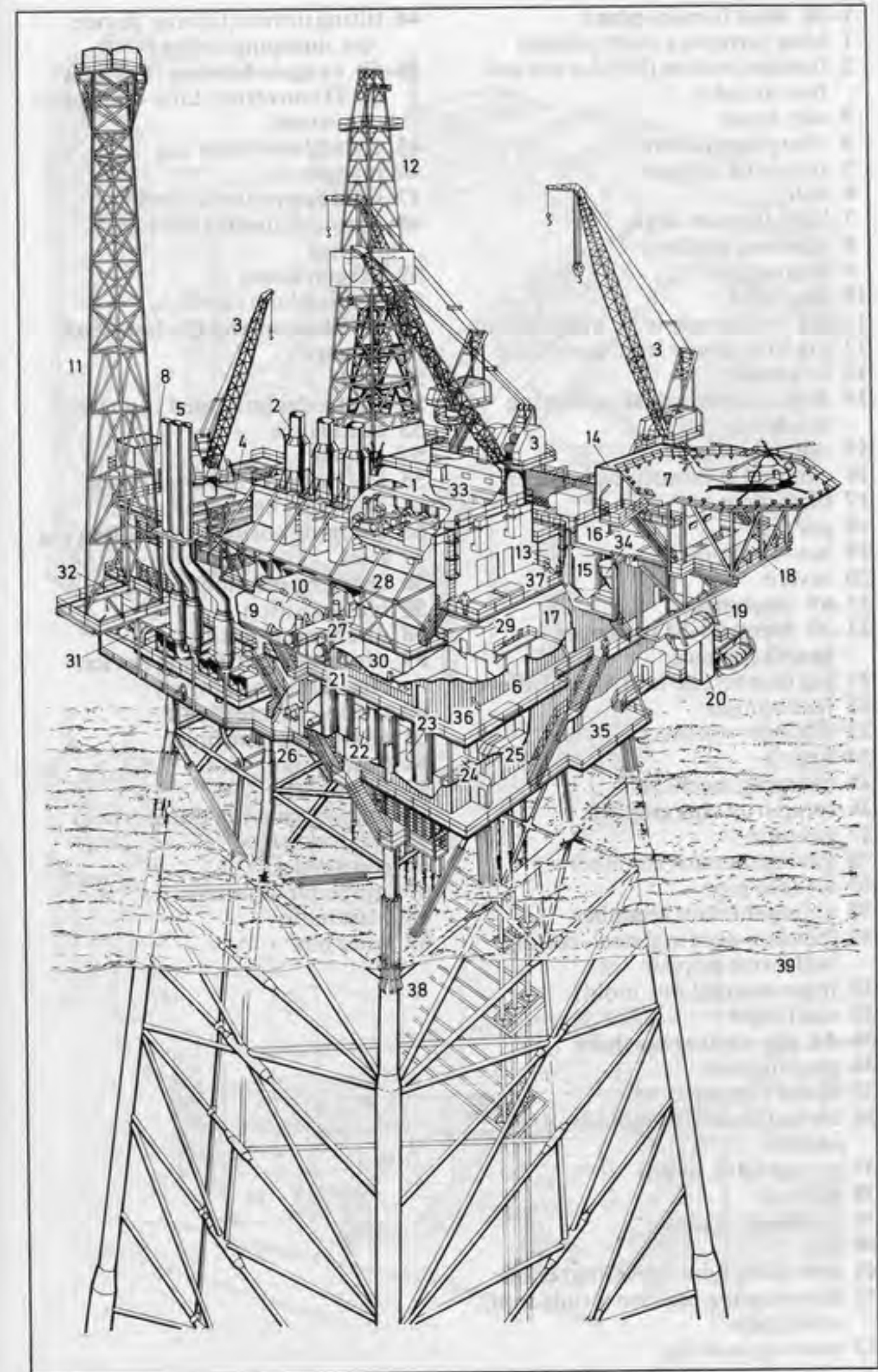



- 1-20 blast furnace plant**
- 1 blast furnace, a shaft furnace
  - 2 furnace incline (lift) for ore and flux or coke
  - 3 skip hoist
  - 4 charging platform
  - 5 receiving hopper
  - 6 bell
  - 7 blast furnace shaft
  - 8 smelting section
  - 9 slag escape
  - 10 slag ladle
  - 11 pig iron (crude iron, iron) runout
  - 12 pig iron (crude iron, iron) ladle
  - 13 downtake
  - 14 dust catcher, a dust-collecting machine
  - 15 hot-blast stove
  - 16 external combustion chamber
  - 17 blast main
  - 18 gas pipe
  - 19 hot-blast pipe
  - 20 tuyère
- 21-69 steelworks**
- 21-30 Siemens-Martin open-hearth furnace**
- 21 pig iron (crude iron, iron) ladle
  - 22 feed runner
  - 23 stationary furnace
  - 24 hearth
  - 25 charging machine
  - 26 scrap iron charging box
  - 27 gas pipe
  - 28 gas regenerator chamber
  - 29 air feed pipe
  - 30 air regenerator chamber
  - 31 [bottom-pouring] steel-casting ladle with stopper
  - 32 ingot mould (*Am.* mold)
  - 33 steel ingot
- 34-44 pig-casting machine**
- 34 pouring end
  - 35 metal runner
  - 36 series (strand) of moulds (*Am.* molds)
  - 37 mould (*Am.* mold)
  - 38 catwalk
  - 39 discharging chute
  - 40 pig
  - 41 travelling (*Am.* traveling) crane
  - 42 top-pouring pig iron (crude iron, iron) ladle
  - 43 pouring ladle lip
- 44 tilting device (tipping device, *Am.* dumping device)**
- 45-50 oxygen-blowing converter (L-D converter, Linz-Donawitz converter)**
- 45 conical converter top
  - 46 mantle
  - 47 solid converter bottom
  - 48 fireproof lining (refractory lining)
  - 49 oxygen lance
  - 50 tapping hole (tap hole)
- 51-54 Siemens electric low-shaft furnace**
- 51 feed
  - 52 electrodes [arranged in a circle]
  - 53 bustle pipe
  - 54 runout
- 55-69 Thomas converter (basic Bessemer converter)**
- 55 charging position for molten pig iron
  - 56 charging position for lime
  - 57 blow position
  - 58 discharging position
  - 59 tilting device (tipping device, *Am.* dumping device)
  - 60 crane-operated ladle
  - 61 auxiliary crane hoist
  - 62 lime bunker
  - 63 downpipe
  - 64 tipping car (*Am.* dump truck)
  - 65 scrap iron feed
  - 66 control desk
  - 67 converter chimney
  - 68 blast main
  - 69 wind box

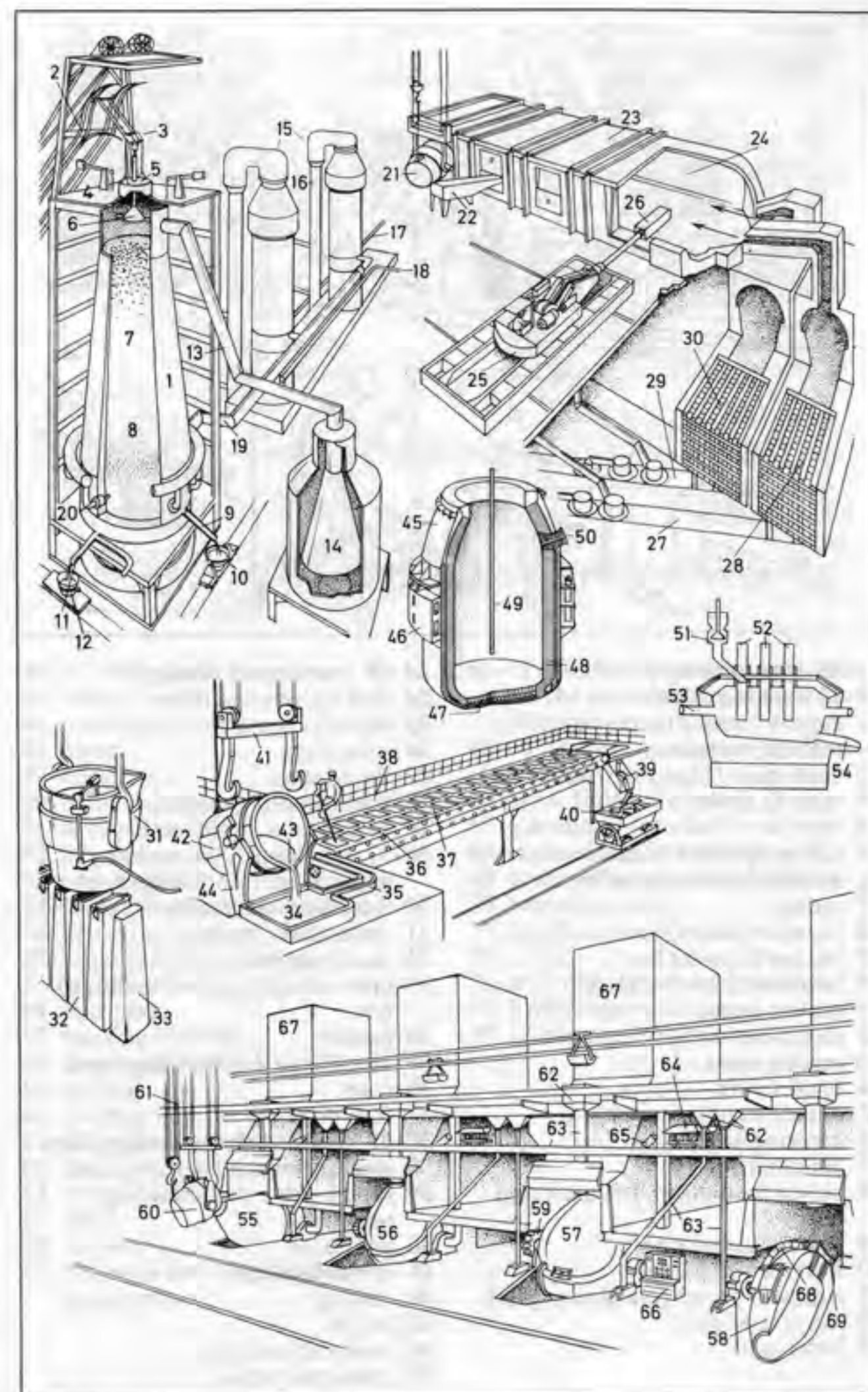



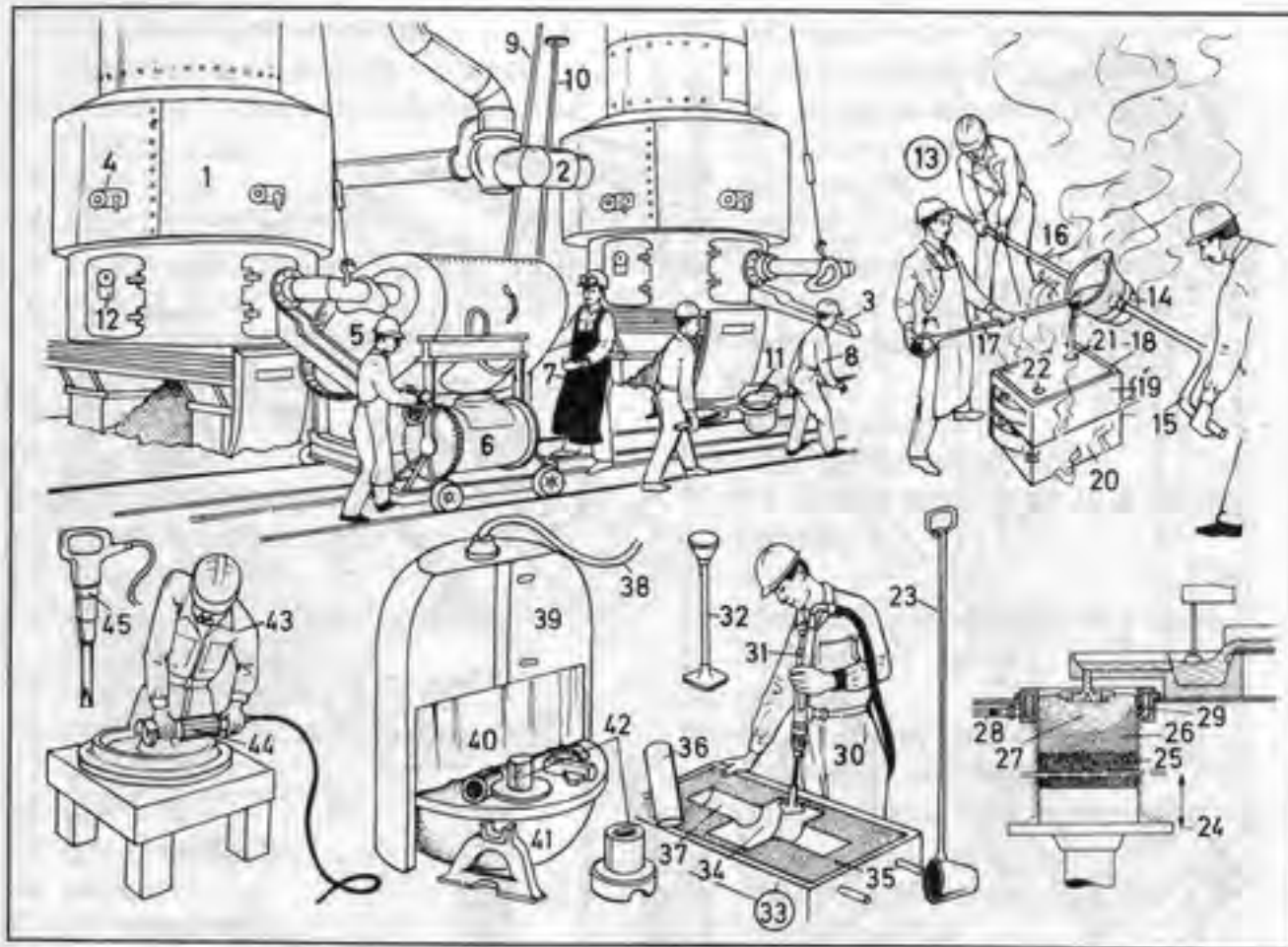

**1-45 iron foundry**

**1-12 melting plant**

- 1 cupola furnace (cupola), a melting furnace
- 2 blast main (blast inlet, blast pipe)
- 3 tapping spout
- 4 spyhole
- 5 tilting-type hot-metal receiver
- 6 mobile drum-type ladle
- 7 melter
- 8 founder (caster)
- 9 tap bar (tapping bar)
- 10 bott stick (*Am.* bot stick)
- 11 molten iron
- 12 slag spout
- 13 casting team
- 14 hand shank
- 15 double handle (crutch)
- 16 carrying bar
- 17 skimmer rod
- 18 closed moulding (*Am.* molding) box
- 19 upper frame (cope)
- 20 lower frame (drag)
- 21 runner (runner gate, down-gate)
- 22 riser (riser gate)
- 23 hand ladle

**24-29 continuous casting**

- 24 sinking pouring floor
- 25 solidifying pig
- 26 solid stage
- 27 liquid stage
- 28 water-cooling system
- 29 mould (*Am.* mold) wall
- 30-37 **moulding** (*Am.* molding) department (*moulding shop*)
- 30 moulder (*Am.* molder)
- 31 pneumatic rammer
- 32 hand rammer
- 33 open moulding (*Am.* molding) box
- 34 pattern
- 35 moulding (*Am.* molding) sand
- 36 core
- 37 core print
- 38-45 **cleaning shop** (*fettling shop*)
- 38 steel grit or sand delivery pipe
- 39 rotary-table shot-blasting machine
- 40 grit guard
- 41 revolving table
- 42 casting
- 43 fettler
- 44 pneumatic grinder
- 45 pneumatic chisel

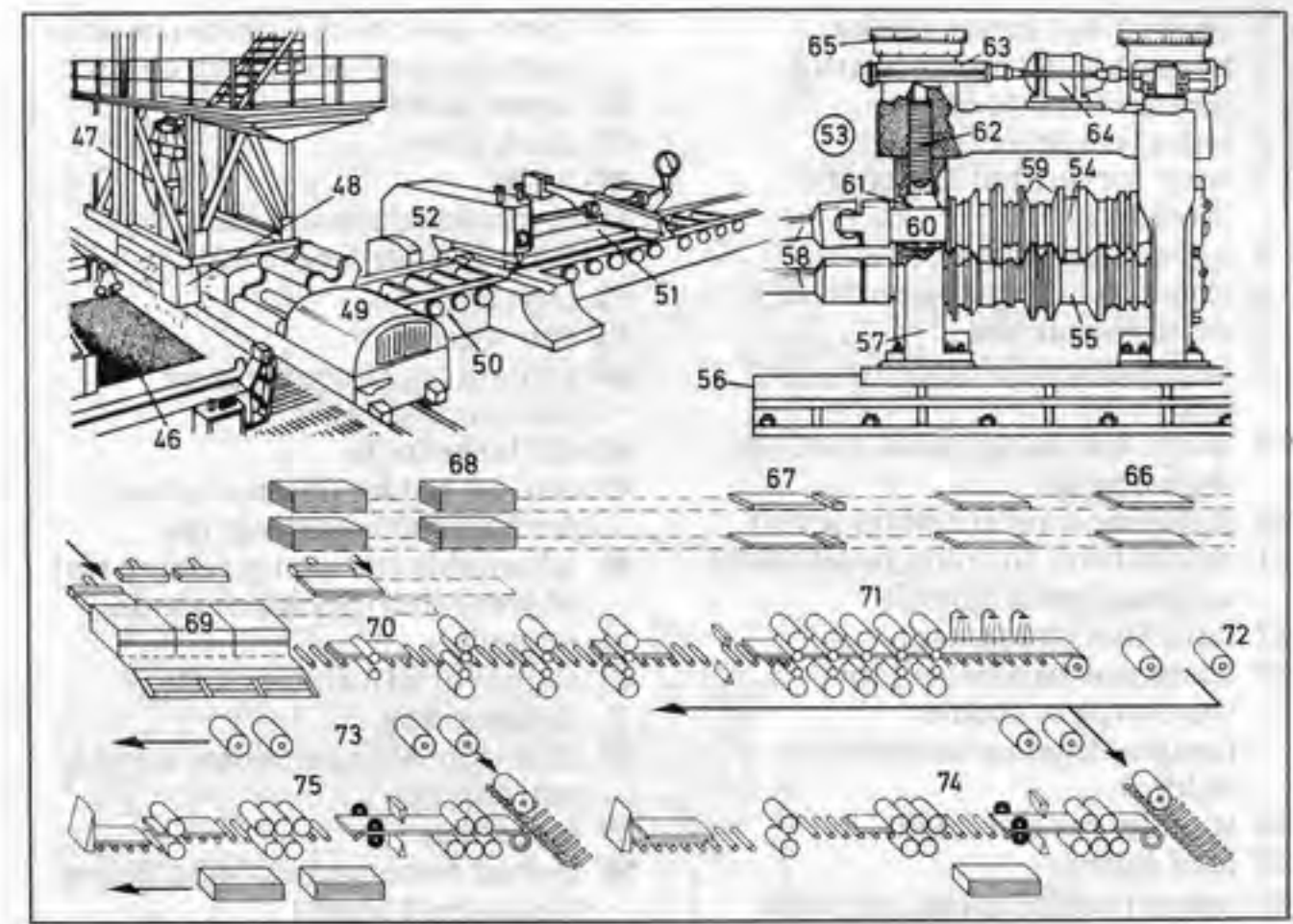

**46-75 rolling mill**

- 46 soaking pit
- 47 soaking pit crane
- 48 ingot
- 49 ingot tipper
- 50 blooming train (roller path)
- 51 workpiece
- 52 bloom shears
- 53 two-high mill
- 54-55 **set of rolls** (set of rollers)
- 54 upper roll (upper roller)
- 55 lower roll (lower roller)
- 56-60 **roll stand**
- 56 base plate
- 57 housing (frame)
- 58 coupling spindle
- 59 groove
- 60 roll bearing
- 61-65 **adjusting equipment**
- 61 chock
- 62 main screw
- 63 gear
- 64 motor
- 65 indicator for rough and fine adjustment

**66-75 continuous rolling mill train for the manufacture of strip [diagram]**

- 66-68 processing of semi-finished product
- 66 semi-finished product
- 67 gas cutting installation
- 68 stack of finished steel sheets
- 69 continuous reheating furnaces
- 70 blooming train
- 71 finishing train
- 72 coiler
- 73 collar bearing for marketing
- 74 5 mm shearing train
- 75 10 mm shearing train



- 1 centre (*Am.* center) lathe
- 2 headstock with gear control (geared headstock)
- 3 reduction drive lever
- 4 lever for normal and coarse threads
- 5 speed change lever
- 6 leadscrew reverse-gear lever
- 7 change-gear box
- 8 feed gearbox (Norton tumbler gear)
- 9 levers for changing the feed and thread pitch
- 10 feed gear lever (tumbler lever)
- 11 switch lever for right or left hand action of main spindle
- 12 lathe foot (footpiece)
- 13 leadscrew handwheel for traversing of saddle (longitudinal movement of saddle)
- 14 tumbler reverse lever
- 15 feed screw
- 16 apron (saddle apron, carriage apron)
- 17 lever for longitudinal and transverse motion
- 18 drop (dropping) worm (feed trip, feed tripping device) for engaging feed mechanisms
- 19 lever for engaging half nut of leadscrew (lever for clasp nut engagement)
- 20 lathe spindle
- 21 tool post
- 22 top slide (tool slide, tool rest)
- 23 cross slide
- 24 bed slide
- 25 coolant supply pipe
- 26 tailstock centre (*Am.* center)
- 27 barrel (tailstock barrel)
- 28 tailstock barrel clamp lever
- 29 tailstock
- 30 tailstock barrel adjusting handwheel
- 31 lathe bed
- 32 leadscrew
- 33 feed shaft
- 34 reverse shaft for right and left hand motion and engaging and disengaging
- 35 four-jaw chuck (four-jaw independent chuck)
- 36 gripping jaw

- 37 three-jaw chuck (three-jaw self-centring, self-centering, chuck)
- 38 turret lathe
- 39 cross slide
- 40 turret
- 41 combination toolholder (multiple turning head)
- 42 top slide
- 43 star wheel
- 44 coolant tray for collecting coolant and swarf
- 45-53 lathe tools
- 45 tool bit holder (clamp tip tool) for adjustable cutting tips
- 46 adjustable cutting tip (clamp tip) of cemented carbide or oxide ceramic
- 47 shapes of adjustable oxide ceramic tips
- 48 lathe tool with cemented carbide cutting edge
- 49 tool shank
- 50 brazed cemented carbide cutting tip (cutting edge)
- 51 internal facing tool (boring tool) for corner work
- 52 general-purpose lathe tool
- 53 parting (parting-off) tool
- 54 lathe carrier
- 55 driving (driver) plate
- 56-72 measuring instruments
- 56 plug gauge (*Am.* gage)
- 57 'GO' gauging (*Am.* gaging) member (end)
- 58 'NOT GO' gauging (*Am.* gaging) member (end)
- 59 calliper (caliper, snap) gauge (*Am.* gage)
- 60 'GO' side
- 61 'NOT GO' side
- 62 micrometer
- 63 measuring scale
- 64 graduated thimble
- 65 frame
- 66 spindle (screwed spindle)
- 67 vernier calliper (caliper) gauge (*Am.* gage)
- 68 depth gauge (*Am.* gage) attachment rule
- 69 vernier scale
- 70 outside jaws
- 71 inside jaws
- 72 vernier depth gauge (*Am.* gage)

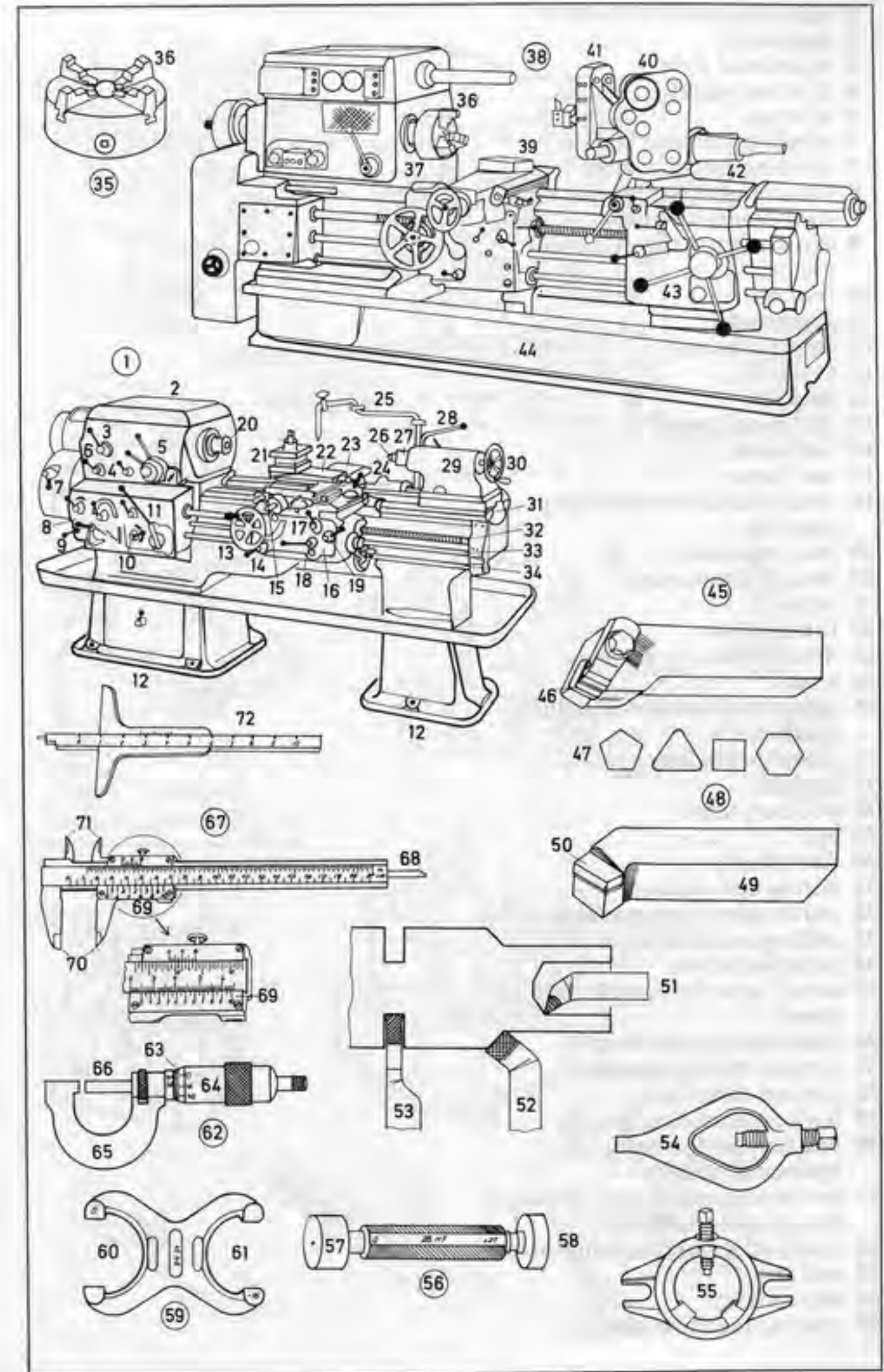



- 1 universal grinding machine
- 2 headstock
- 3 wheelhead slide
- 4 grinding wheel
- 5 tailstock
- 6 grinding machine bed
- 7 grinding machine table
- 8 two-column planing machine (two-column planer)
- 9 drive motor, a direct current motor
- 10 column
- 11 planer table
- 12 cross slide (rail)
- 13 tool box
- 14 hacksaw
- 15 clamping device
- 16 saw blade
- 17 saw frame
- 18 radial (radial-arm) drilling machine
- 19 bed (base plate)
- 20 block for workpiece
- 21 pillar
- 22 lifting motor
- 23 drill spindle
- 24 arm
- 25 horizontal boring and milling machine
- 26 movable headstock
- 27 spindle
- 28 auxiliary table
- 29 bed
- 30 fixed steady
- 31 boring mill column
- 32 universal milling machine
- 33 milling machine table
- 34 table feed drive
- 35 switch lever for spindle rotation speed
- 36 control box (control unit)
- 37 vertical milling spindle
- 38 vertical drive head
- 39 horizontal milling spindle
- 40 end support for steadying horizontal spindle
- 41 machining centre (*Am. center*), a rotary-table machine
- 42 rotary (circular) indexing table
- 43 end mill
- 44 machine tap
- 45 shaping machine (shaper)

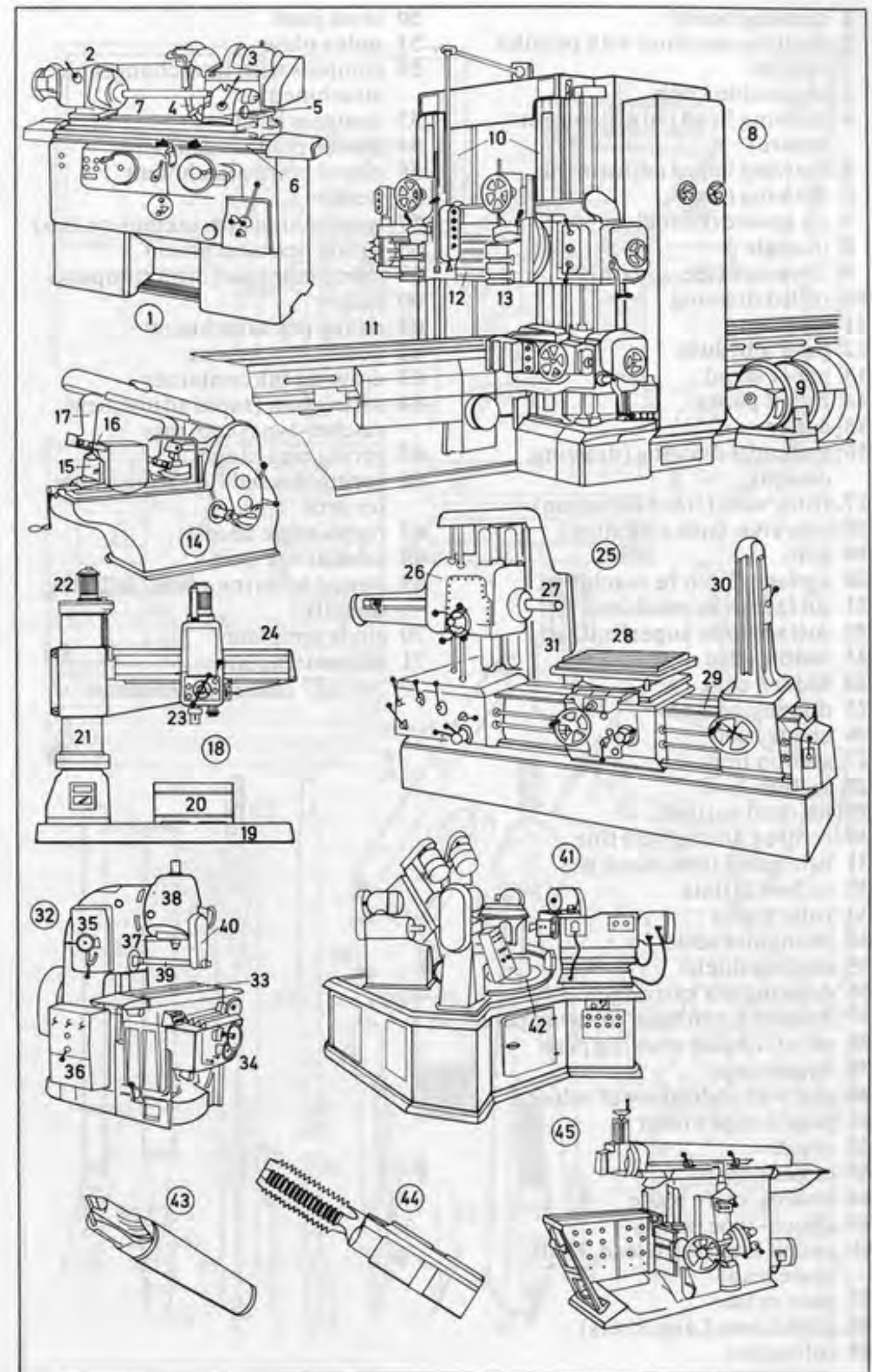



- |  |  |
|--|--|
| 1 drawing board                                  | 50 cross joint   |
| 2 drafting machine with parallel motion          | 51 index plate   |
| 3 adjustable knob                                | 52 compass with interchangeable attachments            |
| 4 drawing head (adjustable set square)           | 53 compass head  |
| 5 drawing board adjustment                       | 54 needle point attachment                             |
| 6 drawing table                                  | 55 pencil point attachment                             |
| 7 set square (triangle)                          | 56 needle  |
| 8 triangle                                       | 57 lengthening arm (extension bar)                     |
| 9 T-square (tee-square)                          | 58 ruling pen attachment                               |
| 10 rolled drawing                                | 59 pump compass (drop compass)                         |
| 11 diagram                                       | 60 piston  |
| 12 time schedule                                 | 61 ruling pen attachment                               |
| 13 paper stand                                   | 62 pencil attachment                                   |
| 14 roll of paper                                 | 63 drawing ink container                               |
| 15 cutter  | 64 spring bow (rapid adjustment, ratchet-type) compass |
| 16 technical drawing (drawing, design)           | 65 spring ring hinge                                   |
| 17 front view (front elevation)                  | 66 spring-loaded fine adjustment for arcs              |
| 18 side view (side elevation)                    | 67 right-angle needle                                  |
| 19 plan  | 68 tubular ink unit                                    |
| 20 surface not to be machined                    | 69 stencil lettering guide (lettering stencil)         |
| 21 surface to be machined                        | 70 circle template                                     |
| 22 surface to be superfinished                   | 71 ellipse template                                    |
| 23 visible edge                                  |  |
| 24 hidden edge                                   |  |
| 25 dimension line                                |  |
| 26 arrow head                                    |  |
| 27 section line                                  |  |
| 28 section A-B                                   |  |
| 29 hatched surface                               |  |
| 30 centre ( <i>Am.</i> center) line              |  |
| 31 title panel (title block)                     |  |
| 32 technical data                                |  |
| 33 ruler (rule)                                  |  |
| 34 triangular scale                              |  |
| 35 erasing shield                                |  |
| 36 drawing ink cartridge                         |  |
| 37 holders for tubular drawing pens              |  |
| 38 set of tubular drawing pens                   |  |
| 39 hygrometer                                    |  |
| 40 cap with indication of nib size               |  |
| 41 pencil-type eraser                            |  |
| 42 eraser  |  |
| 43 erasing knife                                 |  |
| 44 erasing knife blade                           |  |
| 45 clutch-type pencil                            |  |
| 46 pencil lead (refill lead, refill, spare lead) |  |
| 47 glass eraser                                  |  |
| 48 glass fibres ( <i>Am.</i> fibers)             |  |
| 49 ruling pen                                    |  |

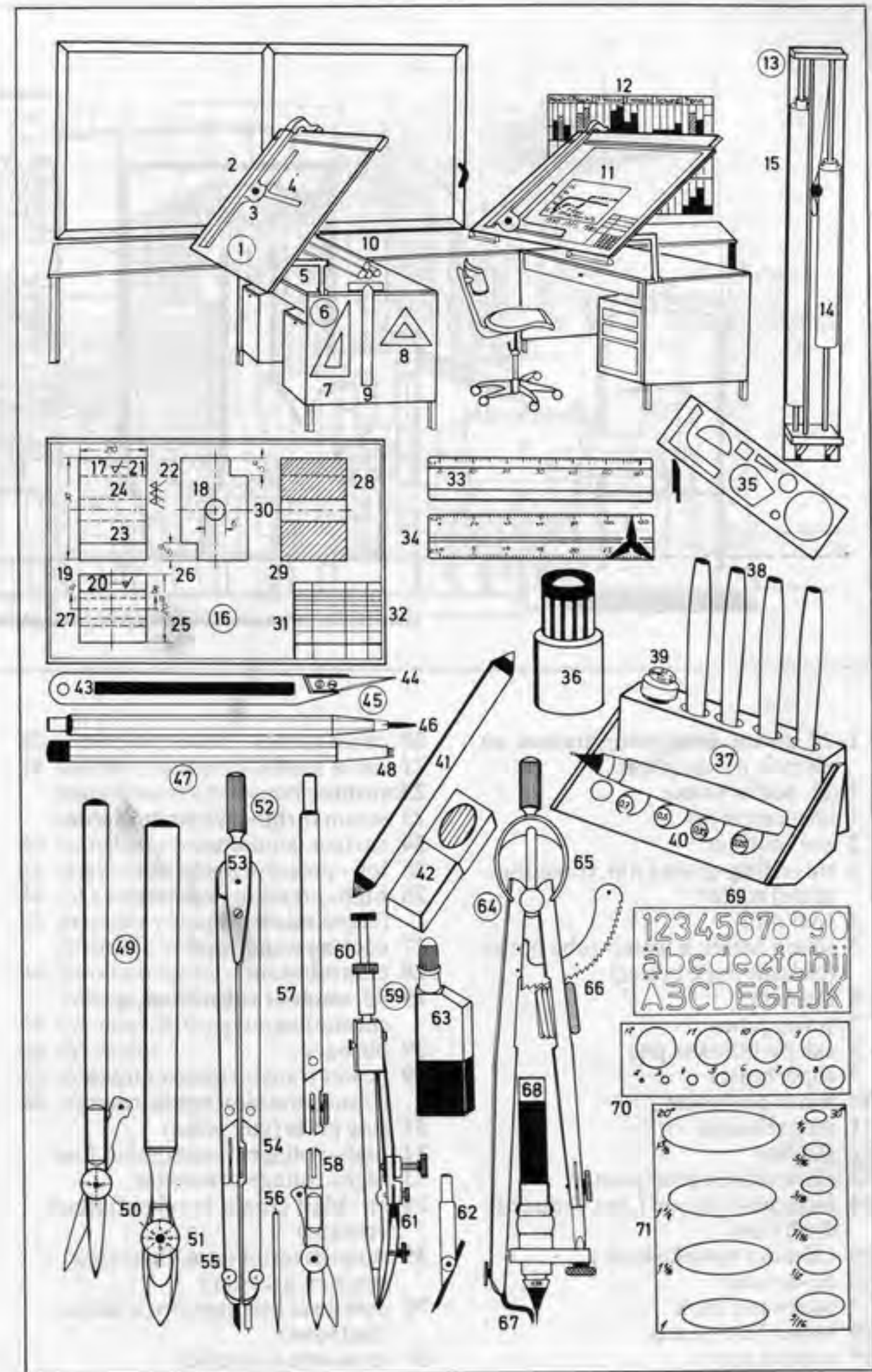



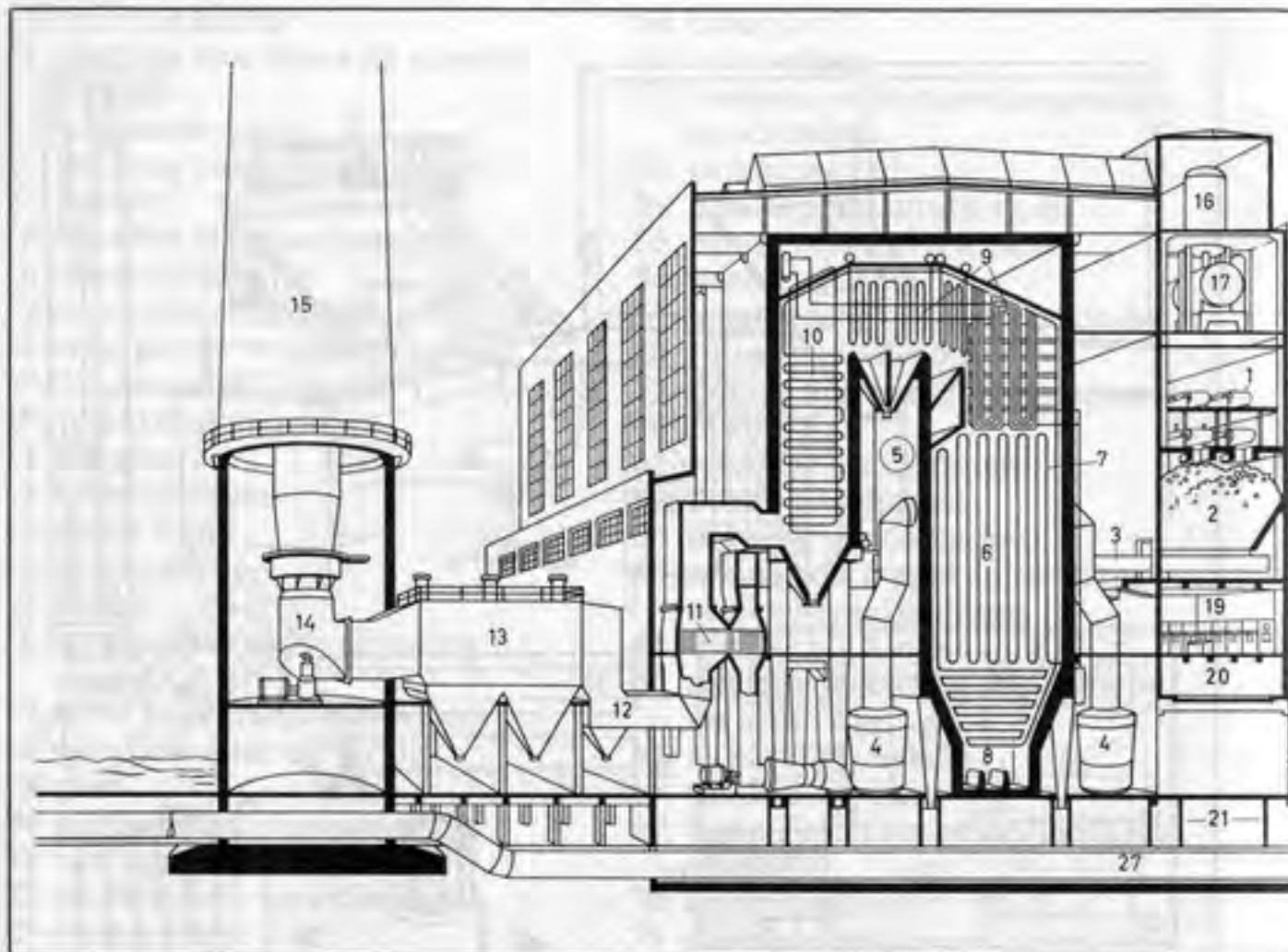

**1-28 steam-generating station, an electric power plant**

**1-21 boiler house**

1 coal conveyor

2 coal bunker

3 travelling-grate (*Am.* traveling-grate) stoker

4 coal mill

5 steam boiler, a water-tube boiler (radiant-type boiler)

6 burners

7 water pipes

8 ash pit (clinker pit)

9 superheater

10 water preheater

11 air preheater

12 gas flue

13 electrostatic precipitator

14 induced-draught (*Am.* induced-draft) fan

15 chimney (smokestack)

16 de-aerator

17 feedwater tank

18 boiler feed pump

19 control room

20 cable tunnel

21 cable vault

22 turbine house

23 steam turbine with alternator

24 surface condenser

25 low-pressure preheater

26 high-pressure preheater (economizer)

27 cooling water pipe

28 control room

**29-35 outdoor substation, a substation**

29 busbars

30 power transformer, a mobile (transportable) transformer

31 stay poles (guy poles)

32 high-voltage transmission line

33 high-voltage conductor

34 air-blast circuit breaker (circuit breaker)

35 surge diverter (*Am.* lightning arrester, arrester)

36 overhead line support, a lattice steel tower

37 cross arm (traverse)

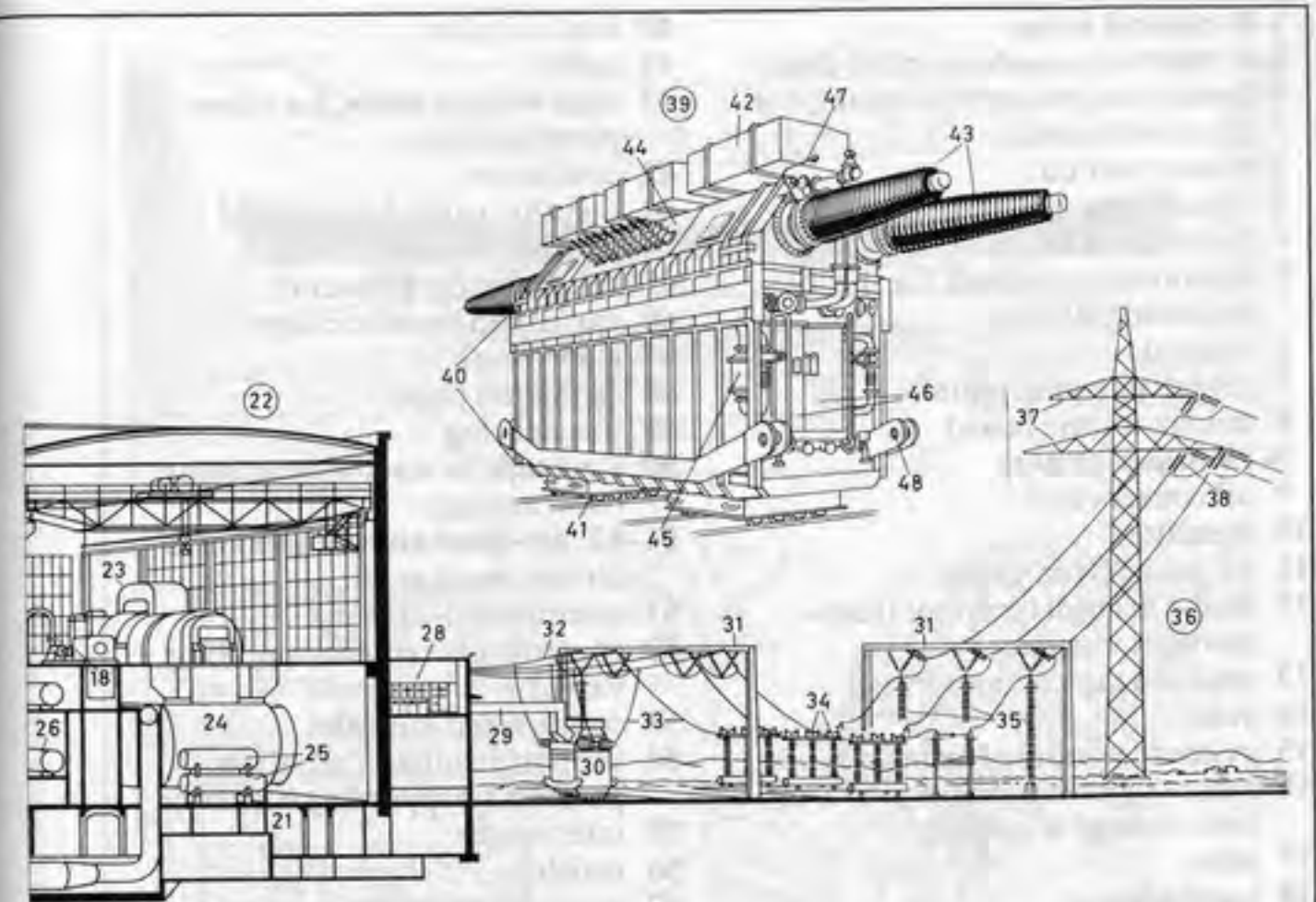

38 strain insulator

**39 mobile (transportable) transformer (power transformer, transformer)**

40 transformer tank

41 bogie (*Am.* truck)

42 oil conservator

43 primary voltage terminal (primary voltage bushing)

44 low-voltage terminals (low-voltage bushings)

45 oil-circulating pump

46 oil cooler

47 arcing horn

48 transport lug



- 1-8 control room
- 1-6 control console (control desk)
- 1 control board (control panel) for the alternators
- 2 master switch
- 3 signal light
- 4 feeder panel
- 5 monitoring controls for the switching systems
- 6 controls
- 7 revertive signal panel
- 8 matrix mimic board
- 9-18 transformer
- 9 oil conservator
- 10 breather
- 11 oil gauge (Am. gage)
- 12 feed-through terminal (feed-through insulator)
- 13 on-load tap changer
- 14 yoke
- 15 primary winding (primary)
- 16 secondary winding (secondary, low-voltage winding)
- 17 core
- 18 tap (tapping)
- 19 transformer connection
- 20 star connection (star network, Y-connection)
- 21 delta connection (mesh connection)
- 22 neutral point
- 23-30 steam turbine, a turbogenerator unit
- 23 high-pressure cylinder
- 24 medium-pressure cylinder
- 25 low-pressure cylinder
- 26 three-phase generator (generator)
- 27 hydrogen cooler
- 28 leakage steam path
- 29 jet nozzle
- 30 turbine monitoring panel with measuring instruments
- 31 automatic voltage regulator
- 32 synchro
- 33 cable box
- 34 conductor
- 35 feed-through terminal (feed-through insulator)
- 36 core
- 37 casing
- 38 filling compound (filler)
- 39 lead sheath

- 40 lead-in tube
- 41 cable
- 42 high voltage cable, for three-phase current
- 43 conductor
- 44 metallic paper (metallized paper)
- 45 tracer (tracer element)
- 46 varnished-cambric tape
- 47 lead sheath
- 48 asphalted paper
- 49 jute serving
- 50 steel tape or steel wire armour (Am. armor)
- 51-62 air-blast circuit breaker, a circuit breaker
- 51 compressed-air tank
- 52 control valve (main operating valve)
- 53 compressed-air inlet
- 54 support insulator, a hollow porcelain supporting insulator
- 55 interrupter
- 56 resistor
- 57 auxiliary contacts
- 58 current transformer
- 59 voltage transformer (potential transformer)
- 60 operating mechanism housing
- 61 arcing horn
- 62 spark gap

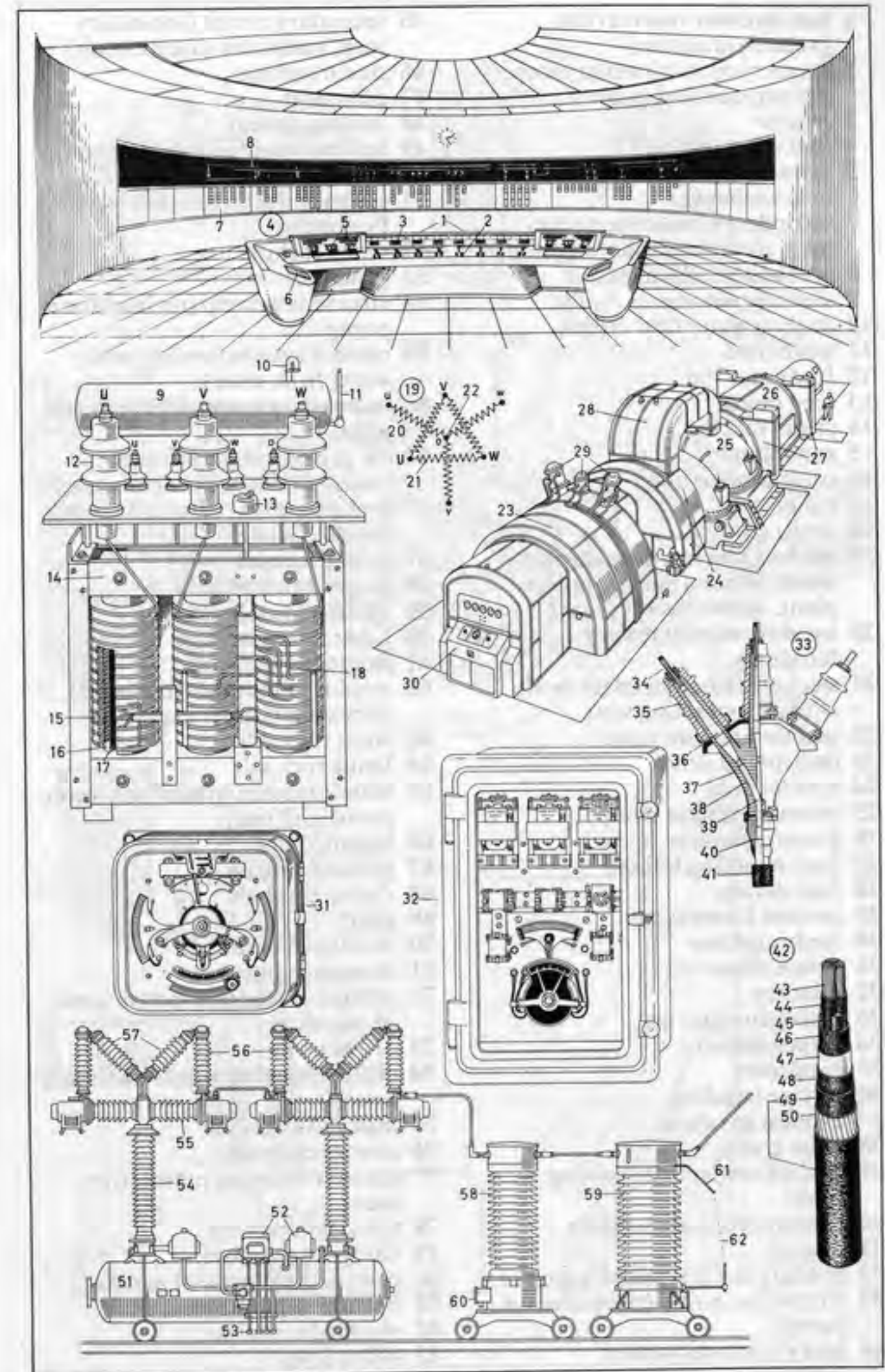



- 1 fast-breeder reactor (fast breeder) [diagram]
- 2 primary circuit (primary loop, primary sodium system)
- 3 reactor
- 4 fuel rods (fuel pins)
- 5 primary sodium pump
- 6 heat exchanger
- 7 secondary circuit (secondary loop, secondary sodium system)
- 8 secondary sodium pump
- 9 steam generator
- 10 cooling water flow circuit
- 11 steam line
- 12 feedwater line
- 13 feed pump
- 14 steam turbine
- 15 generator
- 16 transmission line
- 17 condenser
- 18 cooling water
- 19 nuclear reactor, a pressurized-water reactor (nuclear power plant, atomic power plant)
- 20 concrete shield (reactor building)
- 21 steel containment (steel shell) with air extraction vent
- 22 reactor pressure vessel
- 23 control rod drive
- 24 control rods
- 25 primary coolant pump
- 26 steam generator
- 27 fuel-handling hoists
- 28 fuel storage
- 29 coolant flow passage
- 30 feedwater line
- 31 prime steam line
- 32 manway
- 33 turbogenerator set
- 34 turbogenerator
- 35 condenser
- 36 service building
- 37 exhaust gas stack
- 38 polar crane
- 39 cooling tower, a dry cooling tower
- 40 pressurized-water system
- 41 reactor
- 42 primary circuit (primary loop)
- 43 circulation pump (recirculation pump)
- 44 heat exchanger (steam generator)

- 45 secondary circuit (secondary loop, feedwater steam circuit)
- 46 steam turbine
- 47 generator
- 48 cooling system
- 49 boiling water system [diagram]
- 50 reactor
- 51 steam and recirculation water flow paths
- 52 steam turbine
- 53 generator
- 54 circulation pump (recirculation pump)
- 55 coolant system (cooling with water from river)
- 56 radioactive waste storage in salt mine
- 57-68 geological structure of abandoned salt mine converted for disposal of radioactive waste (nuclear waste)
- 57 Lower Keuper
- 58 Upper Muschelkalk
- 59 Middle Muschelkalk
- 60 Lower Muschelkalk
- 61 Bunter downthrow
- 62 residue of leached (lixiviated) Zechstein (Upper Permian)
- 63 Aller rock salt
- 64 Leine rock salt
- 65 Stassfurt seam (potash salt seam, potash salt bed)
- 66 Stassfurt salt
- 67 grenzanhydrite
- 68 Zechstein shale
- 69 shaft
- 70 minehead buildings
- 71 storage chamber
- 72 storage of medium-active waste in salt mine
- 73 511 m level
- 74 protective screen (anti-radiation screen)
- 75 lead glass window
- 76 storage chamber
- 77 drum containing radioactive waste
- 78 television camera
- 79 charging chamber
- 80 control desk (control panel)
- 81 upward ventilator
- 82 shielded container
- 83 490 m level

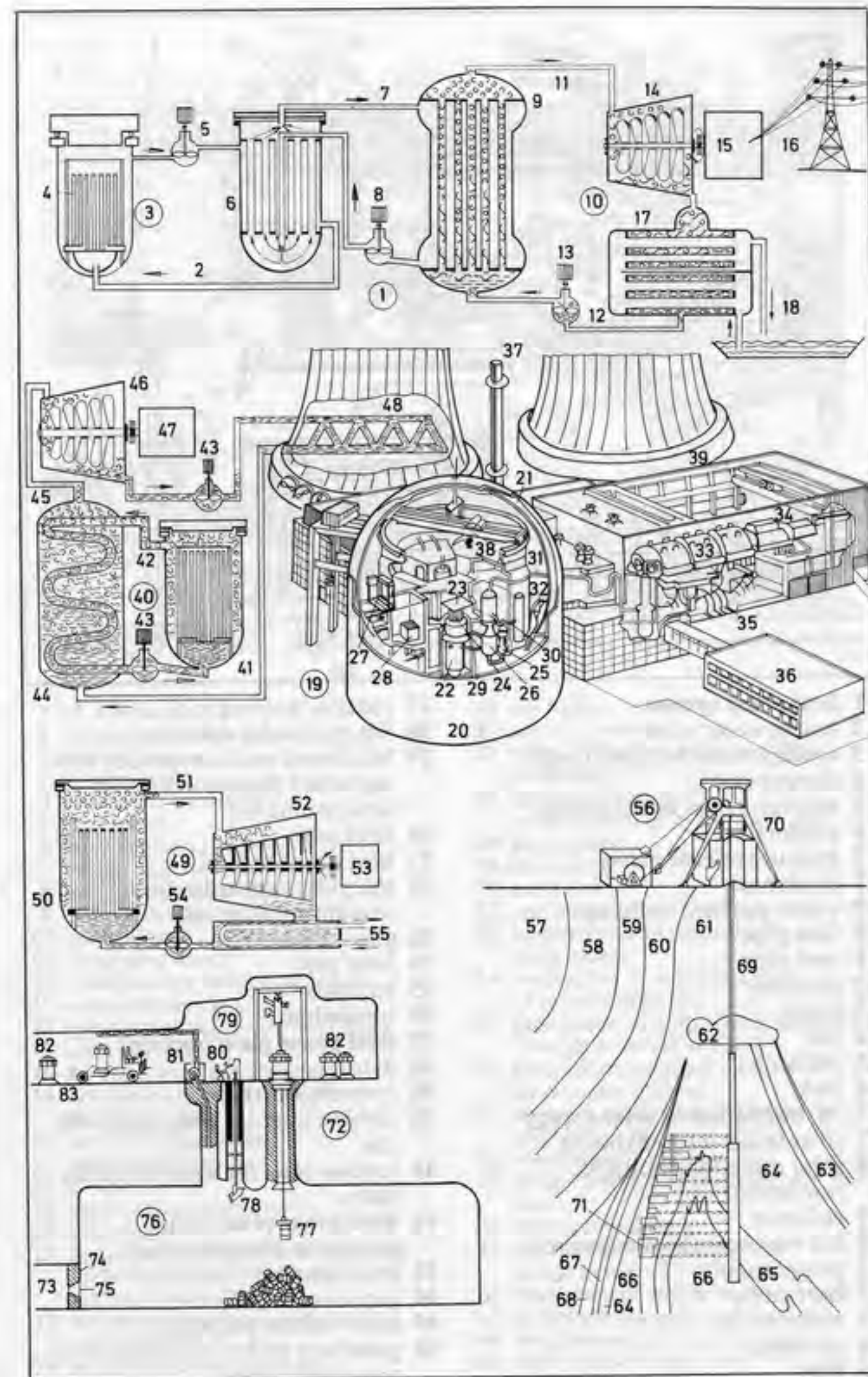



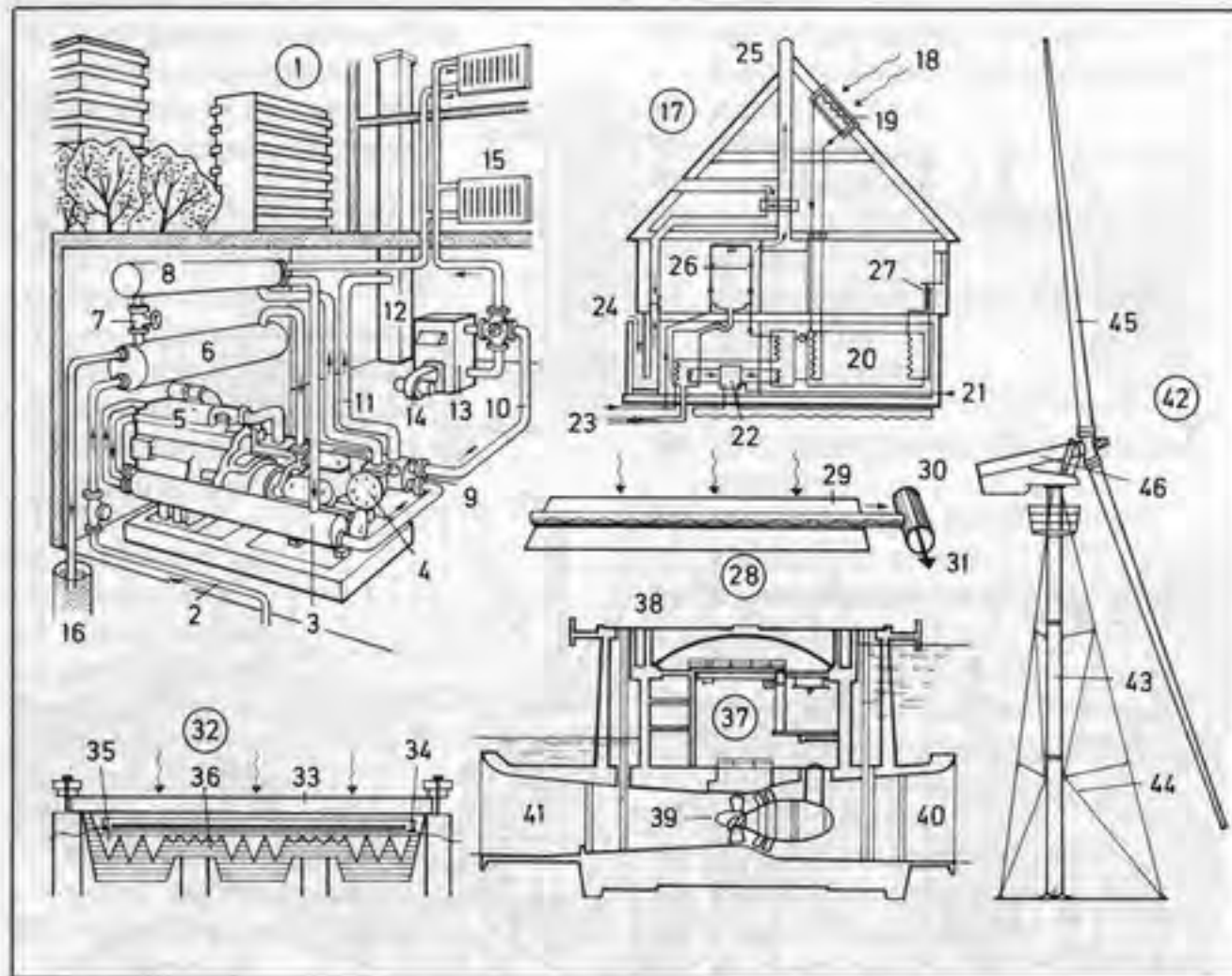

- |   |  |
|---|--|
| 1 heat pump system                        | 27 radiator heating  |
| 2 source water inlet                      | 28 flat plate solar collector  |
| 3 cooling water heat exchanger            | 29 blackened receiver surface with asphalted aluminium (Am. aluminum) foil |
| 4 compressor                              | 30 steel tube  |
| 5 natural-gas or diesel engine            | 31 heat transfer fluid   |
| 6 evaporator                              | 32 flat plate solar collector, containing solar cell                       |
| 7 pressure release valve                  | 33 glass cover   |
| 8 condenser                               | 34 solar cell  |
| 9 waste-gas heat exchanger                | 35 air ducts   |
| 10 flow pipe                              | 36 insulation  |
| 11 vent pipe                              | 37 tidal power plant [section]   |
| 12 chimney                                | 38 dam   |
| 13 boiler                                 | 39 reversible turbine  |
| 14 fan                                    | 40 turbine inlet for water from the sea                                    |
| 15 radiator                               | 41 turbine inlet for water from the basin                                  |
| 16 sink                                   | 42 wind power plant (wind generator, aerogenerator)                        |
| 17-36 utilization of solar energy         | 43 truss tower   |
| 17 solar (solar-heated) house             | 44 guy wire  |
| 18 solar radiation (sunlight, insolation) | 45 rotor blades (propeller)  |
| 19 collector                              | 46 generator with variable pitch for power regulation                      |
| 20 hot reservoir (heat reservoir)         |  |
| 21 power supply                           |  |
| 22 heat pump                              |  |
| 23 water outlet                           |  |
| 24 air supply                             |  |
| 25 flue                                   |  |
| 26 hot water supply                       |  |

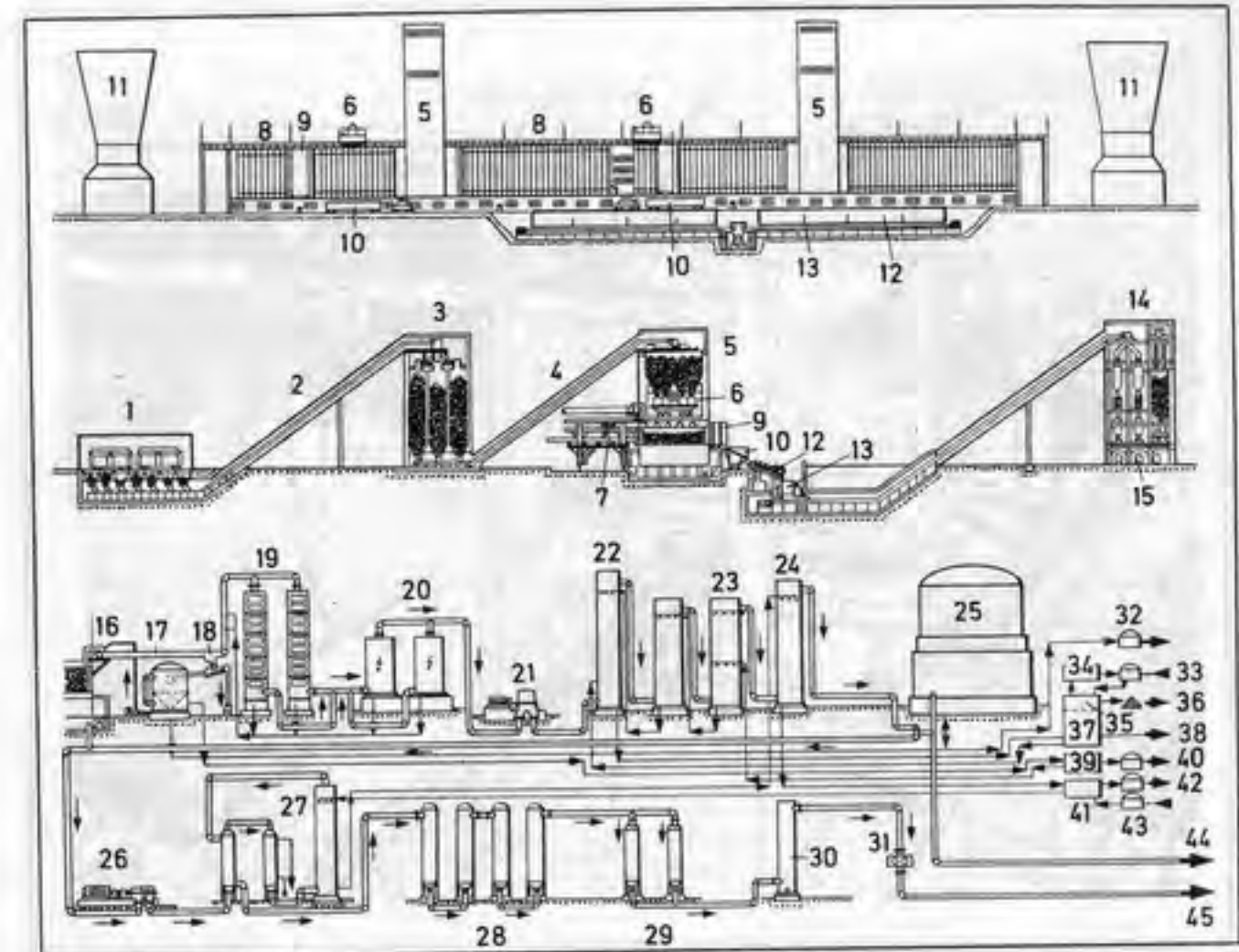

- |  |   |
|--|---|
| 1-15 coking plant  | 25 gas holder   |
| 1 dumping of coking coal   | 26 gas compressor   |
| 2 belt conveyor  | 27 debenzoling by cooler and heat exchanger               |
| 3 service bunker   | 28 desulphurization (Am. desulfurization) of pressure gas |
| 4 coal tower conveyor  | 29 gas cooling  |
| 5 coal tower   | 30 gas drying   |
| 6 larry car (larry, charging car)  | 31 gas meter  |
| 7 pusher ram   | 32 crude tar tank   |
| 8 battery of coke ovens  | 33 sulphuric acid (Am. sulfuric acid) supply              |
| 9 coke guide   | 34 production of sulphuric acid (Am. sulfuric acid)       |
| 10 quenching car, with engine  | 35 production of ammonium sulphate (Am. ammonium sulfate) |
| 11 quenching tower   | 36 ammonium sulphate (Am. ammonium sulfate)               |
| 12 coke loading bay (coke wharf)   | 37 recovery plant for recovering the scrubbing agents     |
| 13 coke side bench   | 38 waste water discharge                                  |
| 14 screening of lump coal and culm   | 39 phenol extraction from the gas water                   |
| 15 coke loading  | 40 crude phenol tank                                      |
| 16-45 coke-oven gas processing   | 41 production of crude benzol (crude benzene)             |
| 16 discharge (release) of gas from the coke ovens                                      | 42 crude benzol (crude benzene) tank                      |
| 17 gas-collecting main   | 43 scrubbing oil tank                                     |
| 18 coal tar extraction   | 44 low-pressure gas main                                  |
| 19 gas cooler  | 45 high-pressure gas main                                 |
| 20 electrostatic precipitator  |   |
| 21 gas extractor   |   |
| 22 hydrogen sulphide (Am. hydrogen sulfide) scrubber (hydrogen sulphide wet collector) |   |
| 23 ammonia scrubber (ammonia wet collector)  |   |
| 24 benzene (benzol) scrubber   |   |







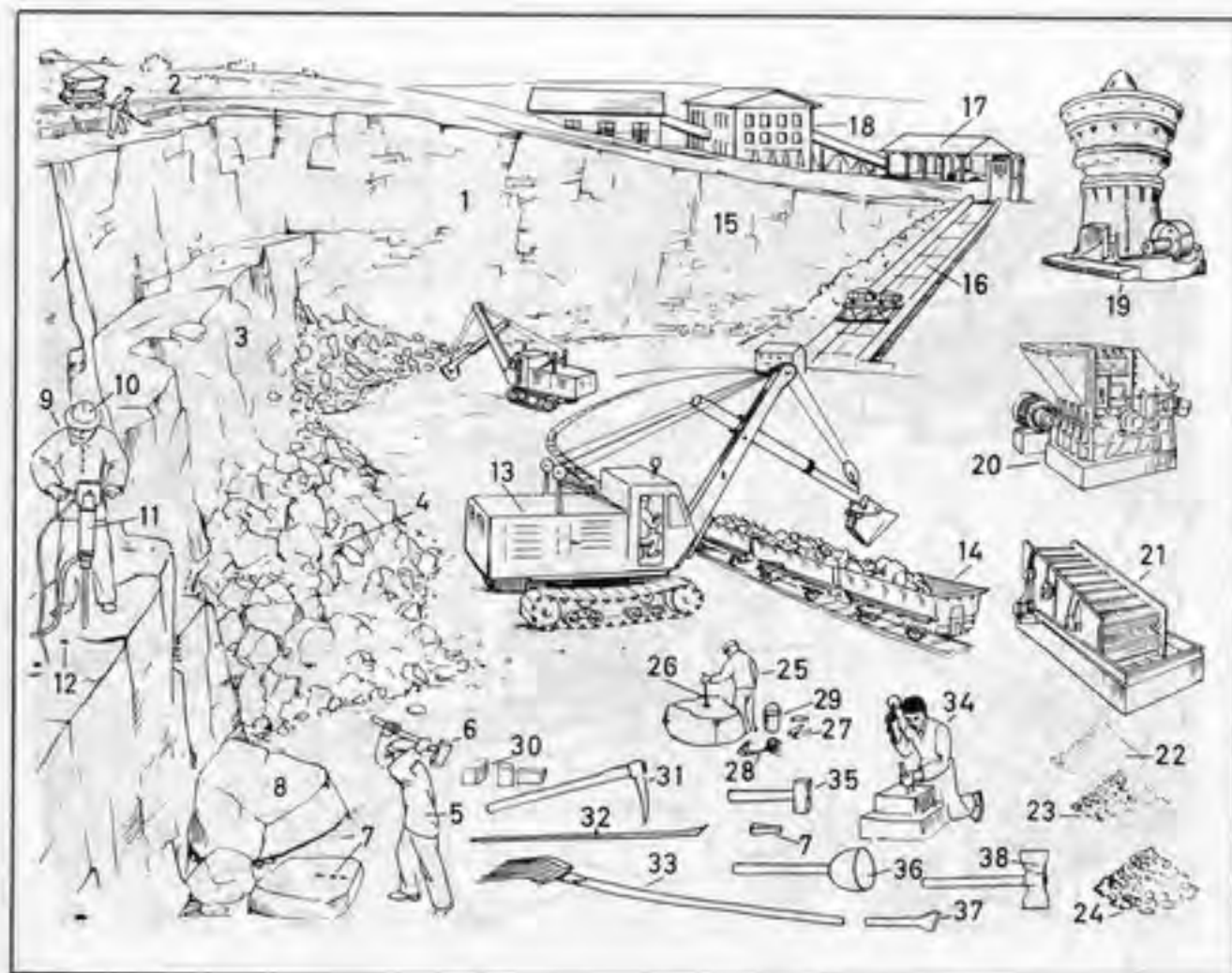

- |   |  |
|---|--|
| 1 quarry, an open-cast working  | 21 vibrating screen                            |
| 2 overburden  | 22 screenings (fine dust)                      |
| 3 working face  | 23 stone chippings                             |
| 4 loose rock pile (blasted rock)  | 24 crushed stone                               |
| 5 quarryman (quarrier), a quarry worker   | 25 shot firer                                  |
| 6 sledge hammer   | 26 measuring rod                               |
| 7 wedge   | 27 blasting cartridge                          |
| 8 block of stone  | 28 fuse (blasting fuse)                        |
| 9 driller   | 29 plugging sand (stemming sand) bucket        |
| 10 safety helmet  | 30 dressed stone                               |
| 11 hammer drill (hard-rock drill)   | 31 pick  |
| 12 borehole   | 32 crowbar (pinch bar)                         |
| 13 universal excavator  | 33 fork  |
| 14 large-capacity truck   | 34 stonemason                                  |
| 15 rock face  | 35-38 stonemason's tools                       |
| 16 inclined hoist   | 35 stonemason's hammer                         |
| 17 primary crusher  | 36 mallet                                      |
| 18 stone-crushing plant   | 37 drove chisel (drove, boaster, broad chisel) |
| 19 coarse rotary (gyratory) crusher; <i>sim.</i> : fine rotary (gyratory) crusher | 38 dressing axe ( <i>Am.</i> ax)               |
| 20 hammer crusher (impact crusher)  |  |

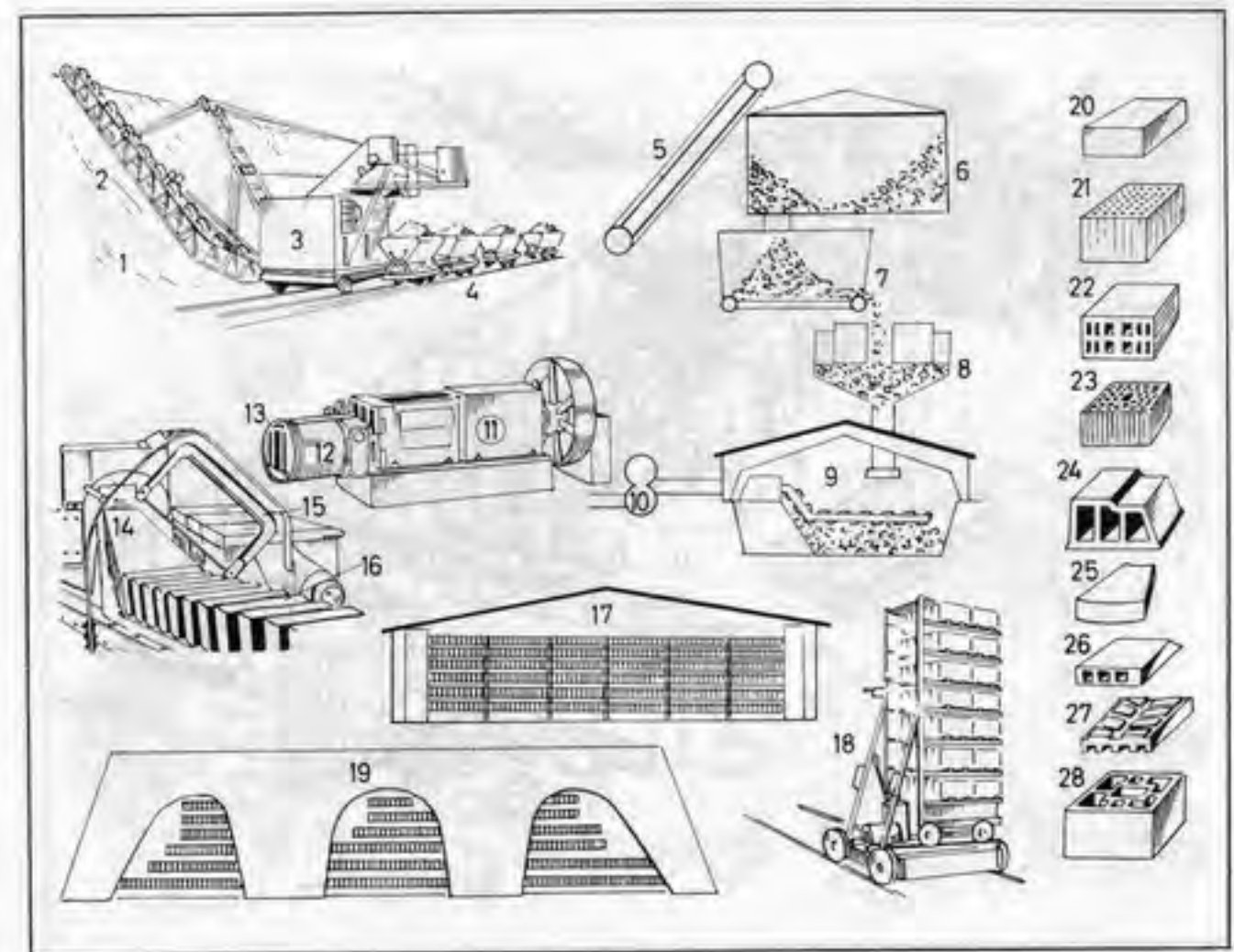

- |  |  |
|--|--|
| 1 clay pit   | 20 solid brick (building brick)                    |
| 2 loam, an impure clay (raw clay)                      | 21-22 perforated bricks and hollow blocks          |
| 3 overburden excavator, a large-scale excavator        | 21 perforated brick with vertical perforations     |
| 4 narrow-gauge ( <i>Am.</i> narrow-gauge) track system | 22 hollow clay block with horizontal perforations  |
| 5 inclined hoist                                       | 23 hollow clay block with vertical perforations    |
| 6 souring chambers                                     | 24 floor brick                                     |
| 7 box feeder (feeder)                                  | 25 compass brick (radial brick, radiating brick)   |
| 8 edge runner mill (edge mill, pan grinding mill)      | 26 hollow flooring block                           |
| 9 rolling plant  | 27 paving brick                                    |
| 10 double-shaft trough mixer (mixer)                   | 28 cellular brick [for fireplaces] (chimney brick) |
| 11 extrusion press (brick-pressing machine)            |  |
| 12 vacuum chamber                                      |  |
| 13 die   |  |
| 14 clay column   |  |
| 15 cutter (brick cutter)                               |  |
| 16 unfired brick (green brick)                         |  |
| 17 drying shed   |  |
| 18 mechanical finger car (stacker truck)               |  |
| 19 circular kiln (brick kiln)                          |  |



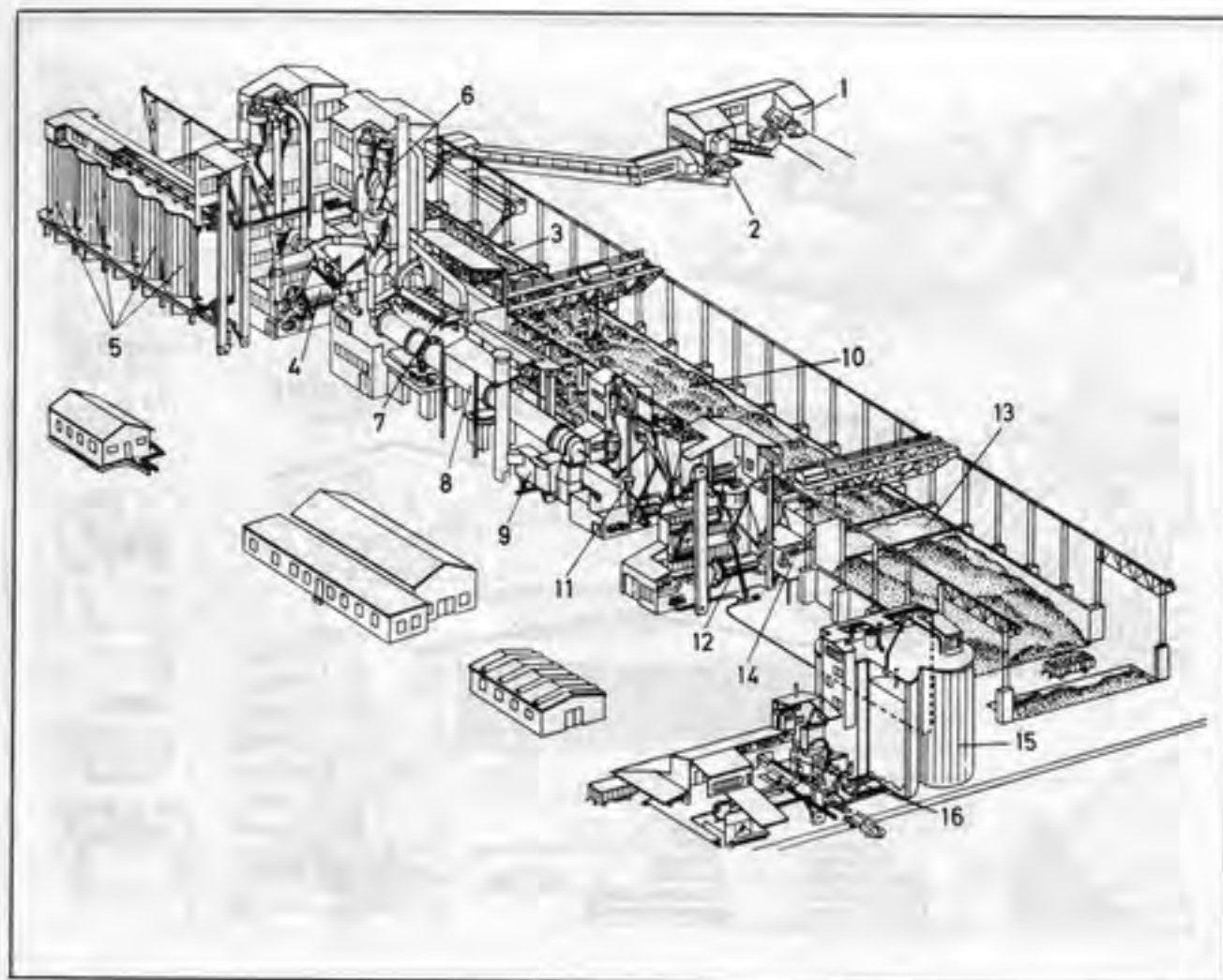

- 1 raw materials (limestone, clay, and marl)
- 2 hammer crusher (hammer mill)
- 3 raw material store
- 4 raw mill for simultaneously grinding and drying the raw materials with exhaust gas from the heat exchanger
- 5 raw meal silos
- 6 heat exchanger (cyclone heat exchanger)
- 7 dust collector (an electrostatic precipitator) for the heat exchanger exhaust from the raw mill
- 8 rotary kiln
- 9 clinker cooler
- 10 clinker store
- 11 primary air blower
- 12 cement-grinding mill
- 13 gypsum store
- 14 gypsum crusher
- 15 cement silo
- 16 cement-packing plant

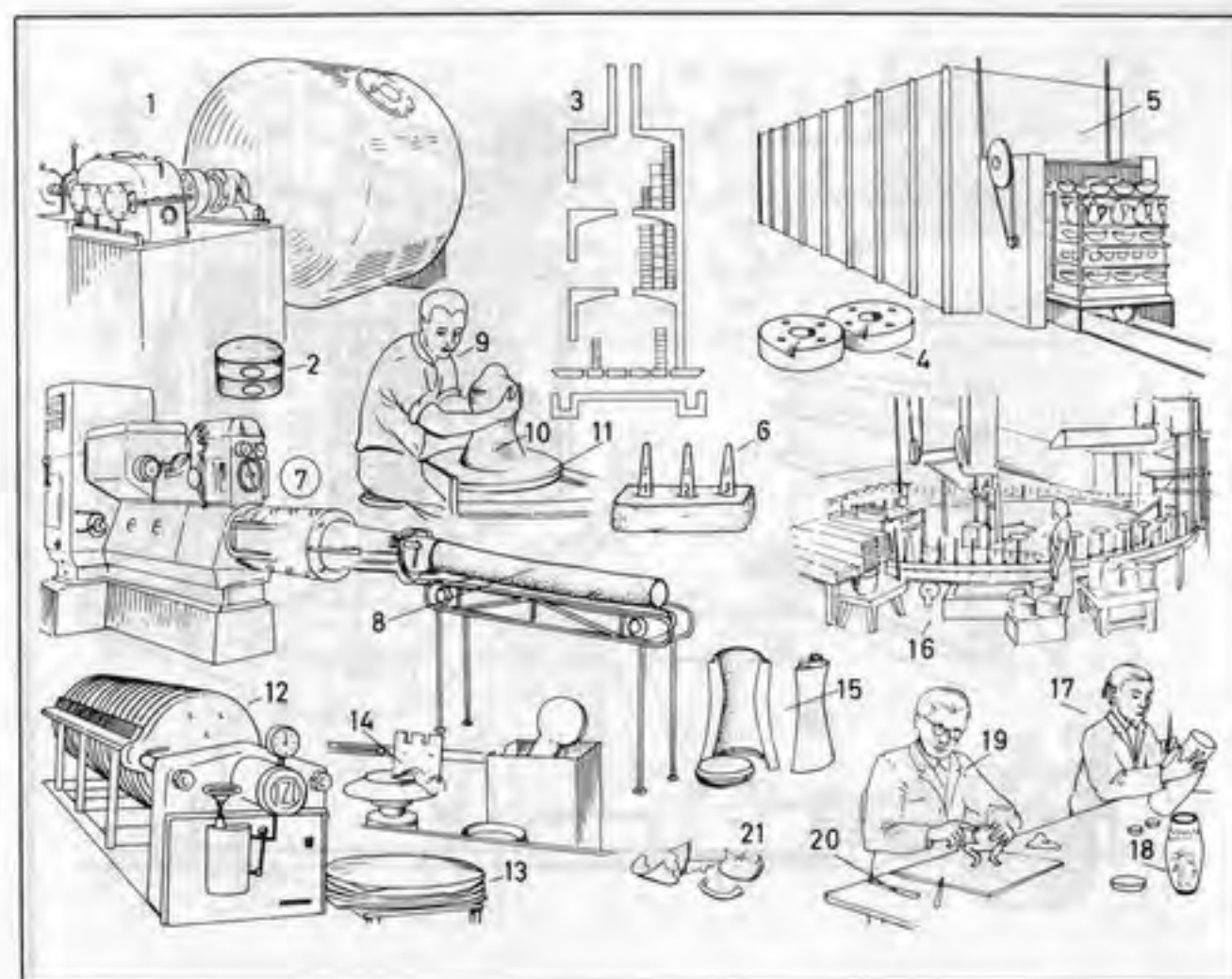

- 1 grinding cylinder (ball mill) for the preparation of the raw material in water
- 2 sample sagger (saggar, seggar), with aperture for observing the firing process
- 3 bottle kiln (beehive kiln) [diagram]
- 4 firing mould (*Am. mold*)
- 5 tunnel kiln
- 6 Seger cone (pyrometric cone, *Am. Orton cone*) for measuring high temperatures
- 7 de-airing pug mill (de-airing pug press), an extrusion press
- 8 clay column
- 9 thrower throwing a ball (bat) of clay
- 10 slug of clay
- 11 turntable; *sim.*: potter's wheel
- 12 filter press
- 13 filter cake
- 14 jiggering, with a profiling tool; *sim.*: jollying
- 15 plaster mould (*Am. mold*) for slip casting
- 16 turntable glazing machine
- 17 porcelain painter (*china painter*)
- 18 hand-painted vase
- 19 repairer
- 20 pallet (modelling, *Am. modeling, tool*)
- 21 shards (sherds, potsherds)



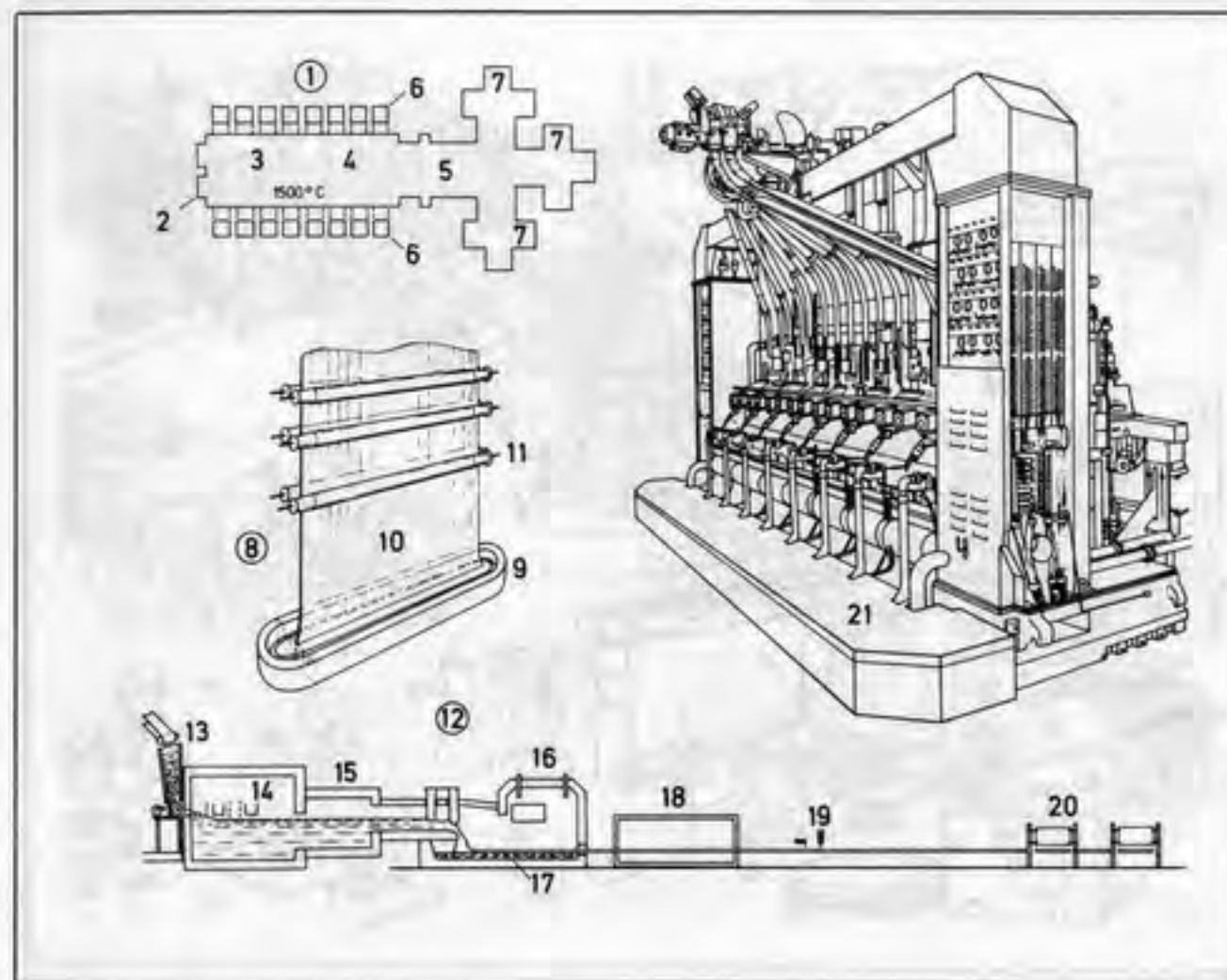

**1-20 sheet glass production (flat glass production)**

- 1 glass furnace (tank furnace) for the Fourcault process [diagram]
- 2 filling end, for feeding in the batch (frit)
- 3 melting bath
- 4 refining bath (fining bath)
- 5 working baths (working area)
- 6 burners
- 7 drawing machines
- 8 Fourcault glass-drawing machine
- 9 slot
- 10 glass ribbon (ribbon of glass, sheet of glass) being drawn upwards
- 11 rollers (drawing rolls)
- 12 float glass process
- 13 batch (frit) feeder (funnel)
- 14 melting bath
- 15 cooling tank
- 16 float bath in a protective inert-gas atmosphere
- 17 molten tin

- 18 annealing lehr
- 19 automatic cutter
- 20 stacking machines
- 21 IS (individual-section) machine, a bottle-making machine
- 22-37 blowing processes**
- 22 blow-and-blow process
- 23 introduction of the gob of molten glass
- 24 first blowing
- 25 suction
- 26 transfer from the parison mould (*Am. mold*) to the blow mould (*Am. mold*)
- 27 reheating
- 28 blowing (suction, final shaping)
- 29 delivery of the completed vessel
- 30 press-and-blow process
- 31 introduction of the gob of molten glass
- 32 plunger
- 33 pressing
- 34 transfer from the press mould (*Am. mold*) to the blow mould (*Am. mold*)

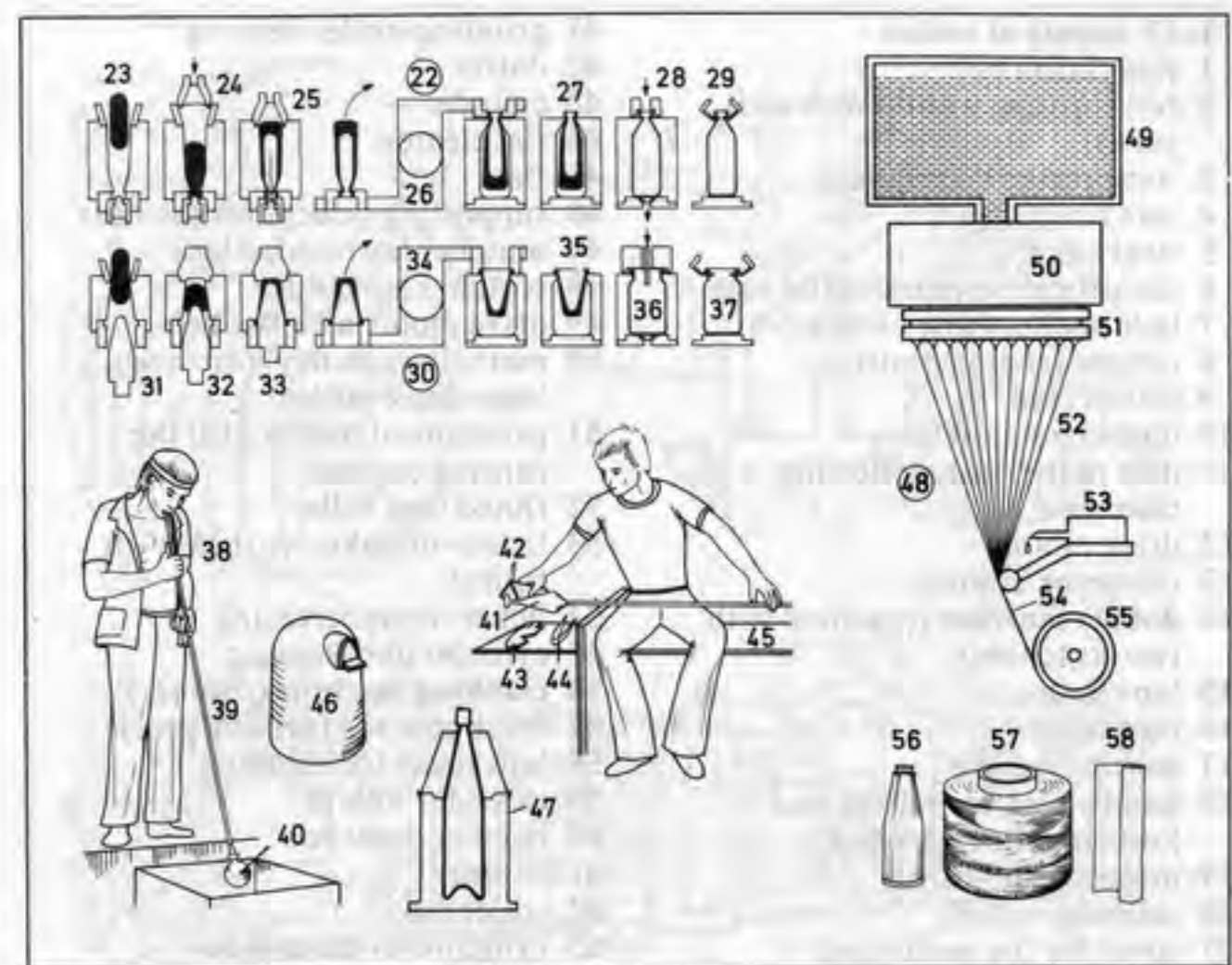

- 35 reheating
- 36 blowing (suction, final shaping)
- 37 delivery of the completed vessel
- 38-47 glassmaking (glassblowing, glassblowing by hand, glass forming)**
- 38 glassmaker (glassblower)
- 39 blowing iron
- 40 gob
- 41 hand-blown goblet
- 42 clappers for shaping the base (foot) of the goblet
- 43 trimming tool
- 44 tongs
- 45 glassmaker's chair (gaffer's chair)
- 46 covered glasshouse pot
- 47 mould (*Am. mold*), into which the parison is blown
- 48-55 production of glass fibre (*Am. glass fiber*)**
- 48 continuous filament process
- 49 glass furnace
- 50 bushing containing molten glass
- 51 bushing tips

- 52 glass filaments
- 53 sizing
- 54 strand (thread)
- 55 spool
- 56-58 glass fibre (*Am. glass fiber*) products**
- 56 glass yarn (glass thread)
- 57 sleeved glass yarn (glass thread)
- 58 glass wool



## 1-13 supply of cotton

- 1 ripe cotton boll
- 2 full cop (cop wound with weft yarn)
- 3 compressed cotton bale
- 4 jute wrapping
- 5 steel band
- 6 identification mark of the bale
- 7 bale opener (bale breaker)
- 8 cotton-feeding brattice
- 9 cotton feed
- 10 dust extraction fan
- 11 duct to the dust-collecting chamber
- 12 drive motor
- 13 conveyor brattice
- 14 **double scutcher** (machine with two scutchers)
- 15 lap cradle
- 16 rack head
- 17 starting handle
- 18 handwheel, for raising and lowering the rack head
- 19 movable lap-turner
- 20 calender rollers
- 21 cover for the perforated cylinders
- 22 dust escape flue (dust discharge flue)
- 23 drive motors (beater drive motors)
- 24 beater driving shaft
- 25 three-blade beater (Kirschner beater)
- 26 grid [for impurities to drop]
- 27 pedal roller (pedal cylinder)
- 28 control lever for the pedal roller, a pedal lever
- 29 variable change-speed gear
- 30 cone drum box
- 31 stop and start levers for the hopper
- 32 wooden hopper delivery roller
- 33 hopper feeder
- 34 **carding machine** (card, carding engine)
- 35 card can (carding can), for receiving the coiled sliver
- 36 can holder
- 37 calender rollers
- 38 carded sliver (card sliver)
- 39 vibrating doffer comb
- 40 start-stop lever

- 41 grinding-roller bearing
- 42 doffer
- 43 cylinder
- 44 flat clearer
- 45 flats
- 46 supporting pulleys for the flats
- 47 scutcher lap (carded lap)
- 48 scutcher lap holder
- 49 drive motor with flat belt
- 50 main drive pulley (fast-and-loose drive pulley)
- 51 principle of the card (of the carding engine)
- 52 fluted feed roller
- 53 licker-in (taker-in, licker-in roller)
- 54 licker-in undercasing
- 55 cylinder undercasing
- 56 **combing machine** (comber)
- 57 drive gearbox (driving gear)
- 58 laps ready for combing
- 59 calender rollers
- 60 comber draw box
- 61 counter
- 62 coiler top
- 63 principle of the comber
- 64 lap
- 65 bottom nipper
- 66 top nipper
- 67 top comb
- 68 combing cylinder
- 69 plain part of the cylinder
- 70 needed part of the cylinder
- 71 detaching rollers
- 72 carded and combed sliver

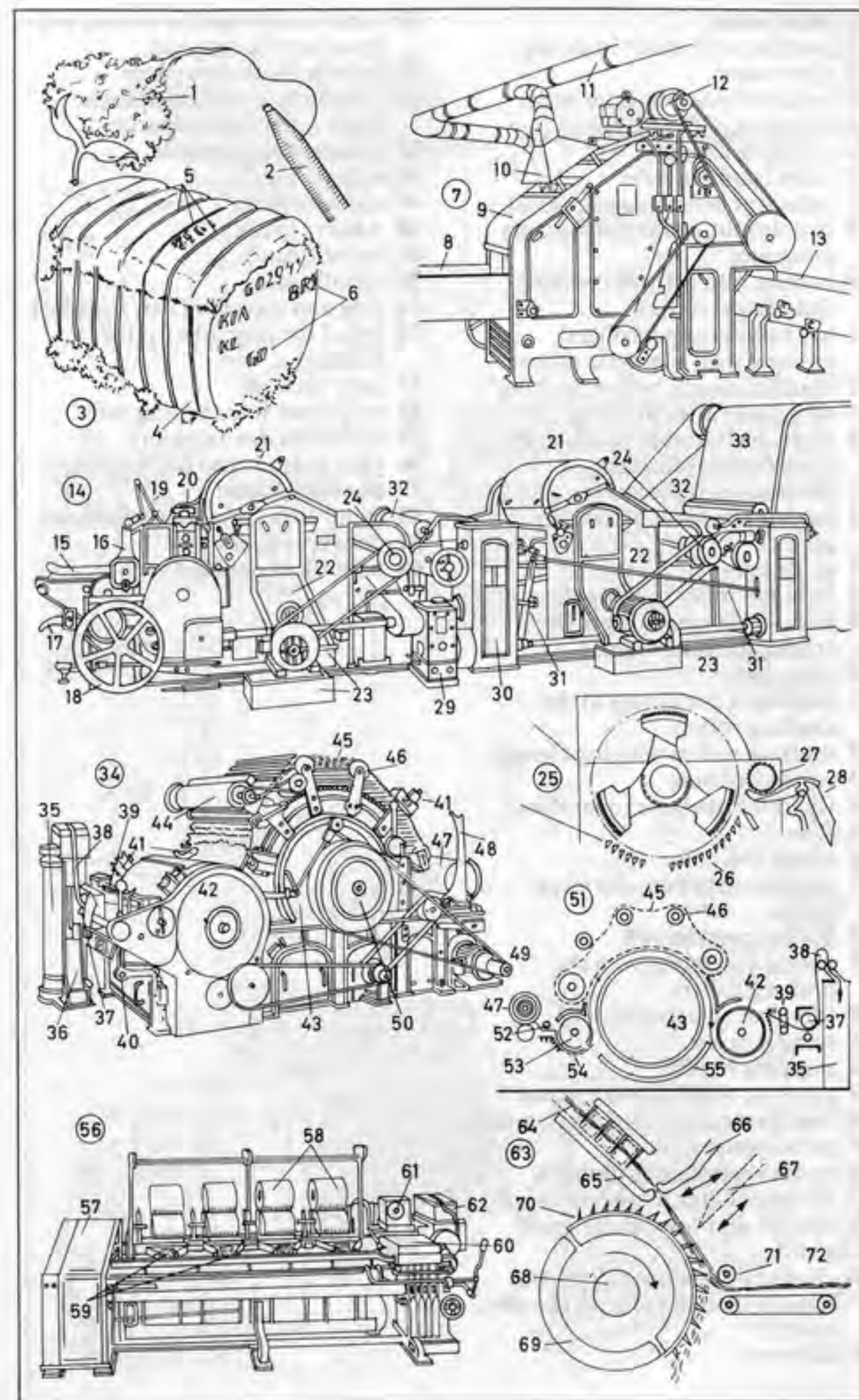



- 1 draw frame
- 2 gearbox with built-in motor
- 3 sliver cans
- 4 broken thread detector roller
- 5 doubling of the slivers
- 6 stopping handle
- 7 draw frame cover
- 8 indicator lamps (signal lights)
- 9 simple four-roller draw frame [diagram]
- 10 bottom rollers (lower rollers), fluted steel rollers
- 11 top rollers (upper rollers) covered with synthetic rubber
- 12 doubled slivers before drafting
- 13 thin sliver after drafting
- 14 high-draft system (high-draft draw frame) [diagram]
- 15 feeding-in of the sliver
- 16 leather apron (composition apron)
- 17 guide bar
- 18 light top roller (guide roller)
- 19 high-draft speed frame (fly frame, slubbing frame)
- 20 sliver cans
- 21 feeding of the slivers to the drafting rollers
- 22 drafting rollers with top clearers
- 23 roving bobbins
- 24 fly frame operator (operative)
- 25 flyer
- 26 frame end plate
- 27 intermediate yarn-forming frame
- 28 bobbin creel (creel)
- 29 roving emerging from the drafting rollers
- 30 lifter rail (separating rail)
- 31 spindle drive
- 32 stopping handle
- 33 gearbox, with built-on motor
- 34 ring frame (ring spinning frame)
- 35 three-phase motor
- 36 motor base plate (bedplate)
- 37 lifting bolt [for motor removal]
- 38 control gear for spindle speed
- 39 gearbox
- 40 change wheels for varying the spindle speed [to change the yarn count]
- 41 full creel

- 42 shafts and levers for raising and lowering the ring rail
- 43 spindles with separators
- 44 suction box connected to the front roller underclearers
- 45 standard ring spindle
- 46 spindle shaft
- 47 roller bearing
- 48 wharve (pulley)
- 49 spindle catch
- 50 spindle rail
- 51 ring and traveller (*Am. traveler*)
- 52 top of the ring tube (of the bobbin)
- 53 yarn (thread)
- 54 ring fitted into the ring rail
- 55 traveller (*Am. traveler*)
- 56 yarn wound onto the bobbin
- 57 doubling frame
- 58 creel, with cross-wound cheeses
- 59 delivery rollers
- 60 bobbins of doubled yarn

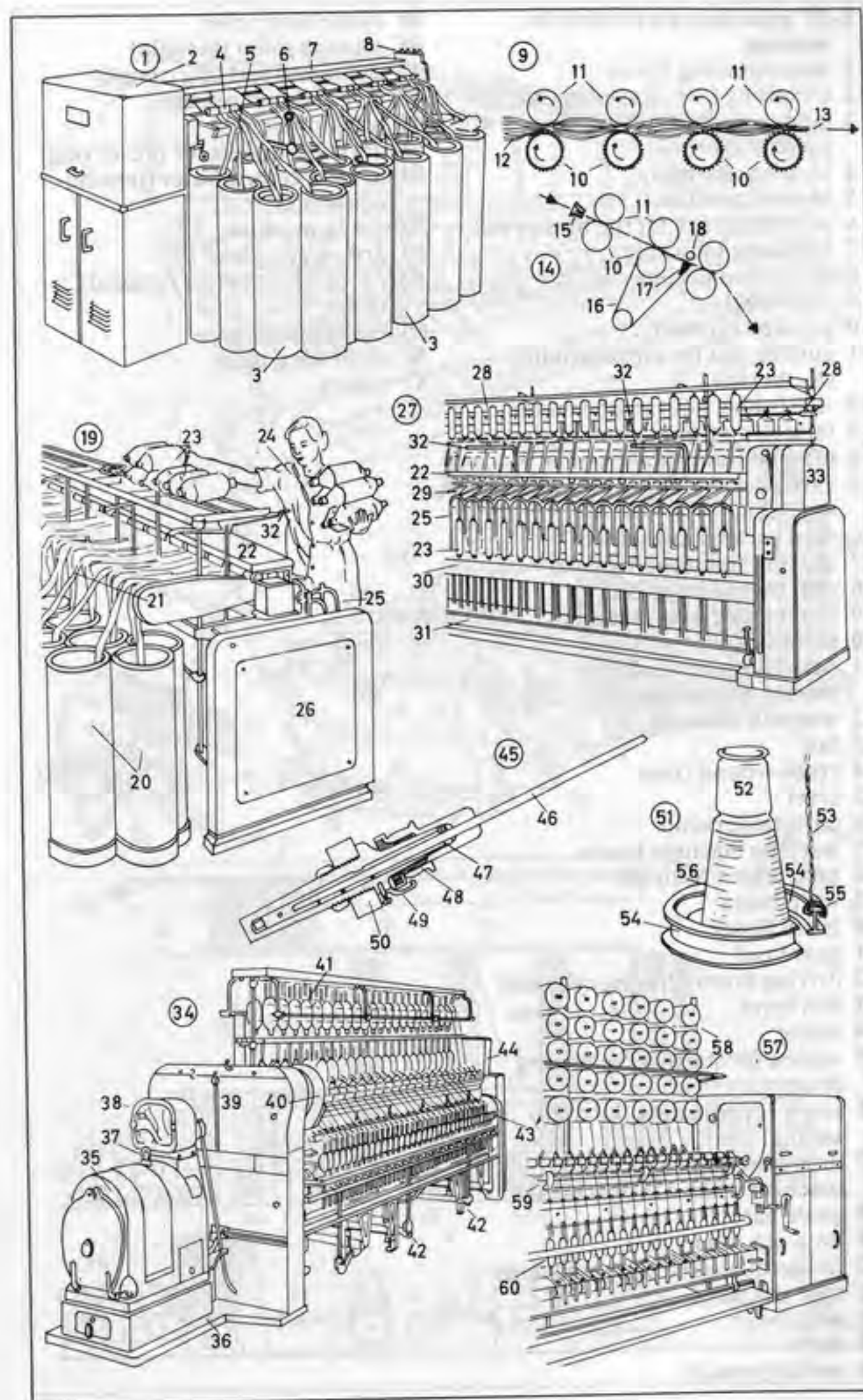



- 1-57 processes preparatory to weaving
- 1 cone-winding frame
  - 2 travelling (*Am.* traveling) blower
  - 3 guide rail, for the travelling (*Am.* traveling) blower
  - 4 blowing assembly
  - 5 blower aperture
  - 6 superstructure for the blower rail
  - 7 full-cone indicator
  - 8 cross-wound cone
  - 9 cone creel
  - 10 grooved cylinder
  - 11 guiding slot for cross-winding the threads
  - 12 side frame, housing the motor
  - 13 tension and slub-catching device
  - 14 off-end framing with filter
  - 15 yarn package, a ring tube or mule cop
  - 16 yarn package container
  - 17 starting and stopping lever
  - 18 self-threading guide
  - 19 broken thread stop motion
  - 20 thread clearer
  - 21 weighting disc (disk) for tensioning the thread
  - 22 warping machine
  - 23 fan
  - 24 cross-wound cone
  - 25 creel
  - 26 adjustable comb
  - 27 warping machine frame
  - 28 yarn length recorder
  - 29 warp beam
  - 30 beam flange
  - 31 guard rail
  - 32 driving drum (driving cylinder)
  - 33 belt drive
  - 34 motor
  - 35 release for starting the driving drum
  - 36 screw for adjusting the comb setting
  - 37 drop pins, for stopping the machine when a thread breaks
  - 38 guide bar
  - 39 drop pin rollers
  - 40 indigo dying and sizing machine
  - 41 take-off stand
  - 42 warp beam
  - 43 warp
  - 44 wetting trough

- 45 immersion roller
- 46 squeeze roller (mangle)
- 47 dye liquor padding trough
- 48 air oxidation passage
- 49 washing trough
- 50 drying cylinders for pre-drying
- 51 tension compensator (tension equalizer)
- 52 sizing machine
- 53 drying cylinders
- 54 *for cotton: stenter; for wool: tenter*
- 55 beaming machine
- 56 sized warp beam
- 57 rollers

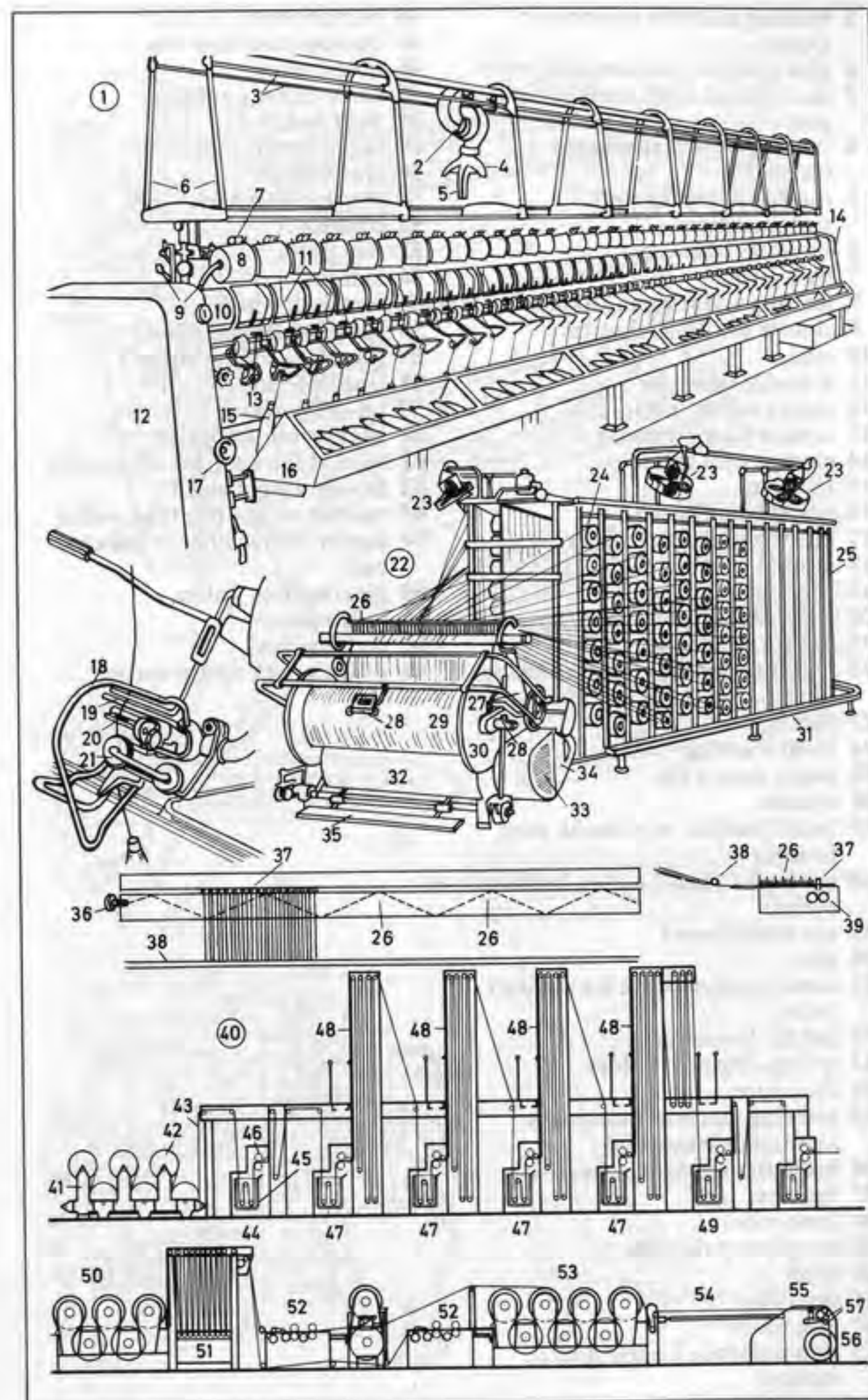



- |  |  |
|--|--|
| 1 weaving machine (automatic loom)                   | 44 bumper steel                        |
| 2 pick counter (tachometer)                          | 45 bumper steel stop rod               |
| 3 shaft (heald shaft, heald frame guide)             | 46 breast beam                         |
| 4 shafts (heald shafts, heald frames)                | 47 cloth take-up roller                |
| 5 rotary battery for weft replenishment              | 48 warp beam                           |
| 6 sley (slay) cap                                    | 49 beam flange                         |
| 7 weft pirn  | 50 crankshaft                          |
| 8 starting and stopping handle                       | 51 crankshaft wheel                    |
| 9 shuttle box, with shuttles                         | 52 connector                           |
| 10 reed  | 53 sley (slay)                         |
| 11 selvage (selvage)                                 | 54 lam rods                            |
| 12 cloth (woven fabric)                              | 55 camshaft wheel                      |
| 13 temple (cloth temple)                             | 56 camshaft (tappet shaft)             |
| 14 electric weft feeler                              | 57 tappet (shedding tappet)            |
| 15 flywheel  | 58 treadle lever                       |
| 16 breast beam board                                 | 59 let-off motion                      |
| 17 picking stick (pick stick)                        | 60 beam motion control                 |
| 18 electric motor                                    | 61 rope of the warp let-off motion     |
| 19 cloth take-up motion                              | 62 let-off weight lever                |
| 20 cloth roller (fabric roller)                      | 63 control weight [for the treadle]    |
| 21 can for empty pirns                               | 64 picker with leather or bakelite pad |
| 22 lug strap, for moving the picking stick           | 65 picking stick buffer                |
| 23 fuse box  | 66 picking cam                         |
| 24 loom framing                                      | 67 picking bowl                        |
| 25 metal shuttle tip                                 | 68 picking stick return spring         |
| 26 shuttle   |  |
| 27 heald (heddle, wire heald, wire heddle)           |  |
| 28 eye (eyelet, heald eyelet, heddle eyelet)         |  |
| 29 eye (shuttle eye)                                 |  |
| 30 pirn  |  |
| 31 metal contact sleeve for the weft feeler          |  |
| 32 slot for the feeler                               |  |
| 33 spring-clip pirn holder                           |  |
| 34 drop wire   |  |
| 35 weaving machine (automatic loom) [side elevation] |  |
| 36 heald shaft guiding wheels                        |  |
| 37 backrest  |  |
| 38 lease rods  |  |
| 39 warp (warp thread)                                |  |
| 40 shed  |  |
| 41 sley (slay)                                       |  |
| 42 race board  |  |
| 43 stop rod blade for the stop motion                |  |

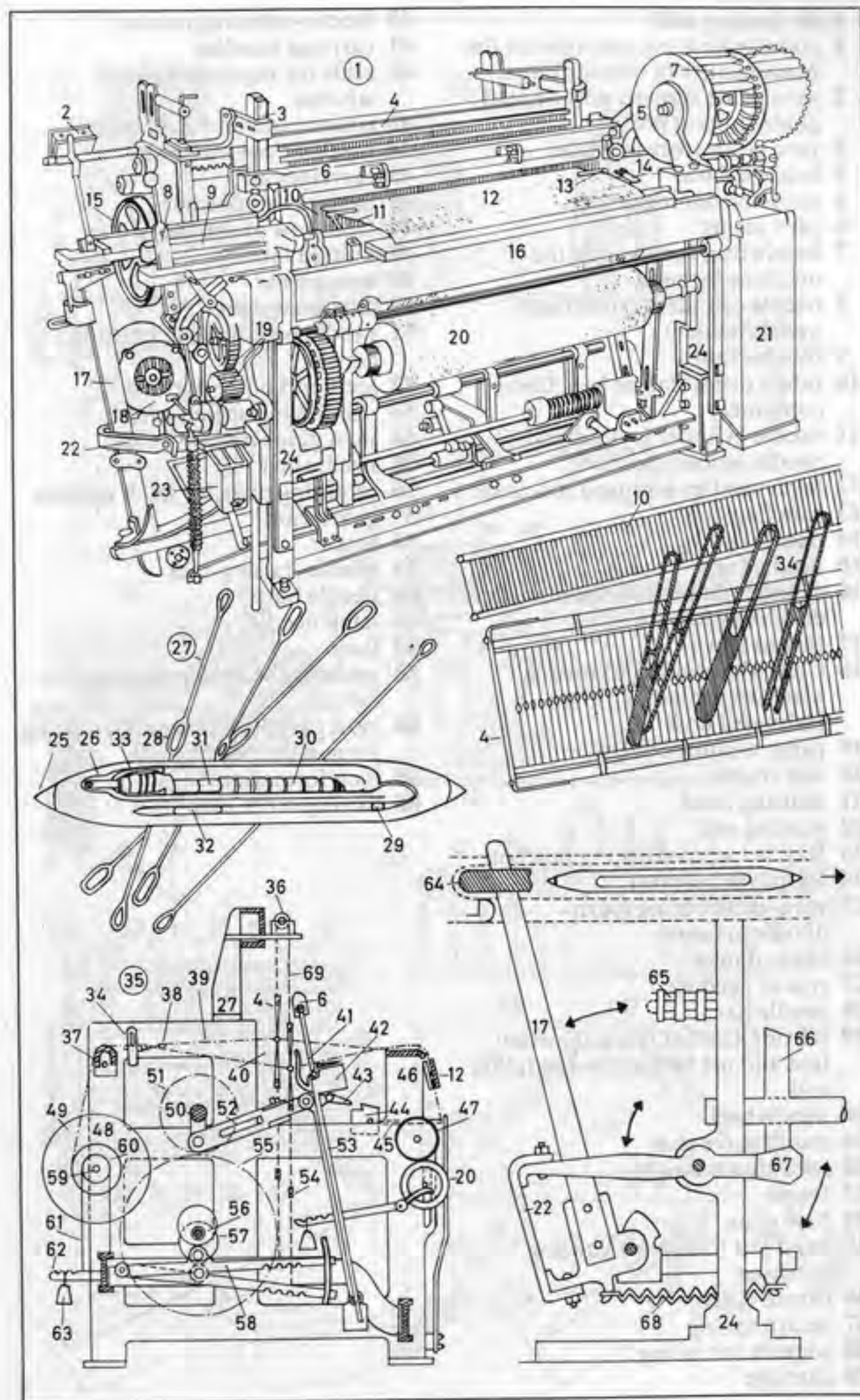



- 1-66 hosiery mill
- 1 circular knitting machine for the manufacture of tubular fabric
  - 2 yarn guide support post (thread guide support post)
  - 3 yarn guide (thread guide)
  - 4 bottle bobbin
  - 5 yarn-tensioning device
  - 6 yarn feeder
  - 7 handwheel for rotating the machine by hand
  - 8 needle cylinder (cylindrical needle holder)
  - 9 tubular fabric
  - 10 fabric drum (fabric box, fabric container)
  - 11 needle cylinder (cylindrical needle holder) [section]
  - 12 latch needles arranged in a circle
  - 13 cam housing
  - 14 needle cams
  - 15 needle trick
  - 16 cylinder diameter (also diameter of tubular fabric)
  - 17 thread (yarn)
  - 18 Cotton's patent flat knitting machine for ladies' fully-fashioned hose
  - 19 pattern control chain
  - 20 side frame
  - 21 knitting head
  - 22 starting rod
  - 23 Raschel warp-knitting machine
  - 24 warp (warp beam)
  - 25 yarn-distributing (yarn-dividing) beam
  - 26 beam flange
  - 27 row of needles
  - 28 needle bar
  - 29 fabric (Raschel fabric) [curtain lace and net fabrics] on the fabric roll
  - 30 handwheel
  - 31 motor drive gear
  - 32 take-down weight
  - 33 frame
  - 34 base plate
  - 35 hand flat (flat-bed) knitting machine
  - 36 thread (yarn)
  - 37 return spring
  - 38 support for springs
  - 39 carriage
  - 40 feeder-selecting device
  - 41 carriage handles
  - 42 scale for regulating size of stitches
  - 43 course counter (tachometer)
  - 44 machine control lever
  - 45 carriage rail
  - 46 back row of needles
  - 47 front row of needles
  - 48 knitted fabric
  - 49 tension bar
  - 50 tension weight
  - 51 needle bed showing knitting action
  - 52 teeth of knock-over bit
  - 53 needles in parallel rows
  - 54 yarn guide (thread guide)
  - 55 needle bed
  - 56 retaining plate for latch needles
  - 57 guard cam
  - 58 sinker
  - 59 needle-raising cam
  - 60 needle butt
  - 61 latch needle
  - 62 loop
  - 63 pushing the needle through the fabric
  - 64 yarn guide (thread guide) placing yarn in the needle hook
  - 65 loop formation
  - 66 casting off of loop

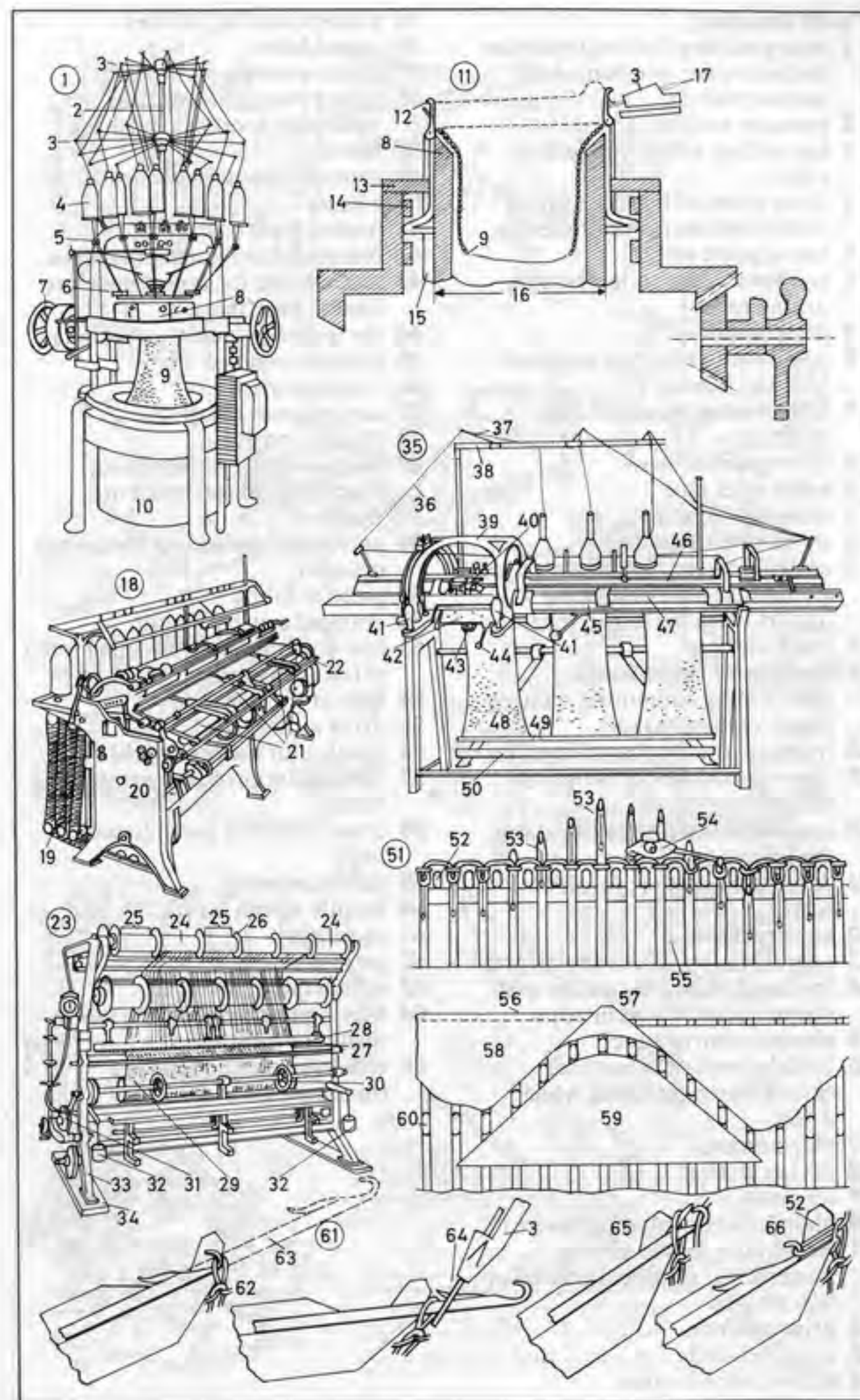



1-65 finishing

- 1 rotary milling (fulling) machine for felting the woollen (*Am.* woollen) fabric
- 2 pressure weights
- 3 top milling roller (top fulling roller)
- 4 drive wheel of bottom milling roller (bottom fulling roller)
- 5 fabric guide roller
- 6 bottom milling roller (bottom fulling roller)
- 7 draft board
- 8 open-width scouring machine for finer fabrics
- 9 fabric being drawn off the machine
- 10 drive gearbox
- 11 water inlet pipe
- 12 drawing-in roller
- 13 scroll-opening roller
- 14 pendulum-type hydro-extractor (centrifuge), for extracting liquors from the fabric
- 15 machine base
- 16 casing over suspension
- 17 outer casing containing rotating cage (rotating basket)
- 18 hydro-extractor (centrifuge) lid
- 19 stop-motion device (stopping device)
- 20 automatic starting and braking device
- 21 *for cotton: stenter; for wool: tenter*
- 22 air-dry fabric
- 23 operator's (operative's) platform
- 24 feeding of fabric by guides onto stenter (tenter) pins or clips
- 25 electric control panel
- 26 initial overfeed to produce shrink-resistant fabric when dried
- 27 thermometer
- 28 drying section
- 29 air outlet
- 30 plaiter (fabric-plaiting device)
- 31 wire-roller fabric-raising machine for producing raised or nap surface
- 32 drive gearbox
- 33 unraised cloth
- 34 wire-covered rollers

- 35 plaiter (cuttling device)
- 36 raised fabric
- 37 plaiting-down platform
- 38 rotary press (calendering machine), for press finishing
- 39 fabric
- 40 control buttons and control wheels
- 41 heated press bowl
- 42 rotary cloth-shearing machine
- 43 suction slot, for removing loose fibres (*Am.* fibers)
- 44 doctor blade (cutting cylinder)
- 45 protective guard
- 46 rotating brush
- 47 curved scray entry
- 48 treadle control
- 49 [non-shrinking] decatizing (decatizing) fabric-finishing machine
- 50 perforated decatizing (decatizing) cylinder
- 51 piece of fabric
- 52 cranked control handle
- 53 ten-colour (*Am.* ten-color) roller printing machine
- 54 base of the machine
- 55 drive motor
- 56 blanket [of rubber or felt]
- 57 fabric after printing (printed fabric)
- 58 electric control panel (control unit)
- 59 screen printing
- 60 mobile screen frame
- 61 squeegee
- 62 pattern stencil
- 63 screen table
- 64 fabric gummed down on table ready for printing
- 65 screen printing operator (operative)

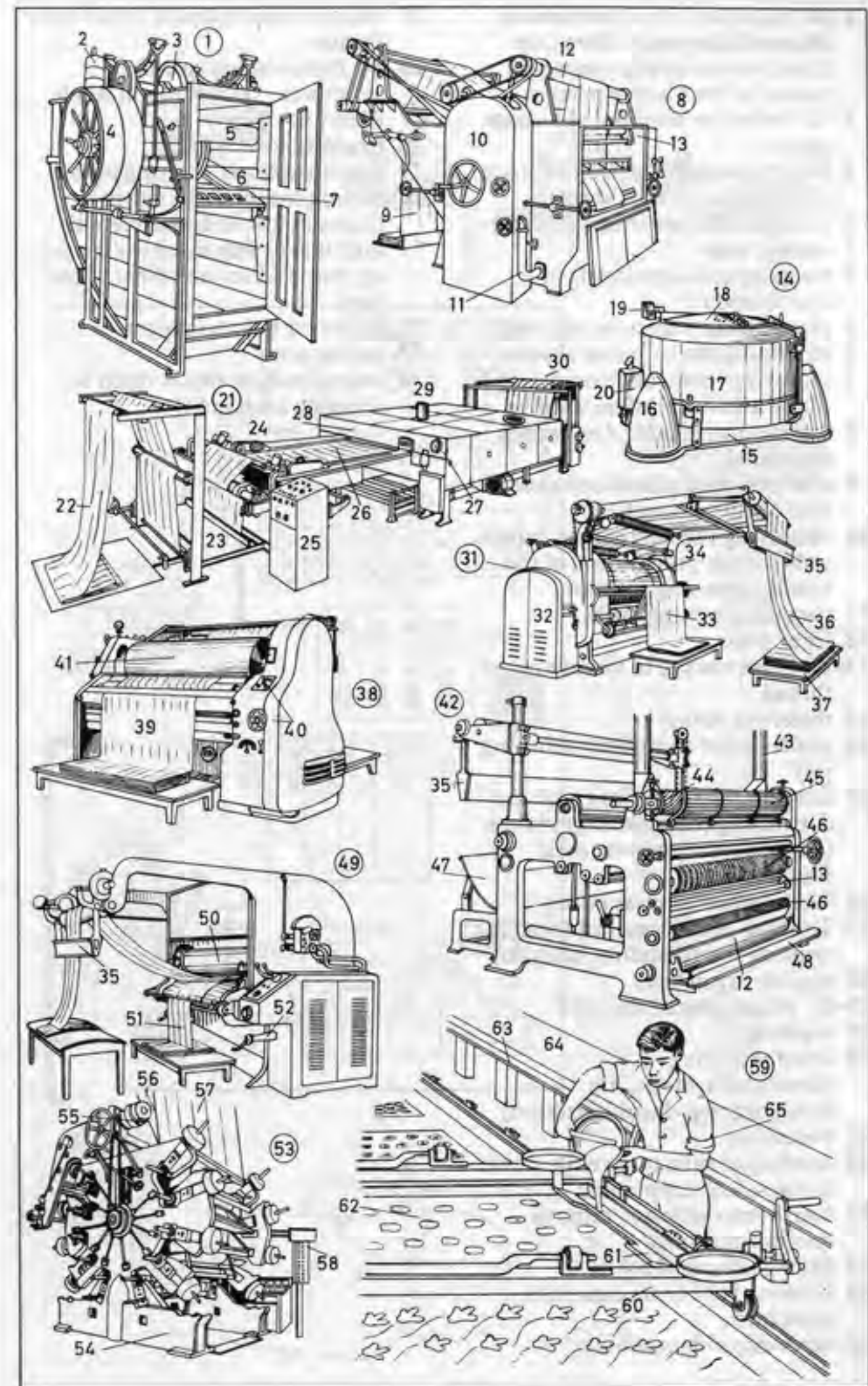



- 1-34 manufacture of **continuous filament and staple fibre** (*Am. fiber*) **viscose rayon yarns** by means of the viscose process
- 1-12 from raw material to viscose rayon
- 1 basic material [beech and spruce cellulose in form of sheets]
- 2 mixing cellulose sheets
- 3 caustic soda
- 4 steeping cellulose sheets in caustic soda
- 5 pressing out excess caustic soda
- 6 shredding the cellulose sheets
- 7 maturing (controlled oxidation) of the alkali-cellulose crumbs
- 8 carbon disulphide (*Am. carbon disulfide*)
- 9 conversion of alkali-cellulose into cellulose xanthate
- 10 dissolving the xanthate in caustic soda for the preparation of the viscose spinning solution
- 11 vacuum ripening tanks
- 12 filter press
- 13-27 from viscose to viscose rayon thread
- 13 metering pump
- 14 multi-holed spinneret (spinning jet)
- 15 coagulating (spinning) bath for converting (coagulating) viscose (viscous solution) into solid filaments
- 16 Godet wheel, a glass pulley
- 17 Topham centrifugal pot (box) for twisting the filaments into yarn
- 18 viscose rayon cake
- 19-27 processing of the cake
- 19 washing
- 20 desulphurizing (desulphurization, *Am. desulfurizing, desulfurization*)
- 21 bleaching
- 22 treating of cake to give filaments softness and suppleness
- 23 hydro-extraction to remove surplus moisture
- 24 drying in heated room
- 25 winding yarn from cake into cone form
- 26 cone-winding machine

- 27 viscose rayon yarn on cone ready for use
- 28-34 from viscose spinning solution to viscose rayon staple fibre (*Am. fiber*)
- 28 filament tow
- 29 overhead spray washing plant
- 30 cutting machine for cutting filament tow to desired length
- 31 multiple drying machine for cut-up staple fibre (*Am. fiber*) layer (lap)
- 32 conveyor belt (conveyor)
- 33 baling press
- 34 bale of viscose rayon ready for dispatch (despatch)

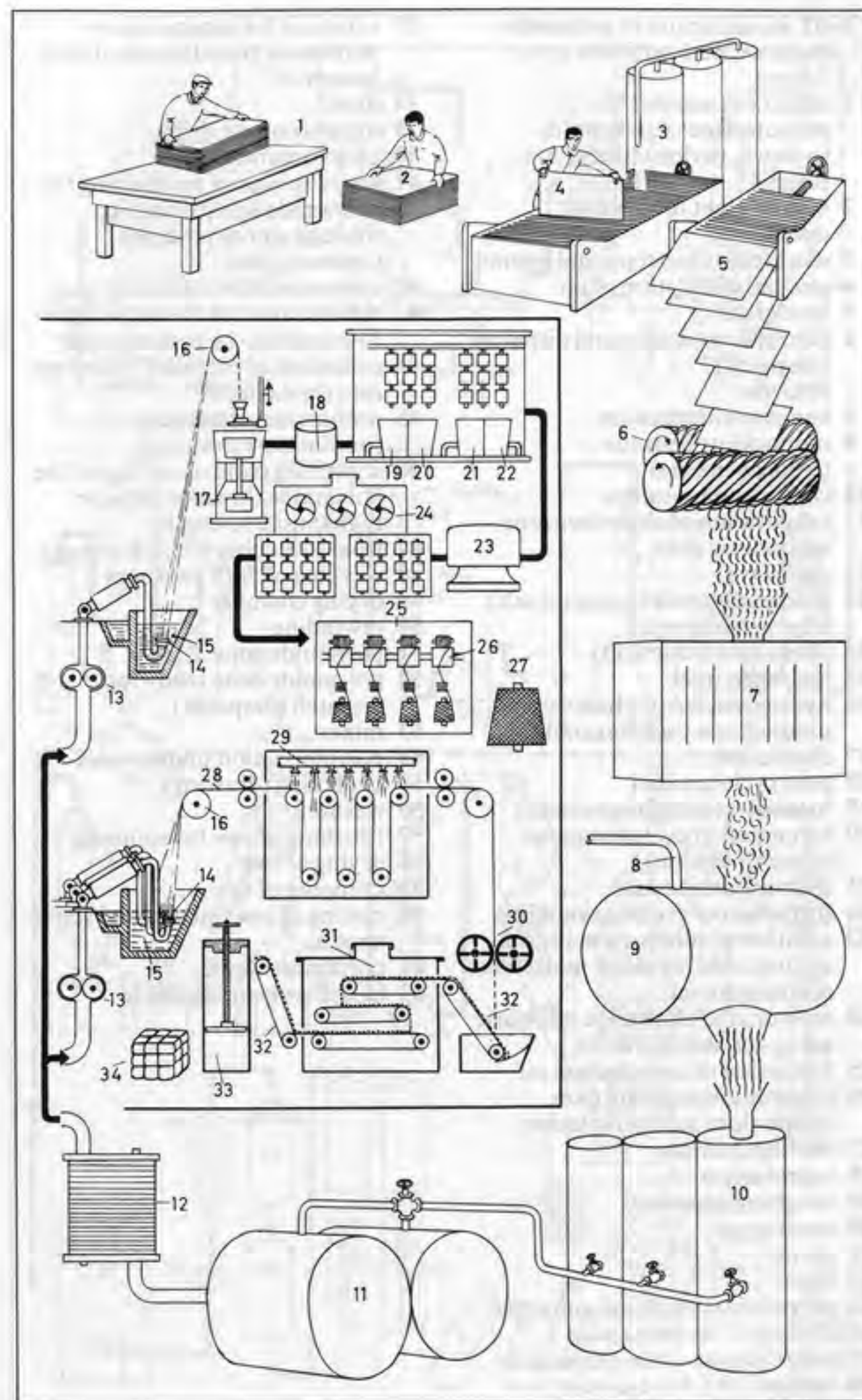



- 1-62 manufacture of polyamide (nylon 6, perlon) fibres (*Am. fibers*)
- 1 coal [raw material for manufacture of polyamide (nylon 6, perlon) fibres (*Am. fibers*)]
  - 2 coking plant for dry coal distillation
  - 3 extraction of coal tar and phenol
  - 4 gradual distillation of tar
  - 5 condenser
  - 6 benzene extraction and dispatch (despatch)
  - 7 chlorine
  - 8 benzene chlorination
  - 9 monochlorobenzene (chlorobenzene)
  - 10 caustic soda solution
  - 11 evaporation of chlorobenzene and caustic soda
  - 12 autoclave
  - 13 sodium chloride (common salt), a by-product
  - 14 phenol (carbolic acid)
  - 15 hydrogen inlet
  - 16 hydrogenation of phenol to produce raw cyclohexanol
  - 17 distillation
  - 18 pure cyclohexanol
  - 19 oxidation (dehydrogenation)
  - 20 formation of cyclohexanone (pimehinketone)
  - 21 hydroxylamine inlet
  - 22 formation of cyclohexanoxime
  - 23 addition of sulphuric acid (*Am. sulfuric acid*) to effect molecular rearrangement
  - 24 ammonia to neutralize sulphuric acid (*Am. sulfuric acid*)
  - 25 formation of caprolactam oil
  - 26 ammonium sulphate (*Am. ammonium sulfate*) solution
  - 27 cooling cylinder
  - 28 caprolactam
  - 29 weighing apparatus
  - 30 melting pot
  - 31 pump
  - 32 filter
  - 33 polymerization in the autoclave
  - 34 cooling of the polyamide
  - 35 solidification of the polyamide
  - 36 vertical lift (*Am. elevator*)
  - 37 extractor for separating the polyamide from the remaining lactam oil
  - 38 drier
  - 39 dry polyamide chips
  - 40 chip container
  - 41 top of spinneret for melting the polyamide and forcing it through spinneret holes (spinning jets)
  - 42 spinneret holes (spinning jets)
  - 43 solidification of the polyamide filaments in the cooling tower
  - 44 collection of extruded filaments into thread form
  - 45 preliminary stretching (preliminary drawing)
  - 46 stretching (cold-drawing) of the polyamide thread to achieve high tensile strength
  - 47 final stretching (final drawing)
  - 48 washing of yarn packages
  - 49 drying chamber
  - 50 rewinding
  - 51 polyamide cone
  - 52 polyamide cone ready for dispatch (despatch)
  - 53 mixer
  - 54 polymerization under vacua
  - 55 stretching (drawing)
  - 56 washing
  - 57 finishing of tow for spinning
  - 58 drying of tow
  - 59 crimping of tow
  - 60 cutting of tow into normal staple lengths
  - 61 polyamide staple
  - 62 bale of polyamide staple

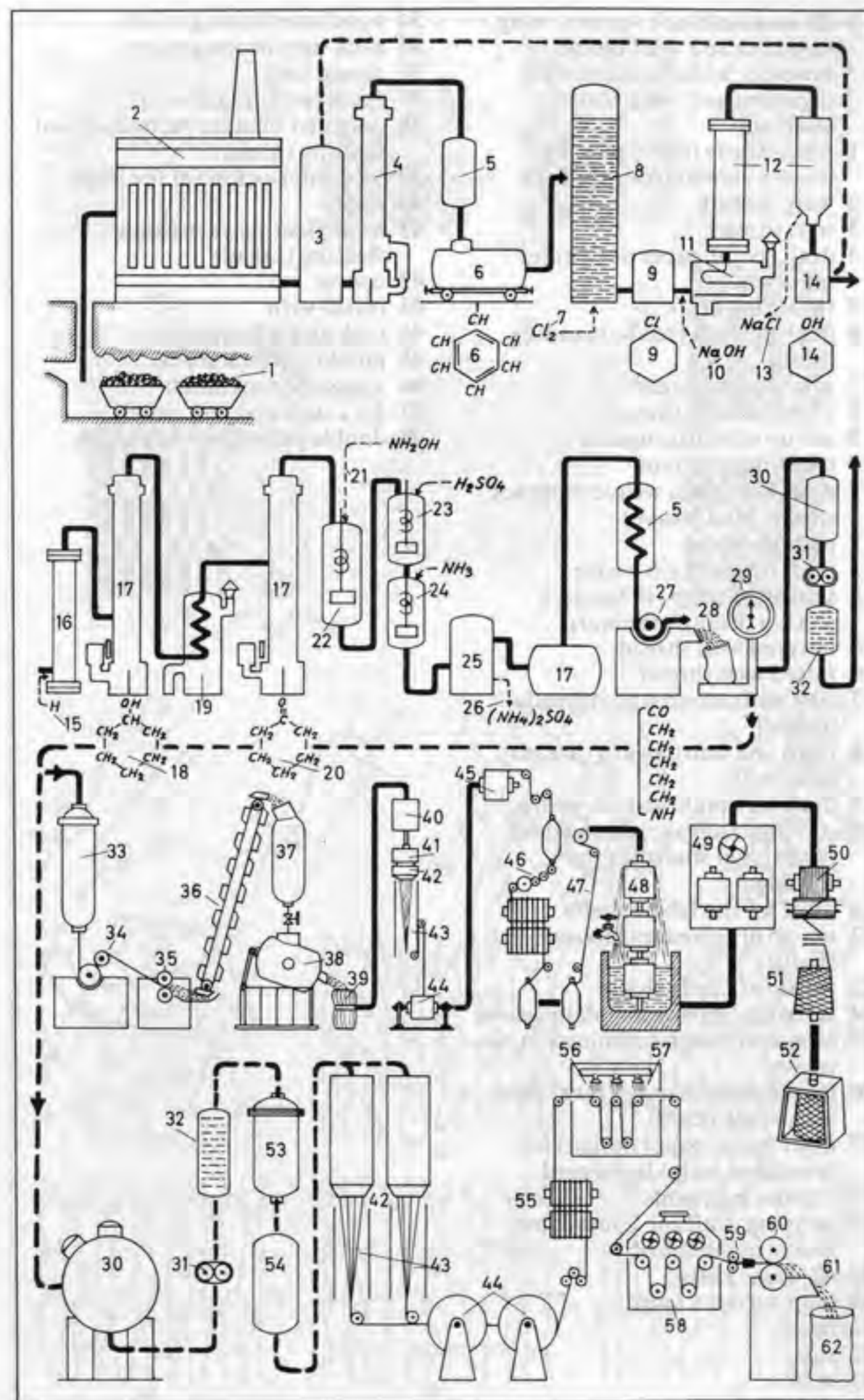



- 1-29 weaves [black squares: warp thread raised, weft thread lowered; white squares: weft thread raised, warp thread lowered]
- 1 plain weave (tabby weave) [weave viewed from above]
- 2 warp thread
- 3 weft thread
- 4 draft (point paper design) for plain weave
- 5 threading draft
- 6 denting draft (reed-threading draft)
- 7 raised warp thread
- 8 lowered warp thread
- 9 tie-up of shafts in pairs
- 10 treadling diagram
- 11 draft for basket weave (hopsack weave, matt weave)
- 12 pattern repeat
- 13 draft for warp rib weave
- 14 section of warp rib fabric, a section through the warp
- 15 lowered weft thread
- 16 raised weft thread
- 17 first and second warp threads [raised]
- 18 third and fourth warp threads [lowered]
- 19 draft for combined rib weave
- 20 selvedge (selvage) thread draft (additional shafts for the selvage)
- 21 draft for the fabric shafts
- 22 tie-up of selvage (selvage) shafts
- 23 tie-up of fabric shafts
- 24 selvedge (selvage) in plain weave
- 25 section through combination rib weave
- 26 thread interlacing of reversible warp-faced cord
- 27 draft (point paper design) for reversible warp-faced cord
- 28 interlacing points
- 29 weaving draft for honeycomb weave in the fabric
- 30-48 basic knits
- 30 loop, an open loop
- 31 head
- 32 side
- 33 neck

- 34 head interlocking point
- 35 neck interlocking point
- 36 closed loop
- 37 mesh [with inlaid yarn]
- 38 diagonal floating yarn (diagonal floating thread)
- 39 loop interlocking at the head
- 40 float
- 41 loose floating yarn (loose floating thread)
- 42 course
- 43 inlaid yarn
- 44 tuck and miss stitch
- 45 pulled-up tuck stitch
- 46 staggered tuck stitch
- 47 2 x 2 tuck and miss stitch
- 48 double pulled-up tuck stitch

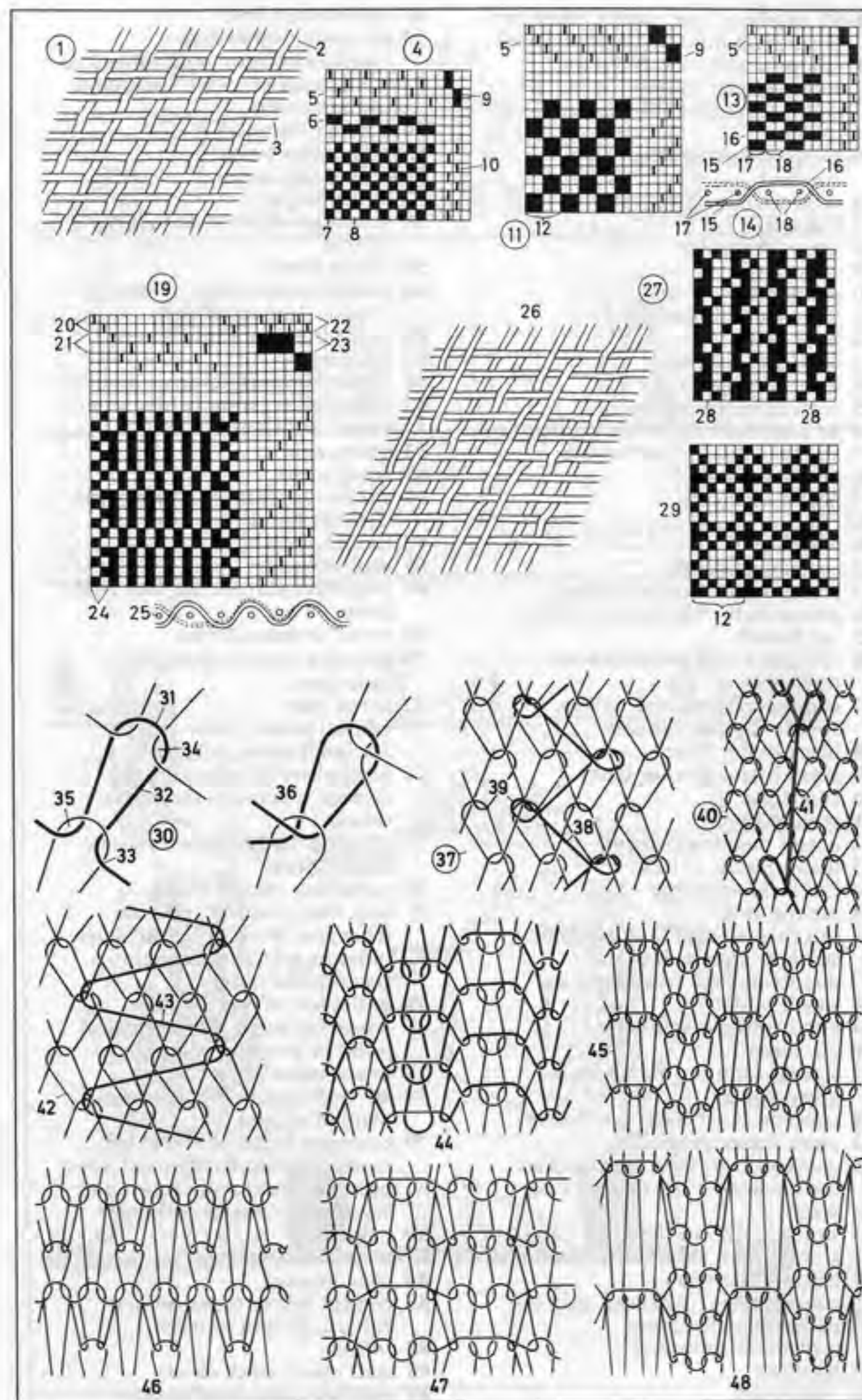



- 1-52 sulphate (*Am.* sulfate) pulp mill (kraft pulp mill) [in diagram form]
- 1 chippers with dust extractor  
2 rotary screen (riffler)  
3 chip packer (chip distributor)  
4 blower  
5 disintegrator (crusher, chip crusher)  
6 dust-settling chamber  
7 digester  
8 liquor preheater  
9 control tap  
10 swing pipe  
11 blow tank (diffuser)  
12 blow valve  
13 blow pit (diffuser)  
14 turpentine separator  
15 centralized separator  
16 jet condenser (injection condenser)  
17 storage tank for condensate  
18 hot water tank  
19 heat exchanger  
20 filter  
21 presorter  
22 centrifugal screen  
23 rotary sorter (rotary strainer)  
24 concentrator (thickener, decker)  
25 vat (chest)  
26 collecting tank for backwater (low box)  
27 conical refiner (cone refiner, Jordan, Jordan refiner)  
28 black liquor filter  
29 black liquor storage tank  
30 condenser  
31 separators  
32 heater (heating element)  
33 liquor pump  
34 heavy liquor pump  
35 mixing tank  
36 salt cake storage tank (sodium sulphate storage tank)  
37 dissolving tank (dissolver)  
38 steam heater  
39 electrostatic precipitator  
40 air pump  
41 storage tank for the unclarified green liquor  
42 concentrator (thickener, decker)  
43 green liquor preheater  
44 concentrator (thickener, decker) for the weak wash liquor (wash water)  
45 storage tank for the weak liquor  
46 storage tank for the cooking liquor  
47 agitator (stirrer)  
48 concentrator (thickener, decker)  
49 causticizing agitators (causticizing stirrers)  
50 classifier  
51 lime slaker
- 52 reconverted lime  
53-65 groundwood mill (mechanical pulp mill) [diagram]  
53 continuous grinder (continuous chain grinder)  
54 strainer (knotter)  
55 pulp water pump  
56 centrifugal screen  
57 screen (sorter)  
58 secondary screen (secondary sorter)  
59 rejects chest  
60 conical refiner (cone refiner, Jordan, Jordan refiner)  
61 pulp-drying machine (pulp machine)  
62 concentrator (thickener, decker)  
63 waste water pump (white water pump, pulp water pump)  
64 steam pipe  
65 water pipe  
66 continuous grinder (continuous chain grinder)  
67 feed chain  
68 groundwood  
69 reduction gear for the feed chain drive  
70 stone-dressing device  
71 grinding stone (grindstone, pulpstone)  
72 spray pipe  
73 conical refiner (cone refiner, Jordan, Jordan refiner)  
74 handwheel for adjusting the clearance between the knives (blades)  
75 rotating bladed cone (rotating bladed plug)  
76 stationary bladed shell (chemical wood pulp, chemical pulp) or groundwood pulp (mechanical pulp)  
77 inlet for unrefined cellulose (chemical wood pulp, chemical pulp) or groundwood pulp (mechanical pulp)  
78 outlet for refined cellulose (chemical wood pulp, chemical pulp) or groundwood pulp (mechanical pulp)  
79-86 stuff (stock) preparation plant [diagram]  
79 conveyor belt (conveyor) for loading cellulose (chemical wood pulp, chemical pulp) or groundwood pulp (mechanical pulp)  
80 pulper  
81 dump chest  
82 cone breaker  
83 conical refiner (cone refiner, Jordan, Jordan refiner)  
84 refiner  
85 stuff chest (stock chest)  
86 machine chest (stuff chest)

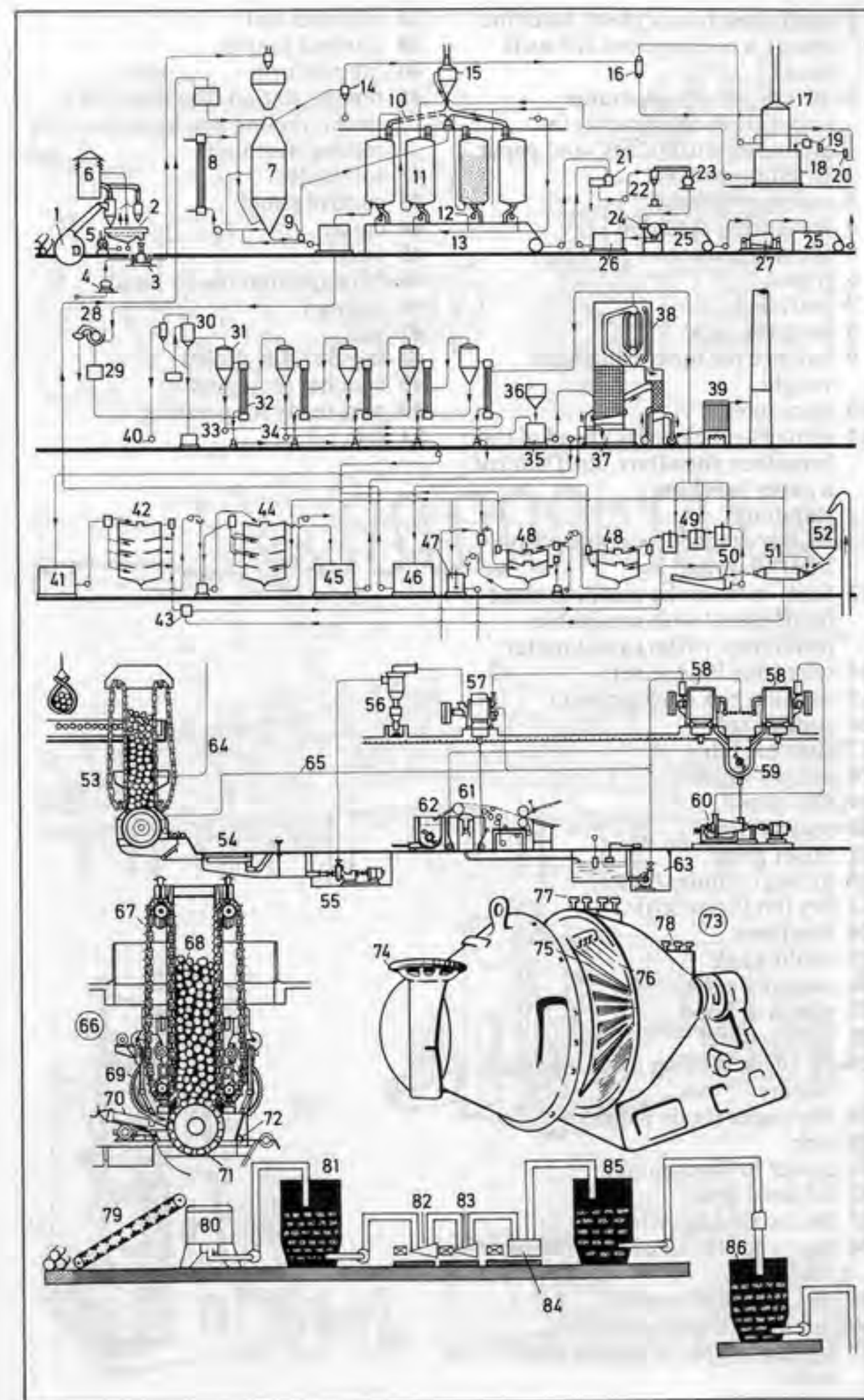



- |  |  |
|--|--|
| 1 stuff chest (stock chest, machine chest), a mixing chest for stuff (stock)                     | 38 calender roll   |
| 2-10 laboratory apparatus (laboratory equipment) for analysing stuff (stock) and paper           | 39 unwind station  |
| 2 Erlenmeyer flask   | 40 lift platform   |
| 3 volumetric flask   | 41 rewind station (rewinder, re-reeler, reeling machine, re-reeling machine) |
| 4 measuring cylinder   | 42 roll cutter   |
| 5 Bunsen burner  | 43 control panel   |
| 6 tripod   | 44 cutter  |
| 7 petri dish   | 45 web   |
| 8 test tube rack   | 46-51 papermaking by hand  |
| 9 balance for measuring basis weight   | 46 vatman  |
| 10 micrometer  | 47 vat   |
| 11 centrifugal cleaners ahead of the breastbox (headbox, stuff box) of a paper machine           | 48 mould ( <i>Am. mold</i> )   |
| 12 standpipe   | 49 coucher (couchman)  |
| 13-28 paper machine (production line) [diagram]  | 50 post ready for pressing   |
| 13 feed-in from the machine chest (stuff chest) with sand table (sand trap, riffler) and knotter | 51 felt  |
| 14 wire (machine wire)   |  |
| 15 vacuum box (suction box)  |  |
| 16 suction roll  |  |
| 17 first wet felt  |  |
| 18 second wet felt   |  |
| 19 first press   |  |
| 20 second press  |  |
| 21 offset press  |  |
| 22 drying cylinder (drier)   |  |
| 23 dry felt (drier felt)   |  |
| 24 size press  |  |
| 25 cooling roll  |  |
| 26 calender rolls  |  |
| 27 machine hood  |  |
| 28 delivery reel   |  |
| 29-35 blade coating machine (blade coater)   |  |
| 29 raw paper (body paper)  |  |
| 30 web   |  |
| 31 coater for the top side   |  |
| 32 infrared drier  |  |
| 33 heated drying cylinder  |  |
| 34 coater for the underside (wire side)  |  |
| 35 reel of coated paper  |  |
| 36 calender (Super-calender)   |  |
| 37 hydraulic system for the press rolls  |  |

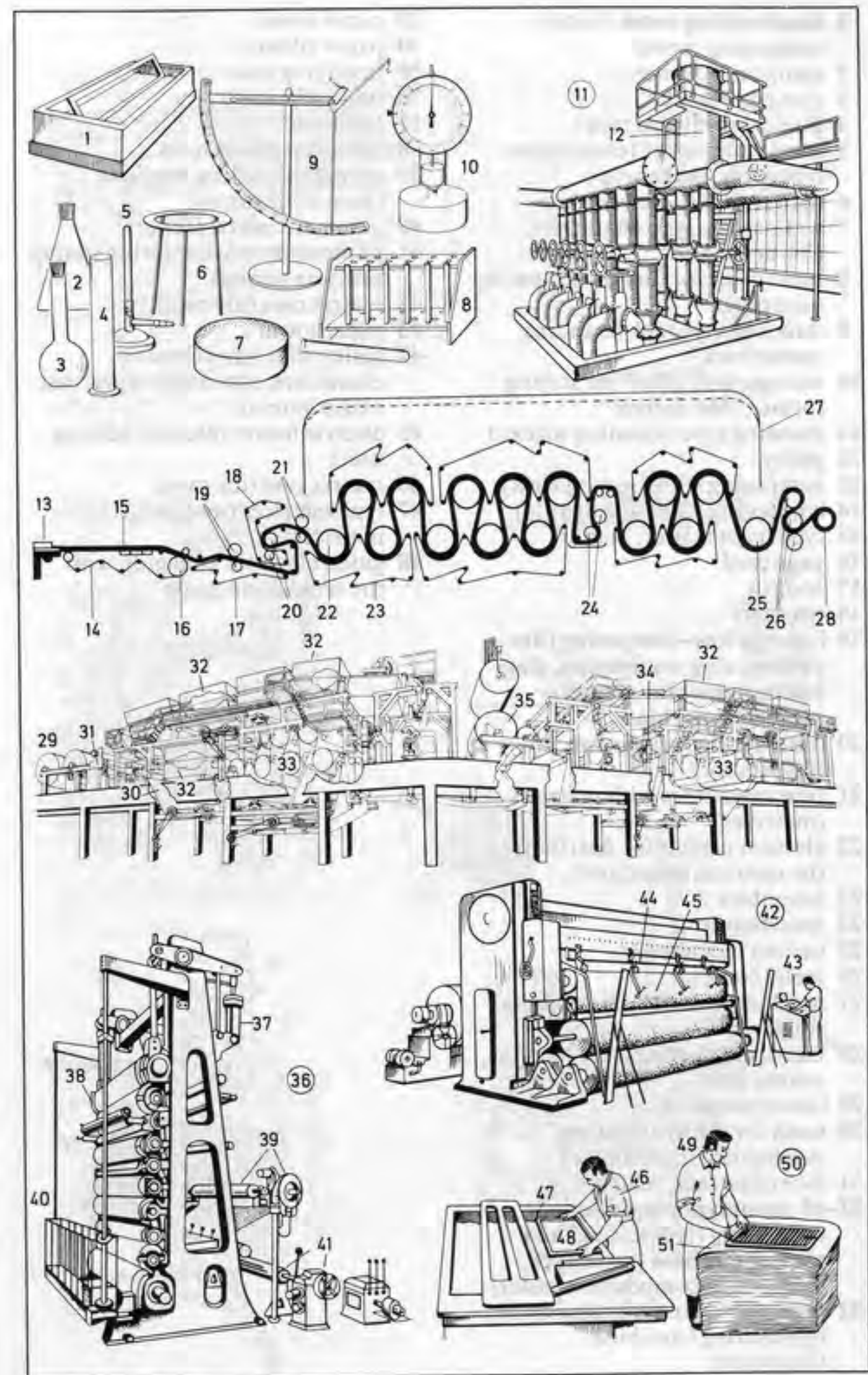



- 1 hand-setting room (hand-composing room)
- 2 composing frame
- 3 case (typecase)
- 4 case cabinet (case rack)
- 5 hand compositor (compositor, typesetter, maker-up)
- 6 manuscript (typescript)
- 7 sorts, types (type characters, characters)
- 8 rack (case) for furniture (spacing material)
- 9 standing type rack (standing matter rack)
- 10 storage shelf (shelf for storing formes, *Am.* forms)
- 11 standing type (standing matter)
- 12 galley
- 13 composing stick (setting stick)
- 14 composing rule (setting rule)
- 15 type (type matter, matter)
- 16 page cord
- 17 bodkin
- 18 tweezers
- 19 Linotype line-composing (line-casting, slug-composing, slug-casting) machine, a multi-magazine machine
- 20 distributing mechanism (distributor)
- 21 type magazines with matrices (matrixes)
- 22 elevator carrier for distributing the matrices (matrixes)
- 23 assembler
- 24 spacebands
- 25 casting mechanism
- 26 metal feeder
- 27 machine-set matter (cast lines, slugs)
- 28 matrices (matrixes) for hand-setting (sorts)
- 29 Linotype matrix
- 30 teeth for the distributing mechanism (distributor)
- 31 face (type face, matrix)
- 32-45 monotype single-unit composing (typesetting) and casting machine (monotype single-unit composition caster)
- 32 monotype standard composing (typesetting) machine (keyboard)
- 33 paper tower
- 34 paper ribbon
- 35 justifying scale
- 36 unit indicator
- 37 keyboard
- 38 compressed-air hose
- 39 monotype casting machine (monotype caster)
- 40 automatic metal feeder
- 41 pump compression spring (pump pressure spring)
- 42 matrix case (die case)
- 43 paper tower
- 44 galley with types (letters, characters, cast single types, cast single letters)
- 45 electric heater (electric heating unit)
- 46 matrix case (die case)
- 47 type matrices (matrixes) (letter matrixes)
- 48 guide block for engaging with the cross-slide guide

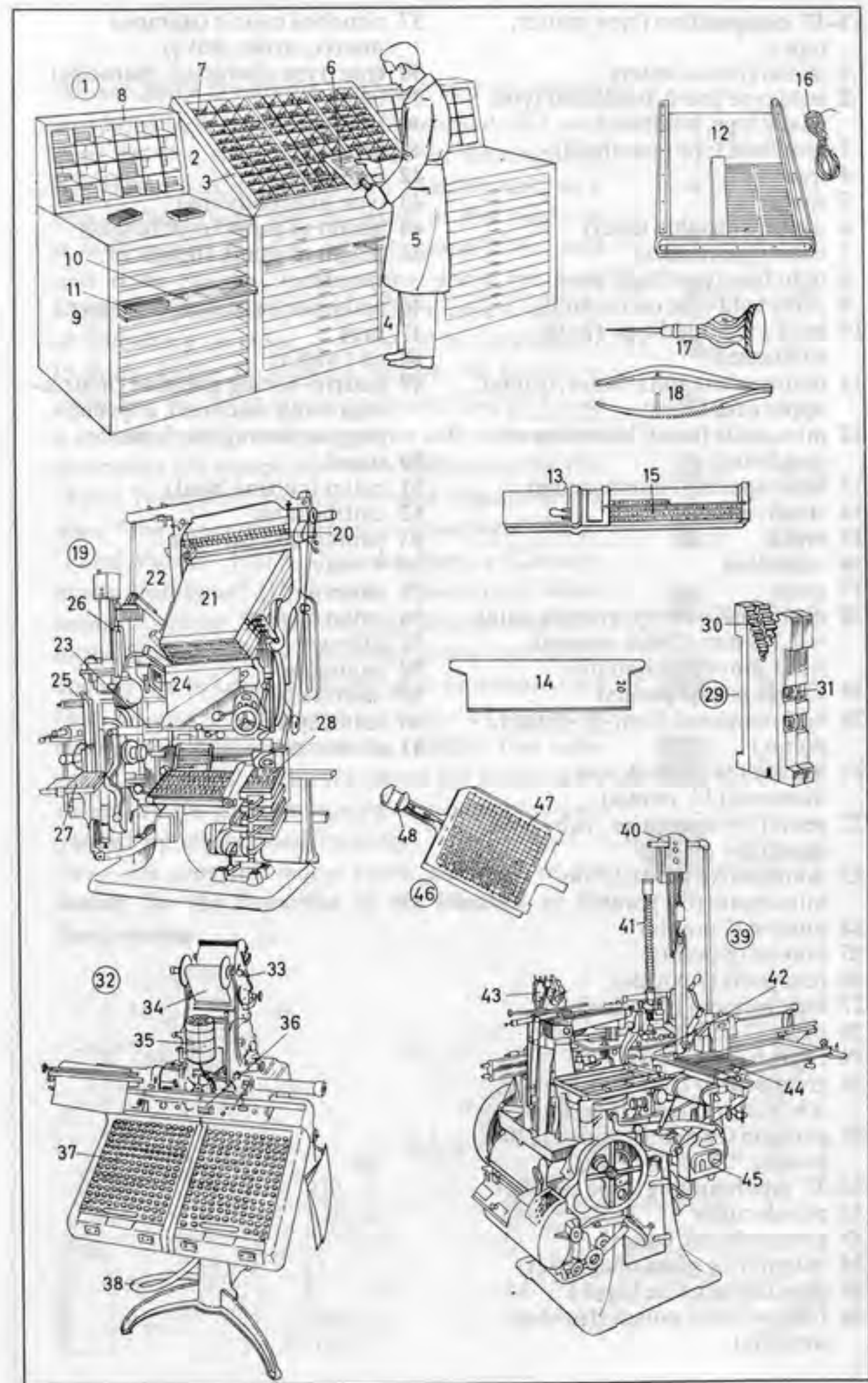



- 1-17 **composition** (type matter, type)
- 1 initial (initial letter)
- 2 bold type (bold, boldfaced type, heavy type, boldface)
- 3 semibold type (semibold)
- 4 line
- 5 space
- 6 ligature (double letter)
- 7 italic type (italics)
- 8 light face type (light face)
- 9 extra bold type (extra bold)
- 10 bold condensed type (bold condensed)
- 11 majuscule (capital letter, capital, upper case letter)
- 12 minuscule (small letter, lower case letter)
- 13 letter spacing (interspacing)
- 14 small capitals
- 15 break
- 16 indention
- 17 space
- 18 **type sizes** [one typographic point = 0.376 mm (Didot system), 0.351 mm (Pica system)]
- 19 six-to-pica (2 points)
- 20 half nonpareil (four-to-pica) (3 points)
- 21 brilliant (4 points); *sim.*: diamond (4½ points)
- 22 pearl (5 points); *sim.*: ruby (*Am.* agate) (5½ points)
- 23 nonpareil (6 points); *sim.*: minionette (6½ points)
- 24 minion (7 points)
- 25 brevier (8 points)
- 26 bourgeois (9 points)
- 27 long primer (10 points)
- 28 pica (12 points)
- 29 english (14 points)
- 30 great primer (two-line brevier, *Am.* Columbian) (16 points)
- 31 paragon (two-line primer) (20 points)
- 32-37 **typefounding** (type casting)
- 32 punch cutter
- 33 graver (burin, cutter)
- 34 magnifying glass (magnifier)
- 35 punch blank (die blank)
- 36 finished steel punch (finished steel die)

- 37 punched matrix (stamped matrix, strike, drive)
- 38 **type** (type character, character)
- 39 head
- 40 shoulder
- 41 counter
- 42 face (type face)
- 43 type line (bodyline)
- 44 height to paper (type height)
- 45 height of shank (height of shoulder)
- 46 body size (type size, point size)
- 47 nick
- 48 set (width)
- 49 **matrix-boring machine** (matrix-engraving machine), a special-purpose boring machine
- 50 stand
- 51 cutter (cutting head)
- 52 cutting table
- 53 pantograph carriage
- 54 V-way
- 55 pattern
- 56 pattern table
- 57 follower
- 58 pantograph
- 59 matrix clamp
- 60 cutter spindle
- 61 drive motor

1 Alfred John Dodsley, essayist and journalist, 4 was born in Wenlock on the 5th August 1841 and died on the 4th October 1920 in Birmingham. His father was a journeyman thatcher and as a 5 boy Dodsley was sent to work in the fields as a bird-scarer. Having taught himself to read and write fluently — for many years the only 6 books he possessed were a Bible and a volume of Tillotson's sermons — he went to Shrewsbury to study. Living in extreme poverty he began to write for the EAST HEREFORDSHIRE GAZETTE and a collection of his essays together with some poems on country life was published in 1868 under the title "Rural Thoughts". Among his most popular works were "The Diary of a Derbyshire Shepherd" (1872), "Rural Verses" (1879), "Leaves from a Countryman's Notebook" (1893) and "Memoirs of Nineteenth Century Shropshire", published posthumously. Dodsley also contributed many articles on country life to London papers and championed 13 the cause of the agricultural worker during the depression of the 1880's. The latter 11 years of his life were embittered by controversy 12 raised by his protests against the unemployment caused by mechanised farming. 15

16— He was for many years president of the Society for the Protection of the Liberties of the Farm-worker. 10 17

- 19
- 20 (18)
- 21 N n
- 22 N n
- 23 N n
- 24 N n
- 25 N n
- 26 N n
- 27 N n
- 28 N n
- 29 N n
- 30 N n
- 31 N n

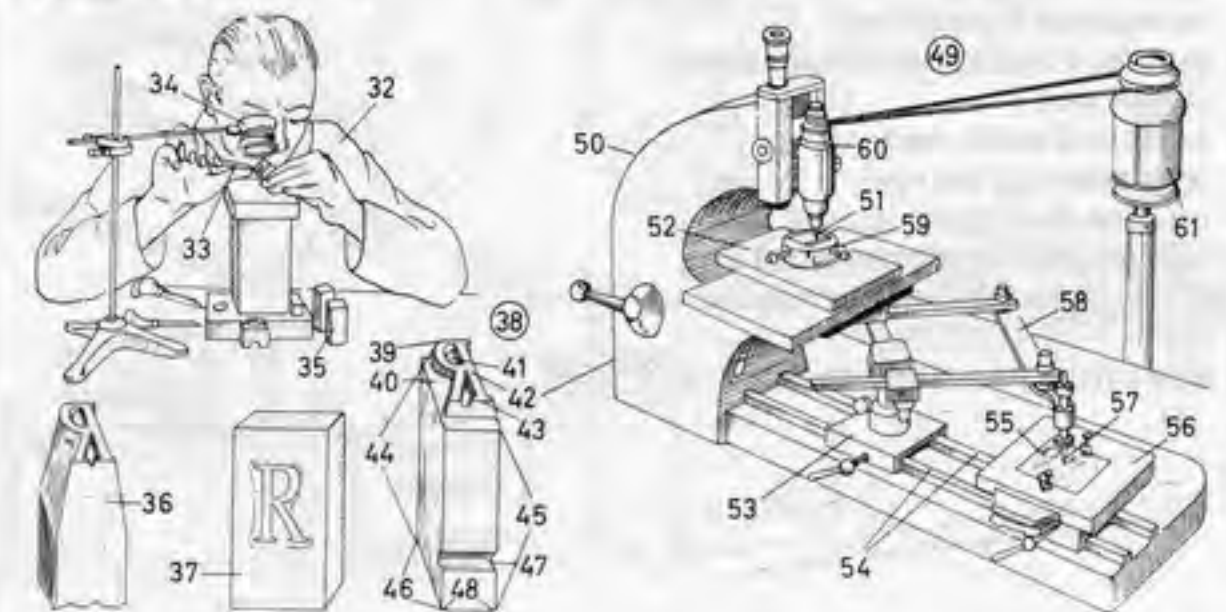



**176 Composing Room (Case Room) III (Phototypesetting, Photocomposition, Photosetting, Filmsetting)**

- 1 keyboard console (keyboard unit) for phototypesetting
- 2 keyboard
- 3 manuscript (copy)
- 4 keyboard operator
- 5 tape punch (perforator)
- 6 punched tape (punch tape)
- 7 filmsetter
- 8 punched tape (punch tape)
- 9 exposure control device
- 10 typesetting computer
- 11 memory unit (storage unit)
- 12 punched tape (punch tape)
- 13 punched tape (punch tape) reader
- 14 photo-unit (photographic unit) for computer-controlled typesetting (composition)
- 15 punched tape (punch tape) reader
- 16 type matrices (matrixes) (letter matrices)
- 17 matrix case (film matrix case)
- 18 guide block
- 19 synchronous motor
- 20 type disc (disk) (matrix disc)
- 21 mirror assembly
- 22 optical wedge
- 23 lens
- 24 mirror system
- 25 film
- 26 flash tubes
- 27 matrix drum
- 28 automatic film copier
- 29 central processing unit of a photocomposition system (photosetting system) for newspaper typesetting
- 30 punched tape (punch tape) input (input unit)
- 31 keyboard send-receive teleprinter (Teletype)
- 32 on-line disc (disk) storage unit
- 33 alphanumeric (alphameric) disc (disk) store (alphanumeric disc file)
- 34 disc (disk) stack (disc pack)

**Composing Room (Case Room) III (Phototypesetting, 176 Photocomposition, Photosetting, Filmsetting)**

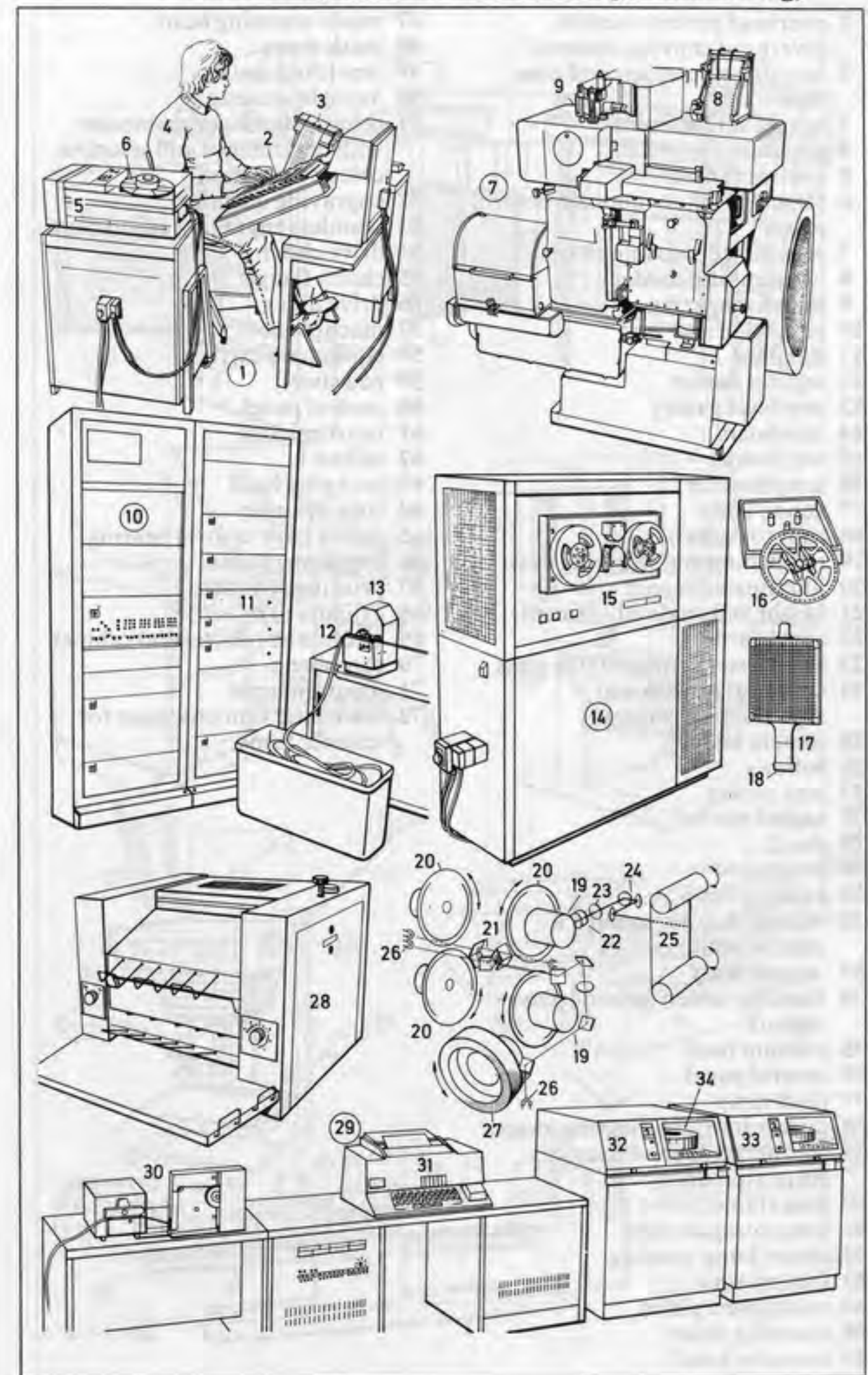



- 1 overhead process camera  
(overhead copying camera)
- 2 focusing screen (ground glass  
screen)
- 3 hinged screen holder
- 4 graticule
- 5 control console
- 6 hinged bracket-mounted control  
panel
- 7 percentage focusing charts
- 8 vacuum film holder
- 9 screen magazine
- 10 bellows
- 11 standard
- 12 register device
- 13 overhead gantry
- 14 copyboard
- 15 copyholder
- 16 lamp bracket
- 17 xenon lamp
- 18 copy (original)
- 19 retouching and stripping desk
- 20 illuminated screen
- 21 height and angle adjustment
- 22 copyboard
- 23 linen tester, a magnifying glass
- 24 universal process and  
reproduction camera
- 25 camera body
- 26 bellows
- 27 lens carrier
- 28 angled mirror
- 29 stand
- 30 copyboard
- 31 halogen lamp
- 32 vertical process camera, a  
compact camera
- 33 camera body
- 34 focusing screen (ground glass  
screen)
- 35 vacuum back
- 36 control panel
- 37 flash lamp
- 38 mirror for right-reading images
- 39 scanner (colour, *Am.* color,  
correction unit)
- 40 base frame
- 41 lamp compartment
- 42 xenon lamp housing
- 43 feed motors
- 44 transparency arm
- 45 scanning drum
- 46 scanning head
- 47 mask-scanning head
- 48 mask drum
- 49 recording space
- 50 daylight cassette
- 51 colour (*Am.* color) computer  
with control unit and selective  
colour correction
- 52 engraving machine
- 53 seamless engraving adjustment
- 54 drive clutch
- 55 clutch flange
- 56 drive unit
- 57 machine bed
- 58 equipment carrier
- 59 bed slide
- 60 control panel
- 61 bearing block
- 62 tailstock
- 63 scanning head
- 64 copy cylinder
- 65 centre (*Am.* center) bearing
- 66 engraving system
- 67 printing cylinder
- 68 cylinder arm
- 69 electronics (electronic) cabinet
- 70 computers
- 71 program input
- 72 automatic film processor for  
scanner films

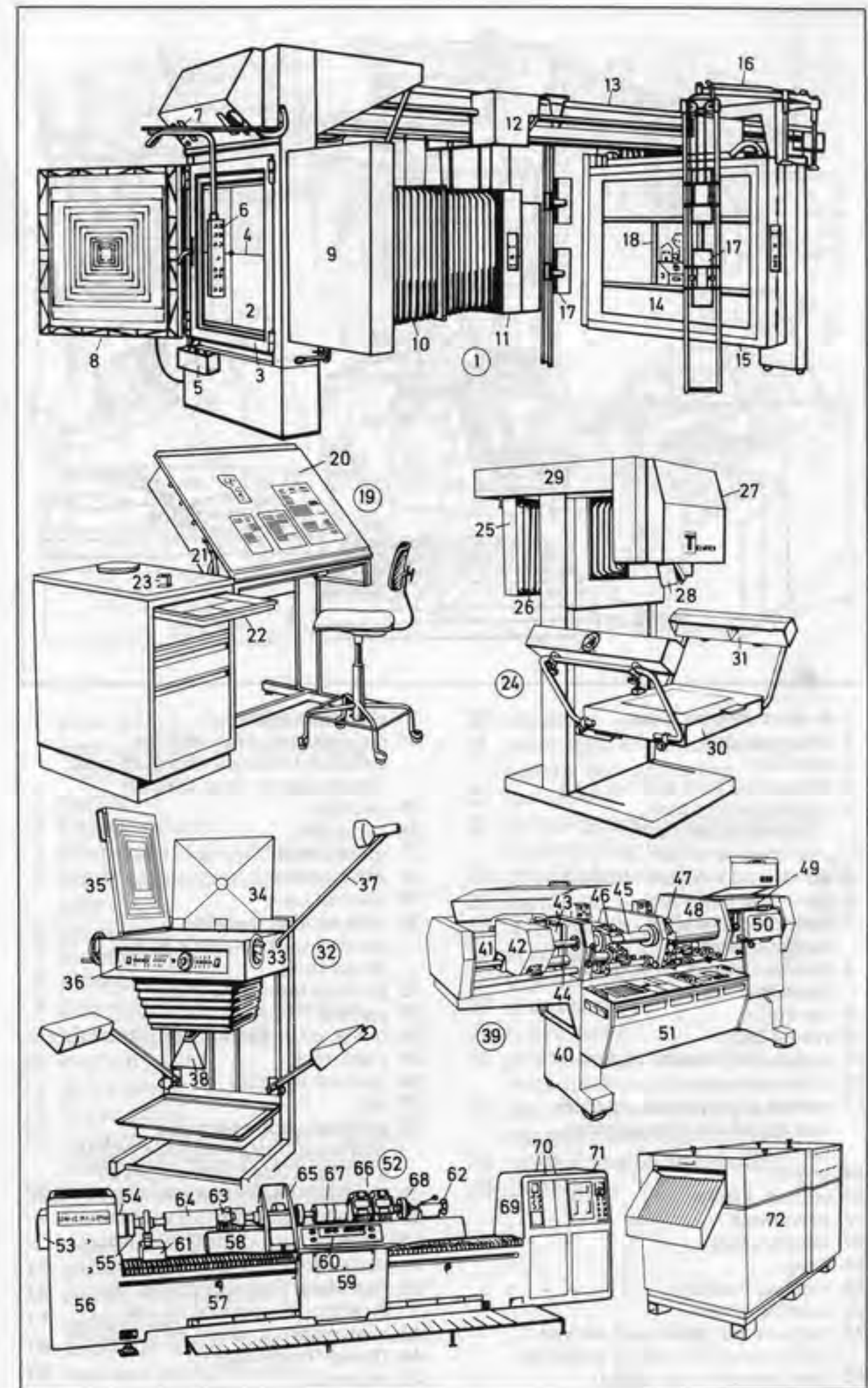

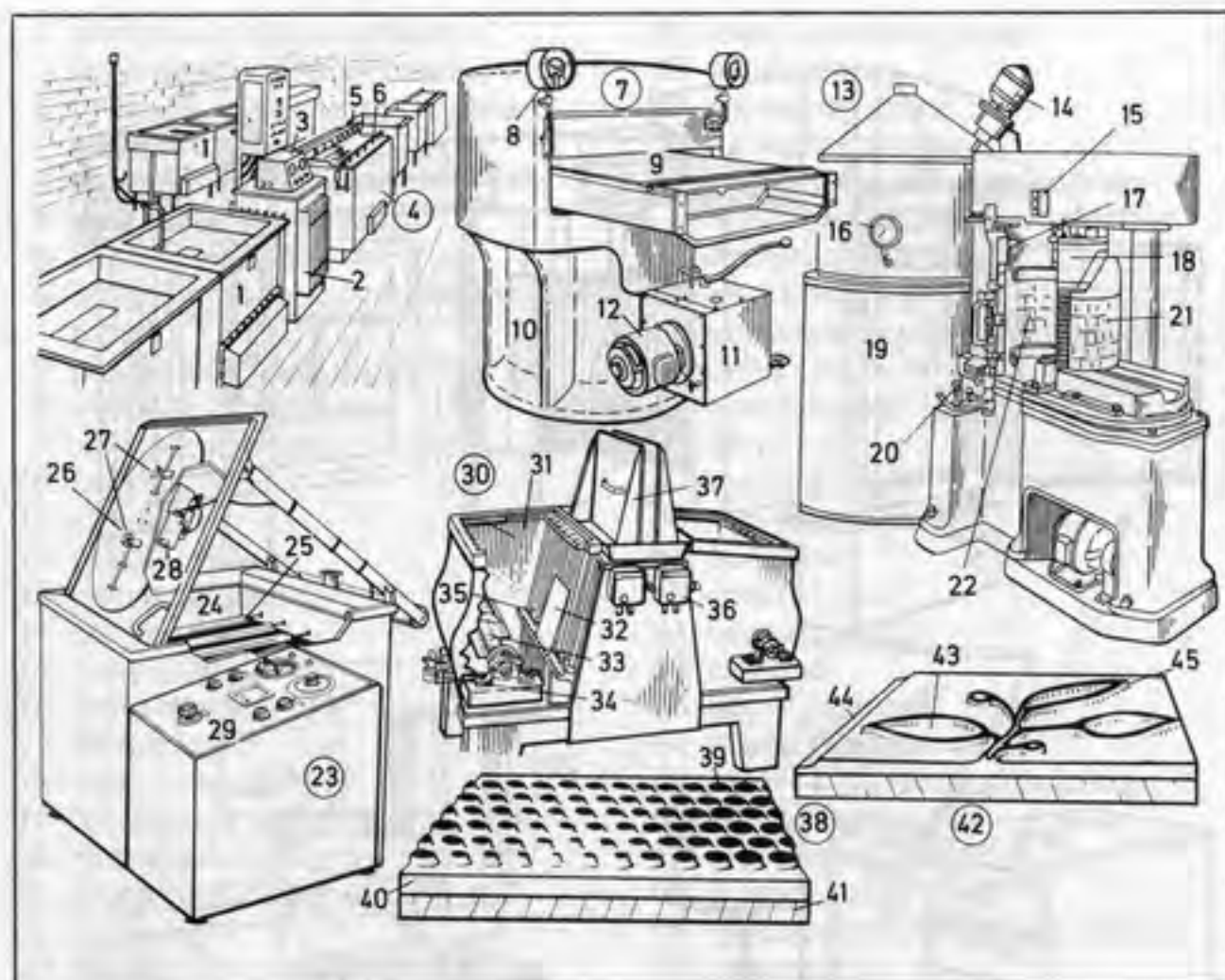

**1-6 electrotyping plant**

- 1 cleaning tank
- 2 rectifier
- 3 measuring and control unit
- 4 electroplating tank (electroplating bath, electroplating vat)
- 5 anode rod (copper anodes)
- 6 plate rod (cathode)
- 7 hydraulic moulding (*Am.* moulding) press
- 8 pressure gauge (*Am.* gage) (manometer)
- 9 apron
- 10 round base
- 11 hydraulic pressure pump
- 12 drive motor
- 13 curved plate casting machine (curved electrotype casting machine)
- 14 motor
- 15 control knobs
- 16 pyrometer
- 17 mouth piece
- 18 core
- 19 melting furnace
- 20 starting lever
- 21 cast curved plate (cast curved electrotype) for rotary printing
- 22 fixed mould (*Am.* mold)

**23 etching machine**

- 24 etching tank with etching solution (etchant, mordant) and filming agent (film former)
- 25 paddles
- 26 turntable
- 27 plate clamp
- 28 drive motor
- 29 control unit
- 30 twin etching machine
- 31 etching tank (etching bath) [in section]
- 32 photoprinted zinc plate
- 33 paddle
- 34 outlet cock (drain cock, *Am.* faucet)
- 35 plate rack
- 36 control switches
- 37 lid
- 38 half-tone photoengraving (half-tone block, half-tone plate), a block (plate, printing plate)
- 39 dot (half-tone dot), a printing element
- 40 etched zinc plate
- 41 block mount (block mounting, plate mount, plate mounting)
- 42 line block (line engraving, line etching, line plate, line cut)
- 43 non-printing, deep-etched areas
- 44 flange (bevel edge)
- 45 sidewall

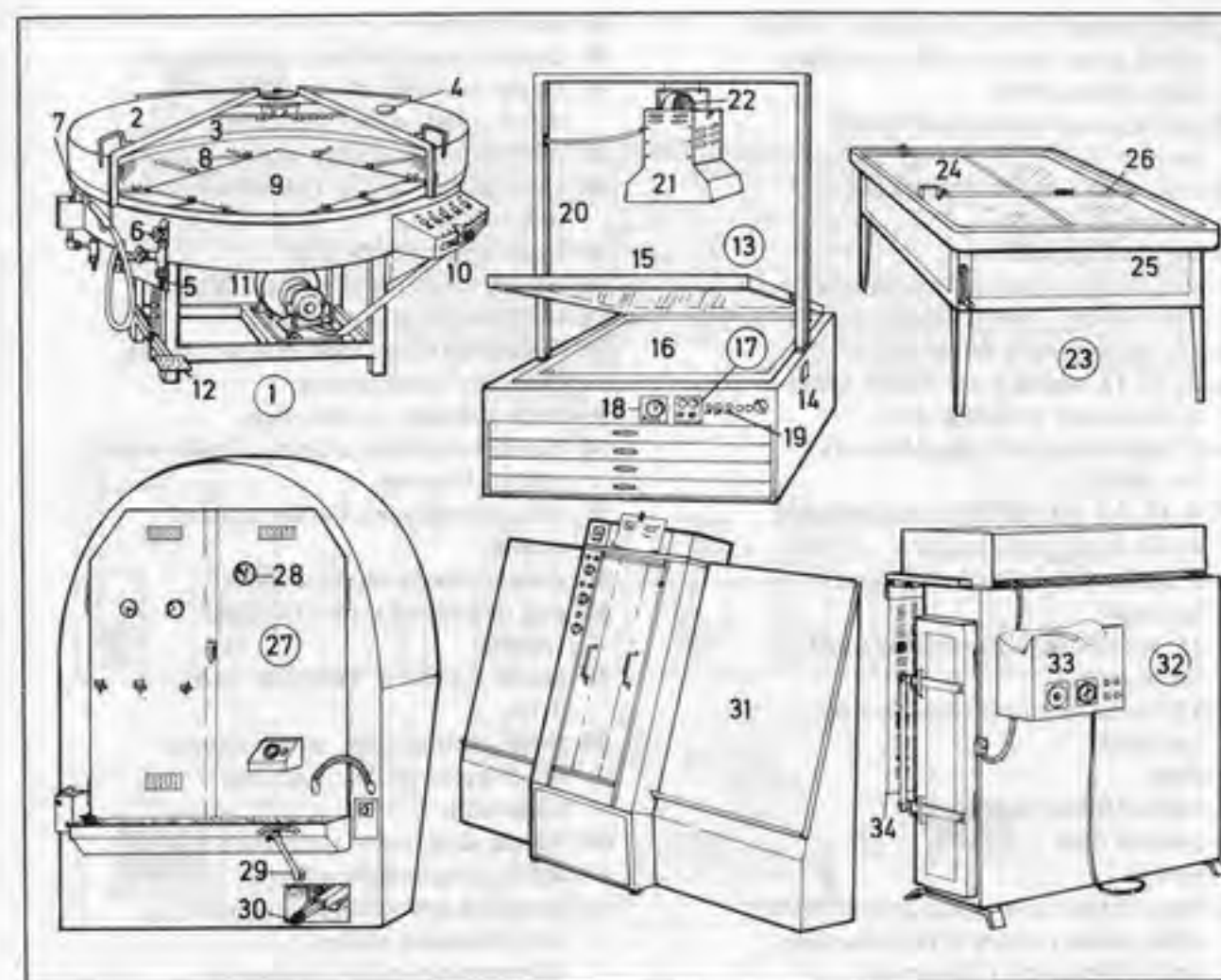

- 1 plate whirler (whirler, plate-coating machine) for coating offset plates
- 2 sliding lid
- 3 electric heater
- 4 temperature gauge (*Am.* gage)
- 5 water connection for the spray unit
- 6 spray unit
- 7 hand spray
- 8 plate clamps
- 9 zinc plate (*also:* magnesium plate, copper plate)
- 10 control panel
- 11 drive motor
- 12 brake pedal
- 13 vacuum printing frame (vacuum frame, printing-down frame)
- 14 base of the vacuum printing frame (vacuum frame, printing-down frame)
- 15 plate glass frame
- 16 coated offset plate
- 17 control panel
- 18 exposure timer
- 19 vacuum pump switch

- 20 support
- 21 point light exposure lamp, a quartz-halogen lamp
- 22 fan blower
- 23 stripping table (make-up table) for stripping films
- 24 crystal glass screen
- 25 light box
- 26 straightedge rules
- 27 vertical plate-drying cabinet
- 28 hygrometer
- 29 speed control
- 30 brake pedal
- 31 processing machine for presensitized plates
- 32 burning-in oven for glue-enamel plates (diaz plates)
- 33 control box (control unit)
- 34 diazo plate



- 1 four-colour (*Am.* four-color) rotary offset press (rotary offset machine, web-offset press)
- 2 roll of unprinted paper (blank paper)
- 3 reel stand (carrier for the roll of unprinted paper)
- 4 forwarding rolls
- 5 side margin control (margin control, side control, side lay control)
- 6-13 inking units (inker units)
- 6, 8, 10, 12 inking units (inker units) in the upper printing unit
- 6-7 perfecting unit (double unit) for yellow
- 7, 9, 11, 13 inking units (inker units) in the lower printing unit
- 8-9 perfecting unit (double unit) for cyan
- 10-11 perfecting unit (double unit) for magenta
- 12-13 perfecting unit (double unit) for black
- 14 drier
- 15 folder (folder unit)
- 16 control desk
- 17 sheet
- 18 four-colour (*Am.* four-color) rotary offset press (rotary offset machine, web-offset press) [diagram]
- 19 reel stand
- 20 side margin control (margin control, side control, side lay control)
- 21 inking rollers (ink rollers, inkers)
- 22 ink duct (ink fountain)
- 23 damping rollers (dampening rollers, dampers, dampeners)
- 24 blanket cylinder
- 25 plate cylinder
- 26 route of the paper (of the web)
- 27 drier
- 28 chilling rolls (cooling rollers, chill rollers)
- 29 folder (folder unit)
- 30 four-colour (*Am.* four-color) sheet-fed offset machine (offset press) [diagram]
- 31 sheet feeder (feeder)
- 32 feed table (feed board)
- 33 route of the sheets through swing-grippers to the feed drum
- 34 feed drum
- 35 impression cylinder
- 36 transfer drums (transfer cylinders)
- 37 blanket cylinder
- 38 plate cylinder
- 39 damping unit (dampening unit)
- 40 inking units (inker units)
- 41 printing unit
- 42 delivery cylinder
- 43 chain delivery

- 44 delivery pile
- 45 delivery unit (delivery mechanism)
- 46 single-colour (*Am.* single-color) offset press (offset machine)
- 47 pile of paper (sheets, printing paper)
- 48 sheet feeder (feeder), an automatic pile feeder
- 49 feed table (feed board)
- 50 inking rollers (ink rollers, inkers)
- 51 inking units (inker units)
- 52 damping rollers (dampening rollers, dampers, dampeners)
- 53 plate cylinder, a zinc plate
- 54 blanket cylinder, a steel cylinder with rubber blanket
- 55 pile delivery unit for the printed sheets
- 56 gripper bar, a chain gripper
- 57 pile of printed paper (printed sheets)
- 58 guard for the V-belt (vee-belt) drive
- 59 single-colour (*Am.* single-color) offset press (offset machine) [diagram]
- 60 inking unit (inker unit) with inking rollers (ink rollers, inkers)
- 61 damping unit (dampening unit) with damping rollers (dampening rollers, dampers, dampeners)
- 62 plate cylinder
- 63 blanket cylinder
- 64 impression cylinder
- 65 delivery cylinders with grippers
- 66 drive wheel
- 67 feed table (feed board)
- 68 sheet feeder (feeder)
- 69 pile of unprinted paper (blank paper, unprinted sheets, blank sheets)
- 70 small sheet-fed offset press
- 71 inking unit (inker unit)
- 72 suction feeder
- 73 pile feeder
- 74 instrument panel (control panel) with counter, pressure gauge (*Am.* gage), air regulator, and control switch for the sheet feeder (feeder)
- 75 flat-bed offset press (offset machine) ('Mailänder' proofing press, proof press)
- 76 inking unit (inker unit)
- 77 inking rollers (ink rollers, inkers)
- 78 bed (press bed, type bed, forme bed, *Am.* form bed)
- 79 cylinder with rubber blanket
- 80 starting and stopping lever for the printing unit
- 81 impression-setting wheel (impression-adjusting wheel)

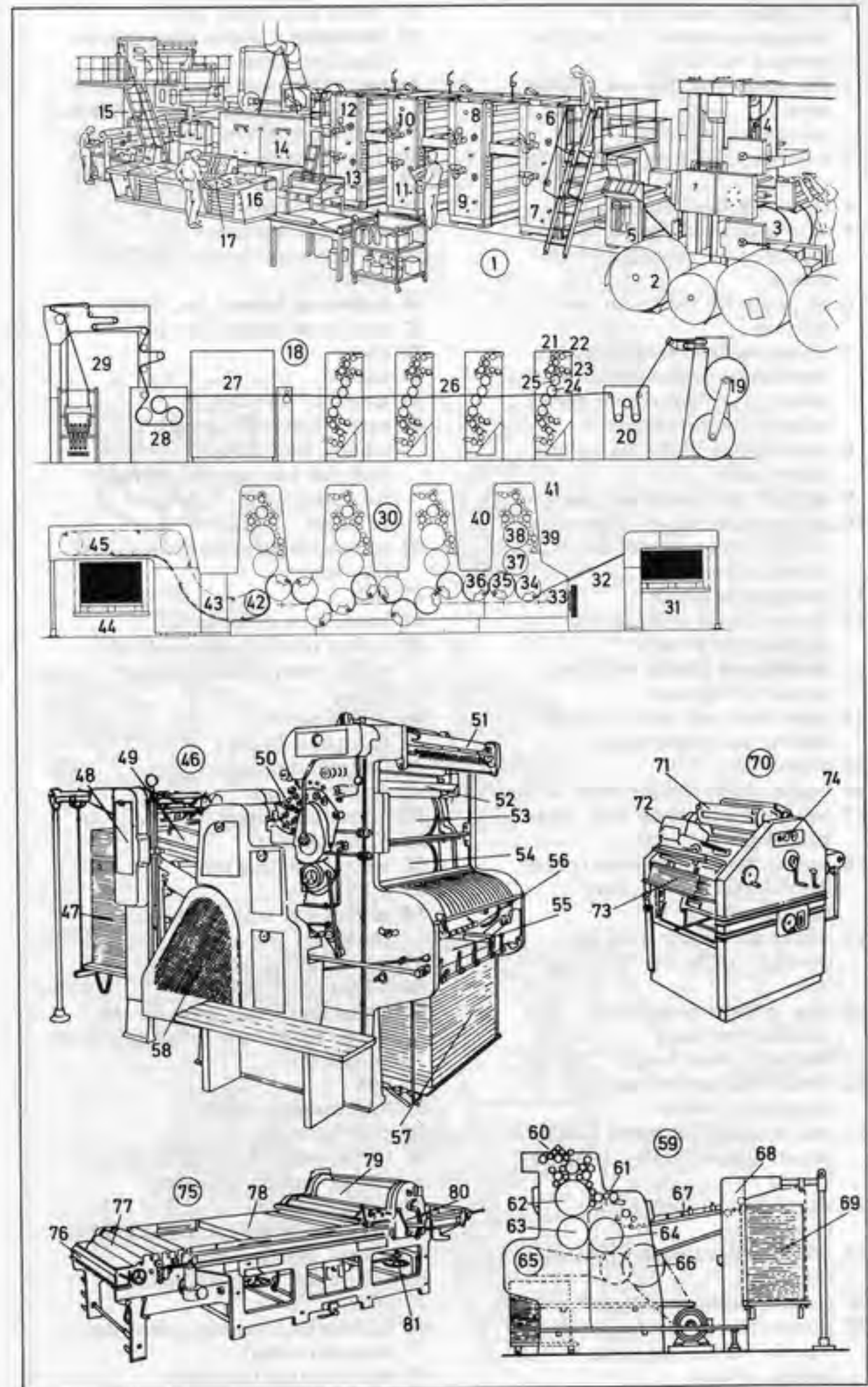



- 1-65 presses (machines) for letterpress printing (letterpress printing machines)
- 1 two-revolution flat-bed cylinder press
- 2 impression cylinder
- 3 lever for raising or lowering the cylinder
- 4 feed table (feed board)
- 5 automatic sheet feeder (feeder) [operated by vacuum and air blasts]
- 6 air pump for the feeder and delivery
- 7 inking unit (inker unit) with distributing rollers (distributor rollers, distributors) and forme rollers (*Am. form rollers*)
- 8 ink slab (ink plate) inking unit (inker unit)
- 9 delivery pile for printed paper
- 10 sprayer (anti set-off apparatus, anti set-off spray) for dusting the printed sheets
- 11 interleaving device
- 12 foot pedal for starting and stopping the press
- 13 platen press (platen machine, platen) [in section]
- 14 paper feed and delivery (paper feeding and delivery unit)
- 15 platen
- 16 toggle action (toggle-joint action)
- 17 bed (type bed, press bed, forme bed, *Am. form bed*)
- 18 forme rollers (*Am. form rollers*) (forme-inking, *Am. form-inking, rollers*)
- 19 inking unit (inker unit) for distributing the ink (printing ink)
- 20 stop-cylinder press (stop-cylinder machine)
- 21 feed table (feed board)
- 22 feeder mechanism (feeding apparatus, feeder)
- 23 pile of unprinted paper (blank paper, unprinted sheets, blank sheets)
- 24 guard for the sheet feeder (feeder)
- 25 pile of printed paper (printed sheets)
- 26 control mechanism
- 27 forme rollers (*Am. form rollers*) (forme-inking, *Am. form-inking, rollers*)

- 28 inking unit (inker unit)
- 29 [Heidelberg] platen press (platen machine, platen)
- 30 feed table (feed board) with pile of unprinted paper (blank paper, unprinted sheets, blank sheets)
- 31 delivery table
- 32 starting and stopping lever
- 33 delivery blower
- 34 spray gun (sprayer)
- 35 air pump for vacuum and air blasts
- 36 locked-up forme (*Am. form*)
- 37 type (type matter, matter)
- 38 chase
- 39 quoin
- 40 length of furniture
- 41 rotary letterpress press (rotary letterpress machine, web-fed letterpress machine) for newspapers of up to 16 pages
- 42 slitters for dividing the width of the web
- 43 web
- 44 impression cylinder
- 45 jockey roller (compensating roller, compensator, tension roller)
- 46 roll of paper
- 47 automatic brake
- 48 first printing unit
- 49 perfecting unit
- 50 inking unit (inker unit)
- 51 plate cylinder
- 52 second printing unit
- 53 former
- 54 tachometer with sheet counter
- 55 folder (folder unit)
- 56 folded newspaper
- 57 inking unit (inker unit) for the rotary press (web-fed press) [in section]
- 58 web
- 59 impression cylinder
- 60 plate cylinder
- 61 forme rollers (*Am. form rollers*) (forme-inking, *Am. form-inking, rollers*)
- 62 distributing rollers (distributor rollers, distributors)
- 63 lifter roller (ductor, ductor roller)
- 64 duct roller (fountain roller, ink fountain roller)
- 65 ink duct (ink fountain)

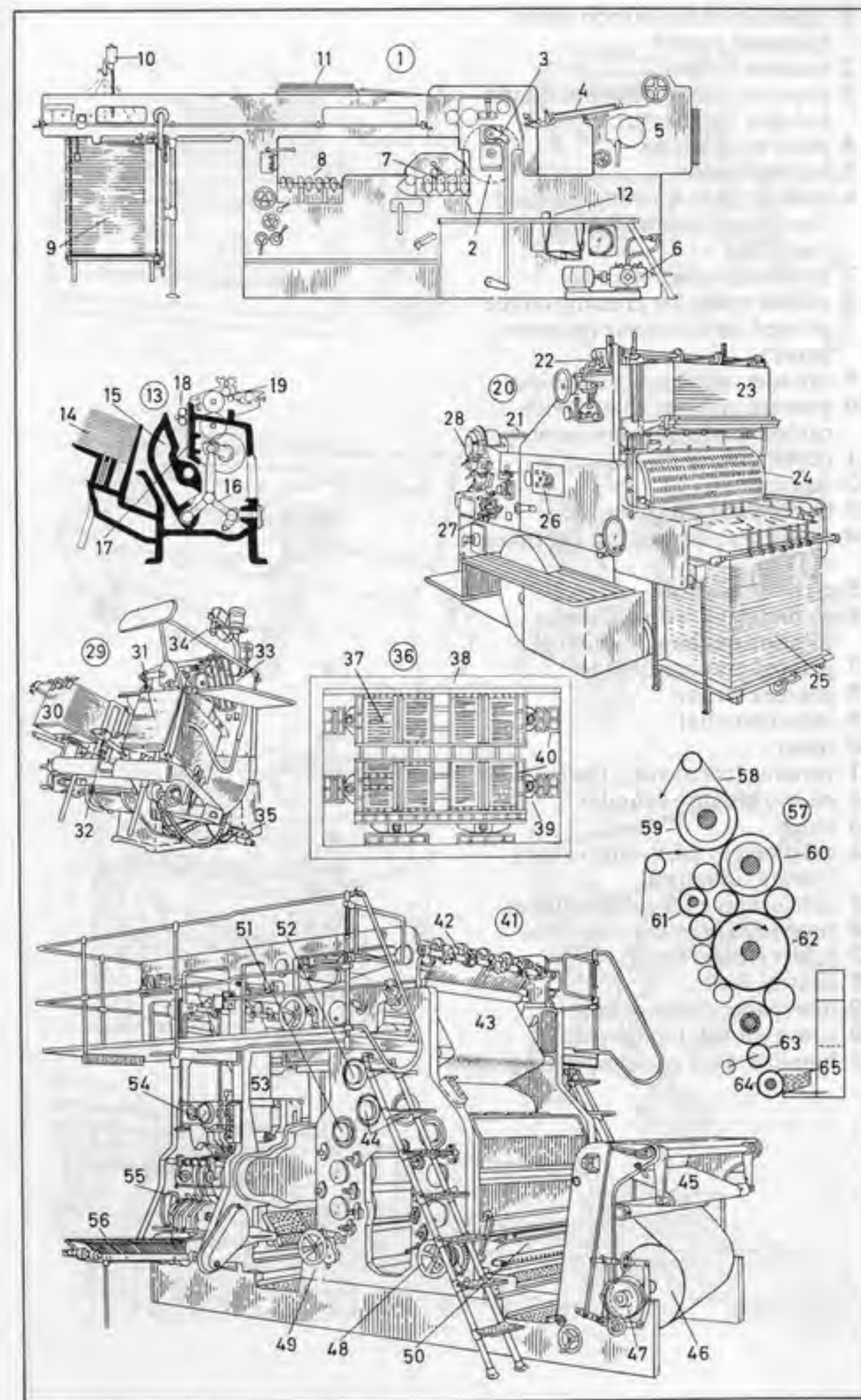



- 1 exposure of the carbon tissue (pigment paper)
- 2 vacuum frame
- 3 exposing lamp, a bank of quartz-halogen lamps
- 4 point source lamp
- 5 heat extractor
- 6 carbon tissue transfer machine (laydown machine, laying machine)
- 7 polished copper cylinder
- 8 rubber roller for pressing on the printed carbon tissue (pigment paper)
- 9 cylinder-processing machine
- 10 gravure cylinder coated with carbon tissue (pigment paper)
- 11 developing tank
- 12 staging
- 13 developed cylinder
- 14 retoucher painting out (stopping out)
- 15 etching machine
- 16 etching tank with etching solution (etchant, mordant)
- 17 printed gravure cylinder
- 18 gravure etcher
- 19 calculator dial
- 20 timer
- 21 revising (correcting) the cylinder
- 22 etched gravure cylinder
- 23 ledge
- 24 multicolour (*Am.* multicolor) rotogravure press
- 25 exhaust pipe for solvent fumes
- 26 reversible printing unit
- 27 folder (folder unit)
- 28 control desk
- 29 newspaper delivery unit
- 30 conveyor belt (conveyor)
- 31 bundled stack of newspapers

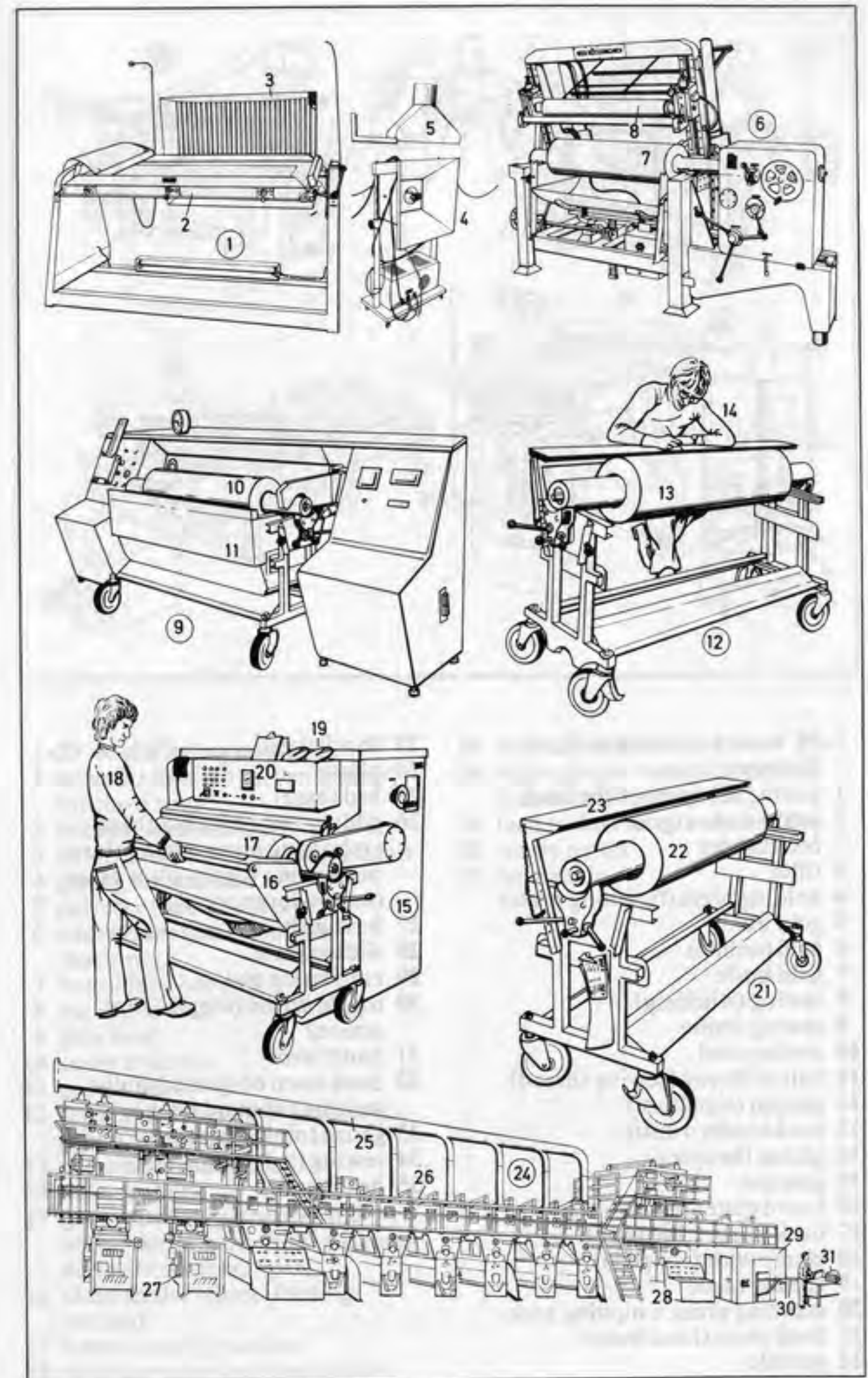



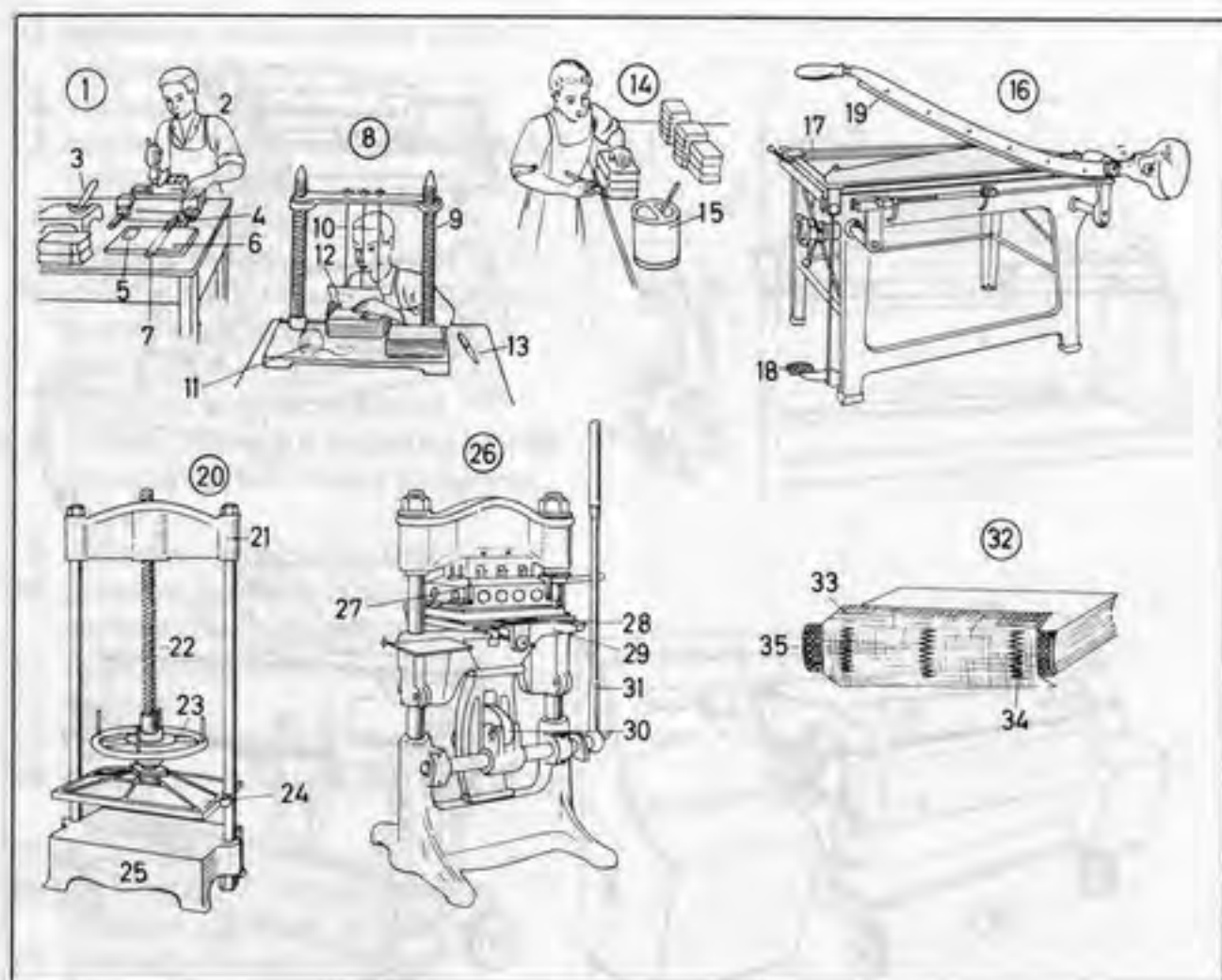

- 1-35 hand bookbindery (hand bindery)**
- 1 gilding the spine of the book
  - 2 gold finisher (gilder), a bookbinder
  - 3 fillet
  - 4 holding press (finishing press)
  - 5 gold leaf
  - 6 gold cushion
  - 7 gold knife
  - 8 sewing (stitching)
  - 9 sewing frame
  - 10 sewing cord
  - 11 ball of thread (sewing thread)
  - 12 section (signature)
  - 13 bookbinder's knife
  - 14 gluing the spine
  - 15 glue pot
  - 16 board cutter (guillotine)
  - 17 back gauge (*Am. gage*)
  - 18 clamp with foot pedal
  - 19 cutting blade
  - 20 standing press, a nipping press
  - 21 head piece (head beam)
  - 22 spindle
  - 23 handwheel
  - 24 platen
  - 25 bed (base)
  - 26 gilding (gold blocking) and embossing press, a hand-lever press; *sim.*: toggle-joint press (toggle-lever press)
  - 27 heating box
  - 28 sliding plate
  - 29 embossing platen
  - 30 toggle action (toggle-joint action)
  - 31 hand lever
  - 32 book sewn on gauze (mull, scrim) (unbound book)
  - 33 gauze (mull, scrim)
  - 34 sewing (stitching)
  - 35 headband

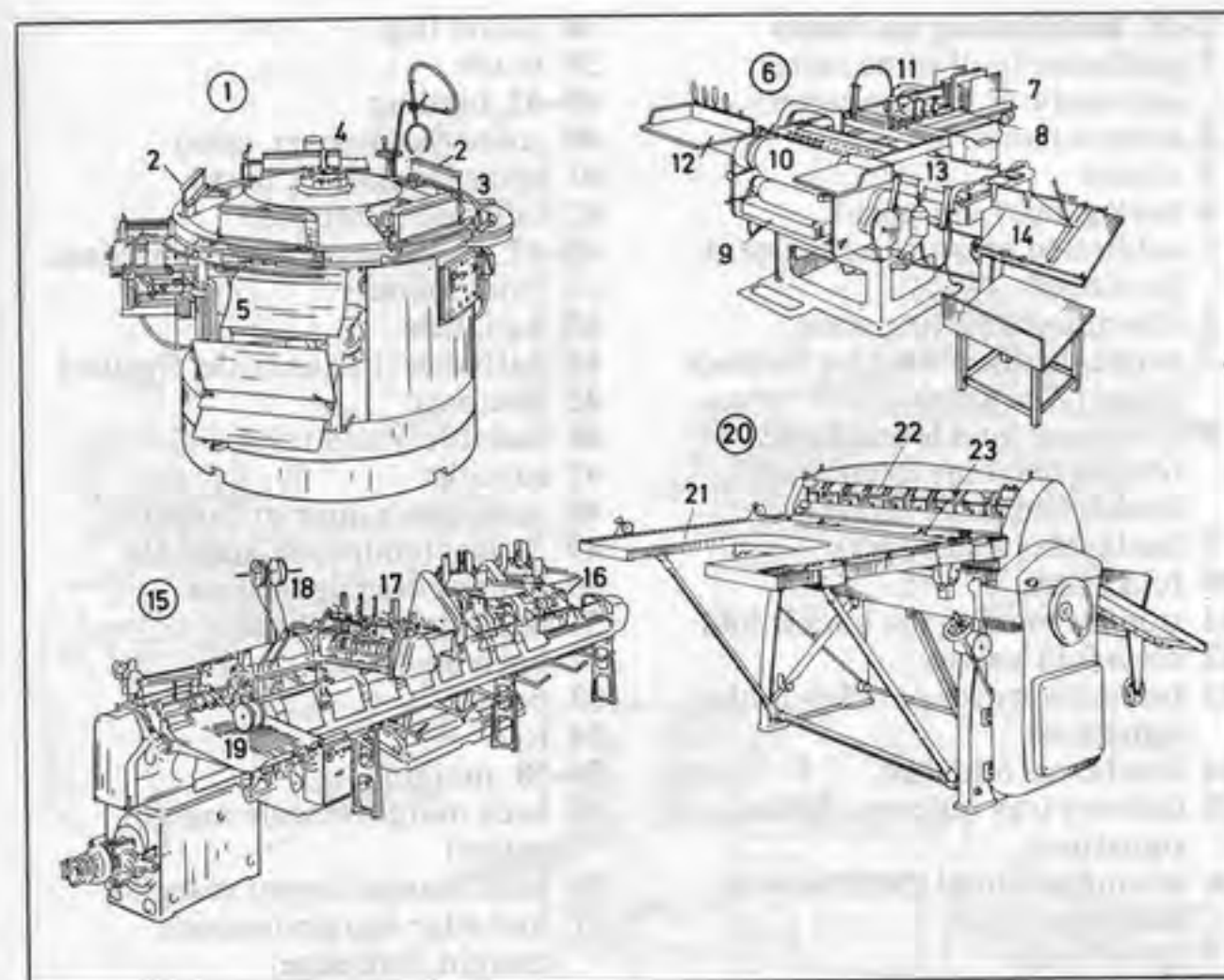

- 1-23 bookbinding machines**
- 1 **adhesive binder** (perfect binder) for short runs
  - 2 manual feed station
  - 3 cutoff knife and roughing station
  - 4 gluing mechanism
  - 5 delivery (book delivery)
  - 6 **case maker** (case-making machine)
  - 7 board feed hopper
  - 8 pickup sucker
  - 9 glue tank
  - 10 cover cylinder
  - 11 picker head
  - 12 feed table for covering materials [linen, paper, leather]
  - 13 pressing mechanism
  - 14 delivery table
  - 15 **gang stitcher** (gathering and wire-stitching machine, gatherer and wire stitcher)
  - 16 sheet feeder (sheet-feeding station)
  - 17 folder-feeding station
  - 18 stitching wire feed mechanism
  - 19 delivery table
  - 20 **rotary board cutter** (rotary board-cutting machine)
  - 21 feed table with cut-out section
  - 22 rotary cutter
  - 23 feed guide



**1-35 bookbinding machines**

- 1 guillotine (guillotine cutter, automatic guillotine cutter)
- 2 control panel
- 3 clamp
- 4 back gauge (*Am. gage*)
- 5 calibrated pressure adjustment [to clamp]
- 6 illuminated cutting scale
- 7 single-hand control for the back gauge (*Am. gage*)
- 8 combined buckle and knife folding machine (combined buckle and knife folder)
- 9 feed table (feed board)
- 10 fold plates
- 11 stop for making the buckle fold
- 12 cross fold knives
- 13 belt delivery for parallel-folded signatures
- 14 third cross fold unit
- 15 delivery tray for cross-folded signatures
- 16 sewing machine (book-sewing machine)
- 17 spool holder
- 18 thread cop (thread spool)
- 19 gauze roll holder (mull roll holder, scrim roll holder)
- 20 gauze (mull, scrim)
- 21 needle cylinder with sewing needles
- 22 sewn book
- 23 delivery
- 24 reciprocating saddle
- 25 sheet feeder (feeder)
- 26 feed hopper
- 27 casing-in machine
- 28 joint and side pasting attachment
- 29 blade
- 30 preheater unit
- 31 gluing machine for whole-surface, stencil, edge, and strip gluing
- 32 glue tank
- 33 glue roller
- 34 feed table
- 35 delivery
- 36 **book**
- 37 dust jacket (dust cover, bookjacket, wrapper), a publisher's wrapper

- 38 jacket flap
- 39 blurb
- 40-42 **binding**
- 40 cover (book cover, case)
- 41 spine (backbone, back)
- 42 tailband (footband)
- 43-47 preliminary matter (prelims, front matter)
- 43 half-title
- 44 half-title (bastard title, fly title)
- 45 title page
- 46 full title (main title)
- 47 subtitle
- 48 publisher's imprint (imprint)
- 49 fly leaf (endpaper, endleaf)
- 50 handwritten dedication
- 51 bookplate (ex libris)
- 52 open book
- 53 page
- 54 fold
- 55-58 **margin**
- 55 back margin (inside margin, gutter)
- 56 head margin (upper margin)
- 57 fore edge margin (outside margin, fore edge)
- 58 tail margin (foot margin, tail, foot)
- 59 type area
- 60 chapter heading
- 61 asterisk
- 62 footnote
- 63 page number
- 64 double-column page
- 65 column
- 66 running title (running head)
- 67 caption
- 68 marginal note (side note)
- 69 signature (signature code)
- 70 attached bookmark (attached bookmarker)
- 71 loose bookmark (loose bookmarker)

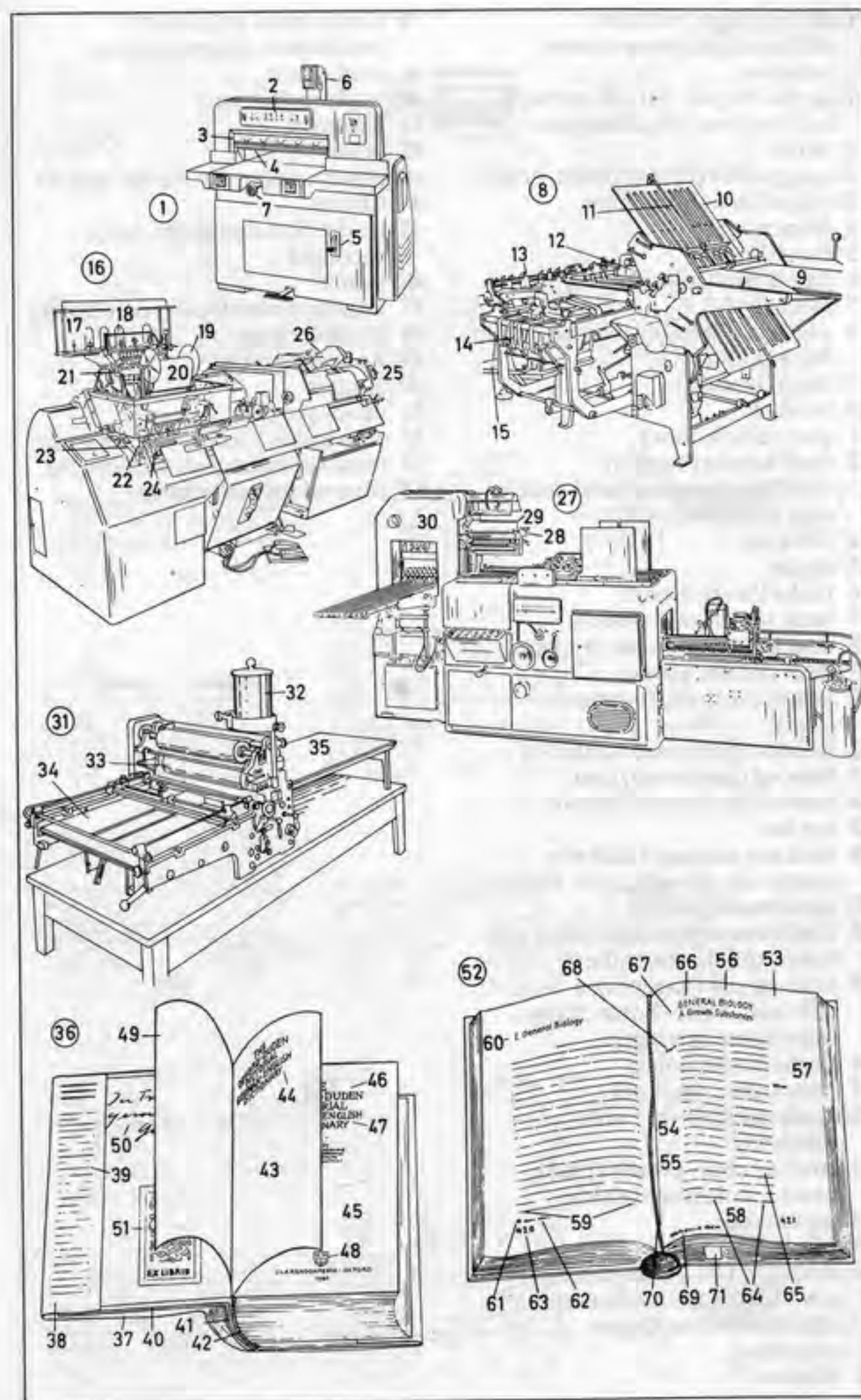



- 1-54 carriages (vehicles, conveyances, horse-drawn vehicles)
- 1-3, 26-39, 45, 51-54 carriages and coaches (coach wagons)
- 1 berlin
- 2 waggonette (*larger*: brake, break)
- 3 coupé; *sim.*: brougham
- 4 front wheel
- 5 coach body
- 6 dashboard (splashboard)
- 7 footboard
- 8 coach box (box, coachman's seat, driver's seat)
- 9 lamp (lantern)
- 10 window
- 11 door (coach door)
- 12 door handle (handle)
- 13 footboard (carriage step, coach step, step, footpiece)
- 14 fixed top
- 15 spring
- 16 brake (brake block)
- 17 back wheel (rear wheel)
- 18 dogcart, a one-horse carriage
- 19 shafts (thills, poles)
- 20 lackey (lacquey, footman)
- 21 livery
- 22 braided (gallooned) collar
- 23 braided (gallooned) coat
- 24 braided (gallooned) sleeve
- 25 top hat
- 26 hackney carriage (hackney coach, cab, growler, *Am.* hack)
- 27 stableman (groom)
- 28 coach horse (carriage horse, cab horse, thill horse, thiller)
- 29 hansom cab (hansom), a cabriolet, a one-horse chaise (one-horse carriage)
- 30 shafts (thills, poles)
- 31 reins (rein, *Am.* line)
- 32 coachman (driver) with inverness
- 33 covered char-a-banc (brake, break), a pleasure vehicle
- 34 gig (chaise)
- 35 barouche
- 36 landau, a two-horse carriage; *sim.*: landaulet, landalette
- 37 omnibus (horse-drawn omnibus)
- 38 phaeton
- 39 Continental stagecoach (mailcoach, diligence); *also*: road coach
- 40 mailcoach driver
- 41 posthorn
- 42 hood
- 43 post horses (relay horses, relays)
- 44 tilbury
- 45 troika (Russian three-horse carriage)
- 46 leader
- 47 wheeler (wheelhorse, pole horse)
- 48 English buggy
- 49 American buggy
- 50 tandem
- 51 vis-à-vis
- 52 collapsible hood (collapsible top)
- 53 mailcoach (English stagecoach)
- 54 covered (closed) chaise

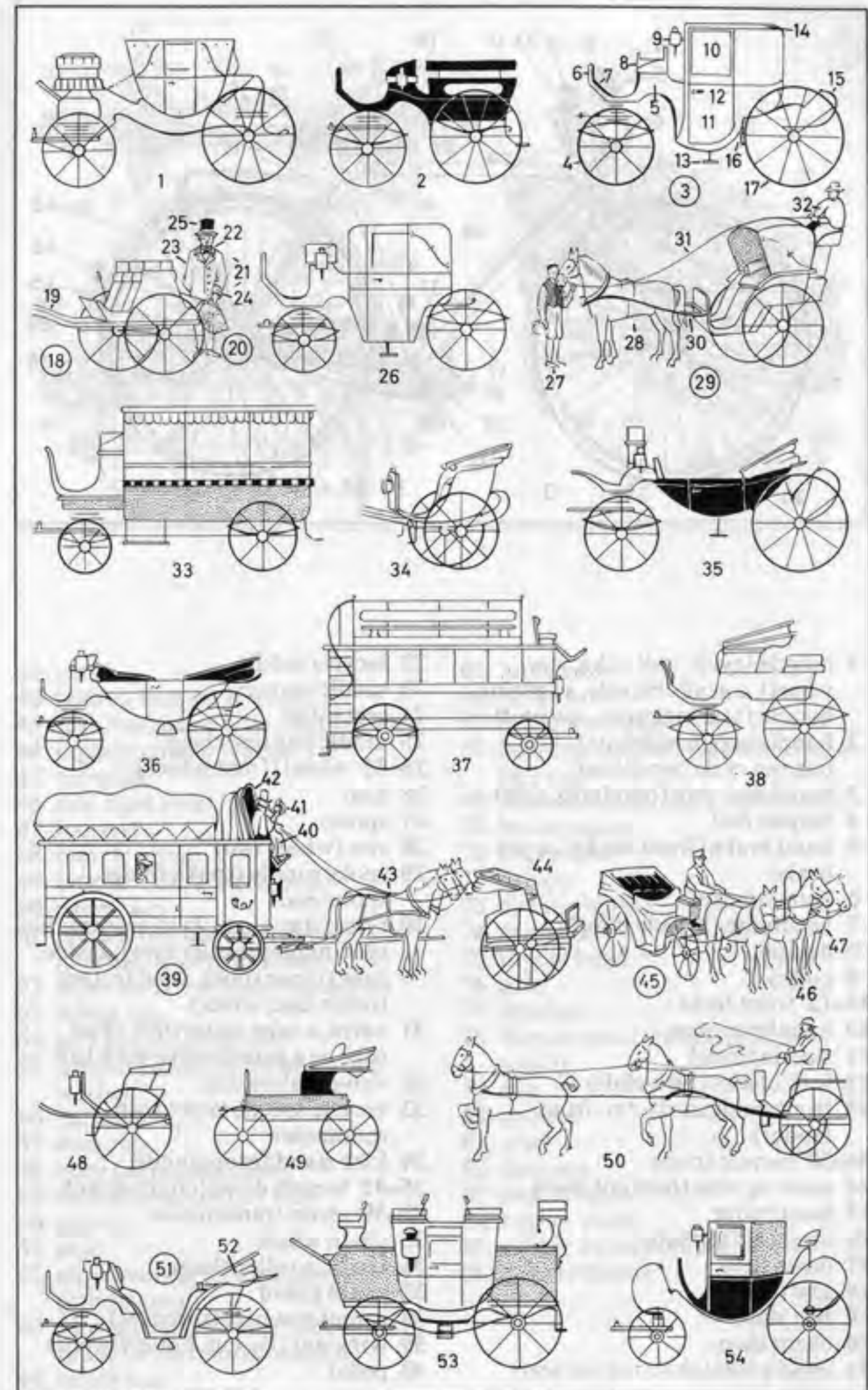



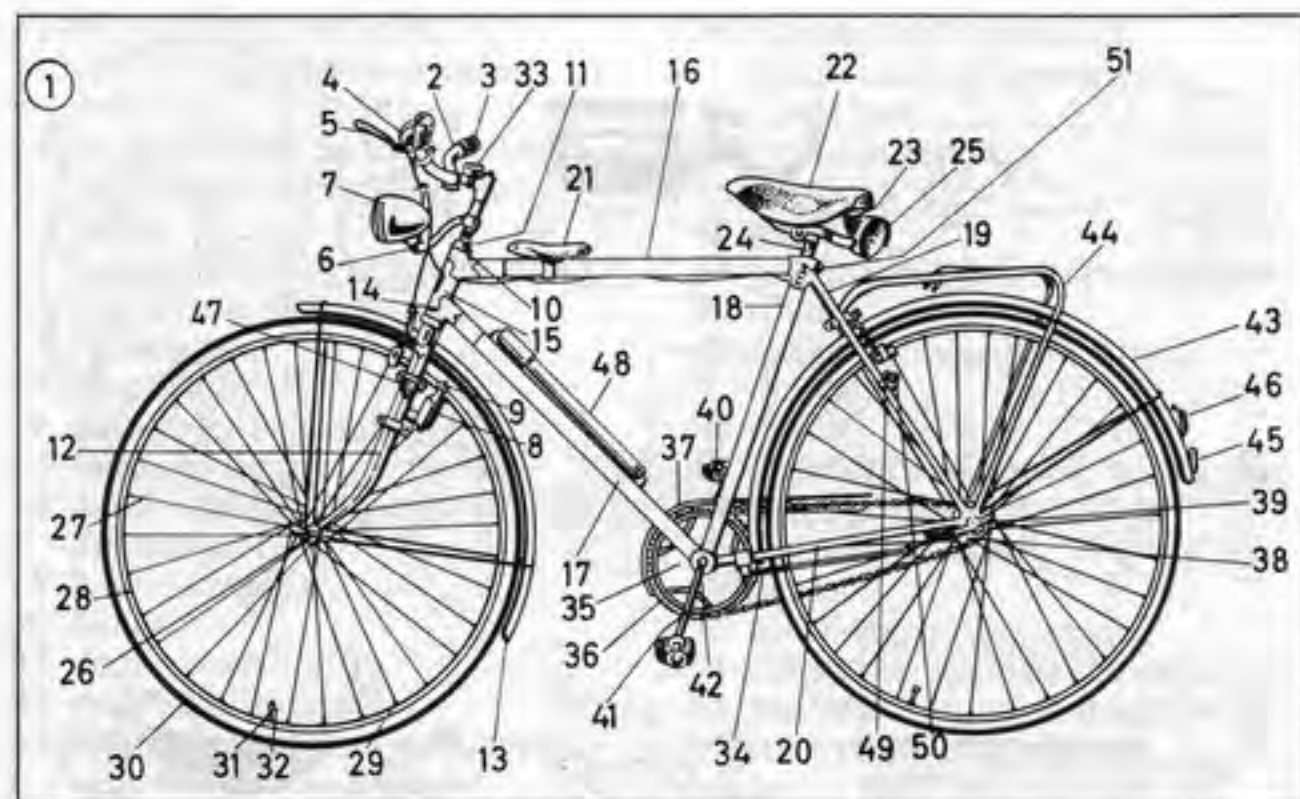

- |   |   |
|---|---|
| 1 bicycle (cycle, <i>coll.</i> bike, <i>Am.</i> wheel), a gent's bicycle, a touring bicycle (touring cycle, roadster) | 22 bicycle saddle   |
| 2 handlebar (handlebars), a touring cycle handlebar   | 23 saddle springs   |
| 3 handlebar grip (handgrip, grip)   | 24 seat pillar  |
| 4 bicycle bell  | 25 saddle bag (tool bag)  |
| 5 hand brake (front brake), a rim brake   | 26-32 wheel (front wheel)   |
| 6 lamp bracket  | 26 hub  |
| 7 headlamp (bicycle lamp)   | 27 spoke  |
| 8 dynamo  | 28 rim (wheel rim)  |
| 9 pulley  | 29 spoke nipple (spoke flange, spoke end)   |
| 10-12 front forks   | 30 tyres ( <i>Am.</i> tires) (tyre, pneumatic tyre, high-pressure tyre); <i>inside</i> : tube (inner tube), <i>outside</i> : tyre (outer case, cover) |
| 10 handlebar stem   | 31 valve, a tube valve with valve tube or a patent valve with ball  |
| 11 steering head  | 32 valve sealing cap  |
| 12 fork blades (fork ends)  | 33 bicycle speedometer with milometer   |
| 13 front mudguard ( <i>Am.</i> front fender)  | 34 kick stand (prop stand)  |
| 14-20 bicycle frame   | 35-42 bicycle drive (chain drive)   |
| 14 steering tube (fork column)  | 35-39 chain transmission  |
| 15 head badge   | 35 chain wheel  |
| 16 crossbar (top tube)  | 36 chain, a roller chain  |
| 17 down tube  | 37 chain guard  |
| 18 seat tube  | 38 sprocket wheel (sprocket)  |
| 19 seat stays   | 39 wing nut (fly nut, butterfly nut)  |
| 20 chain stays  | 40 pedal  |
| 21 child's seat (child carrier seat)  |   |

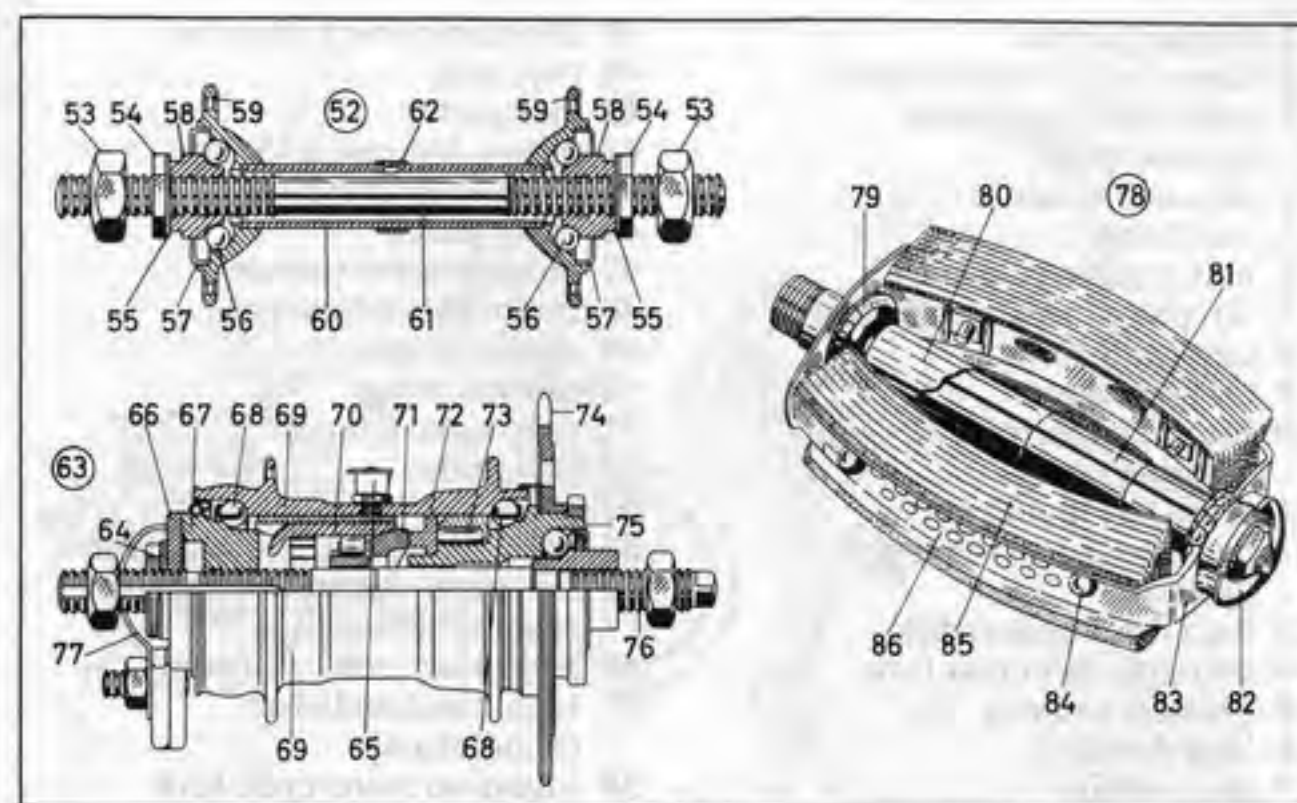

- |  |  |
|--|--|
| 41 crank   | 65 lubricator                                  |
| 42 bottom bracket bearing                                    | 66 brake arm                                   |
| 43 rear mudguard ( <i>Am.</i> rear fender)                   | 67 brake arm cone                              |
| 44 luggage carrier (carrier)                                 | 68 bearing cup with ball bearings in ball race |
| 45 reflector   | 69 hub shell (hub body, hub barrel)            |
| 46 rear light (rear lamp)                                    | 70 brake casing                                |
| 47 footrest  | 71 brake cone                                  |
| 48 bicycle pump  | 72 driver                                      |
| 49 bicycle lock, a wheel lock                                | 73 driving barrel                              |
| 50 patent key  | 74 sprocket                                    |
| 51 cycle serial number (factory number, frame number)        | 75 thread head                                 |
| 52 front hub (front hub assembly)                            | 76 axle  |
| 53 wheel nut   | 77 bracket                                     |
| 54 locknut (locking nut)                                     | 78 bicycle pedal (pedal, reflector pedal)      |
| 55 washer (slotted cone adjusting washer)                    | 79 cup   |
| 56 ball bearing  | 80 spindle                                     |
| 57 dust cap  | 81 axle  |
| 58 cone (adjusting cone)                                     | 82 dust cap                                    |
| 59 centre ( <i>Am.</i> center) hub                           | 83 pedal frame                                 |
| 60 spindle   | 84 rubber stud                                 |
| 61 axle  | 85 rubber block (rubber tread)                 |
| 62 clip covering lubrication hole (lubricator)               | 86 glass reflector                             |
| 63 free-wheel hub with back-pedal brake (with coaster brake) |  |
| 64 safety nut  |  |



- 1 folding bicycle
- 2 hinge (*also*: locking lever)
- 3 adjustable handlebar (handlebars)
- 4 adjustable saddle
- 5 stabilizers
- 6 motor-assisted bicycle
- 7 air-cooled two-stroke engine
- 8 telescopic forks
- 9 tubular frame
- 10 fuel tank (petrol tank, *Am.* gasoline tank)
- 11 semi-rise handlebars
- 12 two-speed gear-change (gearshift)
- 13 high-back polo saddle
- 14 swinging-arm rear fork
- 15 upswept exhaust
- 16 heat shield
- 17 drive chain
- 18 crash bar (roll bar)
- 19 speedometer (*coll. speedo*)
- 20 battery-powered moped, an electrically-powered vehicle
- 21 swivel saddle
- 22 battery compartment
- 23 wire basket
- 24 touring moped (moped)
- 25 pedal crank (pedal drive, starter pedal)
- 26 single-cylinder two-stroke engine
- 27 spark-plug cap
- 28 fuel tank (petrol tank, *Am.* gasoline tank)
- 29 moped headlamp (front lamp)
- 30-35 handlebar fittings
- 30 twist grip throttle control (throttle twist grip)
- 31 twist grip (gear-change, gearshift)
- 32 clutch lever
- 33 hand brake lever
- 34 speedometer (*coll. speedo*)
- 35 rear-view mirror (mirror)
- 36 front wheel drum brake (drum brake)
- 37 Bowden cables (brake cables)
- 38 stop and tail light unit
- 39 light motorcycle with kickstarter
- 40 housing for instruments with speedometer and electronic rev counter (revolution counter)

- 41 telescopic shock absorber
- 42 twin seat
- 43 kickstarter
- 44 pillion footrest, a footrest
- 45 handlebar (handlebars)
- 46 chain guard
- 47 motor scooter (scooter)
- 48 removable side panel
- 49 tubular frame
- 50 metal fairings
- 51 prop stand (stand)
- 52 foot brake
- 53 horn (hooter)
- 54 hook for handbag or briefcase
- 55 foot gear-change control (foot gearshift control)
- 56 high-riser; *sim.*: Chopper
- 57 high-rise handlebar (handlebars)
- 58 imitation motorcycle fork
- 59 banana saddle
- 60 chrome bracket

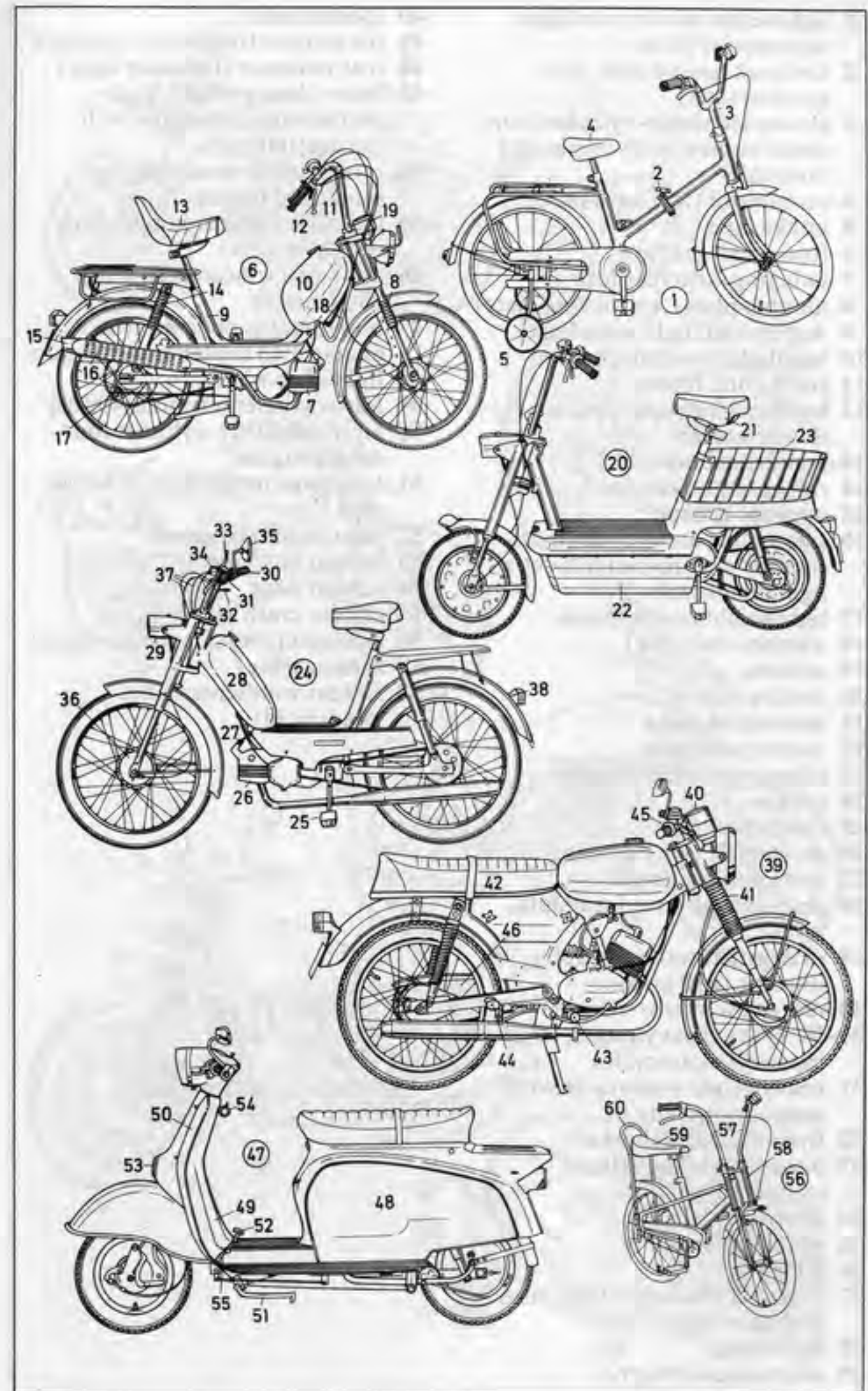



- 1 lightweight motorcycle (light motorcycle) [50 cc]
- 2 fuel tank (petrol tank, *Am.* gasoline tank)
- 3 air-cooled single-cylinder four-stroke engine (with overhead camshaft)
- 4 carburettor (*Am.* carburetor)
- 5 intake pipe
- 6 five-speed gearbox
- 7 swinging-arm rear fork
- 8 number plate (*Am.* license plate)
- 9 stop and tail light (rear light)
- 10 headlight (headlamp)
- 11 front drum brake
- 12 brake cable (brake line), a Bowden cable
- 13 rear drum brake
- 14 racing-style twin seat
- 15 upswept exhaust
- 16 scrambling motorcycle (cross-country motorcycle) [125 cc], a light motorcycle
- 17 lightweight cradle frame
- 18 number disc (disk)
- 19 solo seat
- 20 cooling ribs
- 21 motorcycle stand
- 22 motorcycle chain
- 23 telescopic shock absorber
- 24 spokes
- 25 rim (wheel rim)
- 26 motorcycle tyre (*Am.* tire)
- 27 tyre (*Am.* tire) tread
- 28 gear-change lever (gearshift lever)
- 29 twist grip throttle control (throttle twist grip)
- 30 rear-view mirror (mirror)
- 31-58 heavy (heavyweight, large-capacity) motorcycles
- 31 heavyweight motorcycle with water-cooled engine
- 32 front disc (disk) brake
- 33 disc (disk) brake calliper (caliper)
- 34 floating axle
- 35 water cooler
- 36 oil tank
- 37 indicator (indicator light, turn indicator light)
- 38 kickstarter
- 39 water-cooled engine
- 40 speedometer
- 41 rev counter (revolution counter)
- 42 rear indicator (indicator light)
- 43 heavy (heavyweight, high-performance) machine with fairing [1000 cc]
- 44 integrated streamlining, an integrated fairing
- 45 indicator (indicator light, turn indicator light)
- 46 anti-mist windscreen (*Am.* windshield)
- 47 horizontally-opposed twin engine with cardan transmission
- 48 light alloy wheel
- 49 four-cylinder machine [400 cc]
- 50 air-cooled four-cylinder four-stroke engine
- 51 four-pipe megaphone exhaust pipe
- 52 electric starter button
- 53 sidecar machine
- 54 sidecar body
- 55 sidecar crash bar
- 56 sidelight (*Am.* sidemarker lamp)
- 57 sidecar wheel
- 58 sidecar windscreen (*Am.* windshield)

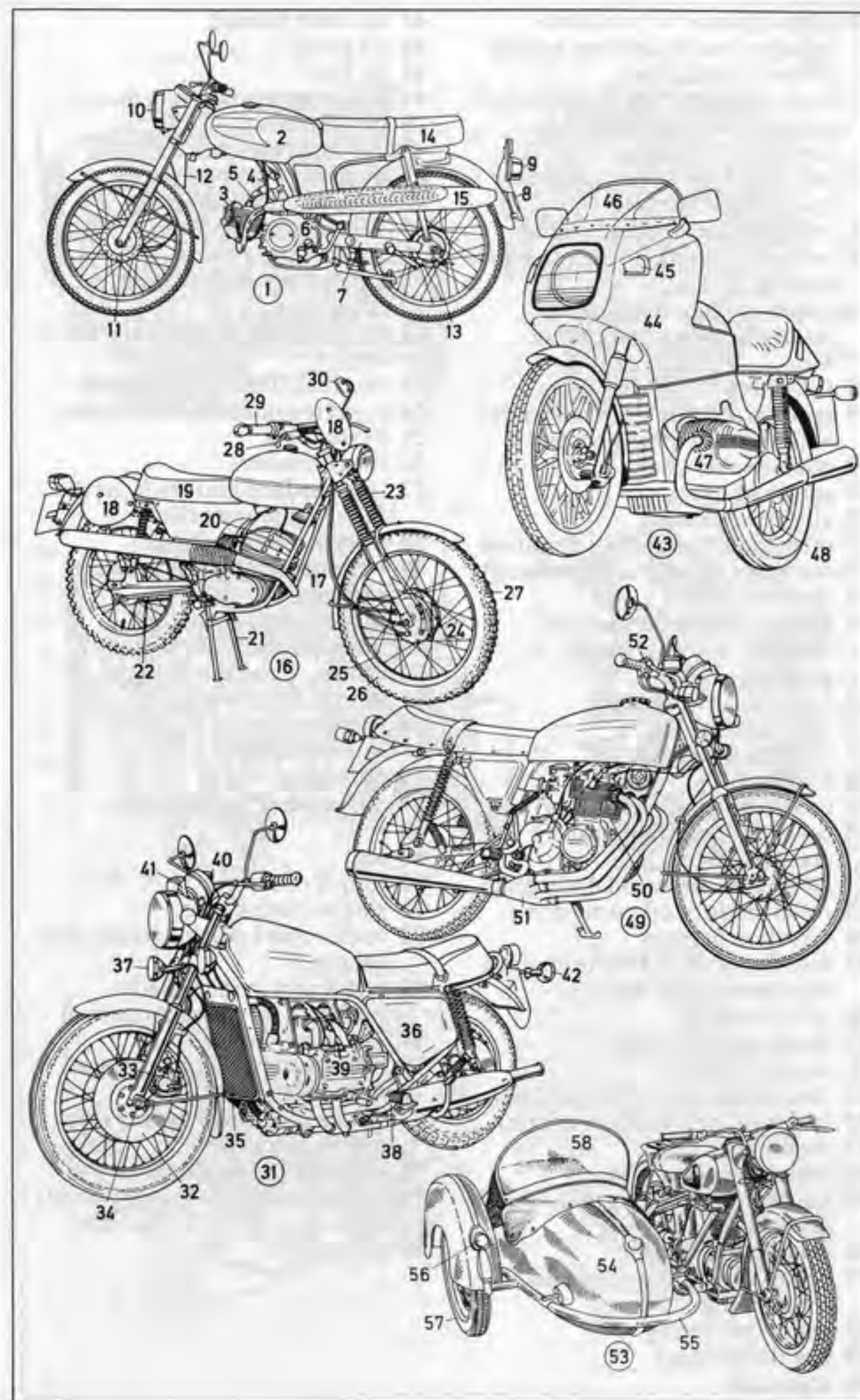



- 1 eight-cylinder V (vee) fuel-injection spark-ignition engine (Otto-cycle engine)
- 2 cross-section of spark-ignition engine (Otto-cycle internal combustion engine)
- 3 sectional view of five-cylinder in-line diesel engine
- 4 cross-section of diesel engine
- 5 two-rotor Wankel engine (rotary engine)
- 6 single-cylinder two-stroke internal combustion engine
- 7 fan
- 8 fan clutch for viscous drive
- 9 ignition distributor (distributor) with vacuum timing control
- 10 double roller chain
- 11 camshaft bearing
- 12 air-bleed duct
- 13 oil pipe for camshaft lubrication
- 14 camshaft, an overhead camshaft
- 15 venturi throat
- 16 intake silencer (absorption silencer, *Am.* absorption muffler)
- 17 fuel pressure regulator
- 18 inlet manifold
- 19 cylinder crankcase
- 20 flywheel
- 21 connecting rod (piston rod)
- 22 cover of crankshaft bearing
- 23 crankshaft
- 24 oil bleeder screw (oil drain plug)
- 25 roller chain of oil pump drive
- 26 vibration damper
- 27 distributor shaft for the ignition distributor (distributor)
- 28 oil filler neck
- 29 diaphragm spring
- 30 control linkage
- 31 fuel supply pipe (*Am.* fuel line)
- 32 fuel injector (injection nozzle)
- 33 rocker arm
- 34 rocker arm mounting
- 35 spark plug (sparking plug) with suppressor
- 36 exhaust manifold
- 37 piston with piston rings and oil scraper ring
- 38 engine mounting
- 39 dog flange (dog)
- 40 crankcase
- 41 oil sump (sump)
- 42 oil pump
- 43 oil filter
- 44 starter motor (starting motor)
- 45 cylinder head
- 46 exhaust valve
- 47 dipstick
- 48 cylinder head gasket
- 49 double bushing chain
- 50 warm-up regulator
- 51 tapered needle for idling adjustment
- 52 fuel pressure pipe (fuel pressure line)
- 53 fuel leak line (drip fuel line)
- 54 injection nozzle (spray nozzle)
- 55 heater plug
- 56 thrust washer
- 57 intermediate gear shaft for the injection pump drive
- 58 injection timer unit
- 59 vacuum pump (low-pressure regulator)
- 60 cam for vacuum pump
- 61 water pump (coolant pump)
- 62 cooling water thermostat
- 63 thermo time switch
- 64 fuel hand pump
- 65 injection pump
- 66 glow plug
- 67 oil pressure limiting valve
- 68 rotor
- 69 seal
- 70 torque converter
- 71 single-plate clutch
- 72 multi-speed gearing (multi-step gearing)
- 73 port liners in the exhaust manifold for emission control
- 74 disc (disk) brake
- 75 differential gear (differential)
- 76 generator
- 77 foot gear-change control (foot gearshift control)
- 78 dry multi-plate clutch
- 79 cross-draught (*Am.* cross-draft) carburettor (*Am.* carburetor)
- 80 cooling ribs

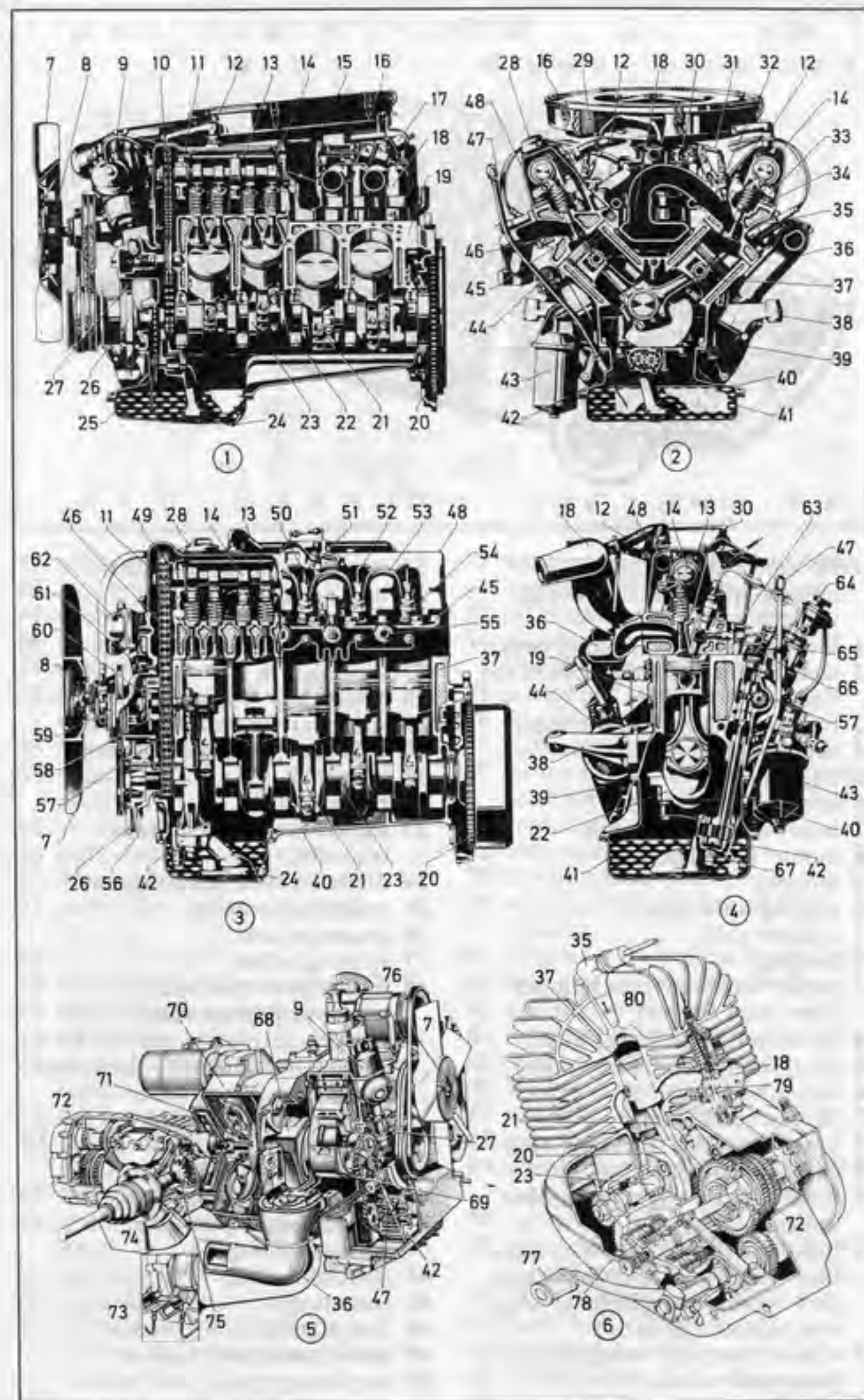



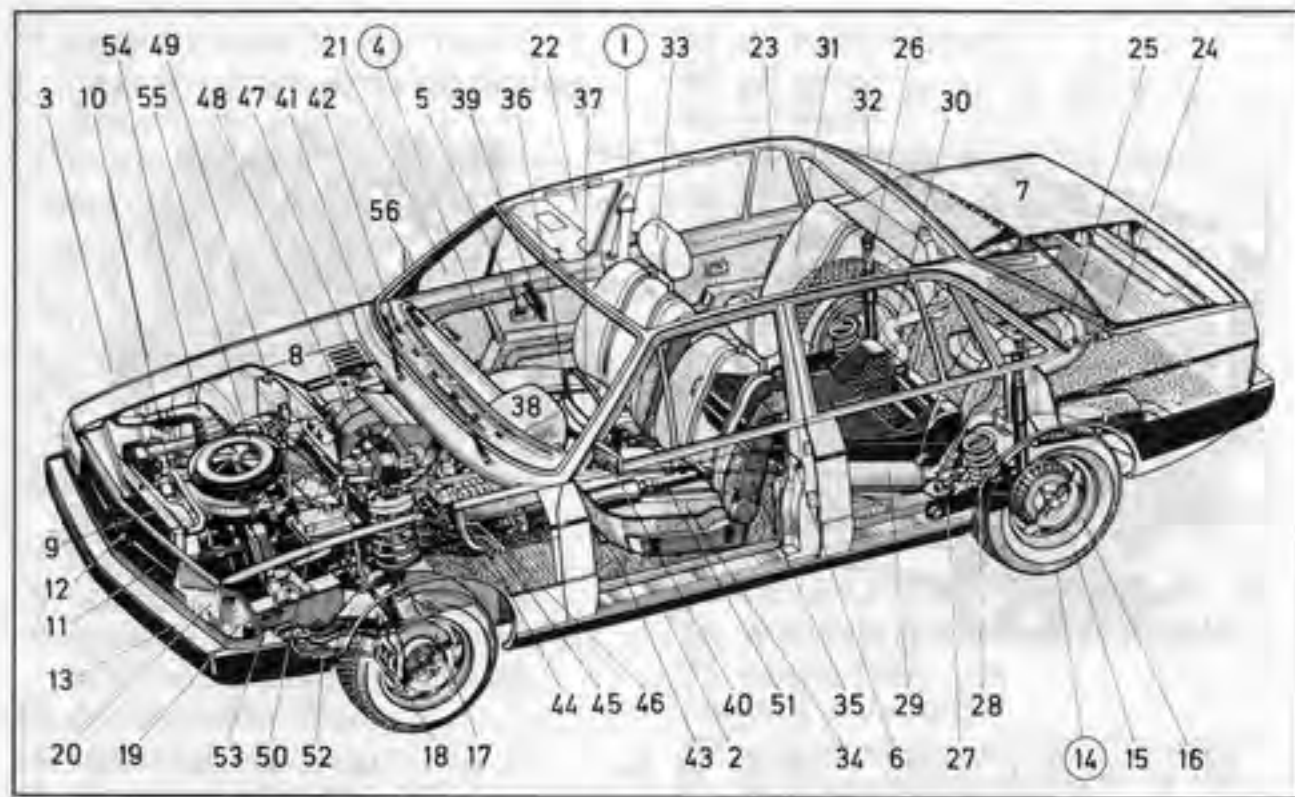

- 1-56 motor car (car, *Am. automobile, auto*), a passenger vehicle
- 1 monocoque body (unitary body)  
 2 chassis, the understructure of the body  
 3 front wing (*Am. front fender*)  
 4 car door  
 5 door handle  
 6 door lock  
 7 boot lid (*Am. trunk lid*)  
 8 bonnet (*Am. hood*)  
 9 radiator  
 10 cooling water pipe  
 11 radiator grill  
 12 badging  
 13 rubber-covered front bumper (*Am. front fender*)  
 14 car wheel, a disc (disk) wheel  
 15 car tyre (*Am. automobile tire*)  
 16 rim (wheel rim)  
 17-18 disc (disk) brake  
 17 brake disc (disk) (braking disc)  
 18 calliper (caliper)  
 19 front indicator light (front turn indicator light)  
 20 headlight (headlamp) with main beam (high beam), dipped beam (low beam), sidelight (side lamp, *Am. sidemarker lamp*)  
 21 windscreen (*Am. windshield*), a panoramic windscreen  
 22 crank-operated car window  
 23 quarter light (quarter vent)  
 24 boot (*Am. trunk*)  
 25 spare wheel  
 26 damper (shock absorber)  
 27 trailing arm  
 28 coil spring  
 29 silencer (*Am. muffler*)  
 30 automatic ventilation system  
 31 rear seats  
 32 rear window  
 33 adjustable headrest (head restraint)  
 34 driver's seat, a reclining seat  
 35 reclining backrest  
 36 passenger seat  
 37 steering wheel  
 38 centre (*Am. center*) console containing speedometer (*coll. speedo*), revolution counter (*rev counter, tachometer*), clock, fuel gauge (*Am. gage*), water temperature gauge, oil temperature gauge  
 39 inside rear-view mirror  
 40 left-hand wing mirror  
 41 windscreen wiper (*Am. windshield wiper*)  
 42 defroster vents  
 43 carpeting  
 44 clutch pedal (*coll. clutch*)  
 45 brake pedal (*coll. brake*)  
 46 accelerator pedal (*coll. accelerator*)

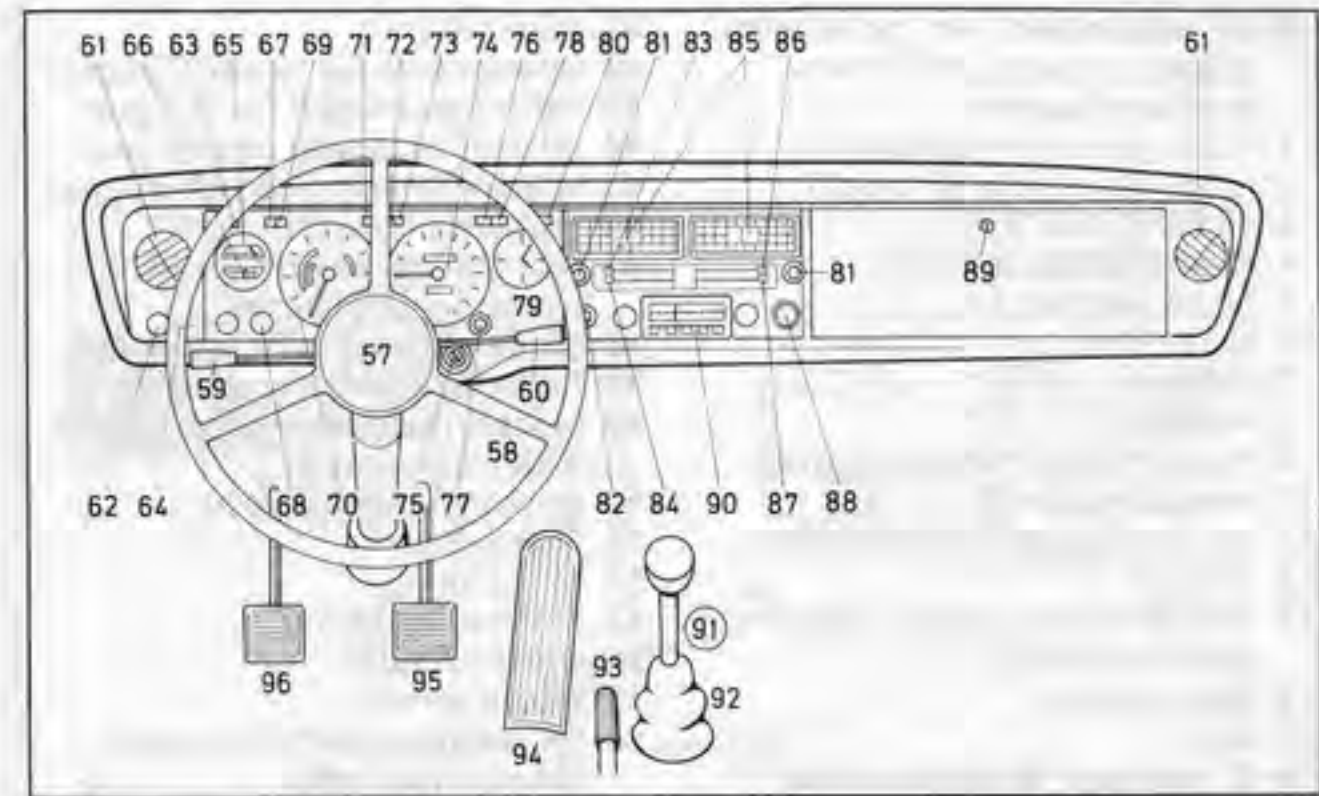

- 47 inlet vent  
 48 blower fan  
 49 brake fluid reservoir  
 50 battery  
 51 exhaust pipe  
 52 front running gear with front wheel drive  
 53 engine mounting  
 54 intake silencer (*Am. intake muffler*)  
 55 air filter (air cleaner)  
 56 right-hand wing mirror  
 57-90 dashboard (fascia panel)  
 57 controlled-collapse steering column  
 58 steering wheel spoke  
 59 indicator and dimming switch  
 60 wiper/washer switch and horn  
 61 side window blower  
 62 sidelight, headlight, and parking light switch  
 63 fog lamp warning light  
 64 fog headlamp and rear lamp switch  
 65 fuel gauge (*Am. gage*)  
 66 water temperature gauge (*Am. gage*)  
 67 warning light for rear fog lamp  
 68 hazard flasher switch  
 69 main beam warning light  
 70 electric rev counter (revolution counter)  
 71 fuel warning light  
 72 warning light for the hand brake and dual-circuit brake system  
 73 oil pressure warning light  
 74 speedometer (*coll. speedo*) with trip mileage recorder  
 75 starter and steering lock  
 76 warning lights for turn indicators and hazard flashers  
 77 switch for the courtesy light and reset button for the trip mileage recorder  
 78 ammeter  
 79 electric clock  
 80 warning light for heated rear window  
 81 switch for the leg space ventilation  
 82 rear window heating switch  
 83 ventilation switch  
 84 temperature regulator  
 85 fresh-air inlet and control  
 86 fresh-air regulator  
 87 warm-air regulator  
 88 cigar lighter  
 89 glove compartment (glove box) lock  
 90 car radio  
 91 gear lever (gearshift lever, floor-type gear-change)  
 92 leather gaiter  
 93 hand brake lever  
 94 accelerator pedal  
 95 brake pedal  
 96 clutch pedal



- 1-15 carburettor (Am. carburetor), a down-draught (Am. down-draft) carburettor
- 1 idling jet (slow-running jet)
- 2 idling air jet (idle air bleed)
- 3 air correction jet
- 4 compensating airstream
- 5 main airstream
- 6 choke flap
- 7 plunger
- 8 venturi
- 9 throttle valve (butterfly valve)
- 10 emulsion tube
- 11 idle mixture adjustment screw
- 12 main jet
- 13 fuel inlet (Am. gasoline inlet) (inlet manifold)
- 14 float chamber
- 15 float
- 16-27 pressure-feed lubricating system
- 16 oil pump
- 17 oil sump
- 18 sump filter
- 19 oil cooler
- 20 oil filter
- 21 main oil gallery (drilled gallery)
- 22 crankshaft drilling (crankshaft tributary, crankshaft bleed)
- 23 crankshaft bearing (main bearing)
- 24 camshaft bearing
- 25 connecting-rod bearing
- 26 gudgeon pin (piston pin)
- 27 bleed
- 28-47 four-speed synchromesh gearbox
- 28 clutch pedal
- 29 crankshaft
- 30 drive shaft (propeller shaft)
- 31 starting gear ring
- 32 sliding sleeve for 3rd and 4th gear
- 33 synchronizing cone
- 34 helical gear wheel for 3rd gear
- 35 sliding sleeve for 1st and 2nd gear
- 36 helical gear wheel for 1st gear
- 37 lay shaft
- 38 speedometer drive
- 39 helical gear wheel for speedometer drive
- 40 main shaft
- 41 gearshift rods
- 42 selector fork for 1st and 2nd gear
- 43 helical gear wheel for 2nd gear
- 44 selector head with reverse gear
- 45 selector fork for 3rd and 4th gear
- 46 gear lever (gearshift lever)
- 47 gear-change pattern (gearshift pattern, shift pattern)
- 48-55 disc (disk) brake [assembly]
- 48 brake disc (disk) (braking disc)
- 49 calliper (caliper), a fixed calliper with friction pads
- 50 servo cylinder (servo unit)
- 51 brake shoes
- 52 brake lining
- 53 outlet to brake line
- 54 wheel cylinder
- 55 return spring
- 56-59 steering gear (worm-and-nut steering gear)
- 56 steering column
- 57 worm gear sector
- 58 steering drop arm
- 59 worm
- 60-64 water-controlled heater
- 60 air intake
- 61 heat exchanger (heater box)
- 62 blower fan
- 63 flap valve
- 64 defroster vent
- 65-71 live axle (rigid axle)
- 65 propeller shaft
- 66 trailing arm
- 67 rubber bush
- 68 coil spring
- 69 damper (shock absorber)
- 70 Panhard rod
- 71 stabilizer bar
- 72-84 MacPherson strut unit
- 72 body-fixing plate
- 73 upper bearing
- 74 suspension spring
- 75 piston rod
- 76 suspension damper
- 77 rim (wheel rim)
- 78 stub axle
- 79 steering arm
- 80 track-rod ball-joint
- 81 trailing link arm
- 82 bump rubber (rubber bonding)
- 83 lower bearing
- 84 lower suspension arm

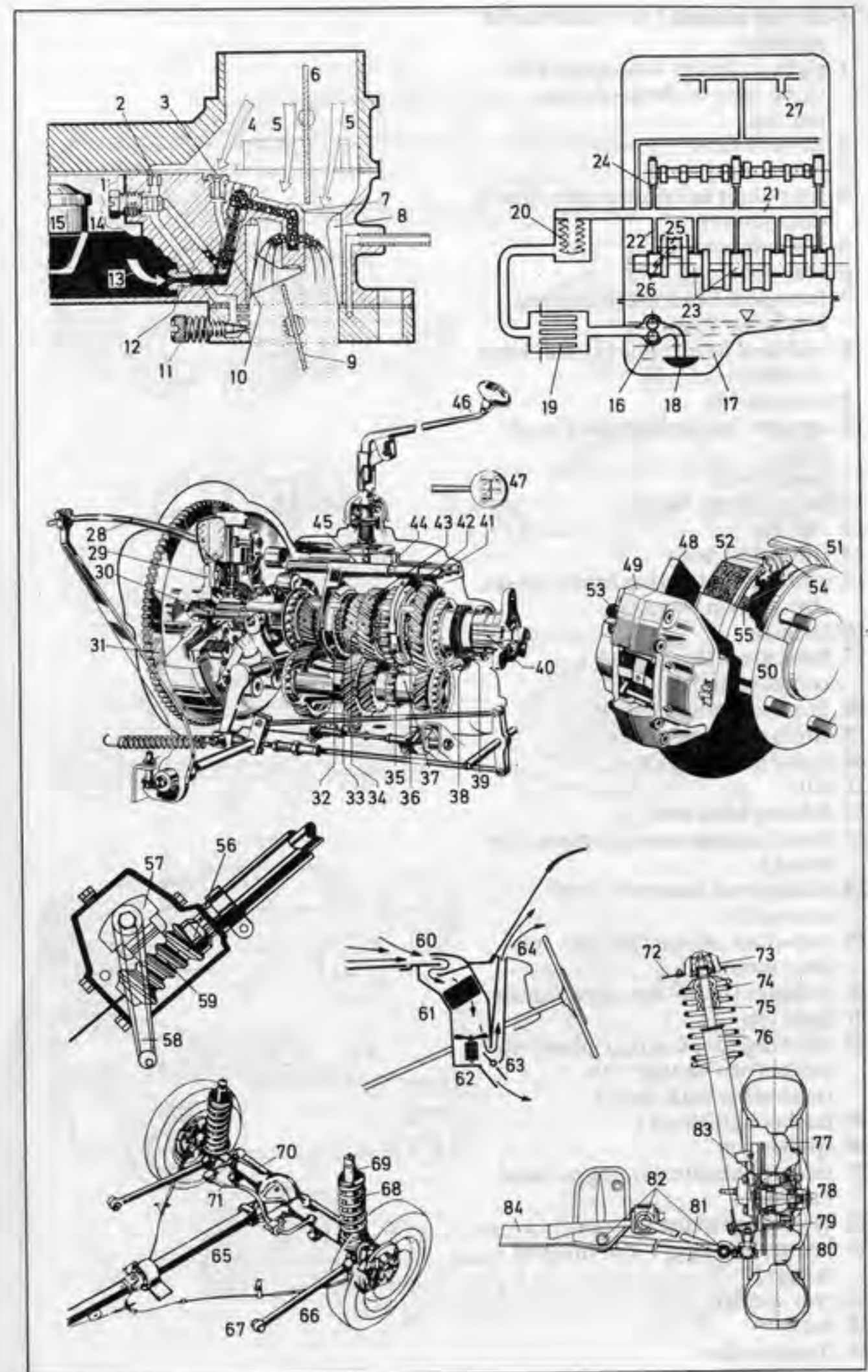



- 1-36 car models (*Am. automobile models*)
- 1 eight-cylinder limousine with three rows of three-abreast seating
  - 2 driver's door
  - 3 rear door
  - 4 four-door saloon car (*Am. four-door sedan*)
  - 5 front door
  - 6 rear door
  - 7 front seat headrest (front seat head restraint)
  - 8 rear seat headrest (rear seat head restraint)
  - 9 convertible
  - 10 convertible (collapsible) hood (top)
  - 11 bucket seat
  - 12 buggy (dune buggy)
  - 13 roll bar
  - 14 fibre glass body
  - 15 estate car (shooting brake, estate, *Am. station wagon*)
  - 16 tailgate
  - 17 boot space (luggage compartment)
  - 18 three-door hatchback
  - 19 small three-door car
  - 20 rear door (tailgate)
  - 21 sill
  - 22 folding back seat
  - 23 boot (luggage compartment, *Am. trunk*)
  - 24 sliding roof (sunroof, steel sunroof)
  - 25 two-door saloon car (*Am. two-door sedan*)
  - 26 roadster (hard-top), a two-seater
  - 27 hard top
  - 28 sporting coupé, a two-plus-two coupé (two-seater with removable back seats)
  - 29 fastback (liftback)
  - 30 spoiler rim
  - 31 integral headrest (integral head restraint)
  - 32 GT car (gran turismo car)
  - 33 integral bumper (*Am. integral fender*)
  - 34 rear spoiler
  - 35 back
  - 36 front spoiler

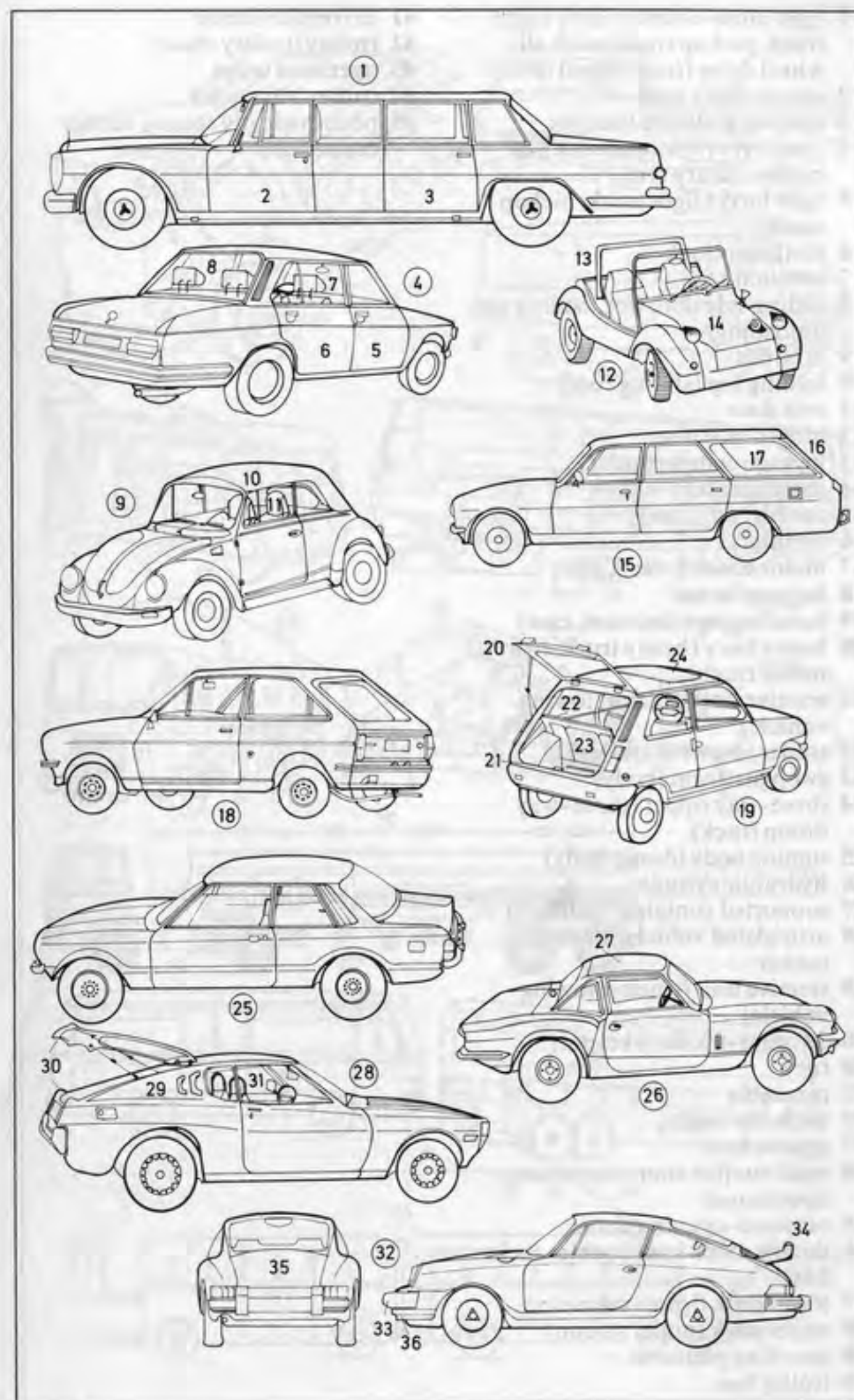



- 1 light cross-country lorry (light truck, pickup truck) with all-wheel drive (four-wheel drive)
- 2 cab (driver's cab)
- 3 loading platform (body)
- 4 spare tyre (Am. spare tire), a cross-country tyre
- 5 light lorry (light truck, pickup truck)
- 6 platform truck
- 7 medium van
- 8 sliding side door [for loading and unloading]
- 9 minibus
- 10 folding top (sliding roof)
- 11 rear door
- 12 hinged side door
- 13 luggage compartment
- 14 passenger seat
- 15 cab (driver's cab)
- 16 air inlet
- 17 motor coach (coach, bus)
- 18 luggage locker
- 19 hand luggage (suitcase, case)
- 20 heavy lorry (heavy truck, heavy motor truck)
- 21 tractive unit (tractor, towing vehicle)
- 22 trailer (drawbar trailer)
- 23 swop platform (body)
- 24 three-way tipper (three-way dump truck)
- 25 tipping body (dump body)
- 26 hydraulic cylinder
- 27 supported container platform
- 28 articulated vehicle, a vehicle tanker
- 29 tractive unit (tractor, towing vehicle)
- 30-33 semi-trailer (skeletal)
- 30 tank
- 31 turntable
- 32 undercarriage
- 33 spare wheel
- 34 midi bus [for short-route town operations]
- 35 outward-opening doors
- 36 double-deck bus (double-decker bus)
- 37 lower deck (lower saloon)
- 38 upper deck (upper saloon)
- 39 boarding platform
- 40 trolley bus

- 41 current collector
- 42 trolley (trolley shoe)
- 43 overhead wires
- 44 trolley bus trailer
- 45 pneumatically sprung rubber connection

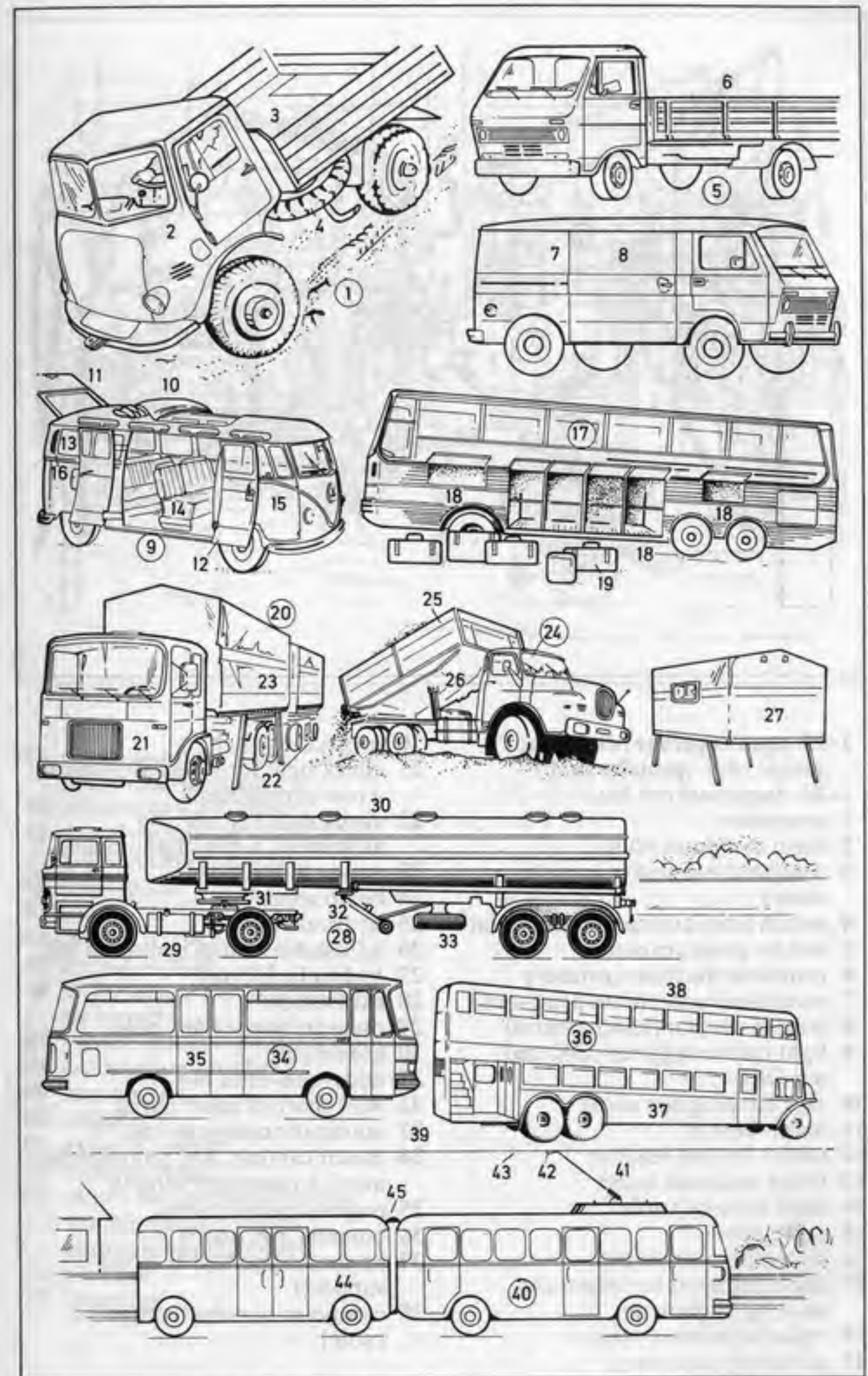





- |  |   |
|--|---|
| 1-55 agent's garage (distributor's garage, Am. specialty shop) | 20 projector switch   |
| 1-23 diagnostic test bay                                       | 21 check light for wheel alignment, a row of photocells       |
| 1 computer   | 22 check light for steering alignment, a row of photocells    |
| 2 main computer plug   | 23 power screwdriver  |
| 3 computer harness (computer cable)                            | 24 beam setter  |
| 4 switch from automatic to manual                              | 25 hydraulic lift   |
| 5 slot for program cards                                       | 26 adjustable arm of hydraulic lift                           |
| 6 print-out machine (printer)                                  | 27 hydraulic lift pad   |
| 7 condition report (data print-out)                            | 28 excavation   |
| 8 master selector (hand control)                               | 29 pressure gauge (Am. gage)                                  |
| 9 light read-out [green: OK; red: not OK]                      | 30 grease gun   |
| 10 rack for program cards                                      | 31 odds-and-ends box  |
| 11 mains button  | 32 wall chart [of spare parts]                                |
| 12 switch for fast readout                                     | 33 automatic computer test                                    |
| 13 firing sequence insert                                      | 34 motor car (car, Am. automobile, auto), a passenger vehicle |
| 14 shelf for used cards  | 35 engine compartment   |
| 15 cable boom  | 36 bonnet (Am. hood)  |
| 16 oil temperature sensor                                      | 37 bonnet support (Am. hood support)                          |
| 17 test equipment for wheel and steering alignment             | 38 computer harness (computer cable)                          |
| 18 right-hand optic plate                                      |   |
| 19 actuating transistors                                       |   |

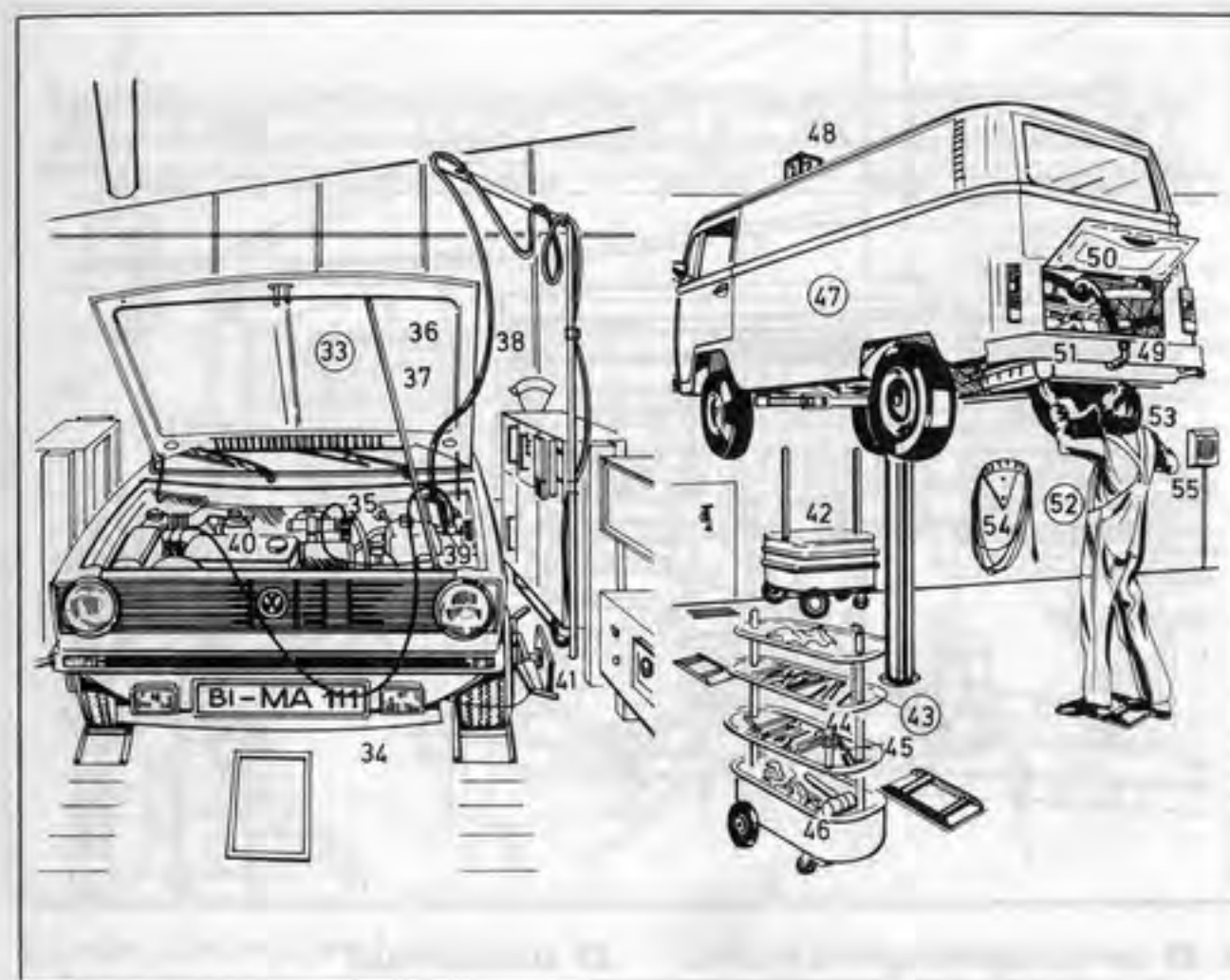

- |   |
|---|
| 39 main computer socket; also: multi-outlet socket                      |
| 40 oil temperature sensor   |
| 41 wheel mirror for visual wheel and steering alignment                 |
| 42 tool trolley   |
| 43 tools  |
| 44 impact wrench  |
| 45 torque wrench  |
| 46 body hammer (roughing-out hammer)                                    |
| 47 vehicle under repair, a minibus                                      |
| 48 car location number  |
| 49 rear engine  |
| 50 tailgate   |
| 51 exhaust system   |
| 52 exhaust repair   |
| 53 motor car mechanic (motor vehicle mechanic, Am. automotive mechanic) |
| 54 air hose   |
| 55 intercom   |



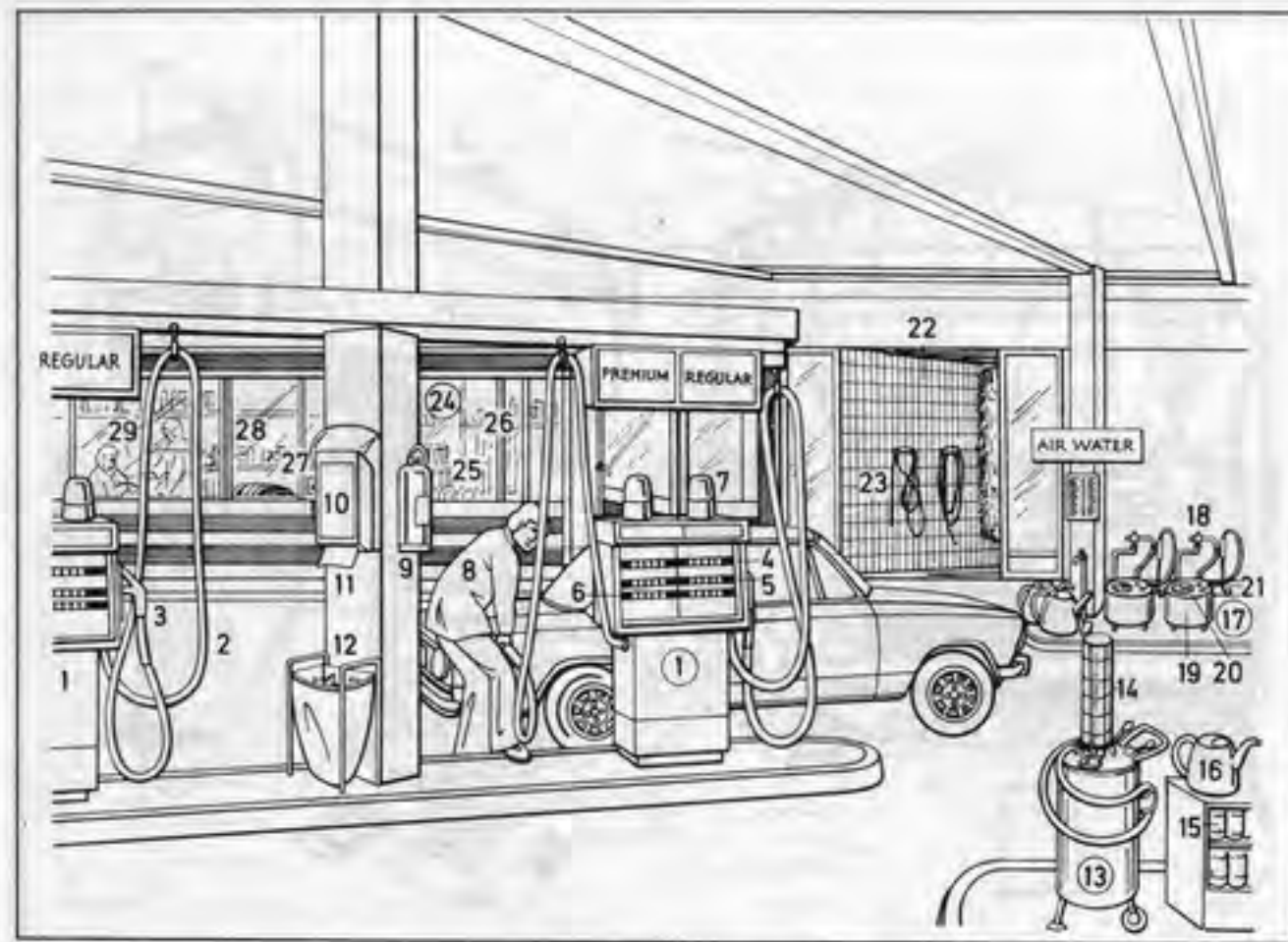

- |  |  |
|--|--|
| 1-29 service station (petrol station, filling station, <i>Am.</i> gasoline station, gas station), a self-service station                   | 19 static air tank                               |
| 1 petrol ( <i>Am.</i> gasoline) pump (blending pump) for regular and premium grade petrol ( <i>Am.</i> gasoline) ( <i>sim.</i> : for derv) | 20 pressure gauge ( <i>Am.</i> gage) (manometer) |
| 2 hose (petrol pump, <i>Am.</i> gasoline pump, hose)   | 21 air filler neck                               |
| 3 nozzle   | 22 repair bay (repair shop)                      |
| 4 cash readout   | 23 car-wash hose, a hose (hosepipe)              |
| 5 volume read-out  | 24 accessory shop                                |
| 6 price display  | 25 petrol can ( <i>Am.</i> gasoline can)         |
| 7 indicator light  | 26 rain cape                                     |
| 8 driver using self-service petrol pump ( <i>Am.</i> gasoline pump)  | 27 car tyres ( <i>Am.</i> automobile tires)      |
| 9 fire extinguisher  | 28 car accessories                               |
| 10 paper-towel dispenser   | 29 cash desk (console)                           |
| 11 paper towel   |  |
| 12 litter receptacle   |  |
| 13 two-stroke blending pump  |  |
| 14 meter   |  |
| 15 engine oil  |  |
| 16 oil can   |  |
| 17 tyre pressure gauge ( <i>Am.</i> tire pressure gage)  |  |
| 18 air hose  |  |

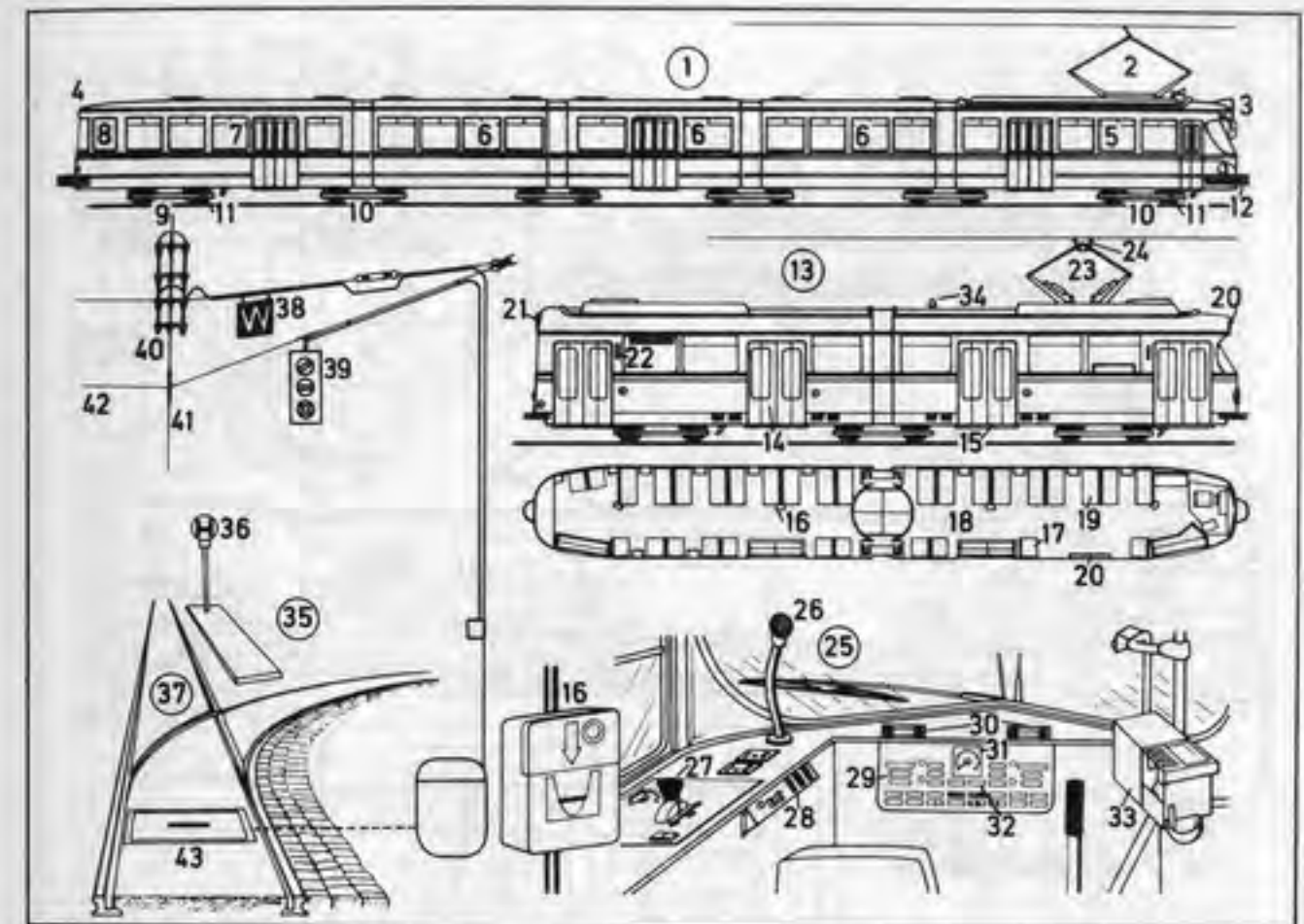

- |   |   |
|---|---|
| 1 twelve-axle articulated railcar for interurban rail service   | 24 carbon or aluminium ( <i>Am.</i> aluminum) alloy trolley shoes                 |
| 2 current collector   | 25 driver's position  |
| 3 head of the railcar   | 26 microphone   |
| 4 rear of the railcar   | 27 controller   |
| 5 carriage A containing the motor   | 28 radio equipment (radio communication set)                                      |
| 6 carriage B ( <i>also</i> : carriages C and D)   | 29 dashboard  |
| 7 carriage E containing the motor   | 30 dashboard lighting   |
| 8 rear controller   | 31 speedometer  |
| 9 bogie   | 32 buttons controlling doors, windscreen wipers, internal and external lighting   |
| 10 carrying bogie   | 33 ticket counter with change machine   |
| 11 wheel guard  | 34 radio antenna  |
| 12 bumper ( <i>Am.</i> fender)  | 35 tram stop ( <i>Am.</i> streetcar stop, trolley stop)                           |
| 13 six-axle articulated railcar ('Mannheim' type) for tram ( <i>Am.</i> streetcar, trolley) and urban rail services | 36 tram stop sign ( <i>Am.</i> streetcar stop sign, trolley stop sign)            |
| 14 entrance and exit door, a double folding door  | 37 electric change points   |
| 15 step   | 38 points signal (switch signal)  |
| 16 ticket-cancelling machine  | 39 points change indicator  |
| 17 single seat  | 40 trolley wire contact point   |
| 18 standing room portion  | 41 trolley wire (overhead contact wire)   |
| 19 double seat  | 42 overhead cross wire  |
| 20 route (number) and destination sign  | 43 electric ( <i>also</i> : electrohydraulic, electromechanical) points mechanism |
| 21 route sign (number sign)   |   |
| 22 indicator (indicator light)  |   |
| 23 pantograph (current collector)   |   |



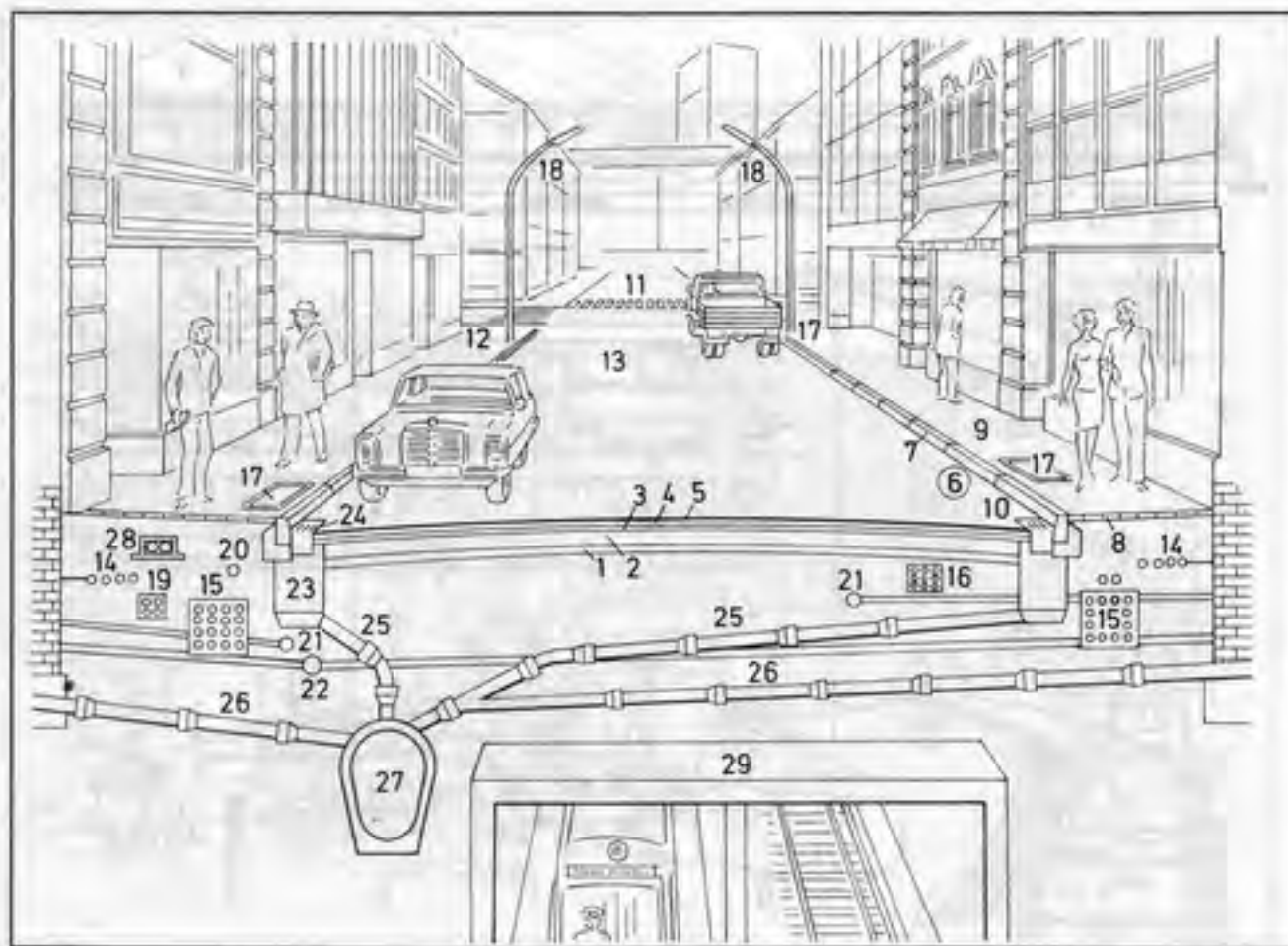

**1-5 road layers**

- 1 anti-frost layer
- 2 bituminous sub-base course
- 3 base course
- 4 binder course
- 5 bituminous surface
- 6 kerb (curb)
- 7 kerbstone (curbstone)
- 8 paving (pavement)
- 9 pavement (*Am.* sidewalk, walkway)
- 10 gutter
- 11 pedestrian crossing (zebra crossing, *Am.* crosswalk)
- 12 street corner
- 13 street
- 14 electricity cables
- 15 telephone cables
- 16 telephone cable pipeline
- 17 cable manhole with cover (with manhole cover)
- 18 lamp post with lamp
- 19 electricity cables for technical installations
- 20 subscribers' (*Am.* customers') telephone lines

- 21 gas main
- 22 water main
- 23 drain
- 24 drain cover
- 25 drain pipe
- 26 waste pipe
- 27 combined sewer
- 28 district heating main
- 29 underground tunnel

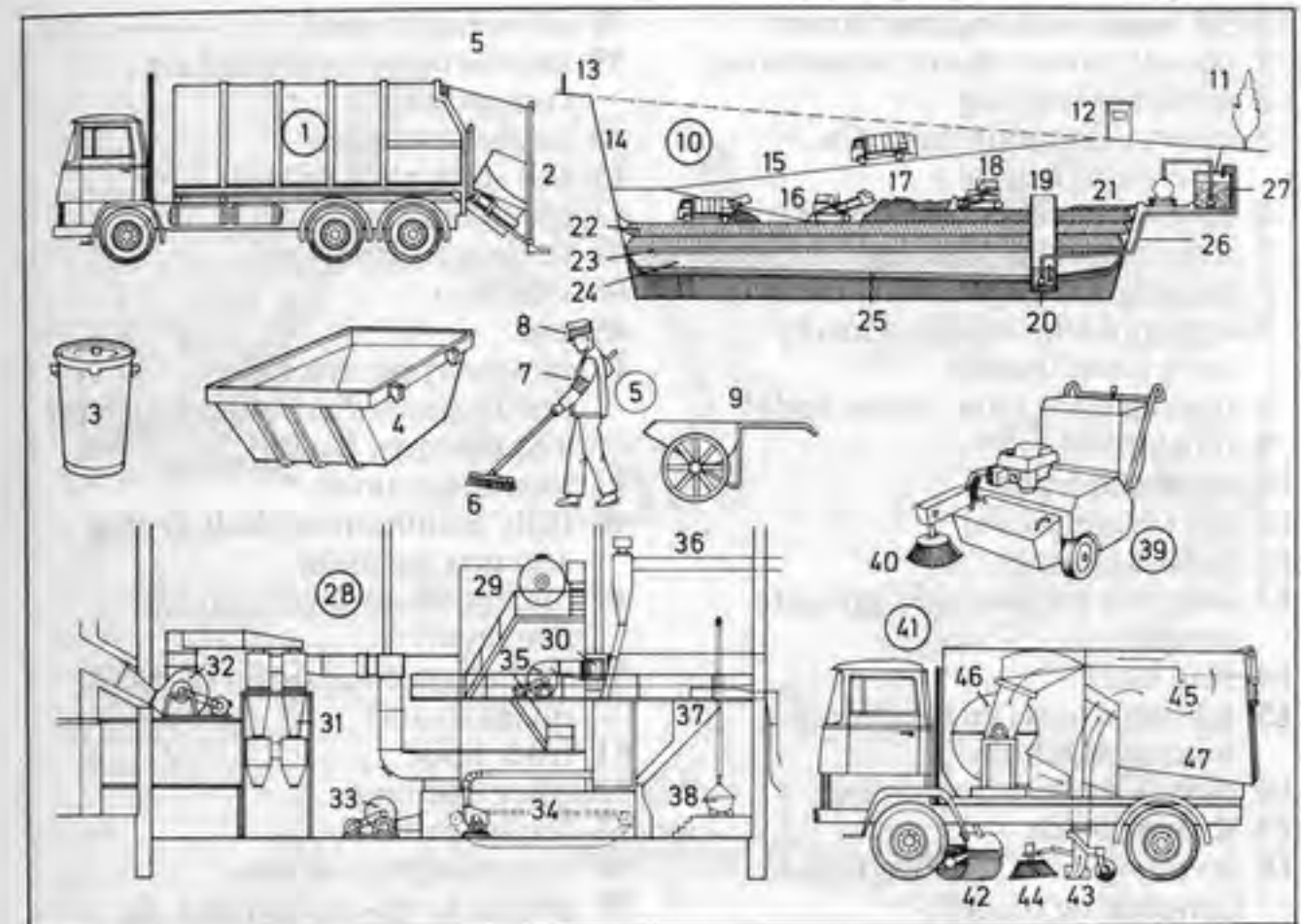

- 1 refuse collection vehicle (*Am.* garbage truck)
- 2 dustbin-tipping device (*Am.* garbage can dumping device), a dust-free emptying system
- 3 dustbin (*Am.* garbage can, trash can)
- 4 refuse container (*Am.* garbage container)
- 5 road sweeper (*Am.* street sweeper)
- 6 broom
- 7 fluorescent armband
- 8 cap with fluorescent band
- 9 road sweeper's (*Am.* street sweeper's) barrow
- 10 controlled tip (*Am.* sanitary landfill, sanitary fill)
- 11 screen
- 12 weigh office
- 13 fence
- 14 embankment
- 15 access ramp
- 16 bulldozer
- 17 refuse (*Am.* garbage)
- 18 bulldozer for dumping and compacting
- 19 pump shaft
- 20 waste water pump
- 21 porous cover
- 22 compacted and decomposed refuse
- 23 gravel filter layer
- 24 morainic filter layer
- 25 drainage layer
- 26 drain pipe
- 27 water tank
- 28 refuse (*Am.* garbage) incineration unit
- 29 furnace
- 30 oil-firing system
- 31 separation plant
- 32 extraction fan
- 33 low-pressure fan for the grate
- 34 continuous feed grate
- 35 fan for the oil-firing system
- 36 conveyor for separately incinerated material
- 37 coal feed conveyor
- 38 truck for carrying fuller's earth
- 39 mechanical sweeper
- 40 circular broom
- 41 road-sweeping lorry (street-cleaning lorry, street cleaner)
- 42 cylinder broom
- 43 suction port
- 44 feeder broom
- 45 air flow
- 46 fan
- 47 dust collector



1-54 road-building machinery

- 1 shovel (power shovel, excavator)
- 2 machine housing
- 3 caterpillar mounting (*Am.* caterpillar tractor)
- 4 digging bucket arm (dipper stick)
- 5 digging bucket (bucket)
- 6 digging bucket (bucket) teeth
- 7 tipper (dump truck), a heavy lorry (*Am.* truck)
- 8 tipping body (*Am.* dump body)
- 9 reinforcing rib
- 10 extended front
- 11 cab (driver's cab)
- 12 bulk material
- 13 concrete scraper, an aggregate scraper
- 14 skip hoist
- 15 mixing drum (mixer drum), a mixing machine
- 16 caterpillar hauling scraper
- 17 scraper blade
- 18 levelling (*Am.* leveling) blade (smoothing blade)
- 19 grader (motor grader)
- 20 scarifier (ripper, road ripper, rooter)
- 21 grader levelling (*Am.* leveling) blade (grader ploughshare, *Am.* plowshare)
- 22 blade-slewing gear (slew turntable)
- 23 light railway (narrow-gauge, *Am.* narrow-gage, railway)
- 24 light railway (narrow-gauge, *Am.* narrow-gage) diesel locomotive
- 25 trailer wagon (wagon truck, skip)
- 26 tamper (rammer); *heavier*: frog
- 27 guide rods
- 28 bulldozer
- 29 bulldozer blade
- 30 pushing frame
- 31 road-metal spreading machine (macadam spreader, stone spreader)
- 32 tamping beam
- 33 sole-plate
- 34 side stop
- 35 side of storage bin
- 36 three-wheeled roller, a road roller
- 37 roller

- 38 all-weather roof
- 39 mobile diesel-powered air compressor
- 40 oxygen cylinder
- 41 self-propelled gritter
- 42 spreading flap
- 43 surface finisher
- 44 side stop
- 45 bin
- 46 tar-spraying machine (bituminous distributor) with tar and bitumen heater
- 47 tar storage tank
- 48 fully automatic asphalt drying and mixing plant
- 49 bucket elevator (elevating conveyor)
- 50 asphalt-mixing drum (asphalt mixer drum)
- 51 filler hoist
- 52 filler opening
- 53 binder injector
- 54 mixed asphalt outlet
- 55 typical cross-section of a bituminous road
- 56 grass verge
- 57 crossfall
- 58 asphalt surface (bituminous layer, bituminous coating)
- 59 base (base course)
- 60 gravel sub-base course (hardcore sub-base course, Telford base), an anti-frost layer
- 61 sub-drainage
- 62 perforated cement pipe
- 63 drainage ditch
- 64 soil covering

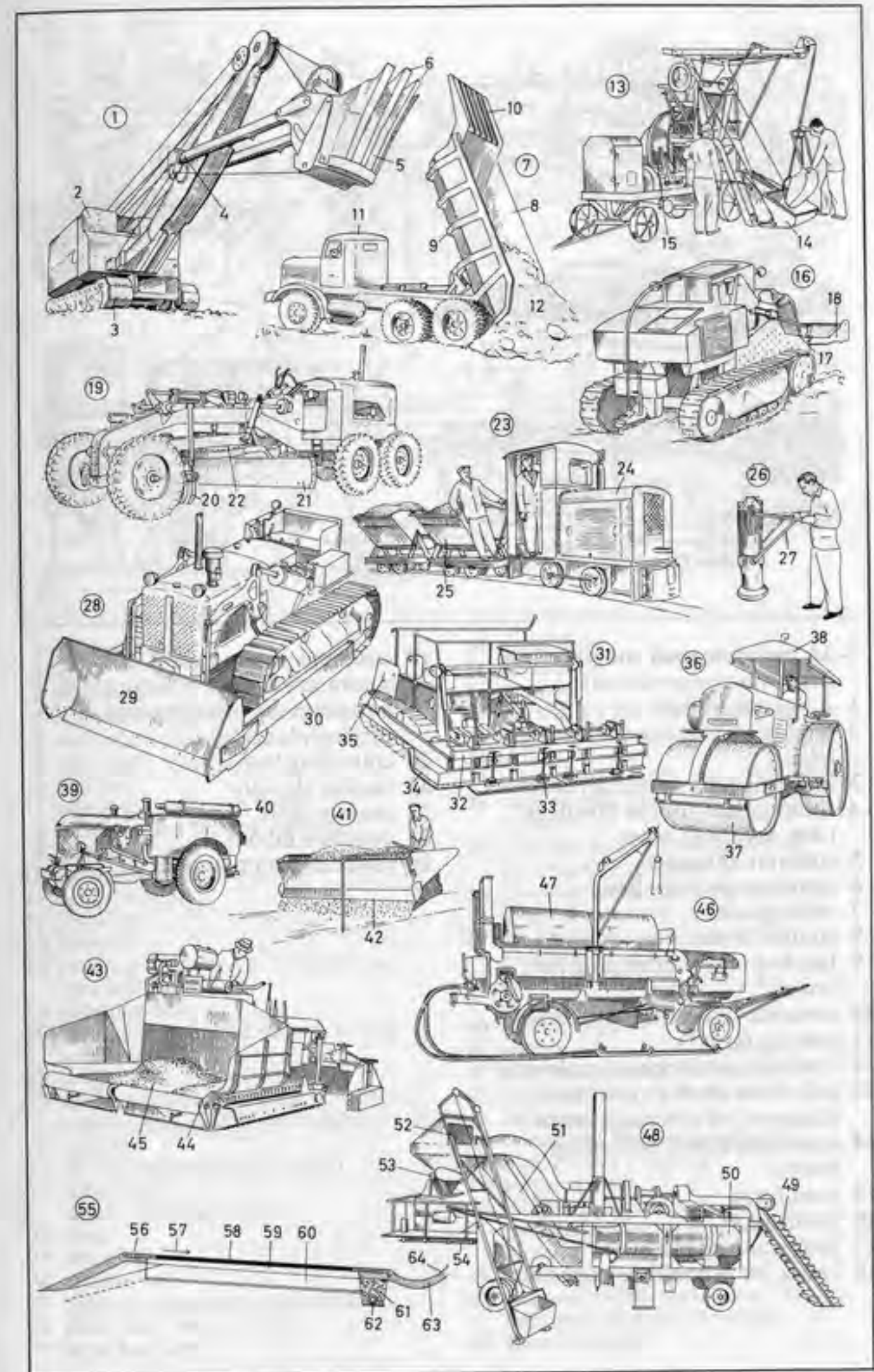



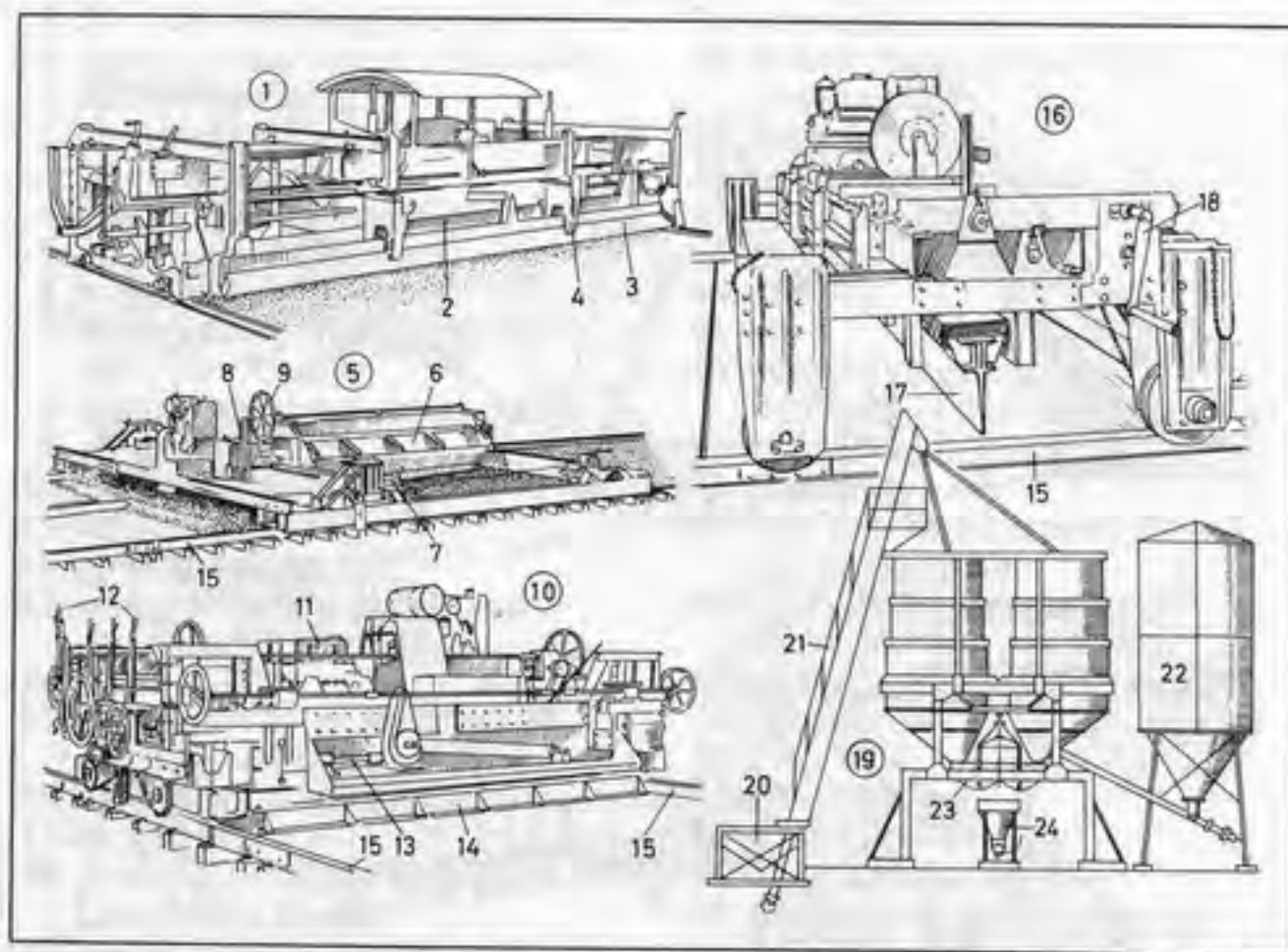

**1-24 concrete road construction**  
(highway construction)

**19 concrete-mixing plant, a stationary central mixing plant, an automatic batching and mixing plant**

- 1 subgrade grader
- 2 tamping beam (consolidating beam)
- 3 levelling (*Am.* leveling) beam
- 4 roller guides for the levelling (*Am.* leveling) beam
- 5 concrete spreader
- 6 concrete spreader box
- 7 cable guides
- 8 control levers
- 9 handwheel for emptying the boxes
- 10 concrete-vibrating compactor
- 11 gearing (gears)
- 12 control levers (operating levers)
- 13 axle drive shaft to vibrators (tamper) of vibrating beam
- 14 screeding board (screeding beam)
- 15 road form
- 16 joint cutter
- 17 joint-cutting blade
- 18 crank for propelling machine

- 19 concrete-mixing plant, a stationary central mixing plant, an automatic batching and mixing plant
- 20 collecting bin
- 21 bucket elevator
- 22 cement store
- 23 concrete mixer
- 24 concrete pump hopper

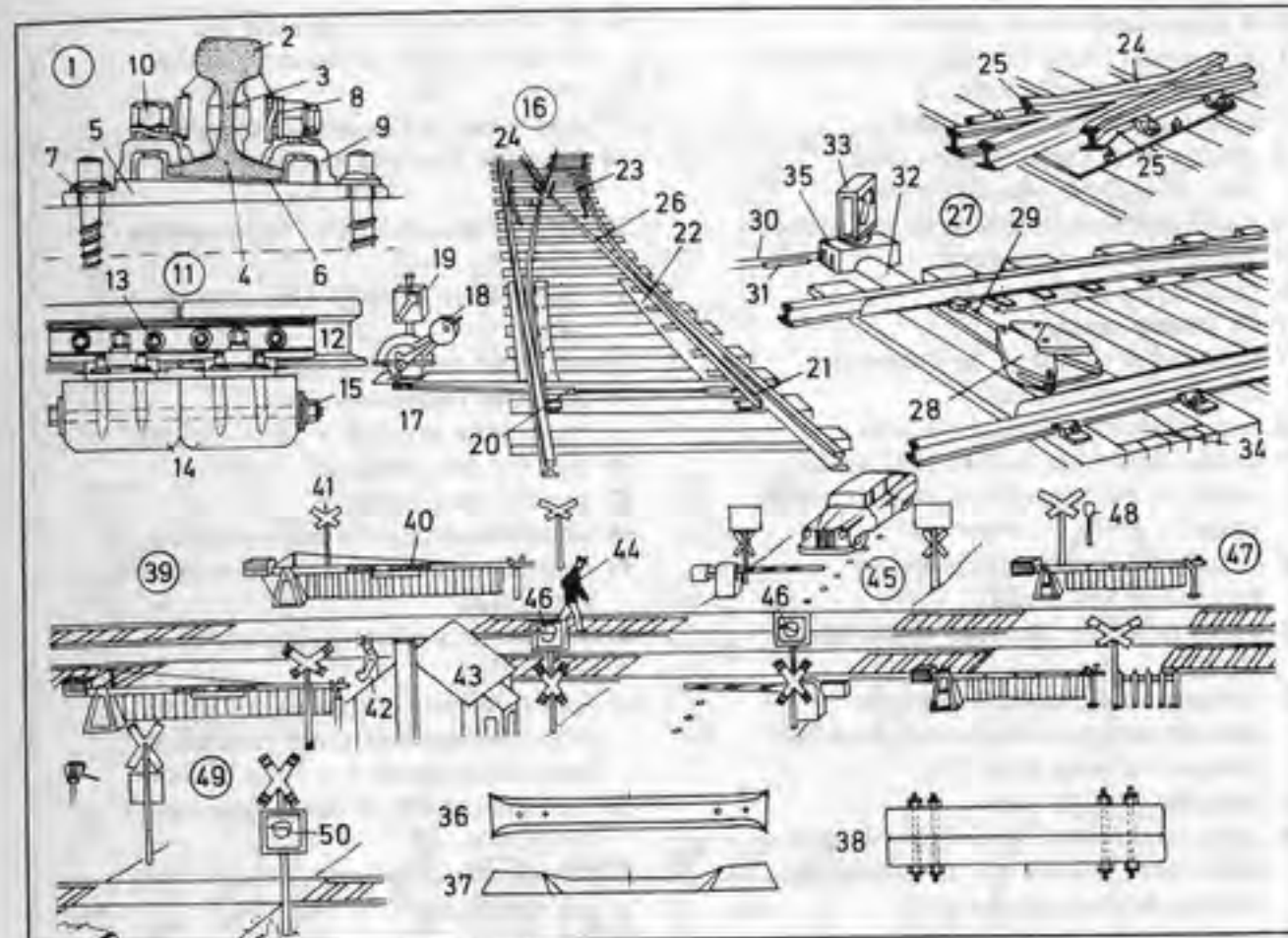

**1-38 line (track)**

- 1 rail
- 2 rail head
- 3 web (rail web)
- 4 rail foot (rail bottom)
- 5 sole-plate (base plate)
- 6 cushion
- 7 coach screw (coach bolt)
- 8 lock washers (spring washers)
- 9 rail clip (clip)
- 10 T-head bolt
- 11 rail joint (joint)
- 12 fishplate
- 13 fishbolt
- 14 coupled sleeper (*Am.* coupled tie, coupled crosstie)
- 15 coupling bolt
- 16 manually-operated points (switch)
- 17 switch stand
- 18 weight
- 19 points signal (switch signal, points signal lamp, switch signal lamp)
- 20 pull rod
- 21 switch blade (switch tongue)
- 22 slide chair
- 23 check rail (guard rail)
- 24 frog
- 25 wing rail
- 26 closure rail
- 27 remote-controlled points (switch)
- 28 point lock (switch lock)
- 29 stretcher bar

**30 point wire**

- 30 point wire
- 31 turnbuckle
- 32 channel
- 33 electrically illuminated points signal (switch signal)
- 34 trough
- 35 points motor with protective casing
- 36 steel sleeper (*Am.* steel tie, steel crosstie)
- 37 concrete sleeper (*Am.* concrete tie, concrete crosstie)
- 38 coupled sleeper (*Am.* coupled tie, coupled crosstie)
- 39-50 level crossings (*Am.* grade crossings)
- 39 protected level crossing (*Am.* protected grade crossing)
- 40 barrier (gate)
- 41 warning cross (*Am.* crossbuck)
- 42 crossing keeper (*Am.* gateman)
- 43 crossing keeper's box (*Am.* gateman's box)
- 44 linesman (*Am.* trackwalker)
- 45 half-barrier crossing
- 46 warning light
- 47 intercom-controlled crossing; *sim.*: telephone-controlled crossing
- 48 intercom system
- 49 unprotected level crossing (*Am.* unprotected grade crossing)
- 50 warning light



## 203 Railway Line (Am. Railroad Track) II (Signalling Equipment)

- 1-6 stop signals (main signals)
- 1 stop signal (main signal), a semaphore signal in 'stop' position
- 2 signal arm (semaphore arm)
- 3 electric stop signal (colour light, Am. color light, signal) at 'stop'
- 4 signal position: 'proceed at low speed'
- 5 signal position: 'proceed'
- 6 substitute signal
- 7-24 distant signals
- 7 semaphore signal at 'be prepared to stop at next signal'
- 8 supplementary semaphore arm
- 9 colour light (Am. color light) distant signal at 'be prepared to stop at next signal'
- 10 signal position: 'be prepared to proceed at low speed'
- 11 signal position: 'proceed main signal ahead'
- 12 semaphore signal with indicator plate showing a reduction in braking distance of more than 5%
- 13 triangle (triangle sign)
- 14 colour light (Am. color light) distant signal with indicator light for showing reduced braking distance
- 15 supplementary white light
- 16 distant signal indicating 'be prepared to stop at next signal' (yellow light)
- 17 second distant signal (distant signal with supplementary light, without indicator plate)
- 18 distant signal with speed indicator
- 19 distant speed indicator
- 20 distant signal with route indicator
- 21 route indicator
- 22 distant signal without supplementary arm in position: 'be prepared to stop at next signal'
- 23 distant signal without supplementary arm in 'be prepared to proceed' position
- 24 distant signal identification plate
- 25-44 supplementary signals
- 25 stop board for indicating the stopping point at a control point
- 26-29 approach signs
- 26 approach sign 100 m from distant signal
- 27 approach sign 175 m from distant signal
- 28 approach sign 250 m from distant signal
- 29 approach sign at a distance of 5% less than the braking distance on the section
- 30 chequered sign indicating stop signals (main signals) not positioned immediately to the right of or over the line (track)

- 31-32 stop boards to indicate the stopping point of the front of the train
- 33 stop board (be prepared to stop)
- 34-35 snow plough (Am. snowplow) signs
- 34 'raise snow-plough (Am. snowplow)' sign
- 35 'lower snow-plough (Am. snowplow)' sign
- 36-44 speed restriction signs
- 36-38 speed restriction sign [maximum speed  $3 \times 10 = 30$  kph]
- 36 sign for day running
- 37 speed code number
- 38 illuminated sign for night running
- 39 commencement of temporary speed restriction
- 40 termination of temporary speed restriction
- 41 speed restriction sign for a section with a permanent speed restriction [maximum speed  $5 \times 10 = 50$  kph]
- 42 commencement of permanent speed restriction
- 43 speed restriction warning sign [only on main lines]
- 44 speed restriction sign [only on main lines]
- 45-52 points signals (switch signals)
- 45-48 single points (single switches)
- 45 route straight ahead (main line)
- 46 [right] branch
- 47 [left] branch
- 48 branch [seen from the frog]
- 49-52 double crossover
- 49 route straight ahead from left to right
- 50 route straight ahead from right to left
- 51 turnout to the left from the left
- 52 turnout to the right from the right
- 53 manually-operated signal box (Am. signal tower, switch tower)
- 54 lever mechanism
- 55 points lever (switch lever) [blue], a lock lever
- 56 signal lever [red]
- 57 catch
- 58 route lever
- 59 block instruments
- 60 block section panel
- 61 electrically-operated signal box (Am. signal tower, switch tower)
- 62 points (switch) and signal knobs
- 63 lock indicator panel
- 64 track and signal indicator
- 65 track diagram control layout
- 66 track diagram control panel (domino panel)
- 67 push buttons
- 68 routes
- 69 intercom system

## Railway Line (Am. Railroad Track) II 203 (Signalling Equipment)

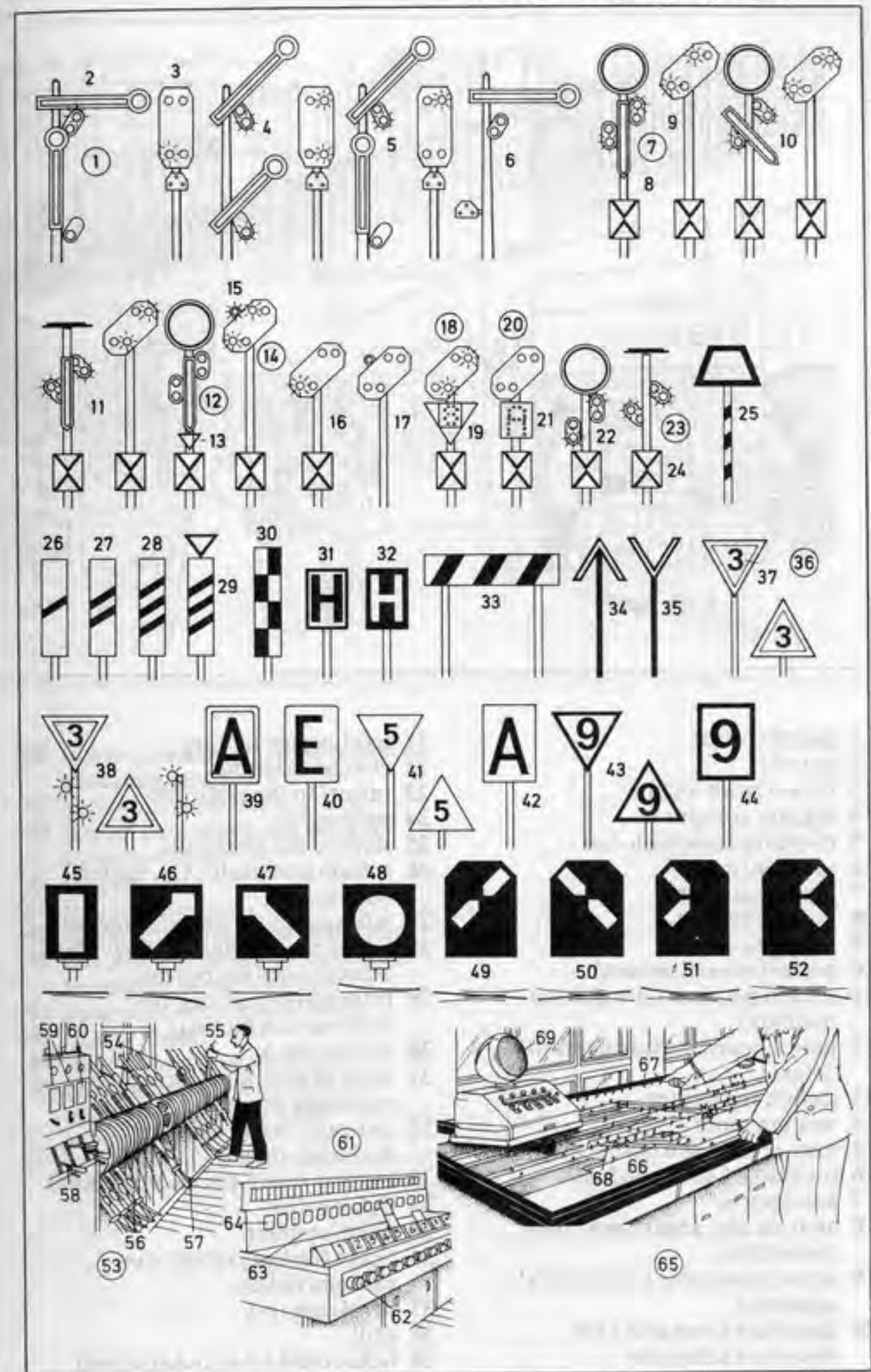





- |   |  |
|---|--|
| 1 parcels office  | 21 left luggage lockers  |
| 2 parcels   | 22 change machine  |
| 3 basket [with lock]                                    | 23 tunnel to the platforms   |
| 4 luggage counter                                       | 24 passengers  |
| 5 platform scale with dial                              | 25 steps to the platforms  |
| 6 suitcase (case)                                       | 26 station bookstall ( <i>Am.</i> station bookstand)                     |
| 7 luggage sticker                                       | 27 left luggage office (left luggage)                                    |
| 8 luggage receipt                                       | 28 travel centre ( <i>Am.</i> center); <i>also:</i> accommodation bureau |
| 9 luggage clerk   | 29 information office ( <i>Am.</i> information bureau)                   |
| 10 poster (advertisement)                               | 30 station clock   |
| 11 station post box ( <i>Am.</i> station mailbox)       | 31 bank branch with foreign exchange counter                             |
| 12 notice board indicating train delays                 | 32 indicator board showing exchange rates                                |
| 13 station restaurant                                   | 33 railway map ( <i>Am.</i> railroad map)                                |
| 14 waiting room   | 34 ticket office   |
| 15 map of the town (street map)                         | 35 ticket counter  |
| 16 timetable ( <i>Am.</i> schedule)                     | 36 ticket (railway ticket, <i>Am.</i> railroad ticket)                   |
| 17 hotel porter   | 37 revolving tray  |
| 18 arrivals and departures board (timetable)            | 38 grill   |
| 19 arrival timetable ( <i>Am.</i> arrival schedule)     | 39 ticket clerk ( <i>Am.</i> ticket agent)                               |
| 20 departure timetable ( <i>Am.</i> departure schedule) |  |

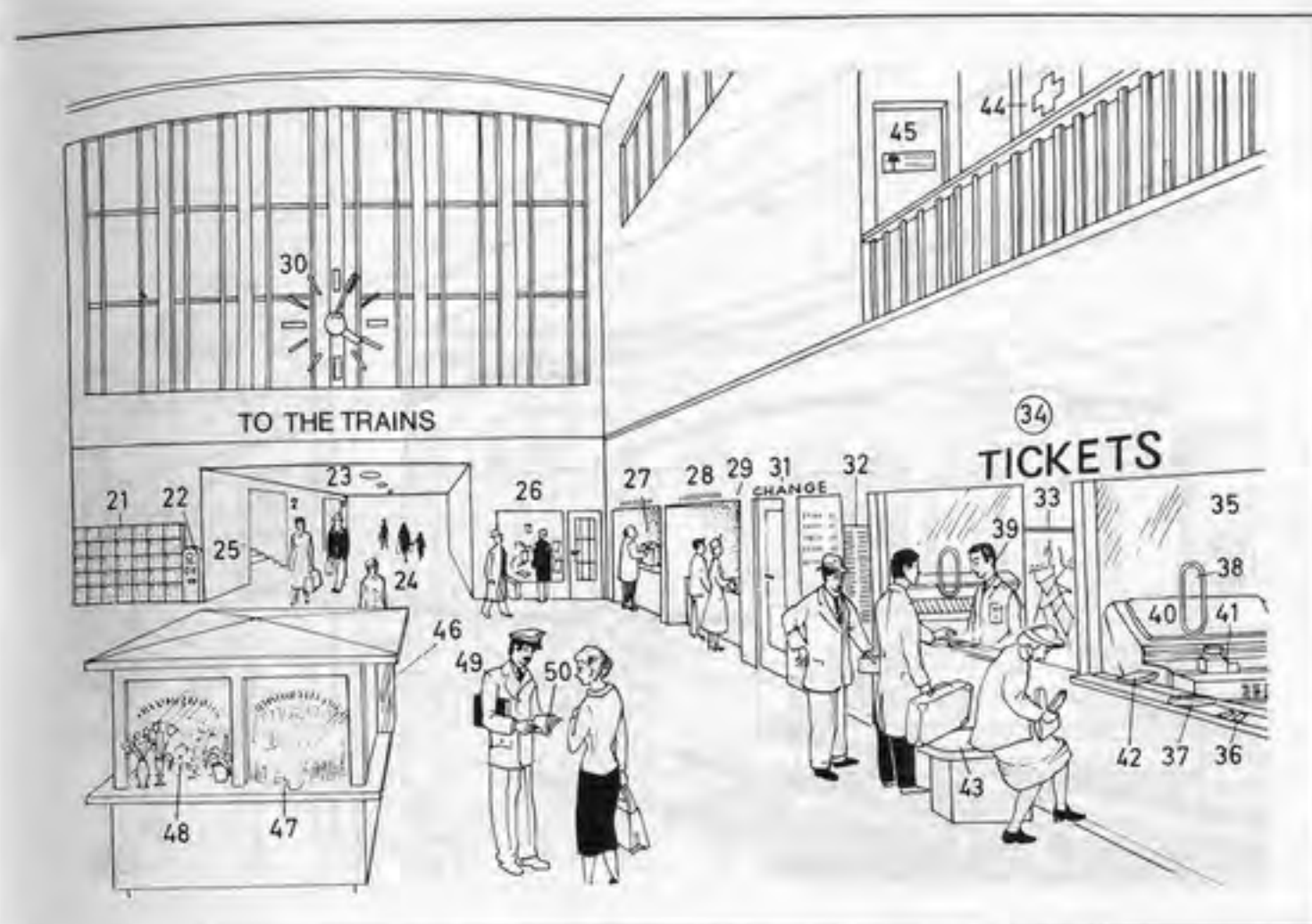

- |   |
|---|
| 40 ticket-printing machine (ticket-stamping machine)                      |
| 41 hand-operated ticket printer   |
| 42 pocket timetable ( <i>Am.</i> pocket train schedule)                   |
| 43 luggage rest   |
| 44 first aid station  |
| 45 Travellers' ( <i>Am.</i> Travelers') Aid                               |
| 46 telephone box (telephone booth, telephone kiosk, call box)             |
| 47 cigarettes and tobacco kiosk   |
| 48 flower stand   |
| 49 railway information clerk  |
| 50 official timetable (official railway guide, <i>Am.</i> train schedule) |



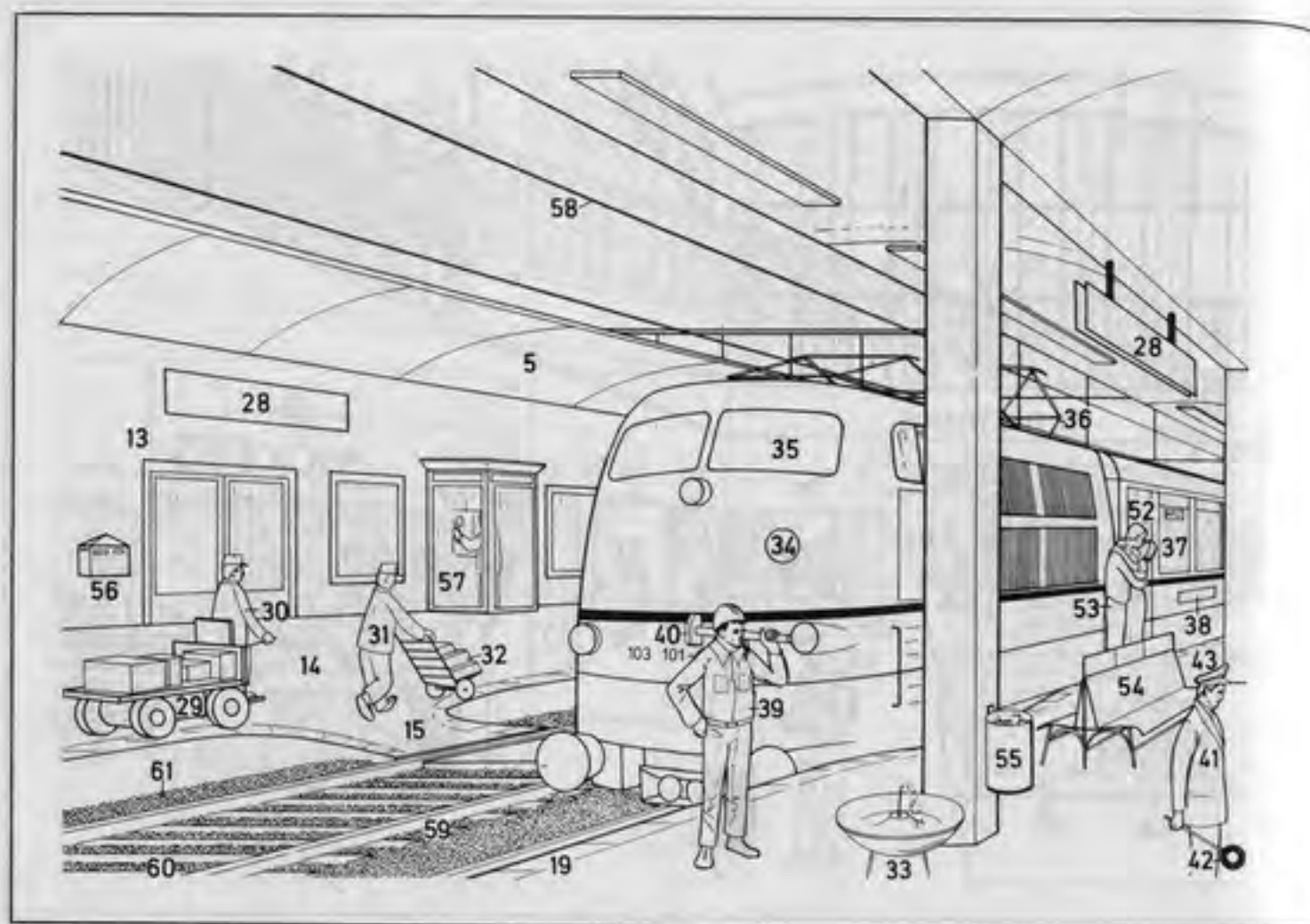

- |   |   |
|---|---|
| 1 platform  | 22 destination indicator                                |
| 2 steps to the platform                               | 23 departure time indicator                             |
| 3 bridge to the platforms                             | 24 delay indicator                                      |
| 4 platform number                                     | 25 suburban train, a railcar                            |
| 5 platform roofing                                    | 26 special compartment                                  |
| 6 passengers  | 27 platform loudspeaker                                 |
| 7-12 luggage  | 28 station sign   |
| 7 suitcase (case)                                     | 29 electric trolley (electric truck)                    |
| 8 luggage label                                       | 30 loading foreman                                      |
| 9 hotel sticker                                       | 31 porter ( <i>Am.</i> redcap)                          |
| 10 travelling ( <i>Am.</i> traveling) bag             | 32 barrow   |
| 11 hat box  | 33 drinking fountain                                    |
| 12 umbrella, a walking-stick umbrella                 | 34 electric Trans-Europe Express; also: Intercity train |
| 13 main building; also: offices                       | 35 electric locomotive, an express locomotive           |
| 14 platform   | 36 collector bow (sliding bow)                          |
| 15 crossing   | 37 secretarial compartment                              |
| 16 news trolley                                       | 38 destination board                                    |
| 17 news vendor ( <i>Am.</i> news dealer)              | 39 wheel tapper   |
| 18 reading matter for the journey                     | 40 wheel-tapping hammer                                 |
| 19 edge of the platform                               | 41 station foreman                                      |
| 20 railway policeman ( <i>Am.</i> railroad policeman) | 42 signal   |
| 21 destination board                                  | 43 red cap  |

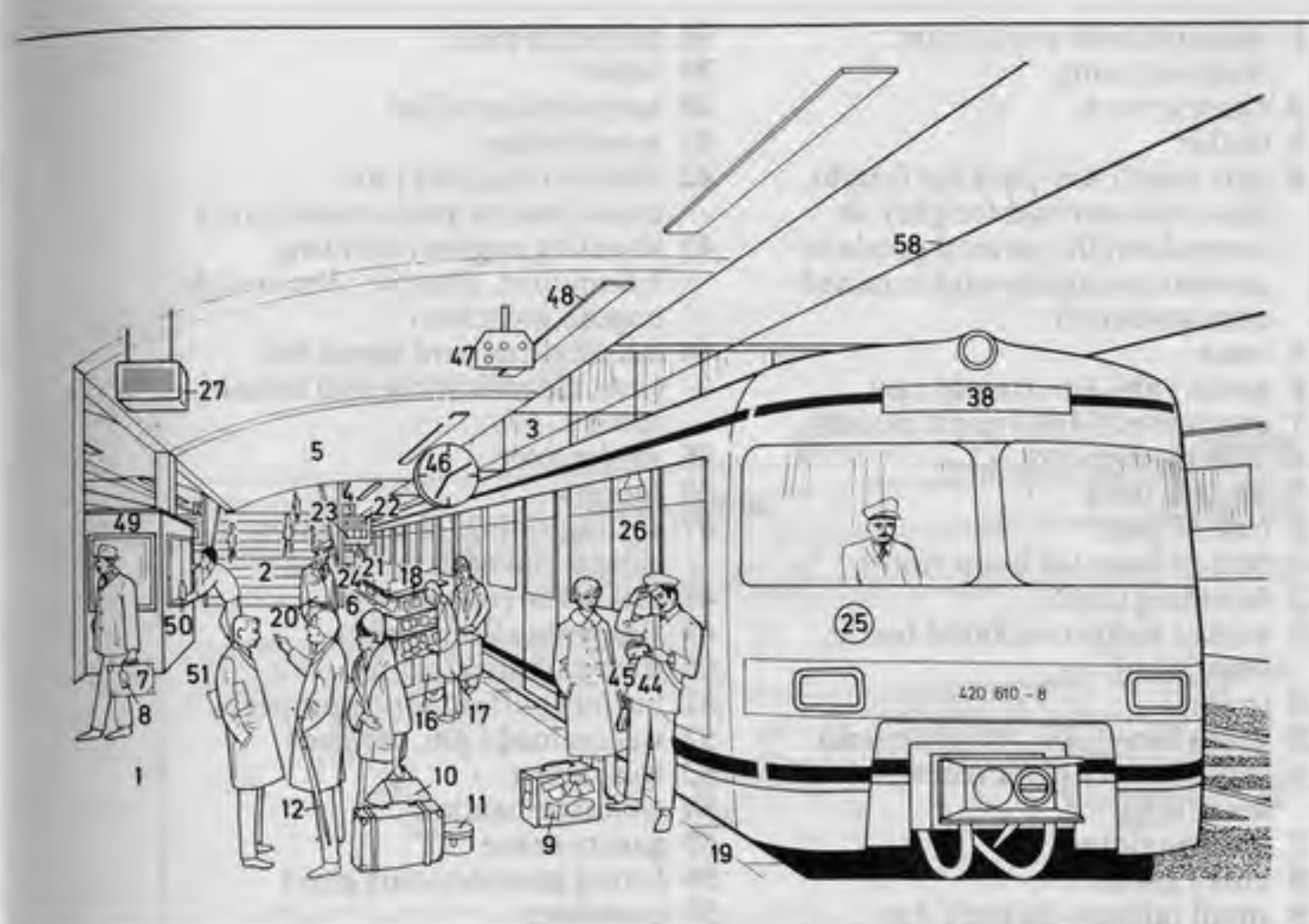

- |   |
|---|
| 44 inspector  |
| 45 pocket timetable ( <i>Am.</i> pocket train schedule) |
| 46 platform clock                                       |
| 47 starting signal                                      |
| 48 platform lighting                                    |
| 49 refreshment kiosk                                    |
| 50 beer bottle  |
| 51 newspaper  |
| 52 parting kiss   |
| 53 embrace  |
| 54 platform seat  |
| 55 litter bin ( <i>Am.</i> litter basket)               |
| 56 platform post box ( <i>Am.</i> platform mailbox)     |
| 57 platform telephone                                   |
| 58 trolley wire (overhead contact wire)                 |
| 59-61 track   |
| 59 rail   |
| 60 sleeper ( <i>Am.</i> tie, crosstie)                  |
| 61 ballast (bed)  |



- |   |   |
|---|---|
| 1 ramp (vehicle ramp); <i>sim.</i> :<br>livestock ramp  | 38 rail (slide rail)  |
| 2 electric truck  | 39 roller   |
| 3 trailer   | 40 weighbridge office   |
| 4 part loads ( <i>Am.</i> package freight,<br>less-than-carload freight); <i>in</i><br><i>general traffic</i> : general goods in<br>general consignments (in mixed<br>consignments) | 41 weighbridge  |
| 5 crate   | 42 marshalling yard ( <i>Am.</i><br>classification yard, switch yard)                       |
| 6 goods van ( <i>Am.</i> freight car)   | 43 shunting engine (shunting<br>locomotive, shunter, <i>Am.</i> switch<br>engine, switcher) |
| 7 goods shed ( <i>Am.</i> freight house)  | 44 marshalling yard signal box<br>( <i>Am.</i> classification yard switch<br>tower)         |
| 8 loading strip   | 45 yardmaster   |
| 9 loading dock  | 46 hump   |
| 10 bale of peat   | 47 sorting siding (classification<br>siding, classification track)                          |
| 11 bale of linen (of linen cloth)   | 48 rail brake (retarder)  |
| 12 fastening (cord)   | 49 slipper brake (slipper)  |
| 13 wicker bottle (wickered bottle,<br>demijohn)   | 50 storage siding (siding)  |
| 14 trolley  | 51 buffer (buffers, <i>Am.</i> bumper)  |
| 15 goods lorry ( <i>Am.</i> freight truck)  | 52 wagon load ( <i>Am.</i> carload)   |
| 16 forklift truck (fork truck,<br>forklift)   | 53 warehouse  |
| 17 loading siding   | 54 container station  |
| 18 bulky goods  | 55 gantry crane   |
| 19 small railway-owned ( <i>Am.</i><br>railroad-owned) container  | 56 lifting gear (hoisting gear)   |
| 20 showman's caravan ( <i>sim.</i> : circus<br>caravan)   | 57 container  |
| 21 flat wagon ( <i>Am.</i> flat freight car)  | 58 container wagon ( <i>Am.</i> container<br>car)   |
| 22 loading gauge ( <i>Am.</i> gage)   | 59 semi-trailer   |
| 23 bale of straw  |   |
| 24 flat wagon ( <i>Am.</i> flatcar) with<br>side stakes   |   |
| 25 fleet of lorries ( <i>Am.</i> trucks)  |   |
| 26-39 goods shed ( <i>Am.</i> freight<br>house)   |   |
| 26 goods office (forwarding office,<br><i>Am.</i> freight office)   |   |
| 27 part-load goods ( <i>Am.</i> package<br>freight)   |   |
| 28 forwarding agent ( <i>Am.</i> freight<br>agent, shipper)   |   |
| 29 loading foreman  |   |
| 30 consignment note (waybill)   |   |
| 31 weighing machine   |   |
| 32 pallet   |   |
| 33 porter   |   |
| 34 electric cart (electric truck)   |   |
| 35 trailer  |   |
| 36 loading supervisor   |   |
| 37 goods shed door ( <i>Am.</i> freight<br>house door)  |   |

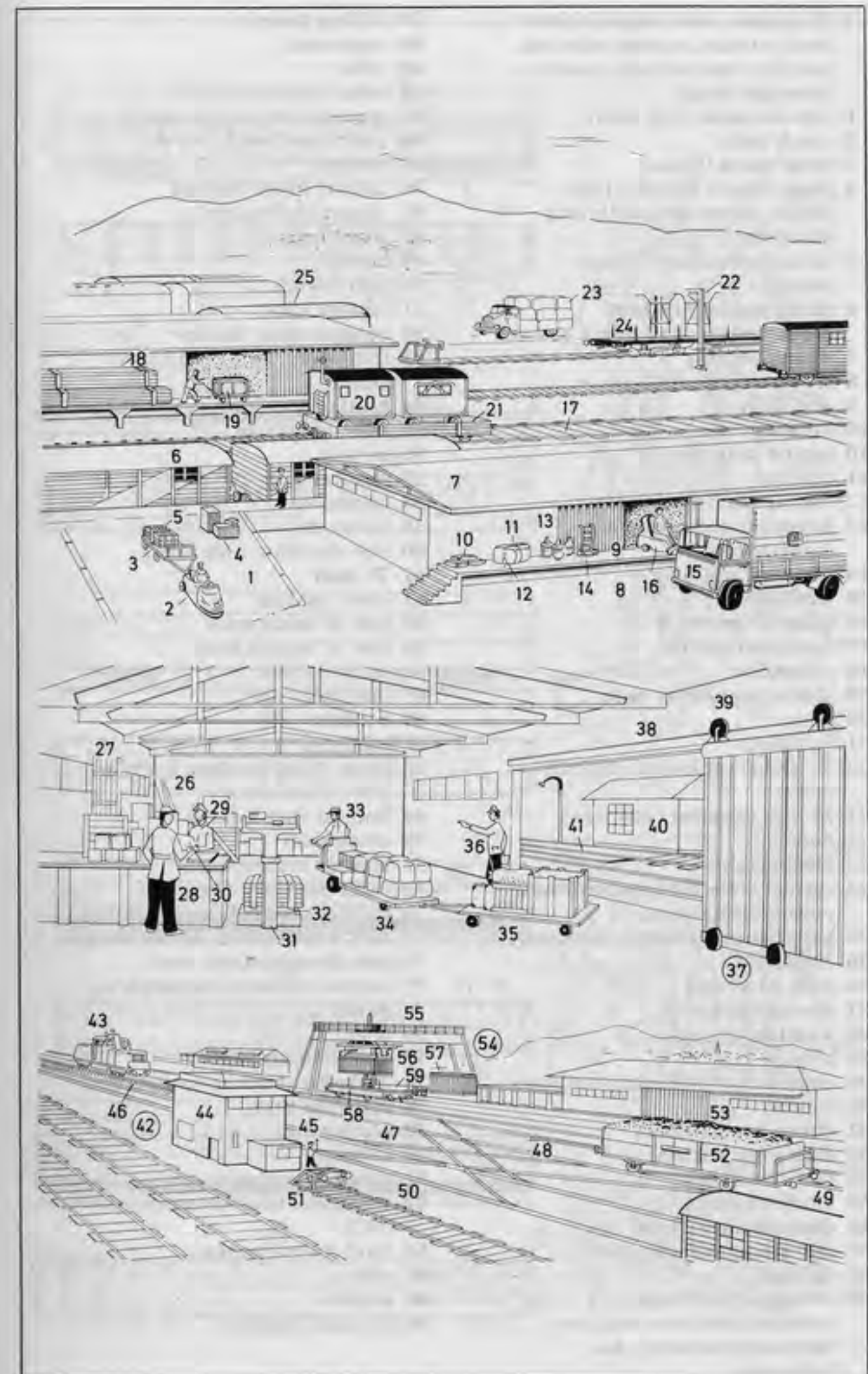



1-21 express train coach (express train carriage, express train car, corridor compartment coach), a passenger coach  
 1 side elevation (side view)  
 2 coach body  
 3 underframe (frame)  
 4 bogie (truck) with steel and rubber suspension and shock absorbers  
 5 battery containers (battery boxes)  
 6 steam and electric heat exchanger for the heating system  
 7 sliding window  
 8 rubber connecting seal  
 9 ventilator  
 10-21 plan  
 10 second-class section  
 11 corridor  
 12 folding seat (tip-up seat)  
 13 passenger compartment (compartment)  
 14 compartment door  
 15 washroom  
 16 toilet (lavatory, WC)  
 17 first-class section  
 18 swing door  
 19 sliding connecting door  
 20 door  
 21 vestibule  
 22-32 dining car (restaurant car, diner)  
 22-25 side elevation (side view)  
 22 door  
 23 loading door  
 24 current collector for supplying power during stops  
 25 battery boxes (battery containers)  
 26-32 plan  
 26 staff washroom  
 27 storage cupboard  
 28 washing-up area  
 29 kitchen  
 30 electric oven with eight hotplates  
 31 counter  
 32 dining compartment  
 33 dining car kitchen  
 34 chef (head cook)  
 35 kitchen cabinet  
 36 sleeping car (sleeper)  
 37 side elevation (side view)  
 38-42 plan  
 38 two-seat twin-berth compartment (two-seat two-berth compartment, *Am.* bedroom)

39 folding doors  
 40 washstand  
 41 office  
 42 toilet (lavatory, WC)  
 43 express train compartment  
 44 upholstered reclining seat  
 45 armrest  
 46 ashtray in the armrest  
 47 adjustable headrest  
 48 antimacassar  
 49 mirror  
 50 coat hook  
 51 luggage rack  
 52 compartment window  
 53 fold-away table (pull-down table)  
 54 heating regulator  
 55 litter receptacle  
 56 curtain  
 57 footrest  
 58 corner seat  
 59 open car  
 60 side elevation (side view)  
 61-72 plan  
 61 open carriage  
 62 row of single seats  
 63 row of double seats  
 64 reclining seat  
 65 seat upholstery  
 66 backrest  
 67 headrest  
 68 down-filled headrest cushion with nylon cover  
 69 armrest with ashtray  
 70 cloakroom  
 71 luggage compartment  
 72 toilet (lavatory, WC)  
 73 buffet car (quick-service buffet car), a self-service restaurant car  
 74 side elevation (side view)  
 75 current collector for supplying power  
 76 plan  
 77 dining compartment  
 78-79 buffet (buffet compartment)  
 78 customer area  
 79 serving area  
 80 kitchen  
 81 staff compartment  
 82 staff toilet (staff lavatory, staff WC)  
 83 food compartments  
 84 plates  
 85 cutlery  
 86 till (cash register)

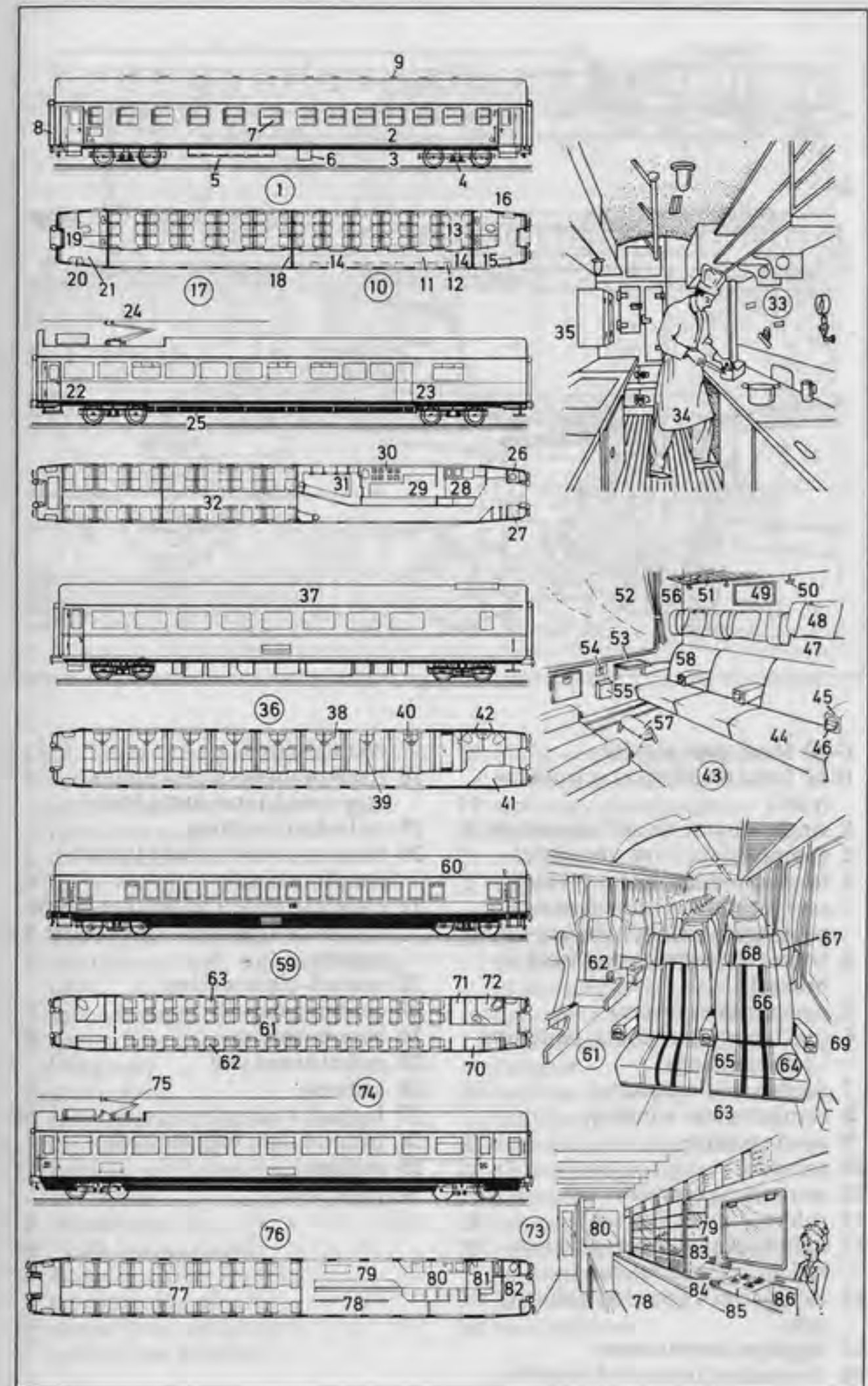

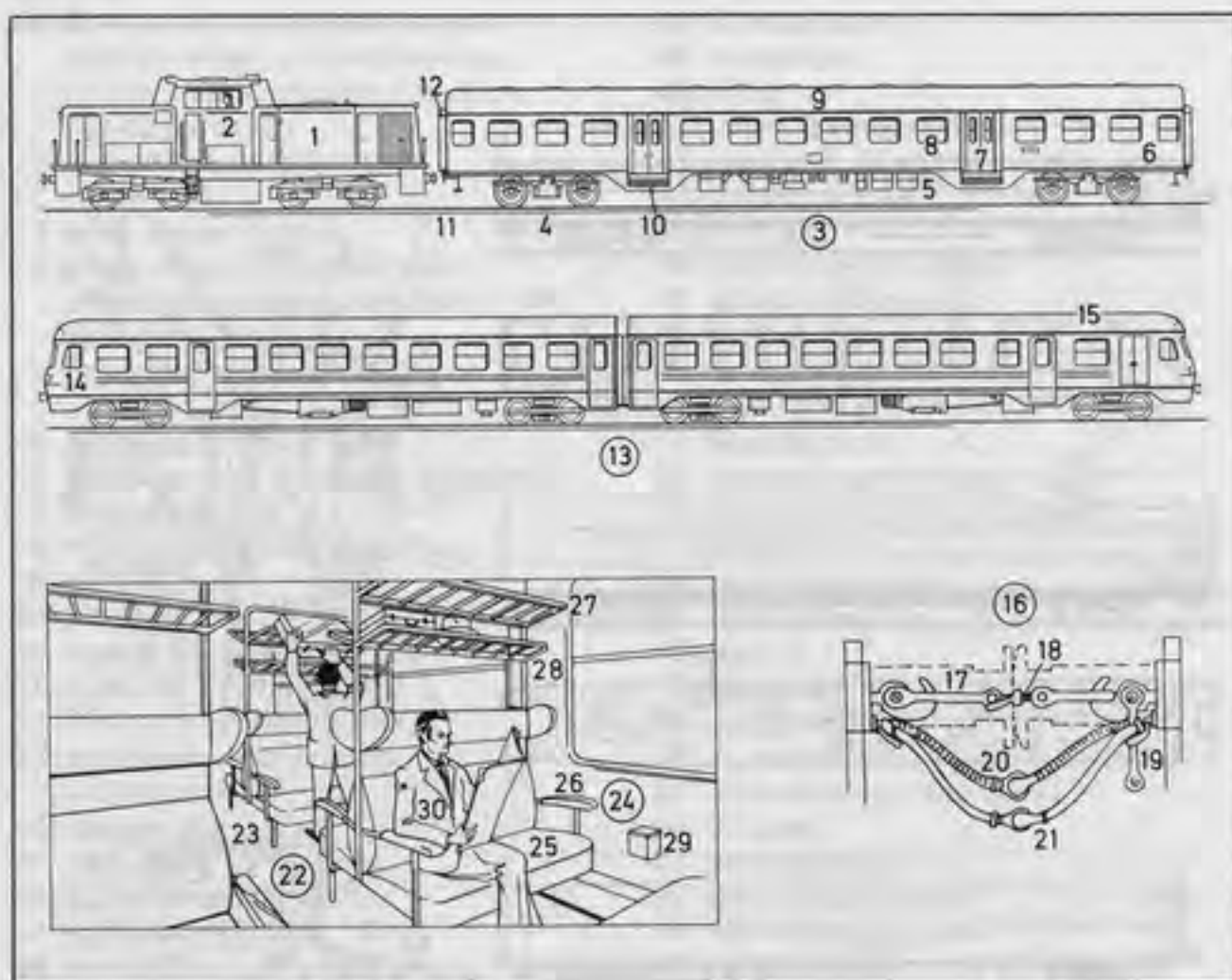

**1-30 local train service****1-12 local train (short-distance train)**

- 1 single-engine diesel locomotive
- 2 engine driver (*Am.* engineer)
- 3 four-axled coach (four-axled car) for short-distance routes, a passenger coach (passenger car)
- 4 bogie (truck) [with disc (disk) brakes]
- 5 underframe (frame)
- 6 coach body with metal panelling (*Am.* paneling)
- 7 double folding doors
- 8 compartment window
- 9 open carriage
- 10 entrance
- 11 connecting corridor
- 12 rubber connecting seal
- 13 light railcar, a short-distance railcar, a diesel railcar
- 14 cab (driver's cab, *Am.* engineer's cab)
- 15 luggage compartment
- 16 connecting hoses and coupling

- 17 coupling link
- 18 tensioning device (coupling screw with tensioning lever)
- 19 unlinked coupling
- 20 heating coupling hose (steam coupling hose)
- 21 coupling hose (connecting hose) for the compressed-air braking system
- 22 second-class section
- 23 central gangway
- 24 compartment
- 25 upholstered seat
- 26 armrest
- 27 luggage rack
- 28 hat and light luggage rack
- 29 ashtray
- 30 passenger

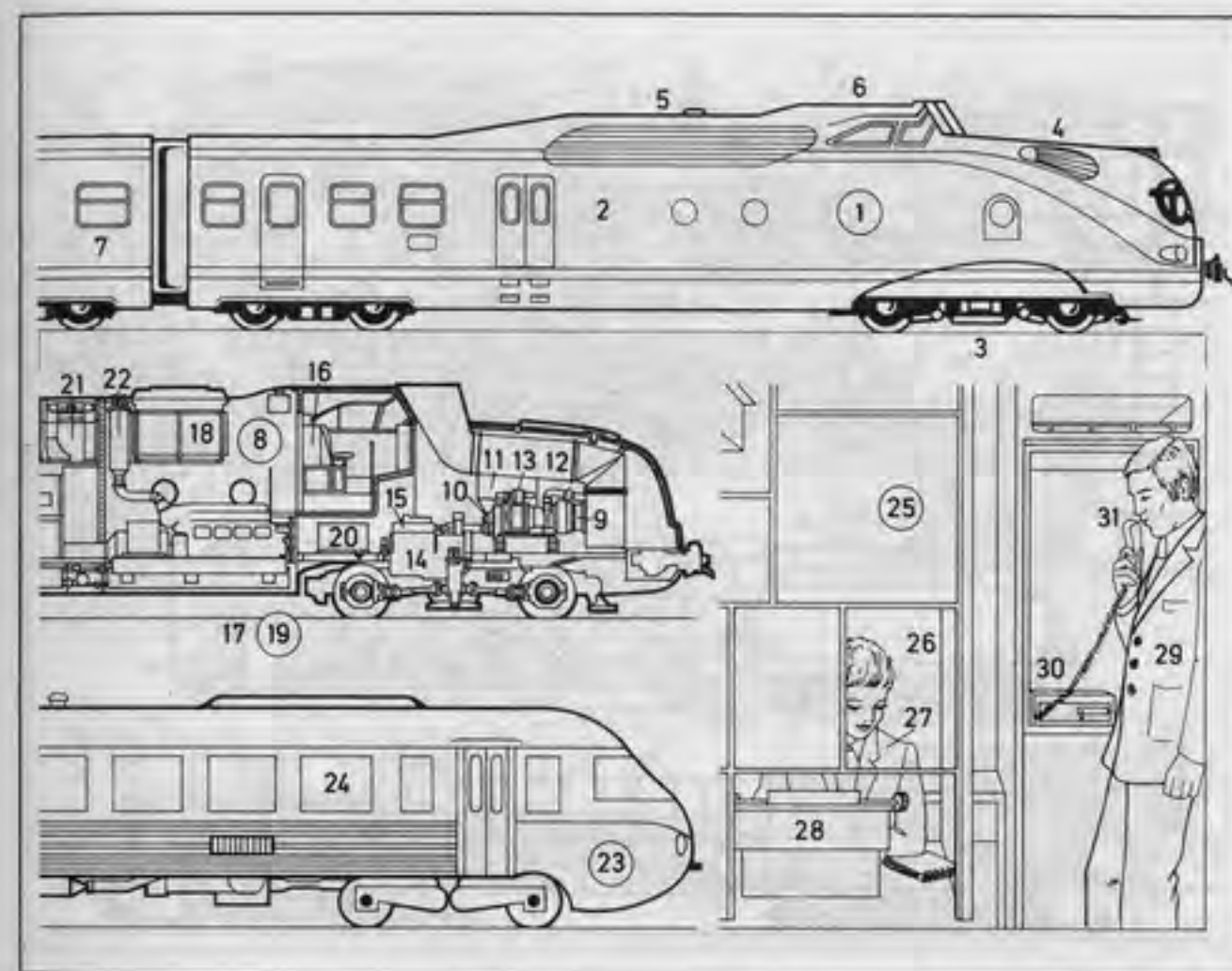
**1-22 Trans-Europe Express**

- 1 German Federal Railway trainset, a diesel trainset or gas turbine trainset
- 2 driving unit
- 3 drive wheel unit
- 4 main engine
- 5 diesel generator unit
- 6 cab (driver's cab, *Am.* engineer's cab)
- 7 second coach
- 8 gas turbine driving unit [diagram]
- 9 gas turbine
- 10 turbine transmission
- 11 air intake
- 12 exhaust with silencers (*Am.* mufflers)
- 13 dynastarter
- 14 Voith transmission
- 15 heat exchanger for the transmission oil
- 16 gas turbine controller
- 17 gas turbine fuel tank

- 18 oil-to-air cooling unit for transmission and turbine
- 19 auxiliary diesel engine
- 20 fuel tank
- 21 cooling unit
- 22 exhaust with silencers (*Am.* mufflers)
- 23 **Société Nationale des Chemins de Fer Français (SNCF)** experimental trainset with six-cylinder underfloor diesel engine and twin-shaft gas turbine
- 24 turbine unit with silencers (*Am.* mufflers)
- 25 secretarial compartment
- 26 typing compartment
- 27 secretary
- 28 typewriter
- 29 travelling (*Am.* traveling) salesman
- 30 dictating machine
- 31 microphone



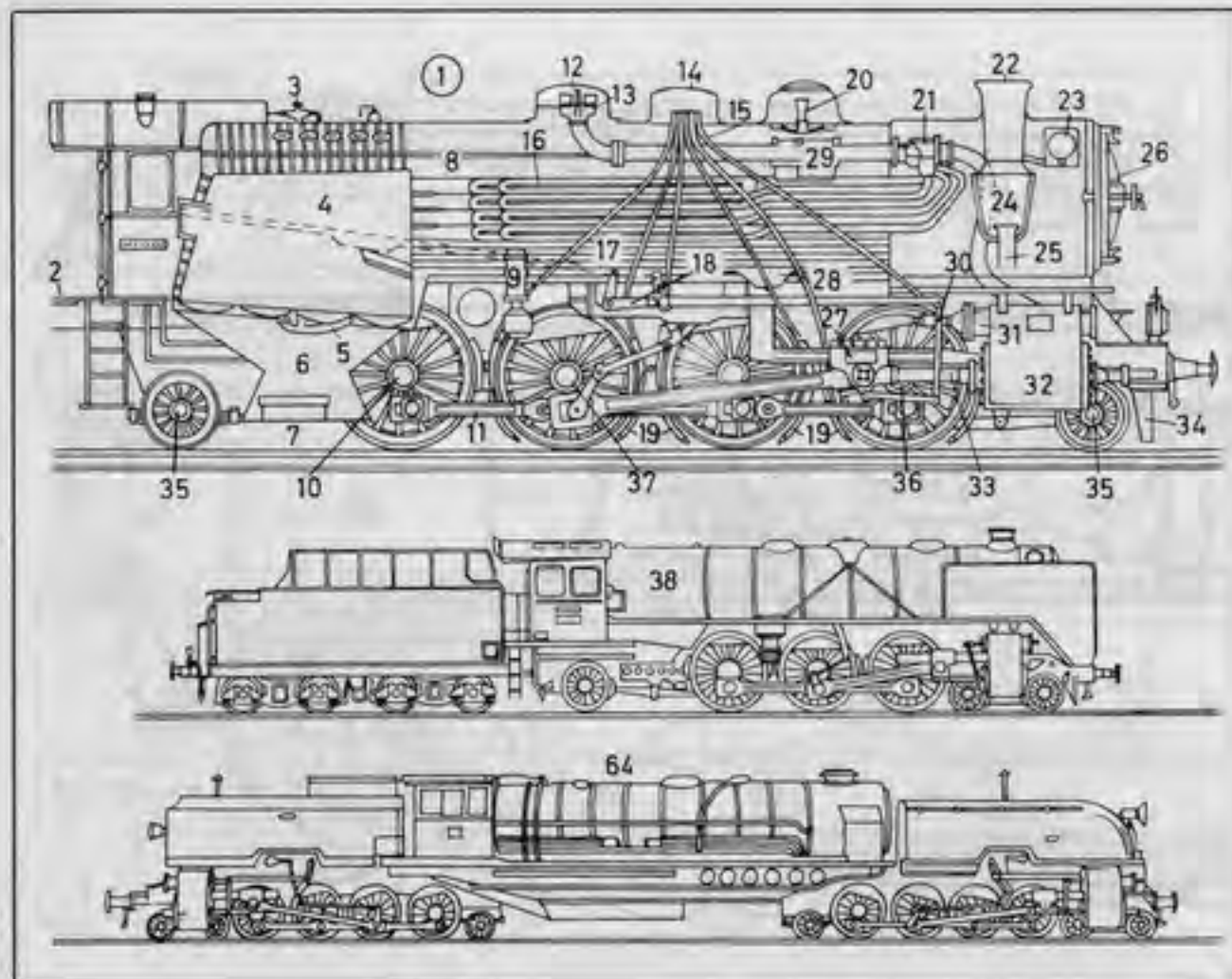

- |   |   |
|---|---|
| 1-69 steam locomotives                    | 21 steam collector  |
| 2-37 locomotive boiler and driving gear   | 22 chimney (smokestack, smoke outlet and waste steam exhaust) |
| 2 tender platform with coupling           | 23 feedwater preheater (feedwater heater, economizer)         |
| 3 safety valve for excess boiler pressure | 24 spark arrester   |
| 4 firebox                                 | 25 blast pipe   |
| 5 drop grate                              | 26 smokebox door  |
| 6 ashpan with damper doors                | 27 cross head   |
| 7 bottom door of the ashpan               | 28 mud drum   |
| 8 smoke tubes (flue tubes)                | 29 top feedwater tray   |
| 9 feed pump                               | 30 combination lever  |
| 10 axle bearing                           | 31 steam chest  |
| 11 connecting rod                         | 32 cylinder   |
| 12 steam dome                             | 33 piston rod with stuffing box (packing box)                 |
| 13 regulator valve (regulator main valve) | 34 guard iron (rail guard, <i>Am.</i> pilot, cowcatcher)      |
| 14 sand dome                              | 35 carrying axle (running axle, dead axle)                    |
| 15 sand pipes (sand tubes)                | 36 coupled axle   |
| 16 boiler (boiler barrel)                 | 37 driving axle   |
| 17 fire tubes or steam tubes              | 38 express locomotive with tender                             |
| 18 reversing gear (steam reversing gear)  |   |
| 19 sand pipes                             |   |
| 20 feed valve                             |   |

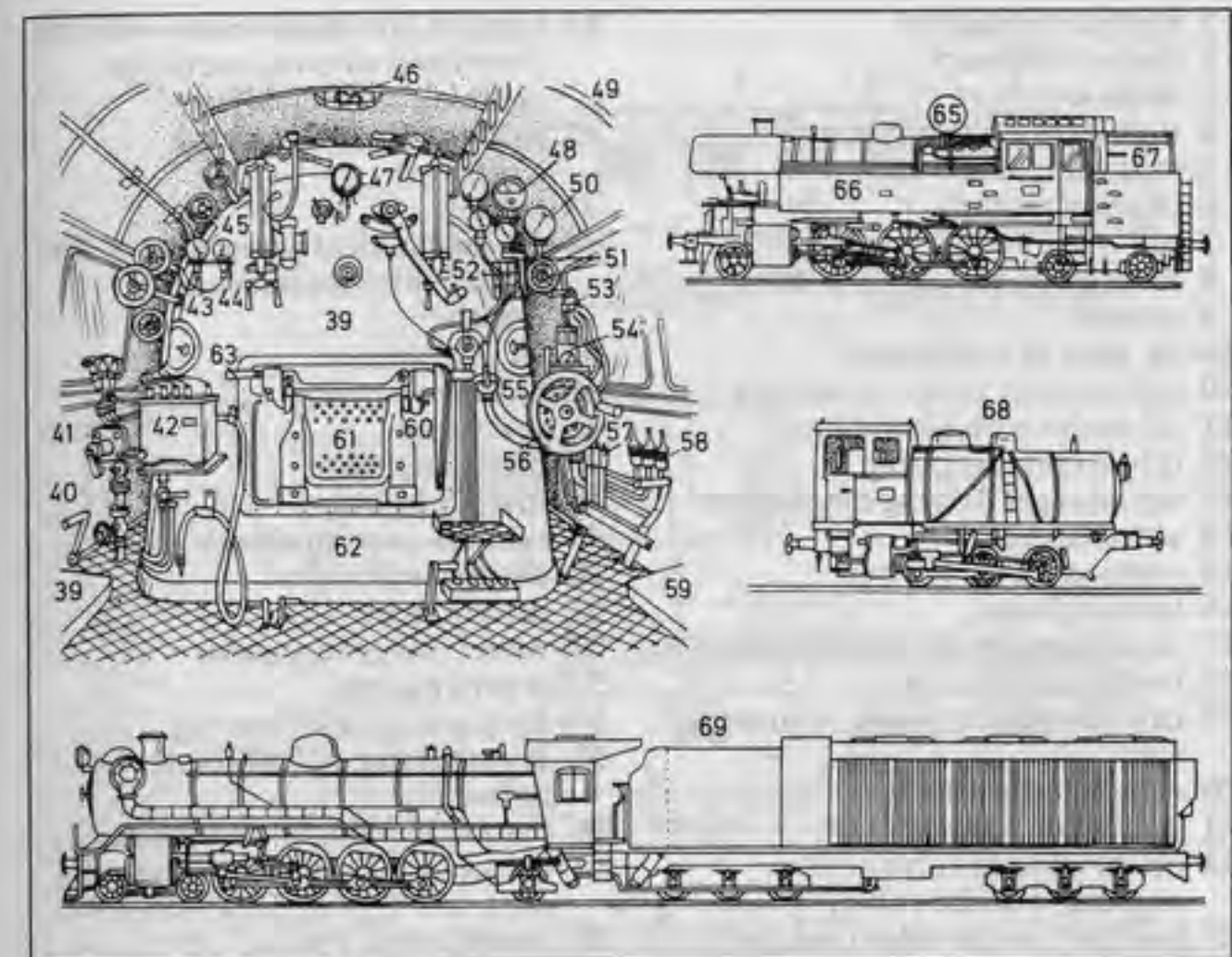

- |  |  |
|--|--|
| 39-63 cab (driver's cab, <i>Am.</i> engineer's cab)          | 54 speed recorder (tachograph)                               |
| 39 fireman's seat  | 55 sanding valve   |
| 40 drop grate lever  | 56 reversing wheel   |
| 41 line steam injector                                       | 57 emergency brake valve                                     |
| 42 automatic lubricant pump (automatic lubricator)           | 58 release valve   |
| 43 preheater pressure gauge ( <i>Am.</i> gage)               | 59 driver's seat ( <i>Am.</i> engineer's seat)               |
| 44 carriage heating pressure gauge ( <i>Am.</i> gage)        | 60 firehole shield   |
| 45 water gauge ( <i>Am.</i> gage)                            | 61 firehole door   |
| 46 light   | 62 vertical boiler   |
| 47 boiler pressure gauge ( <i>Am.</i> gage)                  | 63 firedoor handle handgrip                                  |
| 48 distant-reading temperature gauge ( <i>Am.</i> gage)      | 64 articulated locomotive (Garratt locomotive)               |
| 49 cab (driver's cab, <i>Am.</i> engineer's cab)             | 65 tank locomotive   |
| 50 brake pressure gauge ( <i>Am.</i> gage)                   | 66 water tank  |
| 51 whistle valve handle                                      | 67 fuel tender   |
| 52 driver's timetable ( <i>Am.</i> engineer's schedule)      | 68 steam storage locomotive (fireless locomotive)            |
| 53 driver's brake valve ( <i>Am.</i> engineer's brake valve) | 69 condensing locomotive (locomotive with condensing tender) |



- |   |  |
|---|--|
| 1 electric locomotive   | 41 contact wire maintenance vehicle<br>(overhead wire maintenance vehicle), a diesel railcar |
| 2 current collector   | 42 work platform (working platform)  |
| 3 main switch   | 43 ladder  |
| 4 high-tension transformer  | 44-54 mechanical equipment of the contact wire maintenance vehicle                           |
| 5 roof cable  | 44 air compressor  |
| 6 traction motor  | 45 blower oil pump   |
| 7 inductive train control system                                    | 46 generator   |
| 8 main air reservoir  | 47 diesel engine   |
| 9 whistle   | 48 injection pump  |
| 10-18 plan of locomotive  | 49 silencer ( <i>Am.</i> muffler)  |
| 10 transformer with tap changer                                     | 50 change-speed gear   |
| 11 oil cooler with blower   | 51 cardan shaft  |
| 12 oil-circulating pump   | 52 wheel flange lubricator   |
| 13 tap changer driving mechanism                                    | 53 reversing gear  |
| 14 air compressor   | 54 torque converter bearing  |
| 15 traction motor blower  | 55 accumulator railcar (battery railcar)   |
| 16 terminal box   | 56 battery box (battery container)   |
| 17 capacitors for auxiliary motors                                  | 57 cab (driver's cab, <i>Am.</i> engineer's cab)   |
| 18 commutator cover   | 58 second-class seating arrangement  |
| 19 cab (driver's cab, <i>Am.</i> engineer's cab)                    | 59 toilet (lavatory, WC)   |
| 20 controller handwheel   | 60 fast electric multiple-unit train   |
| 21 dead man's handle  | 61 front railcar   |
| 22 driver's brake valve ( <i>Am.</i> engineer's brake valve)        | 62 driving trailer car   |
| 23 ancillary brake valve (auxiliary brake valve)                    |  |
| 24 pressure gauge ( <i>Am.</i> gage)                                |  |
| 25 bypass switch for the dead man's handle                          |  |
| 26 tractive effort indicator  |  |
| 27 train heating voltage indicator                                  |  |
| 28 contact wire voltage indicator (overhead wire voltage indicator) |  |
| 29 high-tension voltage indicator                                   |  |
| 30 on/off switch for the current collector                          |  |
| 31 main switch  |  |
| 32 sander switch (sander control)                                   |  |
| 33 anti-skid brake switch   |  |
| 34 visual display for the ancillary systems                         |  |
| 35 speedometer  |  |
| 36 running step indicator   |  |
| 37 clock  |  |
| 38 controls for the inductive train control system                  |  |
| 39 cab heating switch   |  |
| 40 whistle lever  |  |

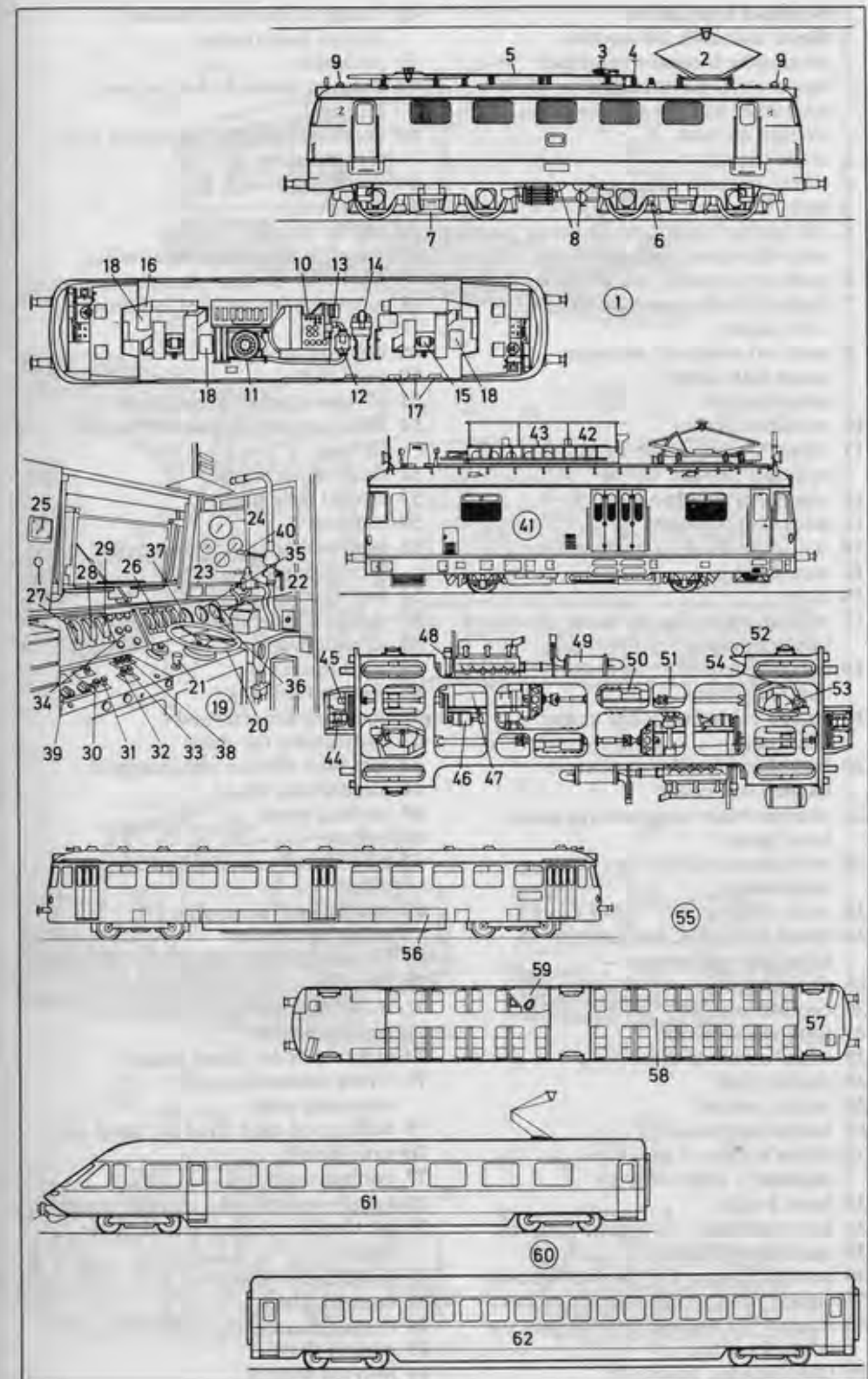



- 1-84 diesel locomotives
- 1 diesel-hydraulic locomotive, a mainline locomotive (diesel locomotive) for medium passenger and goods service (freight service)
- 2 bogie (truck)
- 3 wheel and axle set
- 4 main fuel tank
- 5 cab (driver's cab, *Am.* engineer's cab) of a diesel locomotive
- 6 main air pressure gauge (*Am.* gage)
- 7 brake cylinder pressure gauge (*Am.* gage)
- 8 main air reservoir pressure gauge (*Am.* gage)
- 9 speedometer
- 10 auxiliary brake
- 11 driver's brake valve (*Am.* engineer's brake valve)
- 12 controller handwheel
- 13 dead man's handle
- 14 inductive train control system
- 15 signal lights
- 16 clock
- 17 voltage meter for the train heating system
- 18 current meter for the train heating system
- 19 engine oil temperature gauge (*Am.* gage)
- 20 transmission oil temperature gauge (*Am.* gage)
- 21 cooling water temperature gauge (*Am.* gage)
- 22 revolution counter (rev counter, tachometer)
- 23 radio telephone
- 24 diesel-hydraulic locomotive [plan and elevation]
- 25 diesel engine
- 26 cooling unit
- 27 fluid transmission
- 28 wheel and axle drive
- 29 cardan shaft
- 30 starter motor
- 31 instrument panel
- 32 driver's control desk (*Am.* engineer's control desk)
- 33 hand brake
- 34 air compressor with electric motor
- 35 equipment locker
- 36 heat exchanger for transmission oil
- 37 engine room ventilator
- 38 magnet for the inductive train control system
- 39 train heating generator
- 40 casing of the train heating system transformer
- 41 preheater
- 42 exhaust silencer (*Am.* exhaust muffler)
- 43 auxiliary heat exchanger for the transmission oil
- 44 hydraulic brake
- 45 tool box
- 46 starter battery
- 47 diesel-hydraulic locomotive for light and medium shunting service
- 48 exhaust silencer (*Am.* exhaust muffler)
- 49 bell and whistle
- 50 yard radio
- 51-67 elevation of locomotive
- 51 diesel engine with supercharged turbine
- 52 fluid transmission
- 53 output gear box
- 54 radiator
- 55 heat exchanger for the engine lubricating oil
- 56 fuel tank
- 57 main air reservoir
- 58 air compressor
- 59 sand boxes
- 60 reserve fuel tank
- 61 auxiliary air reservoir
- 62 hydrostatic fan drive
- 63 seat with clothes compartment
- 64 hand brake wheel
- 65 cooling water
- 66 ballast
- 67 engine and transmission control wheel
- 68 small diesel locomotive for shunting service
- 69 exhaust casing
- 70 horn
- 71 main air reservoir
- 72 air compressor
- 73 eight-cylinder diesel engine
- 74 Voith transmission with reversing gear
- 75 heating oil tank (fuel oil tank)
- 76 sand box
- 77 cooling unit
- 78 header tank for the cooling water
- 79 oil bath air cleaner (oil bath air filter)
- 80 hand brake wheel
- 81 control wheel
- 82 coupling
- 83 cardan shaft
- 84 louvred shutter

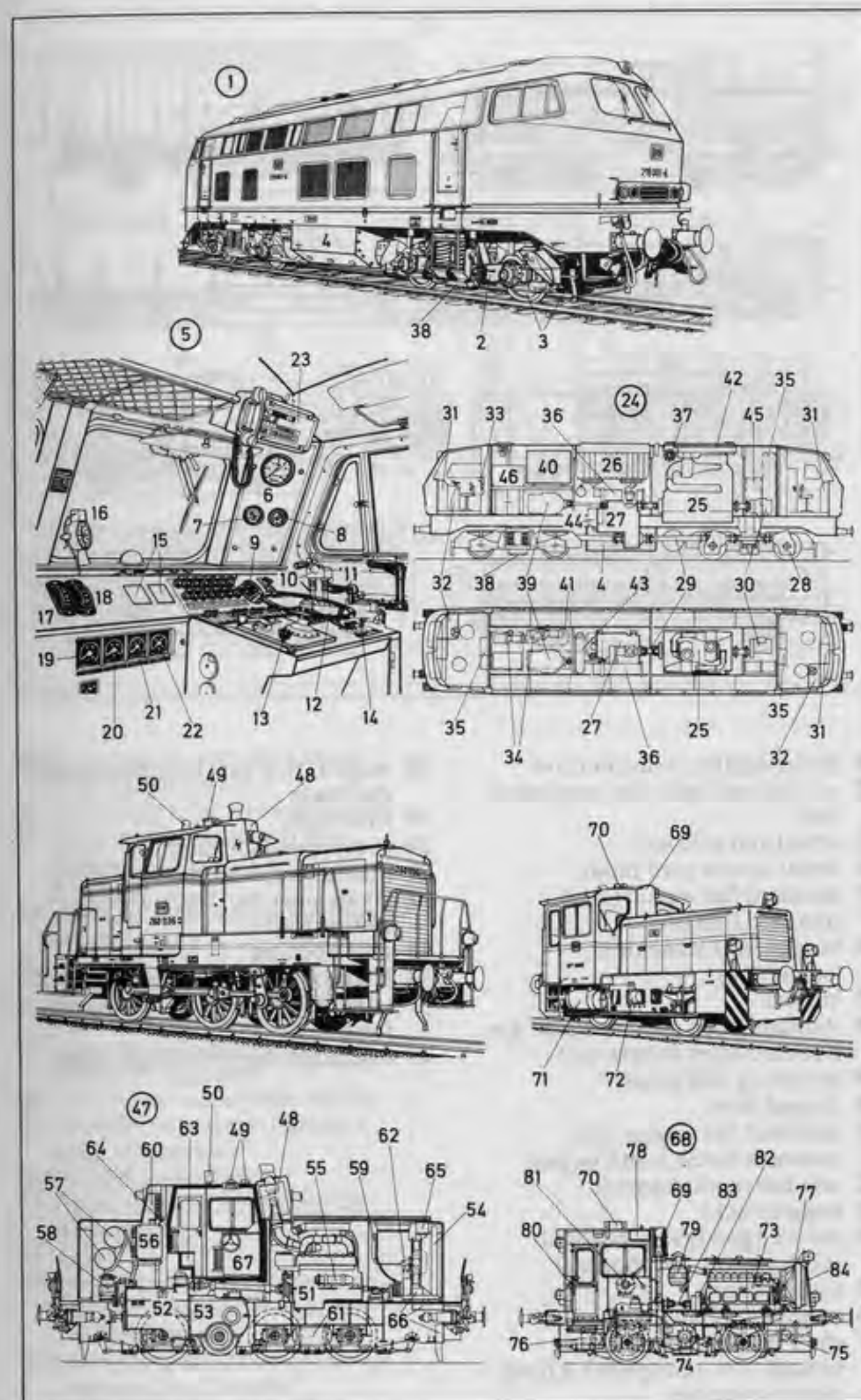



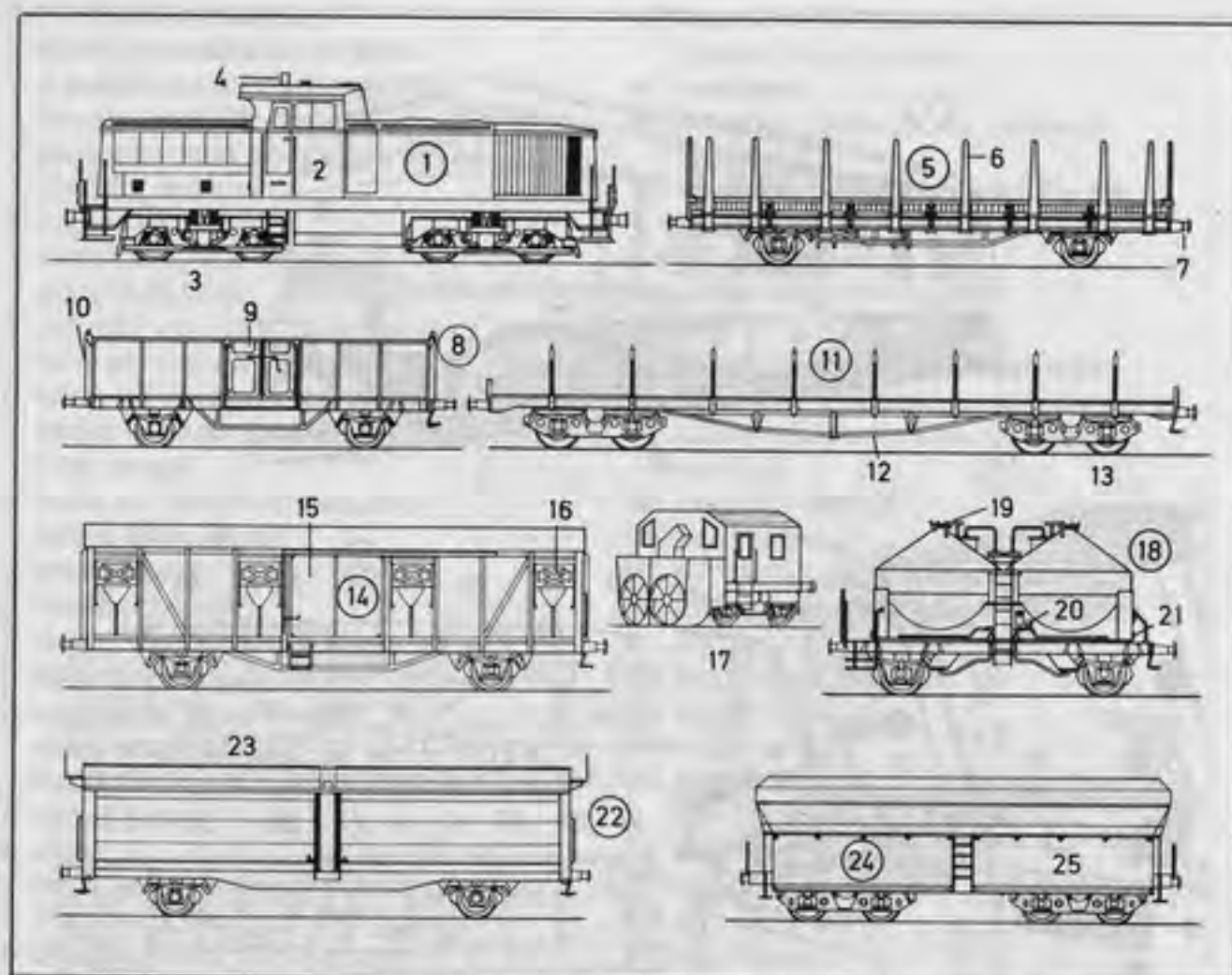

- |   |   |
|---|---|
| 1 diesel-hydraulic locomotive   | 18 wagon ( <i>Am. car</i> ) with pneumatic discharge                                    |
| 2 cab (driver's cab, <i>Am. engineer's cab</i> )                                    | 19 filler hole  |
| 3 wheel and axle set  | 20 compressed-air supply  |
| 4 aerial for the yard radio   | 21 discharge connection valve   |
| 5 standard flat wagon ( <i>Am. standard flatcar</i> )                               | 22 goods van ( <i>Am. boxcar</i> ) with sliding roof                                    |
| 6 hinged steel stanchion ( <i>stanchion</i> )                                       | 23 roof opening   |
| 7 buffers   | 24 bogie open self-discharge wagon ( <i>Am. bogie open self-discharge freight car</i> ) |
| 8 standard open goods wagon ( <i>Am. standard open freight car</i> )                | 25 discharge flap (discharge door)  |
| 9 revolving side doors  |   |
| 10 hinged front   |   |
| 11 standard flat wagon ( <i>Am. standard flatcar</i> ) with bogies                  |   |
| 12 sole bar reinforcement   |   |
| 13 bogie ( <i>truck</i> )   |   |
| 14 covered goods van (covered goods wagon, <i>Am. boxcar</i> )                      |   |
| 15 sliding door   |   |
| 16 ventilation flap   |   |
| 17 snow blower (rotary snow plough, <i>Am. snowplow</i> ), a track-clearing vehicle |   |

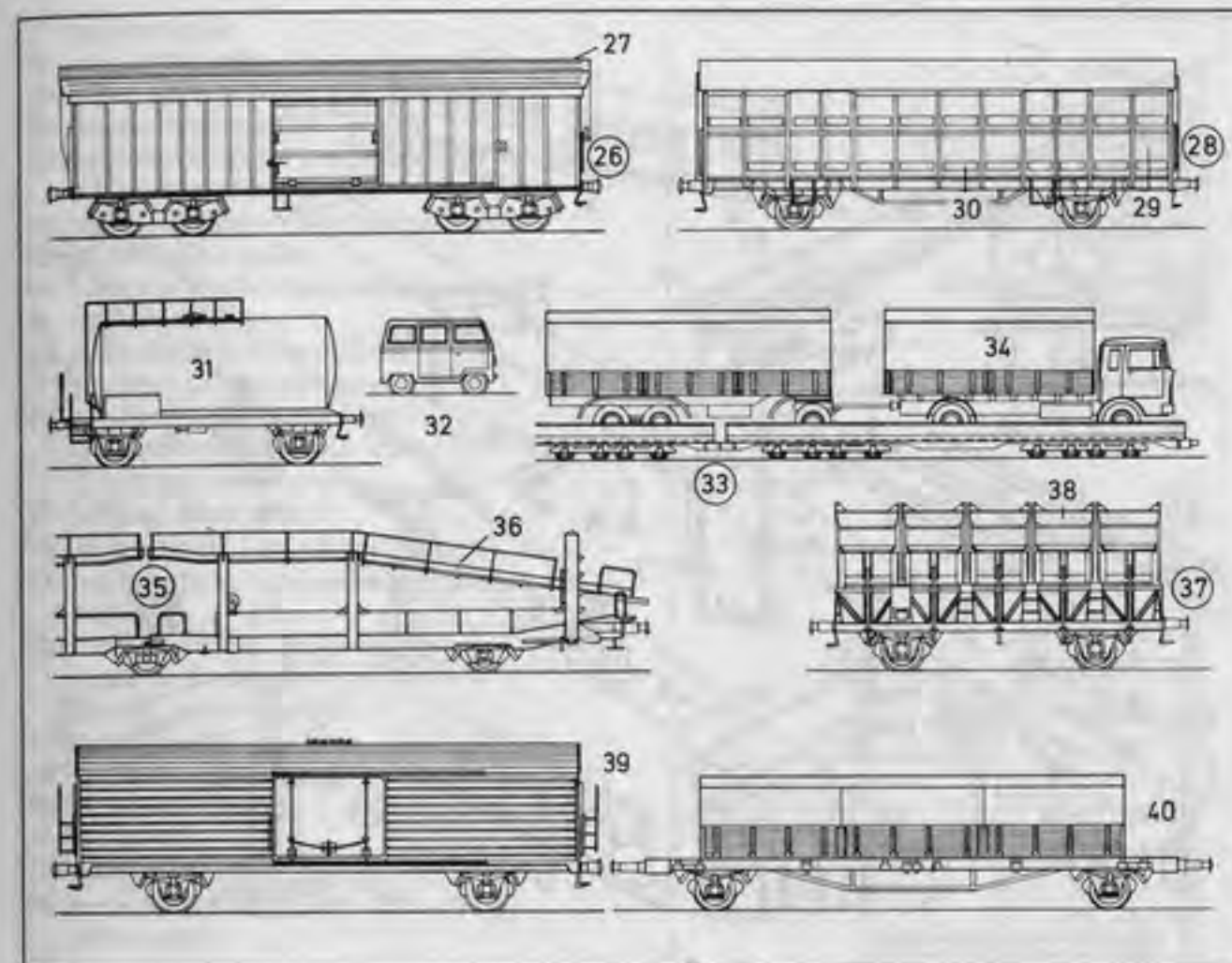

- |  |
|--|
| 26 bogie wagon with swivelling ( <i>Am. swiveling</i> ) roof                           |
| 27 swivelling ( <i>Am. swiveling</i> ) roof  |
| 28 large-capacity wagon ( <i>Am. large-capacity car</i> ) for small livestock          |
| 29 sidewall with ventilation flaps (slatted wall)                                      |
| 30 ventilation flap  |
| 31 tank wagon ( <i>Am. tank car</i> )  |
| 32 track inspection railcar  |
| 33 open special wagons ( <i>Am. open special freight cars</i> )                        |
| 34 lorry ( <i>Am. truck</i> ) with trailer   |
| 35 two-tier car carrier (double-deck car carrier)                                      |
| 36 hinged upper deck   |
| 37 tipper wagon ( <i>Am. dump car</i> ) with skips                                     |
| 38 skip  |
| 39 general-purpose refrigerator wagon (refrigerator van, <i>Am. refrigerator car</i> ) |
| 40 interchangeable bodies for flat wagons ( <i>Am. flatcars</i> )                      |



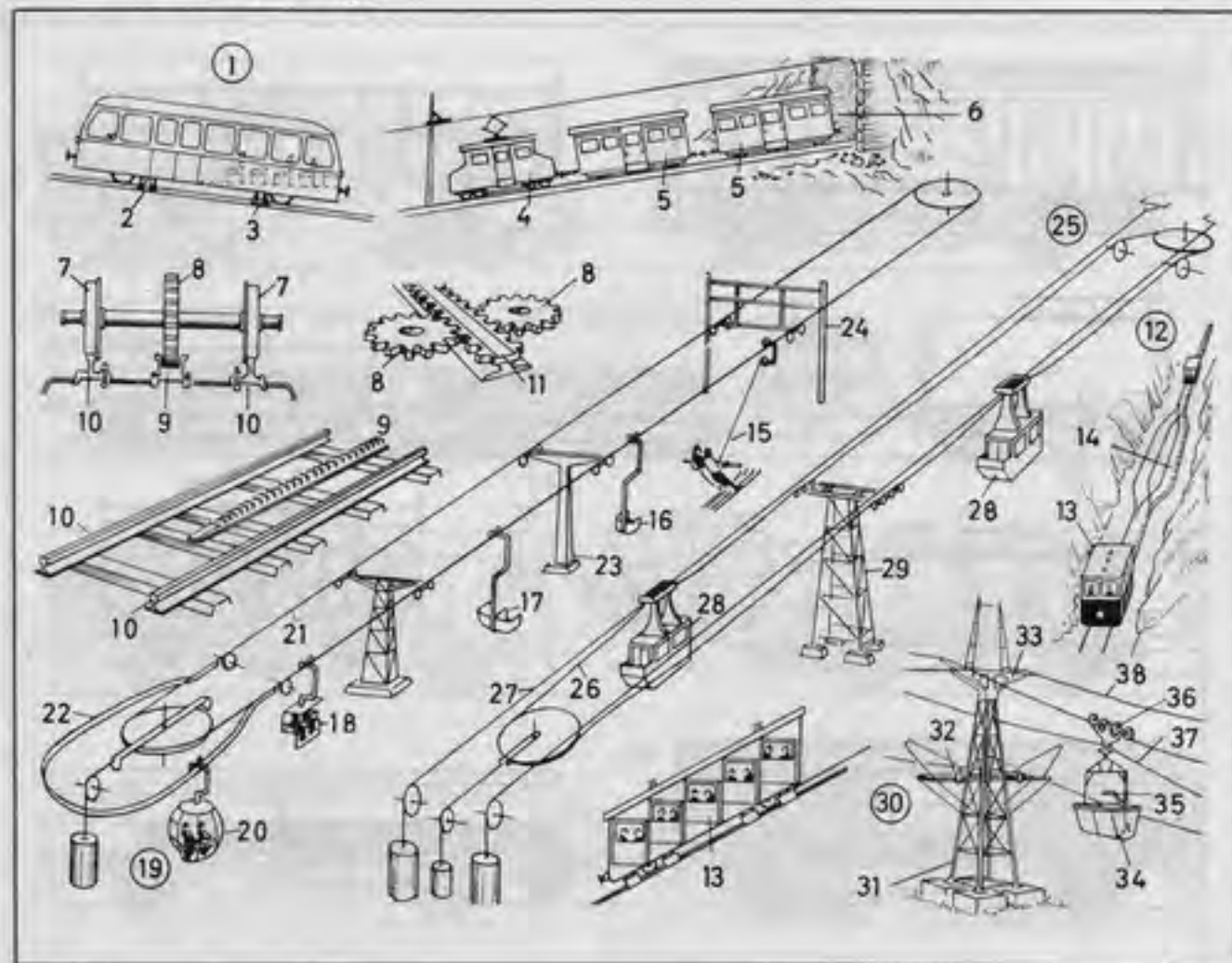

1-14 mountain railways (*Am. mountain railroads*)

- 1 adhesion railcar
- 2 drive
- 3 emergency brake
- 4-5 rack mountain railway (rack-and-pinion railway, cog railway, *Am. cog railroad, rack railroad*)
- 4 electric rack railway locomotive (*Am. electric rack railroad locomotive*)
- 5 rack railway coach (rack railway trailer, *Am. rack railroad car*)
- 6 tunnel
- 7-11 rack railways (rack-and-pinion railways, *Am. rack railroads*) [systems]
- 7 running wheel (carrying wheel)
- 8 driving pinion
- 9 rack [with teeth machined on top edge]
- 10 rail
- 11 rack [with teeth on both outer edges]
- 12 funicular railway (funicular, cable railway)
- 13 funicular railway car
- 14 haulage cable
- 15-38 cableways (ropeways, cable suspension lines)
- 15-24 single-cable ropeways (single-cable suspension lines), endless ropeways
- 15 drag lift

16-18 chair lift

- 16 lift chair, a single chair
- 17 double lift chair, a two-seater chair
- 18 double chair (two-seater chair) with coupling
- 19 gondola cableway, an endless cableway
- 20 gondola (cabin)
- 21 endless cable, a suspension (supporting) and haulage cable
- 22 U-rail
- 23 single-pylon support
- 24 gantry support
- 25 double-cable ropeway (double-cable suspension line), a suspension line with balancing cabins
- 26 haulage cable
- 27 suspension cable (supporting cable)
- 28 cabin
- 29 intermediate support
- 30 cableway (ropeway, suspension line), a double-cable ropeway (double-cable suspension line)
- 31 pylon
- 32 haulage cable roller
- 33 cable guide rail (suspension cable bearing)
- 34 skip, a tipping bucket (*Am. dumping bucket*)
- 35 stop
- 36 pulley cradle

- 37 haulage cable
- 38 suspension cable (supporting cable)
- 39 valley station (lower station)
- 40 tension weight shaft
- 41 tension weight for the suspension cable (supporting cable)
- 42 tension weight for the haulage cable
- 43 tension cable pulley
- 44 suspension cable (supporting cable)
- 45 haulage cable
- 46 balance cable (lower cable)
- 47 auxiliary cable (emergency cable)
- 48 auxiliary-cable tensioning mechanism (emergency-cable tensioning mechanism)
- 49 haulage cable rollers
- 50 spring buffer (*Am. spring bumper*)
- 51 valley station platform (lower station platform)
- 52 cabin (cableway gondola, ropeway gondola, suspension line gondola), a large-capacity cabin
- 53 pulley cradle
- 54 suspension gear
- 55 stabilizer
- 56 guide rail
- 57 top station (upper station)
- 58 suspension cable guide (supporting cable guide)
- 59 suspension cable anchorage (supporting cable anchorage)
- 60 haulage cable rollers
- 61 haulage cable guide wheel
- 62 haulage cable driving pulley
- 63 main drive
- 64 standby drive
- 65 control room
- 66 cabin pulley cradle
- 67 main pulley cradle
- 68 double cradle
- 69 two-wheel cradle
- 70 running wheels
- 71 suspension cable brake (supporting cable brake), an emergency brake in case of haulage cable failure
- 72 suspension gear bolt
- 73 haulage cable sleeve
- 74 balance cable sleeve (lower cable sleeve)
- 75 derailment guard
- 76 cable supports (ropeway supports, suspension line supports, intermediate supports)
- 77 pylon, a framework support
- 78 tubular steel pylon, a tubular steel support
- 79 suspension cable guide rail (supporting cable guide rail, support guide rail)
- 80 support truss, a frame for work on the cable
- 81 base of the support

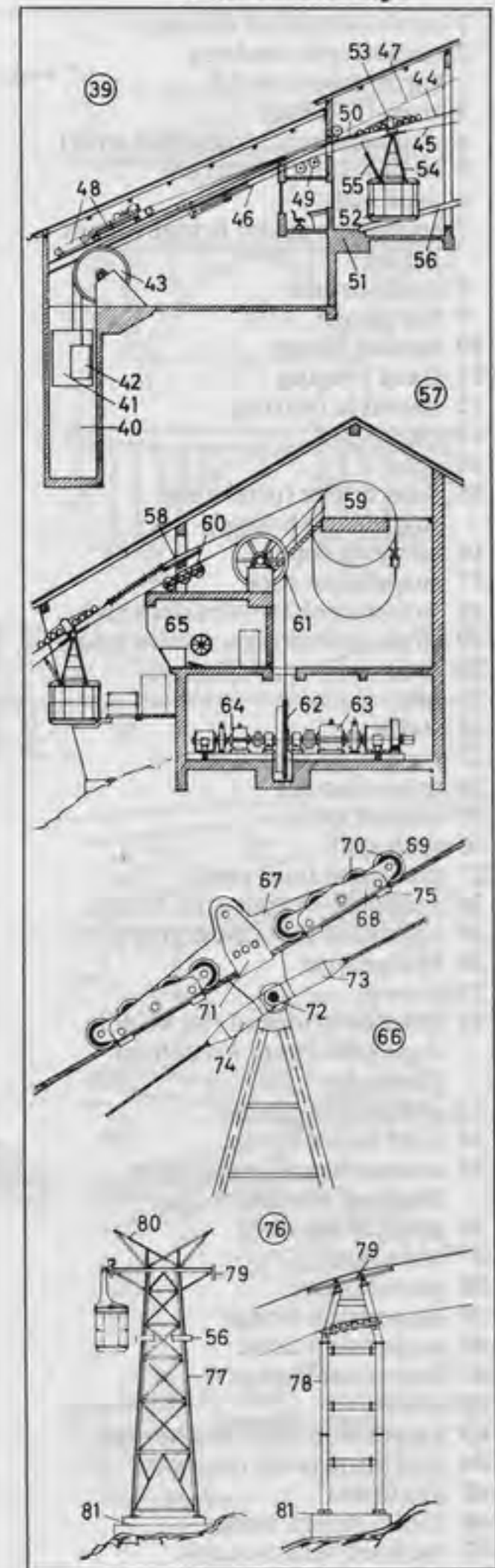



- 1 cross-section of a bridge
- 2 orthotropic roadway (orthotropic deck)
- 3 truss (bracing)
- 4 diagonal brace (diagonal strut)
- 5 hollow tubular section
- 6 deck slab
- 7 solid-web girder bridge (beam bridge)
- 8 road surface
- 9 top flange
- 10 bottom flange
- 11 fixed bearing
- 12 movable bearing
- 13 clear span
- 14 span
- 15 rope bridge (primitive suspension bridge)
- 16 carrying rope
- 17 suspension rope
- 18 woven deck (woven decking)
- 19 stone arch bridge, a solid bridge
- 20 arch
- 21 pier
- 22 statue
- 23 trussed arch bridge
- 24 truss element
- 25 trussed arch
- 26 arch span
- 27 abutment (end pier)
- 28 spandrel-braced arch bridge
- 29 abutment (abutment pier)
- 30 bridge strut
- 31 crown
- 32 covered bridge of the Middle Ages (the *Ponte Vecchio* in Florence)
- 33 goldsmiths' shops
- 34 steel lattice bridge
- 35 counterbrace (crossbrace, diagonal member)
- 36 vertical member
- 37 truss joint
- 38 portal frame
- 39 suspension bridge
- 40 suspension cable
- 41 suspender (hanger)
- 42 tower
- 43 suspension cable anchorage
- 44 tied beam [with roadway]
- 45 abutment
- 46 cable-stayed bridge
- 47 inclined tension cable

- 48 inclined cable anchorage
- 49 reinforced concrete bridge
- 50 reinforced concrete arch
- 51 inclined cable system (multiple cable system)
- 52 flat bridge, a plate girder bridge
- 53 stiffener
- 54 pier
- 55 bridge bearing
- 56 cutwater
- 57 straits bridge, a bridge built of precast elements
- 58 precast construction unit
- 59 viaduct
- 60 valley bottom
- 61 reinforced concrete pier
- 62 scaffolding
- 63 lattice swing bridge
- 64 turntable
- 65 pivot pier
- 66 pivoting half (pivoting section, pivoting span, movable half) of bridge
- 67 flat swing bridge
- 68 middle section
- 69 pivot
- 70 parapet (handrailing)

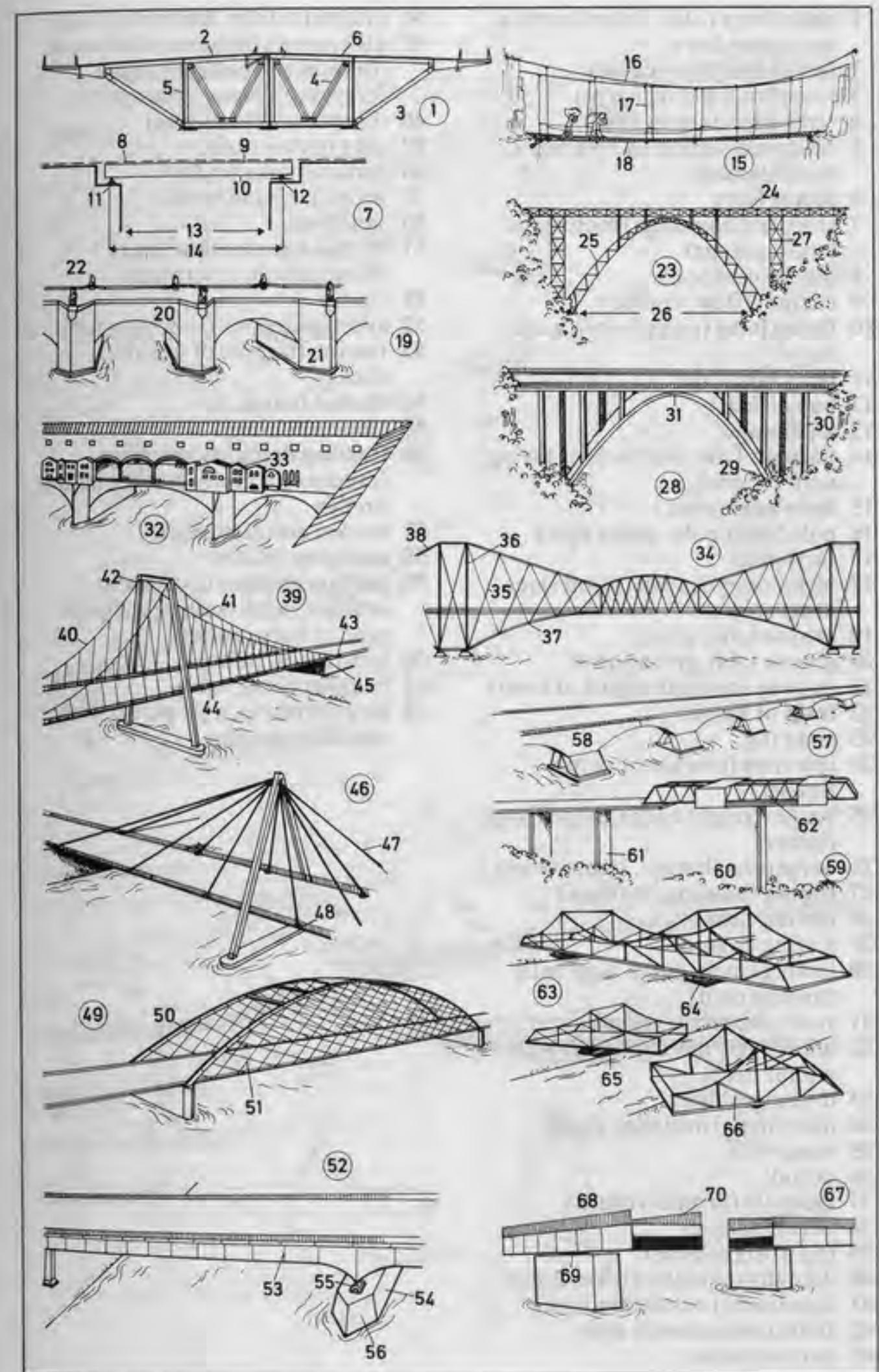



- 1 cable ferry (also: chain ferry), a passenger ferry
- 2 ferry rope (ferry cable)
- 3 river branch (river arm)
- 4 river island (river islet)
- 5 collapsed section of riverbank, flood damage
- 6 motor ferry
- 7 ferry landing stage (motorboat landing stage)
- 8 pile foundations
- 9 current (flow, course)
- 10 flying ferry (river ferry), a car ferry
- 11 ferry boat
- 12 buoy (float)
- 13 anchorage
- 14 harbour (*Am.* harbor) for laying up river craft
- 15 ferry boat (punt)
- 16 pole (punt pole, quant pole)
- 17 ferryman
- 18 blind river branch (blind river arm)
- 19 groyne (*Am.* groin)
- 20 groyne (*Am.* groin) head
- 21 fairway (navigable part of river)
- 22 train of barges
- 23 river tug
- 24 tow rope (tow line, towing hawser)
- 25 barge (freight barge, cargo barge, lighter)
- 26 bargeman (bargee, lighterman)
- 27 towing (hauling, haulage)
- 28 towing mast
- 29 towing engine
- 30 towing track; *form.*: tow path (towing path)
- 31 river after river training
- 32 dike (dyke, main dike, flood wall, winter dike)
- 33 drainage ditch
- 34 dike (dyke) drainage sluice
- 35 wing wall
- 36 outfall
- 37 drain (infiltration drain)
- 38 berm (berme)
- 39 top of dike (dyke)
- 40 dike (dyke) batter (dike slope)
- 41 flood bed (inundation area)
- 42 flood containment area
- 43 current meter
- 44 kilometre (*Am.* kilometer) sign
- 45 dikereeve's (dykereeve's) house (dikereeve's cottage); also: ferryman's house (cottage)
- 46 dikereeve (dykereeve)
- 47 dike (dyke) ramp
- 48 summer dike (dyke)
- 49 levee (embankment)
- 50 sandbags
- 51-55 bank protection (bank stabilization, revetment)
- 51 riprap
- 52 alluvial deposit (sand deposit)
- 53 fascine (bundle of wooden sticks)
- 54 wicker fences
- 55 stone pitching
- 56 floating dredging machine (dredger), a multi-bucket ladder dredge
- 57 bucket elevator chain
- 58 dredging bucket
- 59 suction dredger (hydraulic dredger) with trailing suction pipe or barge sucker
- 60 centrifugal pump
- 61 back scouring valve
- 62 suction pump, a jet pump with scouring nozzles

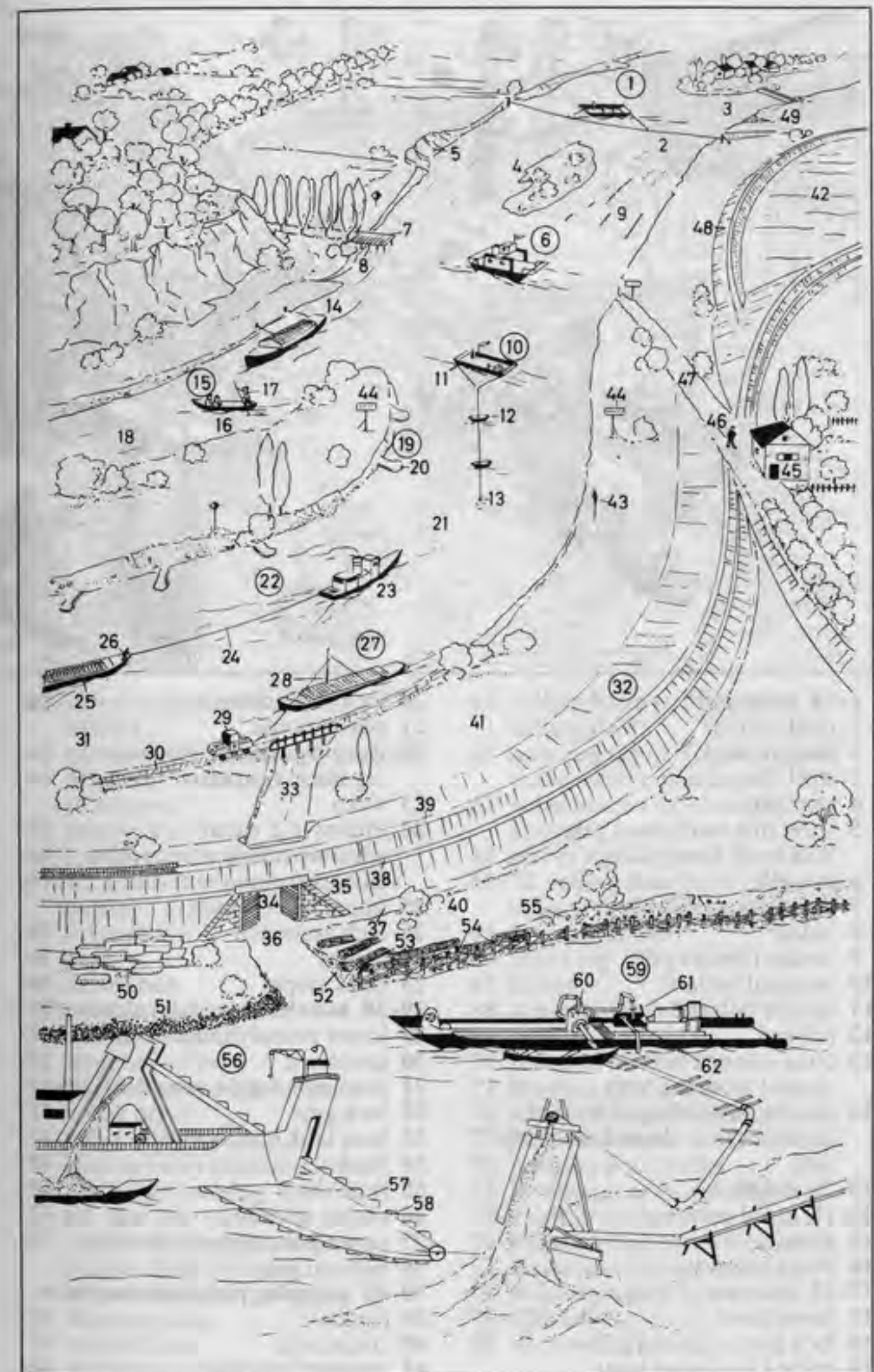

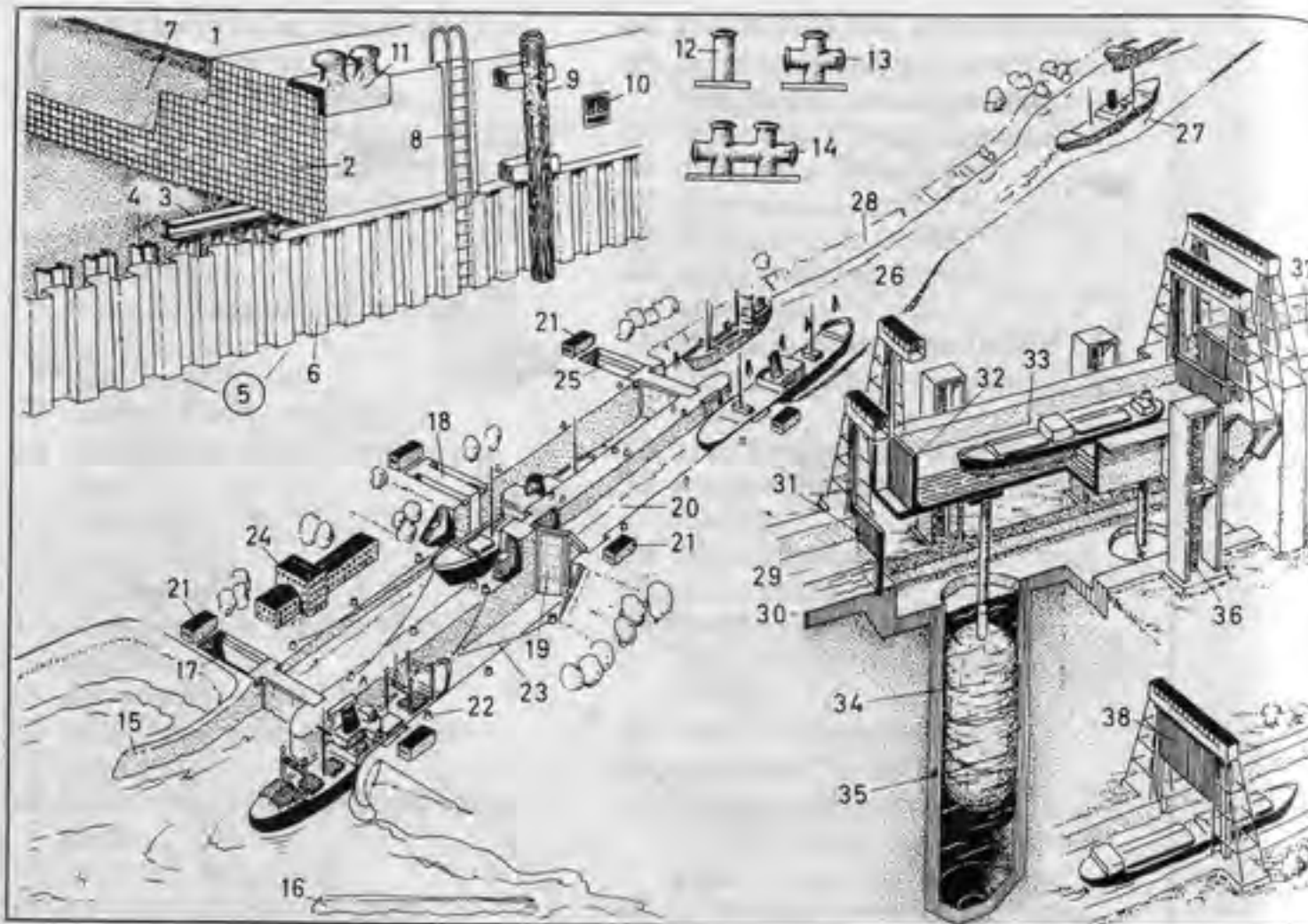

**1-14 quay wall**

- 1 road surface
- 2 body of wall
- 3 steel sleeper
- 4 steel pile
- 5 sheet pile wall (sheet pile bulkhead, sheetpiling)
- 6 box pile
- 7 backfilling (filling)
- 8 ladder
- 9 fender (fender pile)
- 10 recessed bollard
- 11 double bollard
- 12 bollard
- 13 cross-shaped bollard (cross-shaped mooring bitt)
- 14 double cross-shaped bollard (double cross-shaped mooring bitt)
- 15-28 canal**
- 15-16 canal entrance
- 15 mole
- 16 breakwater
- 17-25 staircase of locks
- 17 lower level
- 18 lock gate, a sliding gate
- 19 mitre (*Am.* miter) gate

**20 lock (lock chamber)**

- 21 power house
- 22 warping capstan (hauling capstan), a capstan
- 23 warp
- 24 offices (e.g. canal administration, river police, customs)
- 25 upper level (head)
- 26 lock approach
- 27 lay-by
- 28 bank slope
- 29-38 boat lift (*Am.* boat elevator)**
- 29 lower pound (lower reach)
- 30 canal bed
- 31 pound lock gate, a vertical gate
- 32 lock gate
- 33 boat tank (caisson)
- 34 float
- 35 float shaft
- 36 lifting spindle
- 37 upper pound (upper reach)
- 38 vertical gate
- 39-46 pumping plant and reservoir**
- 39 forebay
- 40 surge tank
- 41 pressure pipeline

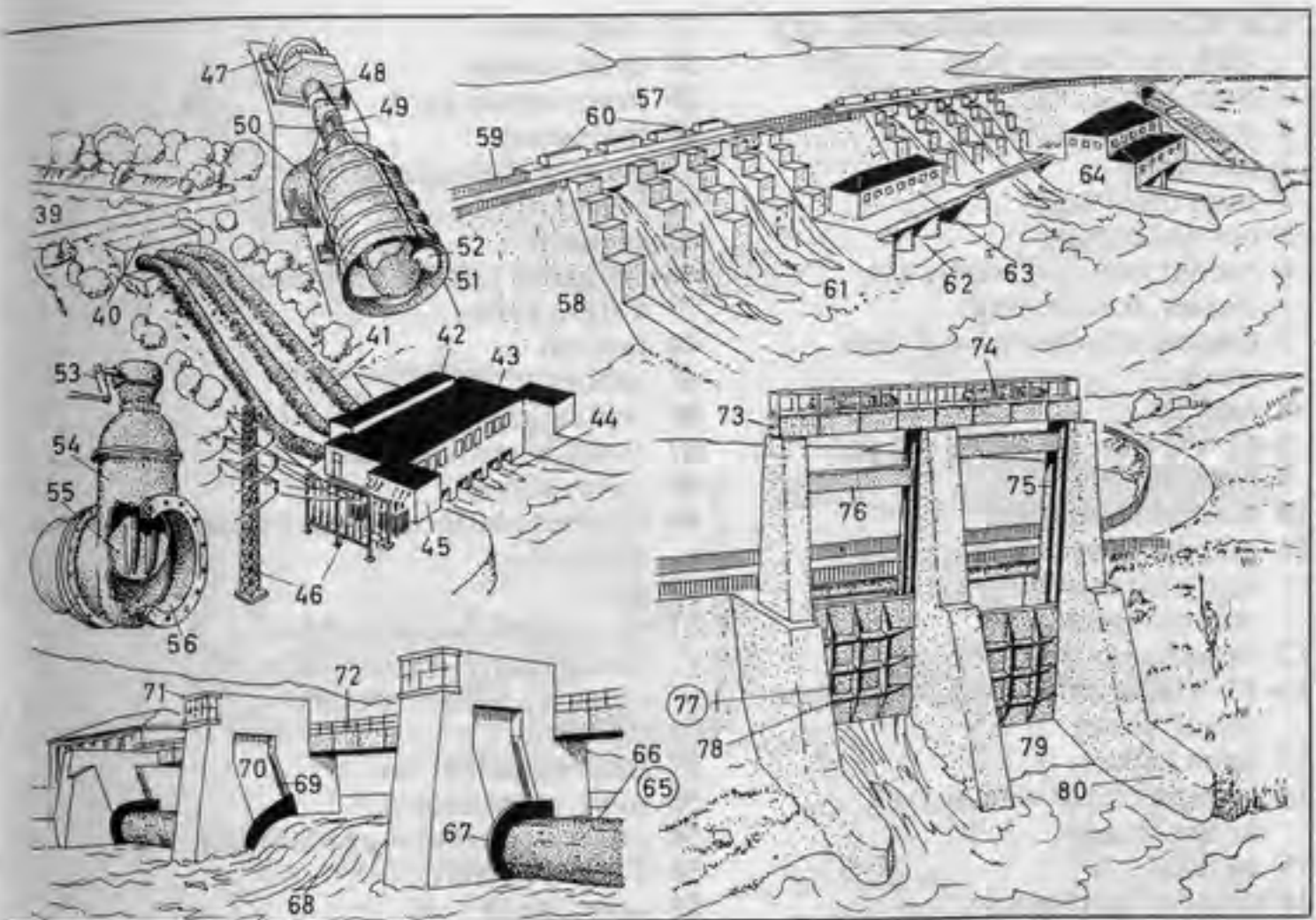

- 42 valve house (valve control house)
- 43 turbine house (pumping station)
- 44 discharge structure (outlet structure)
- 45 control station
- 46 transformer station
- 47-52 axial-flow pump (propeller pump)**
- 47 drive motor
- 48 gear
- 49 drive shaft
- 50 pressure pipe
- 51 suction head
- 52 impeller wheel
- 53-56 sluice valve (sluice gate)**
- 53 crank drive
- 54 valve housing
- 55 sliding valve (sliding gate)
- 56 discharge opening
- 57-64 dam (barrage)**
- 57 reservoir (storage reservoir, impounding reservoir, impounded reservoir)
- 58 masonry dam
- 59 crest of dam
- 60 spillway (overflow spillway)

**61 stilling basin (stilling box, stilling pool)**

- 62 scouring tunnel (outlet tunnel, waste water outlet)
- 63 valve house (valve control house)
- 64 power station
- 65-72 rolling dam (weir), a barrage; other system: shutter weir**
- 65 roller, a barrier
- 66 roller top
- 67 flange
- 68 submersible roller
- 69 rack track
- 70 recess
- 71 hoisting gear cabin
- 72 service bridge (walkway)
- 73-80 sluice dam**
- 73 hoisting gear bridge
- 74 hoisting gear (winding gear)
- 75 guide groove
- 76 counterweight (counterpoise)
- 77 sluice gate (floodgate)
- 78 reinforcing rib
- 79 dam sill (weir sill)
- 80 wing wall



- 1-6 **Germanic rowing boat** [ca. AD 400], the Nydam boat  
 1 stern post  
 2 steersman  
 3 oarsman  
 4 stem post (stem)  
 5 oar, for rowing  
 6 rudder (steering oar), a side rudder, for steering  
 7 **dugout**, a hollowed-out tree trunk  
 8 paddle  
 9-12 **trireme**, a Roman warship  
 9 ram  
 10 forecandle (fo'c'sle)  
 11 grapple (grapnel, grappling iron), for fastening the enemy ship alongside  
 12 three banks (tiers) of oars  
 13-17 **Viking ship** (longship, dragon ship) [Norse]  
 13 helm (tiller)  
 14 awning crutch with carved horses' heads  
 15 awning  
 16 dragon figurehead  
 17 shield  
 18-26 **cog** (Hansa cog, Hansa ship)  
 18 anchor cable (anchor rope, anchor hawser)  
 19 forecandle (fo'c'sle)  
 20 bowsprit  
 21 furled (brailed-up) square sail  
 22 town banner (city banner)  
 23 aftercastle (sterncastle)  
 24 rudder, a stem rudder  
 25 elliptical stern (round stern)  
 26 wooden fender  
 27-43 **caravel** (carvel) ['Santa Maria' 1492]  
 27 admiral's cabin  
 28 spanker boom  
 29 mizzen (mizen, mutton spanker, lateen spanker), a lateen sail  
 30 lateen yard  
 31 mizzen (mizen) mast  
 32 lashing  
 33 mainsail (main course), a square sail  
 34 bonnet, a removable strip of canvas  
 35 bowline  
 36 bunt line (martinet)

- 37 main yard  
 38 main topsail  
 39 main topsail yard  
 40 mainmast  
 41 foresail (fore course)  
 42 foremast  
 43 spritsail  
 44-50 **galley** [15th to 18th century], a slave galley  
 44 lantern  
 45 cabin  
 46 central gangway  
 47 slave driver with whip  
 48 galley slaves  
 49 covered platform in the forepart of the ship  
 50 gun  
 51-60 **ship of the line** (line-of-battle ship) [18th to 19th century], a three-decker  
 51 jib boom  
 52 fore topgallant sail  
 53 main topgallant sail  
 54 mizzen (mizen) topgallant sail  
 55-57 gilded stern  
 55 upper stern  
 56 stern gallery  
 57 quarter gallery, a projecting balcony with ornamental portholes  
 58 lower stern  
 59 gunports for broadside fire  
 60 gunport shutter

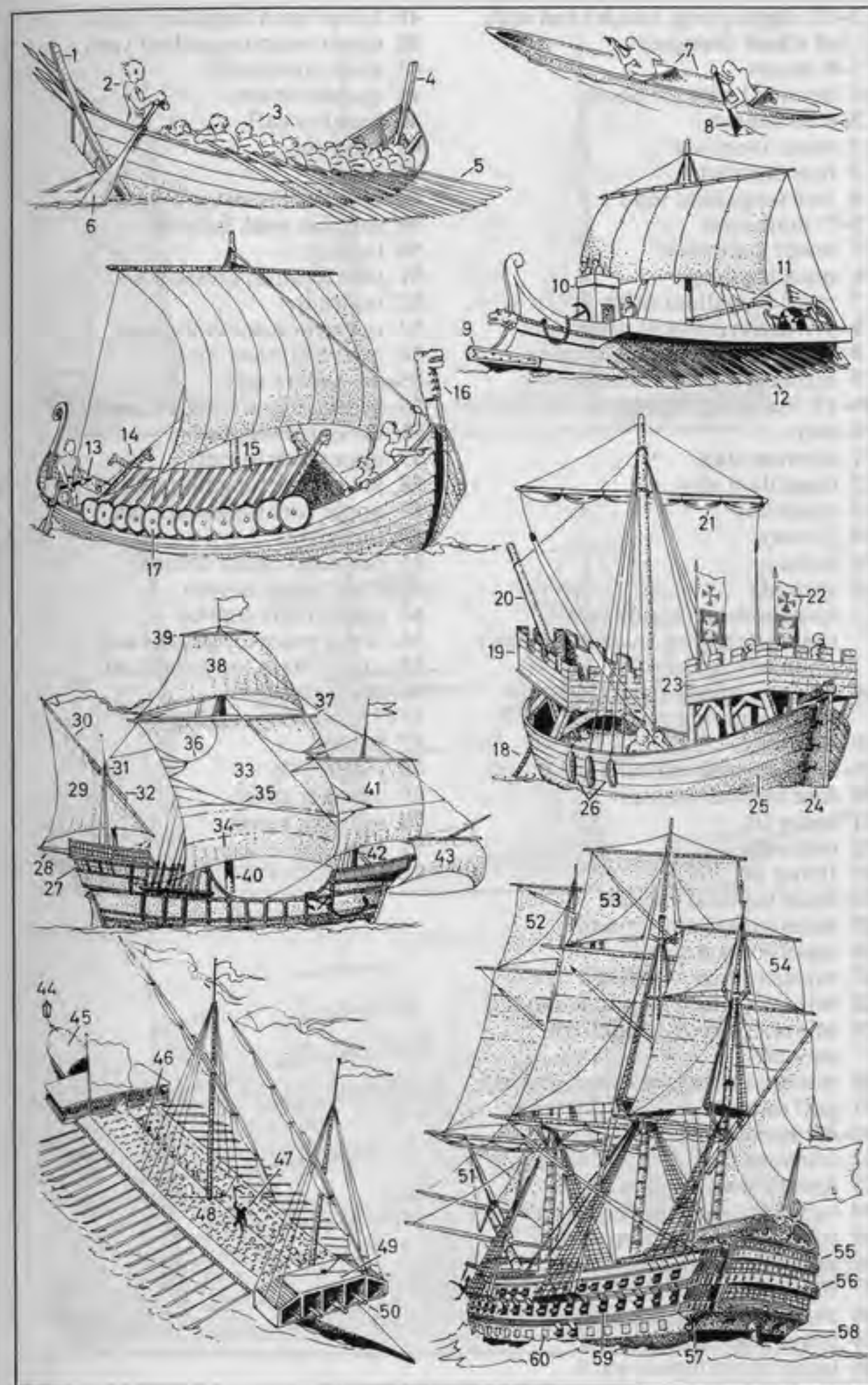



- 1-72 rigging (rig, tackle) and sails of a bark (barque)**
- 1-9 masts**
- 1 bowsprit with jib boom  
2-4 foremast  
2 lower foremast  
3 fore topmast  
4 fore topgallant mast  
5-7 mainmast  
5 lower mainmast  
6 main topmast  
7 main topgallant mast  
8-9 mizzen (mizen) mast  
8 lower mizzen (lower mizen)  
9 mizzen (mizen) topmast
- 10-19 standing rigging**
- 10 stay  
11 topmast stay  
12 topgallant stay  
13 royal stay  
14 jib stay  
15 bobstay  
16 shrouds  
17 fore topmast rigging (main topmast rigging, mizzen (mizen) topmast rigging)  
18 fore topgallant rigging (main topgallant rigging)  
19 backstays
- 20-31 fore-and-aft sails**
- 20 fore topmast staysail  
21 inner jib  
22 outer jib  
23 flying jib  
24 main topmast staysail  
25 main topgallant staysail  
26 main royal staysail  
27 mizzen (mizen) staysail  
28 mizzen (mizen) topmast staysail  
29 mizzen (mizen) topgallant staysail  
30 mizzen (mizen, spanker, driver)  
31 gaff topsail
- 32-45 spars**
- 32 foreyard  
33 lower fore topsail yard  
34 upper fore topsail yard  
35 lower fore topgallant yard  
36 upper fore topgallant yard  
37 fore royal yard  
38 main yard  
39 lower main topsail yard  
40 upper main topsail yard  
41 lower main topgallant yard  
42 upper main topgallant yard  
43 main royal yard  
44 spanker boom  
45 spanker gaff
- 46-54**
- 46 footrope  
47 lifts  
48 spanker boom topping lift  
49 spanker peak halyard  
50 foretop  
51 fore topmast crosstrees  
52 maintop  
53 main topmast crosstrees  
54 mizzen (mizen) top
- 55-66 square sails**
- 55 foresail (fore course)  
56 lower fore topsail  
57 upper fore topsail  
58 lower fore topgallant sail  
59 upper fore topgallant sail  
60 fore royal  
61 mainsail (main course)  
62 lower main topsail  
63 upper main topsail  
64 lower main topgallant sail  
65 upper main topgallant sail  
66 main royal sail
- 67-71 running rigging**
- 67 braces  
68 sheets  
69 spanker sheet  
70 spanker vang  
71 bunt line  
72 reef

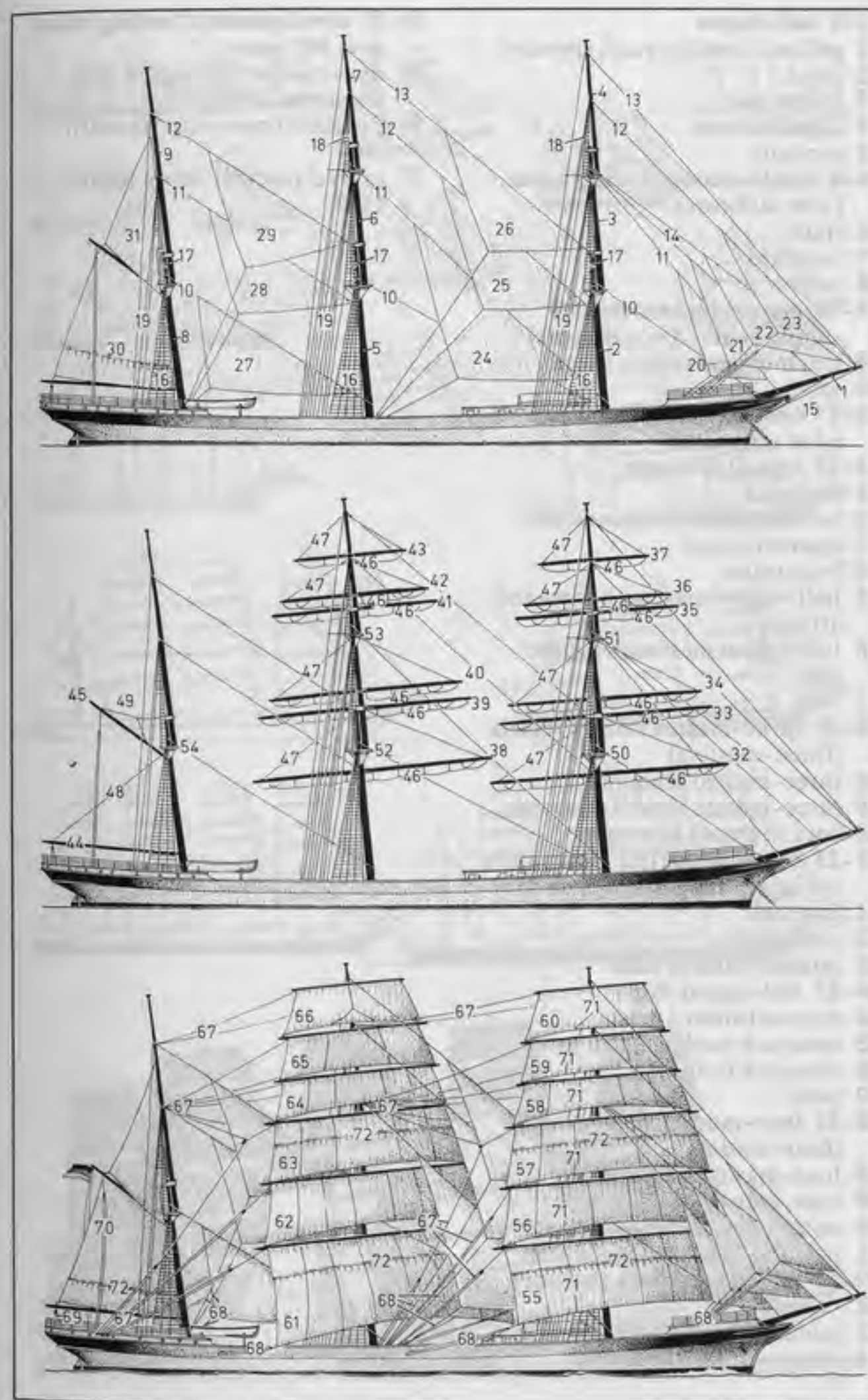



- 1-5 sail shapes  
 1 gaffsail (*small*: trysail, spencer)  
 2 jib  
 3 lateen sail  
 4 lugsail  
 5 spritsail  
 6-8 single-masted sailing boats  
 (*Am. sailboats*)  
 6 tjalk  
 7 leeboard  
 8 cutter  
 9-10 mizzen (mizen) masted sailing boats (*Am. sailboats*)  
 9 ketch-rigged sailing barge  
 10 yawl  
 11-17 two-masted sailing boats  
 (*Am. sailboats*)  
 11 topsail schooner  
 11 mainsail  
 12 boom foresail  
 13 square foresail  
 14 brigantine  
 15 half-rigged mast with fore-and-aft sails  
 16 full-rigged mast with square sails  
 17 brig  
 18-27 three-masted sailing vessels  
 (three-masters)  
 18 three-masted schooner  
 19 three-masted topsail schooner  
 20 bark (barque) schooner  
 21-23 bark (barque) [cf. illustration of rigging and sails in plate 219]  
 21 foremast  
 22 mainmast  
 23 mizzen (mizen) mast  
 24-27 full-rigged ship  
 24 mizzen (mizen) mast  
 25 crossjack yard (crojack yard)  
 26 crossjack (crojack)  
 27 ports  
 28-31 four-masted sailing ships  
 (four-masters)  
 28 four-masted schooner  
 29 four-masted bark (barque)  
 30 mizzen (mizen) mast  
 31 four-masted full-rigged ship  
 32-34 five-masted bark (barque)  
 32 skysail  
 33 middle mast  
 34 mizzen (mizen) mast

- 35-37 development of sailing ships  
 over 400 years  
 35 five-masted full-rigged ship  
 'Preussen' 1902-10  
 36 English clipper ship 'Spindrift'  
 1867  
 37 caravel (carvel) 'Santa Maria'  
 1492

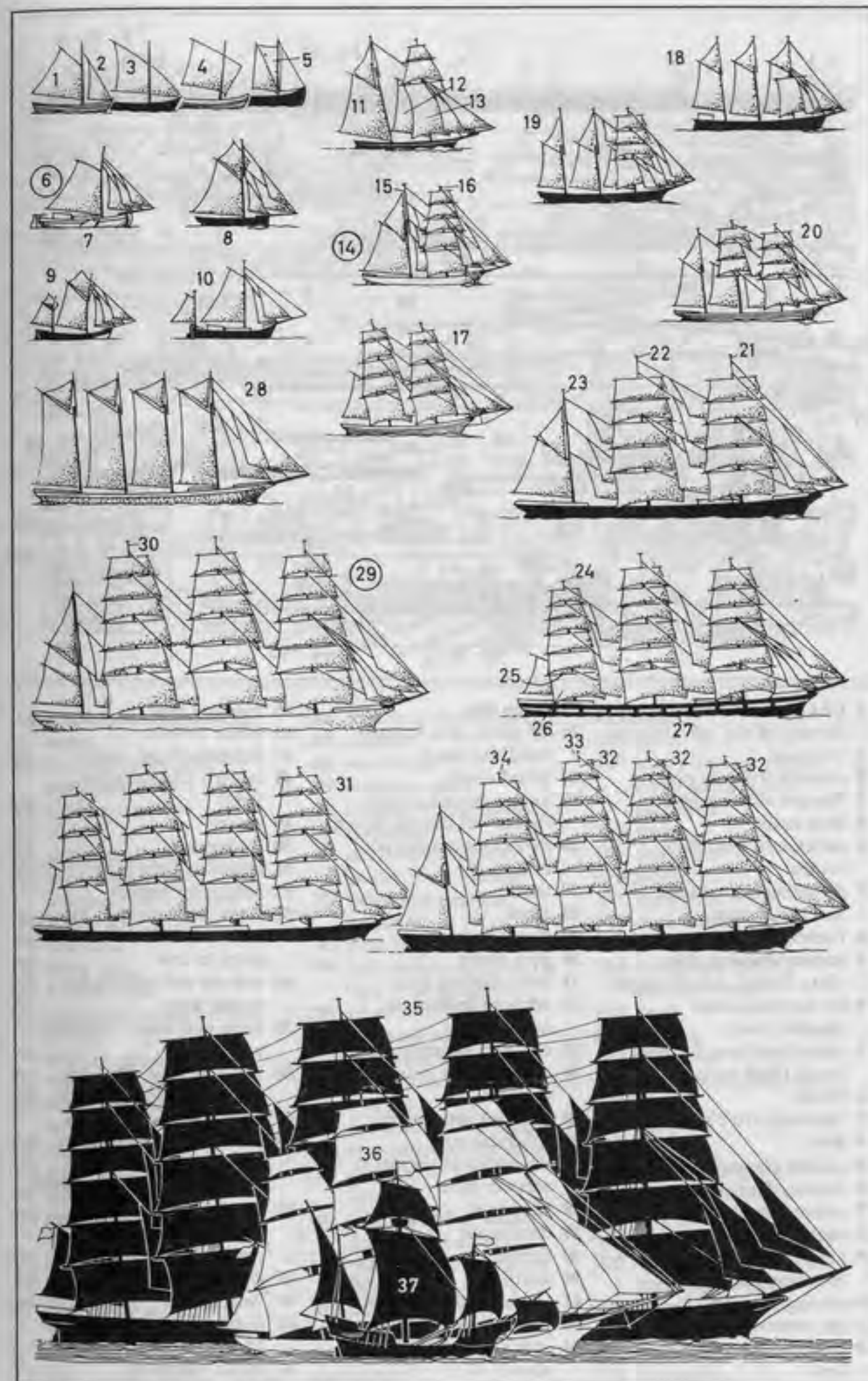



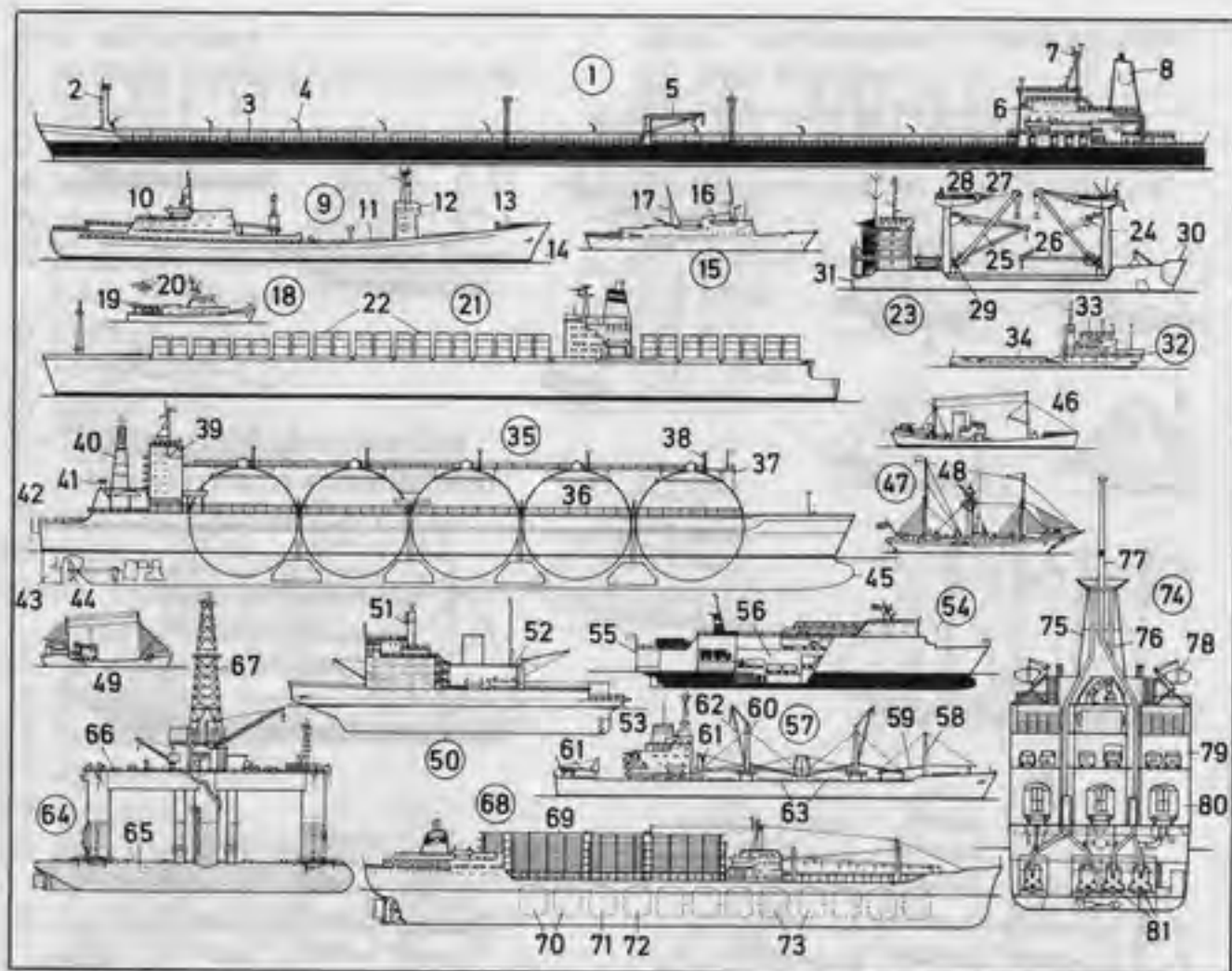

- |  |   |  |
|--|---|--|
| 1 ULCC (ultra large crude carrier) of the 'all-aft' type | 23 cargo ship                                   | 45 bulbous bow   |
| 2 foremast   | 24-29 cargo gear (cargo handling gear)          | 46 steam trawler   |
| 3 catwalk with the pipes                                 | 24 bipod mast                                   | 47 lightship (light vessel)  |
| 4 fire gun (fire nozzle)                                 | 25 jumbo derrick boom (heavy-lift derrick boom) | 48 lantern (characteristic light)                                    |
| 5 deck crane   | 26 derrick boom (cargo boom)                    | 49 smack   |
| 6 deckhouse with the bridge                              | 27 tackle                                       | 50 ice breaker   |
| 7 aft signal (signalling) and radar mast                 | 28 block  | 51 steaming light mast   |
| 8 funnel   | 29 thrust bearing                               | 52 helicopter hangar   |
| 9 nuclear research ship 'Otto Hahn', a bulk carrier      | 30 bow doors                                    | 53 stern towing point, for gripping the bow of ships in tow          |
| 10 aft superstructure (engine room)                      | 31 stern loading door                           | 54 roll-on-roll-off (ro-ro) trailer ferry                            |
| 11 cargo hatchway for bulk goods (bulk cargoes)          | 32 offshore drilling rig supply vessel          | 55 stern port (stern opening) with ramp                              |
| 12 bridge  | 33 compact superstructure                       | 56 heavy vehicle lifts (Am. heavy vehicle elevators)                 |
| 13 forecastle (fo'c'sle)                                 | 34 loading deck (working deck)                  | 57 multi-purpose freighter   |
| 14 stem  | 35 liquefied-gas tanker                         | 58 ventilator-type samson (sampsun) post (ventilator-type king post) |
| 15 seaside pleasure boat                                 | 36 spherical tank                               | 59 derrick boom (cargo boom, cargo gear, cargo-handling gear)        |
| 16 dummy funnel  | 37 navigational television receiver mast        | 60 derrick mast  |
| 17 exhaust mast  | 38 vent mast                                    | 61 deck crane  |
| 18 rescue cruiser  | 39 deckhouse                                    | 62 jumbo derrick boom (heavy-lift derrick boom)                      |
| 19 helicopter platform (working deck)                    | 40 funnel                                       | 63 cargo hatchway  |
| 20 rescue helicopter                                     | 41 ventilator                                   |  |
| 21 all-container ship                                    | 42 transom stern (transom)                      |  |
| 22 containers stowed on deck                             | 43 rudder blade (rudder)                        |  |
|  | 44 ship's propeller (ship's screw)              |  |

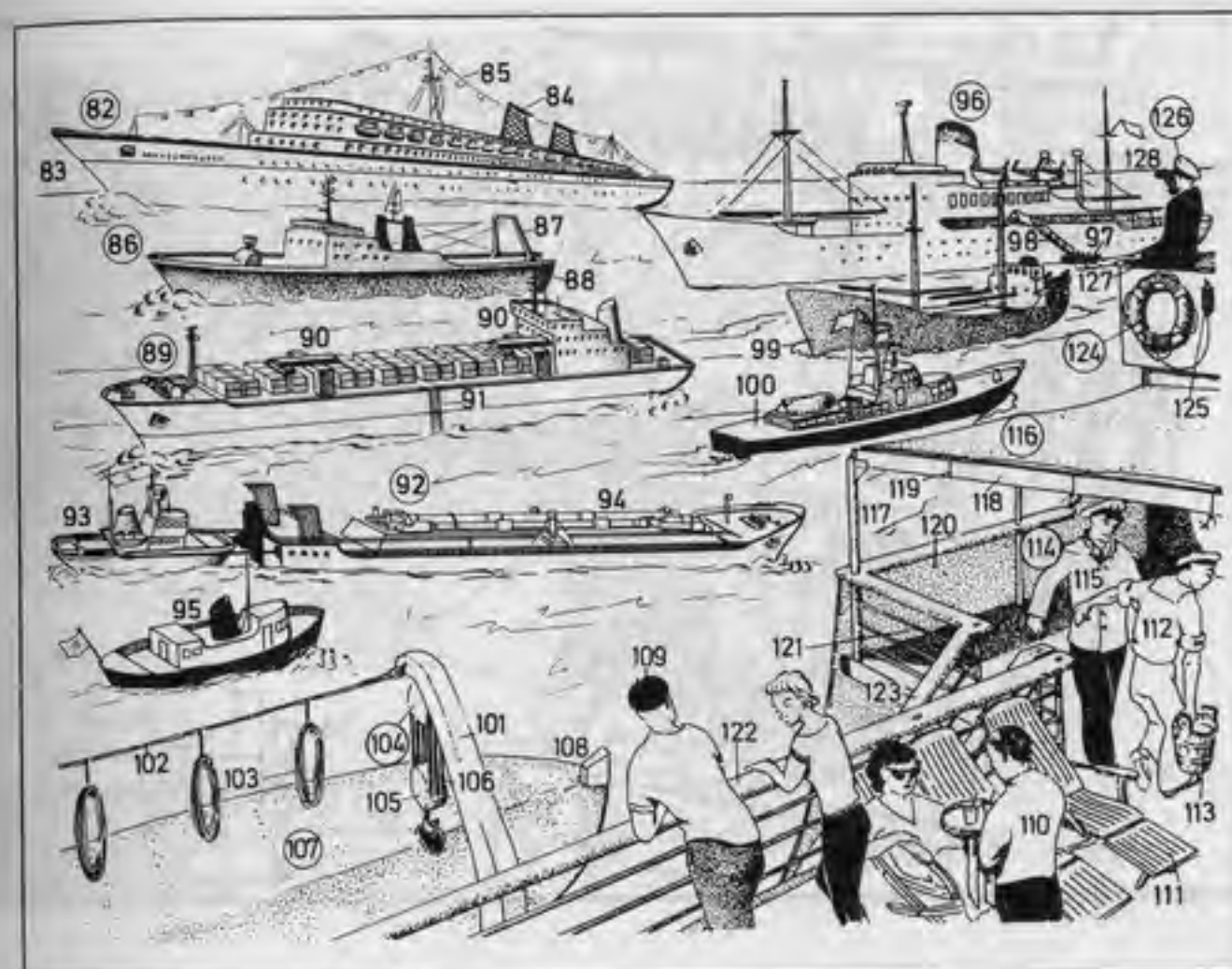

- |   |   |  |
|---|---|--|
| 64 semisubmersible drilling vessel  | 86 trawler, a factory ship                    | 105 block  |
| 65 floating vessel with machinery   | 87 gallows                                    | 106 fall   |
| 66 drilling platform  | 88 stern ramp                                 | 107 ship's lifeboat (ship's boat) covered with tarpaulin |
| 67 derrick  | 89 container ship                             | 108 stem   |
| 68 cattleship (cattle vessel)   | 90 loading bridge (loading platform)          | 109 passenger  |
| 69 superstructure for transporting livestock  | 91 sea ladder (Jacob's ladder, rope ladder)   | 110 steward  |
| 70 fresh water tanks  | 92 barge and push tug assembly                | 111 deck-chair   |
| 71 fuel tank  | 93 push tug                                   | 112 deck hand  |
| 72 dung tank  | 94 tug-pushed dumb barge (tug-pushed lighter) | 113 deck bucket  |
| 73 fodder tanks   | 95 pilot boat                                 | 114 boatswain (bo's'n, bo'sun, bosun)                    |
| 74 train ferry [cross section]  | 96 combined cargo and passenger liner         | 115 tunic  |
| 75 funnel   | 97 passengers disembarking by boat            | 116 awning   |
| 76 exhaust pipes  | 98 accommodation ladder                       | 117 stanchion  |
| 77 mast   | 99 coaster (coasting vessel)                  | 118 ridge rope (jackstay)                                |
| 78 ship's lifeboat hanging at the davit   | 100 customs or police launch                  | 119 lashing  |
| 79 car deck   | 101-128 excursion steamer (pleasure steamer)  | 120 bulwark  |
| 80 main deck (train deck)   | 101 davit                                     | 121 guard rail   |
| 81 main engines   | 102 wire rope span                            | 122 handrail (top rail)                                  |
| 82 passenger liner (liner, ocean liner)   | 103 lifeline                                  | 123 companion ladder (companionway)                      |
| 83 stem   | 104 tackle                                    | 124 lifebelt (lifebuoy)                                  |
| 84 funnel with lattice casing   |   | 125 lifebuoy light (lifebelt light, signal light)        |
| 85 flag dressing (rainbow dressing, string of flags extending over mastheads, e.g., on the maiden voyage) |   | 126 officer of the watch (watchkeeper)                   |
|   |   | 127 reefer (Am. pea jacket)                              |
|   |   | 128 binoculars   |



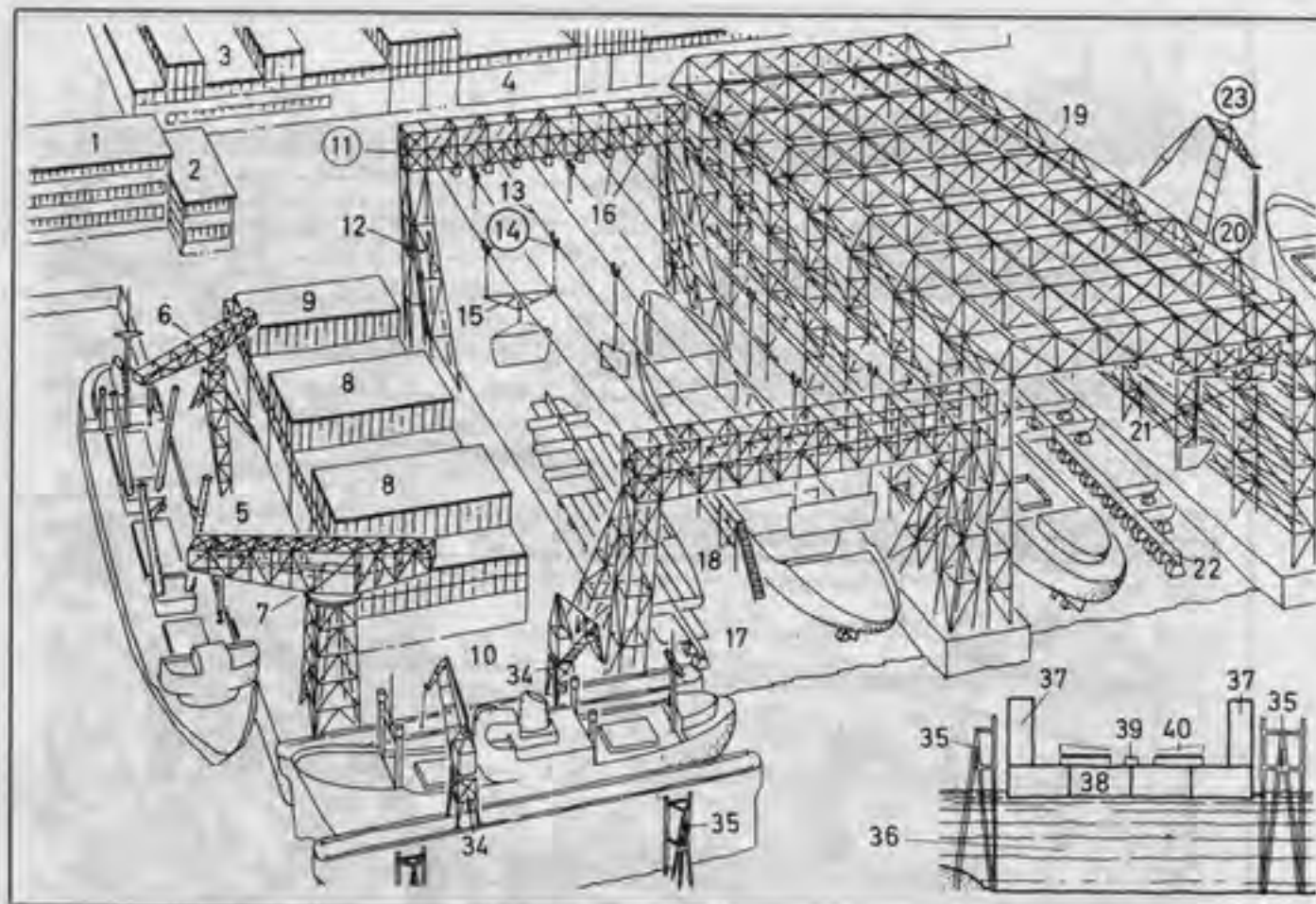

1-43 shipyard (shipbuilding yard, dockyard, *Am.* navy yard)

- 1 administrative offices
- 2 ship-drawing office
- 3-4 shipbuilding sheds
- 3 mould (*Am.* mold) loft
- 4 erection shop
- 5-9 fitting-out quay
- 5 quay
- 6 tripod crane
- 7 hammer-headed crane
- 8 engineering workshop
- 9 boiler shop
- 10 repair quay
- 11-26 slipways (slips, building berths, building slips, stocks)
- 11-18 cable crane berth, a slipway (building berth)
- 11 slipway portal
- 12 bridge support
- 13 crane cable
- 14 crab (jenny)
- 15 cross piece
- 16 crane driver's cabin (crane driver's cage)
- 17 slipway floor
- 18 staging, a scaffold

- 19-21 frame slipway
- 19 slipway frame
- 20 overhead travelling (*Am.* traveling) crane (gantry crane)
- 21 slewing crab
- 22 keel in position
- 23 luffing jib crane, a slipway crane
- 24 crane rails (crane track)
- 25 gantry crane
- 26 gantry (bridge)
- 27 trestles (supports)
- 28 crab (jenny)
- 29 hull frames in position
- 30 ship under construction
- 31-33 dry dock
- 31 dock floor (dock bottom)
- 32 dock gates (caisson)
- 33 pumping station (power house)
- 34-43 floating dock (pontoon dock)
- 34 dock crane (dockside crane), a jib crane
- 35 fender pile
- 36-43 working of docks
- 36 dock basin
- 37-38 dock structure
- 37 side tank (side wall)
- 38 bottom tank (bottom pontoon)
- 39 keel block

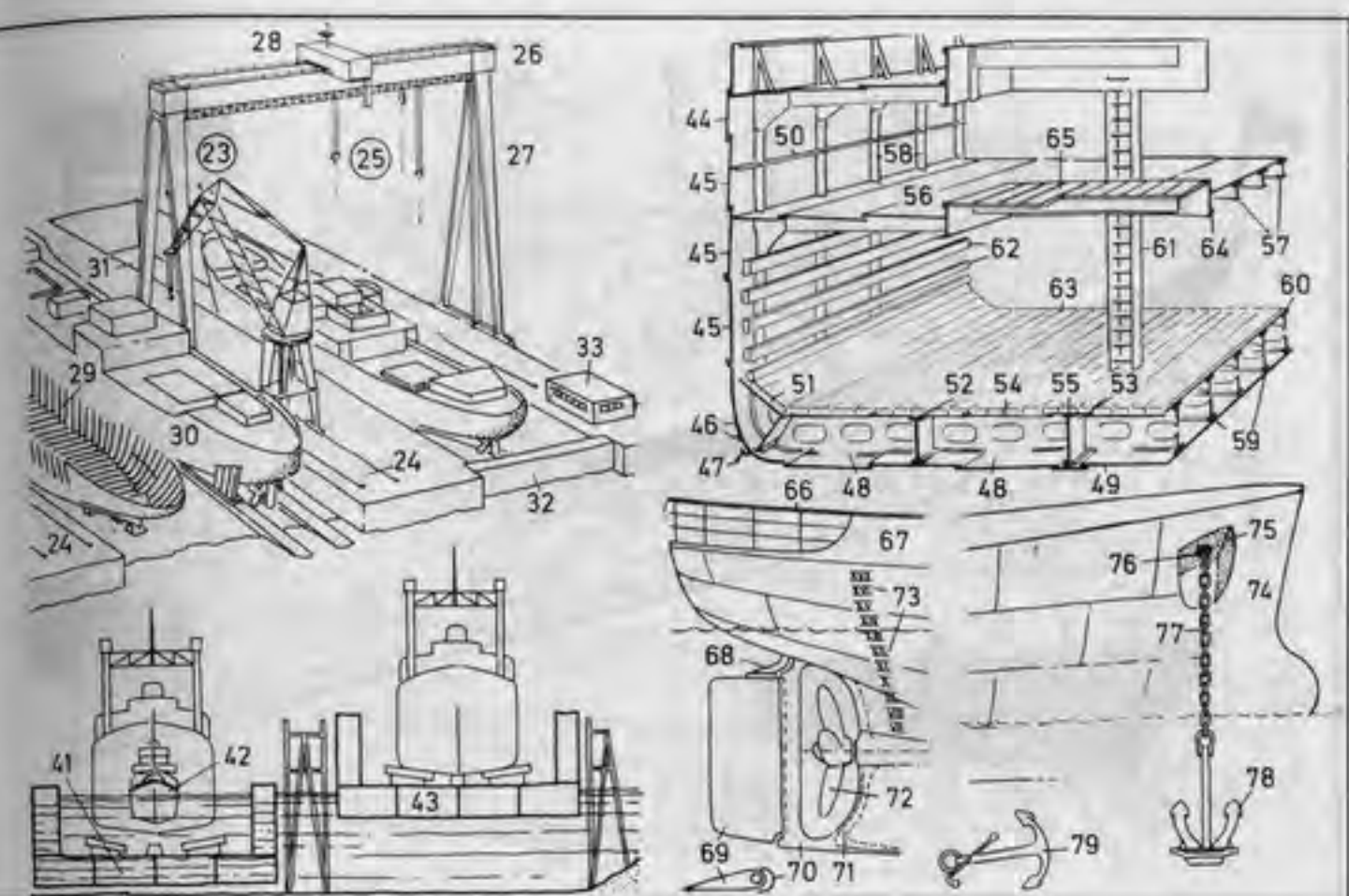

- 40 bilge block (bilge shore, side support)
- 41-43 docking a ship
- 41 flooded floating dock
- 42 tug towing the ship
- 43 emptied (pumped-out) dock
- 44-61 structural parts of the ship
- 44-56 longitudinal structure
- 44-49 shell (shell plating, skin)
- 44 sheer strake
- 45 side strake
- 46 bilge strake
- 47 bilge keel
- 48 bottom plating
- 49 flat plate keel (keel plate)
- 50 stringer (side stringer)
- 51 tank margin plate
- 52 longitudinal side girder
- 53 centre (*Am.* center) plate girder (centre girder, keelson, vertical keel)
- 54 tank top plating (tank top, inner bottom plating)
- 55 centre (*Am.* center) strake
- 56 deck plating
- 57 deck beam
- 58 frame (rib)
- 59 floor plate

- 60 cellular double bottom
- 61 hold pillar (pillar)
- 61, 63 dunnage
- 62 side battens (side ceiling, spar ceiling)
- 63 ceiling (floor ceiling)
- 64-65 hatchway
- 64 hatch coaming
- 65 hatch cover (hatchboard)
- 66-72 stern
- 66 guard rail
- 67 bulwark
- 68 rudder stock
- 69-70 Oertz rudder
- 69 rudder blade (rudder)
- 70-71 stern frame
- 70 rudder post
- 71 propeller post (screw post)
- 72 ship's propeller (ship's screw)
- 73 draught (draft) marks
- 74-79 bow
- 74 stem, a bulbous stem (bulbous bow)
- 75 hawse
- 76 hawse pipe
- 77 anchor cable (chain cable)
- 78 stockless anchor (patent anchor)
- 79 stocked anchor



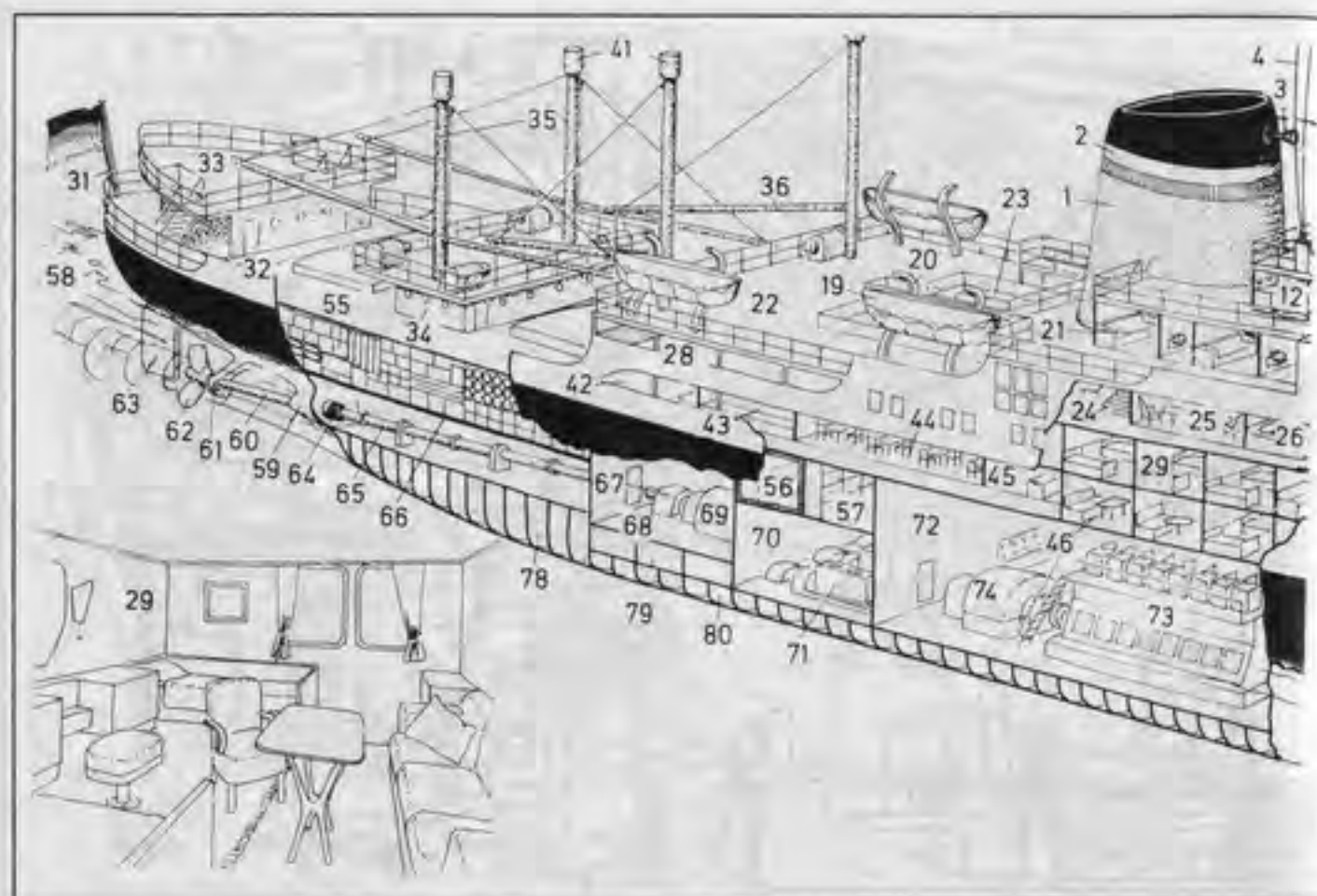

**1-71 combined cargo and passenger ship [of the older type]**

- 1 funnel
- 2 funnel marking
- 3 siren (fog horn)
- 4-11 compass platform** (compass bridge, compass flat, monkey bridge)
- 4 antenna lead-in (antenna down-lead)
- 5 radio direction finder (RDF) antenna (direction finder antenna, rotatable loop antenna, aural null loop antenna)
- 6 magnetic compass (mariner's compass)
- 7 morse lamp (signalling, *Am.* signaling, lamp)
- 8 radar antenna (radar scanner)
- 9 code flag signal
- 10 code flag halyards
- 11 triatic stay (signal stay)
- 12-18 bridge deck** (bridge)
- 12 radio room
- 13 captain's cabin
- 14 navigating bridge
- 15 starboard sidelight [green; port sidelight red]
- 16 wing of bridge**
- 17 shelter (weather cloth, dodger)
- 18 wheelhouse
- 19-21 boat deck**
- 19 ship's lifeboat
- 20 davit
- 21 officer's cabin
- 22-27 promenade deck**
- 22 sun deck (lido deck)
- 23 swimming pool
- 24 companion ladder (companionway)
- 25 library (ship's library)
- 26 lounge
- 27 promenade
- 28-30 A-deck**
- 28 semi-enclosed deck space
- 29 double-berth cabin, a cabin
- 30 de luxe cabin
- 31 ensign staff
- 32-42 B-deck** (main deck)
- 32 after deck
- 33 poop
- 34 deckhouse
- 35 samson (sampson) post (king post)
- 36 derrick boom (cargo boom)

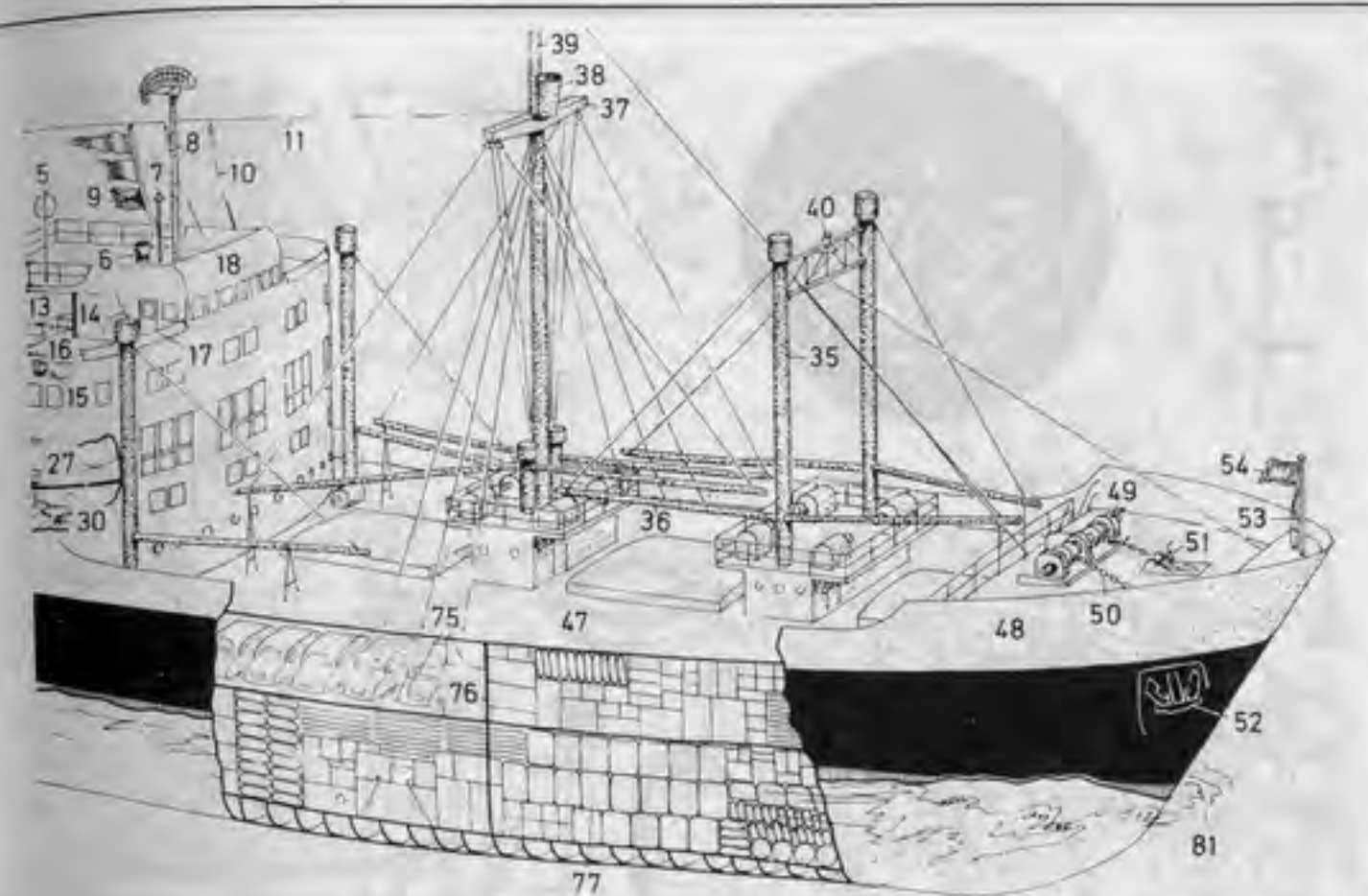

- 37 crosstrees (spreader)
- 38 crow's nest
- 39 topmast
- 40 forward steaming light
- 41 ventilator lead
- 42 galley (caboose, cookroom, ship's kitchen)
- 43 ship's pantry
- 44 dining room
- 45 purser's office
- 46 single-berth cabin
- 47 foredeck
- 48 forecastle (fo'c'sle)
- 49-51 ground tackle**
- 49 windlass
- 50 anchor cable (chain cable)
- 51 compressor (chain compressor)
- 52 anchor
- 53 jackstaff
- 54 jack
- 55 after holds
- 56 cold storage room (insulated hold)
- 57 store room
- 58 wake
- 59 shell bossing (shaft bossing)
- 60 tail shaft (tail end shaft)
- 61 shaft strut (strut, spectacle frame, propeller strut, propeller bracket)
- 62 three-blade ship's propeller (ship's screw)
- 63 rudder blade (rudder)
- 64 stuffing box
- 65 propeller shaft
- 66 shaft alley (shaft tunnel)
- 67 thrust block
- 68-74 diesel-electric drive**
- 68 electric engine room
- 69 electric motor
- 70 auxiliary engine room
- 71 auxiliary engines
- 72 main engine room
- 73 main engine, a diesel engine
- 74 generator
- 75 forward holds
- 76 tween deck
- 77 cargo
- 78 ballast tank (deep tank) for water ballast
- 79 fresh water tank
- 80 fuel tank
- 81 bow wave



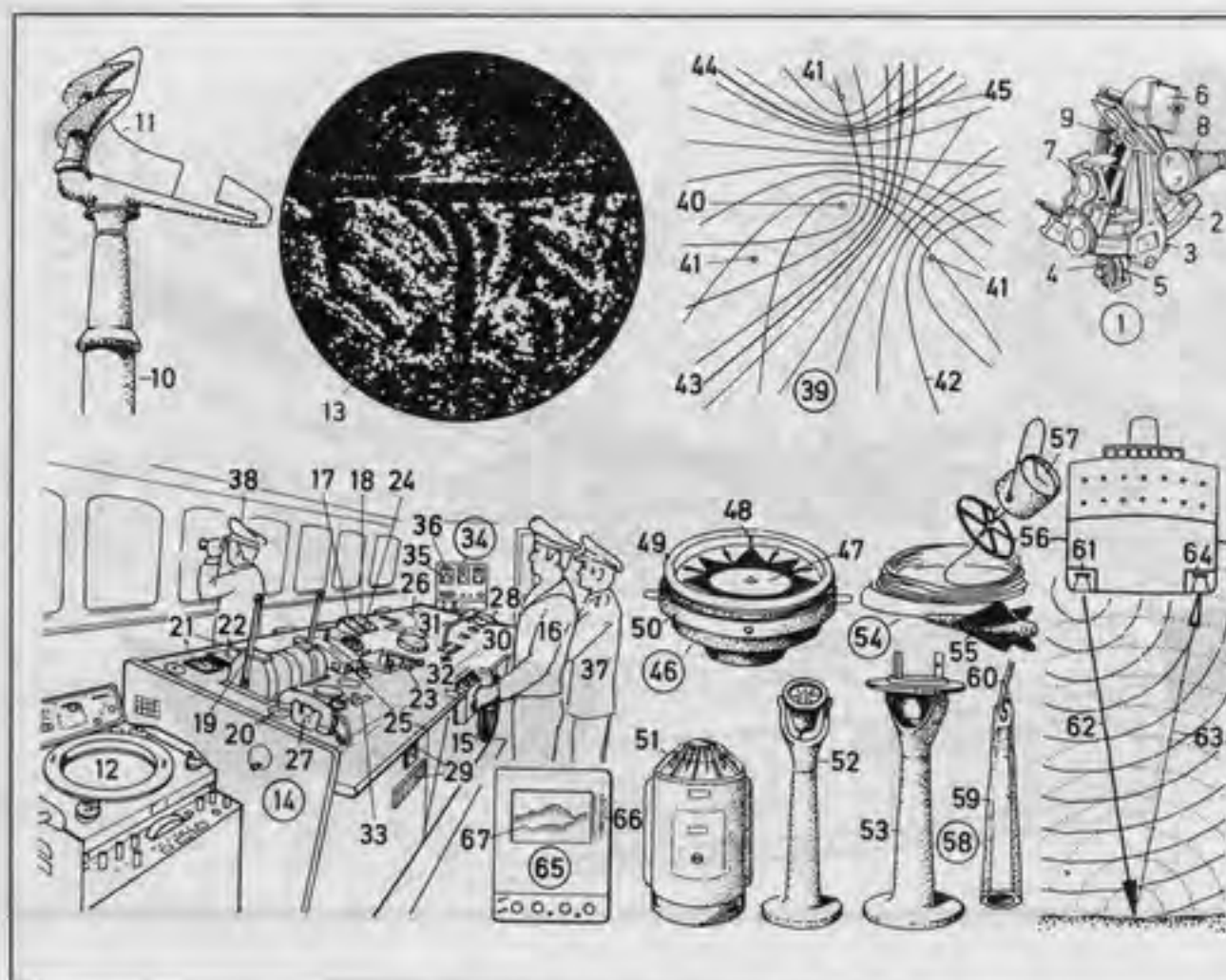

- |  |   |  |
|--|---|--|
| 1 sextant  | 20 propeller pitch indicator  | 35 rough focusing indicator  |
| 2 graduated arc  | 21 main engine revolution indicator   | 36 fine focusing indicator   |
| 3 index bar (index arm)  | 22 ship's speedometer (log)   | 37 navigating officer  |
| 4 decimal micrometer   | 23 control switch for bow thruster (bow maneuvering, <i>Am.</i> maneuvering, propeller) | 38 captain   |
| 5 vernier  | 24 echo recorder (depth recorder, echograph)  | 39 Decca navigation system   |
| 6 index mirror   | 25 engine telegraph (engine order telegraph)  | 40 master station  |
| 7 horizon glass (horizon mirror)   | 26 controls for the anti-rolling system (for the stabilizers)                           | 41 slave station   |
| 8 telescope  | 27 local battery telephone  | 42 null hyperbola  |
| 9 grip (handgrip)  | 28 shipping traffic radio telephone   | 43 hyperbolic position line 1  |
| 10-13 radar equipment (radar apparatus)  | 29 navigation light indicator panel (running light indicator panel)                     | 44 hyperbolic position line 2  |
| 10 radar pedestal  | 30 microphone for ship's address system   | 45 position (fix, ship fix)  |
| 11 revolving radar reflector   | 31 gyro compass (gyroscopic compass), a compass repeater                                | 46-53 compasses  |
| 12 radar display unit (radar screen)   | 32 control button for the ship's siren (ship's fog horn)                                | 46 liquid compass (fluid compass, spirit compass, wet compass), a magnetic compass |
| 13 radar image (radar picture)   | 33 main engine overload indicator   | 47 compass card  |
| 14-38 wheelhouse   | 34 detector indicator unit for fixing the ship's position                               | 48 lubber's line (lubber's mark, lubber's point)                                   |
| 14 steering and control position   |   | 49 compass bowl  |
| 15 ship's wheel for controlling the rudder mechanism   |   | 50 gimbal ring   |
| 16 helmsman ( <i>Am.</i> wheelsman)  |   | 51-53 gyro compass (gyroscopic compass, gyro compass unit)                         |
| 17 rudder angle indicator  |   | 51 master compass (master gyro compass)  |
| 18 automatic pilot (autopilot)   |   | 52 compass repeater (gyro repeater)  |
| 19 control lever for the variable-pitch propeller (reversible propeller, feathering propeller, feathering screw) |   | 53 compass repeater with pelorus   |
|  |   | 54 patent log (screw log, mechanical log, towing log, taffrail log, speedometer)   |



- |   |  |   |
|---|--|---|
| 55 rotator  | 74 light and bell buoy   | 94 can buoy   |
| 56 governor   | 75 bell  | 95 port hand buoys (port hand marks) [red]                                |
| 57 log clock  | 76 conical buoy  | 96 starboard hand buoys (starboard hand marks) [black]                    |
| 58-67 leads   | 77 can buoy  | 97 shoals (shallows, shallow water, <i>Am.</i> flats) outside the fairway |
| 58 hand lead  | 78 topmark   | 98 middle of the fairway (mid-channel)                                    |
| 59 lead (lead sinker)   | 79 spar buoy   | 99 starboard markers (inverted broom)                                     |
| 60 leadline   | 80 topmark buoy  | 100 port markers [upward-pointing broom]                                  |
| 61-67 echo sounder (echo sounding machine)                                      | 81 lightship (light vessel)  | 101-102 range lights (leading lights)                                     |
| 61 sound transmitter  | 82 lantern mast (lantern tower)  | 101 lower range light (lower leading light)                               |
| 62 sound wave (sound impulse)   | 83 beam of light   | 102 higher range light (higher leading light)                             |
| 63 echo (sound echo, echo signal)   | 84-102 fairway markings (channel markings)   | 103 lighthouse  |
| 64 echo receiver (hydrophone)   | 85 wreck to starboard  | 104 radar antenna (radar scanner)   |
| 65 echograph (echo sounding machine recorder)                                   | 86 wreck to port   | 105 lantern (characteristic light)  |
| 66 depth scale  | 87 shoals (shallows, shallow water, <i>Am.</i> flats)  | 106 radio direction finder (RDF) antenna                                  |
| 67 echogram (depth recording, depth reading)                                    | 88 middle ground to port [beginning of the middle ground; topmark: red cylinder above red ball]        | 107 machinery and observation platform (machinery and observation deck)   |
| 68-108 sea marks (floating navigational marks) for buoyage and lighting systems | 89 division (bifurcation)  | 108 living quarters   |
| 68-83 fairway marks (channel marks)   | 90 convergence (confluence) [end of the middle ground; topmark: red St. Antony's cross above red ball] |   |
| 68 light and whistle buoy   | 91 middle ground   |   |
| 69 light (warning light)  | 92 main fairway (main navigable channel)   |   |
| 70 whistle  | 93 secondary fairway (secondary navigable channel)   |   |
| 71 buoy   |  |   |
| 72 mooring chain  |  |   |
| 73 sinker (mooring sinker)  |  |   |



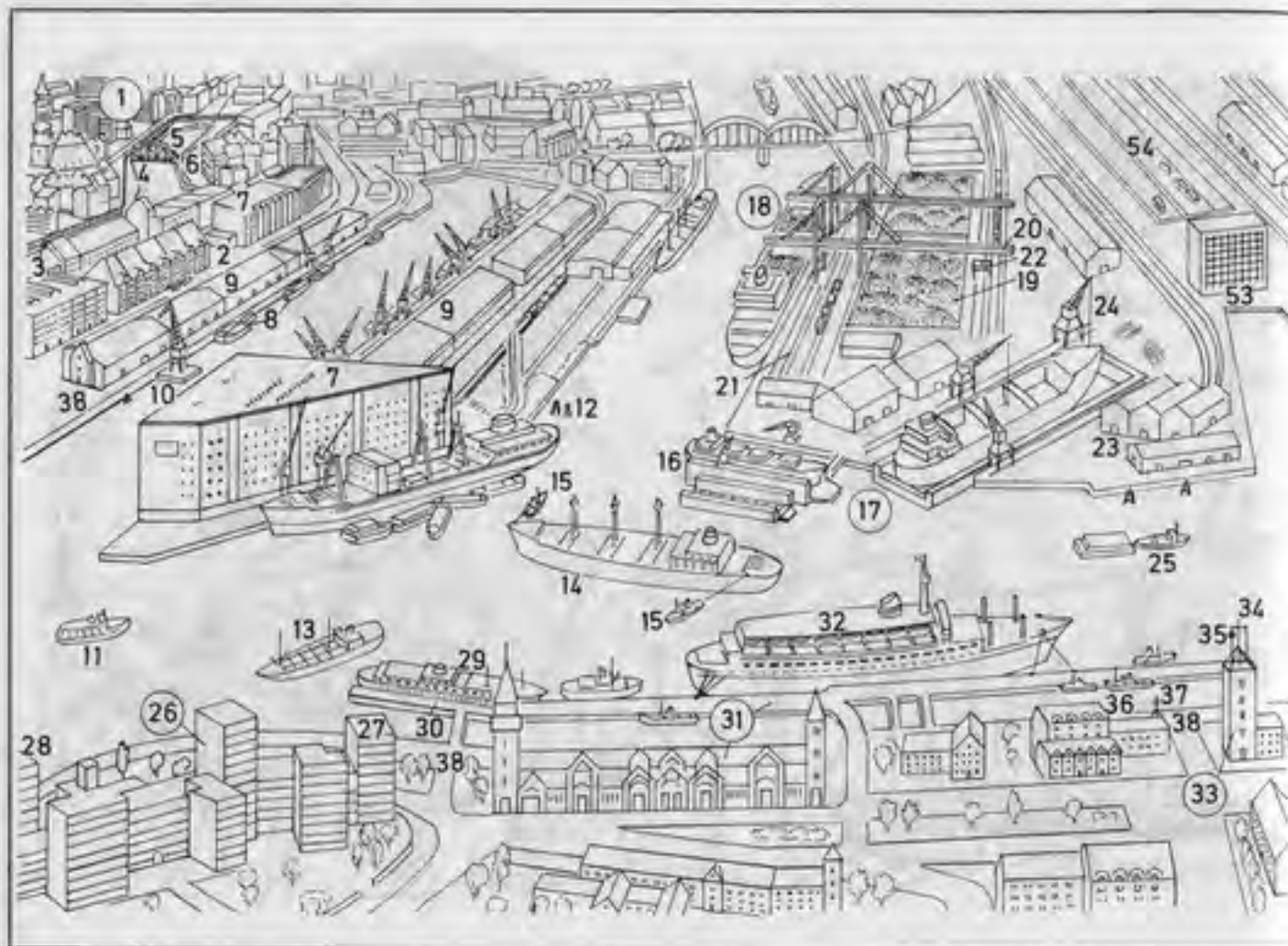

- |  |   |
|--|---|
| 1 dock area  | 21 quayside railway   |
| 2 free port (foreign trade zone)   | 22 weighing bunker  |
| 3 free zone frontier (free zone enclosure)   | 23 warehouse  |
| 4 customs barrier  | 24 quayside crane   |
| 5 customs entrance   | 25 launch and lighter   |
| 6 port custom house  | 26 port hospital  |
| 7 entrepôt   | 27 quarantine wing  |
| 8 barge (dumb barge, lighter)  | 28 Institute of Tropical Medicine                               |
| 9 break-bulk cargo transit shed (general cargo transit shed, package cargo transit shed) | 29 excursion steamer (pleasure steamer)                         |
| 10 floating crane  | 30 jetty  |
| 11 harbour (Am. harbor) ferry (ferryboat)  | 31 passenger terminal   |
| 12 fender (dolphin)  | 32 liner (passenger liner, ocean liner)                         |
| 13 bunkering boat  | 33 meteorological office, a weather station                     |
| 14 break-bulk carrier (general cargo ship)   | 34 signal mast (signalling mast)                                |
| 15 tug   | 35 storm signal   |
| 16 floating dock (pontoon dock)  | 36 port administration offices                                  |
| 17 dry dock  | 37 tide level indicator   |
| 18 coal wharf  | 38 quayside road (quayside roadway)                             |
| 19 coal bunker   | 39 roll-on roll-off (ro-ro) system (roll-on roll-off operation) |
| 20 transporter loading bridge  | 40 gantry   |

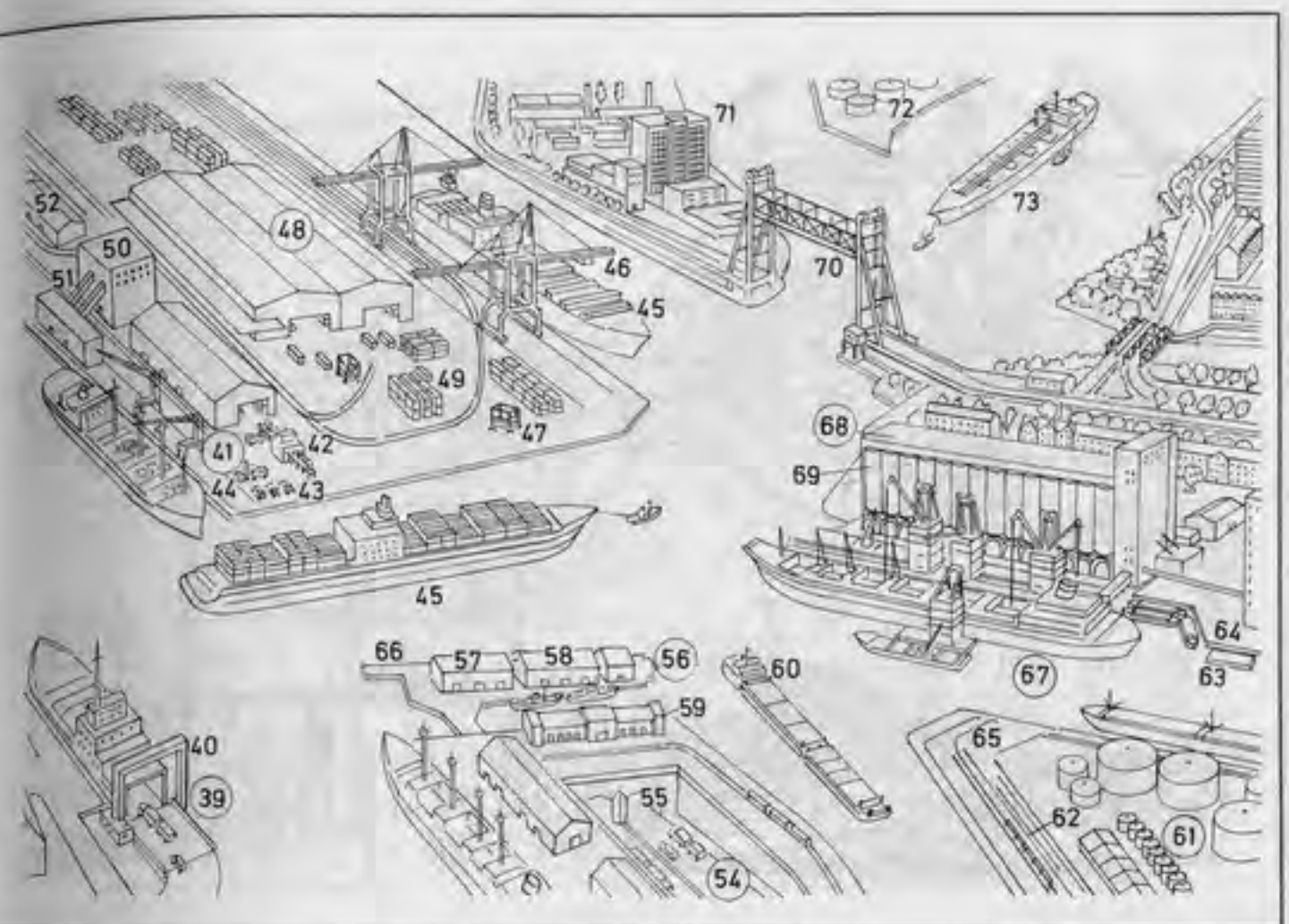

- |   |                                    |
|---|------------------------------------|
| 41 truck-to-truck system (truck-to-truck operation) | 61 tank farm                       |
| 42 foil-wrapped unit loads                          | 62 railway siding                  |
| 43 pallets  | 63 landing pontoon (landing stage) |
| 44 forklift truck (fork truck, forklift)            | 64 quay                            |
| 45 container ship                                   | 65 breakwater (mole)               |
| 46 transporter container-loading bridge             | 66 pier (jetty), a quay extension  |
| 47 container carrier truck                          | 67 bulk carrier                    |
| 48 container terminal (container berth)             | 68 silo                            |
| 49 unit load  | 69 silo cylinder                   |
| 50 cold store                                       | 70 lift bridge                     |
| 51 conveyor belt (conveyor)                         | 71 industrial plant                |
| 52 fruit storage shed (fruit warehouse)             | 72 storage tanks                   |
| 53 office building                                  | 73 tanker                          |
| 54 urban motorway (Am. freeway)                     |                                    |
| 55 harbour (Am. harbor) tunnels                     |                                    |
| 56 fish dock  |                                    |
| 57 fish market                                      |                                    |
| 58 auction room                                     |                                    |
| 59 fish-canning factory                             |                                    |
| 60 push tow   |                                    |



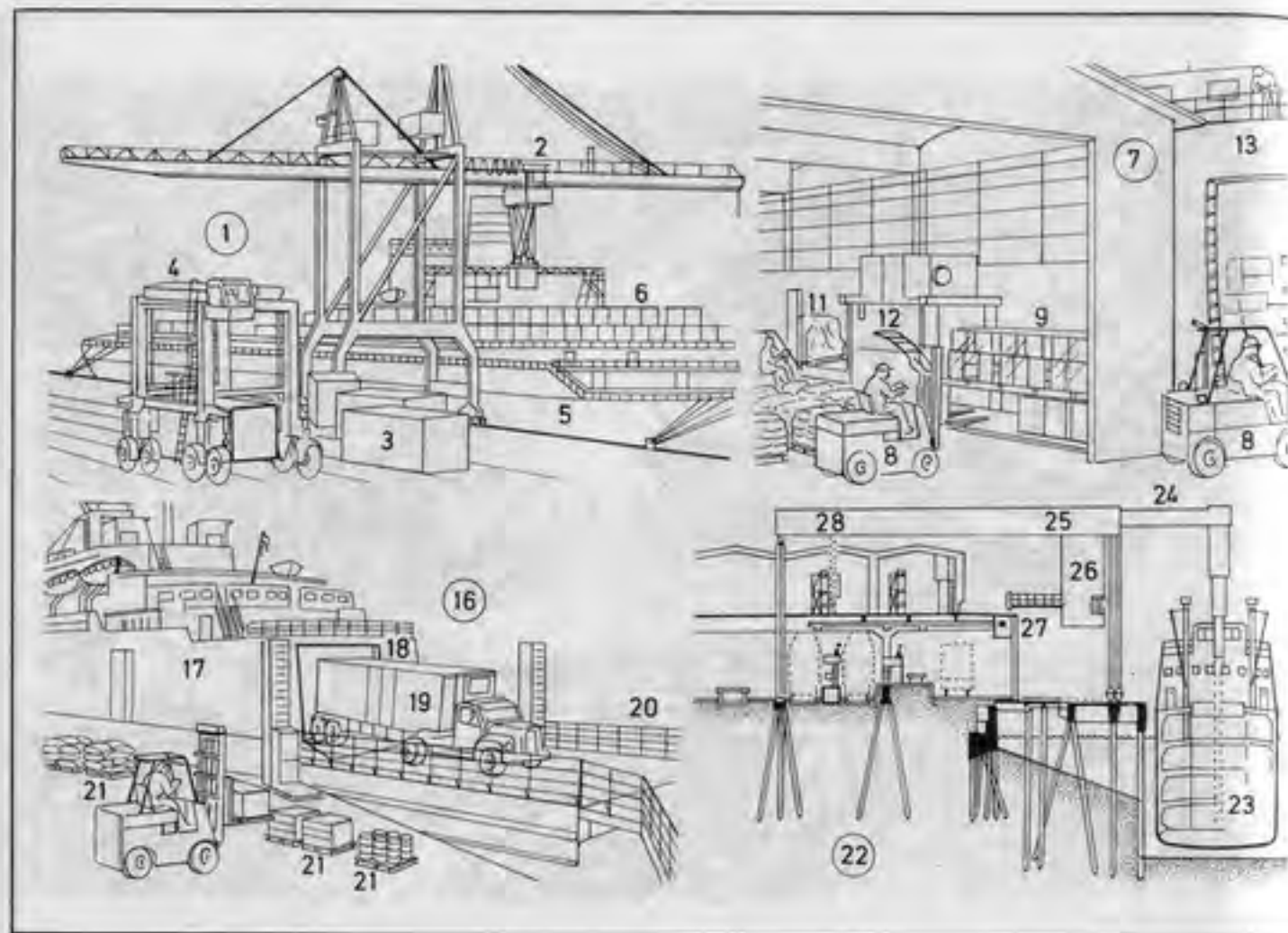

- |  |   |
|--|---|
| 1 container terminal (container berth), a modern cargo-handling berth                                  | 17 roll-on roll-off ship (ro-ro-ship)                                     |
| 2 transporter container-loading bridge (loading bridge); <i>sim.</i> : transtainer crane (transtainer) | 18 stern port (stern opening)   |
| 3 container  | 19 driven load, a lorry ( <i>Am.</i> truck)                               |
| 4 truck (carrier)  | 20 ro-ro depot  |
| 5 all-container ship   | 21 unitized load (unitized package)                                       |
| 6 containers stowed on deck  | 22 banana-handling terminal [section]                                     |
| 7 truck-to-truck handling (horizontal cargo handling with pallets)                                     | 23 seaward tumbler  |
| 8 forklift truck (fork truck, forklift)  | 24 jib  |
| 9 unitized foil-wrapped load (unit load)   | 25 elevator bridge  |
| 10 flat pallet, a standard pallet  | 26 chain sling  |
| 11 unitized break-bulk cargo   | 27 lighting station   |
| 12 heat sealing machine  | 28 shore-side tumbler for loading trains and lorries ( <i>Am.</i> trucks) |
| 13 break-bulk carrier (general cargo ship)   | 29 bulk cargo handling  |
| 14 cargo hatchway  | 30 bulk carrier   |
| 15 receiving truck on board ship   | 31 floating bulk-cargo elevator   |
| 16 multi-purpose terminal  | 32 suction pipes  |
|  | 33 receiver   |
|  | 34 delivery pipe  |
|  | 35 bulk transporter barge   |
|  | 36 floating pile driver   |
|  | 37 pile driver frame  |
|  | 38 pile hammer  |

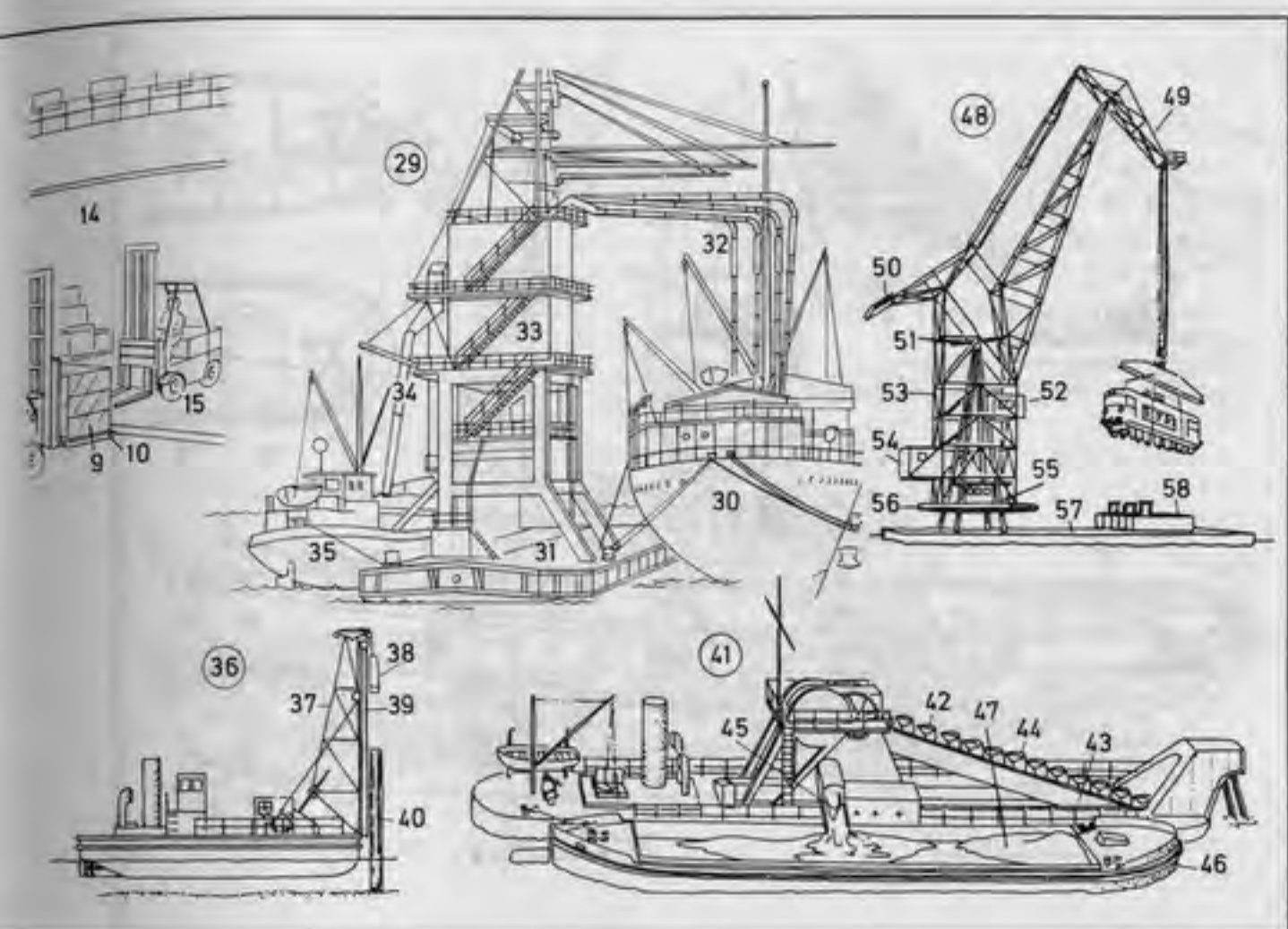

- |   |
|---|
| 39 driving guide rail                         |
| 40 pile                                       |
| 41 bucket dredger, a dredger                  |
| 42 bucket chain                               |
| 43 bucket ladder                              |
| 44 dredger bucket                             |
| 45 chute                                      |
| 46 hopper barge                               |
| 47 spoil                                      |
| 48 floating crane                             |
| 49 jib (boom)                                 |
| 50 counterweight (counterpoise)               |
| 51 adjusting spindle                          |
| 52 crane driver's cabin (crane driver's cage) |
| 53 crane framework                            |
| 54 winch house                                |
| 55 control platform                           |
| 56 turntable                                  |
| 57 pontoon, a pram                            |
| 58 engine superstructure (engine mounting)    |



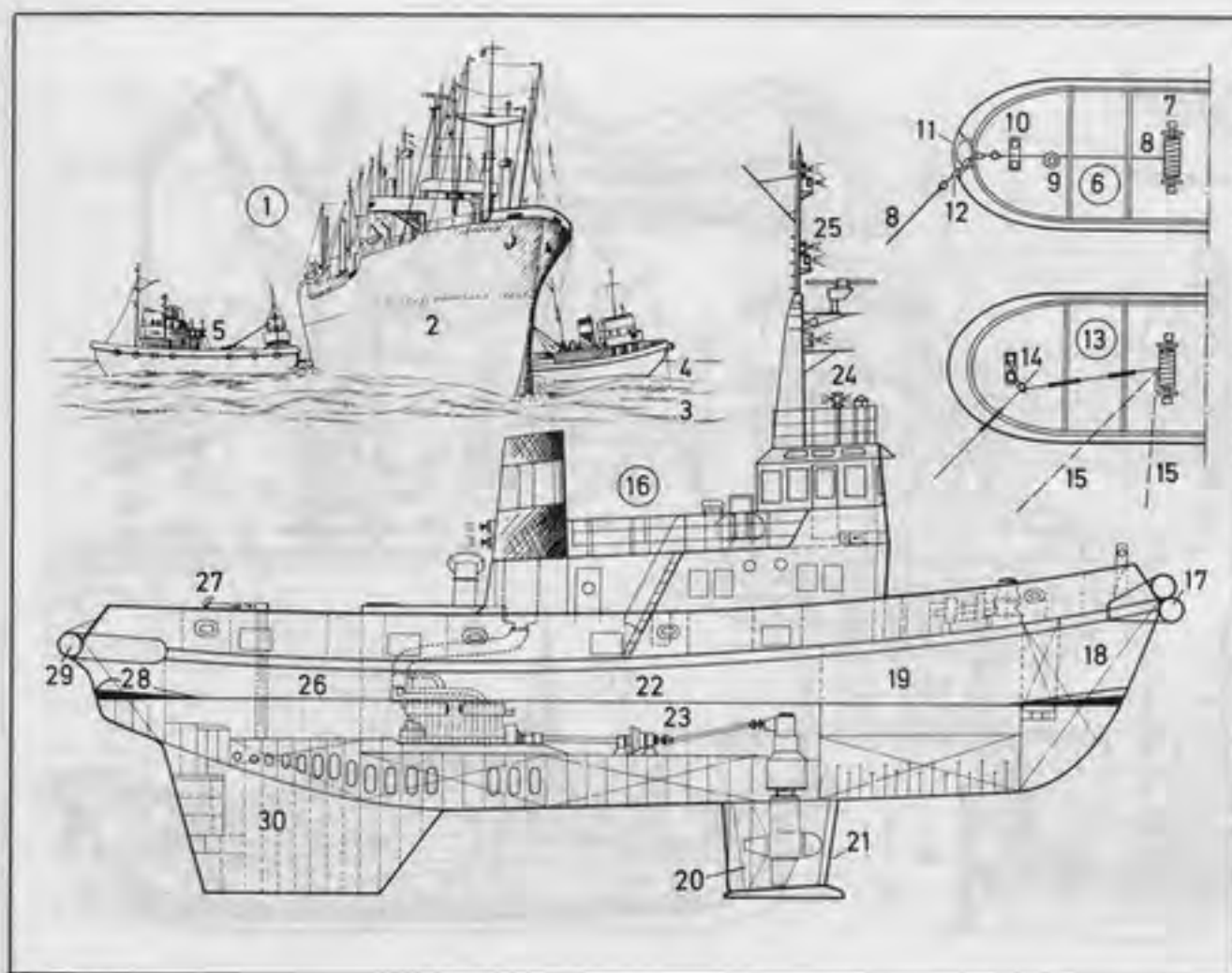

- |   |   |
|---|---|
| 1 salvaging (salving) of a ship run aground               | 18 forepeak   |
| 2 ship run aground (damaged vessel)                       | 19 living quarters  |
| 3 sandbank; <i>also</i> : quicksand                       | 20 Schottel propeller   |
| 4 open sea  | 21 Kort vent  |
| 5 tug (salvage tug)                                       | 22 engine and propeller room                                      |
| 6-15 towing gear  | 23 clutch coupling  |
| 6 towing gear for towing at sea                           | 24 compass platform (compass bridge, compass flat, monkey bridge) |
| 7 towing winch (towing machine, towing engine)            | 25 fire-fighting equipment  |
| 8 tow rope (tow line, towing hawser)                      | 26 stowage  |
| 9 tow rope guide  | 27 tow hook   |
| 10 cross-shaped bollard                                   | 28 afterpeak  |
| 11 hawse hole   | 29 stern fender   |
| 12 anchor cable (chain cable)                             | 30 main manoeuvring ( <i>Am.</i> maneuvering) keel                |
| 13 towing gear for work in harbours ( <i>Am.</i> harbors) |   |
| 14 guest rope   |   |
| 15 position of the tow rope (tow line, towing hawser)     |   |
| 16 tug (salvage tug) [vertical elevation]                 |   |
| 17 bow fender (pudding fender)                            |   |

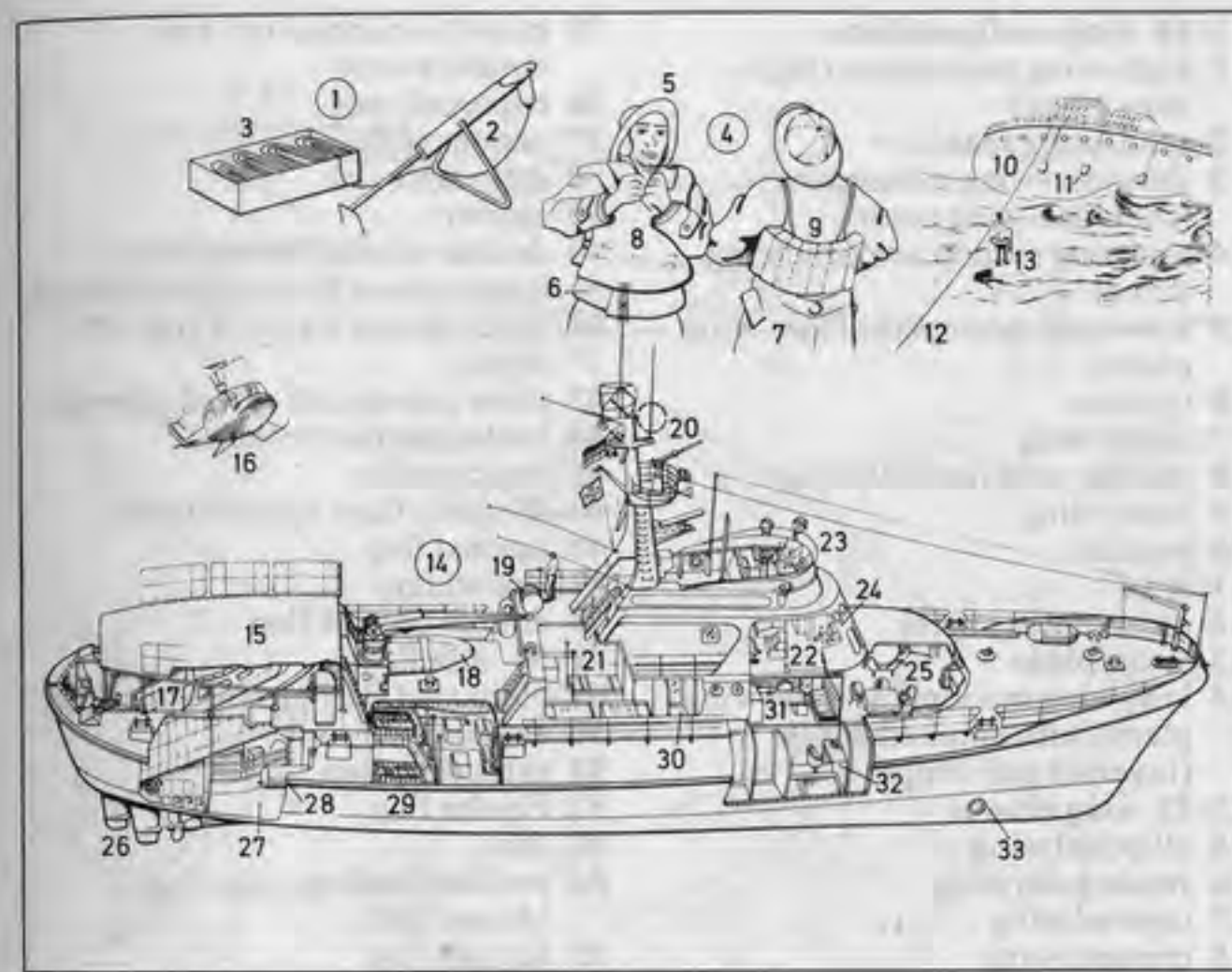

- |  |   |
|--|---|
| 1 rocket apparatus (rocket gun, line-throwing gun) | 21 hospital unit with operating cabin and exposure bath |
| 2 life rocket (rocket)                             | 22 navigating bridge                                    |
| 3 rocket line (whip line)                          | 23 upper tier of navigating bridge                      |
| 4 oilskins   | 24 lower tier of navigating bridge                      |
| 5 sou'wester (southwester)                         | 25 messroom   |
| 6 oilskin jacket                                   | 26 rudders and propeller (screw)                        |
| 7 oilskin coat                                     | 27 stowage  |
| 8 inflatable life jacket                           | 28 foam can   |
| 9 cork life jacket (cork life preserver)           | 29 side engines   |
| 10 stranded ship (damaged vessel)                  | 30 shower   |
| 11 oil bag, for trickling oil on the water surface | 31 coxswain's cabin                                     |
| 12 lifeline  | 32 crew member's single-berth cabin                     |
| 13 breeches buoy                                   | 33 bow propeller  |
| 14 rescue cruiser                                  |   |
| 15 helicopter landing deck                         |   |
| 16 rescue helicopter                               |   |
| 17 daughter boat                                   |   |
| 18 inflatable boat (inflatable dinghy)             |   |
| 19 life raft                                       |   |
| 20 fire-fighting equipment for fires at sea        |   |



**1-14 wing configurations**

- 1 high-wing monoplane (high-wing plane)
- 2 span (wing span)
- 3 shoulder-wing monoplane (shoulder-wing plane)
- 4 midwing monoplane (midwing plane)
- 5 low-wing monoplane (low-wing plane)
- 6 triplane
- 7 upper wing
- 8 middle wing (central wing)
- 9 lower wing
- 10 biplane
- 11 strut
- 12 cross bracing wires
- 13 sesquiplane
- 14 low-wing monoplane (low-wing plane) with cranked wings (inverted gull wings)

**15-22 wing shapes**

- 15 elliptical wing
- 16 rectangular wing
- 17 tapered wing
- 18 crescent wing
- 19 delta wing
- 20 swept-back wing with semi-positive sweepback
- 21 swept-back wing with positive sweepback
- 22 ogival wing (ogee wing)
- 23-36 tail shapes** (tail unit shapes, empennage shapes)
- 23 normal tail (normal tail unit)
- 24-25 vertical tail (vertical stabilizer and rudder)
- 24 vertical stabilizer (vertical fin, tail fin)
- 25 rudder
- 26-27 horizontal tail
- 26 tailplane (horizontal stabilizer)
- 27 elevator
- 28 cruciform tail (cruciform tail unit)
- 29 T-tail (T-tail unit)
- 30 lobe
- 31 V-tail (vee-tail, butterfly tail)
- 32 double tail unit (twin tail unit)
- 33 end plate
- 34 double tail unit (twin tail unit) of a twin-boom aircraft

- 35 raised horizontal tail with double booms
- 36 triple tail unit
- 37 system of flaps**
- 38 extensible slat
- 39 spoiler
- 40 double-slotted Fowler flap
- 41 outer aileron (low-speed aileron)
- 42 inner spoiler (landing flap, lift dump)
- 43 inner aileron (all-speed aileron)
- 44 brake flap (air brake)
- 45 basic profile
- 46-48 plain flaps** (simple flaps)
- 46 normal flap
- 47 slotted flap
- 48 double-slotted flap
- 49-50 split flaps**
- 49 plain split flap (simple split flap)
- 50 zap flap
- 51 extending flap
- 52 Fowler flap
- 53 slat
- 54 profiled leading-edge flap (droop flap)
- 55 Krüger flap

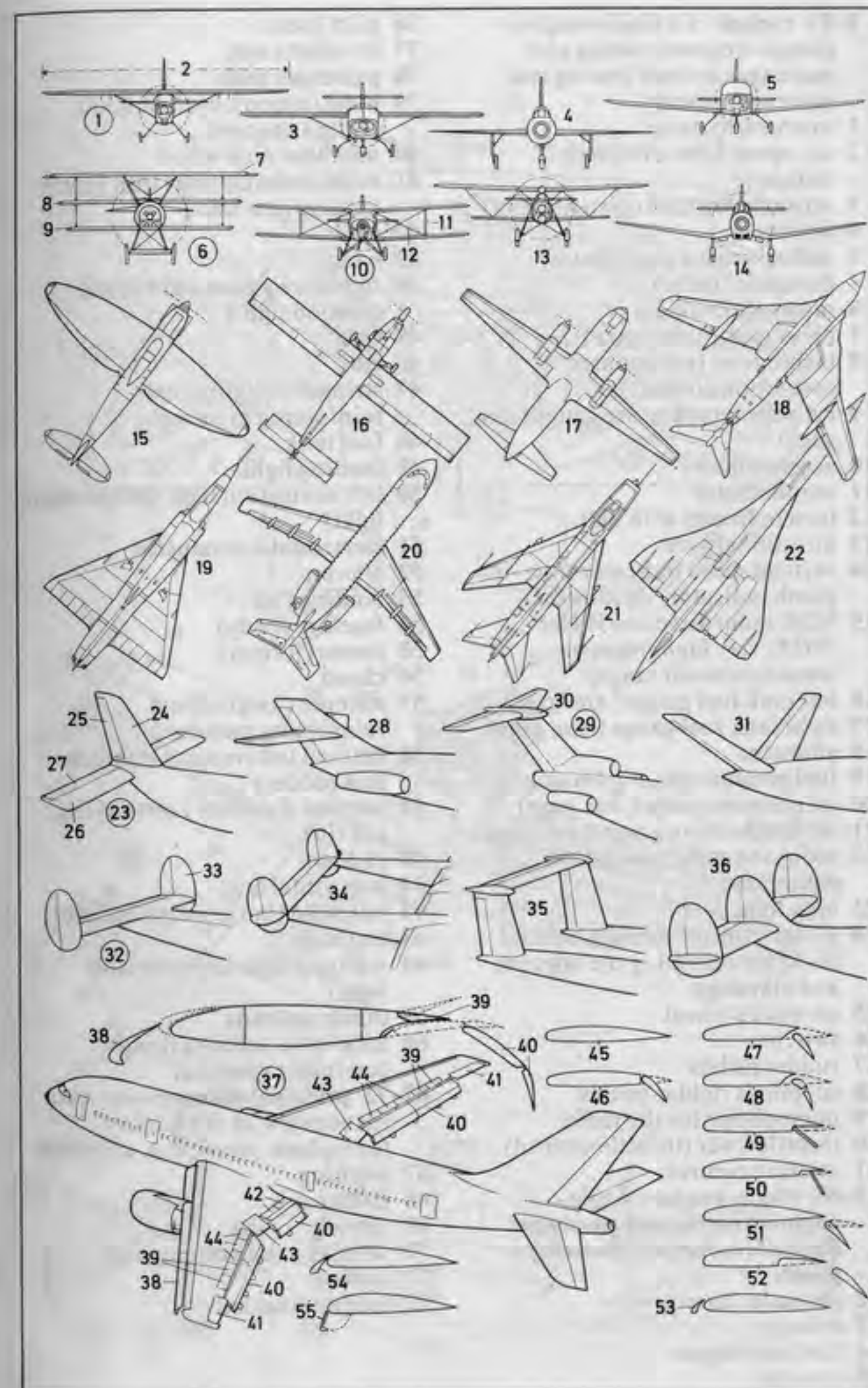



- 1-31 cockpit of a single-engine (single-engined) racing and passenger aircraft (racing and passenger plane)**
- 1 instrument panel
  - 2 air-speed (*Am.* airspeed) indicator
  - 3 artificial horizon (gyro horizon)
  - 4 altimeter
  - 5 radio compass (automatic direction finder)
  - 6 magnetic compass
  - 7 boost gauge (*Am.* gage)
  - 8 tachometer (rev counter, revolution counter)
  - 9 cylinder temperature gauge (*Am.* gage)
  - 10 accelerometer
  - 11 chronometer
  - 12 turn indicator with ball
  - 13 directional gyro
  - 14 vertical speed indicator (rate-of-climb indicator, variometer)
  - 15 VOR radio direction finder [*VOR: very high frequency omnidirectional range*]
  - 16 left tank fuel gauge (*Am.* gage)
  - 17 right tank fuel gauge (*Am.* gage)
  - 18 ammeter
  - 19 fuel pressure gauge (*Am.* gage)
  - 20 oil pressure gauge (*Am.* gage)
  - 21 oil temperature gauge (*Am.* gage)
  - 22 radio and radio navigation equipment
  - 23 map light
  - 24 wheel (control column, control stick) for operating the ailerons and elevators
  - 25 co-pilot's wheel
  - 26 switches
  - 27 rudder pedals
  - 28 co-pilot's rudder pedals
  - 29 microphone for the radio
  - 30 throttle lever (throttle control)
  - 31 mixture control
- 32-66 single-engine (single-engined) racing and passenger aircraft (racing and passenger plane)**
- 32 propeller (airscrew)
  - 33 spinner
  - 34 flat four engine
  - 35 cockpit
  - 36 pilot's seat
  - 37 co-pilot's seat
  - 38 passenger seats
  - 39 hood (canopy, cockpit hood, cockpit canopy)
  - 40 steerable nose wheel
  - 41 main undercarriage unit (main landing gear unit)
  - 42 step
  - 43 wing
  - 44 right navigation light (right position light)
  - 45 spar
  - 46 rib
  - 47 stringer (longitudinal reinforcing member)
  - 48 fuel tank
  - 49 landing light
  - 50 left navigation light (left position light)
  - 51 electrostatic conductor
  - 52 aileron
  - 53 landing flap
  - 54 fuselage (body)
  - 55 frame (former)
  - 56 chord
  - 57 stringer (longitudinal reinforcing member)
  - 58 vertical tail (vertical stabilizer and rudder)
  - 59 vertical stabilizer (vertical fin, tail fin)
  - 60 rudder
  - 61 horizontal tail
  - 62 tailplane (horizontal stabilizer)
  - 63 elevator
  - 64 warning light (anticollision light)
  - 65 dipole antenna
  - 66 long-wire antenna (long-conductor antenna)
- 67-72 principal manoeuvres (*Am.* maneuvers) of the aircraft (aeroplane, plane, *Am.* airplane)**
- 67 pitching
  - 68 lateral axis
  - 69 yawing
  - 70 vertical axis (normal axis)
  - 71 rolling
  - 72 longitudinal axis

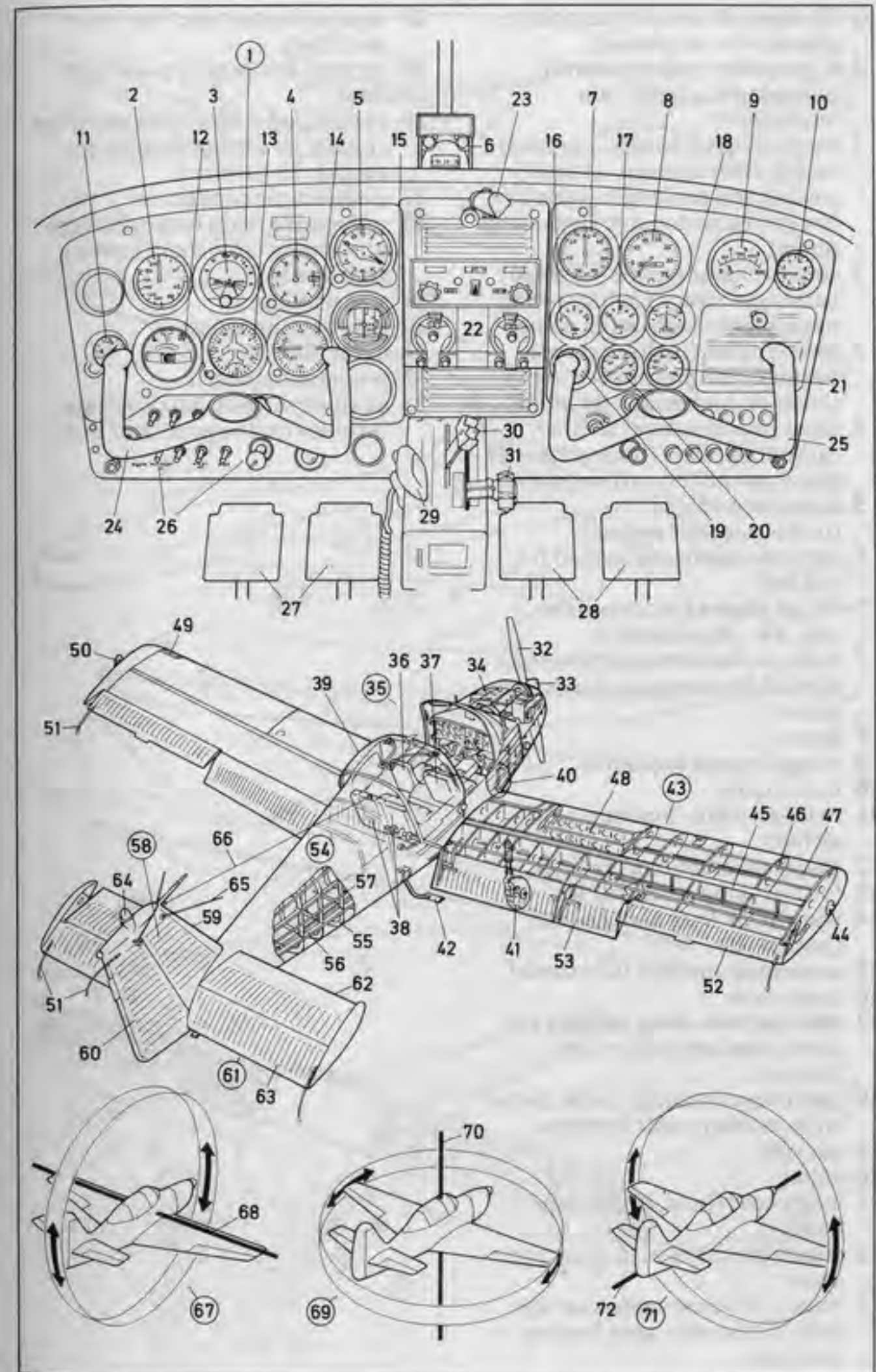



- 1-33 types of aircraft (aeroplanes, planes, *Am.* airplanes)
- 1-6 propeller-driven aircraft (aeroplanes, planes, *Am.* airplanes)
- 1 single-engine (single-engined) racing and passenger aircraft (racing and passenger plane), a low-wing monoplane (low-wing plane)
- 2 single-engine (single-engined) passenger aircraft, a high-wing monoplane (high-wing plane)
- 3 twin-engine (twin-engined) business and passenger aircraft (business and passenger plane)
- 4 short/medium haul airliner, a turboprop plane (turbopropeller plane, propeller-turbine plane)
- 5 turboprop engine (turbopropeller engine)
- 6 vertical stabilizer (vertical fin, tail fin)
- 7-33 jet planes (jet aeroplanes, jets, *Am.* jet airplanes)
- 7 twin-jet business and passenger aircraft (business and passenger plane)
- 8 fence
- 9 wing-tip tank (tip tank)
- 10 rear engine
- 11 twin-jet short/medium haul airliner
- 12 tri-jet medium haul airliner
- 13 four-jet long haul airliner
- 14 wide-body long haul airliner (jumbo jet)
- 15 supersonic airliner [*Concorde*]
- 16 droop nose
- 17 twin-jet wide-body airliner for short/medium haul routes (airbus)
- 18 radar nose (radome, radar dome) with weather radar antenna
- 19 cockpit
- 20 galley
- 21 cargo hold (hold, underfloor hold)
- 22 passenger cabin with passenger seats
- 23 retractable nose undercarriage unit (retractable nose landing gear unit)
- 24 nose undercarriage flap (nose gear flap)
- 25 centre (*Am.* center) passenger door
- 26 engine pod with engine (turbojet engine, jet turbine engine, jet engine, jet turbine)
- 27 electrostatic conductors
- 28 retractable main undercarriage unit (retractable main landing gear unit)
- 29 side window
- 30 rear passenger door
- 31 toilet (lavatory, WC)
- 32 pressure bulkhead
- 33 auxiliary engine (auxiliary gas turbine) for the generator unit

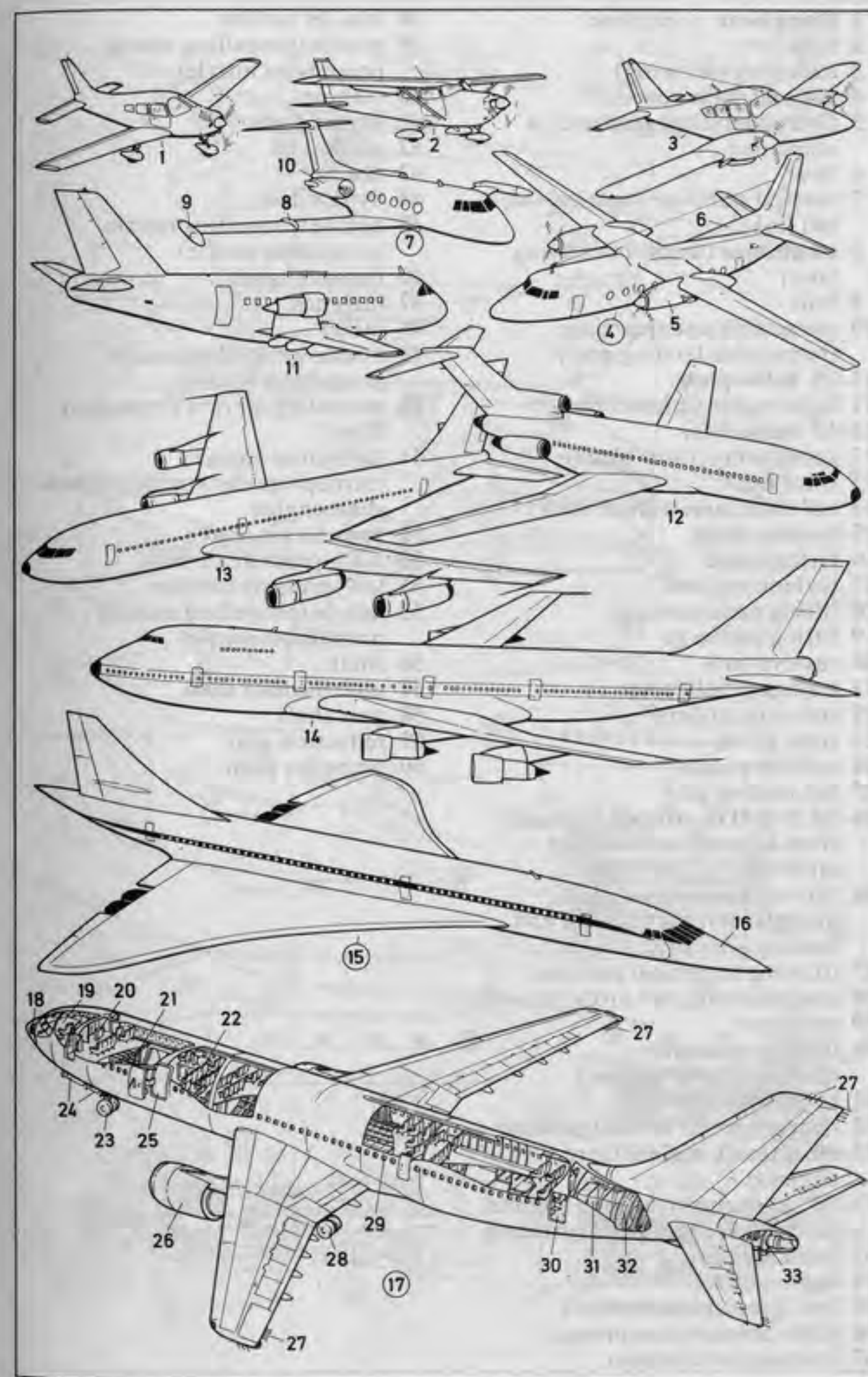



- 1 flying boat, a seaplane
- 2 hull
- 3 stub wing (sea wing)
- 4 tail bracing wires
- 5 floatplane (float seaplane), a seaplane
- 6 float
- 7 vertical stabilizer (vertical fin, tail fin)
- 8 amphibian (amphibian flying boat)
- 9 hull
- 10 retractable undercarriage (retractable landing gear)
- 11-25 helicopters
- 11 light multirole helicopter
- 12-13 main rotor
- 12 rotary wing (rotor blade)
- 13 rotor head
- 14 tail rotor (anti-torque rotor)
- 15 landing skids
- 16 flying crane
- 17 turbine engines
- 18 lifting undercarriage
- 19 lifting platform
- 20 reserve tank
- 21 transport helicopter
- 22 rotors in tandem
- 23 rotor pylon
- 24 turbine engine
- 25 tail loading gate
- 26-32 V/STOL aircraft (vertical/short take-off and landing aircraft)
- 26 tilt-wing aircraft, a VTOL aircraft (vertical take-off and landing aircraft)
- 27 tilt wing in vertical position
- 28 contrarotating tail propellers
- 29 gyrodyne
- 30 turboprop engine (turbopropeller engine)
- 31 convertiplane
- 32 tilting rotor in vertical position
- 33-60 aircraft engines (aero engines)
- 33-50 jet engines (turbojet engines, jet turbine engines, jet turbines)
- 33 front fan-jet
- 34 fan
- 35 low-pressure compressor
- 36 high-pressure compressor
- 37 combustion chamber
- 38 fan-jet turbine
- 39 nozzle (propelling nozzle, propulsion nozzle)
- 40 turbines
- 41 bypass duct
- 42 aft fan-jet
- 43 fan
- 44 bypass duct
- 45 nozzle (propelling nozzle, propulsion nozzle)
- 46 bypass engine
- 47 turbines
- 48 mixer
- 49 nozzle (propelling nozzle, propulsion nozzle)
- 50 secondary air flow (bypass air flow)
- 51 turboprop engine (turbopropeller engine), a twin-shaft engine
- 52 annular air intake
- 53 high-pressure turbine
- 54 low-pressure turbine
- 55 nozzle (propelling nozzle, propulsion nozzle)
- 56 shaft
- 57 intermediate shaft
- 58 gear shaft
- 59 reduction gear
- 60 propeller shaft

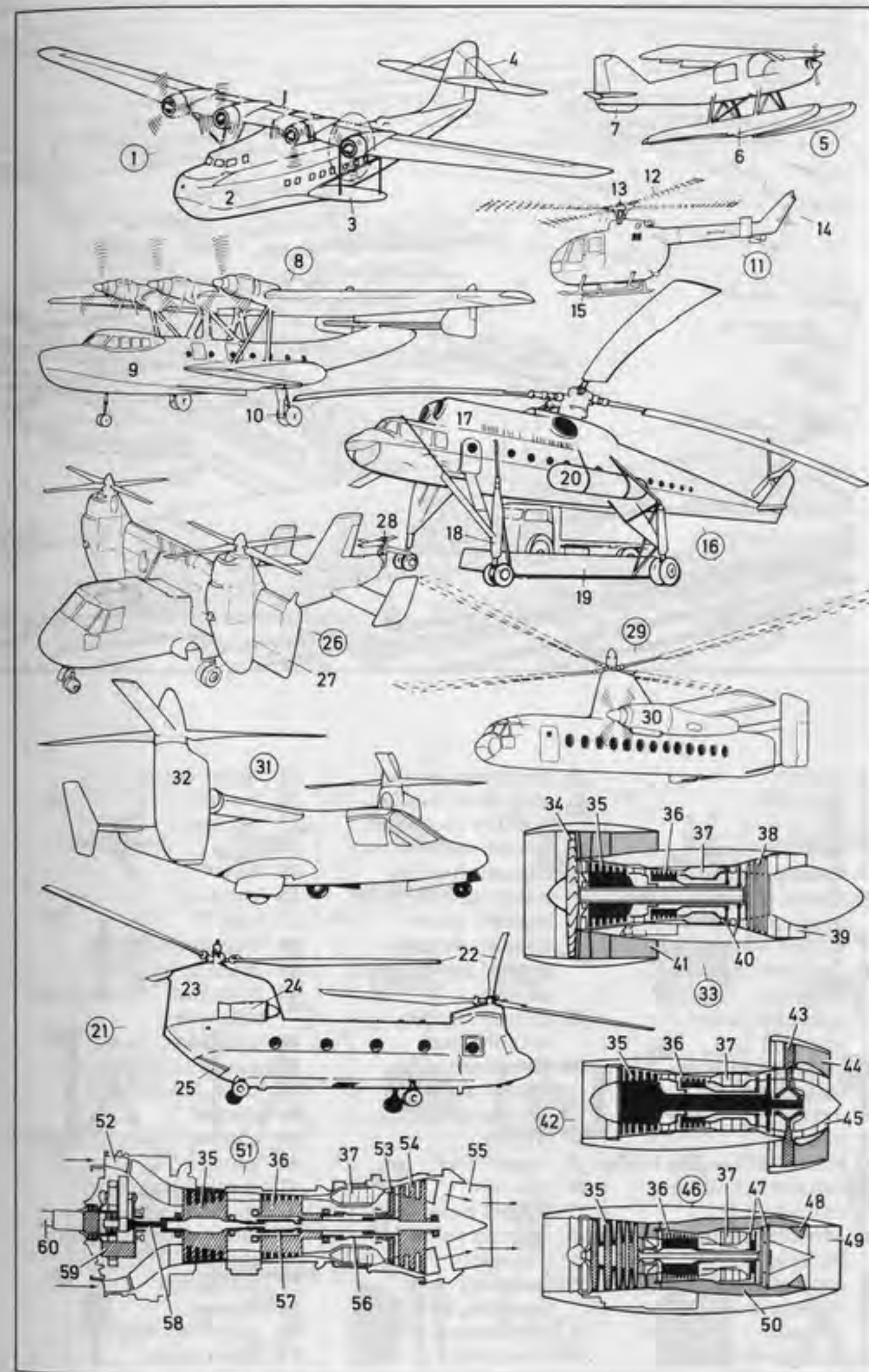





- |   |   |                                       |
|---|---|---------------------------------------|
| 1 runway                                  | 20 spectators' terrace  | 31 'information'                      |
| 2 taxiway                                 | 21 aircraft in loading position (nosed in)  | 32 'taxis'                            |
| 3 apron                                   | 22 service vehicles, e.g. baggage loaders, water tankers, galley loaders, toilet-cleaning vehicles, ground power units, tankers | 33 'car hire'                         |
| 4 apron taxiway                           | 23 aircraft tractor (aircraft tug)  | 34 'trains'                           |
| 5 baggage terminal                        | 24-53 airport information symbols (pictographs)   | 35 'buses'                            |
| 6 tunnel entrance to the baggage terminal | 24 'airport'  | 36 'entrance'                         |
| 7 airport fire service                    | 25 'departures'   | 37 'exit'                             |
| 8 fire appliance building                 | 26 'arrivals'   | 38 'baggage retrieval'                |
| 9 mail and cargo terminal                 | 27 'transit passengers'   | 39 'luggage lockers'                  |
| 10 cargo warehouse                        | 28 'waiting room' ('lounge')  | 40 'telephone - emergency calls only' |
| 11 assembly point                         | 29 'assembly point' ('meeting point', 'rendezvous point')   | 41 'emergency exit'                   |
| 12 pier                                   | 30 'spectators' terrace'  | 42 'passport check'                   |
| 13 pierhead                               |   | 43 'press facilities'                 |
| 14 passenger loading bridge               |   | 44 'doctor'                           |
| 15 departure building (terminal)          |   | 45 'chemist' (Am. 'druggist')         |
| 16 administration building                |   | 46 'showers'                          |
| 17 control tower (tower)                  |   | 47 'gentlemen's toilet' ('gentlemen') |
| 18 waiting room (lounge)                  |   | 48 'ladies toilet' ('ladies')         |
| 19 airport restaurant                     |   | 49 'chapel'                           |
|   |   | 50 'restaurant'                       |
|   |   | 51 'change'                           |
|   |   | 52 'duty free shop'                   |
|   |   | 53 'hairdresser'                      |





- 1 Saturn V 'Apollo' booster (booster rocket) [overall view]
- 2 Saturn V 'Apollo' booster (booster rocket) [overall sectional view]
- 3 first rocket stage (S-IC)
- 4 F-1 engines
- 5 heat shield (thermal protection shield)
- 6 aerodynamic engine fairings
- 7 aerodynamic stabilizing fins
- 8 stage separation retro-rockets, 8 rockets arranged in 4 pairs
- 9 kerosene (RP-1) tank [capacity: 811,000 litres]
- 10 liquid oxygen (LOX, LO<sub>2</sub>) supply lines
- 11 anti-vortex system (device for preventing the formation of vortices in the fuel)
- 12 liquid oxygen (LOX, LO<sub>2</sub>) tank [capacity: 1,315,000 litres]
- 13 anti-slosh baffles
- 14 compressed-helium bottles (helium pressure bottles)
- 15 diffuser for gaseous oxygen
- 16 inter-tank connector (inter-tank section)
- 17 instruments and system-monitoring devices
- 18 second rocket stage (S-II)
- 19 J-2 engines
- 20 heat shield (thermal protection shield)
- 21 engine mounts and thrust structure
- 22 acceleration rockets for fuel acquisition
- 23 liquid hydrogen (LH<sub>2</sub>) suction line
- 24 liquid oxygen (LOX, LO<sub>2</sub>) tank [capacity: 1,315,000 litres]
- 25 standpipe
- 26 liquid hydrogen (LH<sub>2</sub>) tank [capacity: 1,020,000 litres]
- 27 fuel level sensor
- 28 work platform (working platform)
- 29 cable duct
- 30 manhole
- 31 S-IC/S-II inter-stage connector (inter-stage section)
- 32 compressed-gas container (gas pressure vessel)
- 33 third rocket stage (S-IVB)
- 34 J-2 engine
- 35 nozzle (thrust nozzle)
- 36 S-II/S-IVB inter-stage connector (inter-stage section)
- 37 four second-stage (S-II) separation retro-rockets
- 38 attitude control rockets
- 39 liquid oxygen (LOX, LO<sub>2</sub>) tank [capacity: 77,200 litres]
- 40 fuel line duct
- 41 liquid hydrogen (LH<sub>2</sub>) tank [capacity: 253,000 litres]
- 42 measuring probes
- 43 compressed-helium tanks (helium pressure vessels)
- 44 tank vent
- 45 forward frame section
- 46 work platform (working platform)
- 47 cable duct
- 48 acceleration rockets for fuel acquisition
- 49 aft frame section
- 50 compressed-helium tanks (helium pressure vessels)
- 51 liquid hydrogen (LH<sub>2</sub>) line
- 52 liquid oxygen (LOX, LO<sub>2</sub>) line
- 53 24-panel instrument unit
- 54 LM hangar (lunar module hangar)
- 55 LM (lunar module)
- 56 Apollo SM (service module), containing supplies and equipment
- 57 SM (service module) main engine
- 58 fuel tank
- 59 nitrogen tetroxide tank
- 60 pressurized gas delivery system
- 61 oxygen tanks
- 62 fuel cells
- 63 manoeuvring (*Am.* maneuvering) rocket assembly
- 64 directional antenna assembly
- 65 space capsule (command section)
- 66 launch phase escape tower

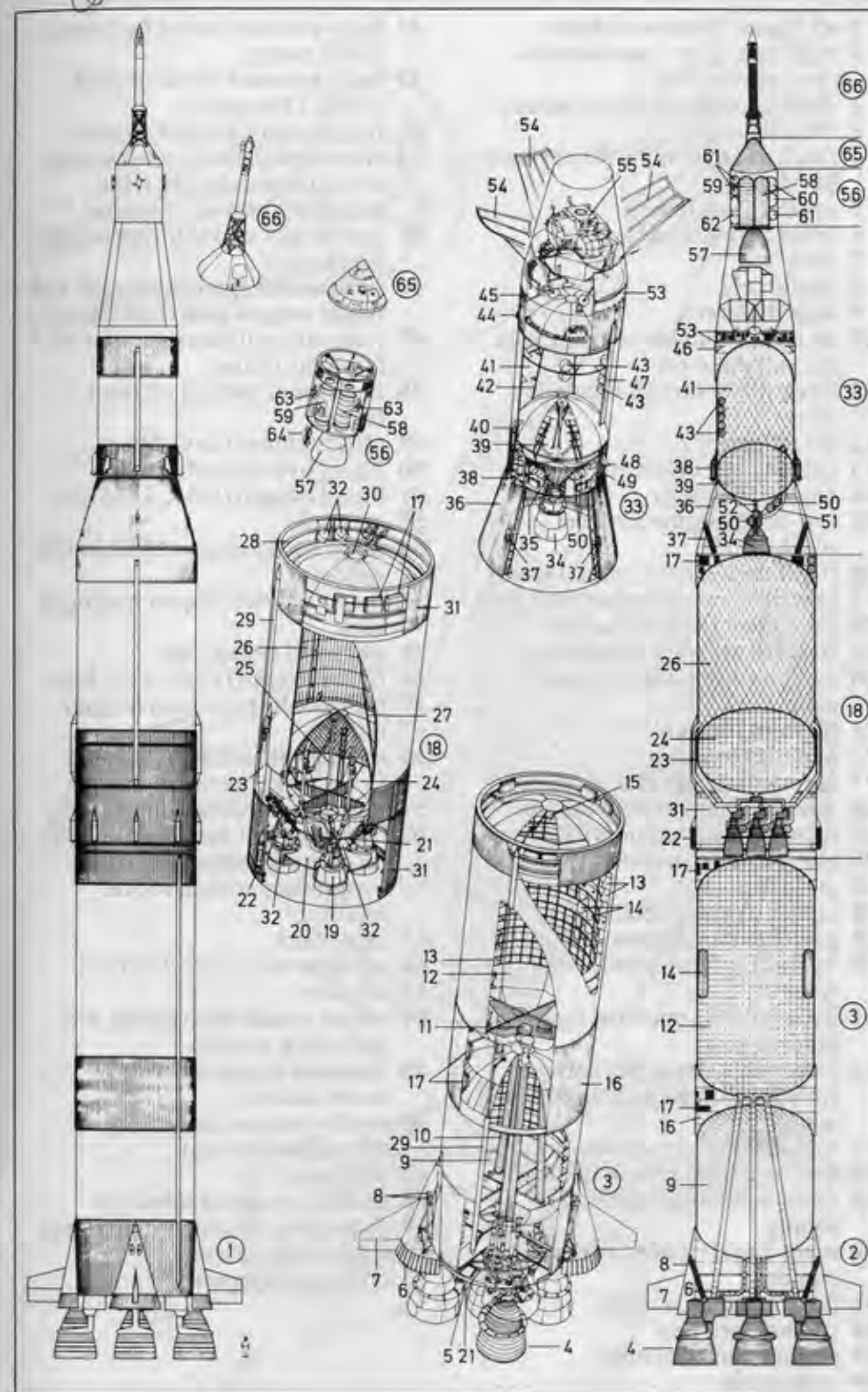



## 1-45 Space Shuttle-Orbiter

- 1 twin-spar (two-spar, double-spar) vertical fin
- 2 engine compartment structure
- 3 fin post
- 4 fuselage attachment [of payload bay doors]
- 5 upper thrust mount
- 6 lower thrust mount
- 7 keel
- 8 heat shield
- 9 waist longeron
- 10 integrally machined (integrally milled) main rib
- 11 integrally stiffened light alloy skin
- 12 lattice girder
- 13 payload bay insulation
- 14 payload bay door
- 15 low-temperature surface insulation
- 16 flight deck (crew compartment)
- 17 captain's seat (commander's seat)
- 18 pilot's seat (co-pilot's seat)
- 19 forward pressure bulkhead
- 20 carbon fibre reinforced nose cone
- 21 forward fuel tanks
- 22 avionics consoles
- 23 automatic flight control panel
- 24 upward observation windows
- 25 forward observation windows
- 26 entry hatch to payload bay
- 27 air lock
- 28 ladder to lower deck
- 29 payload manipulator arm
- 30 hydraulically steerable nose wheel
- 31 hydraulically operated main landing gear
- 32 removable (reusable) carbon fibre reinforced leading edge [of wing]
- 33 movable elevon sections
- 34 heat-resistant elevon structure
- 35 main liquid hydrogen (LH<sub>2</sub>) supply
- 36 main liquid-fuelled rocket engine
- 37 nozzle (thrust nozzle)
- 38 coolant feed line
- 39 engine control system
- 40 heat shield

- 41 high-pressure liquid hydrogen (LH<sub>2</sub>) pump
- 42 high-pressure liquid oxygen (LOX, LO<sub>2</sub>) pump
- 43 thrust vector control system
- 44 electromechanically controlled orbital manoeuvring (*Am.* maneuvering) main engine
- 45 nozzle fuel tanks (thrust nozzle fuel tanks)
- 46 jettisonable liquid hydrogen and liquid oxygen tank (fuel tank)
- 47 integrally stiffened annular rib (annular frame)
- 48 hemispherical end rib (end frame)
- 49 aft attachment to Orbiter
- 50 liquid hydrogen (LH<sub>2</sub>) line
- 51 liquid oxygen (LOX, LO<sub>2</sub>) line
- 52 manhole
- 53 surge baffle system (slosh baffle system)
- 54 pressure line to liquid hydrogen tank
- 55 electrical system bus
- 56 liquid oxygen (LOX, LO<sub>2</sub>) line
- 57 pressure line to liquid oxygen tank
- 58 recoverable solid-fuel rocket (solid rocket booster)
- 59 auxiliary parachute bay
- 60 compartment housing the recovery parachutes and the forward separation rocket motors
- 61 cable duct
- 62 aft separation rocket motors
- 63 aft skirt
- 64 swivel nozzle (swivelling, *Am.* swiveling, nozzle)
- 65 **Spacelab** (space laboratory, space station)
- 66 multi-purpose laboratory (orbital workshop)
- 67 astronaut
- 68 gimbal-mounted telescope
- 69 measuring instrument platform
- 70 spaceflight module
- 71 crew entry tunnel

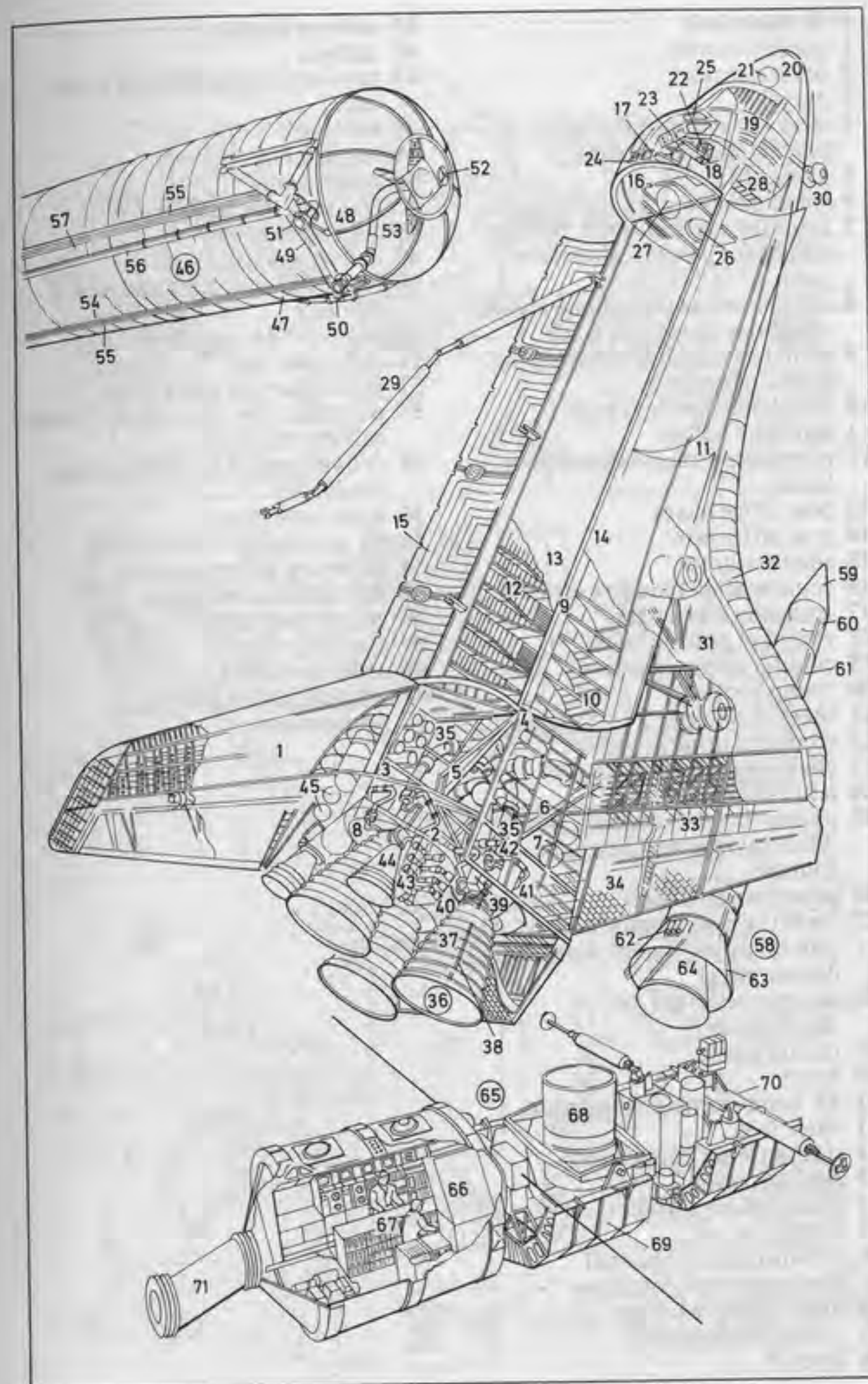



- 1-30 main hall
- 1 parcels counter
  - 2 parcels scales
  - 3 parcel
  - 4 stick-on address label with parcel registration slip
  - 5 glue pot
  - 6 small parcel
  - 7 franking machine (*Am.* postage meter) for parcel registration cards
  - 8 telephone box (telephone booth, telephone kiosk, call box)
  - 9 coin-box telephone (pay phone, public telephone)
  - 10 telephone directory rack
  - 11 directory holder
  - 12 telephone directory (telephone book)
  - 13 post office boxes
  - 14 post office box
  - 15 stamp counter
  - 16 counter clerk (counter officer)
  - 17 company messenger
  - 18 record of posting book
  - 19 counter stamp machine
  - 20 stamp book
  - 21 sheet of stamps
  - 22 security drawer
  - 23 change rack
  - 24 letter scales
  - 25 paying-in (*Am.* deposit), post office savings, and pensions counter
  - 26 accounting machine
  - 27 franking machine for money orders and paying-in slips (*Am.* deposit slips)
  - 28 change machine (*Am.* changemaker)
  - 29 receipt stamp
  - 30 hatch
  - 31-44 letter-sorting installation
  - 31 letter feed
  - 32 stacked letter containers
  - 33 feed conveyor
  - 34 intermediate stacker
  - 35 coding station
  - 36 pre-distributor channel
  - 37 process control computer
  - 38 distributing machine
  - 39 video coding station
  - 40 screen
  - 41 address display
  - 42 address
  - 43 post code (postal code, *Am.* zip code)
  - 44 keyboard
  - 45 handstamp
  - 46 roller stamp
  - 47 franking machine
  - 48 feed mechanism
  - 49 delivery mechanism
  - 50-55 postal collection and delivery
  - 50 postbox (*Am.* mailbox)
  - 51 collection bag
  - 52 post office van (mail van)
  - 53 postman (*Am.* mail carrier, letter carrier, mailman)
  - 54 delivery pouch (postman's bag, mailbag)
  - 55 letter-rate item
  - 56-60 postmarks
  - 56 postmark advertisement
  - 57 date stamp postmark
  - 58 charge postmark
  - 59 special postmark
  - 60 roller postmark
  - 61 stamp (postage stamp)
  - 62 perforations

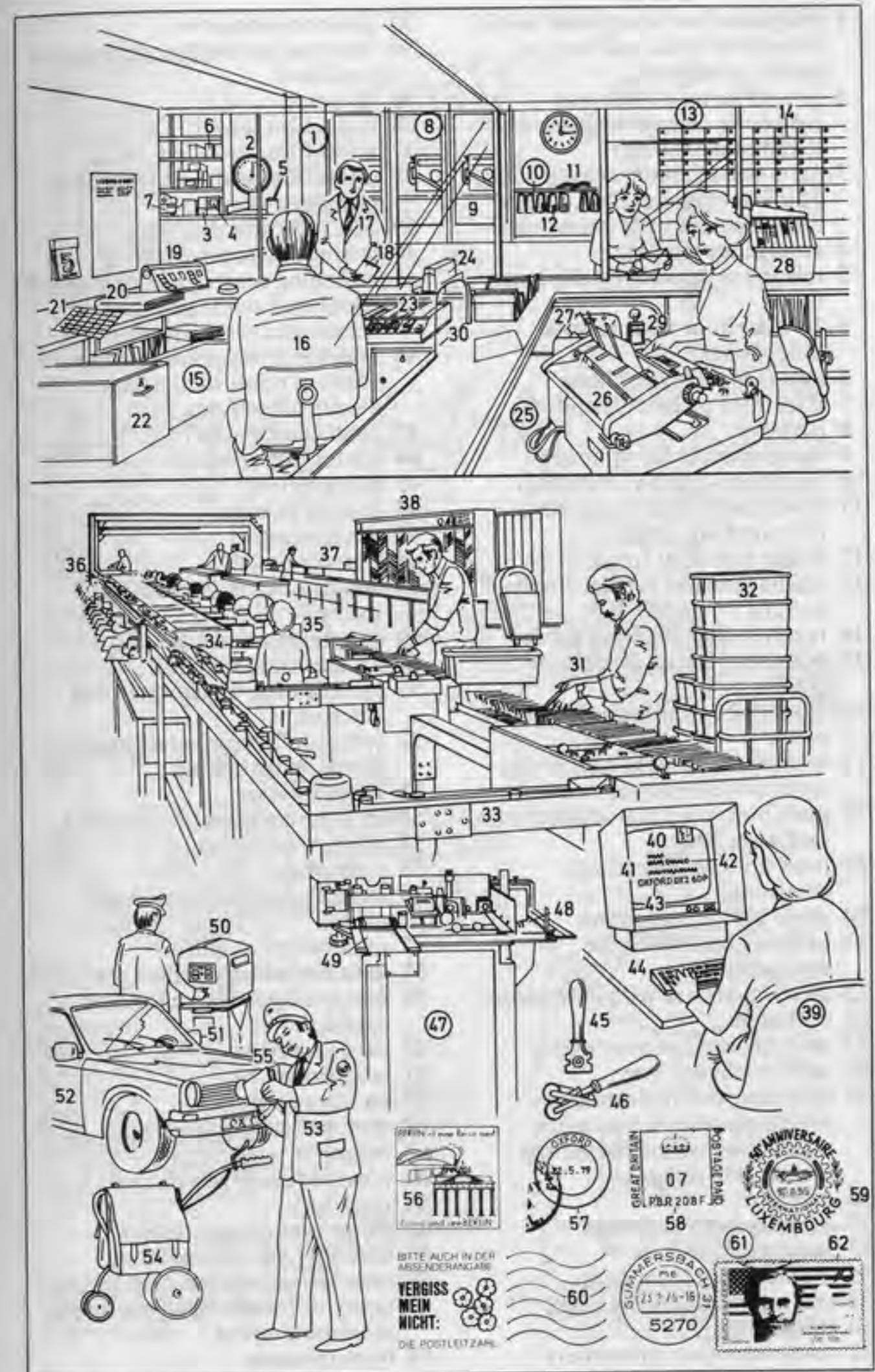



- 1 telephone box (telephone booth, telephone kiosk, call box), a public telephone
- 2 telephone user (*with own telephone*: telephone subscriber, telephone customer)
- 3 coin-box telephone (pay phone, public telephone) for local and long-distance calls (trunk calls)
- 4 emergency telephone
- 5 telephone directory (telephone book)
- 6-26 telephone instruments (telephones)
- 6 standard table telephone
- 7 telephone receiver (handset)
- 8 earpiece
- 9 mouthpiece (microphone)
- 10 dial (push-button keyboard)
- 11 finger plate (dial finger plate, dial wind-up plate)
- 12 finger stop (dial finger stop)
- 13 cradle (handset cradle, cradle switch)
- 14 receiver cord (handset cord)
- 15 telephone casing (telephone cover)
- 16 subscriber's (customer's) private meter
- 17 switchboard (exchange) for a system of extensions
- 18 push button for connecting main exchange lines
- 19 push buttons for calling extensions
- 20 push-button telephone
- 21 earthing button for the extensions
- 22-26 switchboard with extensions
- 22 exchange
- 23 switchboard operator's set
- 24 main exchange line
- 25 switching box (automatic switching system, automatic connecting system, switching centre, *Am. center*)
- 26 extension
- 27-41 telephone exchange
- 27 fault repair service
- 28 maintenance technician
- 29 testing board (testing desk)
- 30 telegraphy
- 31 teleprinter (teletypewriter)
- 32 paper tape
- 33 directory enquiries
- 34 information position (operator's position)
- 35 operator
- 36 microfilm reader
- 37 microfilm file
- 38 microfilm card with telephone numbers
- 39 date indicator display
- 40 testing and control station
- 41 switching centre (*Am. center*) for telephone, telex, and data transmission services
- 42 selector, a motor uniselector made of noble metals; *sim.*: electronic selector
- 43 contact arc (bank)
- 44 contact arm (wiper)
- 45 contact field
- 46 contact arm tag
- 47 electromagnet
- 48 selector motor
- 49 restoring spring (resetting spring)
- 50 communication links
- 51-52 satellite radio link
- 51 earth station with directional antenna
- 52 communications satellite with directional antenna
- 53 coastal station
- 54-55 intercontinental radio link
- 54 short-wave station
- 55 ionosphere
- 56 submarine cable (deep-sea cable)
- 57 underwater amplifier
- 58 data transmission (data services)
- 59 input/output device for data carriers
- 60 data processor
- 61 teleprinter
- 62-64 data carriers
- 62 punched tape (punch tape)
- 63 magnetic tape
- 64 punched card (punch card)
- 65 telex link
- 66 teleprinter (page printer)
- 67 dialling (*Am. dialing*) unit
- 68 telex tape (punched tape, punch tape) for transmitting the text at maximum speed
- 69 telex message
- 70 keyboard

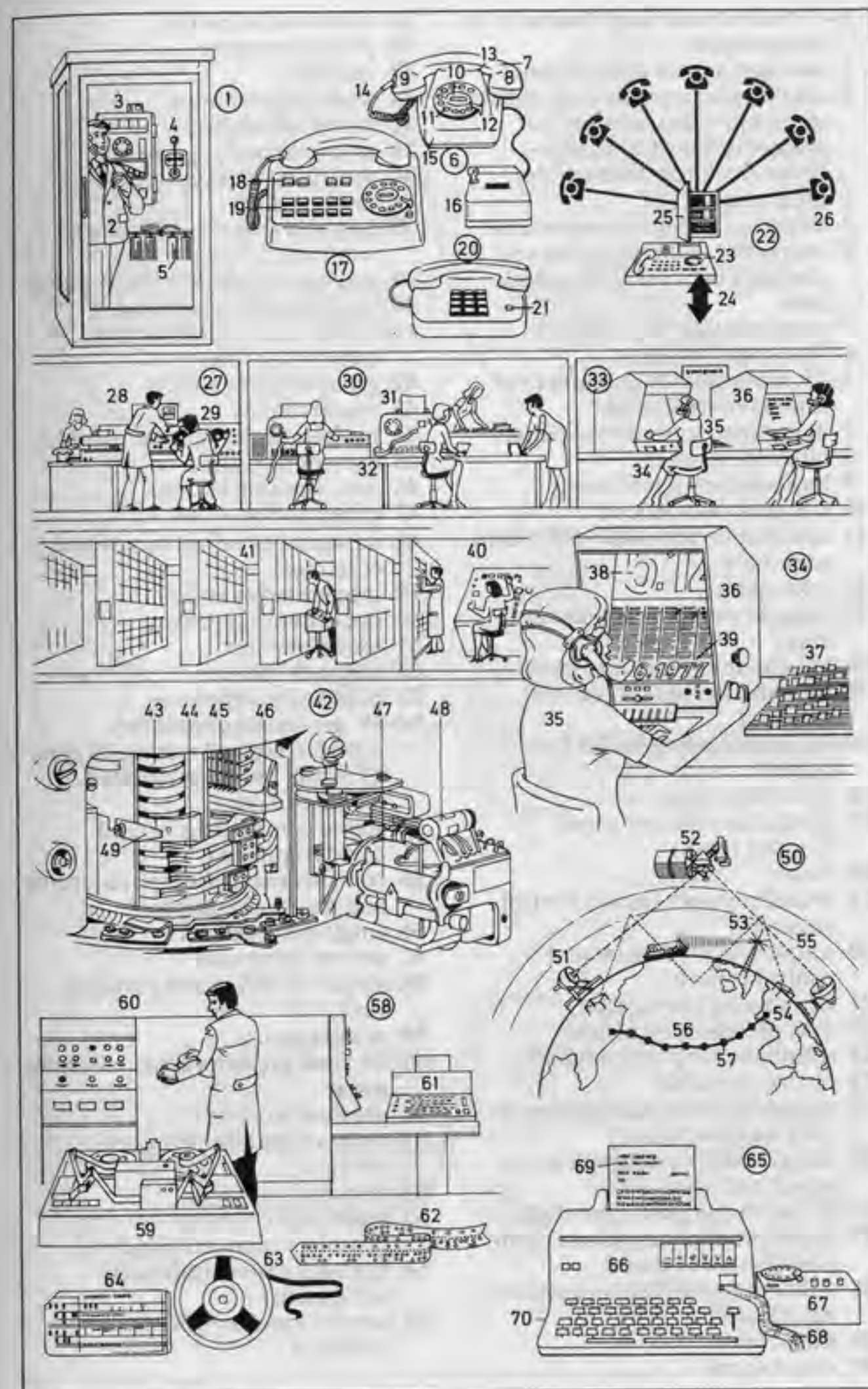



- 1-6 central recording channel of a radio station**
- 1 monitoring and control panel
  - 2 data display terminal (video data terminal, video monitor) for visual display of computer-controlled programmes (*Am.* programs)
  - 3 amplifier and mains power unit
  - 4 magnetic sound recording and playback deck for  $\frac{1}{4}$ " magnetic tape
  - 5 magnetic tape, a  $\frac{1}{4}$ " tape
  - 6 film spool holder
- 7-15 radio switching centre (*Am.* center) control room**
- 7 monitoring and control panel
  - 8 talkback speaker
  - 9 local-battery telephone
  - 10 talkback microphone
  - 11 data display terminal (video data terminal)
  - 12 teleprinter
  - 13 input keyboard for computer data
  - 14 telephone switchboard panel
  - 15 monitoring speaker (control speaker)
- 16-26 broadcasting centre (*Am.* center)**
- 16 recording room
  - 17 production control room (control room)
  - 18 studio
  - 19 sound engineer (sound control engineer)
  - 20 sound control desk (sound control console)
  - 21 newsreader (newscaster)
  - 22 duty presentation officer
  - 23 telephone for phoned reports
  - 24 record turntable
  - 25 recording room mixing console (mixing desk, mixer)
  - 26 sound technician (sound mixer, sound recordist)
- 27-53 television post-sync studio**
- 27 sound production control room (sound control room)
  - 28 dubbing studio (dubbing theatre, *Am.* theater)
  - 29 studio table
  - 30 visual signal
  - 31 electronic stopclock
  - 32 projection screen
  - 33 monitor
  - 34 studio microphone
  - 35 sound effects box
  - 36 microphone socket panel
  - 37 recording speaker (recording loudspeaker)
  - 38 control room window (studio window)
  - 39 producer's talkback microphone
  - 40 local-battery telephone
  - 41 sound control desk (sound control console)
  - 42 group selector switch
  - 43 visual display
  - 44 limiter display (clipper display)
  - 45 control modules
  - 46 pre-listening buttons
  - 47 slide control
  - 48 universal equalizer (universal corrector)
  - 49 input selector switch
  - 50 pre-listening speaker
  - 51 tone generator
  - 52 talkback speaker
  - 53 talkback microphone
- 54-59 pre-mixing room for transferring and mixing 16 mm, 17.5 mm, 35 mm perforated magnetic film**
- 54 sound control desk (sound control console)
  - 55 compact magnetic tape recording and playback equipment
  - 56 single playback deck
  - 57 central drive unit
  - 58 single recording and playback deck
  - 59 rewind bench
- 60-65 final picture quality checking room**
- 60 preview monitor
  - 61 programme (*Am.* program) monitor
  - 62 stopclock
  - 63 vision mixer (vision-mixing console, vision-mixing desk)
  - 64 talkback system (talkback equipment)
  - 65 camera monitor (picture monitor)

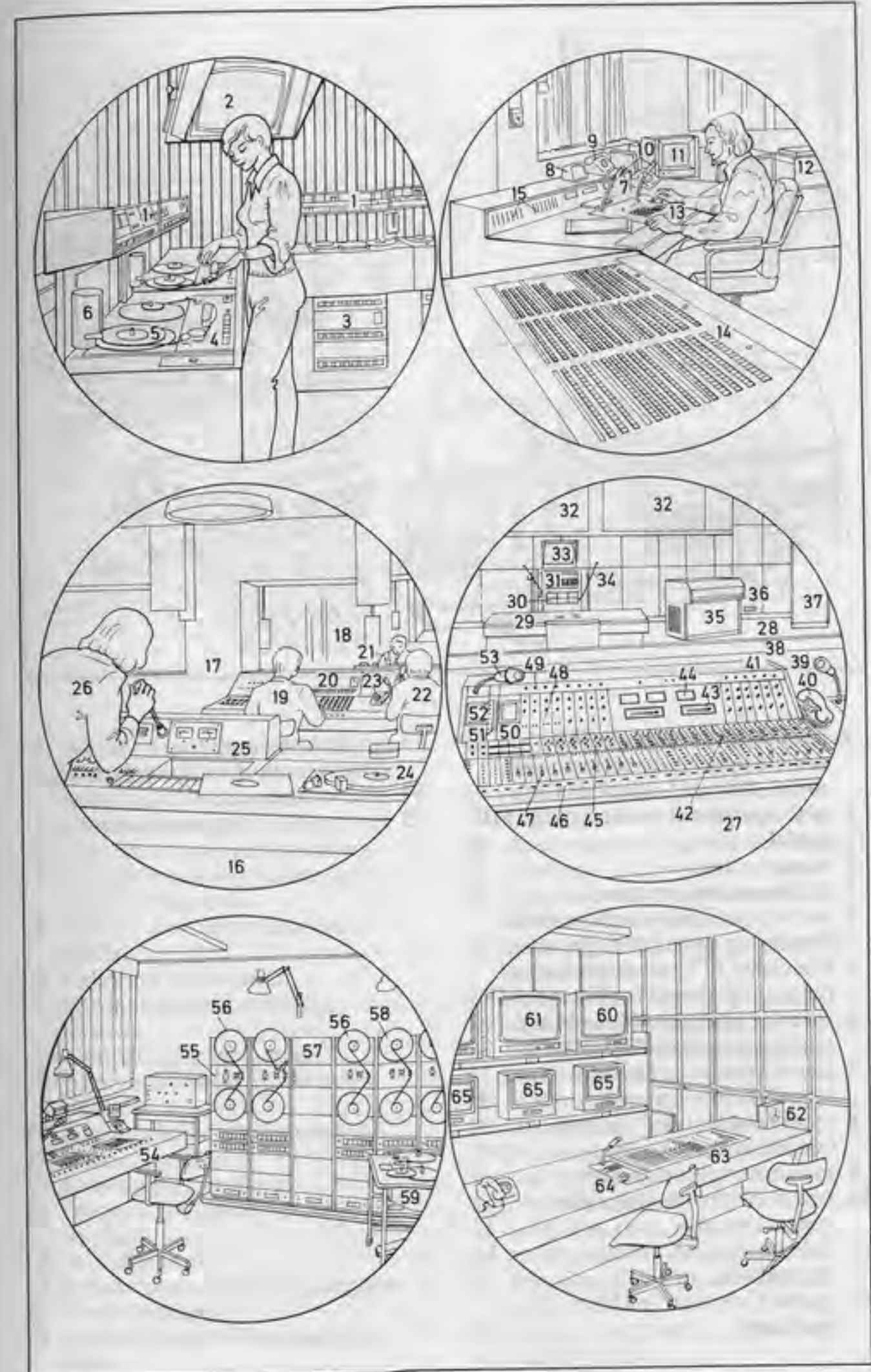



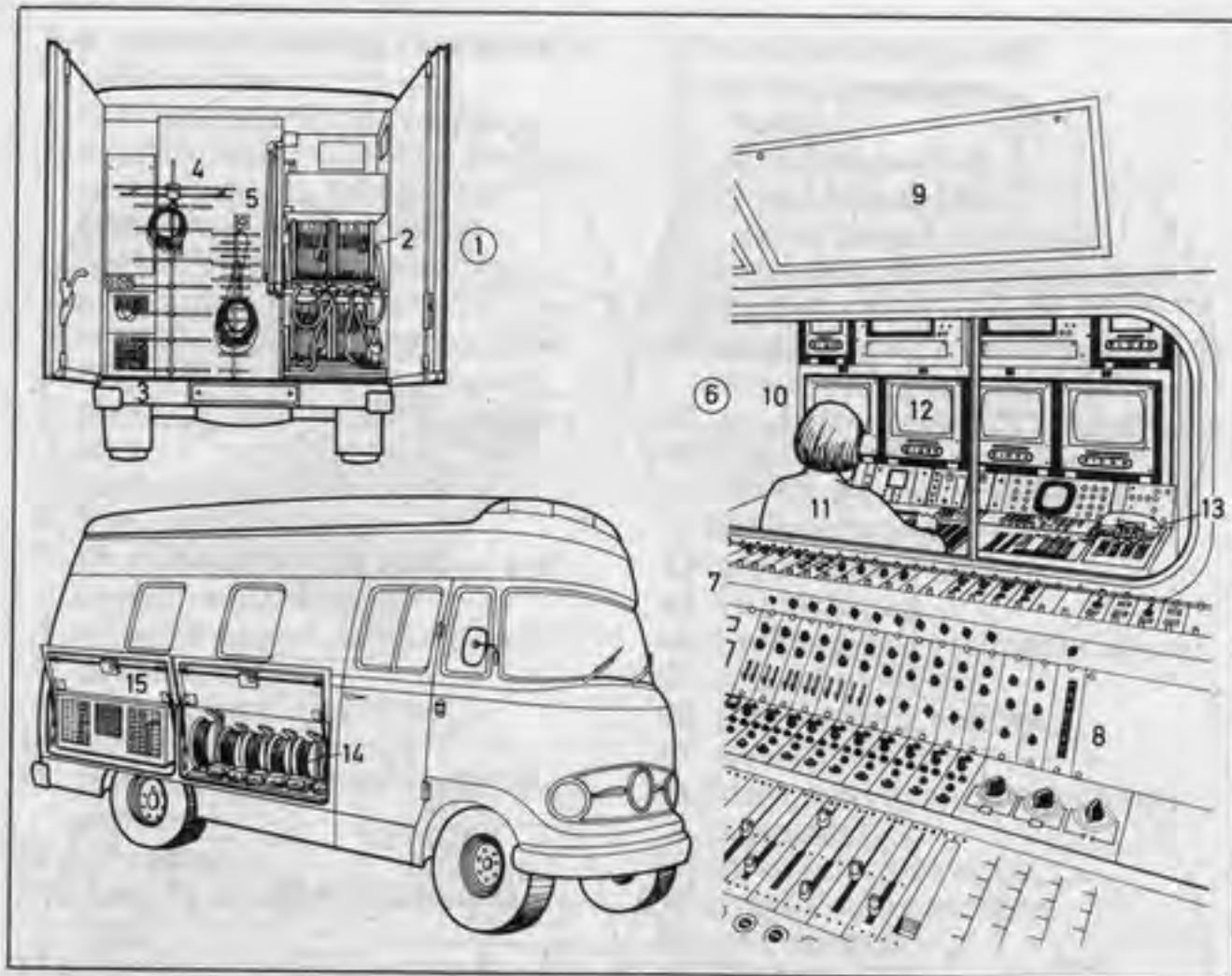

- 1-15 **outside broadcast (OB) vehicle** (television OB van; also: sound OB van, radio OB van)  
 1 **rear equipment section of the OB vehicle**  
 2 camera cable  
 3 cable connection panel  
 4 television (TV) reception aerial (receiving aerial) for Channel I  
 5 television (TV) reception aerial (receiving aerial) for Channel II  
 6 **interior equipment (on-board equipment) of the OB vehicle**  
 7 sound production control room (sound control room)  
 8 sound control desk (sound control console)  
 9 monitoring loudspeaker  
 10 vision control room (video control room)  
 11 video controller (vision controller)  
 12 camera monitor (picture monitor)

- 13 on-board telephone (intercommunication telephone)  
 14 microphone cable  
 15 air-conditioning equipment

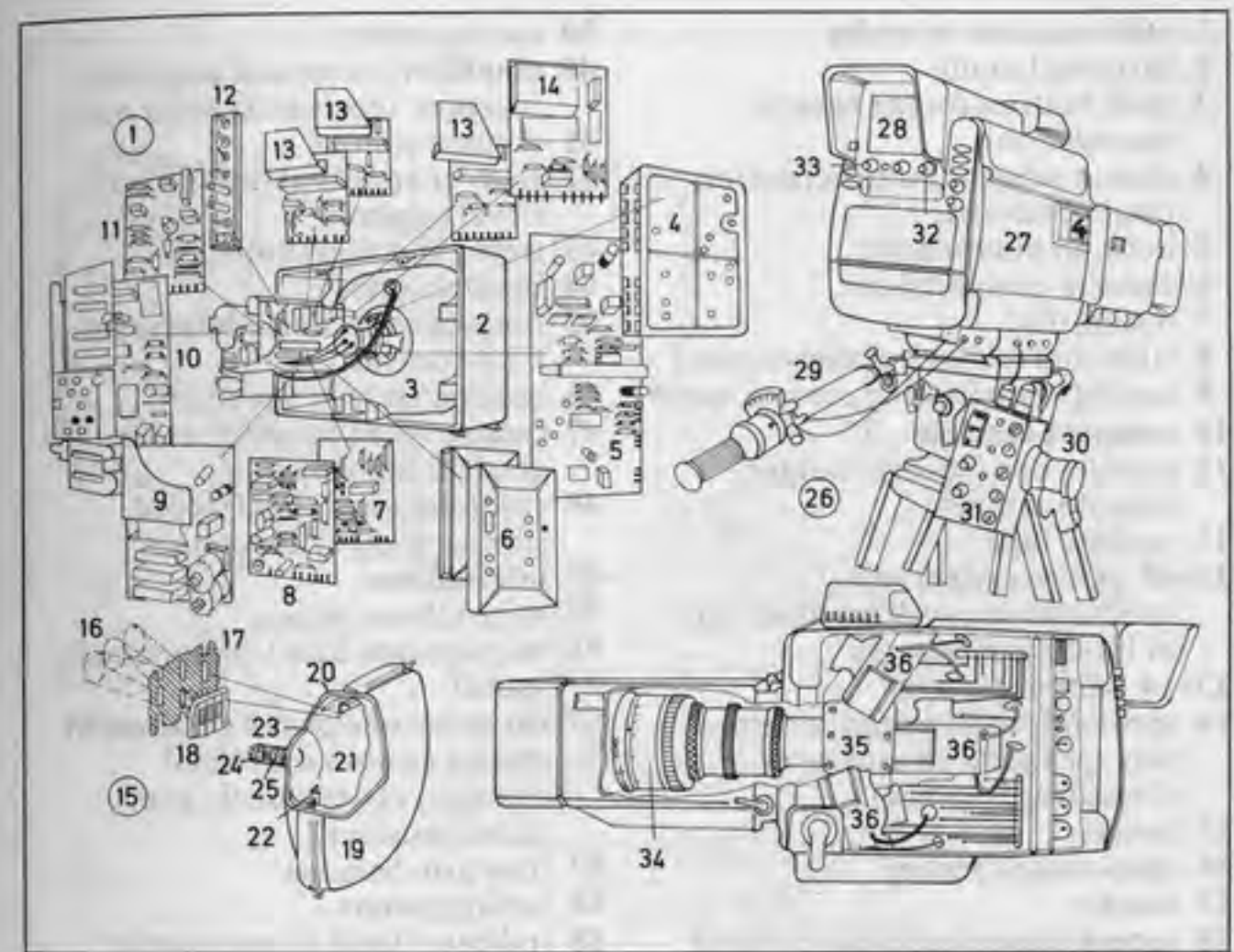

- 1 **colour (Am. color) television (TV) receiver** (colour television set) of modular design  
 2 television cabinet  
 3 television tube (picture tube)  
 4 IF (intermediate frequency) amplifier module  
 5 colour (Am. color) decoder module  
 6 VHF and UHF tuner  
 7 horizontal synchronizing module  
 8 vertical deflection module  
 9 horizontal linearity control module  
 10 horizontal deflection module  
 11 control module  
 12 convergence module  
 13 colour (Am. color) output stage module  
 14 sound module  
 15 colour (Am. color) picture tube  
 16 electron beams  
 17 shadow mask with elongated holes

- 18 strip of fluorescent (luminescent, phosphorescent) material  
 19 coating (film) of fluorescent material  
 20 inner magnetic screen (screening)  
 21 vacuum  
 22 temperature-compensated shadow mask mount  
 23 centring (centering) ring for the deflection system  
 24 electron gun assembly  
 25 rapid heat-up cathode  
 26 **television (TV) camera**  
 27 camera head  
 28 camera monitor  
 29 control arm (control lever)  
 30 focusing adjustment  
 31 control panel  
 32 contrast control  
 33 brightness control  
 34 zoom lens  
 35 beam-splitting prism (beam splitter)  
 36 pickup unit (colour, Am. color, pickup tube)



- 1 radio cassette recorder
- 2 carrying handle
- 3 push buttons for the cassette recorder unit
- 4 station selector buttons (station preset buttons)
- 5 built-in microphone
- 6 cassette compartment
- 7 tuning dial
- 8 slide control [for volume or tone]
- 9 tuning knob (tuning control, tuner)
- 10 compact cassette
- 11 cassette box (cassette holder, cassette cabinet)
- 12 cassette tape
- 13-48 stereo system (also: quadraphonic system) made up of Hi-Fi components
- 13-14 stereo speakers
- 14 speaker (loudspeaker), a three-way speaker with crossover (crossover network)
- 15 tweeter
- 16 mid-range speaker
- 17 woofer
- 18 record player (automatic record changer, auto changer)
- 19 record player housing (record player base)
- 20 turntable
- 21 tone arm
- 22 counterbalance (counterweight)
- 23 gimbal suspension
- 24 stylus pressure control (stylus force control)
- 25 anti-skate control
- 26 magnetic cartridge with (conical or elliptical) stylus, a diamond
- 27 tone arm lock
- 28 tone arm lift
- 29 speed selector (speed changer)
- 30 starter switch
- 31 treble control
- 32 dust cover
- 33 stereo cassette deck
- 34 cassette compartment
- 35-36 recording level meters (volume unit meters, VU meters)
- 35 left-channel recording level meter
- 36 right-channel recording level meter
- 37 tuner
- 38 VHF (FM) station selector buttons
- 39 tuning meter
- 40 amplifier; tuner and amplifier together: receiver (control unit)
- 41 volume control
- 42 four-channel balance control (level control)
- 43 treble and bass tuning
- 44 input selector
- 45 four-channel demodulator for CD4 records
- 46 quadra/stereo converter
- 47 cassette box (cassette holder, cassette cabinet)
- 48 record storage slots (record storage compartments)
- 49 microphone
- 50 microphone screen
- 51 microphone base (microphone stand)
- 52 three-in-one stereo component system (automatic record changer, cassette deck, and stereo receiver)
- 53 tone arm balance
- 54 tuning meters
- 55 indicator light for automatic FeO/CrO<sub>2</sub> tape switch-over
- 56 open-reel-type recorder, a two or four-track unit
- 57 tape reel (open tape reel)
- 58 open-reel tape (recording tape, 1/4" tape)
- 59 sound head housing with erasing head (erase head), recording head, and reproducing head (or: combined head)
- 60 tape deflector roller and end switch (limit switch)
- 61 recording level meter (VU meter)
- 62 tape speed selector
- 63 on/off switch
- 64 tape counter
- 65 stereo microphone sockets (stereo microphone jacks)
- 66 headphones (headset)
- 67 padded headband (padded headpiece)
- 68 membrane
- 69 earcups (earphones)
- 70 headphone cable plug, a standard multi-pin plug
- 71 headphone cable (headphone cord)

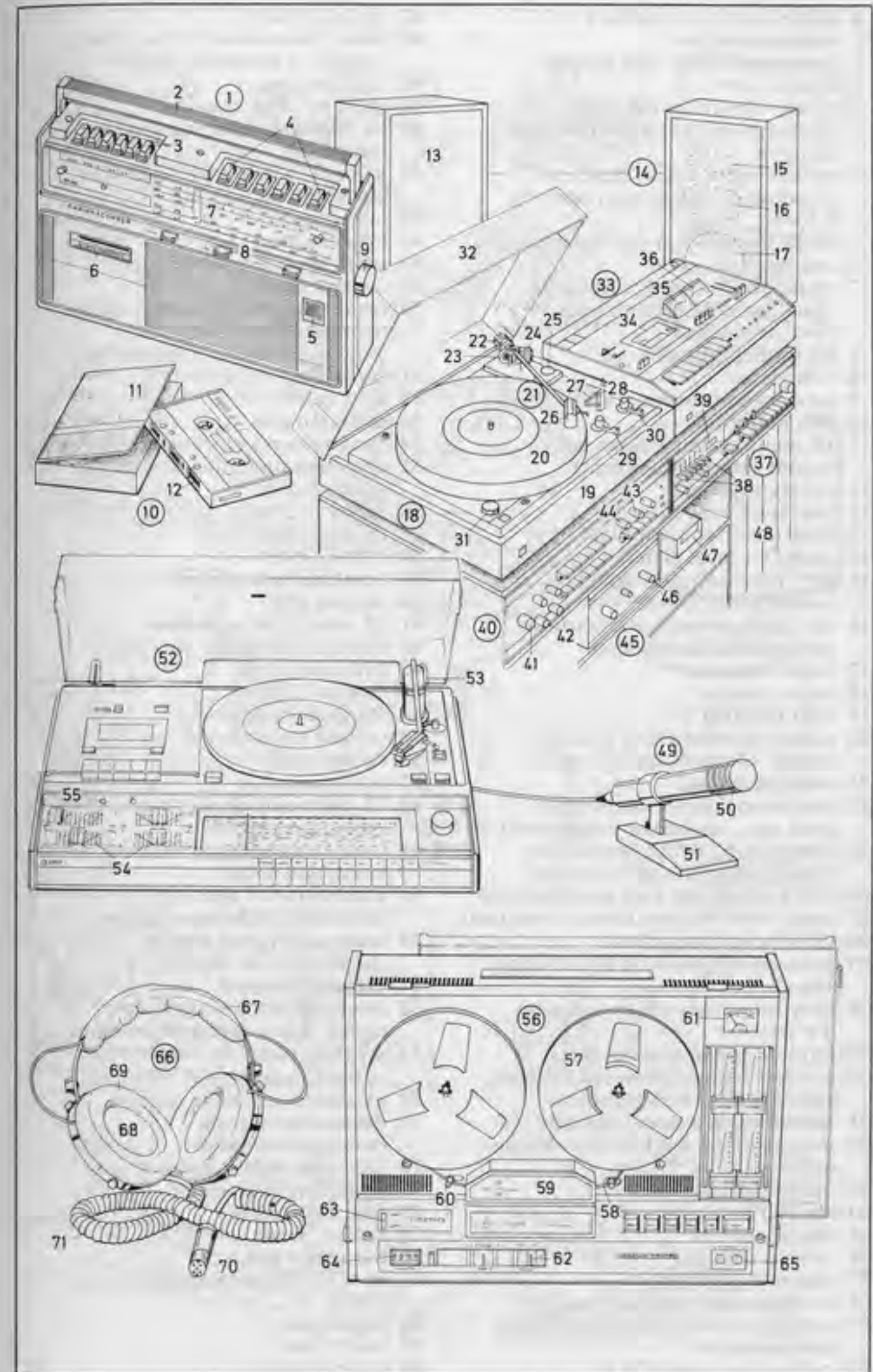



- 1 group instruction using a teaching machine
- 2 instructor's desk with central control unit
- 3 master control panel with individual displays and cross total counters
- 4 student input device (student response device) in the hand of a student
- 5 study step counter (progress counter)
- 6 overhead projector
- 7 apparatus for producing audio-visual learning programmes (Am. programs)
- 8-10 frame coding device
- 8 film viewer
- 9 memory unit (storage unit)
- 10 film perforator
- 11-14 audio coding equipment (sound coding equipment)
- 11 coding keyboard
- 12 two-track tape recorder
- 13 four-track tape recorder
- 14 recording level meter
- 15 PIP (programmed individual presentation) system
- 16 AV (audio-visual) projector for programmed instruction
- 17 audio cassette
- 18 video cassette
- 19 data terminal
- 20 telephone connection with the central data collection station
- 21 video telephone
- 22 conference circuit (conference hook-up, conference connection)
- 23 camera tube switch (switch for transmitting speaker's picture)
- 24 talk button (talk key, speaking key)
- 25 touch-tone buttons (touch-tone pad)
- 26 video telephone screen
- 27 infrared transmission of television sound
- 28 television receiver (television set, TV set)
- 29 infrared sound transmitter
- 30 cordless battery-powered infrared sound headphones (headset)
- 31 microfilming system [diagram]
- 32 magnetic tape station (data storage unit)
- 33 buffer storage
- 34 adapter unit
- 35 digital control
- 36 camera control
- 37 character storage
- 38 analogue (Am. analog) control
- 39 correction (adjustment) of picture tube geometry
- 40 cathode ray tube (CRT)
- 41 optical system
- 42 slide (transparency) of a form for mixing-in images of forms
- 43 flash lamp
- 44 universal film cassettes
- 45-84 demonstration and teaching equipment
- 45 demonstration model of a four-stroke engine
- 46 piston
- 47 cylinder head
- 48 spark plug (sparking plug)
- 49 contact breaker
- 50 crankshaft with balance weights (counterbalance weights) (counterbalanced crankshaft)
- 51 crankcase
- 52 inlet valve
- 53 exhaust valve
- 54 coolant bores (cooling water bores)
- 55 demonstration model of a two-stroke engine
- 56 deflector piston
- 57 transfer port
- 58 exhaust port
- 59 crankcase scavenging
- 60 cooling ribs
- 61-67 models of molecules
- 61 ethylene molecule
- 62 hydrogen atom
- 63 carbon atom
- 64 formaldehyde atom
- 65 oxygen molecule
- 66 benzene ring
- 67 water molecule
- 68-72 electronic circuits made up of modular elements
- 68 logic element (logic module), an integrated circuit
- 69 plugboard for electronic elements (electronic modules)
- 70 linking (link-up, joining, connection) of modules
- 71 magnetic contact
- 72 assembly (construction) of a circuit, using magnetic modules
- 73 multiple meter for measuring current, voltage and resistance
- 74 measurement range selector
- 75 measurement scale (measurement dial)
- 76 indicator needle (pointer)
- 77 current/voltage meter
- 78 adjusting screw
- 79 optical bench
- 80 triangular rail
- 81 laser (teaching laser, instruction laser)
- 82 diaphragm
- 83 lens system
- 84 target (screen)

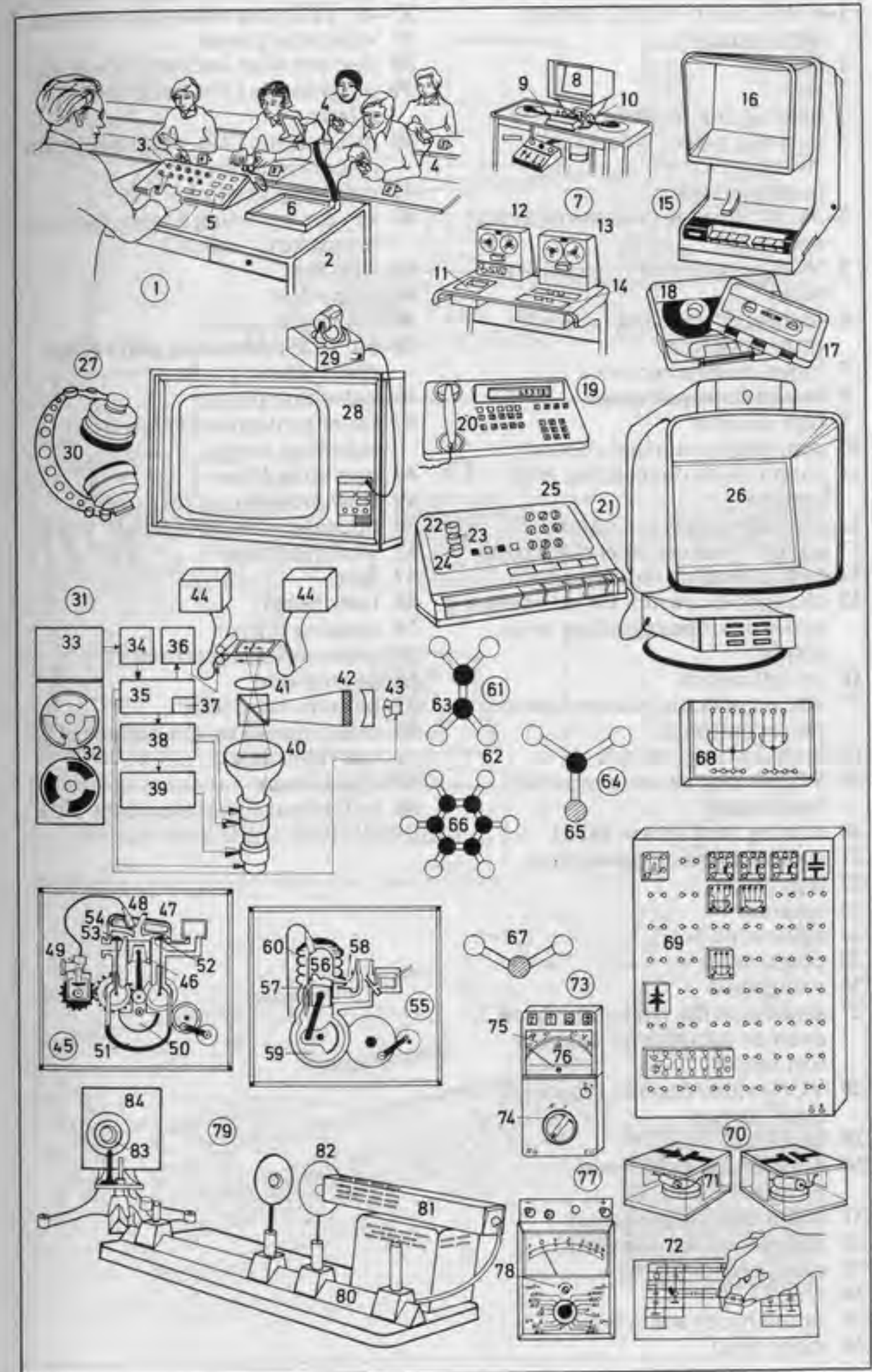



- 1-4 AV (audio-visual) camera with recorder  
 1 camera  
 2 lens  
 3 built-in microphone  
 4 portable video (videotape) recorder (for  $\frac{1}{4}$ " open-reel magnetic tape)
- 5-36 VCR (video cassette recorder) system  
 5 VCR cassette (for  $\frac{1}{2}$ " magnetic tape)  
 6 domestic television receiver (also: monitor)  
 7 video cassette recorder  
 8 cassette compartment  
 9 tape counter  
 10 centring (centering) control  
 11 sound (audio) recording level control  
 12 recording level indicator  
 13 control buttons (operating keys)  
 14 tape threading indicator light  
 15 changeover switch for selecting audio or video recording level display  
 16 on/off switch  
 17 station selector buttons (station preset buttons)  
 18 built-in timer switch  
 19 VCR (video cassette recorder) head drum  
 20 erasing head (erase head)  
 21 stationary guide (guide pin)  
 22 tape guide  
 23 capstan  
 24 audio sync head  
 25 pinch roller  
 26 video head  
 27 grooves in the wall of the head drum to promote air cushion formation  
 28 VCR (video cassette recorder) track format  
 29 tape feed  
 30 direction of video head movement  
 31 video track, a slant track  
 32 sound track (audio track)  
 33 sync track  
 34 sync head  
 35 sound head (audio head)  
 36 video head
- 37-45 TED (television disc) system  
 37 video disc player  
 38 disc slot with inserted video disc  
 39 programme (Am. program) selector  
 40 programme (Am. program) scale (programme dial)  
 41 operating key ('play')  
 42 key for repeating a scene (scene-repeat key, 'select')  
 43 stop key  
 44 video disc  
 45 video disc jacket
- 46-60 VLP (video long play) video disc system  
 46 video disc player  
 47 cover projection (below it: scanning zone)  
 48 operating keys  
 49 slow motion control  
 50 optical system [diagram]  
 51 VLP video disc  
 52 lens  
 53 laser beam  
 54 rotating mirror  
 55 semi-reflecting mirror  
 56 photodiode  
 57 helium-neon laser  
 58 video signals on the surface of the video disc  
 59 signal track  
 60 individual signal element ('pit')

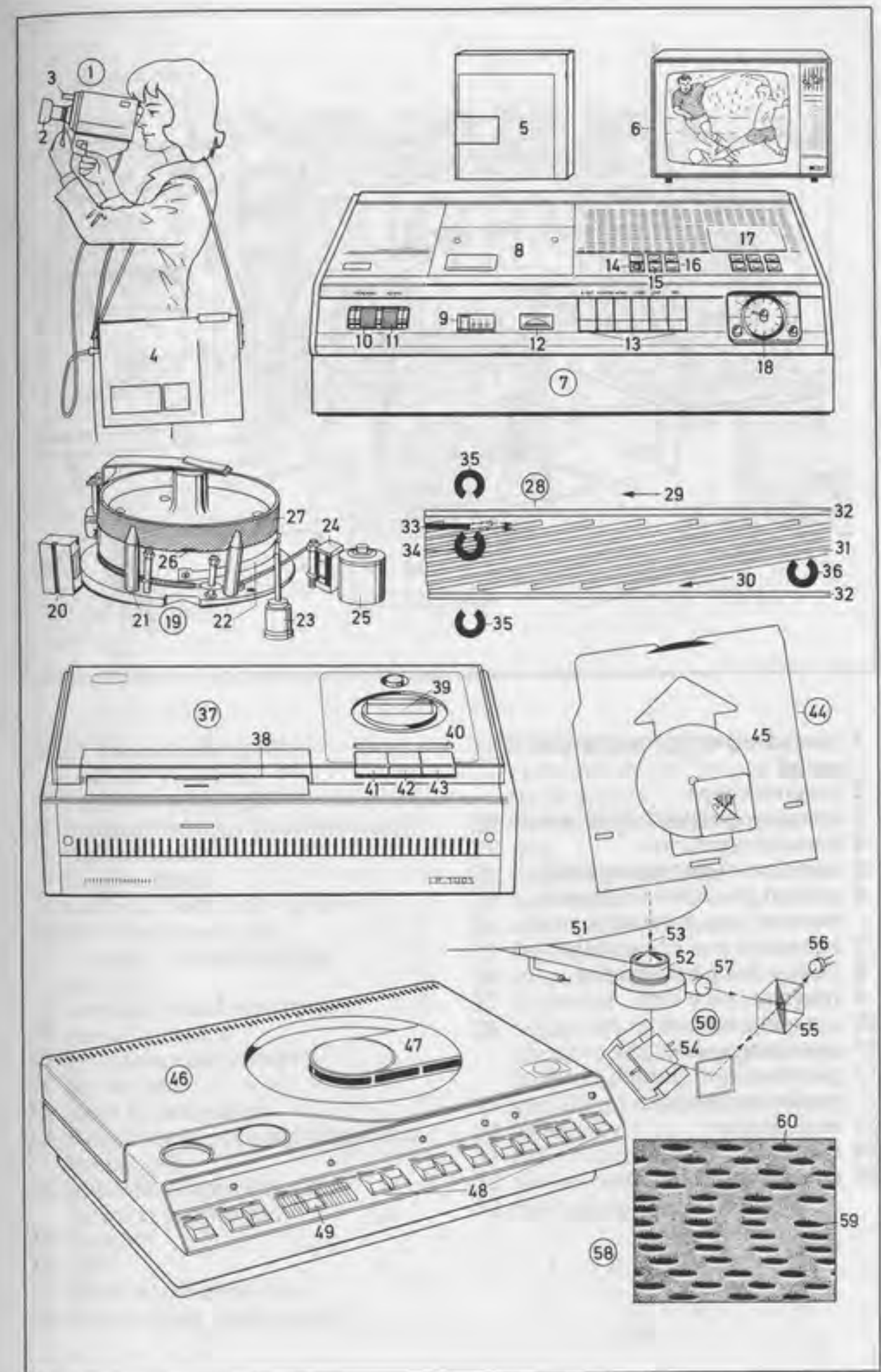



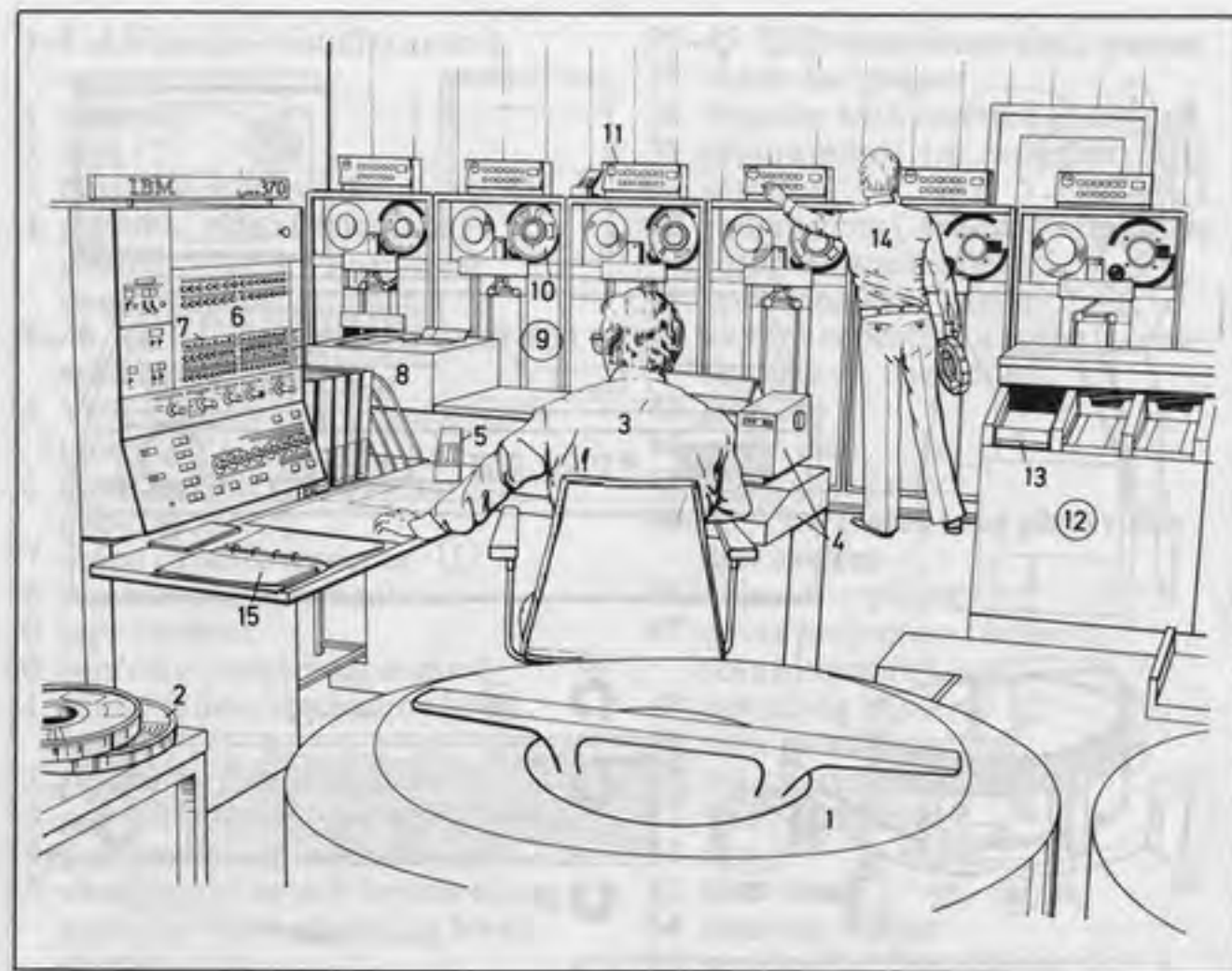

- 1 disc (disk) store (magnetic disc store)
- 2 magnetic tape
- 3 console operator (chief operator)
- 4 console typewriter
- 5 intercom (intercom system)
- 6 central processor with main memory and arithmetic unit
- 7 operation and error indicators
- 8 floppy disc (disk) reader
- 9 magnetic tape unit
- 10 magnetic tape reel
- 11 operating indicators
- 12 punched card (punch card) reader and punch
- 13 card stacker
- 14 operator
- 15 operating instructions

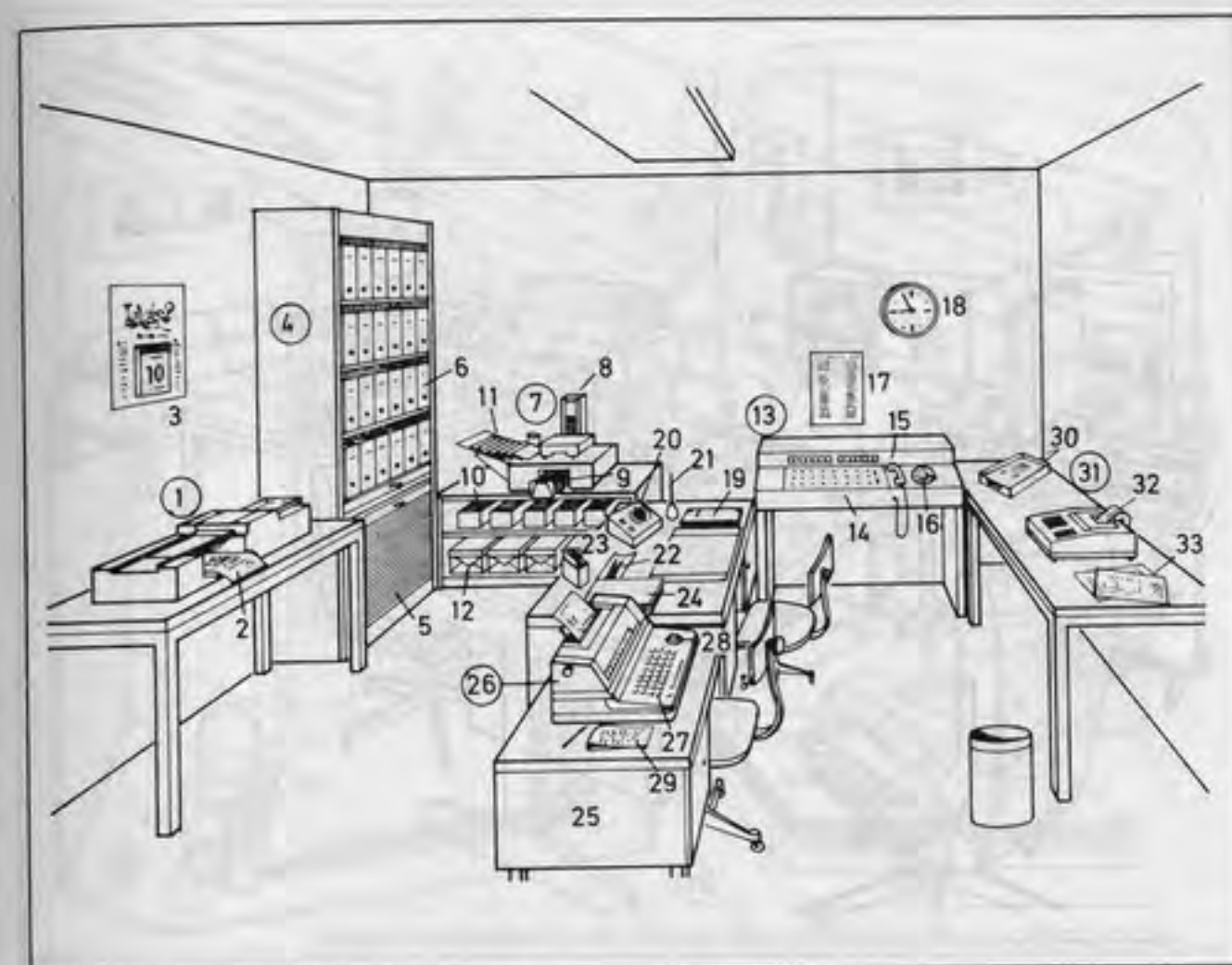

- 1-33 receptionist's office (secretary's office)
- 1 facsimile telegraph
- 2 transmitted copy (received copy)
- 3 wall calendar
- 4 filing cabinet
- 5 tambour door (roll-up door)
- 6 file (document file)
- 7 transfer-type addressing machine
- 8 vertical stencil magazine
- 9 stencil ejection
- 10 stencil storage drawer
- 11 paper feed
- 12 stock of notepaper
- 13 switchboard (internal telephone exchange)
- 14 push-button keyboard for internal connections
- 15 handset
- 16 dial
- 17 internal telephone list
- 18 master clock (main clock)
- 19 folder containing documents, correspondence, etc. for signing (to be signed)
- 20 intercom (office intercom)
- 21 pen
- 22 pen and pencil tray
- 23 card index
- 24 stack (set) of forms
- 25 typing desk
- 26 memory typewriter
- 27 keyboard
- 28 rotary switch for the main memory and the magnetic tape loop
- 29 shorthand pad (*Am. steno pad*)
- 30 letter tray
- 31 office calculator
- 32 printer
- 33 business letter

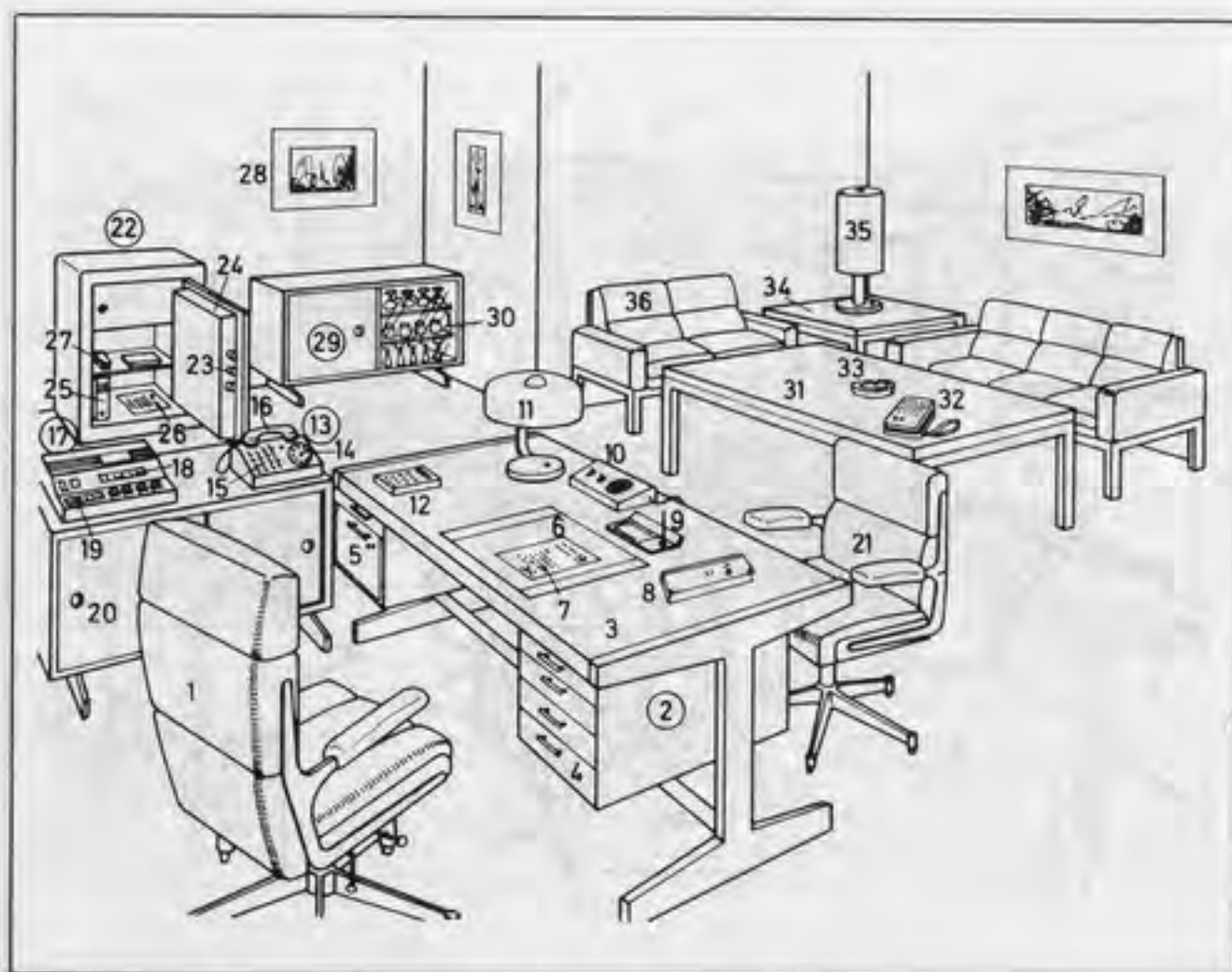

**1-36 executive's office**

- 1 swivel chair
- 2 desk
- 3 writing surface (desk top)
- 4 desk drawer
- 5 cupboard (storage area) with door
- 6 desk mat (blotter)
- 7 business letter
- 8 appointments diary
- 9 desk set
- 10 intercom (office intercom)
- 11 desk lamp
- 12 pocket calculator (electronic calculator)
- 13 telephone, an executive-secretary system
- 14 dial; *also*: push-button keyboard
- 15 call buttons
- 16 receiver (telephone receiver)
- 17 dictating machine
- 18 position indicator
- 19 control buttons (operating keys)
- 20 cabinet

- 21 visitor's chair
- 22 safe
- 23 bolts (locking mechanism)
- 24 armour (*Am.* armor) plating
- 25 confidential documents
- 26 patent
- 27 petty cash
- 28 picture
- 29 bar (drinks cabinet)
- 30 bar set
- 31-36 conference grouping
- 31 conference table
- 32 pocket-sized dictating machine (micro cassette recorder)
- 33 ashtray
- 34 corner table
- 35 table lamp
- 36 two-seater sofa [part of the conference grouping]

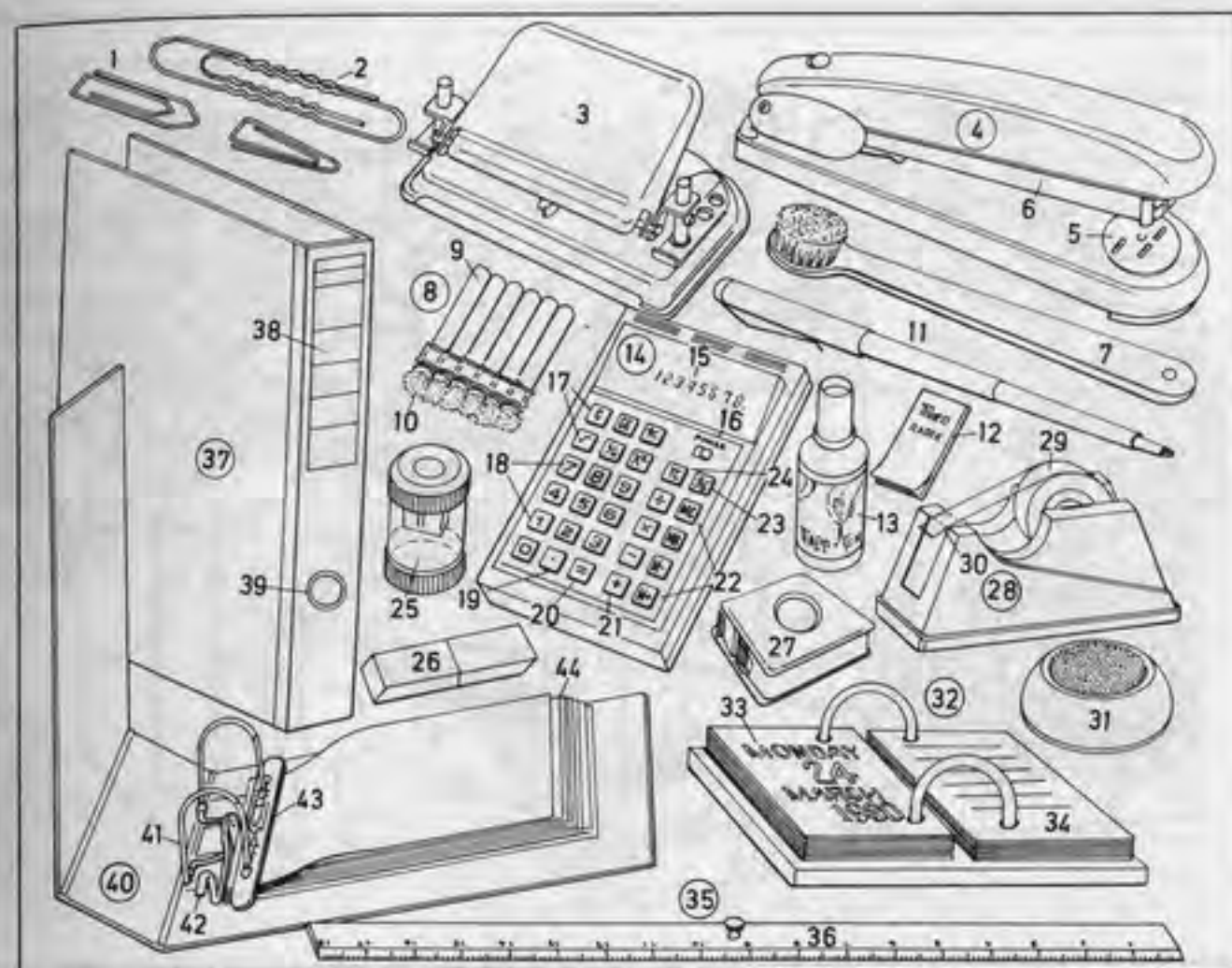
**1-44 office equipment** (office supplies, office materials)

- 1, 2 paper clips
- 3 punch
- 4 stapler (stapling machine)
- 5 anvil
- 6 spring-loaded magazine
- 7 type-cleaning brush for typewriters
- 8 type cleaner (type-cleaning kit)
- 9 fluid container (fluid reservoir)
- 10 cleaning brush
- 11 felt tip pen
- 12 correcting paper [for typing errors]
- 13 correcting fluid [for typing errors]
- 14 electronic pocket calculator
- 15 eight-digit fluorescent display
- 16 on/off switch
- 17 function keys
- 18 number keys
- 19 decimal key
- 20 'equals' key
- 21 instruction keys (command keys)
- 22 memory keys
- 23 percent key (percentage key)
- 24  $\pi$ -key (pi-key) for mensuration of circles
- 25 pencil sharpener
- 26 typewriter rubber
- 27 adhesive tape dispenser
- 28 adhesive tape holder (roller-type adhesive tape dispenser)
- 29 roll of adhesive tape
- 30 tear-off edge
- 31 moistener
- 32 desk diary
- 33 date sheet (calendar sheet)
- 34 memo sheet
- 35 ruler
- 36 centimetre and millimetre (*Am.* centimeter and millimeter) graduations
- 37 file (document file)
- 38 spine label (spine tag)
- 39 finger hole
- 40 arch board file
- 41 arch unit
- 42 release lever (locking lever, release/lock lever)
- 43 compressor
- 44 bank statement (statement of account)



**1-48 open plan office**

- |   |  |
|---|--|
| 1 partition wall (partition screen)                   | 21 typist  |
| 2 filing drawer with suspension file system           | 22 typewriter  |
| 3 suspension file                                     | 23 filing drawer   |
| 4 file tab  | 24 customer card index                                   |
| 5 file (document file)                                | 25 office chair, a swivel chair                          |
| 6 filing clerk  | 26 typing desk   |
| 7 clerical assistant                                  | 27 card index box  |
| 8 note for the files                                  | 28 multi-purpose shelving                                |
| 9 telephone   | 29 proprietor  |
| 10 filing shelves                                     | 30 business letter                                       |
| 11 clerical assistant's desk                          | 31 proprietor's secretary                                |
| 12 office cupboard                                    | 32 shorthand pad ( <i>Am.</i> steno pad)                 |
| 13 plant stand (planter)                              | 33 audio typist  |
| 14 indoor plants (houseplants)                        | 34 dictating machine                                     |
| 15 programmer   | 35 earphone  |
| 16 data display terminal (visual display unit)        | 36 statistics chart                                      |
| 17 customer service representative                    | 37 pedestal containing a cupboard or drawers             |
| 18 customer   | 38 sliding-door cupboard                                 |
| 19 computer-generated design (computer-generated art) | 39 office furniture arranged in an angular configuration |
| 20 sound-absorbing partition                          | 40 wall-mounted shelf                                    |
|   | 41 letter tray   |



- |  |
|--|
| 42 wall calendar   |
| 43 data centre ( <i>Am.</i> center)  |
| 44 calling up information on the data display terminal (visual display unit) |
| 45 waste paper basket  |
| 46 sales statistics  |
| 47 EDP print-out, a continuous fan-fold sheet                                |
| 48 connecting element  |



- 1 electric typewriter, a golf ball typewriter
- 2-6 keyboard
- 2 space bar
- 3 shift key
- 4 line space and carrier return key
- 5 shift lock
- 6 margin release key
- 7 tabulator key
- 8 tabulator clear key
- 9 on/off switch
- 10 striking force control (impression control)
- 11 ribbon selector
- 12 margin scale
- 13 left margin stop
- 14 right margin stop
- 15 golf ball (spherical typing element) bearing the types
- 16 ribbon cassette
- 17 paper bail with rollers
- 18 platen
- 19 typing opening (typing window)
- 20 paper release lever
- 21 carrier return lever
- 22 platen knob
- 23 line space adjuster
- 24 variable platen action lever
- 25 push-in platen variable
- 26 erasing table
- 27 transparent cover
- 28 exchange golf ball (exchange typing element)
- 29 type
- 30 golf ball cap (cap of typing element)
- 31 teeth
- 32 web-fed automatic copier
- 33 magazine for paper roll
- 34 paper size selection (format selection)
- 35 print quantity selection
- 36 contrast control
- 37 main switch (on/off switch)
- 38 start print button
- 39 document glass
- 40 transfer blanket
- 41 toner roll
- 42 exposure system
- 43 print delivery (copy delivery)
- 44 letter-folding machine
- 45 paper feed
- 46 folding mechanism
- 47 receiving tray
- 48 small offset press
- 49 paper feed
- 50 lever for inking the plate cylinder
- 51-52 inking unit (inker unit)
- 51 distributing roller (distributor)
- 52 ink roller (inking roller, fountain roller)
- 53 pressure adjustment
- 54 sheet delivery (receiving table)
- 55 printing speed adjustment
- 56 jogger for aligning the piles of sheets
- 57 pile of paper (pile of sheets)
- 58 folding machine
- 59 gathering machine (collating machine, assembling machine) for short runs
- 60 gathering station (collating station, assembling station)
- 61 adhesive binder (perfect binder) for hot adhesives
- 62 magnetic tape dictating machine
- 63 headphones (headset, earphones)
- 64 on/off switch
- 65 microphone cradle
- 66 foot control socket
- 67 telephone adapter socket
- 68 headphone socket (earphone socket, headset socket)
- 69 microphone socket
- 70 built-in loudspeaker
- 71 indicator lamp (indicator light)
- 72 cassette compartment
- 73 forward wind, rewind, and stop buttons
- 74 time scale with indexing marks
- 75 time scale stop

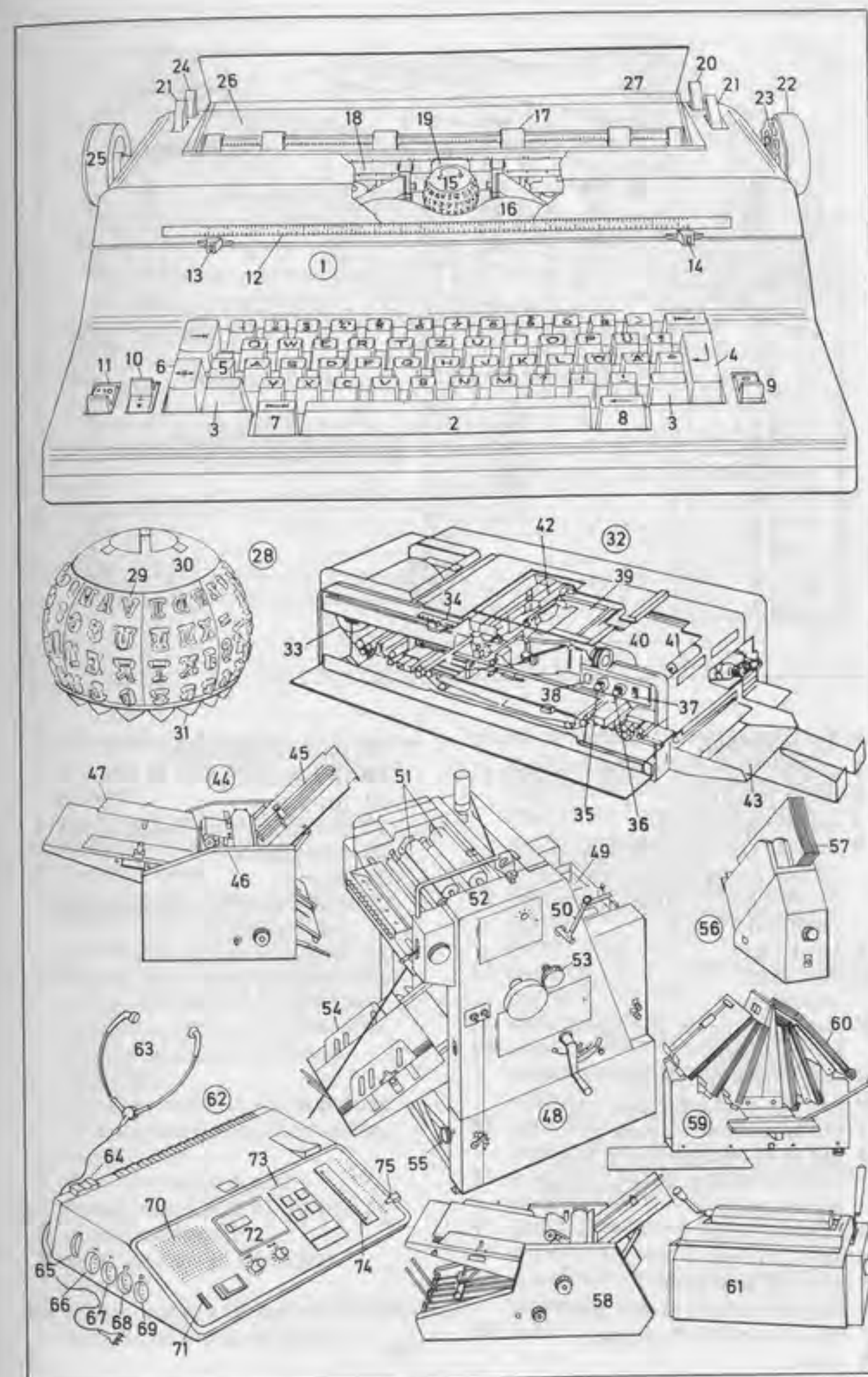





- 1-11 main hall
- 1 cashier's desk (cashier's counter)
- 2 teller (cashier)
- 3 bullet-proof glass
- 4 service counters (service and advice for savings accounts, private and company accounts, personal loans)
- 5 bank clerk
- 6 customer
- 7 brochures
- 8 stock list (price list, list of quotations)
- 9 information counter
- 10 foreign exchange counter
- 11 entrance to strong room
- 12 bill of exchange (bill); here: a draft, an acceptance (a bank acceptance)
- 13 place of issue
- 14 date of issue
- 15 place of payment
- 16 date of maturity (due date)
- 17 bill clause (draft clause)
- 18 value
- 19 payee (remittee)
- 20 drawee (payer)
- 21 drawer
- 22 domiciliation (paying agent)
- 23 acceptance
- 24 stamp
- 25 endorsement (indorsement, transfer entry)
- 26 endorsee (indorsee)
- 27 endorser (indorser)

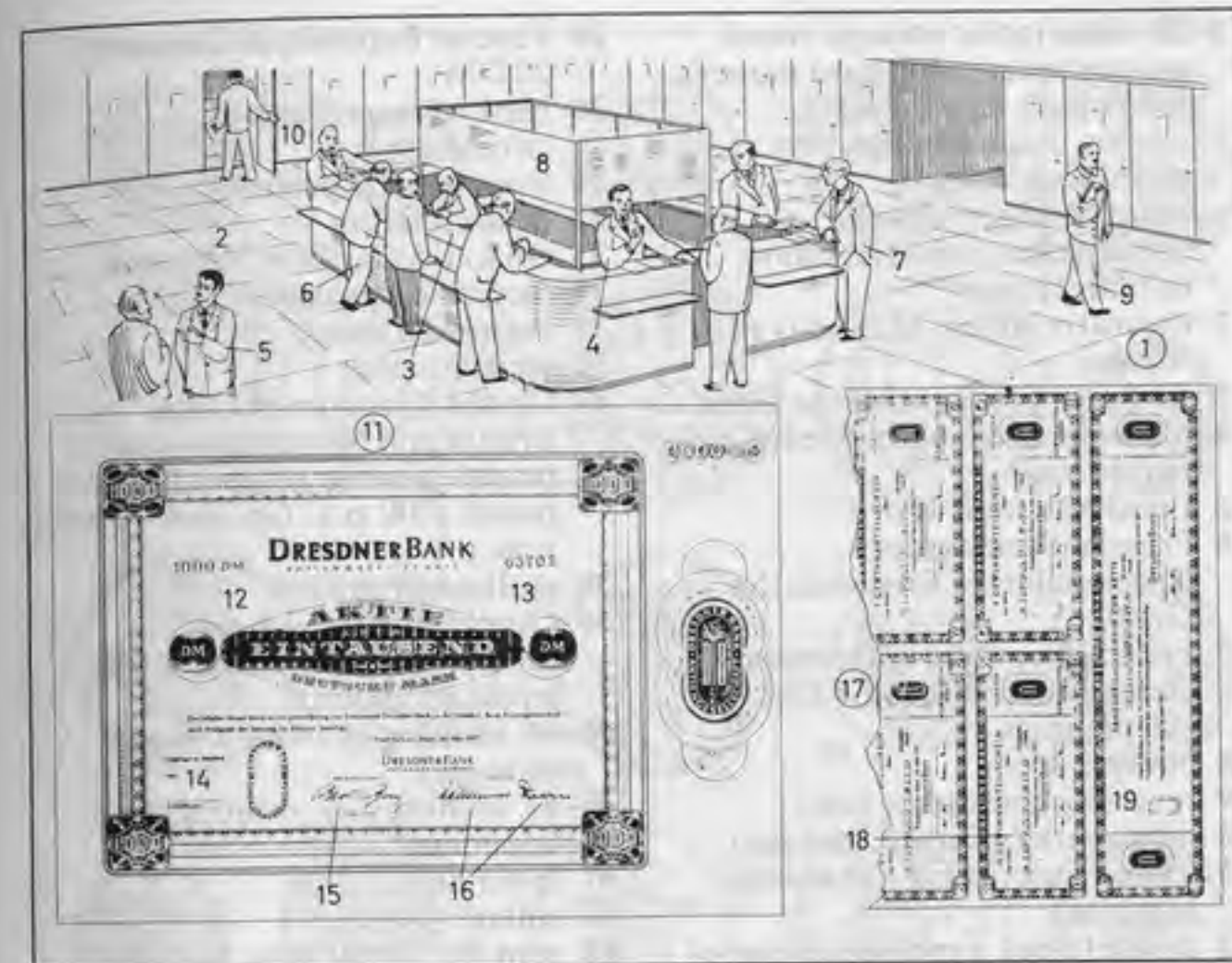

- 1-10 stock exchange (exchange for the sale of securities, stocks, and bonds)
- 1 exchange hall (exchange floor)
- 2 market for securities
- 3 broker's post
- 4 sworn stockbroker (exchange broker, stockbroker, Am. specialist), an inside broker
- 5 kerbstone broker (kerbstoner, curbstoner, curbstoner, outside broker), a commercial broker dealing in unlisted securities
- 6 member of the stock exchange (stockjobber, Am. floor trader, room trader)
- 7 stock exchange agent (boardman), a bank employee
- 8 quotation board
- 9 stock exchange attendant (waiter)
- 10 telephone box (telephone booth, telephone kiosk, call box)
- 11-19 securities; kinds: share (Am. stock), fixed-income security, annuity, bond, debenture bond, municipal bond (corporation stock), industrial bond, convertible bond
- 11 share certificate (Am. stock certificate); here: bearer share (share warrant)
- 12 par (par value, nominal par, face par) of the share
- 13 serial number
- 14 page number of entry in bank's share register (bank's stock ledger)
- 15 signature of the chairman of the board of governors
- 16 signature of the chairman of the board of directors
- 17 sheet of coupons (coupon sheet, dividend coupon sheet)
- 18 dividend warrant (dividend coupon)
- 19 talon



- 1-28 coins (coin, coinage, metal money, specie, *Am.* hard money; kinds: gold, silver, nickel, copper, or aluminium, *Am.* aluminum, coins)
- 1 Athens: nugget-shaped tetradrachm (tetradrachmon, tetradrachma)
- 2 the owl (emblem of the city of Athens)
- 3 aureus of Constantine the Great
- 4 bracteate of Emperor Frederick I Barbarossa
- 5 Louis XIV louis-d'or
- 6 Prussia: 1 reichstaler (speciestaler) of Frederick the Great
- 7 Federal Republic of Germany: 5 Deutschmarks (DM); 1 DM = 100 pfennigs
- 8 obverse
- 9 reverse (subordinate side)
- 10 mint mark (mintage, exergue)
- 11 legend (inscription on the edge of a coin)
- 12 device (type), a provincial coat of arms
- 13 Austria: 25 schillings; 1 sch = 100 groschen
- 14 provincial coats of arms
- 15 Switzerland: 5 francs; 1 franc = 100 centimes
- 16 France: 1 franc = 100 centimes
- 17 Belgium: 100 francs
- 18 Luxembourg (Luxemburg): 1 franc
- 19 Netherlands: 2½ guilders; 1 guilder (florin, gulden) = 100 cents
- 20 Italy: 10 lire (sg. lira)
- 21 Vatican City: 10 lire (sg. lira)
- 22 Spain: 1 peseta = 100 céntimos
- 23 Portugal: 1 escudo = 100 centavos
- 24 Denmark: 1 krone = 100 öre
- 25 Sweden: 1 krona = 100 öre
- 26 Norway: 1 krone = 100 öre
- 27 Czechoslovakia: 1 koruna = 100 heller
- 28 Yugoslavia: 1 dinar = 100 paras
- 29-39 banknotes (*Am.* bills) (paper money, notes, treasury notes)

- 29 Federal Republic of Germany: 20 DM
- 30 bank of issue (bank of circulation)
- 31 watermark [a portrait]
- 32 denomination
- 33 USA: 1 dollar(\$1) = 100 cents
- 34 facsimile signatures
- 35 impressed stamp
- 36 serial number
- 37 United Kingdom of Great Britain and Northern Ireland: 1 pound sterling (£1) = 100 new pence (100 p.); (sg. new penny, new p.)
- 38 guilloched pattern
- 39 Greece: 1,000 drachmas (drachmae); 1 drachma = 100 lepta (sg. lepton)
- 40-44 striking of coins (coinage, mintage)
- 40-41 coining dies (minting dies)
- 40 upper die
- 41 lower die
- 42 collar
- 43 coin disc (disk) (flan, planchet, blank)
- 44 coining press (minting press)





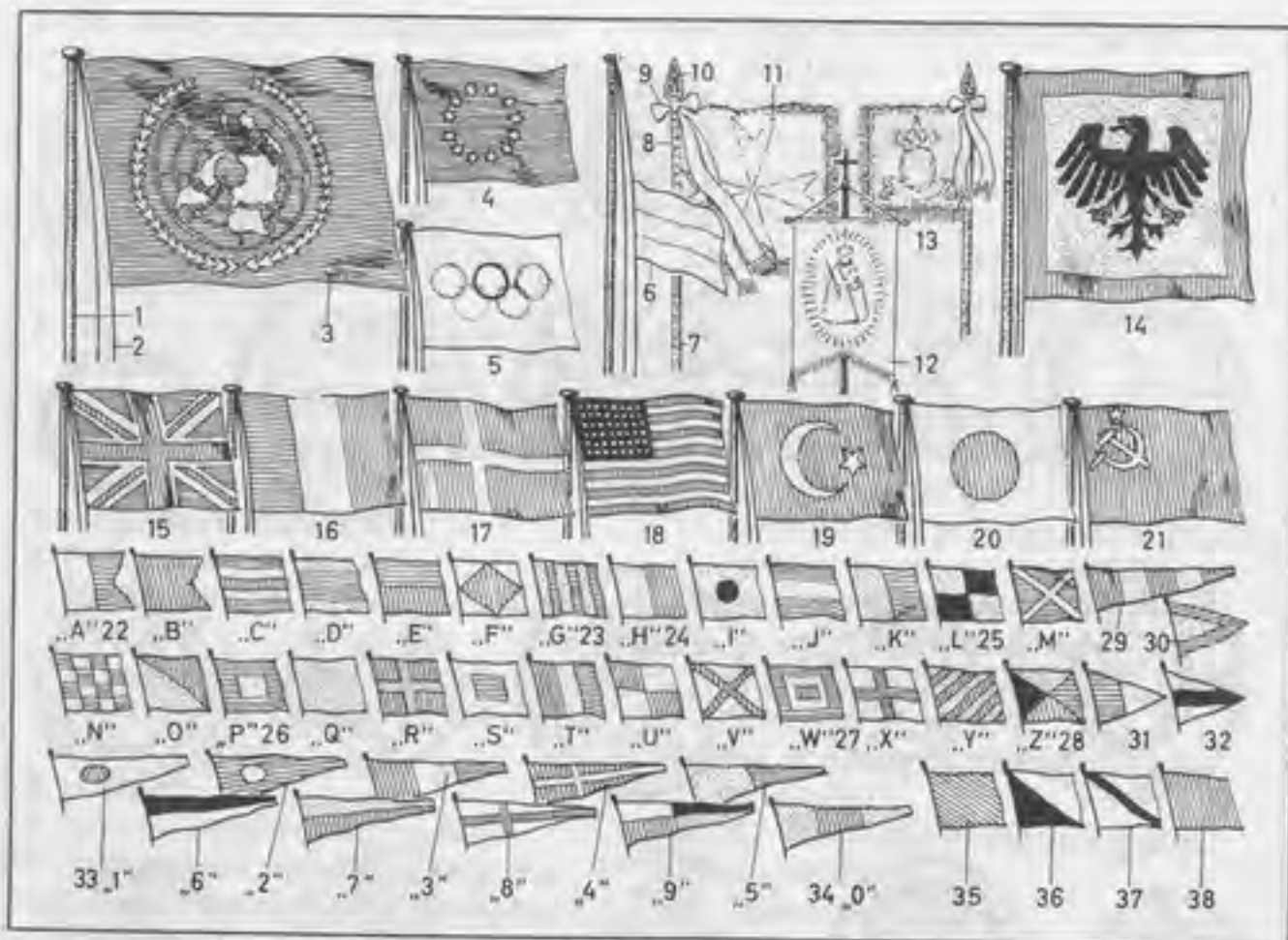

- 1-3 flag of the United Nations  
 1 flagpole (flagstaff) with truck  
 2 halyard (halliard, haulyard)  
 3 bunting  
 4 flag of the Council of Europe  
 5 Olympic flag  
 6 flag at half-mast (*Am.* at half-staff) [as a token of mourning]  
 7-11 flag  
 7 flagpole (flagstaff)  
 8 ornamental stud  
 9 streamer  
 10 pointed tip of the flagpole  
 11 bunting  
 12 banner (gonfalon)  
 13 cavalry standard (flag of the cavalry)  
 14 standard of the German Federal President [ensign of head of state]  
 15-21 national flags  
 15 the Union Jack (Great Britain)  
 16 the Tricolour (*Am.* Tricolor) (France)  
 17 the Dannebrog (Dannebrog) (Denmark)  
 18 the Stars and Stripes (Star-Spangled Banner) (USA)  
 19 the Crescent (Turkey)  
 20 the Rising Sun (Japan)  
 21 the Hammer and Sickle (USSR)  
 22-34 signal flags, a hoist  
 22-28 letter flags  
 22 letter A, a burgee (swallow-tailed flag)  
 23 G, pilot flag  
 24 H ('pilot on board')  
 25 L ('you should stop, I have something important to communicate')  
 26 P, the Blue Peter ('about to set sail')  
 27 W ('I require medical assistance')  
 28 Z, an oblong pennant (oblong pendant)  
 29 code pennant (code pendant), used in the International Signals Code  
 30-32 substitute flags (repeaters), triangular flags (pennants, pendants)  
 33-34 numeral pennants (numeral pendants)  
 33 number 1  
 34 number 0  
 35-38 customs flags  
 35 customs boat pennant (customs boat pendant)  
 36 'ship cleared through customs'  
 37 customs signal flag  
 38 powder flag ['inflammable (flammable) cargo']

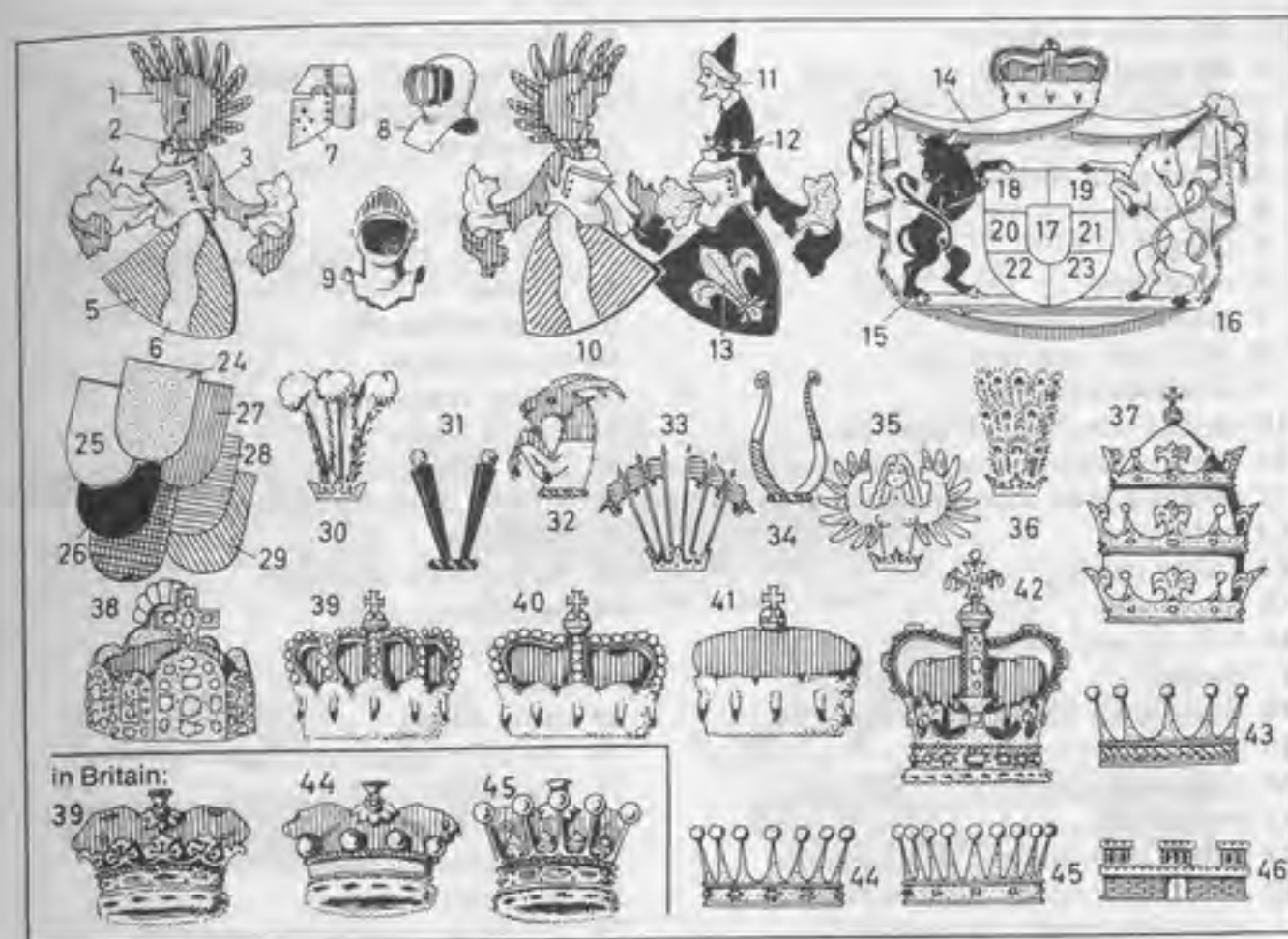

- 1-36 heraldry (blazonry)  
 1, 11, 30-36 crests  
 1-6 coat-of-arms (achievement of arms, hatchment, achievement)  
 1 crest  
 2 wreath of the colours (*Am.* colors)  
 3 mantle (mantling)  
 4, 7-9 helmets (helms)  
 4 tilting helmet (jousting helmet)  
 5 shield  
 6 bend sinister wavy  
 7 pot-helmet (pot-helm, heaume)  
 8 barred helmet (grilled helmet)  
 9 helmet affronty with visor open  
 10-13 marital achievement (marshalled, *Am.* marshaled, coat-of-arms)  
 10 arms of the baron (of the husband)  
 11-13 arms of the family of the femme (of the wife)  
 11 demi-man; *also*: demi-woman  
 12 crest coronet  
 13 fleur-de-lis  
 14 mantling  
 15-16 supporters (heraldic beasts)  
 15 bull  
 16 unicorn  
 17-23 blazon  
 17 inescutcheon (heart-shield)  
 18-23 quarterings one to six  
 18, 20, 22 dexter, right  
 18-19 chief  
 19, 21, 23 sinister, left  
 22-23 base  
 24-29 tinctures  
 24-25 metals  
 24 or (gold) [yellow]  
 25 argent (silver) [white]  
 26 sable  
 27 gules  
 28 azure  
 29 vert  
 30 ostrich feathers (treble plume)  
 31 truncheon  
 32 demi-goat  
 33 tournament pennons  
 34 buffalo horns  
 35 harpy  
 36 plume of peacock's feathers  
 37-46 crowns and coronets  
 37 tiara (papal tiara)  
 38 Imperial Crown [German, until 1806]  
 39 ducal coronet (duke's coronet)  
 40 prince's coronet  
 41 elector's coronet  
 42 English Royal Crown  
 43-45 coronets of rank  
 43 baronet's coronet  
 44 baron's coronet (baronial coronet)  
 45 count's coronet  
 46 mauerkrone (mural crown) of a city crest



- 1-98 army weaponry  
 1-39 hand weapons  
 1 PI pistol  
 2 barrel  
 3 front sight (foresight)  
 4 hammer  
 5 trigger  
 6 pistol grip  
 7 magazine holder  
 8 MP2 sub-machine gun  
 9 shoulder rest (butt)  
 10 casing (mechanism casing)  
 11 barrel clamp (barrel-clamping nut)  
 12 cocking lever (cocking handle)  
 13 palm rest  
 14 safety catch  
 15 magazine  
 16 G3-A3 self-loading rifle  
 17 barrel  
 18 flash hider (flash eliminator)  
 19 palm rest  
 20 trigger mechanism  
 21 magazine  
 22 notch (sighting notch, rearsight)  
 23 front sight block (foresight block) with front sight (foresight)  
 24 rifle butt (butt)  
 25 44 mm anti-tank rocket launcher  
 26 rocket (projectile)  
 27 buffer  
 28 telescopic sight (telescope sight)  
 29 firing mechanism  
 30 cheek rest  
 31 shoulder rest (butt)  
 32 MG3 machine gun (Spandau)  
 33 barrel casing  
 34 gas regulator  
 35 belt-changing flap  
 36 rearsight  
 37 front sight block (foresight block) with front sight (foresight)  
 38 pistol grip  
 39 shoulder rest (butt)  
 40-95 heavy weapons  
 40 120 mm AM 50 mortar  
 41 barrel  
 42 bipod  
 43 gun carriage  
 44 buffer (buffer ring)  
 45 sight (sighting mechanism)  
 46 base plate  
 47 striker pad  
 48 traversing handle  
 49-74 artillery weapons mounted on self-propelled gun carriages  
 49 175 mm SFM 107 cannon  
 50 drive wheel  
 51 elevating piston  
 52 buffer (buffer recuperator)  
 53 hydraulic system  
 54 breech ring  
 55 spade  
 56 spade piston  
 57 155 mm M 109 G self-propelled gun  
 58 muzzle  
 59 fume extractor  
 60 barrel cradle  
 61 barrel recuperator  
 62 barrel clamp  
 63 light anti-aircraft (AA) machine gun  
 64 Honest John M 386 rocket launcher  
 65 rocket with warhead  
 66 launching ramp  
 67 elevating gear  
 68 jack  
 69 cable winch  
 70 110 SF rocket launcher  
 71 disposable rocket tubes  
 72 tube bins  
 73 turntable  
 74 fire control system  
 75 2.5 tonne construction vehicle  
 76 lifting arms (lifting device)  
 77 shovel  
 78 counterweight (counterpoise)  
 79-95 armoured (*Am. armored*) vehicles  
 79 M 113 armoured (*Am. armored*) ambulance  
 80 Leopard 1 A 3 tank  
 81 protection device  
 82 infrared laser rangefinder  
 83 smoke canisters (smoke dispensers)  
 84 armoured (*Am. armored*) turret  
 85 skirt  
 86 road wheel  
 87 track  
 88 anti-tank tank  
 89 fume extractor  
 90 protection device  
 91 armoured (*Am. armored*) personnel carrier  
 92 cannon  
 93 armoured (*Am. armored*) recovery vehicle  
 94 levelling (*Am. leveling*) and support shovel  
 95 jib  
 96 25 tonne all-purpose vehicle  
 97 drop windscreen (*Am. drop windshield*)  
 98 canvas cover

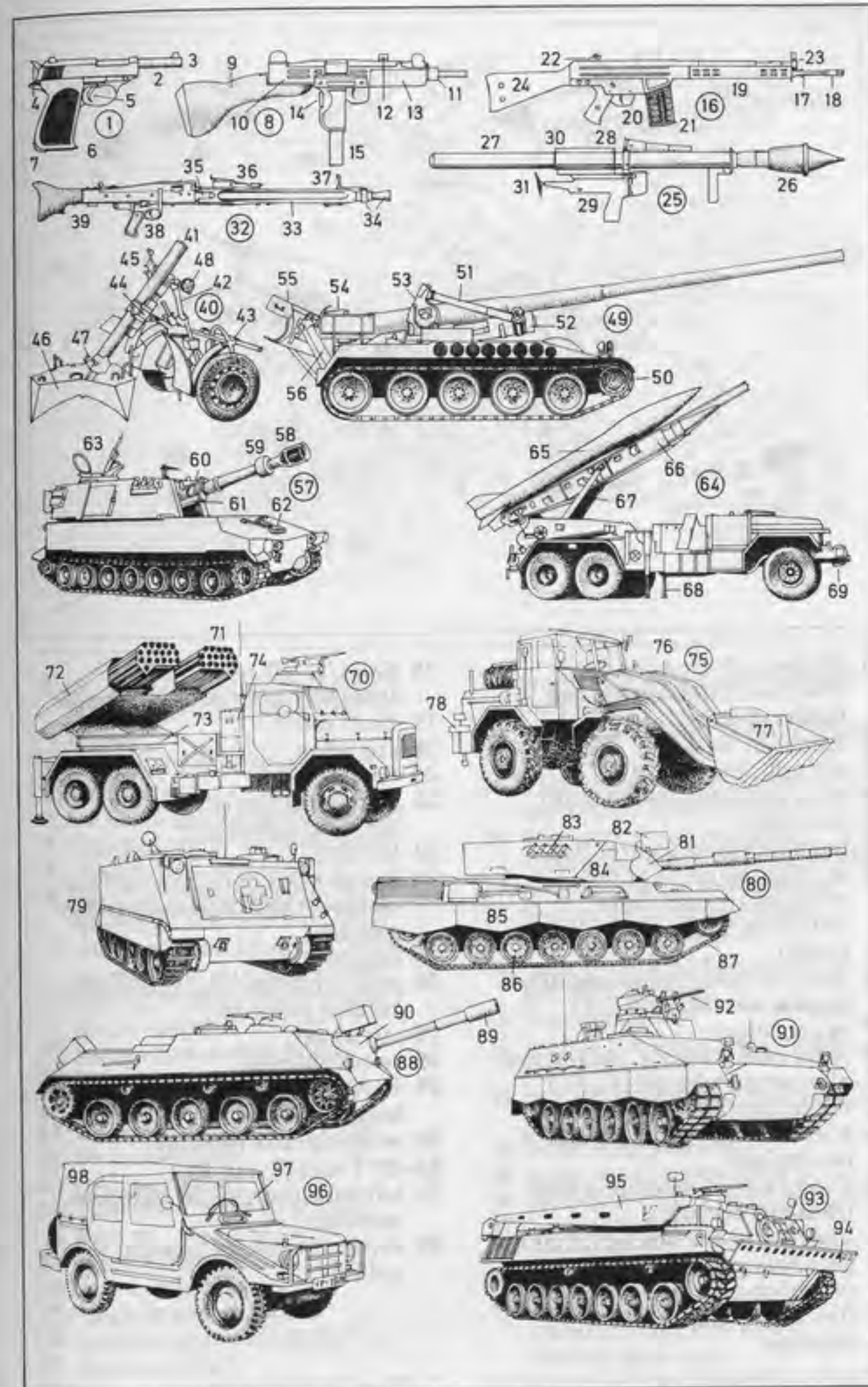





- |  |   |
|--|---|
| <p>1 McDonnell-Douglas F-4F Phantom II interceptor and fighter-bomber</p> <p>2 squadron marking</p> <p>3 aircraft cannon</p> <p>4 wing tank (underwing tank)</p> <p>5 air intake</p> <p>6 boundary layer control flap</p> <p>7 in-flight refuelling (Am. refueling) probe (flight refuelling probe, air refuelling probe)</p> <p>8 Panavia 2000 Tornado multirole combat aircraft (MRCA)</p> <p>9 swing wing</p> <p>10 radar nose (radome, radar dome)</p> <p>11 pitot-static tube (pitot tube)</p> <p>12 brake flap (air brake)</p> <p>13 afterburner exhaust nozzles of the engines</p> <p>14 C160 Transall medium-range transport aircraft</p> <p>15 undercarriage housing (landing gear housing)</p> <p>16 propeller-turbine engine (turboprop engine)</p> <p>17 antenna</p> | <p>18 Bell UH-1D Iroquois light transport and rescue helicopter</p> <p>19 main rotor</p> <p>20 tail rotor</p> <p>21 landing skids</p> <p>22 stabilizing fins (stabilizing surfaces, stabilizers)</p> <p>23 tail skid</p> <p>24 Dornier DO 28 D-2 Skyservant transport and communications aircraft</p> <p>25 engine pod</p> <p>26 main undercarriage unit (main landing gear unit)</p> <p>27 tail wheel</p> <p>28 sword antenna</p> <p>29 F-104 G Starfighter fighter-bomber</p> <p>30 wing-tip tank (tip tank)</p> <p>31-32 T-tail (T-tail unit)</p> <p>31 tailplane (horizontal stabilizer, stabilizer)</p> <p>32 vertical stabilizer (vertical fin, tail fin)</p> |
|--|---|

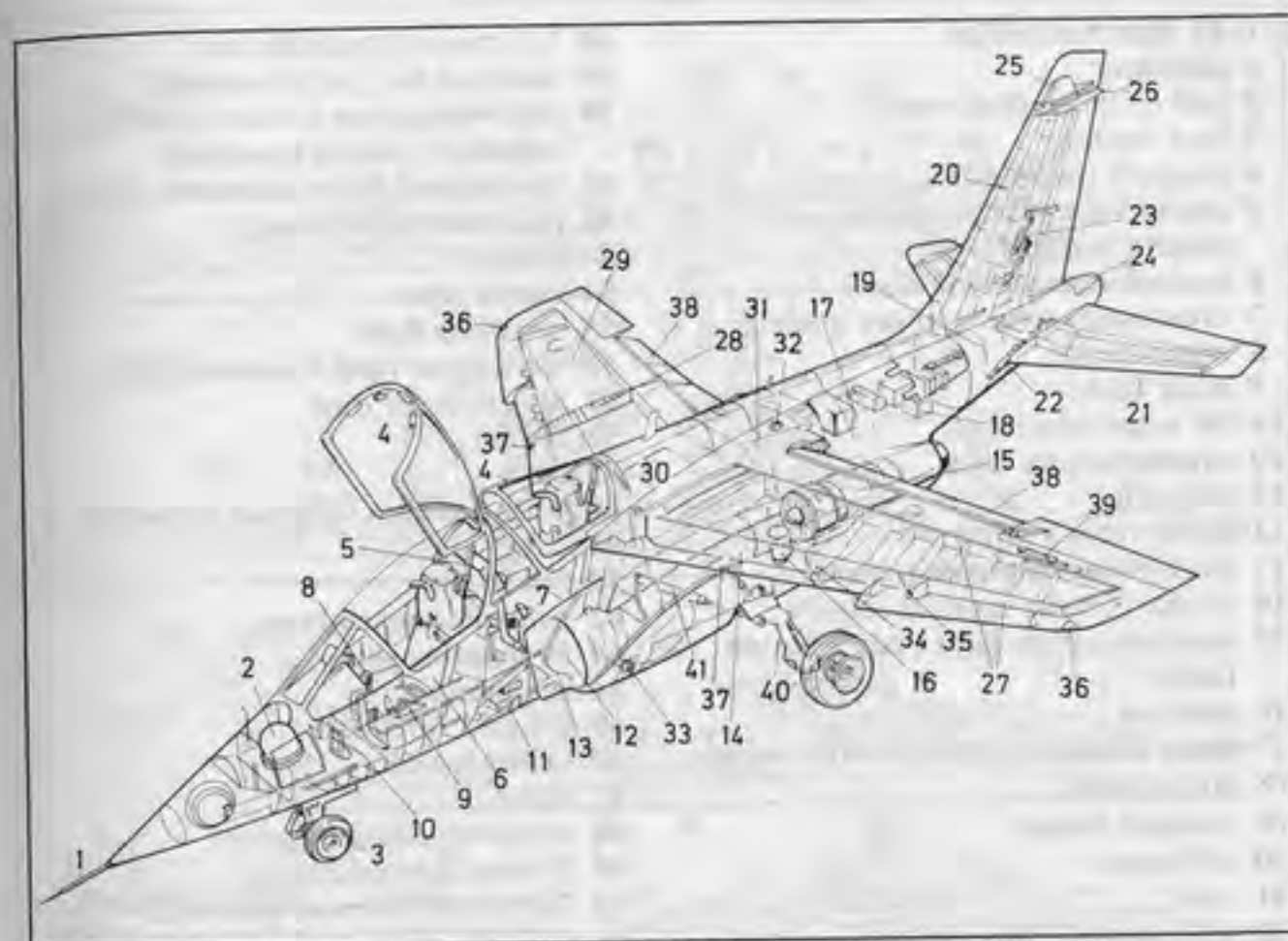

- |   |  |
|---|--|
| <p>1-41 Dornier-Dassault-Breguet Alpha Jet Franco-German jet trainer</p> <p>1 pitot-static tube (pitot tube)</p> <p>2 oxygen tank</p> <p>3 forward-retracting nose wheel</p> <p>4 cockpit canopy (cockpit hood)</p> <p>5 canopy jack</p> <p>6 pilot's seat (student pilot's seat), an ejector seat (ejection seat)</p> <p>7 observer's seat (instructor's seat), an ejector seat (ejection seat)</p> <p>8 control column (control stick)</p> <p>9 thrust lever</p> <p>10 rudder pedals with brakes</p> <p>11 front avionics bay</p> <p>12 air intake to the engine</p> <p>13 boundary layer control flap</p> <p>14 air intake duct</p> <p>15 turbine engine</p> <p>16 reservoir for the hydraulic system</p> <p>17 battery housing</p> <p>18 rear avionics bay</p> <p>19 baggage compartment</p> <p>20 triple-spar tail construction</p> <p>21 horizontal tail</p> <p>22 servo-actuating mechanism for the elevator</p> | <p>23 servo-actuating mechanism for the rudder</p> <p>24 brake chute housing (drag chute housing)</p> <p>25 VHF (very high frequency) antenna (UHF antenna)</p> <p>26 VOR (very high frequency omnidirectional range) antenna</p> <p>27 twin-spar wing construction</p> <p>28 former with integral spars</p> <p>29 integral wing tanks</p> <p>30 centre-section (Am. center-section) fuel tank</p> <p>31 fuselage tanks</p> <p>32 gravity fuelling (Am. fueling) point</p> <p>33 pressure fuelling (Am. fueling) point</p> <p>34 inner wing suspension</p> <p>35 outer wing suspension</p> <p>36 navigation lights (position lights)</p> <p>37 landing lights</p> <p>38 landing flap</p> <p>39 aileron actuator</p> <p>40 forward-retracting main undercarriage unit (main landing gear unit)</p> <p>41 undercarriage hydraulic cylinder (landing gear hydraulic cylinder)</p> |
|---|--|



- 1-63 light battleships  
 1 destroyer  
 2 hull of flush-deck vessel  
 3 bow (stem)  
 4 flagstaff (jackstaff)  
 5 anchor, a stockless anchor (patent anchor)  
 6 anchor capstan (windlass)  
 7 breakwater (*Am.* manger board)  
 8 chine strake  
 9 main deck  
 10-28 superstructures  
 10 superstructure deck  
 11 life rafts  
 12 cutter (ship's boat)  
 13 davit (boat-launching crane)  
 14 bridge (bridge superstructure)  
 15 side navigation light (side running light)  
 16 antenna  
 17 radio direction finder (RDF) frame  
 18 lattice mast  
 19 forward funnel  
 20 aft funnel  
 21 cowl  
 22 aft superstructure (poop)  
 23 capstan  
 24 companion ladder (companionway, companion hatch)  
 25 ensign staff  
 26 stern, a transom stern  
 27 waterline  
 28 searchlight  
 29-37 armament  
 29 100 mm gun turret  
 30 four-barrel anti-submarine rocket launcher (missile launcher)  
 31 40 mm twin anti-aircraft (AA) gun  
 32 MM 38 anti-aircraft (AA) rocket launcher (missile launcher) in launching container  
 33 anti-submarine torpedo tube  
 34 depth-charge thrower  
 35 weapon system radar  
 36 radar antenna (radar scanner)  
 37 optical rangefinder  
 38 destroyer  
 39 bower anchor  
 40 propeller guard  
 41 tripod lattice mast  
 42 pole mast  
 43 ventilator openings (ventilator grill)  
 44 exhaust pipe  
 45 ship's boat  
 46 antenna  
 47 radar-controlled 127 mm all-purpose gun in turret  
 48 127 mm all-purpose gun  
 49 launcher for Tartar missiles  
 50 anti-submarine rocket (ASROC) launcher (missile launcher)  
 51 fire control radar antennas  
 52 radome (radar dome)  
 53 frigate  
 54 hawse pipe  
 55 steaming light  
 56 navigation light (running light)  
 57 air extractor duct  
 58 funnel  
 59 cowl  
 60 whip antenna (fishpole antenna)  
 61 cutter  
 62 stern light  
 63 propeller guard boss  
 64-91 fighting ships  
 64 submarine  
 65 flooded foredeck  
 66 pressure hull  
 67 turret  
 68 retractable instruments  
 69 E-boat (torpedo boat)  
 70 76 mm all-purpose gun with turret  
 71 missile-launching housing  
 72 deckhouse  
 73 40 mm anti-aircraft (AA) gun  
 74 propeller guard moulding (*Am.* molding)  
 75 143 class E-boat (143 class torpedo boat)  
 76 breakwater (*Am.* manger board)  
 77 radome (radar dome)  
 78 torpedo tube  
 79 exhaust escape flue  
 80 mine hunter  
 81 reinforced rubbing strake  
 82 inflatable boat (inflatable dinghy)  
 83 davit  
 84 minesweeper  
 85 cable winch  
 86 towing winch (towing machine, towing engine)  
 87 mine-sweeping gear (paravanes)  
 88 crane (davit)  
 89 landing craft  
 90 bow ramp  
 91 stern ramp  
 92-97 auxiliaries  
 92 tender  
 93 servicing craft  
 94 minelayer  
 95 training ship  
 96 deep-sea salvage tug  
 97 fuel tanker (replenishing ship)

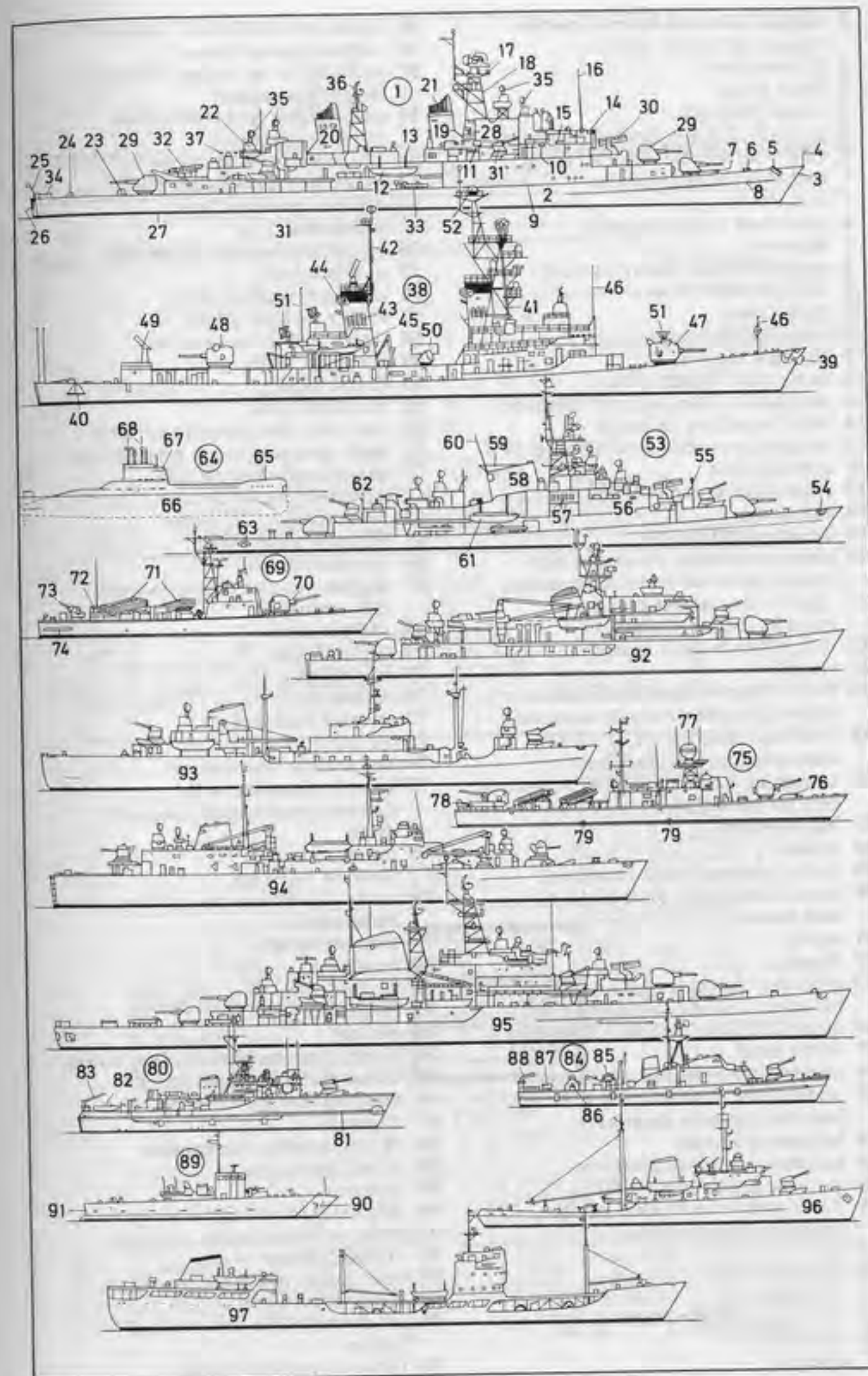



- 1 nuclear-powered aircraft carrier  
"Nimitz ICVN 68" (USA)
- 2-11 body plan
- 2 flight deck
- 3 island (bridge)
- 4 aircraft lift (Am. aircraft elevator)
- 5 eight-barrel anti-aircraft (AA)  
rocket launcher (missile  
launcher)
- 6 pole mast (antenna mast)
- 7 antenna
- 8 radar antenna (radar scanner)
- 8 fully enclosed bow
- 10 deck crane
- 11 transom stern
- 12-20 deck plan
- 12 angle deck (flight deck)
- 13 aircraft lift (Am. aircraft elevator)
- 14 twin launching catapult
- 15 hinged (movable) baffle board
- 16 arrestor wire
- 17 emergency crash barrier
- 18 safety net
- 19 caisson (cofferdam)
- 20 eight-barrel anti-aircraft (AA)  
rocket launcher (missile launcher)
- 21 "Kara" class rocket cruiser  
(missile cruiser) (USSR)
- 22 hull of flush-deck vessel
- 23 sheer
- 24 twelve-barrel underwater salvo  
rocket launcher (missile launcher)
- 25 twin anti-aircraft (AA) rocket  
launcher (missile launcher)
- 26 launching housing for 4 short-range  
rockets (missiles)
- 27 baffle board
- 28 bridge
- 29 radar antenna (radar scanner)
- 30 twin 76 mm anti-aircraft (AA)  
gun turret
- 31 turret
- 32 funnel
- 33 twin anti-aircraft (AA) rocket  
launcher (missile launcher)
- 34 automatic anti-aircraft (AA) gun
- 35 ship's boat
- 36 underwater 5-torpedo housing
- 37 underwater 6-salvo rocket  
launcher (missile launcher)
- 38 helicopter hangar
- 39 helicopter landing platform
- 40 variable depth sonar (VDS)
- 41 "California" class rocket cruiser  
(missile cruiser) (USA)
- 42 hull
- 43 forward turret
- 44 aft turret
- 45 forward superstructure
- 46 landing craft
- 47 antenna
- 48 radar antenna (radar scanner)
- 49 radome (radar dome)
- 50 surface-to-air rocket launcher  
(missile launcher)
- 51 underwater rocket launcher  
(missile launcher)
- 52 127 mm gun with turret
- 53 helicopter landing platform
- 54 nuclear-powered fleet  
submarine
- 55-74 middle section [diagram]
- 55 pressure hull
- 56 auxiliary engine room
- 57 rotary turbine pump
- 58 steam turbine generator
- 59 propeller shaft
- 60 thrust block
- 61 reduction gear
- 62 high and low pressure turbine
- 63 high-pressure steam pipe for the  
secondary water circuit  
(auxiliary water circuit)
- 64 condenser
- 65 primary water circuit
- 66 heat exchanger
- 67 nuclear reactor casing (atomic  
pile casing)
- 68 reactor core
- 69 control rods
- 70 lead screen
- 71 turret
- 72 snorkel (schnorkel)
- 73 air inlet
- 74 retractable instruments
- 75 patrol submarine with  
conventional (diesel-electric)  
drive
- 76 pressure hull
- 77 flooded foredeck
- 78 outer flap (outer doors) [for  
torpedoes]
- 79 torpedo tube
- 80 bow bilge
- 81 anchor
- 82 anchor winch
- 83 battery
- 84 living quarters with folding bunks
- 85 commanding officer's cabin
- 86 main hatchway
- 87 flagstaff
- 88-91 retractable instruments
- 88 attack periscope
- 89 antenna
- 90 snorkel (schnorkel)
- 91 radar antenna (radar scanner)
- 92 exhaust outlet
- 93 heat space (hot-pipe space)
- 94 diesel generators
- 95 aft diving plane and vertical  
rudder
- 96 forward vertical rudder

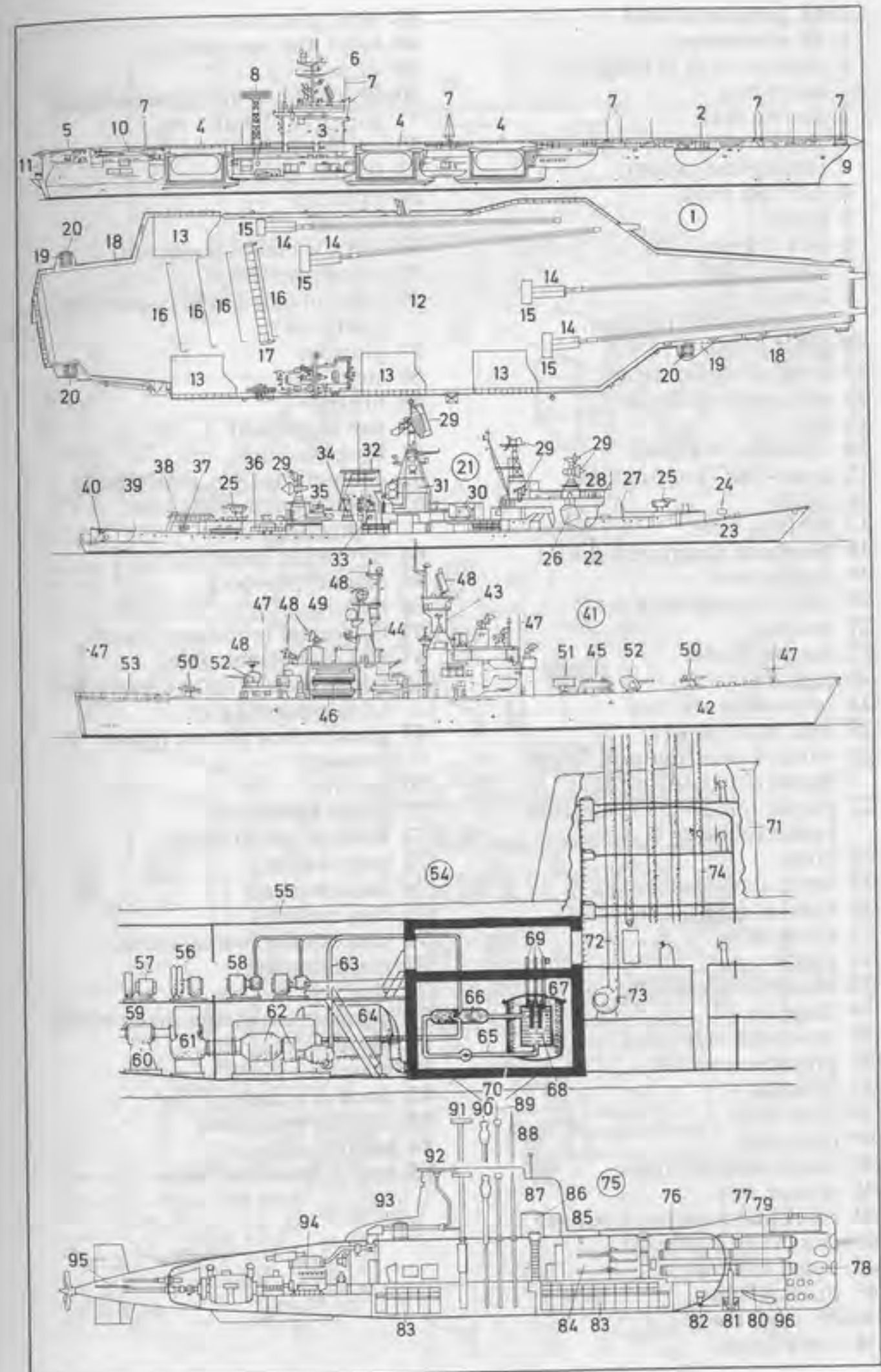



## 1-85 primary school

## 1-45 classroom

- 1 arrangement of desks in a horseshoe
- 2 double desk
- 3 pupils (children) in a group (sitting in a group)
- 4 exercise book
- 5 pencil
- 6 wax crayon
- 7 school bag
- 8 handle
- 9 school satchel (satchel)
- 10 front pocket
- 11 strap (shoulder strap)
- 12 pen and pencil case
- 13 zip
- 14 fountain pen (pen)
- 15 loose-leaf file (ring file)
- 16 reader
- 17 spelling book
- 18 notebook (exercise book)
- 19 felt tip pen
- 20 pupil raising her hand
- 21 teacher
- 22 teacher's desk
- 23 register
- 24 pen and pencil tray
- 25 desk mat (blotter)
- 26 window painting with finger paints (finger painting)
- 27 pupils' (children's) paintings (watercolours)
- 28 cross
- 29 three-part blackboard
- 30 bracket for holding charts
- 31 chalk ledge
- 32 chalk
- 33 blackboard drawing
- 34 diagram
- 35 reversible side blackboard
- 36 projection screen
- 37 triangle
- 38 protractor
- 39 divisions
- 40 blackboard compass
- 41 sponge tray
- 42 blackboard sponge (sponge)
- 43 classroom cupboard
- 44 map (wall map)
- 45 brick wall

- 46-85 craft room
- 46 workbench
- 47 vice (*Am. vise*)
- 48 vice (*Am. vise*) bar
- 49 scissors
- 50-52 working with glue (sticking paper, cardboard, etc.)
- 50 surface to be glued
- 51 tube of glue
- 52 tube cap
- 53 fretsaw
- 54 fretsaw blade (saw blade)
- 55 wood rasp (rasp)
- 56 piece of wood held in the vice (*Am. vise*)
- 57 glue pot
- 58 stool
- 59 brush
- 60 pan (dust pan)
- 61 broken china
- 62 enamelling (*Am. enameling*)
- 63 electric enamelling (*Am. enameling*) stove
- 64 unworked copper
- 65 enamel powder
- 66 hair sieve
- 67-80 pupils' (children's) work
- 67 clay models (models)
- 68 window decoration of coloured (*Am. colored*) glass
- 69 glass mosaic picture (glass mosaic)
- 70 mobile
- 71 paper kite (kite)
- 72 wooden construction
- 73 polyhedron
- 74 hand puppets
- 75 clay masks
- 76 cast candles (wax candles)
- 77 wood carving
- 78 clay jug
- 79 geometrical shapes made of clay
- 80 wooden toys
- 81 materials
- 82 stock of wood
- 83 inks for wood cuts
- 84 paintbrushes
- 85 bag of plaster of Paris





- 1-45 grammar school; also: upper band of a comprehensive school (*Am.* alternative school)
- 1-13 chemistry
- 1 chemistry lab (chemistry laboratory) with tiered rows of seats
- 2 chemistry teacher
- 3 demonstration bench (teacher's bench)
- 4 water pipe
- 5 tiled working surface
- 6 sink
- 7 television monitor, a screen for educational programmes (*Am.* programs)
- 8 overhead projector
- 9 projector top for skins
- 10 projection lens with right-angle mirror
- 11 pupils' (*Am.* students') bench with experimental apparatus
- 12 electrical point (socket)
- 13 projection table
- 14-34 biology preparation room (biology prep room)
- 14 skeleton
- 15 casts of skulls
- 16 calvarium of Pithecanthropus Erectus
- 17 skull of Steinheim man
- 18 calvarium of Peking man (of Sinanthropus)
- 19 skull of Neanderthal man, a skull of primitive man
- 20 Australopithecine skull (skull of Australopithecus)
- 21 skull of present-day man
- 22 dissecting bench
- 23 chemical bottles
- 24 gas tap
- 25 petri dish
- 26 measuring cylinder
- 27 work folder (teaching material)
- 28 textbook
- 29 bacteriological cultures
- 30 incubator
- 31 test tube rack
- 32 washing bottle
- 33 water tank
- 34 sink
- 35 language laboratory
- 36 blackboard

- 37 console
- 38 headphones (headset)
- 39 microphone
- 40 earcups
- 41 padded headband (padded headpiece)
- 42 programme (*Am.* program) recorder, a cassette recorder
- 43 pupil's (*Am.* student's) volume control
- 44 master volume control
- 45 control buttons (operating keys)

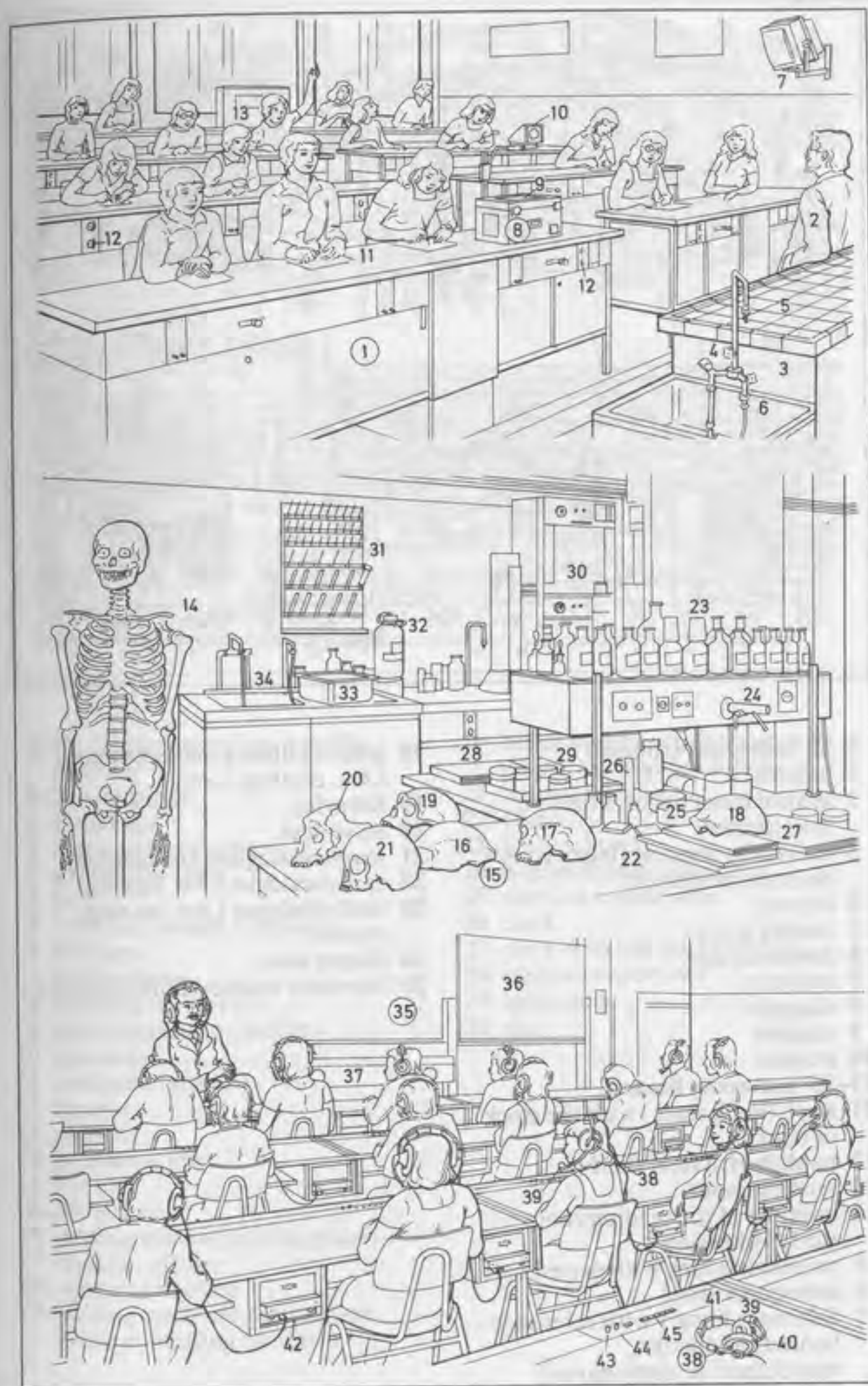

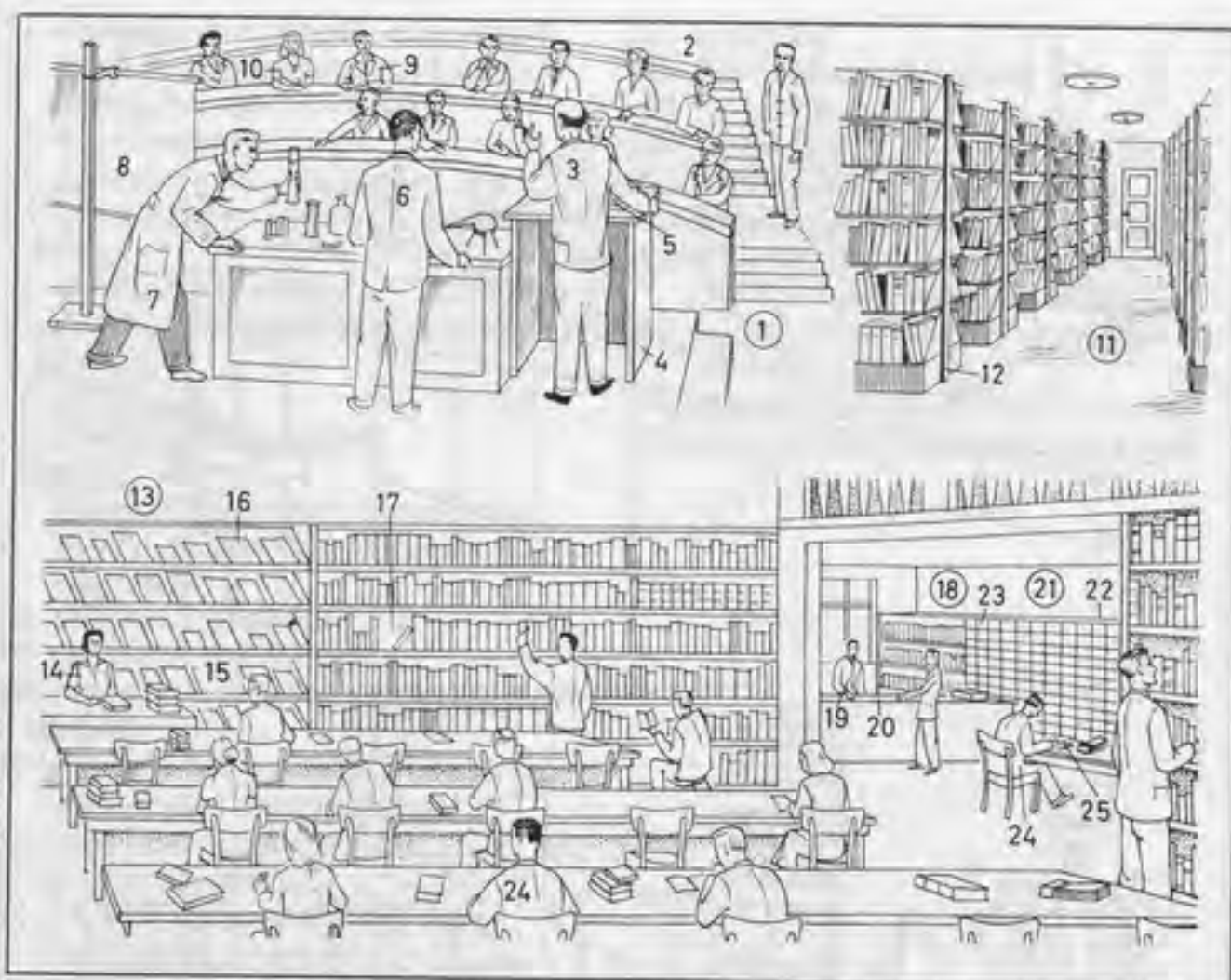

**1-25 university (college)**

- 1 lecture
- 2 lecture room (lecture theatre, *Am.* theater)
- 3 university lecturer (lecturer, *Am.* assistant professor)
- 4 lectern
- 5 lecture notes
- 6 demonstrator
- 7 assistant
- 8 diagram
- 9 student
- 10 student

**11-25 university library**

- 11 stack (book stack) with the stock of books
- 12 bookshelf, a steel shelf
- 13 reading room
- 14 member of the reading room staff, a librarian
- 15 periodicals rack with periodicals
- 16 newspaper shelf
- 17 reference library with reference books (handbooks, encyclopedias, dictionaries)

**18 lending library and catalogue (*Am.* catalog) room**

- 19 librarian
- 20 issue desk
- 21 main catalogue (*Am.* catalog)
- 22 card catalogue (*Am.* catalog)
- 23 card catalogue (*Am.* catalog) drawer
- 24 library user
- 25 borrower's ticket (library ticket)

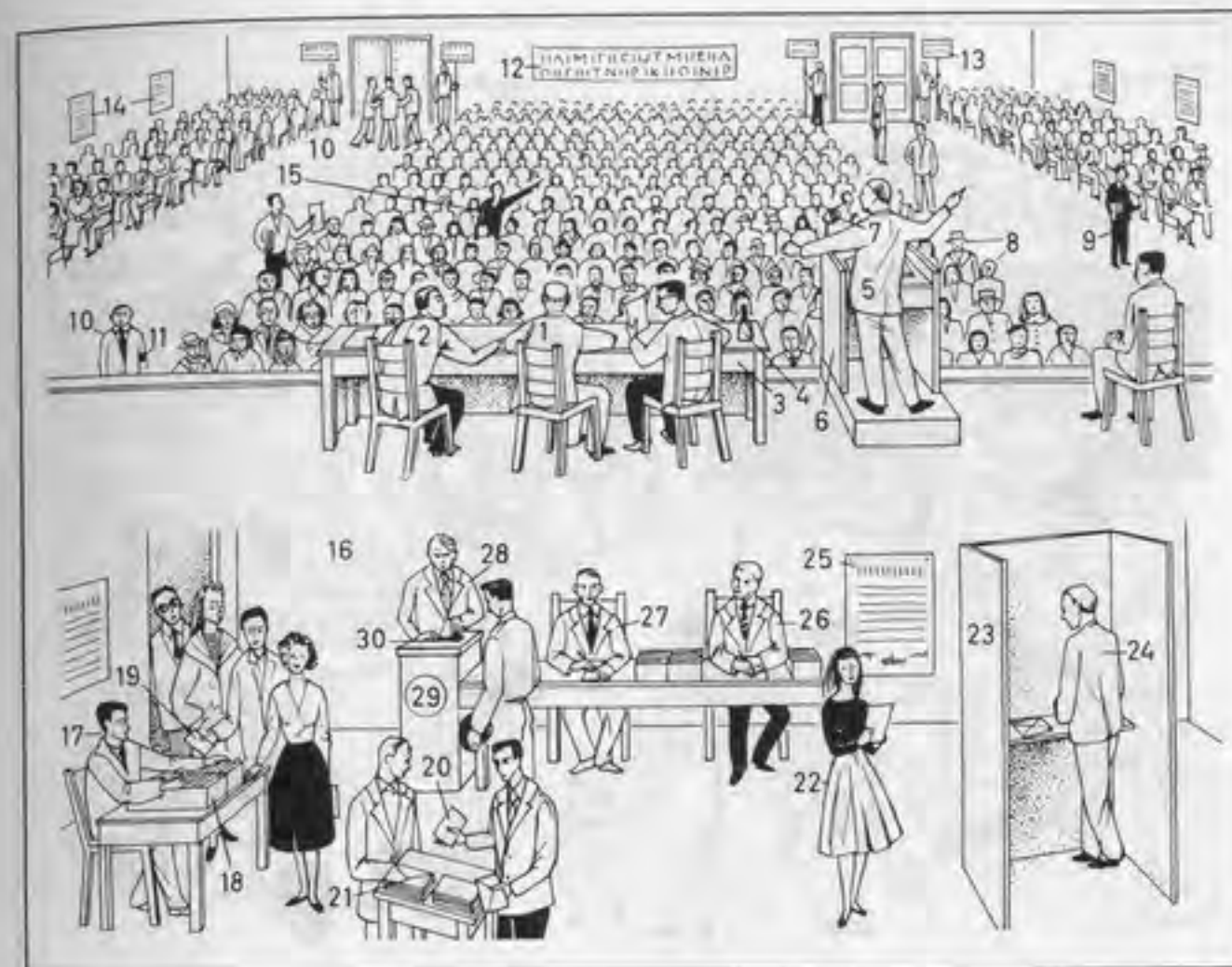
**1-15 election meeting, a public meeting**

- 1-2 committee
- 1 chairman
- 2 committee member
- 3 committee table
- 4 bell
- 5 election speaker (speaker)
- 6 rostrum
- 7 microphone
- 8 meeting (audience)
- 9 man distributing leaflets

**10 stewards****11 armband (armlet)****12 banner****13 placard****14 proclamation****15 heckler****16-30 election****16 polling station (polling place)****17 election officer****18 electoral register****19 polling card with registration number (polling number)****20 ballot paper with the names of the parties and candidates****21 ballot envelope****22 voter****23 polling booth****24 elector (qualified voter)****25 election regulations****26 clerk****27 clerk with the duplicate list****28 election supervisor****29 ballot box****30 slot**

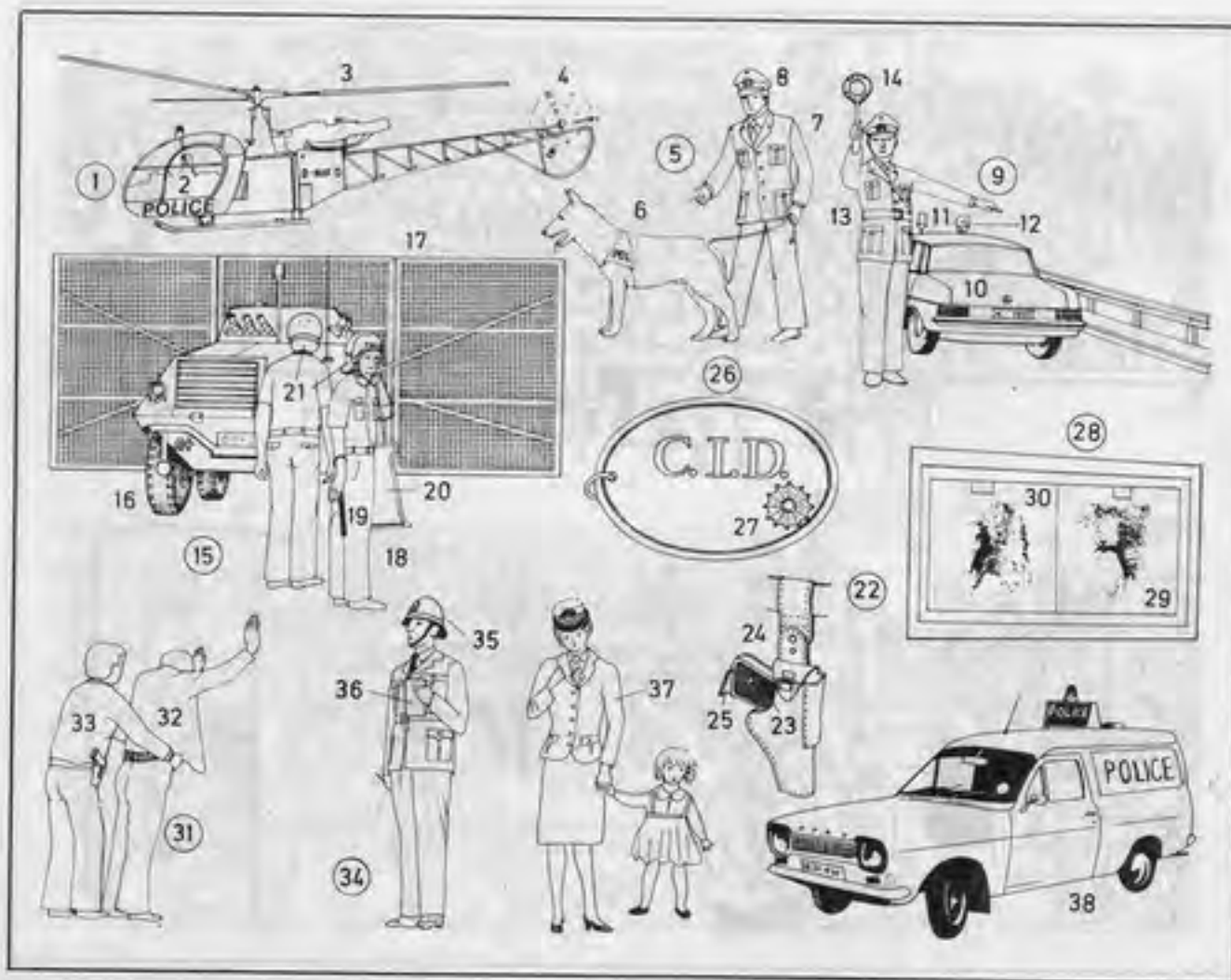

**1-33 police duties**

- 1** police helicopter (traffic helicopter) for controlling (*Am.* controlling) traffic from the air  
**2** cockpit  
**3** rotor (main rotor)  
**4** tail rotor  
**5** police dog and handler  
**6** police dog  
**7** uniform  
**8** uniform cap, a peaked cap with cockade  
**9** traffic control by a mobile traffic patrol  
**10** patrol car  
**11** blue light  
**12** loud hailer (loudspeaker)  
**13** patrolman (police patrolman)  
**14** police signalling (*Am.* signaling) disc (disk)  
**15** riot duty  
**16** special armoured (*Am.* armored) car  
**17** barricade  
**18** policeman (police officer) in riot gear  
**19** truncheon (baton)  
**20** riot shield  
**21** protective helmet (helmet)  
**22** service pistol  
**23** pistol grip  
**24** quick-draw holster  
**25** magazine  
**26** police identification disc (disk)  
**27** police badge  
**28** fingerprint identification (dactyloscopy)  
**29** fingerprint  
**30** illuminated screen  
**31** search  
**32** suspect  
**33** detective (plainclothes policeman)  
**34** English policeman  
**35** helmet  
**36** pocket book  
**37** policewoman  
**38** police van

**1-26 café, sim.: espresso bar, tea room**

- 1** counter (cake counter)  
**2** coffee urn  
**3** tray for the money  
**4** gâteau  
**5** meringue with whipped cream  
**6** trainee pastry cook  
**7** counter assistant  
**8** newspaper shelves (newspaper rack)  
**9** wall lamp  
**10** corner seat, an upholstered seat  
**11** café table  
**12** marble top  
**13** waitress  
**14** tray  
**15** bottle of lemonade  
**16** lemonade glass  
**17** chess players playing a game of chess  
**18** coffee set  
**19** cup of coffee  
**20** small sugar bowl  
**21** cream jug (*Am.* creamer)  
**22-24** café customers  
**22** gentleman  
**23** lady  
**24** man reading a newspaper  
**25** newspaper  
**26** newspaper holder



**1-29 restaurant****1-11 bar (counter)**

- 1 beer pump (beerpull)
- 2 drip tray
- 3 beer glass
- 4 froth (head)
- 5 spherical ashtray for cigarette and cigar ash
- 6 beer glass (beer mug)
- 7 beer warmer
- 8 bartender (barman, *Am.* barkeeper, barkeep)
- 9 shelf for glasses
- 10 shelf for bottles
- 11 stack of plates
- 12 coat stand
- 13 hat peg
- 14 coat hook
- 15 wall ventilator
- 16 bottle
- 17 complete meal
- 18 waitress
- 19 tray
- 20 lottery ticket seller
- 21 menu (menu card)

**22 cruet stand**

- 23 toothpick holder
- 24 matchbox holder
- 25 customer
- 26 beer mat
- 27 meal of the day
- 28 flower seller (flower girl)
- 29 flower basket
- 30-44 wine restaurant (wine bar)**
- 30 wine waiter, a head waiter
- 31 wine list
- 32 wine carafe
- 33 wineglass
- 34 tiled stove
- 35 stove tile
- 36 stove bench
- 37 wooden panelling (*Am.* paneling)
- 38 corner seat
- 39 corner table
- 40 regular customer
- 41 cutlery chest
- 42 wine cooler
- 43 bottle of wine
- 44 ice cubes (ice, lumps of ice)

**45-78 self-service restaurant**

- 45 stack of trays
- 46 drinking straws (straws)
- 47 serviettes (napkins)
- 48 cutlery holders
- 49 cool shelf
- 50 slice of honeydew melon
- 51 plate of salad
- 52 plate of cheeses
- 53 fish dish
- 54 filled roll
- 55 meat dish with trimmings
- 56 half chicken
- 57 basket of fruit
- 58 fruit juice
- 59 drinks shelf
- 60 bottle of mineral water
- 61 bottle of mineral water
- 62 vegetarian meal (diet meal)
- 63 tray
- 64 tray counter
- 65 food price list
- 66 serving hatch
- 67 hot meal
- 68 beer pump (beerpull)

**69 cash desk**

- 70 cashier
- 71 proprietor
- 72 rail
- 73 dining area
- 74 table
- 75 open sandwich
- 76 ice-cream sundae
- 77 salt cellar and pepper pot
- 78 table decoration (flower arrangement)



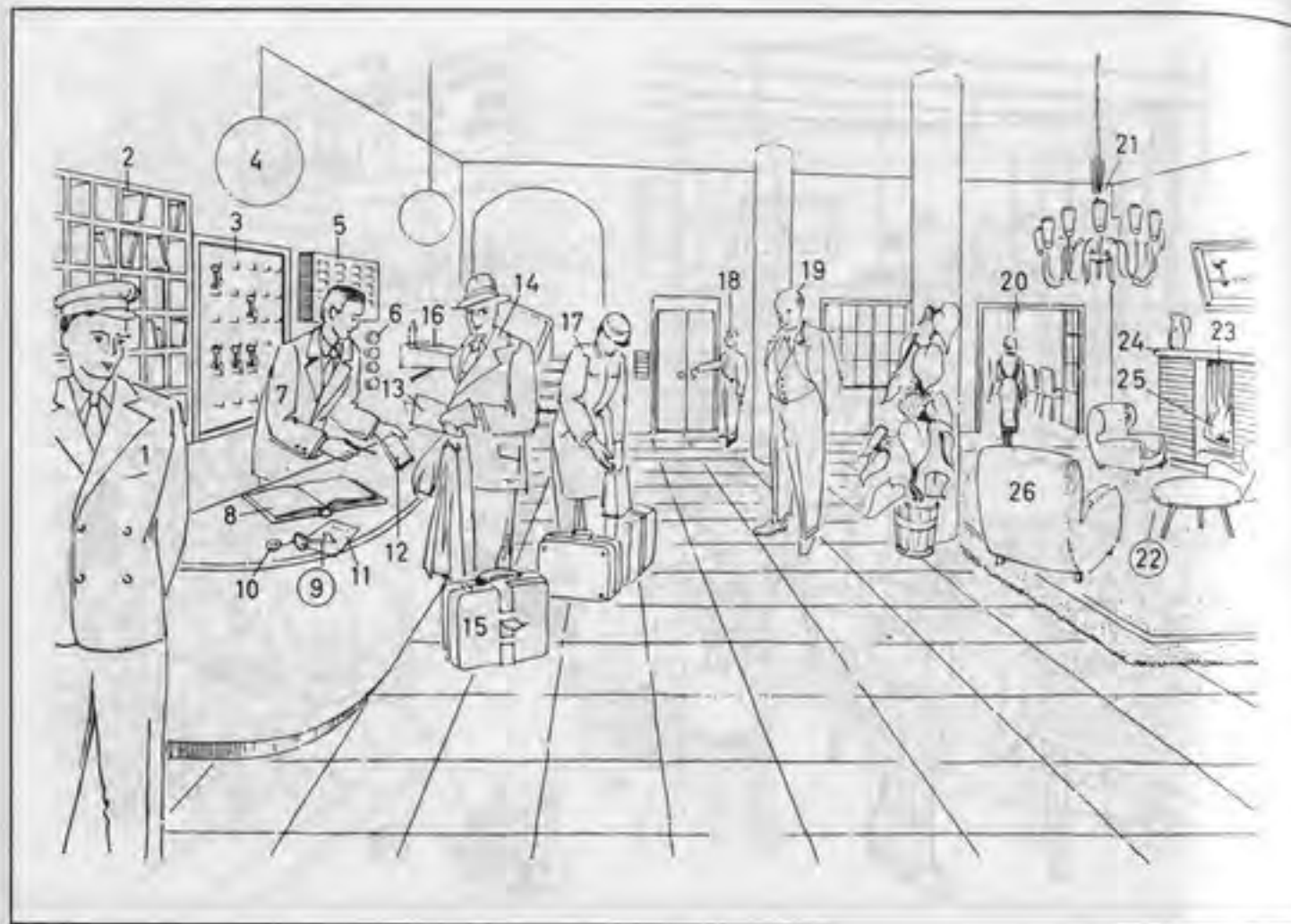

- 1-26 vestibule (foyer, reception hall)**  
 1 doorman (commissionaire)  
 2 letter rack with pigeon holes  
 3 key rack  
 4 globe lamp, a frosted glass globe  
 5 indicator board (drop board)  
 6 indicator light  
 7 chief receptionist  
 8 register (hotel register)  
 9 room key  
 10 number tag (number tab) showing room number  
 11 hotel bill  
 12 block of registration forms  
 13 passport  
 14 hotel guest  
 15 lightweight suitcase, a light suitcase for air travel  
 16 wall desk  
 17 porter (*Am.* baggage man)  
 18-26 lobby (hotel lobby)  
 18 page (pageboy, *Am.* bell boy)  
 19 hotel manager  
 20 dining room (hotel restaurant)

- 21 chandelier  
 22 fireside  
 23 fireplace  
 24 mantelpiece (mantelshelf)  
 25 fire (open fire)  
 26 armchair  
**27-38 hotel room, a double room with bath**  
 27 double door  
 28 service bell panel  
 29 wardrobe trunk  
 30 clothes compartment  
 31 linen compartment  
 32 double washbasin  
 33 room waiter  
 34 room telephone  
 35 velour (velours) carpet  
 36 flower stand  
 37 flower arrangement  
 38 double bed  
**39 banquet room**  
**40-43 private party**  
 40 speaker proposing a toast  
 41 42's neighbour (*Am.* neighbor)  
 42 43's partner



- 43 42's partner  
**44-46 thé dansant (tea dance) in the foyer**  
 44 bar trio  
 45 violinist  
 46 couple dancing (dancing couple)  
 47 waiter  
 48 napkin  
 49 cigar and cigarette boy  
 50 cigarette tray  
**51 hotel bar**  
 52 foot rail  
 53 bar stool  
 54 bar  
 55 bar customer  
 56 cocktail glass (*Am.* highball glass)  
 57 whisky (whiskey) glass  
 58 champagne cork  
 59 champagne bucket (champagne cooler)  
 60 measuring beaker (measure)  
 61 cocktail shaker  
 62 bartender (barman, *Am.* barkeeper, barkeep)

- 63 barmaid  
 64 shelf for bottles  
 65 shelf for glasses  
 66 mirrored panel  
 67 ice bucket





- |   |  |
|---|--|
| 1 parking meter                               | 22 rubbish (litter)  |
| 2 map of the town (street map)                | 23 tramlines ( <i>Am.</i> streetcar tracks)                            |
| 3 illuminated board                           | 24 pedestrian crossing (zebra crossing, <i>Am.</i> crosswalk)          |
| 4 key   | 25 tram stop ( <i>Am.</i> streetcar stop, trolley stop)                |
| 5 litter bin ( <i>Am.</i> litter basket)      | 26 tram stop sign ( <i>Am.</i> streetcar stop sign, trolley stop sign) |
| 6 street lamp (street light)                  | 27 tram timetable ( <i>Am.</i> streetcar schedule)                     |
| 7 street sign showing the name of the street  | 28 ticket machine  |
| 8 drain                                       | 29 'pedestrian crossing' sign  |
| 9 clothes shop (fashion house)                | 30 traffic policeman on traffic duty (point duty)                      |
| 10 shop window                                | 31 traffic control cuff  |
| 11 window display (shop window display)       | 32 white cap   |
| 12 window decoration (shop window decoration) | 33 hand signal   |
| 13 entrance                                   | 34 motorcyclist  |
| 14 window                                     | 35 motorcycle  |
| 15 window box                                 | 36 pillion passenger (pillion rider)                                   |
| 16 neon sign                                  | 37 bookshop  |
| 17 tailor's workroom                          | 38 hat shop (hatter's shop); for ladies' hats: milliner's shop         |
| 18 pedestrian                                 | 39 shop sign   |
| 19 shopping bag                               | 40 insurance company office  |
| 20 road sweeper ( <i>Am.</i> street sweeper)  |  |
| 21 broom                                      |  |



- |   |   |
|---|---|
| 41 department store   | 62 steps to the public lavatories (public conveniences) |
| 42 shop front   | 63 taxi rank (taxi stand)                               |
| 43 advertisement  | 64 taxi (taxicab, cab)                                  |
| 44 flags  | 65 taxi sign  |
| 45 illuminated letters  | 66 traffic sign showing 'taxi rank' ('taxi stand')      |
| 46 tram ( <i>Am.</i> streetcar, trolley)                      | 67 taxi telephone                                       |
| 47 furniture lorry ( <i>Am.</i> furniture truck)              | 68 post office  |
| 48 flyover  | 69 cigarette machine                                    |
| 49 suspended street lamp                                      | 70 advertising pillar                                   |
| 50 stop line  | 71 poster (advertisement)                               |
| 51 pedestrian crossing ( <i>Am.</i> crosswalk)                | 72 white line   |
| 52 traffic lights   | 73 lane arrow for turning left                          |
| 53 traffic light post   | 74 lane arrow for going straight ahead                  |
| 54 set of lights  | 75 news vendor ( <i>Am.</i> news dealer)                |
| 55 pedestrian lights  |   |
| 56 telephone box (telephone booth, telephone kiosk, call box) |   |
| 57 cinema advertisement (film poster)                         |   |
| 58 pedestrian precinct (paved zone)                           |   |
| 59 street café  |   |
| 60 group seated (sitting) at a table                          |   |
| 61 sunshade   |   |



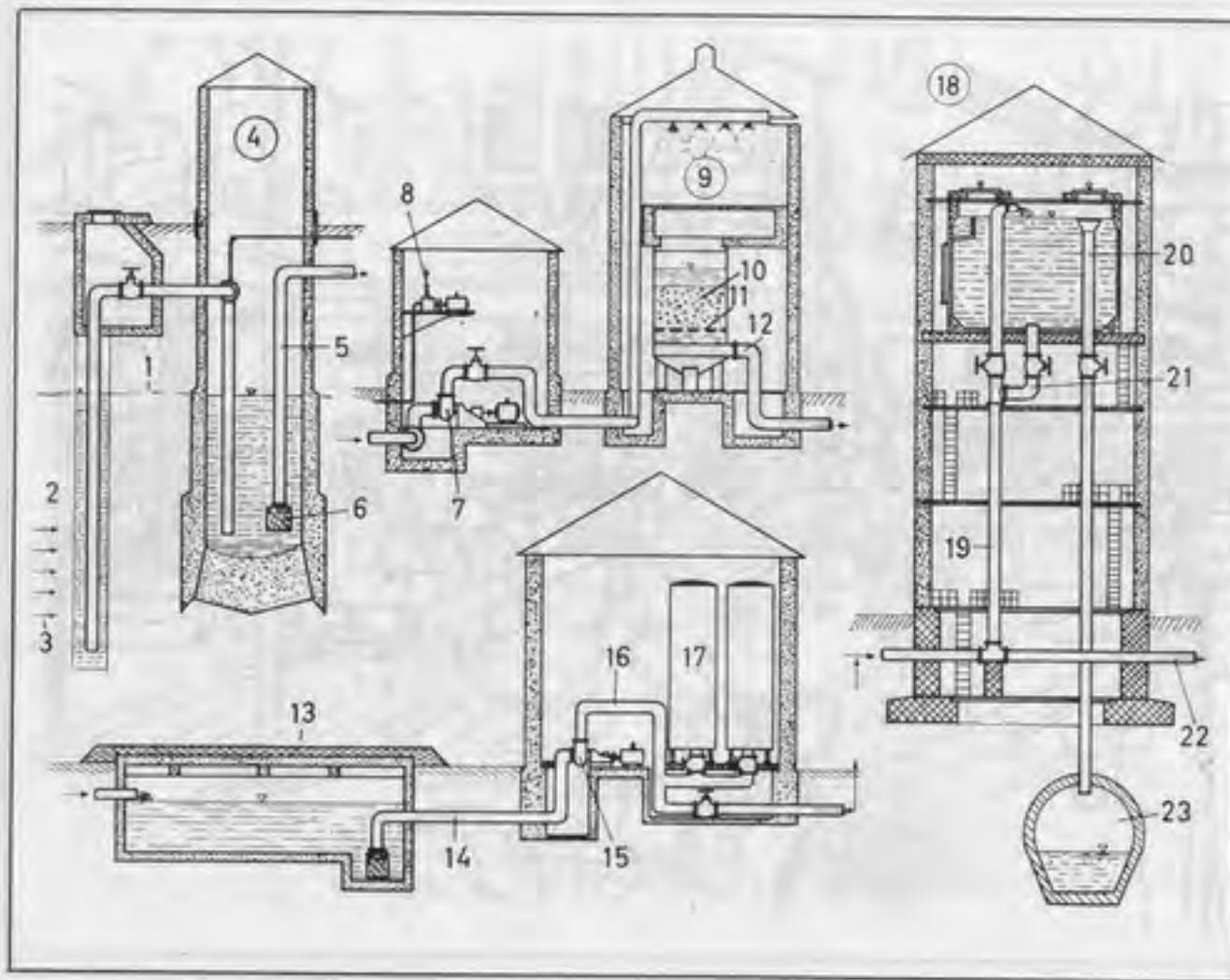

**1-66 drinking water supply**

- 1 water table (groundwater level)
- 2 water-bearing stratum (aquifer, aquafer)
- 3 groundwater stream (underground stream)
- 4 collector well for raw water
- 5 suction pipe
- 6 pump strainer (with foot valve)
- 7 bucket pump with motor
- 8 vacuum pump with motor
- 9 rapid-filter plant
- 10 filter gravel (filter bed)
- 11 filter bottom, a grid
- 12 filtered water outlet
- 13 purified water tank
- 14 suction pipe with pump strainer and foot valve
- 15 main pump with motor
- 16 delivery pipe
- 17 compressed-air vessel (air vessel, air receiver)
- 18 water tower
- 19 riser pipe (riser)
- 20 overflow pipe
- 21 outlet
- 22 distribution main
- 23 excess water conduit
- 24-39 tapping a spring
- 24 chamber
- 25 chamber wall
- 26 manhole
- 27 ventilator
- 28 step irons
- 29 filling (backing)
- 30 outlet control valve
- 31 outlet valve
- 32 strainer
- 33 overflow pipe (overflow)
- 34 bottom outlet
- 35 earthenware pipes
- 36 impervious stratum (impermeable stratum)
- 37 rough rubble
- 38 water-bearing stratum (aquifer, aquafer)
- 39 loam seal (clay seal)
- 40-52 individual water supply
- 40 well
- 41 suction pipe

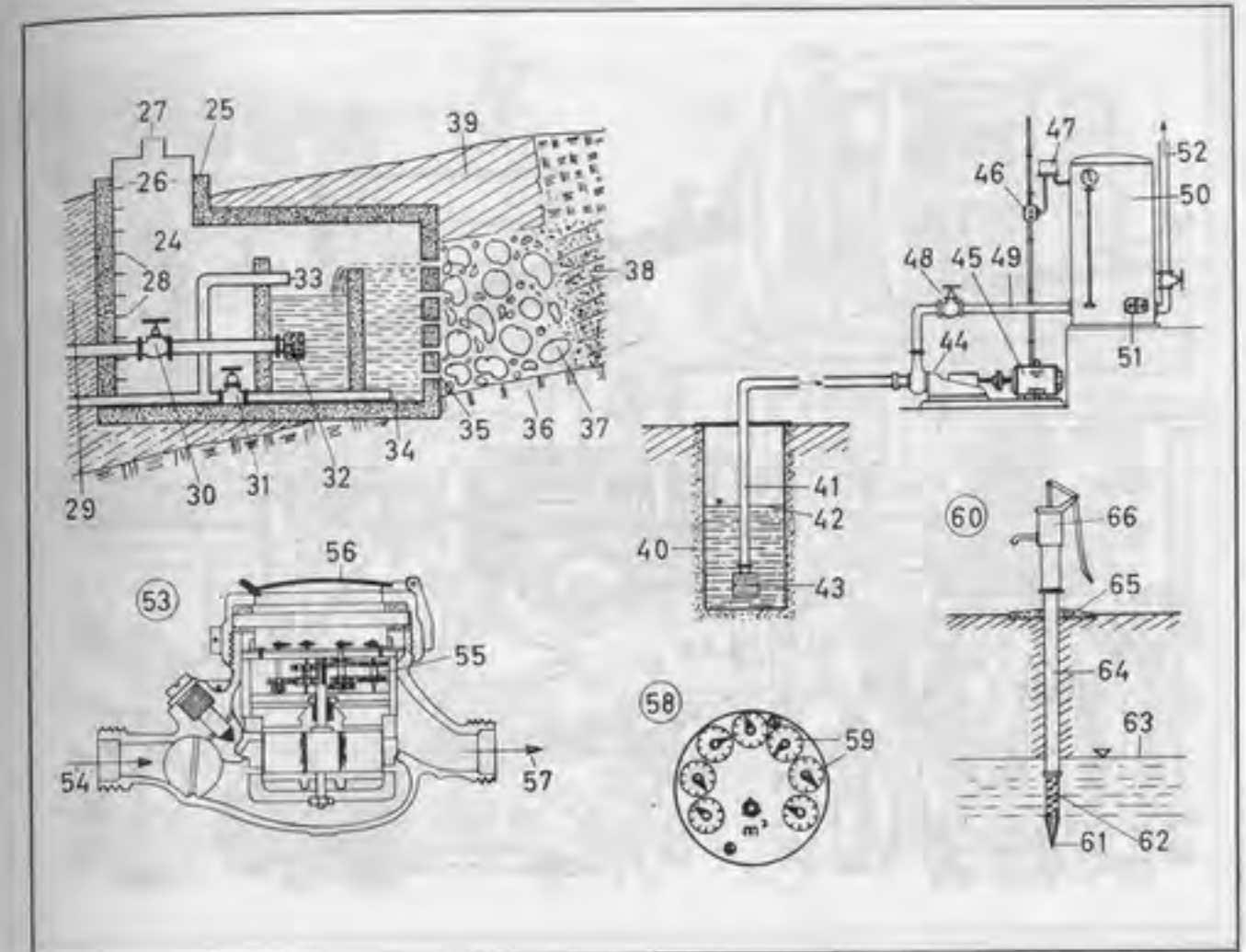

- 42 water table (groundwater level)
- 43 pump strainer with foot valve
- 44 centrifugal pump
- 45 motor
- 46 motor safety switch
- 47 manostat, a switching device
- 48 stopcock
- 49 delivery pipe
- 50 compressed-air vessel (air vessel, air receiver)
- 51 manhole
- 52 delivery pipe
- 53 water meter, a rotary meter
- 54 water inlet
- 55 counter gear assembly
- 56 cover with glass lid
- 57 water outlet
- 58 water-meter dial
- 59 counters
- 60 driven well (tube well, drive well)
- 61 pile shoe
- 62 filter
- 63 water table (groundwater level)
- 64 well casing
- 65 well head
- 66 hand pump



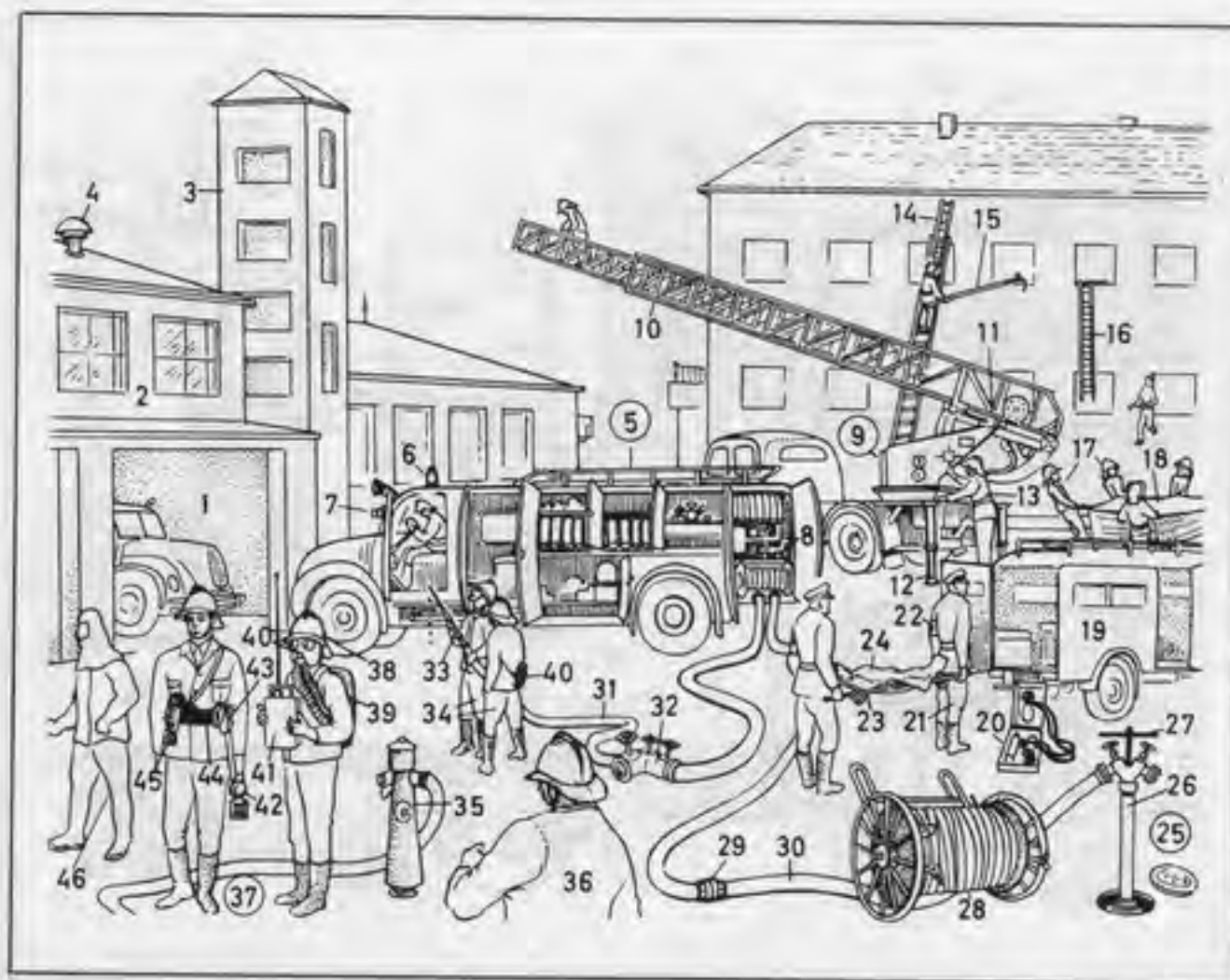

- 1-46 fire service drill**  
(extinguishing, climbing, ladder, and rescue work)
- 1-3 fire station**  
1 engine and appliance room  
2 firemen's quarters  
3 drill tower  
4 fire alarm (fire alarm siren, fire siren)  
5 fire engine  
6 blue light (warning light), a flashing light (*Am.* flashlight)  
7 horn (hooter)  
8 motor pump, a centrifugal pump  
9 motor turntable ladder (*Am.* aerial ladder)  
10 ladder, a steel ladder (automatic extending ladder)  
11 ladder mechanism  
12 jack  
13 ladder operator  
14 extension ladder  
15 ceiling hook (*Am.* preventer)  
16 hook ladder (*Am.* pompier ladder)  
17 holding squad  
18 jumping sheet (sheet)  
19 ambulance car (ambulance)  
20 resuscitator (resuscitation equipment), oxygen apparatus  
21 ambulance attendant (ambulance man)  
22 armband (armlet, brassard)  
23 stretcher  
24 unconscious man  
25 pit hydrant  
26 standpipe (riser, vertical pipe)  
27 hydrant key  
28 hose reel (*Am.* hose cart, hose wagon, hose truck, hose carriage)  
29 hose coupling  
30 soft suction hose  
31 delivery hose  
32 dividing breeching  
33 branch  
34 branchmen  
35 surface hydrant (fire plug)  
36 officer in charge  
37 fireman (*Am.* firefighter)

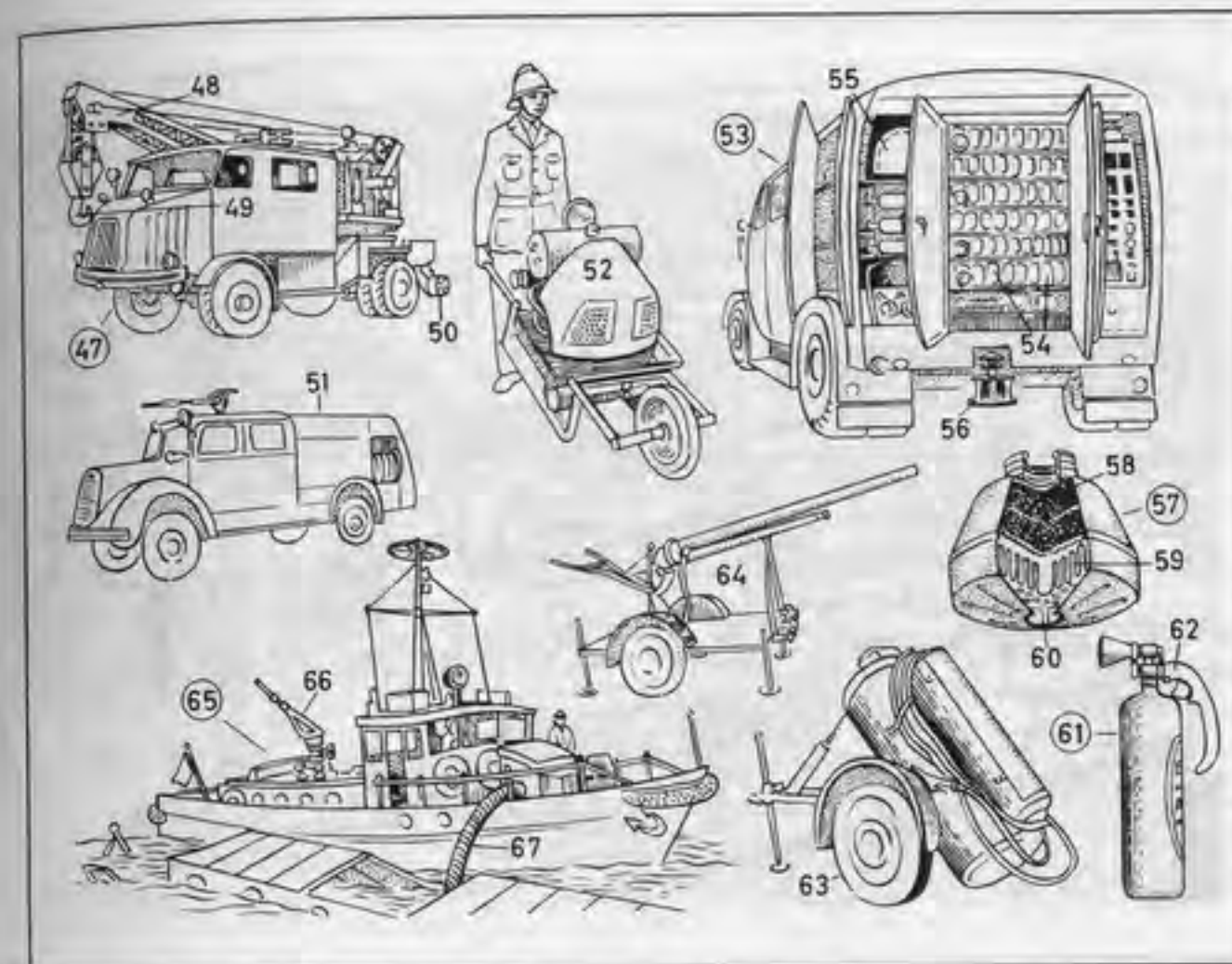

- 38 helmet (fireman's helmet, *Am.* fire hat)  
39 breathing apparatus  
40 face mask  
41 walkie-talkie set  
42 hand lamp  
43 small axe (*Am.* ax, pompier hatchet)  
44 hook belt  
45 beltline  
46 protective clothing of asbestos (asbestos suit) or of metallic fabric  
47 breakdown lorry (*Am.* crane truck, wrecking crane)  
48 lifting crane  
49 load hook (draw hook, *Am.* drag hook)  
50 support roll  
51 water tender  
52 portable pump  
53 hose layer  
54 flaked lengths of hose  
55 cable drum  
56 winch  
57 face mask filter  
58 active carbon (activated carbon, activated charcoal)  
59 dust filter  
60 air inlet  
61 portable fire extinguisher  
62 trigger valve  
63 large mobile extinguisher (wheeled fire extinguisher)  
64 foam-making branch (*Am.* foam gun)  
65 fireboat  
66 monitor (water cannon)  
67 suction hose





- 1 cashier
- 2 electric cash register (till)
- 3 number keys
- 4 cancellation button
- 5 cash drawer (till)
- 6 compartments (money compartments) for coins and notes (*Am.* bills)
- 7 receipt (sales check)
- 8 cash total
- 9 adding mechanism
- 10 goods
- 11 glass-roofed well
- 12 men's wear department
- 13 showcase (display case, indoor display window)
- 14 wrapping counter
- 15 tray for purchases
- 16 customer
- 17 hosiery department
- 18 shop assistant (*Am.* salesgirl, saleslady)
- 19 price card
- 20 glove stand

- 21 duffle coat, a three-quarter length coat
- 22 escalator
- 23 fluorescent light (fluorescent lamp)
- 24 office (e.g. customer accounts office, travel agency, manager's office)
- 25 poster (advertisement)
- 26 theatre (*Am.* theater) and concert booking office (advance booking office)
- 27 shelves
- 28 ladies' wear department
- 29 ready-made dress (ready-to-wear dress, *coll.* off-the-peg dress)
- 30 dust cover
- 31 clothes rack
- 32 changing booth (fitting booth)
- 33 shop walker (*Am.* floorwalker, floor manager)
- 34 dummy
- 35 seat (chair)

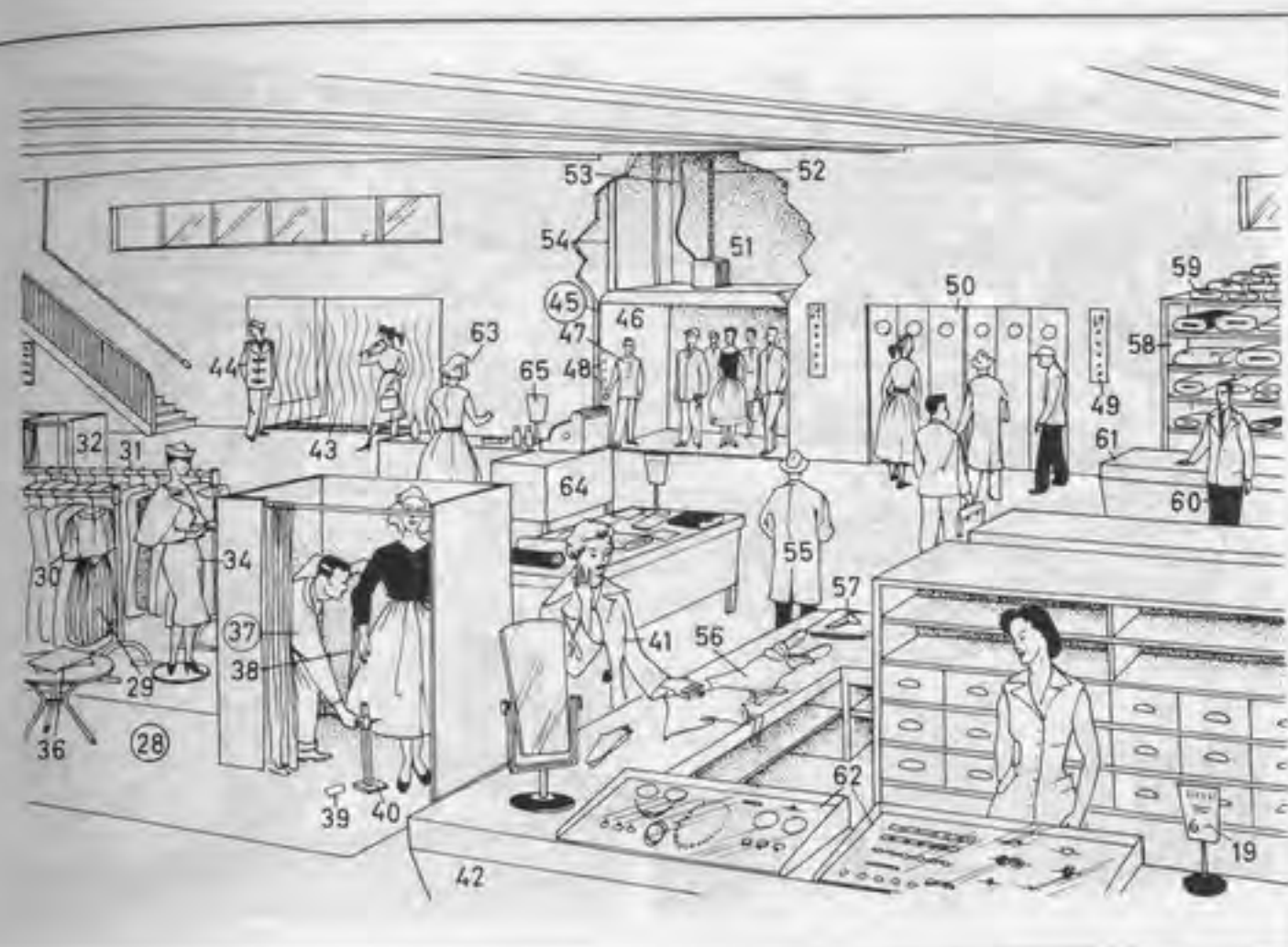

- 36 fashion journal (fashion magazine)
- 37 tailor marking a hemline
- 38 measuring tape (tape measure)
- 39 tailor's chalk (*French* chalk)
- 40 hemline marker
- 41 loose-fitting coat
- 42 sales counter
- 43 warm-air curtain
- 44 doorman (commissionaire)
- 45 lift (*Am.* elevator)
- 46 lift cage (lift car, *Am.* elevator car)
- 47 lift operator (*Am.* elevator operator)
- 48 controls (lift controls, *Am.* elevator controls)
- 49 floor indicator
- 50 sliding door
- 51 lift shaft (*Am.* elevator shaft)
- 52 bearer cable
- 53 control cable
- 54 guide rail
- 55 customer

- 56 hosiery
- 57 linen goods (table linen and bed linen)
- 58 fabric department
- 59 roll of fabric (roll of material, roll of cloth)
- 60 head of department (department manager)
- 61 sales counter
- 62 jewellery (*Am.* jewelry) department
- 63 assistant (*Am.* salesgirl, saleslady), selling new lines (new products)
- 64 special counter (extra counter)
- 65 placard advertising special offers
- 66 curtain department
- 67 display on top of the shelves



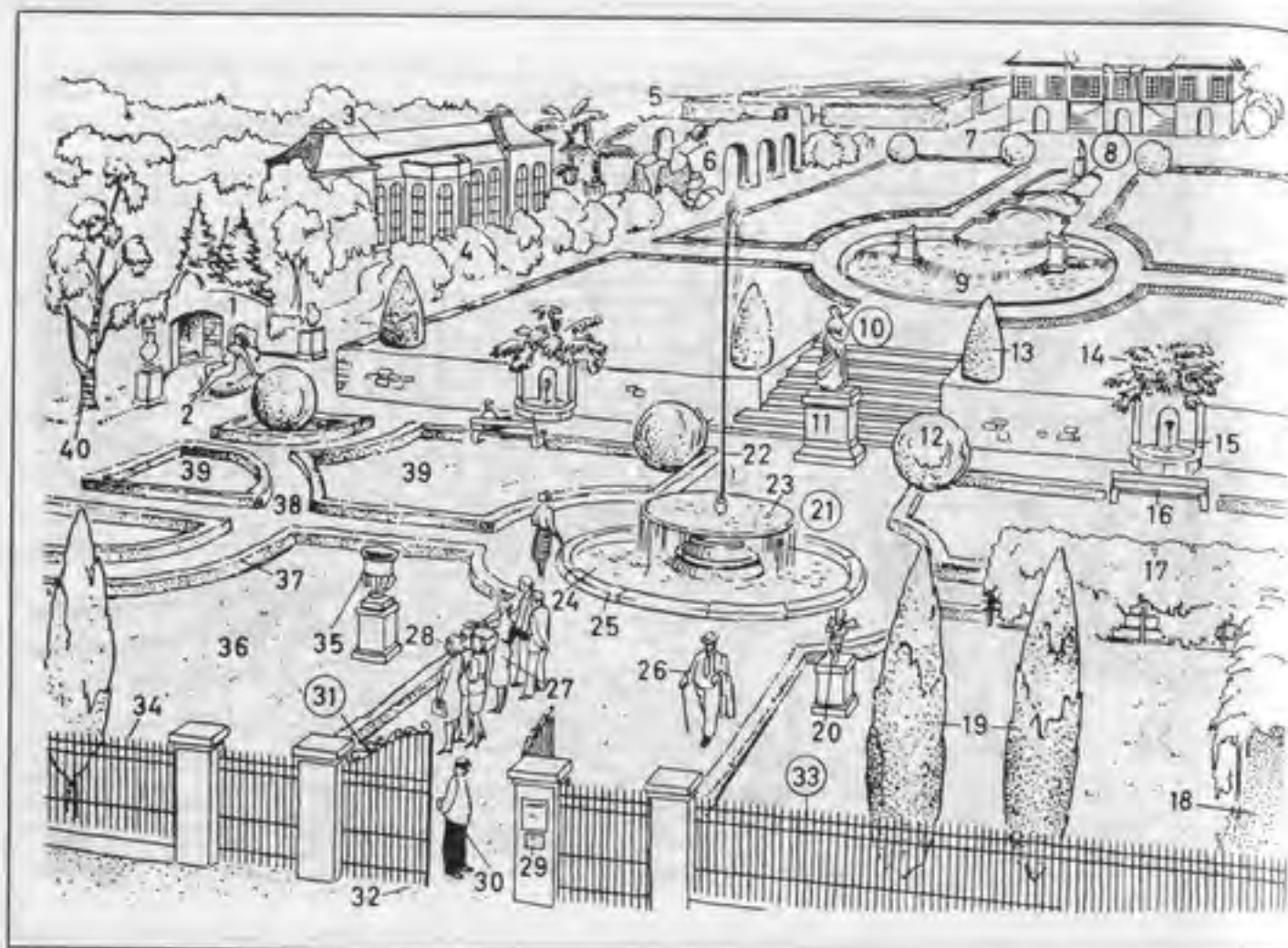

**1-40 formal garden** (French Baroque garden), palace gardens

- 1 grotto (cavern)
- 2 stone statue, a river nymph
- 3 orangery (orangerie)
- 4 boschage (boskage)
- 5 maze (labyrinth of paths and hedges)
- 6 open-air theatre (*Am.* theater)
- 7 Baroque palace
- 8 fountains
- 9 cascade (broken artificial waterfall, artificial falls)
- 10 statue, a monument
- 11 pedestal (base of statue)
- 12 globe-shaped tree
- 13 conical tree
- 14 ornamental shrub
- 15 wall fountain
- 16 park bench
- 17 pergola (bower, arbour, *Am.* arbor)
- 18 gravel path (gravel walk)
- 19 pyramid tree (pyramidal tree)

- 20 cupid (cherub, amoretto, amorino)
- 21 fountain
- 22 fountain
- 23 overflow basin
- 24 basin
- 25 kerb (curb)
- 26 man out for a walk
- 27 tourist guide
- 28 group of tourists
- 29 park by-laws (*bye-laws*)
- 30 park keeper
- 31 garden gates, wrought iron gates
- 32 park entrance
- 33 park railings
- 34 railing (bar)
- 35 stone vase
- 36 lawn
- 37 border, a trimmed (clipped) hedge
- 38 park path
- 39 parterre
- 40 birch (birch tree)

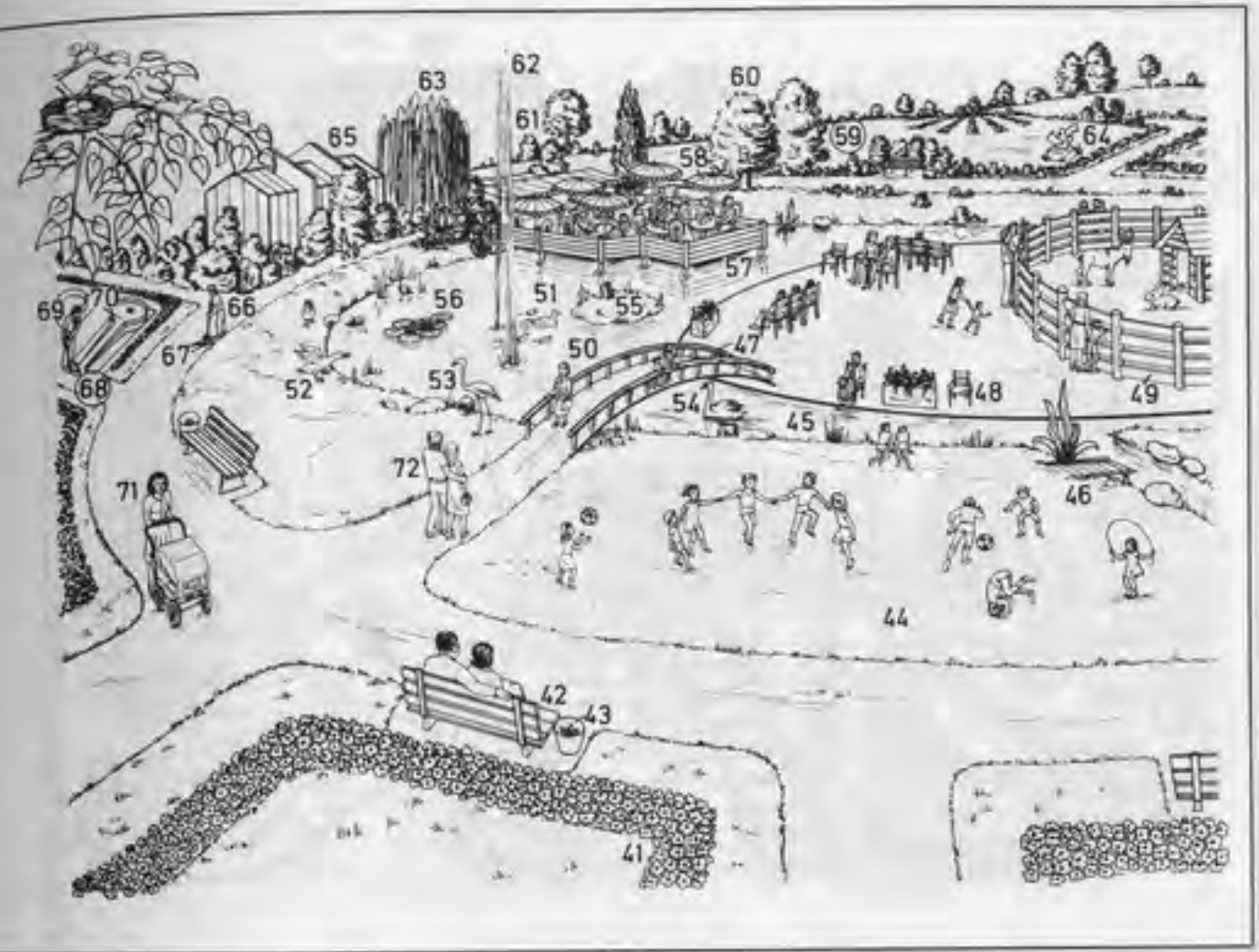

**41-72 landscaped park** (*jardin anglais*)

- 41 flower bed
- 42 park bench (garden seat)
- 43 litter bin (*Am.* litter basket)
- 44 play area
- 45 stream
- 46 jetty
- 47 bridge
- 48 park chair
- 49 animal enclosure
- 50 pond
- 51-54 waterfowl
- 51 wild duck with young
- 52 goose
- 53 flamingo
- 54 swan
- 55 island
- 56 water lily
- 57 open-air café
- 58 sunshade
- 59 tree
- 60 treetop (crown)
- 61 group of trees

- 62 fountain
- 63 weeping willow
- 64 modern sculpture
- 65 hothouse
- 66 park gardener
- 67 broom
- 68 minigolf course
- 69 minigolf player
- 70 minigolf hole
- 71 mother with pram (baby carriage)
- 72 courting couple (young couple)





- |   |  |
|---|--|
| 1 table tennis  | 23 lookout platform                                |
| 2 table   | 24 slide   |
| 3 table tennis net  | 25 litter bin ( <i>Am.</i> litter basket)          |
| 4 table tennis racket (raquet) (table tennis bat)                 | 26 teddy bear                                      |
| 5 table tennis ball   | 27 wooden train set                                |
| 6 badminton game (shuttlecock game)                               | 28 paddling pool                                   |
| 7 shuttlecock   | 29 sailing boat (yacht, <i>Am.</i> sailboat)       |
| 8 maypole swing   | 30 toy duck  |
| 9 child's bicycle   | 31 pram (baby carriage)                            |
| 10 football (soccer)  | 32 high bar (bar)                                  |
| 11 goal (goalposts)   | 33 go-cart (soap box)                              |
| 12 football   | 34 starter's flag                                  |
| 13 goal scorer  | 35 seesaw  |
| 14 goalkeeper   | 36 robot   |
| 15 skipping ( <i>Am.</i> jumping rope)                            | 37 flying model aeroplanes ( <i>Am.</i> airplanes) |
| 16 skipping rope ( <i>Am.</i> skip rope, jump rope, jumping rope) | 38 model aeroplane ( <i>Am.</i> airplane)          |
| 17 climbing tower   | 39 double swing                                    |
| 18 rubber tyre ( <i>Am.</i> tire) swing                           | 40 swing seat                                      |
| 19 lorry tyre ( <i>Am.</i> truck tire)                            | 41 flying kites                                    |
| 20 bouncing ball  | 42 kite  |
| 21 adventure playground   | 43 tail of the kite                                |
| 22 log ladder   | 44 kite string                                     |

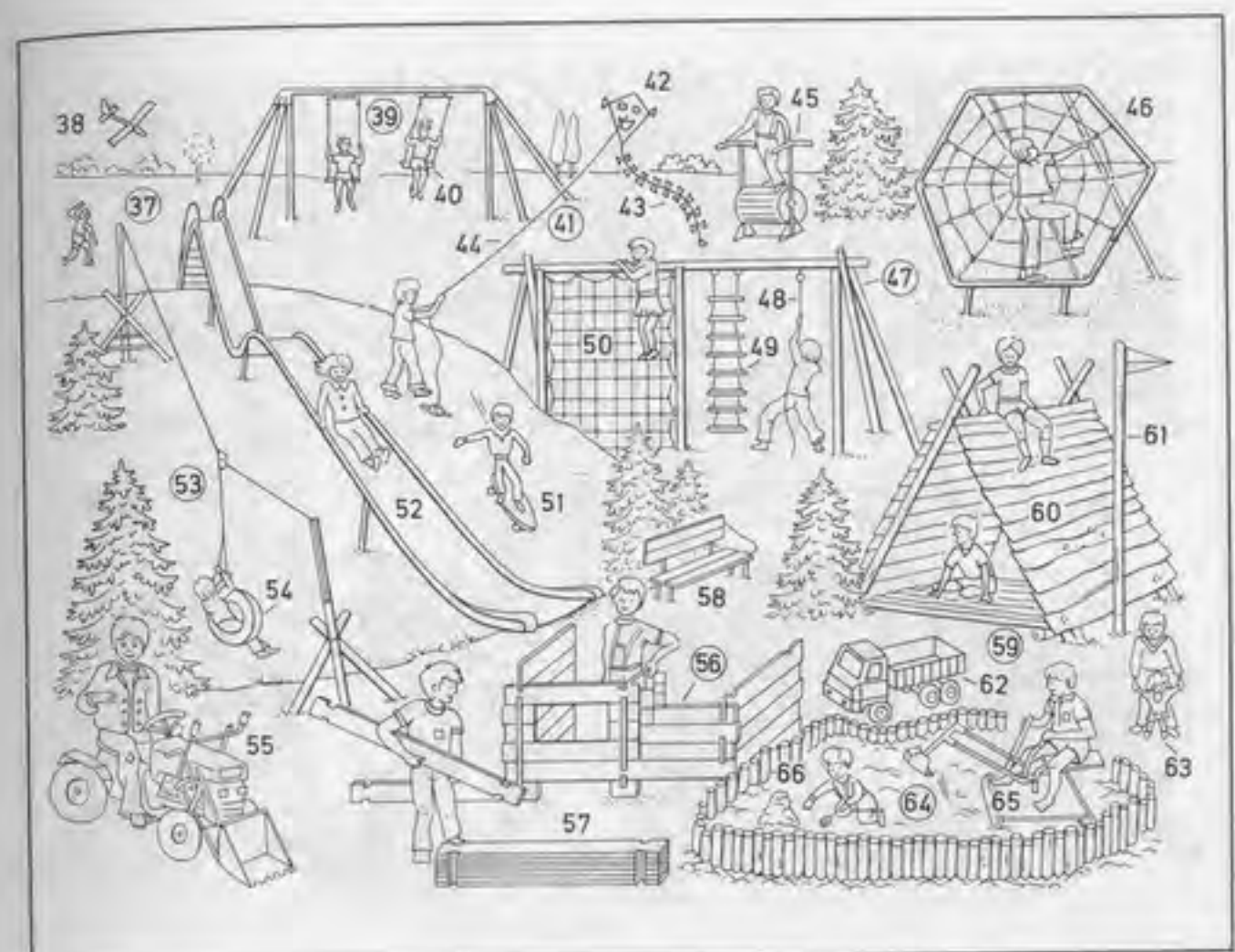

- |   |
|---|
| 47 climbing frame                           |
| 48 climbing rope                            |
| 49 rope ladder                              |
| 50 climbing net                             |
| 51 skateboard                               |
| 52 up-and-down slide                        |
| 53 rubber tyre ( <i>Am.</i> tire) cable car |
| 54 rubber tyre ( <i>Am.</i> tire)           |
| 55 tractor, a pedal car                     |
| 56 den                                      |
| 57 presawn boards                           |
| 58 seat (bench)                             |
| 59 Indian hut                               |
| 60 climbing roof                            |
| 61 flagpole (flagstaff)                     |
| 62 toy lorry ( <i>Am.</i> toy truck)        |
| 63 walking doll                             |
| 64 sandpit ( <i>Am.</i> sandbox)            |
| 65 toy excavator (toy digger)               |
| 66 sandhill                                 |



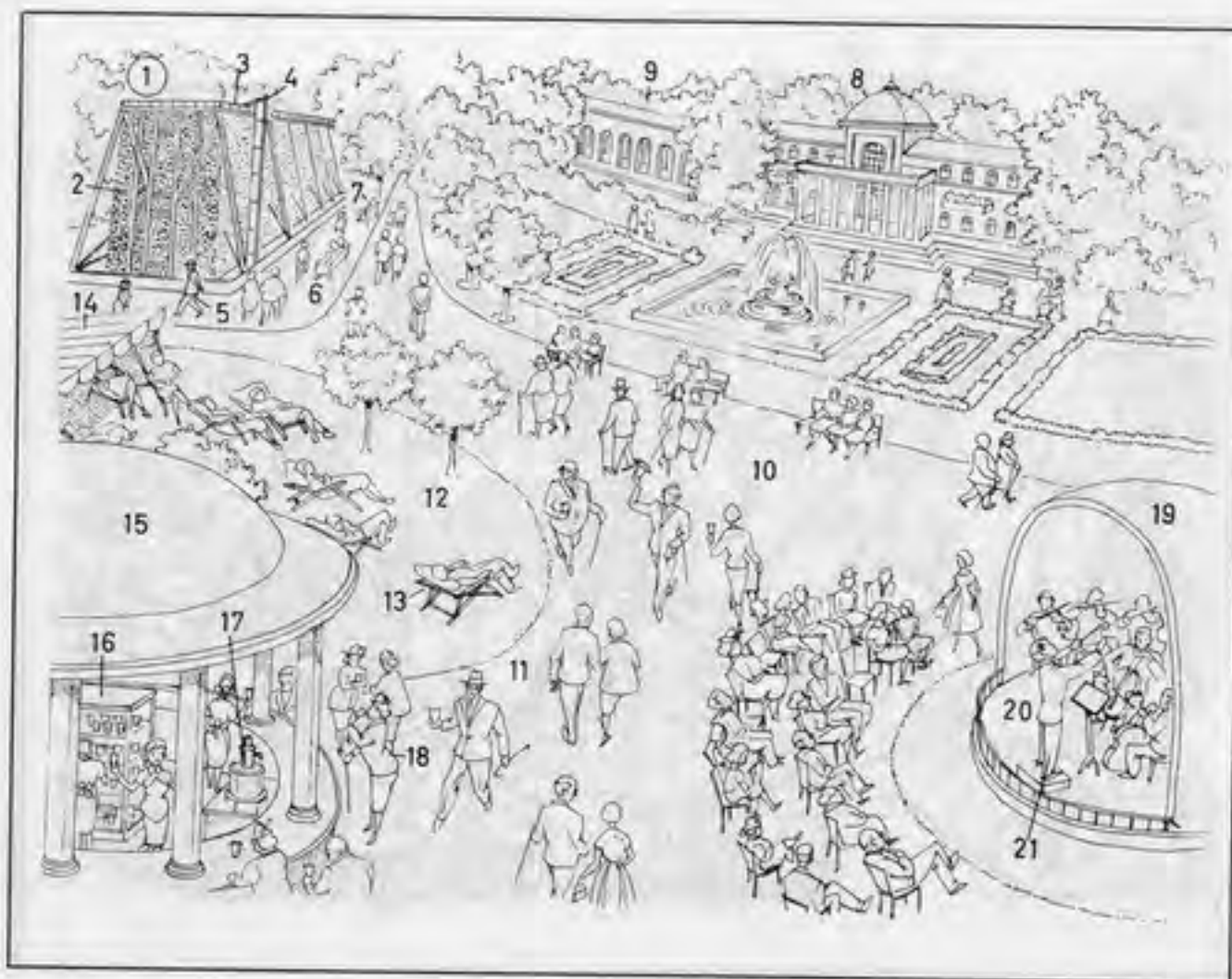

- 1-21 spa gardens  
 1-7 salina (salt works)  
 1 thorn house (graduation house)  
 2 thorns (brushwood)  
 3 brine channels  
 4 brine pipe from the pumping station  
 5 salt works attendant  
 6-7 inhalational therapy  
 6 open-air inhalatorium (outdoor inhalatorium)  
 7 patient inhaling (taking an inhalation)  
 8 hydropathic (pump room) with kursaal (casino)  
 9 colonnade  
 10 spa promenade  
 11 avenue leading to the mineral spring  
 12-14 rest cure  
 12 sunbathing area (lawn)  
 13 deck-chair  
 14 sun canopy  
 15 pump room  
 16 rack for glasses  
 17 tap  
 18 patient taking the waters  
 19 bandstand  
 20 spa orchestra giving a concert  
 21 conductor

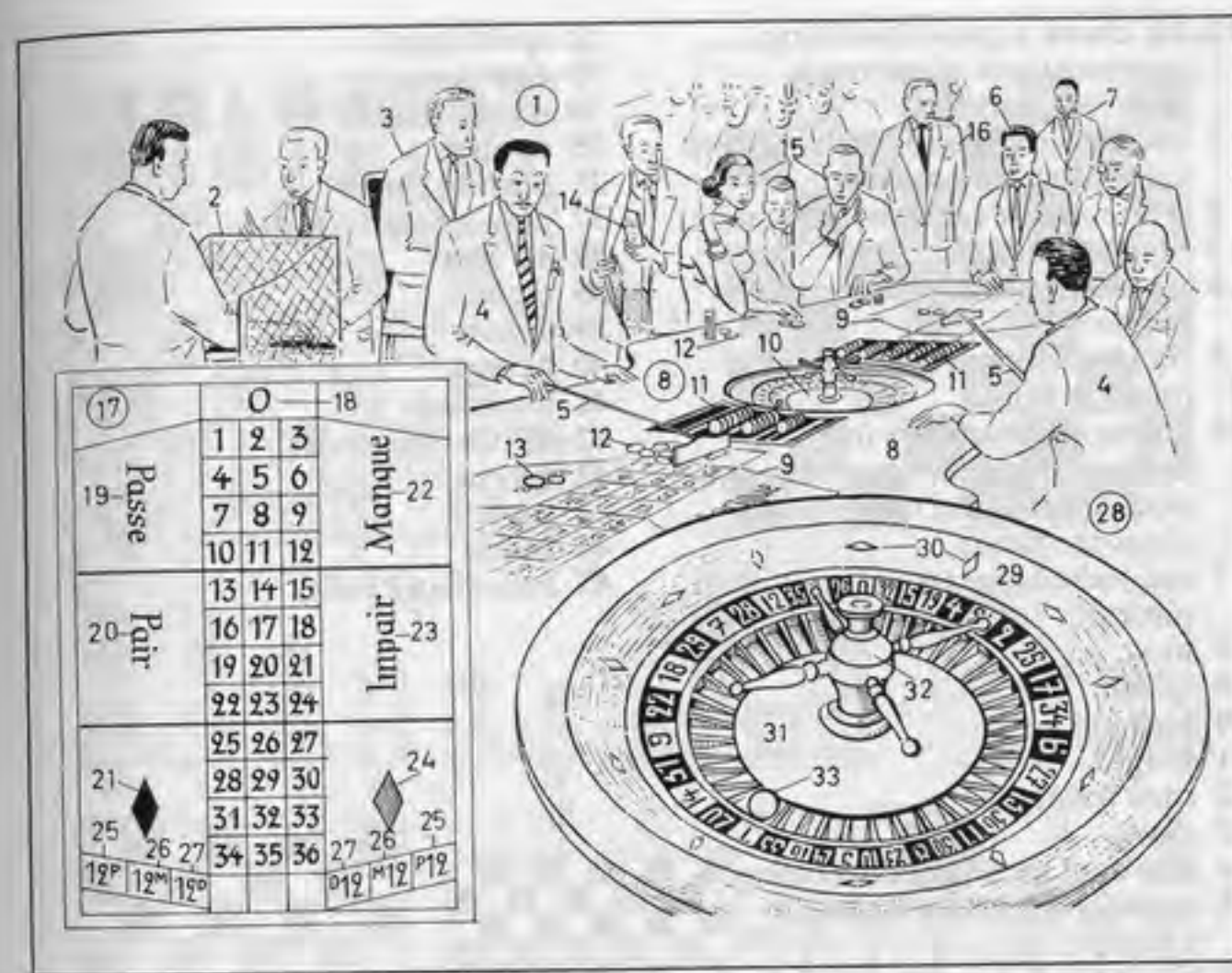

- 1-33 roulette, a game of chance (gambling game)  
 1 gaming room in a casino (gambling casino)  
 2 cash desk  
 3 tourneur (dealer)  
 4 croupier  
 5 rake  
 6 head croupier  
 7 hall manager  
 8 roulette table (gaming table, gambling table)  
 9 roulette layout  
 10 roulette wheel  
 11 bank  
 12 chip (check, plaque)  
 13 stake  
 14 membership card  
 15 roulette player  
 16 private detective (house detective)  
 17 roulette layout  
 18 zero (nought, O)  
 19 passe (high) [numbers 19 to 36]  
 20 pair (even numbers)  
 21 noir (black)  
 22 manque (low) [numbers 1 to 18]  
 23 impair [odd numbers]  
 24 rouge (red)  
 25 douze premier (first dozen) [numbers 1 to 12]  
 26 douze milieu (second dozen) [numbers 13 to 24]  
 27 douze dernier (third dozen) [numbers 25 to 36]  
 28 roulette wheel (roulette)  
 29 roulette bowl  
 30 fret (separator)  
 31 revolving disc (disk) showing numbers 0 to 36  
 32 spin  
 33 roulette ball



- 1-16 chess, a game involving combinations of moves, a positional game
- 1 chessboard (board) with the men (chessmen) in position
- 2 white square (chessboard square)
- 3 black square
- 4 white chessmen (white pieces) [white = W]
- 5 black chessmen (black pieces) [black = B]
- 6 letters and numbers for designating chess squares in the notation of chess moves and chess problems
- 7 individual chessmen (individual pieces)
- 8 king
- 9 queen
- 10 bishop
- 11 knight
- 12 rook (castle)
- 13 pawn
- 14 moves of the individual pieces
- 15 mate (checkmate), a mate by knight
- 16 chess clock, a double clock for chess matches (chess championships)
- 17-19 draughts (*Am.* checkers)
- 17 draughtboard (*Am.* checkerboard)
- 18 white draughtsman (*Am.* checker, checkerman); *also:* piece for backgammon and nine men's morris
- 19 black draughtsman (*Am.* checker, checkerman)
- 20 salta
- 21 salta piece
- 22 backgammon board
- 23-25 nine men's morris
- 23 nine men's morris board
- 24 mill
- 25 double mill
- 26-28 halma
- 26 halma board
- 27 yard (camp, corner)
- 28 halma pieces (halma men) of various colours (*Am.* colors)
- 29 dice (dicing)
- 30 dice cup
- 31 dice

- 32 spots (pips)
- 33 dominoes
- 34 domino (tile)
- 35 double
- 36 playing cards
- 37 playing card (card)
- 38-45 suits
- 38 clubs
- 39 spades
- 40 hearts
- 41 diamonds
- 42-45 German suits
- 42 acorns
- 43 leaves
- 44 hearts
- 45 bells (hawkbells)

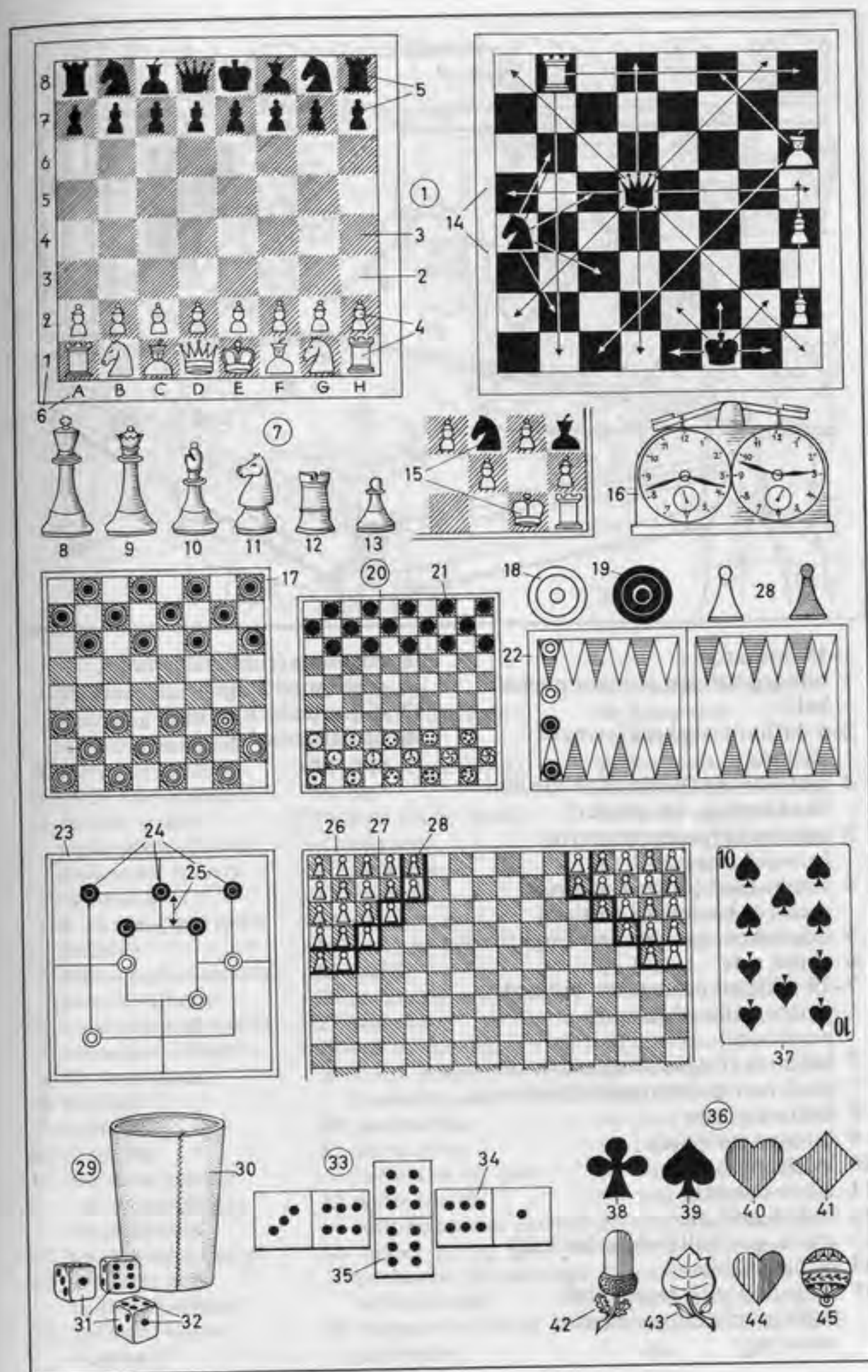



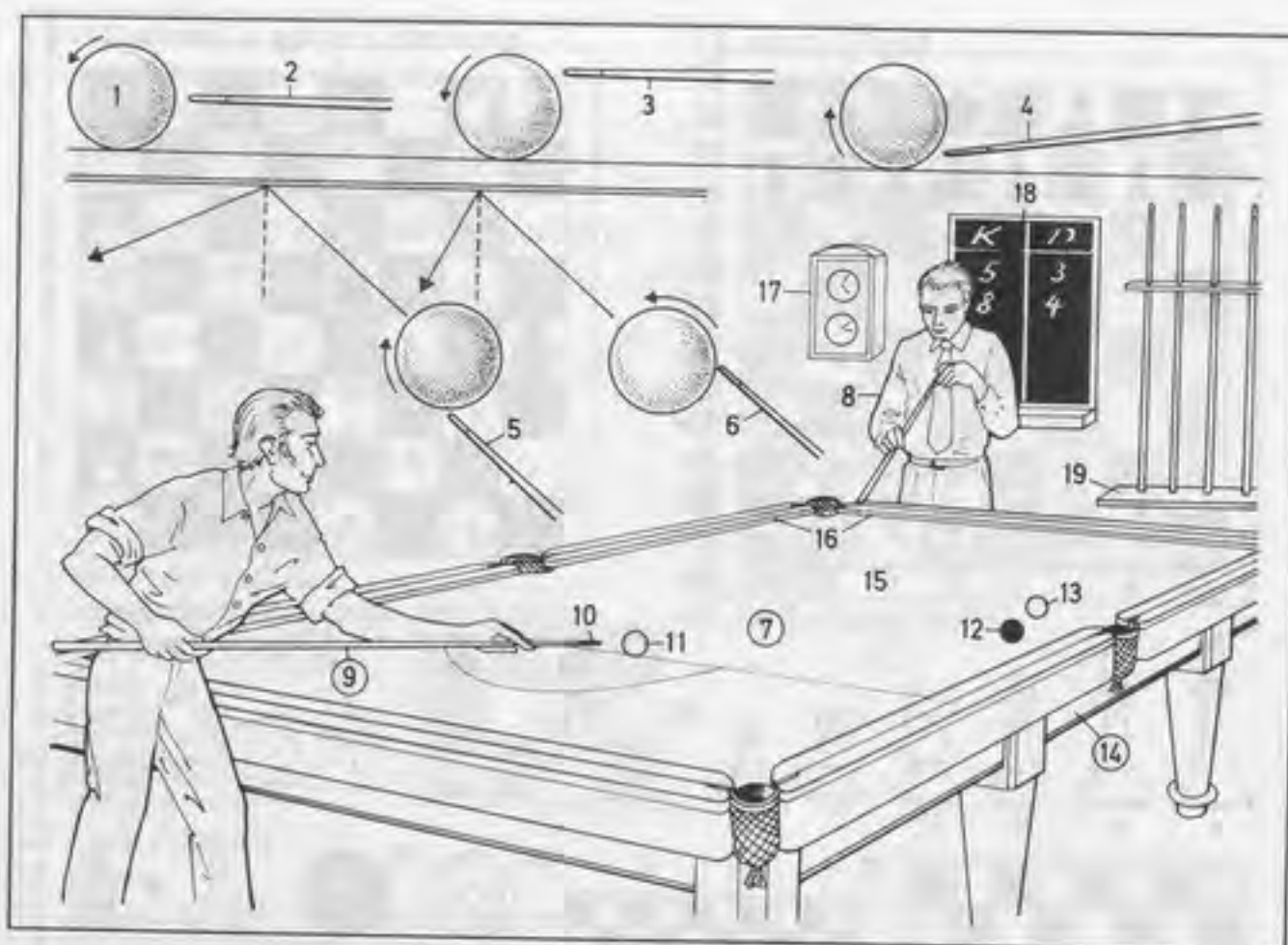

## 1-19 billiards

- 1 billiard ball, an ivory or plastic ball
- 2-6 billiard strokes (forms of striking)
  - 2 plain stroke (hitting the cue ball dead centre, *Am.* center)
  - 3 top stroke [promotes extra forward rotation]
  - 4 screw-back [imparts a direct recoil or backward motion]
  - 5 side (running side, *Am.* English)
  - 6 check side
- 7-19 billiard room (*Am.* billiard parlor, billiard saloon, poolroom)
- 7 billiards (English billiards); *sim.*: pool, carom (carrom) billiards
- 8 billiard player
- 9 billiard cue (cue)
- 10 leather cue tip
- 11 white cue ball
- 12 red object ball
- 13 white spot ball (white dot ball)
- 14 billiard table
- 15 table bed with green cloth (billiard cloth, green baize covering)

- 16 cushions (rubber cushions, cushioned ledge)
- 17 billiard clock, a timer
- 18 billiard marker
- 19 cue rack



## 1-59 camp site

- (camping site, *Am.* campground)
- 1 reception (office)
- 2 camp site attendant
- 3 folding trailer (collapsible caravan, collapsible trailer)
- 4 hammock
- 5-6 washing and toilet facilities
- 5 toilets and washrooms (*Am.* lavatories)
- 6 washbasins and sinks
- 7 bungalow (chalet)
- 8-11 scout camp
- 8 bell tent
- 9 pennon
- 10 camp fire
- 11 boy scout (scout)
- 12 sailing boat (yacht, *Am.* sailboat)
- 13 landing stage (jetty)
- 14 inflatable boat (inflatable dinghy)
- 15 outboard motor (outboard)
- 16 trimaran
- 17 thwart (oarsman's bench)
- 18 rowlock (oarlock)
- 19 oar
- 20 boat trailer (boat carriage)
- 21 ridge tent
- 22 flysheet
- 23 guy line (guy)
- 24 tent peg (peg)
- 25 mallet
- 26 groundsheet ring
- 27 bell end
- 28 erected awning
- 29 storm lantern, a paraffin lamp
- 30 sleeping bag
- 31 air mattress (inflatable air-bed)
- 32 water carrier (drinking water carrier)
- 33 double-burner gas cooker for propane gas or butane gas
- 34 propane or butane gas bottle
- 35 pressure cooker
- 36 frame tent
- 37 awning
- 38 tent pole
- 39 wheelarch doorway
- 40 mesh ventilator
- 41 transparent window
- 42 pitch number
- 43 folding camp chair
- 44 folding camp table
- 45 camping tableware
- 46 camper
- 47 charcoal grill (barbecue)
- 48 charcoal
- 49 bellows
- 50 roof rack
- 51 roof lashing
- 52 caravan (*Am.* trailer)
- 53 box for gas bottle
- 54 jockey wheel
- 55 drawbar coupling
- 56 roof ventilator
- 57 caravan awning
- 58 inflatable igloo tent
- 59 camp bed (*Am.* camp cot)



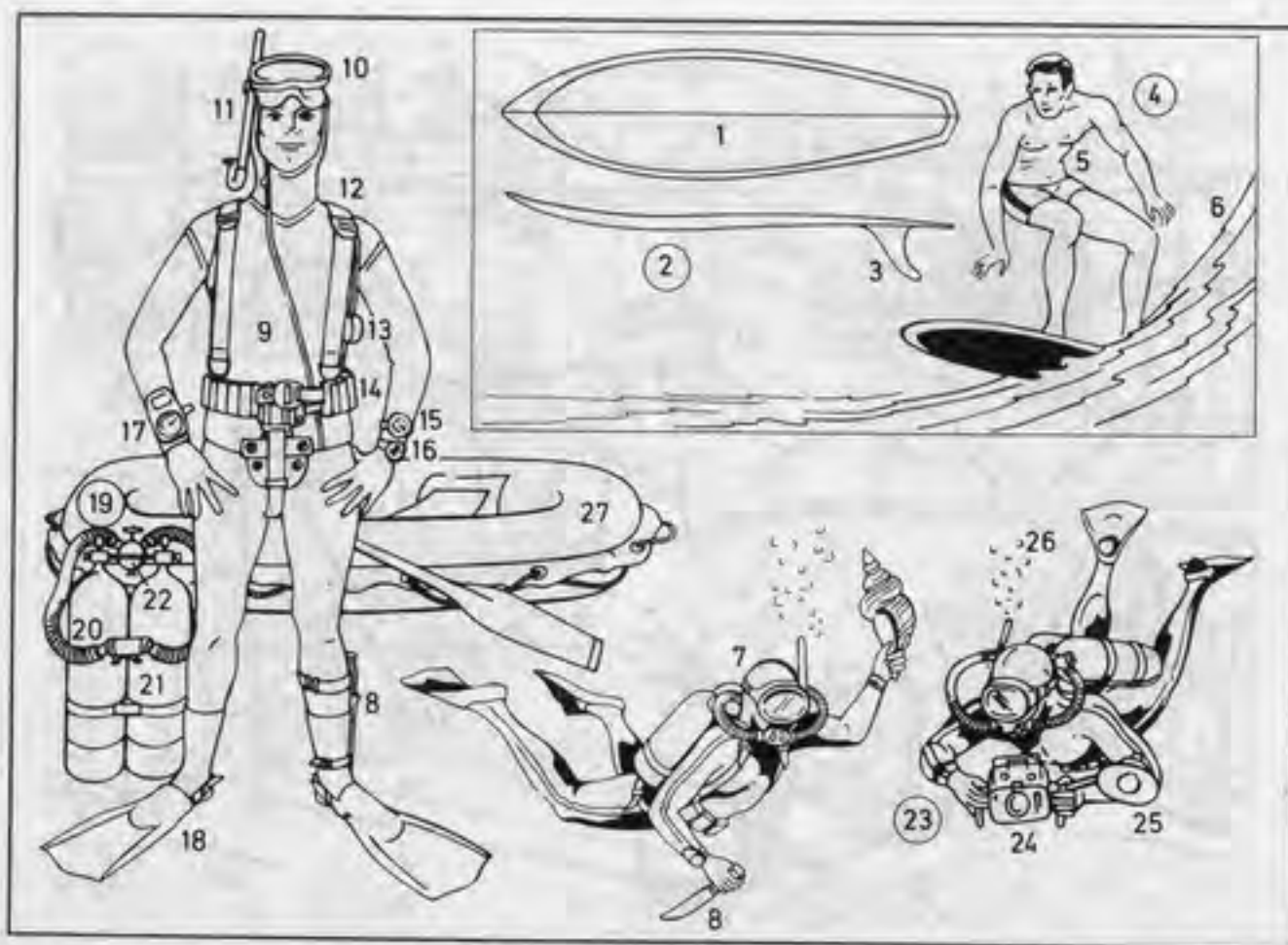

- 1-6 surf riding (surfing)  
 1 plan view of surfboard  
 2 section of surfboard  
 3 skeg (stabilizing fin)  
 4 big wave riding  
 5 surfboarder (surfer)  
 6 breaker  
 7-27 skin diving (underwater swimming)  
 7 skin diver (underwater swimmer)  
 8-22 underwater swimming set  
 8 knife  
 9 neoprene wetsuit  
 10 diving mask (face mask, mask), a pressure-equalizing mask  
 11 snorkel (schnorkel)  
 12 harness of diving apparatus  
 13 compressed-air pressure gauge (Am. gage)  
 14 weight belt  
 15 depth gauge (Am. gage)  
 16 waterproof watch for checking duration of dive  
 17 decometer for measuring stages of ascent  
 18 fin (flipper)  
 19 diving apparatus (also: aqualung, scuba), with two cylinders (bottles)  
 20 two-tube demand regulator  
 21 compressed-air cylinder (compressed-air bottle)  
 22 on/off valve  
 23 underwater photography  
 24 underwater camera  
 25 underwater flashlight  
 26 exhaust bubbles  
 27 inflatable boat (inflatable dinghy)



- 1 lifesaver (lifeguard)  
 2 lifeline  
 3 lifebelt (lifebuoy)  
 4 storm signal  
 5 time ball  
 6 warning sign  
 7 tide table, a notice board showing times of low tide and high tide  
 8 board showing water and air temperature  
 9 bathing platform  
 10 pennon staff  
 11 pennon  
 12 paddle boat (peddle boat)  
 13 surf riding (surfing) behind motorboat  
 14 surfboarder (surfer)  
 15 surfboard  
 16 water ski  
 17 inflatable beach mattress  
 18 beach ball  
 19-23 beachwear  
 19 beach suit  
 20 beach hat  
 21 beach jacket  
 22 beach trousers  
 23 beach shoe (bathing shoe)  
 24 beach bag  
 25 bathing gown (bathing wrap)  
 26 bikini (ladies' two-piece bathing suit)  
 27 bikini bottom  
 28 bikini top  
 29 bathing cap (swimming cap)  
 30 bather  
 31 deck tennis (quoits)  
 32 rubber ring (quoit)  
 33 inflatable rubber animal  
 34 beach attendant  
 35 sandcastle  
 36 roofed wicker beach chair  
 37 underwater swimmer  
 38 diving goggles  
 39 snorkel (schnorkel)  
 40 hand harpoon (fish spear, fish lance)  
 41 fin (flipper) for diving (for underwater swimming)  
 42 bathing suit (swimsuit)  
 43 bathing trunks (swimming trunks)  
 44 bathing cap (swimming cap)  
 45 beach tent, a ridge tent  
 46 lifeguard station



- 1-9 swimming pool with artificial waves, an indoor pool
- 1 artificial waves
- 2 beach area
- 3 edge of the pool
- 4 swimming pool attendant (pool attendant, swimming bath attendant)
- 5 sun bed
- 6 lifebelt
- 7 water wings
- 8 bathing cap
- 9 channel to outdoor mineral bath
- 10 solarium
- 11 sunbathing area
- 12 sun bather
- 13 sun ray lamp
- 14 bathing towel
- 15 nudist sunbathing area
- 16 nudist (naturist)
- 17 screen (fence)
- 18 sauna (mixed sauna)
- 19 wood panelling (Am. paneling)
- 20 tiered benches
- 21 sauna stove
- 22 stones
- 23 hygrometer
- 24 thermometer
- 25 towel
- 26 water tub for moistening the stones in the stove
- 27 birch rods (birches) for beating the skin
- 28 cooling room for cooling off (cooling down) after the sauna
- 29 lukewarm shower
- 30 cold bath
- 31 hot whirlpool (underwater massage bath)
- 32 step into the bath
- 33 massage bath
- 34 jet blower
- 35 hot whirlpool [diagram]
- 36 section of the bath
- 37 step
- 38 circular seat
- 39 water extractor
- 40 water jet pipe
- 41 air jet pipe

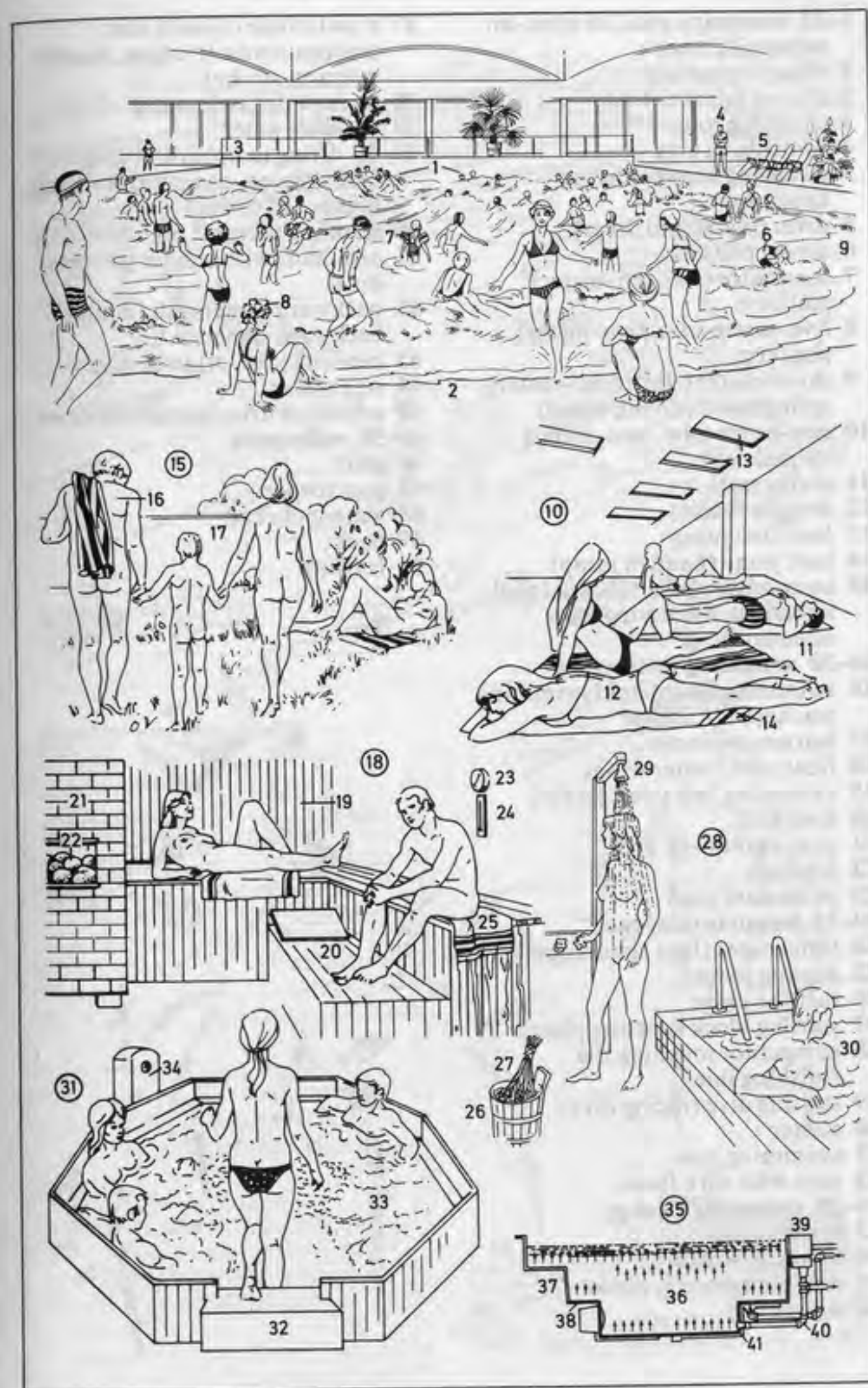



- 1-32 swimming pool, an open-air swimming pool
- 1 changing cubicle
  - 2 shower (shower bath)
  - 3 changing room
  - 4 sunbathing area
  - 5-10 diving boards (diving apparatus)
  - 5 diver (highboard diver)
  - 6 diving platform
  - 7 ten-metre (*Am.* ten-meter) platform
  - 8 five-metre (*Am.* five-meter) platform
  - 9 three-metre (*Am.* three-meter) springboard (diving board)
  - 10 one-metre (*Am.* one-meter) springboard
  - 11 diving pool
  - 12 straight header
  - 13 feet-first jump
  - 14 tuck jump (haunch jump)
  - 15 swimming pool attendant (pool attendant, swimming bath attendant)
  - 16-20 swimming instruction
  - 16 swimming instructor (swimming teacher)
  - 17 learner-swimmer
  - 18 float; *sim.*: water wings
  - 19 swimming belt (cork jacket)
  - 20 land drill
  - 21 non-swimmers' pool
  - 22 footbath
  - 23 swimmers' pool
  - 24-32 freestyle relay race
  - 24 timekeeper (lane timekeeper)
  - 25 placing judge
  - 26 turning judge
  - 27 starting block (starting place)
  - 28 competitor touching the finishing line
  - 29 starting dive (racing dive)
  - 30 starter
  - 31 swimming lane
  - 32 rope with cork floats
  - 33-39 swimming strokes
  - 33 breaststroke
  - 34 butterfly stroke
  - 35 dolphin butterfly stroke
  - 36 side stroke

- 37 crawl stroke (crawl); *sim.*: trudgen stroke (trudgen, double overarm stroke)
- 38 underwater swimming
- 39 treading water
- 40-45 diving (acrobatic diving, fancy diving, competitive diving, highboard diving)
- 40 standing take-off pike dive
- 41 one-half twist isander (reverse dive)
- 42 backward somersault (double backward somersault)
- 43 running take-off twist dive
- 44 screw dive
- 45 armstand dive (handstand dive)
- 46-50 water polo
- 46 goal
- 47 goalkeeper
- 48 water polo ball
- 49 back
- 50 forward

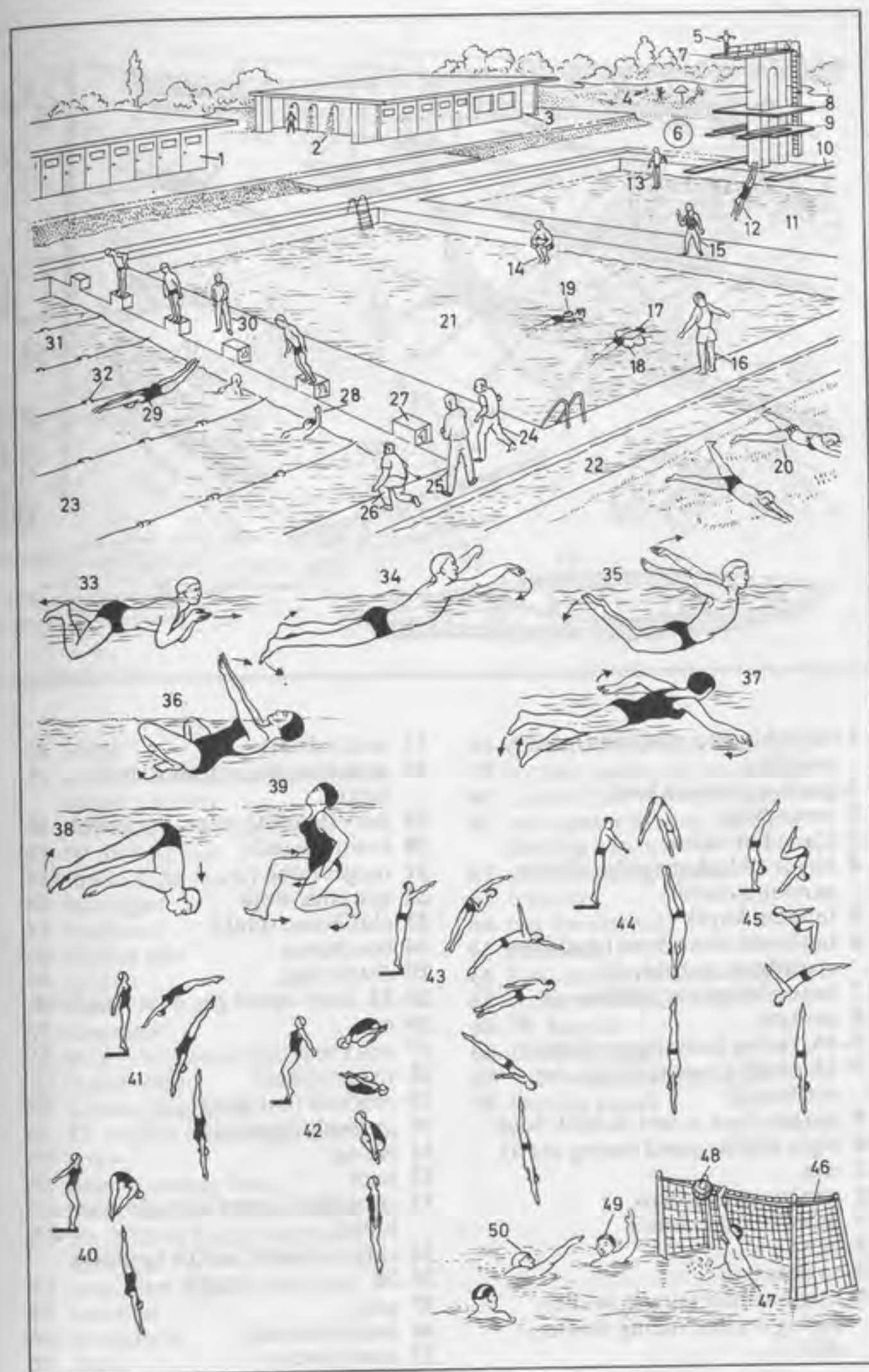



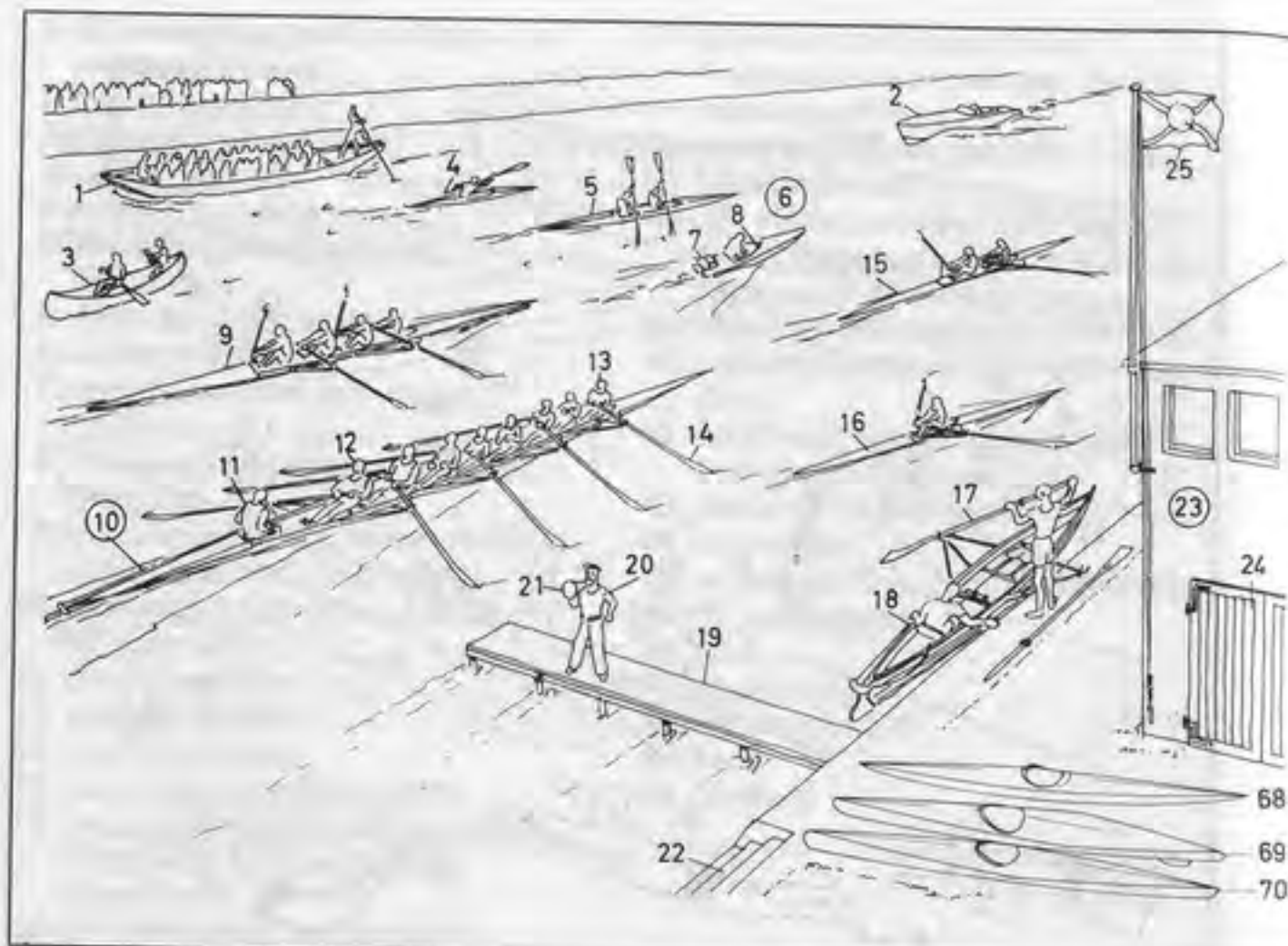

1-18 taking up positions for the regatta

- 1 punt, a pleasure boat
- 2 motorboat
- 3 Canadian canoe
- 4 kayak (Alaskan canoe, slalom canoe), a canoe
- 5 tandem kayak
- 6 outboard motorboat (outboard speedboat, outboard)
- 7 outboard motor (outboard)
- 8 cockpit
- 9-16 racing boats (sportsboats)
- 9-15 shells (rowing boats, *Am.* rowboats)
- 9 coxless four, a carvel-built boat
- 10 eight (eight-oared racing shell)
- 11 cox
- 12 stroke, an oarsman
- 13 bow ('number one')
- 14 oar
- 15 coxless pair
- 16 single sculler (single skuller, racing sculler, racing skuller, skiff)

- 17 scull (skull)
- 18 coxed single, a clinker-built single
- 19 jetty (landing stage, mooring)
- 20 rowing coach
- 21 megaphone
- 22 quayside steps
- 23 clubhouse (club)
- 24 boathouse
- 25 club's flag
- 26-33 four-oared gig, a touring boat
- 26 oar
- 27 cox's seat
- 28 thwart (seat)
- 29 rowlock (oarlock)
- 30 gunwale (gunnel)
- 31 rising
- 32 keel
- 33 skin (shell, outer skin) [clinker-built]
- 34 single-bladed paddle (paddle)
- 35-38 oar (scull, skull)
- 35 grip
- 36 leather sheath
- 37 shaft (neck)

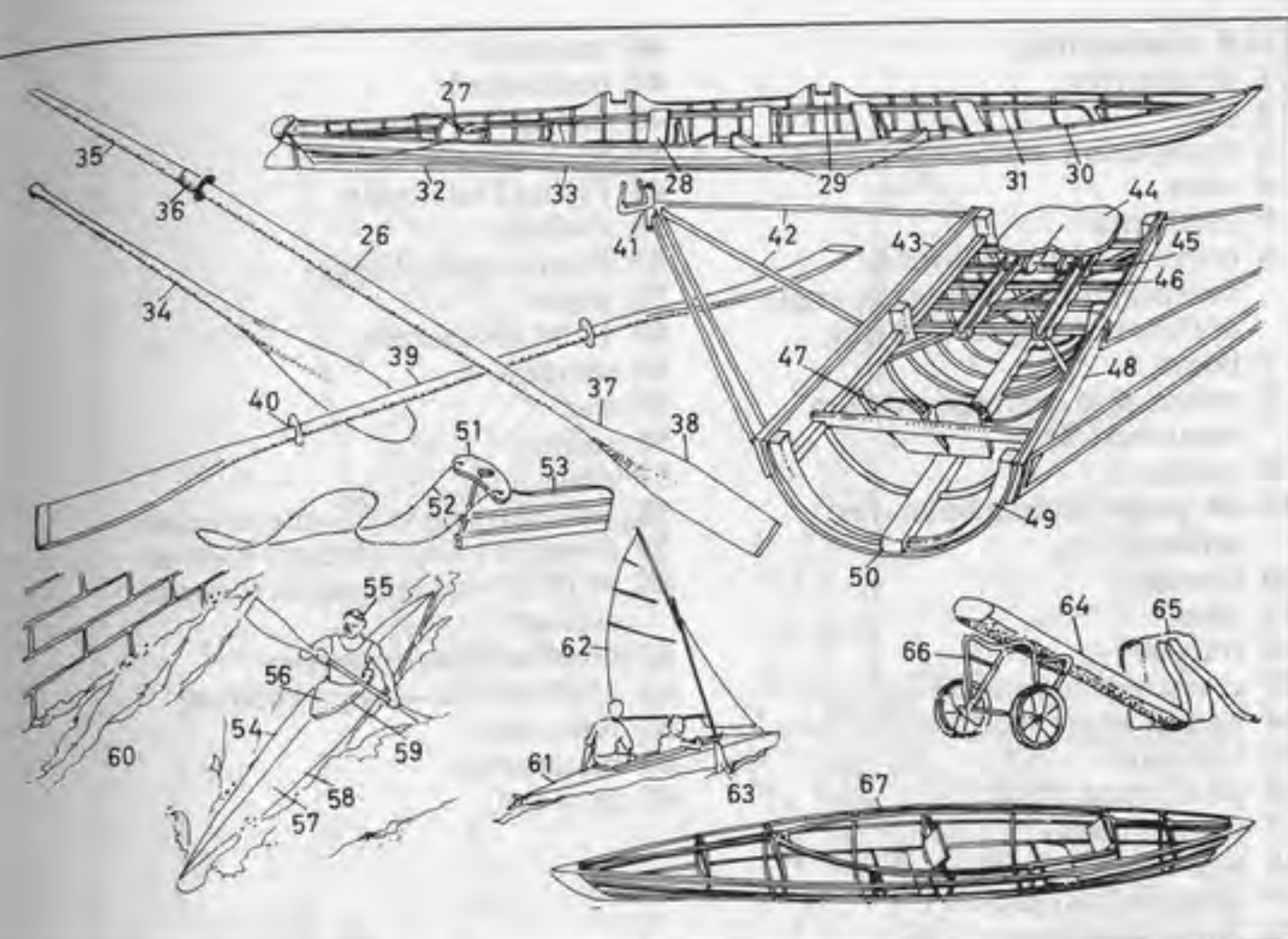

- 38 blade
- 39 double-bladed paddle (double-ended paddle)
- 40 drip ring
- 41-50 sliding seat
- 41 rowlock (oarlock)
- 42 outrigger
- 43 saxboard
- 44 sliding seat
- 45 runner
- 46 strut
- 47 stretcher
- 48 skin (shell, outer skin)
- 49 frame (rib)
- 50 kelson (keelson)
- 51-53 rudder (steering rudder)
- 51 yoke
- 52 lines (steering lines)
- 53 blade (rudder blade, rudder)
- 54-66 folding boats (foldboats, canoes)
- 54 one-man kayak
- 55 canoeist
- 56 spraydeck
- 57 deck

- 58 rubber-covered canvas hull
- 59 cockpit coaming (coaming)
- 60 channel for rafts alongside weir
- 61 two-seater folding kayak, a touring kayak
- 62 sail of folding kayak
- 63 leeboard
- 64 bag for the rods
- 65 rucksack
- 66 boat trailer (boat carriage)
- 67 frame of folding kayak
- 68-70 kayaks
- 68 Eskimo kayak
- 69 wild-water racing kayak
- 70 touring kayak



- 1-9 windsurfing
- 1 windsurfer
- 2 sail
- 3 transparent window (window)
- 4 mast
- 5 surfboard
- 6 universal joint (movable bearing) for adjusting the angle of the mast and for steering
- 7 boom
- 8 retractable centreboard (*Am.* centerboard)
- 9 rudder
- 10-48 yacht (sailing boat, *Am.* sailboat)
- 10 foredeck
- 11 mast
- 12 trapeze
- 13 crosstrees (spreader)
- 14 hound
- 15 forestay
- 16 jib (Genoa jib)
- 17 jib downhaul
- 18 side stay (shroud)
- 19 lanyard (bottlescrew)
- 20 foot of the mast
- 21 kicking strap (vang)
- 22 jam cleat
- 23 foresheet (jib sheet)
- 24 centreboard (*Am.* centerboard) case
- 25 bitt
- 26 centreboard (*Am.* centerboard)
- 27 traveller (*Am.* traveler)
- 28 mainsheet
- 29 fairlead
- 30 toestraps (hiking straps)
- 31 tiller extension (hiking stick)
- 32 tiller
- 33 rudderhead (rudder stock)
- 34 rudder blade (rudder)
- 35 transom
- 36 drain plug
- 37 gooseneck
- 38 window
- 39 boom
- 40 foot
- 41 clew
- 42 luff (leading edge)
- 43 leech pocket (batten cleat, batten pocket)
- 44 batten
- 45 leech (trailing edge)

- 46 mainsail
- 47 headboard
- 48 racing flag (burgee)
- 49-65 yacht classes
- 49 Flying Dutchman
- 50 O-Joller
- 51 Finn dinghy (Finn)
- 52 pirate
- 53 12.00 m<sup>2</sup> sharpie
- 54 tempest
- 55 star
- 56 soling
- 57 dragon
- 58 5.5-metre (*Am.* 5.5-meter) class
- 59 6-metre (*Am.* 6-meter) R-class
- 60 30.00 m<sup>2</sup> cruising yacht (coastal cruiser)
- 61 30.00 m<sup>2</sup> dinghy cruiser
- 62 25.00 m<sup>2</sup> one-design keelboat
- 63 KR-class
- 64 catamaran
- 65 twin hull

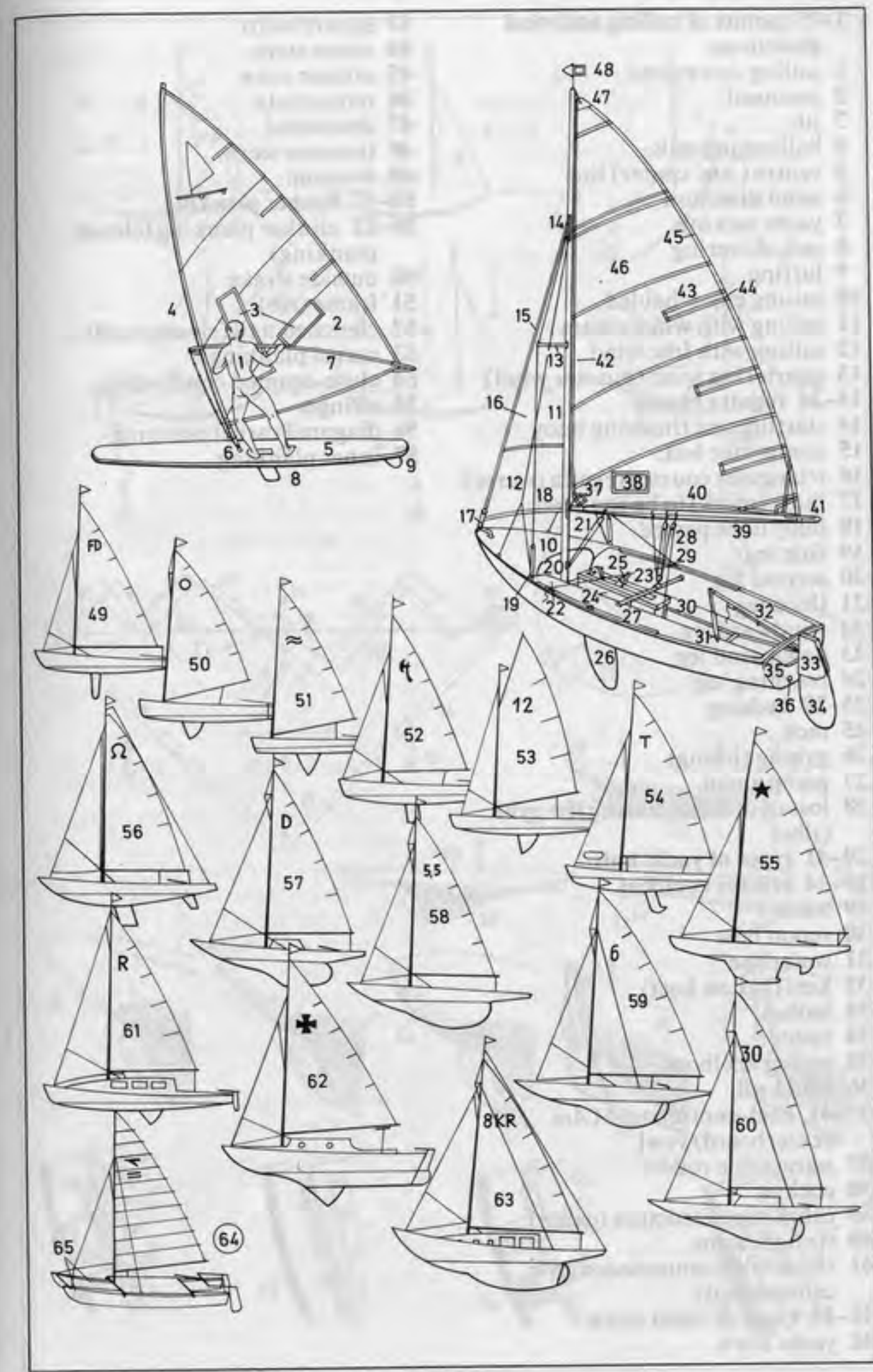



## 1-13 points of sailing and wind directions

- 1 sailing downwind
  - 2 mainsail
  - 3 jib
  - 4 ballooning sails
  - 5 centre (*Am.* center) line
  - 6 wind direction
  - 7 yacht tacking
  - 8 sail, shivering
  - 9 luffing
  - 10 sailing close-hauled
  - 11 sailing with wind abeam
  - 12 sailing with free wind
  - 13 quartering wind (quarter wind)
- 14-24 regatta course**
- 14 starting and finishing buoy
  - 15 committee boat
  - 16 triangular course (regatta course)
  - 17 buoy (mark) to be rounded
  - 18 buoy to be passed
  - 19 first leg
  - 20 second leg
  - 21 third leg
  - 22 windward leg
  - 23 downwind leg
  - 24 reaching leg
- 25-28 tacking**
- 25 tack
  - 26 gybing (jibing)
  - 27 going about
  - 28 loss of distance during the gybe (jibe)

## 29-41 types of yacht hull

- 29-34 cruiser keelboat**
- 29 stern
  - 30 spoon bow
  - 31 waterline
  - 32 keel (ballast keel)
  - 33 ballast
  - 34 rudder
- 35 racing keelboat**
- 36 lead keel
- 37-41 keel-centreboard (*Am.* centerboard) yawl**
- 37 retractable rudder
  - 38 cockpit
  - 39 cabin superstructure (cabin)
  - 40 straight stem
  - 41 retractable centreboard (*Am.* centerboard)

## 42-49 types of yacht stern

- 42 yacht stern

- 43 square stern
  - 44 canoe stern
  - 45 cruiser stern
  - 46 name plate
  - 47 deadwood
  - 48 transom stern
  - 49 transom
- 50-57 timber planking**
- 50-52 clinker planking (clench planking)**
- 50 outside strake
  - 51 frame (rib)
  - 52 clenched nail (riveted nail)
- 53 carvel planking**
- 54 close-seamed construction**
- 55 stringer**
- 56 diagonal carvel planking**
- 57 inner planking**

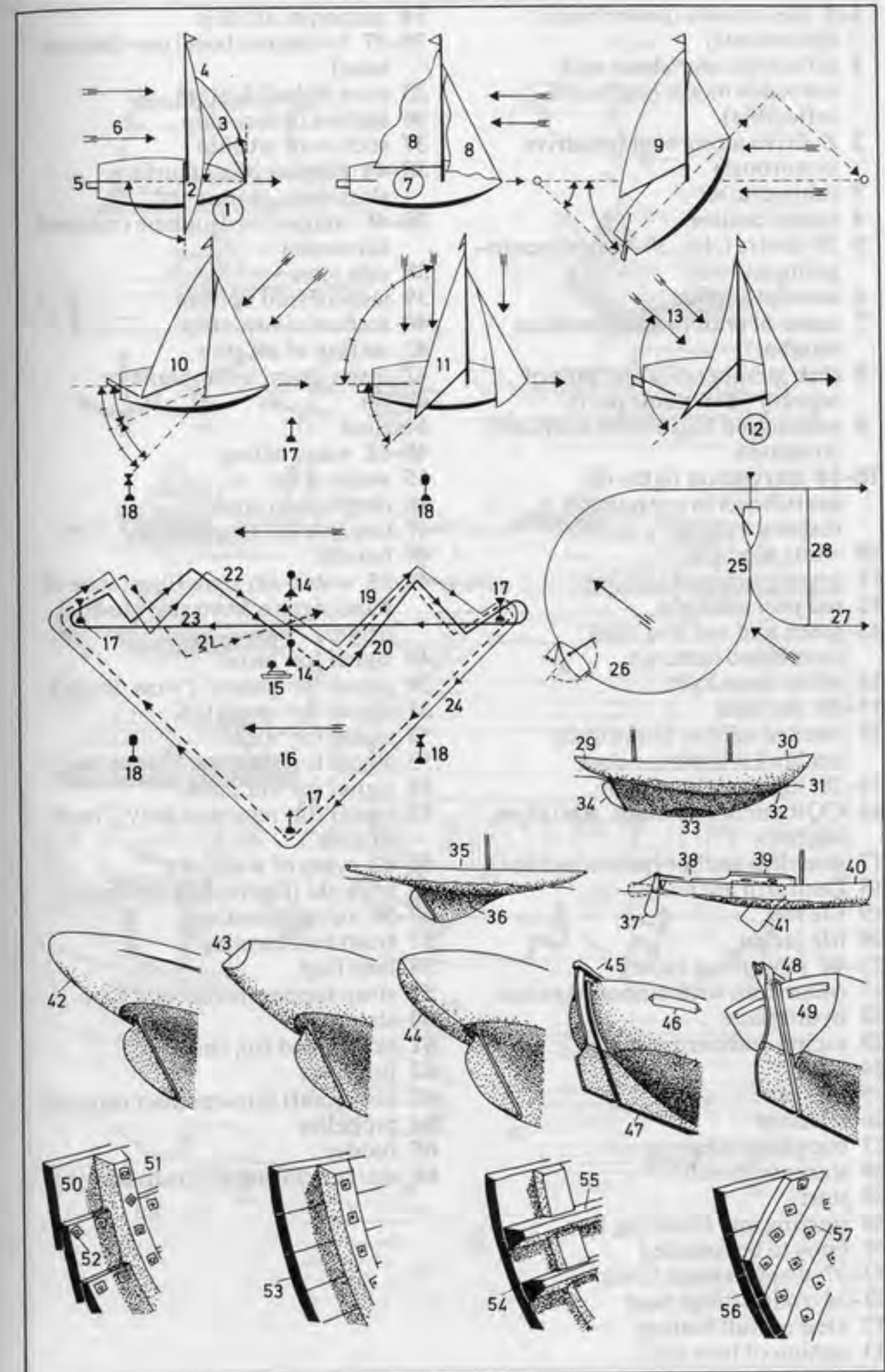



- 1-5 motorboats (powerboats, sportsboats)  
 1 inflatable sportsboat with outboard motor (outboard inflatable)  
 2 Z-drive motorboat (outdrive motorboat)  
 3 cabin cruiser  
 4 motor cruiser  
 5 30-metre (*Am.* 30-meter) ocean-going cruiser  
 6 association flag  
 7 name of craft (*or:* registration number)  
 8 club membership and port of registry (*Am.* home port)  
 9 association flag on the starboard crossstreets  
 10-14 navigation lights of sportsboats in coastal and inshore waters  
 10 white top light  
 11 green starboard sidelight  
 12 red port sidelight  
 13 green and red bow light (combined lantern)  
 14 white stern light  
 15-18 anchors  
 15 stocked anchor (Admiralty anchor), a bower anchor  
 16-18 lightweight anchor  
 16 CQR anchor (plough, *Am.* plow, anchor)  
 17 stockless anchor (patent anchor)  
 18 Danforth anchor  
 19 life raft  
 20 life jacket  
 21-44 powerboat racing  
 21 catamaran with outboard motor  
 22 hydroplane  
 23 racing outboard motor  
 24 tiller  
 25 fuel pipe  
 26 transom  
 27 buoyancy tube  
 28 start and finish  
 29 start  
 30 starting and finishing line  
 31 buoy to be rounded  
 32-37 displacement boats  
 32-34 round-bilge boat  
 32 view of hull bottom  
 33 section of fore ship  
 34 section of aft ship  
 35-37 V-bottom boat (vee-bottom boat)  
 35 view of hull bottom  
 36 section of fore ship  
 37 section of aft ship  
 38-44 planing boats (surface skimmers, skimmers)  
 38-41 stepped hydroplane (stepped skimmer)  
 38 side view  
 39 view of hull bottom  
 40 section of fore ship  
 41 section of aft ship  
 42 three-point hydroplane  
 43 fin  
 44 float  
 45-62 water skiing  
 45 water skier  
 46 deep-water start  
 47 tow line (towing line)  
 48 handle  
 49-55 water-ski signalling (code of hand signals from skier to boat driver)  
 49 signal for 'faster'  
 50 signal for 'slower' ('slow down')  
 51 signal for 'speed OK'  
 52 signal for 'turn'  
 53 signal for 'stop'  
 54 signal for 'cut motor'  
 55 signal for 'return to jetty' ('back to dock')  
 56-62 types of water ski  
 56 trick ski (figure ski), a monoski  
 57-58 rubber binding  
 57 front foot binding  
 58 heel flap  
 59 strap support for second foot  
 60 slalom ski  
 61 skeg (fixed fin, fin)  
 62 jump ski  
 63 hovercraft (air-cushion vehicle)  
 64 propeller  
 65 rudder  
 66 skirt enclosing air cushion

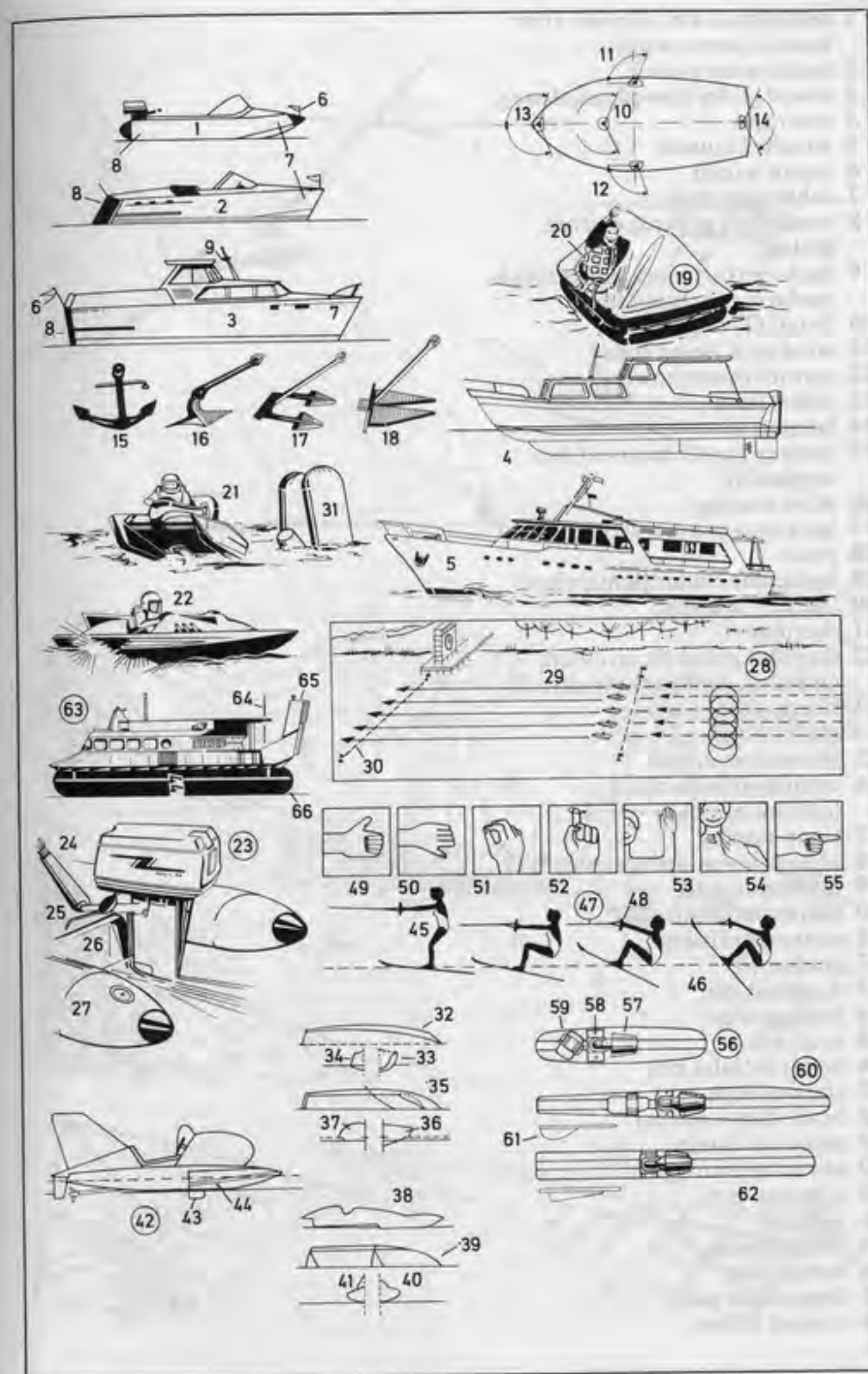



- 1 aeroplane (*Am.* airplane) tow launch (aerotowing)
- 2 tug (towing plane)
- 3 towed glider (towed sailplane)
- 4 tow rope
- 5 winched launch
- 6 motor winch
- 7 cable parachute
- 8 motorized glider (powered glider)
- 9 high-performance glider (high-performance sailplane)
- 10 T-tail (T-tail unit)
- 11 wind sock (wind cone)
- 12 control tower (tower)
- 13 glider field
- 14 hangar
- 15 runway for aeroplanes (*Am.* airplanes)
- 16 wave soaring
- 17 lee waves (waves, wave system)
- 18 rotor
- 19 lenticular clouds (lenticulars)
- 20 thermal soaring
- 21 thermal
- 22 cumulus cloud (heap cloud, cumulus, woolpack cloud)
- 23 storm-front soaring
- 24 storm front
- 25 frontal upcurrent
- 26 cumulonimbus cloud (cumulonimbus)
- 27 slope soaring
- 28 hill upcurrent (orographic lift)
- 29 multispar wing
- 30 main spar, a box spar
- 31 connector fitting
- 32 anchor rib
- 33 diagonal spar
- 34 leading edge
- 35 main rib
- 36 nose rib (false rib)
- 37 trailing edge
- 38 brake flap (spoiler)
- 39 torsional clamp
- 40 covering (skin)
- 41 aileron
- 42 wing tip
- 43 hang gliding
- 44 hang glider
- 45 hang glider pilot
- 46 control frame

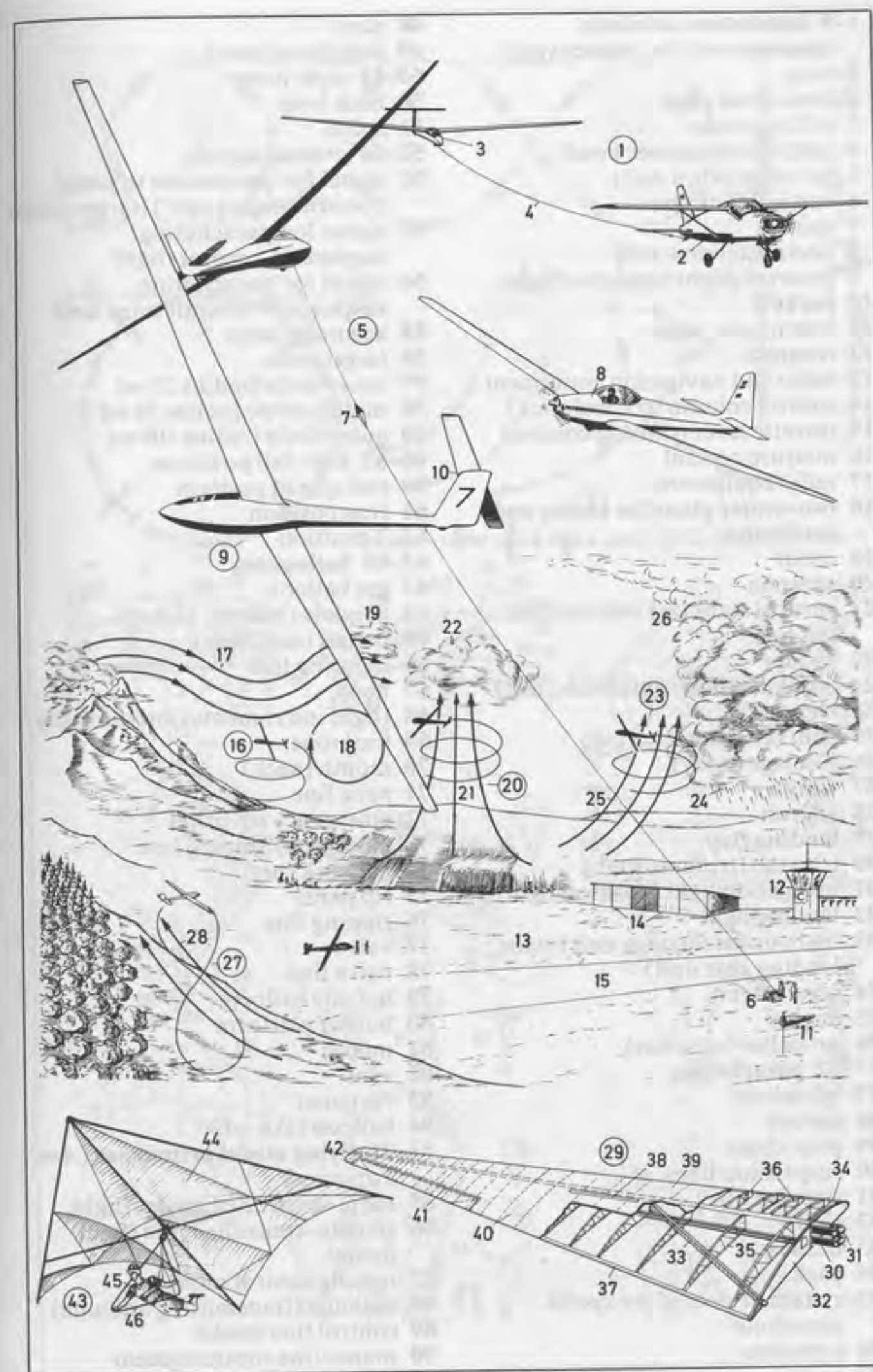



- 1-9 aerobatics, aerobic manoeuvres (*Am.* maneuvers)
- 1 loop
- 2 horizontal eight
- 3 rolling circle
- 4 stall turn (hammer head)
- 5 tail slide (whip stall)
- 6 vertical flick spin
- 7 spin
- 8 horizontal slow roll
- 9 inverted flight (negative flight)
- 10 cockpit
- 11 instrument panel
- 12 compass
- 13 radio and navigation equipment
- 14 control column (control stick)
- 15 throttle lever (throttle control)
- 16 mixture control
- 17 radio equipment
- 18 two-seater plane for racing and aerobatics
- 19 cabin
- 20 antenna
- 21 vertical stabilizer (vertical fin, tail fin)
- 22 rudder
- 23 tailplane (horizontal stabilizer)
- 24 elevator
- 25 trim tab (trimming tab)
- 26 fuselage (body)
- 27 wing
- 28 aileron
- 29 landing flap
- 30 trim tab (trimming tab)
- 31 navigation light (position light) [red]
- 32 landing light
- 33 main undercarriage unit (main landing gear unit)
- 34 nose wheel
- 35 engine
- 36 propeller (airscrew)
- 37-62 parachuting
- 37 parachute
- 38 canopy
- 39 pilot chute
- 40 suspension lines
- 41 steering line
- 42 riser
- 43 harness
- 44 pack
- 45 system of slots of the sports parachute
- 46 turn slots
- 47 apex
- 48 skirt
- 49 stabilizing panel
- 50-51 style jump
- 50 back loop
- 51 spiral
- 52-54 ground signals
- 52 signal for 'permission to jump' ('conditions are safe') (target cross)
- 53 signal for 'parachuting suspended - repeat flight'
- 54 signal for 'parachuting suspended - aircraft must land'
- 55 accuracy jump
- 56 target cross
- 57 inner circle [radius 25 m]
- 58 middle circle [radius 50 m]
- 59 outer circle [radius 100 m]
- 60-62 free-fall positions
- 60 full spread position
- 61 frog position
- 62 T position
- 63-84 ballooning
- 63 gas balloon
- 64 gondola (balloon basket)
- 65 ballast (sandbags)
- 66 mooring line
- 67 hoop
- 68 flight instruments (instruments)
- 69 trail rope
- 70 mouth (neck)
- 71 neck line
- 72 emergency rip panel
- 73 emergency ripping line
- 74 network (net)
- 75 rip panel
- 76 ripping line
- 77 valve
- 78 valve line
- 79 hot-air balloon
- 80 burner platform
- 81 mouth
- 82 vent
- 83 rip panel
- 84 balloon take-off
- 85-91 flying model aeroplanes (*Am.* airplanes)
- 85 radio-controlled model flight
- 86 remote-controlled free flight model
- 87 remote control radio
- 88 antenna (transmitting antenna)
- 89 control line model
- 90 mono-line control system
- 91 flying kennel, a K9-class model

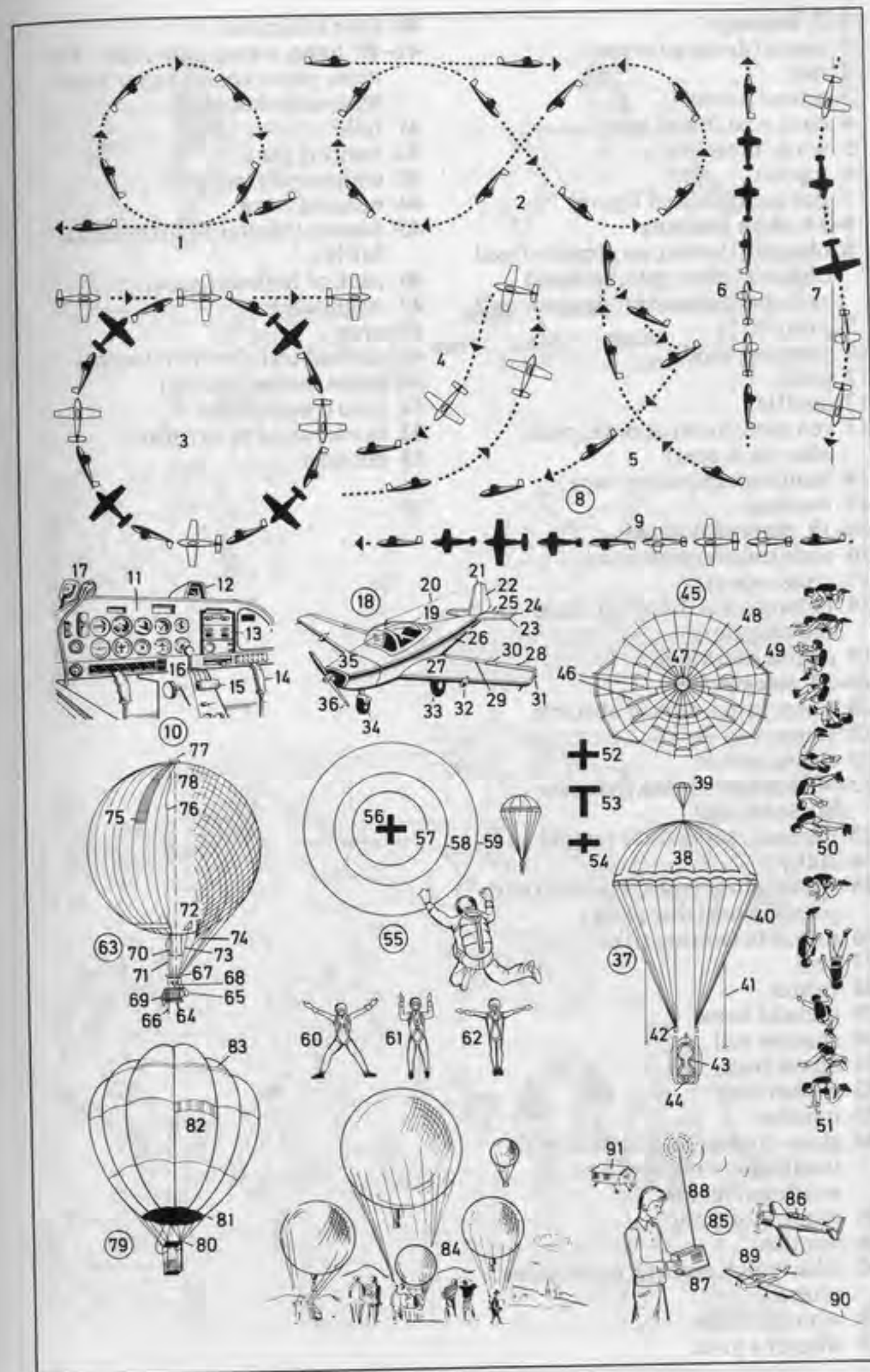



- 1-7 dressage
- 1 arena (dressage arena)
- 2 rail
- 3 school horse
- 4 dark coat (black coat)
- 5 white breeches
- 6 top hat
- 7 gait (also: school figure)
- 8-14 show jumping
- 8 obstacle (fence), an almost-fixed obstacle; *sim.*: gate, gate and rails, palisade, oxer, mound, wall
- 9 jumper
- 10 jumping saddle
- 11 girth
- 12 snaffle
- 13 red coat (hunting pink, pink; also: dark coat)
- 14 hunting cap (riding cap)
- 15 bandage
- 16-19 three-day event
- 16 endurance competition
- 17 cross-country
- 18 helmet (also: hard hat, hard hunting cap)
- 19 course markings
- 20-22 steeplechase
- 20 water jump, a fixed obstacle
- 21 jump
- 22 riding switch
- 23-40 harness racing (harness horse racing)
- 23 harness racing track (track)
- 24 sulky
- 25 spoke wheel (spoked wheel) with plastic wheel disc (disk)
- 26 driver in trotting silks
- 27 rein
- 28 trotter
- 29 piebald horse
- 30 shadow roll
- 31 elbow boot
- 32 rubber boot
- 33 number
- 34 glass-covered grandstand with totalizator windows (tote windows) inside
- 35 totalizator (tote)
- 36 number
- 37 odds (price, starting price, price offered)
- 38 winners' table
- 39 winner's price

- 40 time indicator
- 41-49 hunt, a drag hunt; *sim.*: fox hunt, paper chase (paper hunt, hare-and-hounds)
- 41 field
- 42 hunting pink
- 43 whipper-in (whip)
- 44 hunting horn
- 45 Master (Master of foxhounds, MFH)
- 46 pack of hounds (pack)
- 47 staghound
- 48 drag
- 49 scented trail (artificial scent)
- 50 horse racing (racing)
- 51 field (racehorses)
- 52 favourite (*Am.* favorite)
- 53 outsider

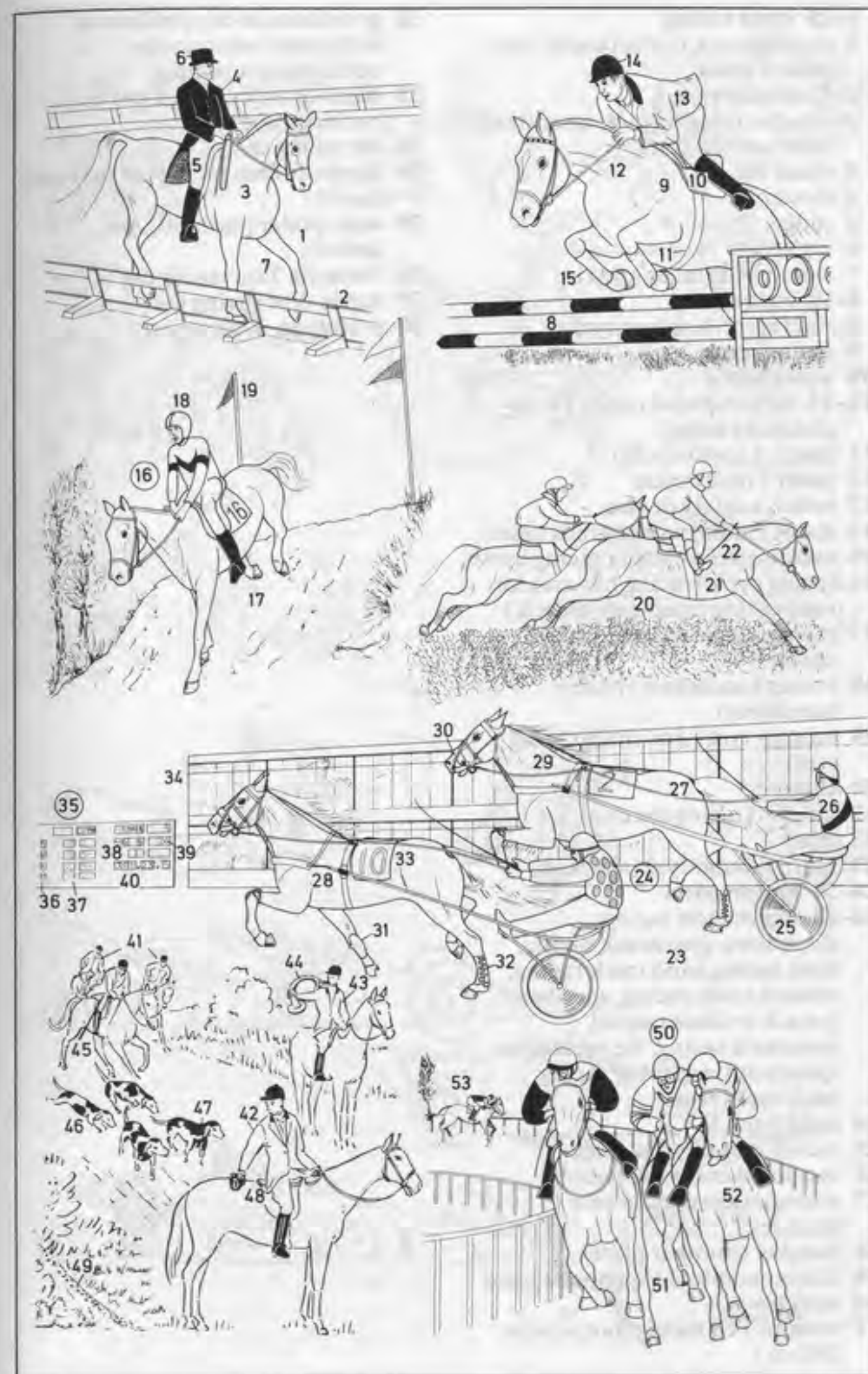



## 1-23 cycle racing

- 1 cycling track (cycle track); *here*: indoor track  
 2-7 six-day race  
 2 six-day racer, a track racer (track rider) on the track  
 3 crash hat  
 4 stewards  
 5 judge  
 6 lap scorer  
 7 rider's box (racer's box)  
 8-10 road race  
 8 road racer, a racing cyclist  
 9 racing jersey  
 10 water bottle  
 11-15 motor-paced racing (long-distance racing)  
 11 pacer, a motorcyclist  
 12 pacer's motorcycle  
 13 roller, a safety device  
 14 stayer (motor-paced track rider)  
 15 motor-paced cycle, a racing cycle  
 16 racing cycle (racing bicycle) for road racing (road race bicycle)  
 17 racing saddle, an unsprung saddle  
 18 racing handlebars (racing handlebar)  
 19 tubular tyre (*Am.* tire) (racing tyre)  
 20 chain  
 21 toe clip (racing toe clip)  
 22 strap  
 23 spare tubular tyre (*Am.* tire)  
 24-38 motorsports

- 24-28 motorcycle racing;  
*disciplines*: grasstrack racing, road racing, sand track racing, cement track racing, speedway [on ash or shale tracks], mountain racing, ice racing (ice speedway), scramble racing, trial, moto cross  
 24 sand track  
 25 racing motorcyclist (rider)  
 26 leather overalls (leathers)  
 27 racing motorcycle, a solo machine  
 28 number (number plate)  
 29 sidecar combination on the bend  
 30 sidecar  
 31 streamlined racing motorcycle [500 cc.]

- 32 gymkhana, a competition of skill; *here*: motorcyclist performing a jump  
 33 cross-country race, a test in performance  
 34-38 racing cars  
 34 Formula One racing car (a mono posto)  
 35 rear spoiler (aerofoil, *Am.* airfoil)  
 36 Formula Two racing car  
 37 Super-Vee racing car  
 38 prototype, a racing car

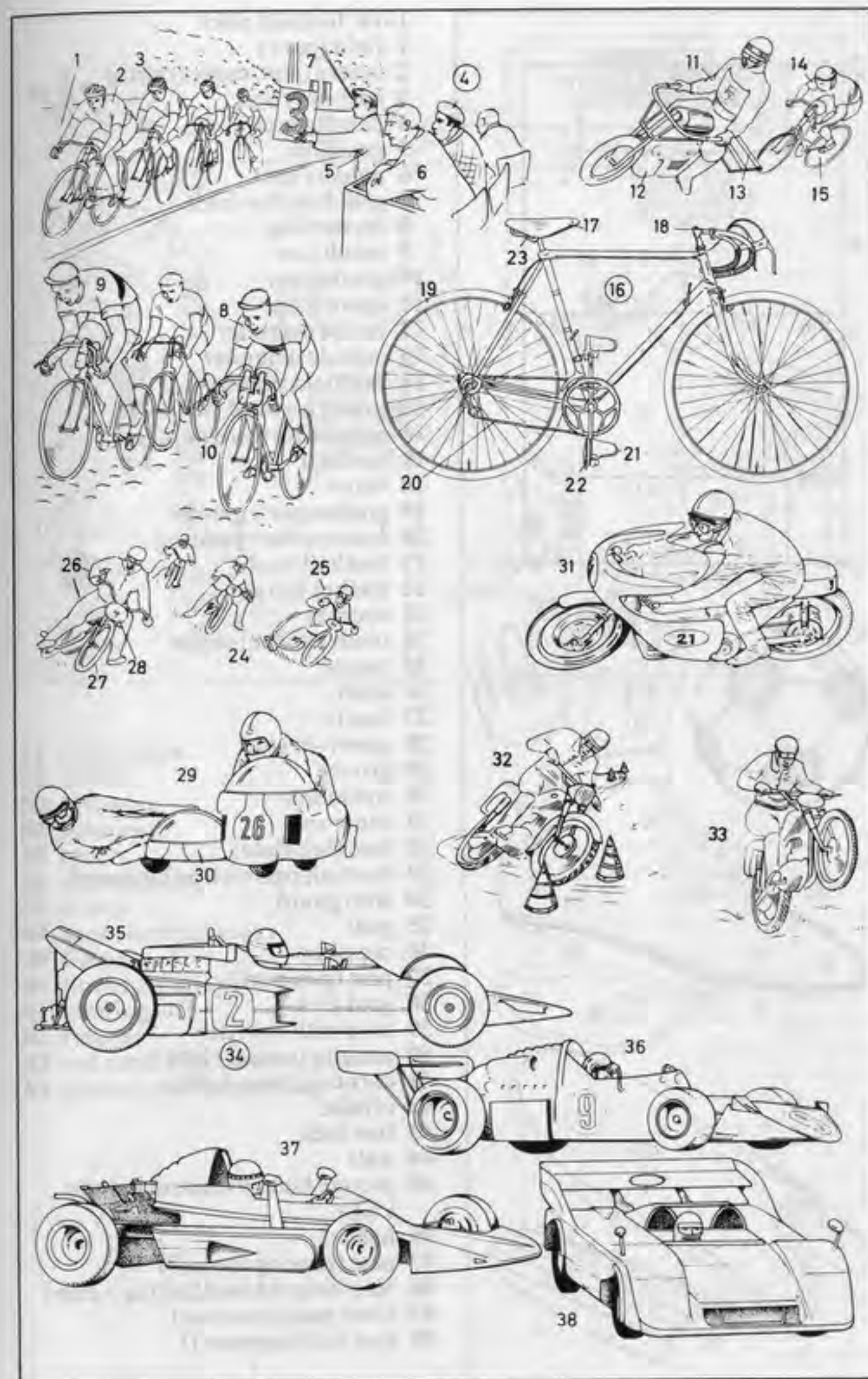





- 1-16 football pitch
- 1 field (park)
- 2 centre (*Am.* center) circle
- 3 half-way line
- 4 penalty area
- 5 goal area
- 6 penalty spot
- 7 goal line (by-line)
- 8 corner flag
- 9 touch line
- 10 goalkeeper
- 11 spare man
- 12 inside defender
- 13 outside defender
- 14 midfield players
- 15 inside forward (striker)
- 16 outside forward (winger)
- 17 football
- 18 valve
- 19 goalkeeper's gloves
- 20 foam rubber padding
- 21 football boot
- 22 leather lining
- 23 counter
- 24 foam rubber tongue
- 25 bands
- 26 shaft
- 27 insole
- 28 screw-in stud
- 29 groove
- 30 nylon sole
- 31 inner sole
- 32 lace (bootlace)
- 33 football pad with ankle guard
- 34 shin guard
- 35 goal
- 36 crossbar
- 37 post (goalpost)
- 38 goal kick
- 39 save with the fists
- 40 penalty (penalty kick)
- 41 corner (corner kick)
- 42 offside
- 43 free kick
- 44 wall
- 45 bicycle kick (overhead bicycle kick)
- 46 header
- 47 pass (passing the ball)
- 48 receiving the ball (taking a pass)
- 49 short pass (one-two)
- 50 foul (infringement)

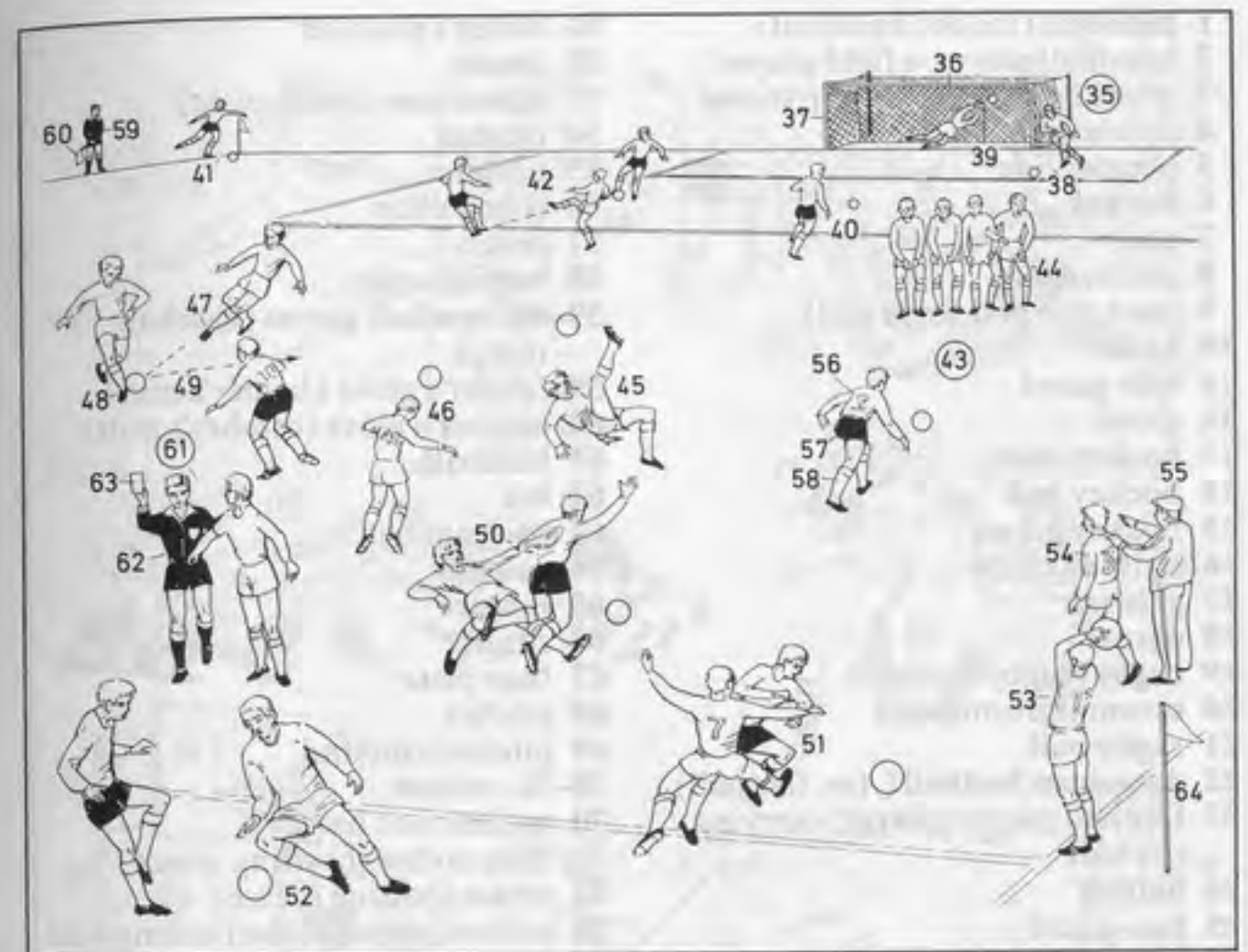

- 51 obstruction
- 52 dribble
- 53 throw-in
- 54 substitute
- 55 coach
- 56 shirt (jersey)
- 57 shorts
- 58 sock (football sock)
- 59 linesman
- 60 linesman's flag
- 61 sending-off
- 62 referee
- 63 red card; also: yellow card
- 64 centre (*Am.* center) flag



- 1 handball (indoor handball)
- 2 handball player, a field player
- 3 attacker, making a jump throw
- 4 defender
- 5 penalty line
- 6 hockey
- 7 goal
- 8 goalkeeper
- 9 pad (shin pad, knee pad)
- 10 kicker
- 11 face guard
- 12 glove
- 13 hockey stick
- 14 hockey ball
- 15 hockey player
- 16 striking circle
- 17 sideline
- 18 corner
- 19 rugby (rugby football)
- 20 scrum (scrummage)
- 21 rugby ball
- 22 American football (Am. football)
- 23 football player (player) carrying the ball
- 24 helmet
- 25 face guard
- 26 padded jersey
- 27 ball (pigskin)
- 28 basketball
- 29 basketball
- 30 backboard
- 31 basket posts
- 32 basket
- 33 basket ring
- 34 target rectangle
- 35 basketball player shooting
- 36 end line
- 37 restricted area
- 38 free-throw line
- 39 substitute
- 40-69 baseball
- 40-58 field (park)
- 40 spectator barrier
- 41 outfielder
- 42 short stop
- 43 second base
- 44 baseman
- 45 runner
- 46 first base
- 47 third base
- 48 foul line (base line)
- 49 pitcher's mound
- 50 pitcher

- 51 batter's position
- 52 batter
- 53 home base (home plate)
- 54 catcher
- 55 umpire
- 56 coach's box
- 57 coach
- 58 batting order
- 59-60 baseball gloves (baseball mitts)
- 59 fielder's glove (fielder's mitt)
- 60 catcher's glove (catcher's mitt)
- 61 baseball
- 62 bat
- 63 batter at bat
- 64 catcher
- 65 umpire
- 66 runner
- 67 base plate
- 68 pitcher
- 69 pitcher's mound
- 70-76 cricket
- 70 wicket with bails
- 71 back crease (bowling crease)
- 72 crease (batting crease)
- 73 wicket keeper of the fielding side
- 74 batsman
- 75 bat (cricket bat)
- 76 fielder (bowler)
- 77-82 croquet
- 77 winning peg
- 78 hoop
- 79 corner peg
- 80 croquet player
- 81 croquet mallet
- 82 croquet ball

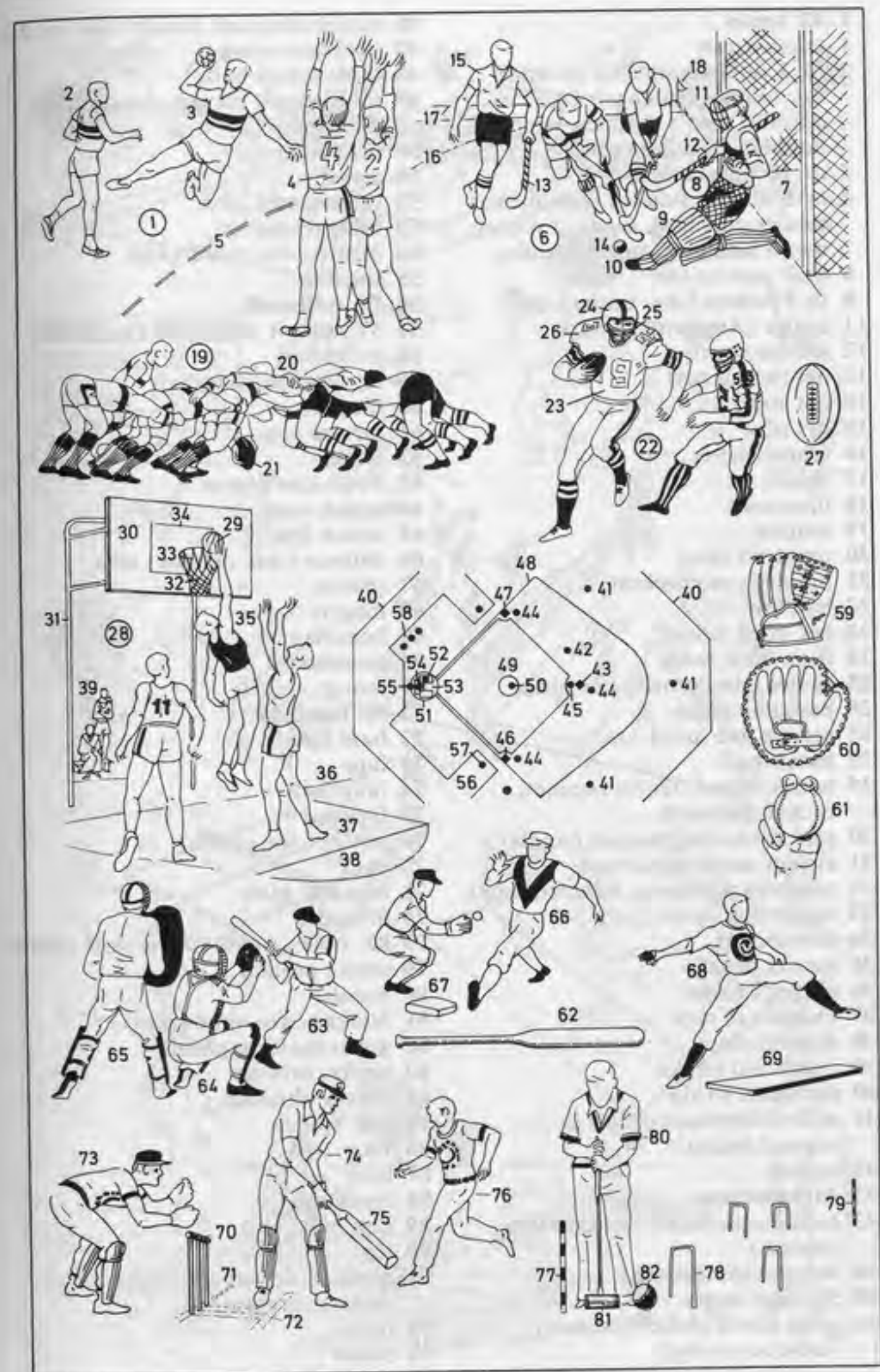



- 1-42 tennis  
 1 tennis court  
 2 to 3 doubles sideline (sideline for doubles matches); *kinds of doubles*: men's doubles, women's doubles, mixed doubles  
 3 to 10 base line  
 4 to 5 singles sideline (sideline for singles matches); *kinds of singles*: men's singles, women's singles  
 6 to 7 service line  
 8 to 9 centre (*Am.* center) line  
 11 centre (*Am.* center) mark  
 12 service court  
 13 net (tennis net)  
 14 net strap  
 15 net post  
 16 tennis player  
 17 smash  
 18 opponent  
 19 umpire  
 20 umpire's chair  
 21 umpire's microphone  
 22 ball boy  
 23 net-cord judge  
 24 foot-fault judge  
 25 centre (*Am.* center) line judge  
 26 base line judge  
 27 service line judge  
 28 tennis ball  
 29 tennis racket (tennis racquet, racket, racquet)  
 30 racket handle (racquet handle)  
 31 strings (striking surface)  
 32 press (racket press, racquet press)  
 33 tightening screw  
 34 scoreboard  
 35 results of sets  
 36 player's name  
 37 number of sets  
 38 state of play  
 39 backhand stroke  
 40 forehand stroke  
 41 volley (forehand volley at normal height)  
 42 service
- 46 racket (racquet) handle (bat handle)  
 47 blade covering  
 48 table tennis ball  
 49 table tennis players; *here*: mixed doubles  
 50 receiver  
 51 server  
 52 table tennis table  
 53 table tennis net  
 54 centre (*Am.* center) line  
 55 sideline  
 56-71 volleyball  
 56-57 correct placing of the hands  
 58 volleyball  
 59 serving the volleyball  
 60 blocker  
 61 service area  
 62 server  
 63 front-line player  
 64 attack area  
 65 attack line  
 66 defence (*Am.* defense) area  
 67 referee  
 68 umpire  
 69 linesman  
 70 scoreboard  
 71 scorer  
 72-78 faustball  
 72 base line  
 73 tape  
 74 faust ball  
 75 forward  
 76 centre (*Am.* center)  
 77 back  
 78 hammer blow
- 79-93 golf  
 79-82 hole, a part of the golf course  
 79 teeing ground  
 80 rough  
 81 bunker (*Am.* sand trap)  
 82 green (putting green)  
 83 golfer, driving  
 84 follow-through  
 85 golf trolley  
 86 flag  
 87 hole  
 88 flagstick  
 89 golf ball  
 90 tee  
 91 wood, a driver; *sim.*: brassie (brassy, brasse)  
 92 iron  
 93 putter

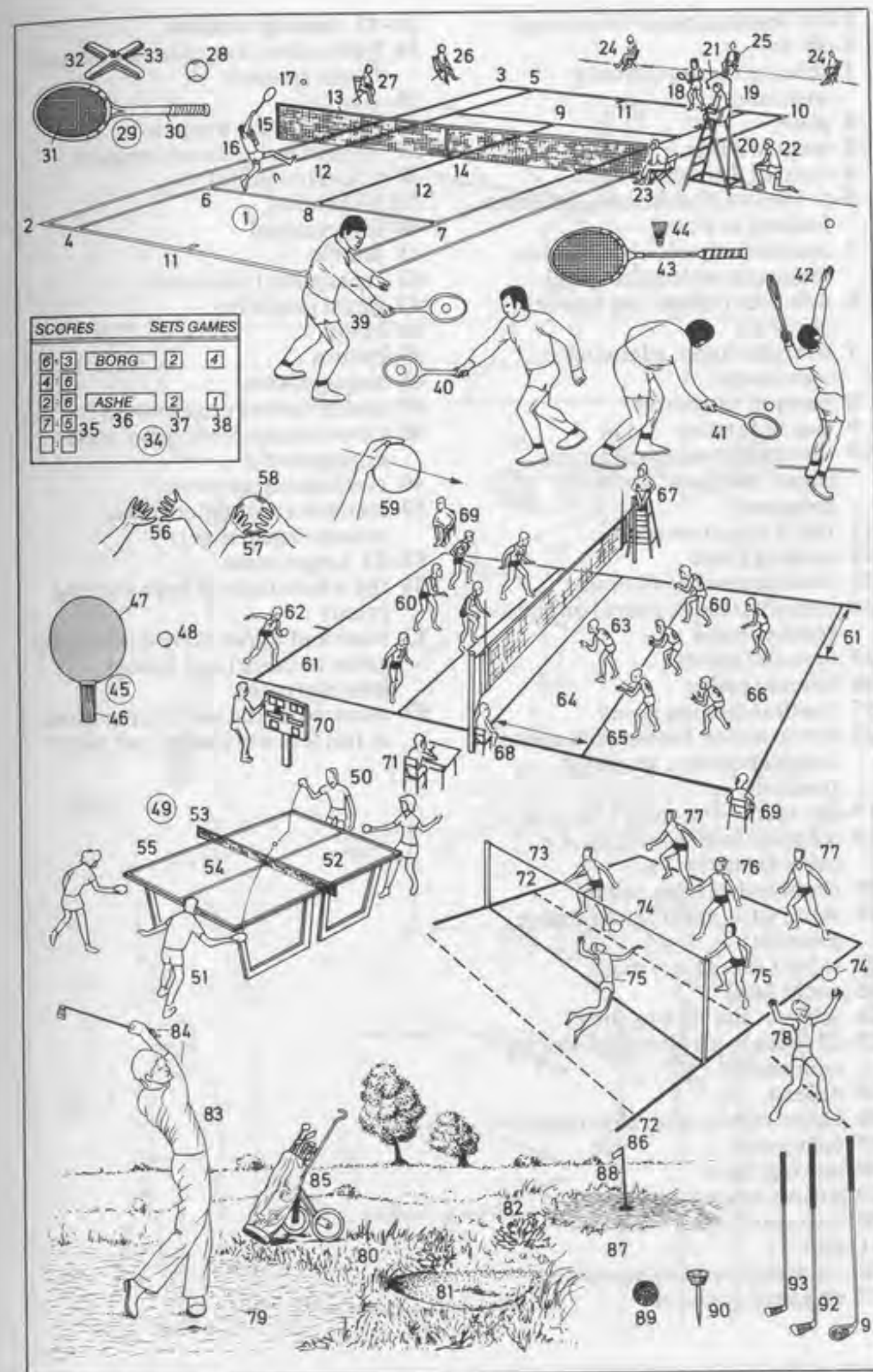



- 1-33 fencing (modern fencing)  
 1-18 foil  
 1 fencing master (fencing instructor)  
 2 piste  
 3 on guard line  
 4 centre (*Am.* center) line  
 5-6 fencers (foil fencers, foilsmen, foilists) in a bout  
 5 attacker (attacking fencer) in lunging position (lunging)  
 6 defender (defending fencer), parrying  
 7 straight thrust, a fencing movement  
 8 parry of the tierce  
 9 line of fencing  
 10 the three fencing measures [short, medium, and long measure]  
 11 foil, a thrust weapon  
 12 fencing glove  
 13 fencing mask (foil mask)  
 14 neck flap (neck guard) on the fencing mask  
 15 metallic jacket  
 16 fencing jacket  
 17 heelless fencing shoes  
 18 first position for fencer's salute (initial position, on guard position)  
 19-24 sabre (*Am.* saber) fencing  
 19 sabreurs (sabre fencers, *Am.* saber fencers)  
 20 (light) sabre (*Am.* saber)  
 21 sabre (*Am.* saber) glove (sabre gauntlet)  
 22 sabre (*Am.* saber) mask  
 23 cut at head  
 24 parry of the fifth (quinte)  
 25-33 épée, with electrical scoring equipment  
 25 épéist  
 26 electric épée; *also*: electric foil  
 27 épée point  
 28 scoring lights  
 29 spring-loaded wire spool  
 30 indicator light  
 31 wire  
 32 electronic scoring equipment  
 33 on guard position  
 34-45 fencing weapons  
 34 light sabre (*Am.* saber), a cut and thrust weapon  
 35 guard  
 36 épée, a thrust weapon  
 37 French foil, a thrust weapon  
 38 guard (coquille)  
 39 Italian foil  
 40 foil pommel  
 41 handle  
 42 cross piece (quillons)  
 43 guard (coquille)  
 44 blade  
 45 button  
 46 engagements  
 47 quarte (carte) engagement  
 48 tierce engagement (*also*: sixte engagement)  
 49 circling engagement  
 50 seconde engagement (*also*: octave engagement)  
 51-53 target areas  
 51 the whole body in épée fencing (men)  
 52 head and upper body down to the groin in sabre (*Am.* saber) fencing (men)  
 53 trunk from the neck to the groin in foil fencing (ladies and men)

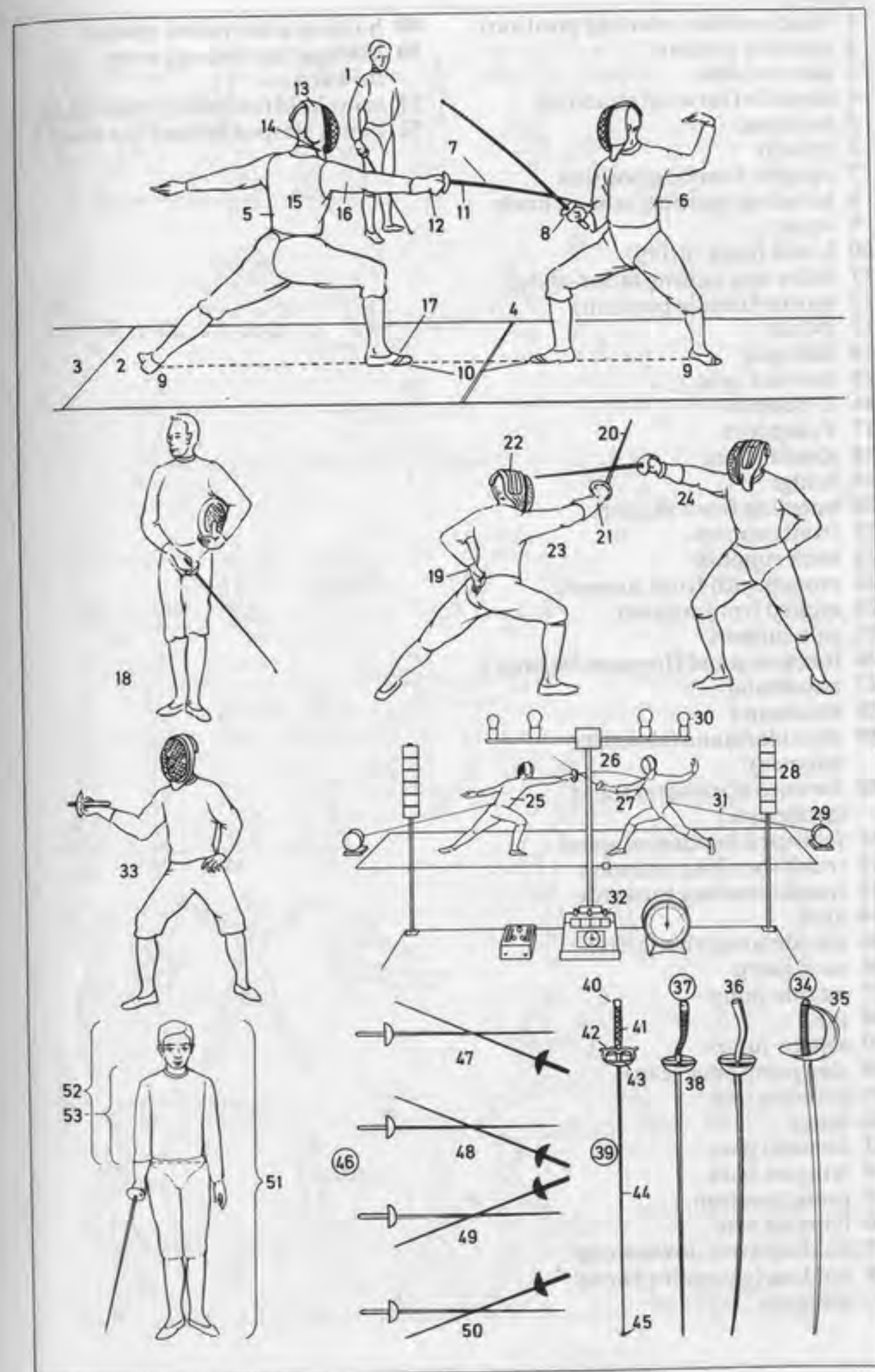



- 1 basic position (starting position)
- 2 running posture
- 3 side straddle
- 4 straddle (forward straddle)
- 5 toe stand
- 6 crouch
- 7 upright kneeling position
- 8 kneeling position, seat on heels
- 9 squat
- 10 L seat (long sitting)
- 11 tailor seat (sitting tailor-style)
- 12 hurdle (hurdle position)
- 13 V-seat
- 14 side split
- 15 forward split
- 16 L-support
- 17 V-support
- 18 straddle seat
- 19 bridge
- 20 kneeling front support
- 21 front support
- 22 back support
- 23 crouch with front support
- 24 arched front support
- 25 side support
- 26 forearm stand (forearm balance)
- 27 handstand
- 28 headstand
- 29 shoulder stand (shoulder balance)
- 30 forward horizontal stand (arabesque)
- 31 rearward horizontal stand
- 32 trunk-bending sideways
- 33 trunk-bending forwards
- 34 arch
- 35 astride jump (butterfly)
- 36 tuck jump
- 37 astride jump
- 38 pike
- 39 scissor jump
- 40 stag jump (stag leap)
- 41 running step
- 42 lunge
- 43 forward pace
- 44 lying on back
- 45 prone position
- 46 lying on side
- 47 holding arms downwards
- 48 holding (extending) arms sideways
- 49 holding arms raised upward
- 50 holding (extending) arms forward
- 51 arms held (extended) backward
- 52 hands clasped behind the head

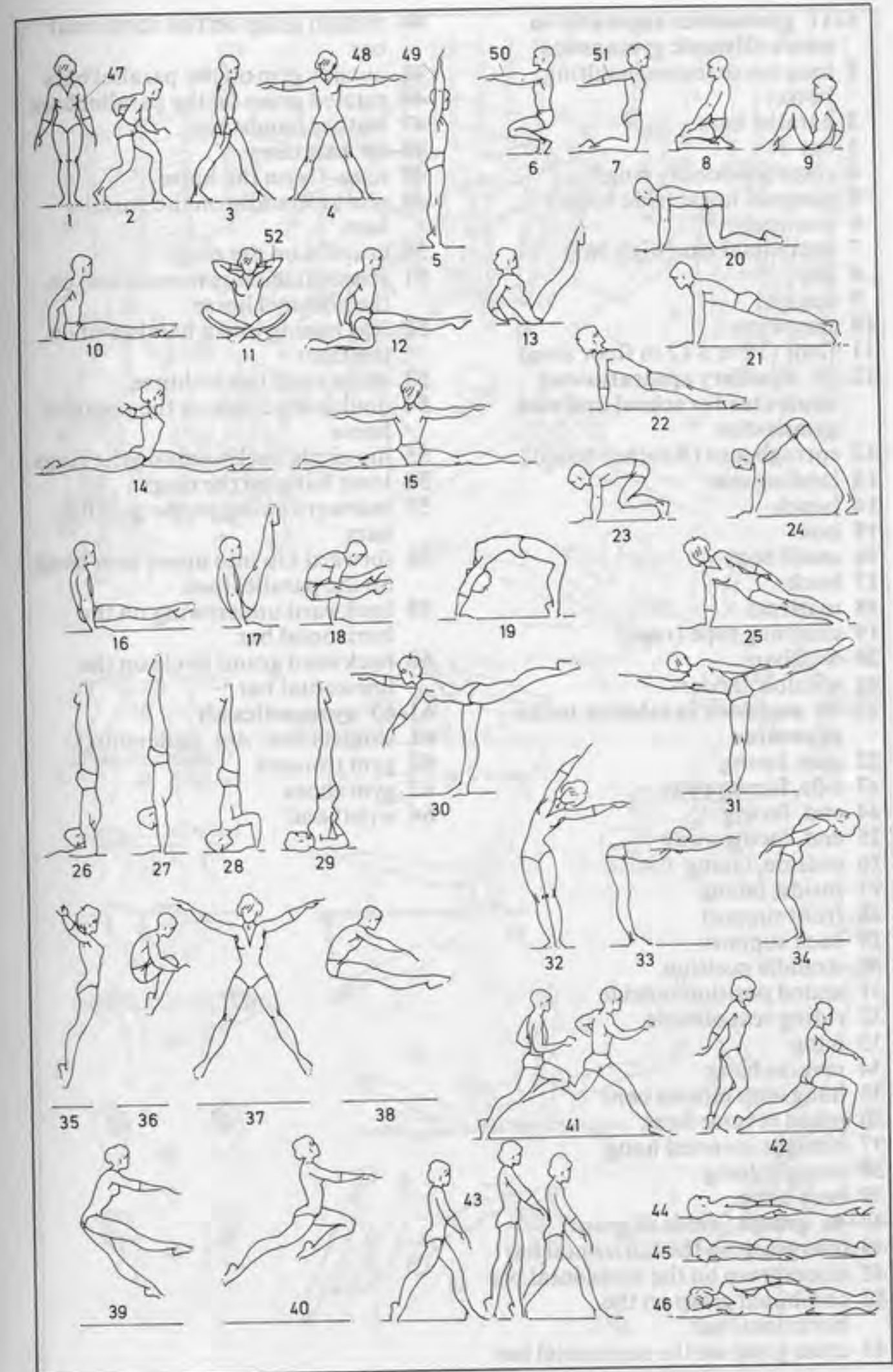



- 1-11 gymnastics apparatus in men's Olympic gymnastics
- 1 long horse (horse, vaulting horse)
  - 2 parallel bars
  - 3 bar
  - 4 rings (stationary rings)
  - 5 pommel horse (side horse)
  - 6 pommel
  - 7 horizontal bar (high bar)
  - 8 bar
  - 9 upright
  - 10 stay wires
  - 11 floor (12 m x 12 m floor area)
- 12-21 auxiliary apparatus and apparatus for school and club gymnastics
- 12 springboard (Reuther board)
  - 13 landing mat
  - 14 bench
  - 15 box
  - 16 small box
  - 17 buck
  - 18 mattress
  - 19 climbing rope (rope)
  - 20 wall bars
  - 21 window ladder
- 22-39 positions in relation to the apparatus
- 22 side, facing
  - 23 side, facing away
  - 24 end, facing
  - 25 end, facing away
  - 26 outside, facing
  - 27 inside, facing
  - 28 front support
  - 29 back support
  - 30 straddle position
  - 31 seated position outside
  - 32 riding seat outside
  - 33 hang
  - 34 reverse hang
  - 35 hang with elbows bent
  - 36 piked reverse hang
  - 37 straight inverted hang
  - 38 straight hang
  - 39 bent hang
- 40-46 grasps (kinds of grasp)
- 40 overgrasp on the horizontal bar
  - 41 undergrasp on the horizontal bar
  - 42 combined grasp on the horizontal bar
  - 43 cross grasp on the horizontal bar

- 44 rotated grasp on the horizontal bar
  - 45 outside grip on the parallel bars
  - 46 rotated grasp on the parallel bars
  - 47 leather handstrap
  - 48-60 exercises
  - 48 long-fly on the horse
  - 49 rise to straddle on the parallel bars
  - 50 crucifix on the rings
  - 51 scissors (scissors movement) on the pommel horse
  - 52 legs raising into a handstand on the floor
  - 53 squat vault on the horse
  - 54 double leg circle on the pommel horse
  - 55 hip circle backwards on the rings
  - 56 lever hang on the rings
  - 57 rearward swing on the parallel bars
  - 58 forward kip into upper arm hang on the parallel bars
  - 59 backward underswing on the horizontal bar
  - 60 backward grand circle on the horizontal bar
- 61-63 gymnastics kit
- 61 singlet (vest, Am. undershirt)
  - 62 gym trousers
  - 63 gym shoes
  - 64 wristband

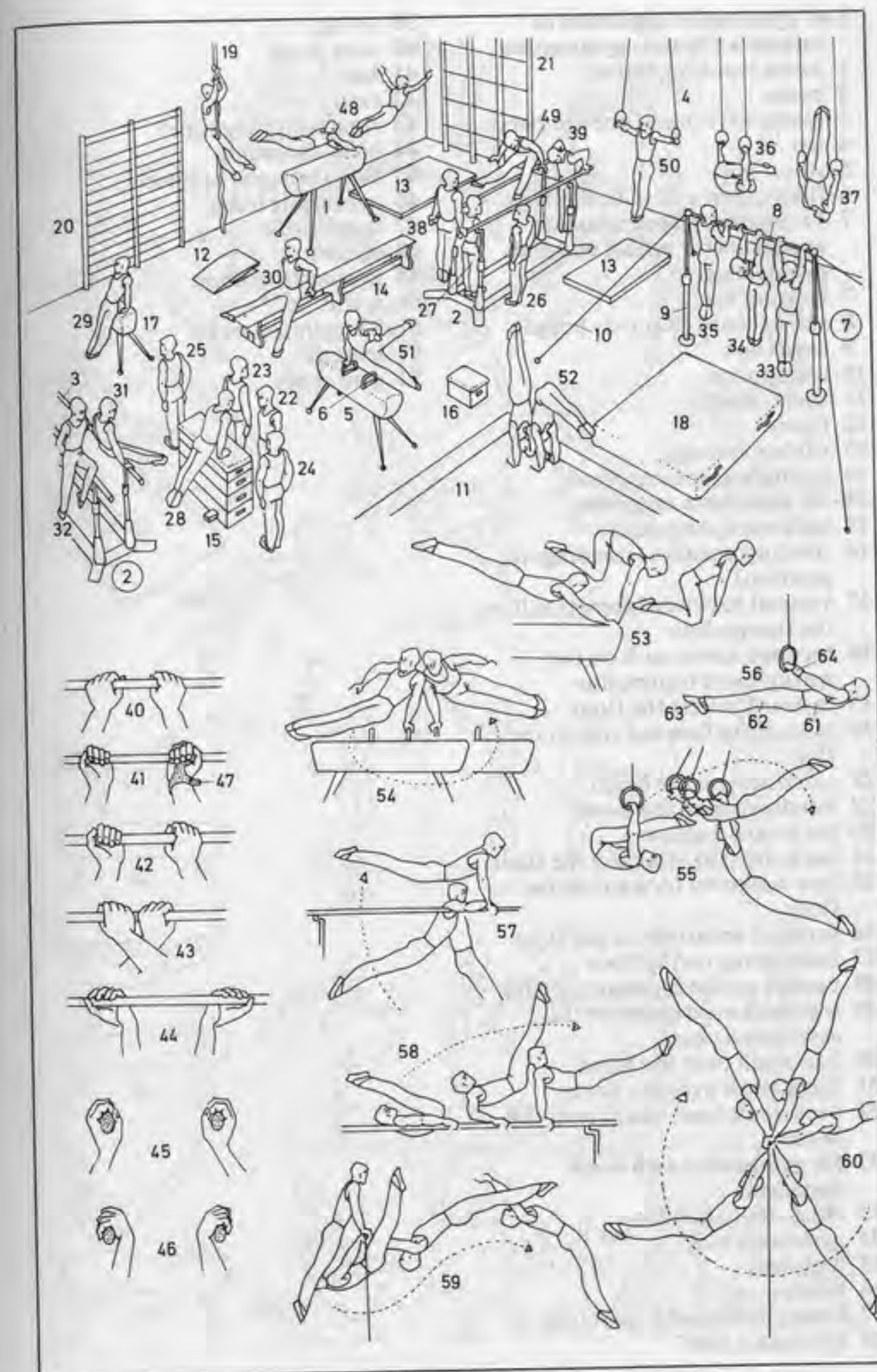



- 1-6 gymnastics apparatus in women's Olympic gymnastics
- 1 horse (vaulting horse)
- 2 beam
- 3 asymmetric bars (uneven bars)
- 4 bar
- 5 stay wires
- 6 floor (12 m x 12 m floor area)
- 7-14 auxiliary apparatus and apparatus for school and club gymnastics
- 7 landing mat
- 8 springboard (Reuther board)
- 9 small box
- 10 trampoline
- 11 sheet (web)
- 12 frame
- 13 rubber springs
- 14 springboard trampoline
- 15-32 apparatus exercises
- 15 backward somersault
- 16 spotting position (standing-in position)
- 17 vertical backward somersault on the trampoline
- 18 forward somersault on the springboard trampoline
- 19 forward roll on the floor
- 20 long-fly to forward roll on the floor
- 21 cartwheel on the beam
- 22 handspring on the horse
- 23 backward walkover
- 24 back flip (flik-flak) on the floor
- 25 free walkover forward on the floor
- 26 forward walkover on the floor
- 27 headspring on the floor
- 28 upstart on the asymmetric bars
- 29 free backward circle on the asymmetric bars
- 30 face vault over the horse
- 31 flank vault over the horse
- 32 back vault (rear vault) over the horse
- 33-50 gymnastics with hand apparatus
- 33 hand-to-hand throw
- 34 gymnastic ball
- 35 high toss
- 36 bounce
- 37 hand circling with two clubs
- 38 gymnastic club

- 39 swing
- 40 tuck jump
- 41 bar
- 42 skip
- 43 rope (skipping rope)
- 44 criss-cross skip
- 45 skip through the hoop
- 46 gymnastic hoop
- 47 hand circle
- 48 serpent
- 49 gymnastic ribbon
- 50 spiral
- 51-52 gymnastics kit
- 51 leotard
- 52 gym shoes

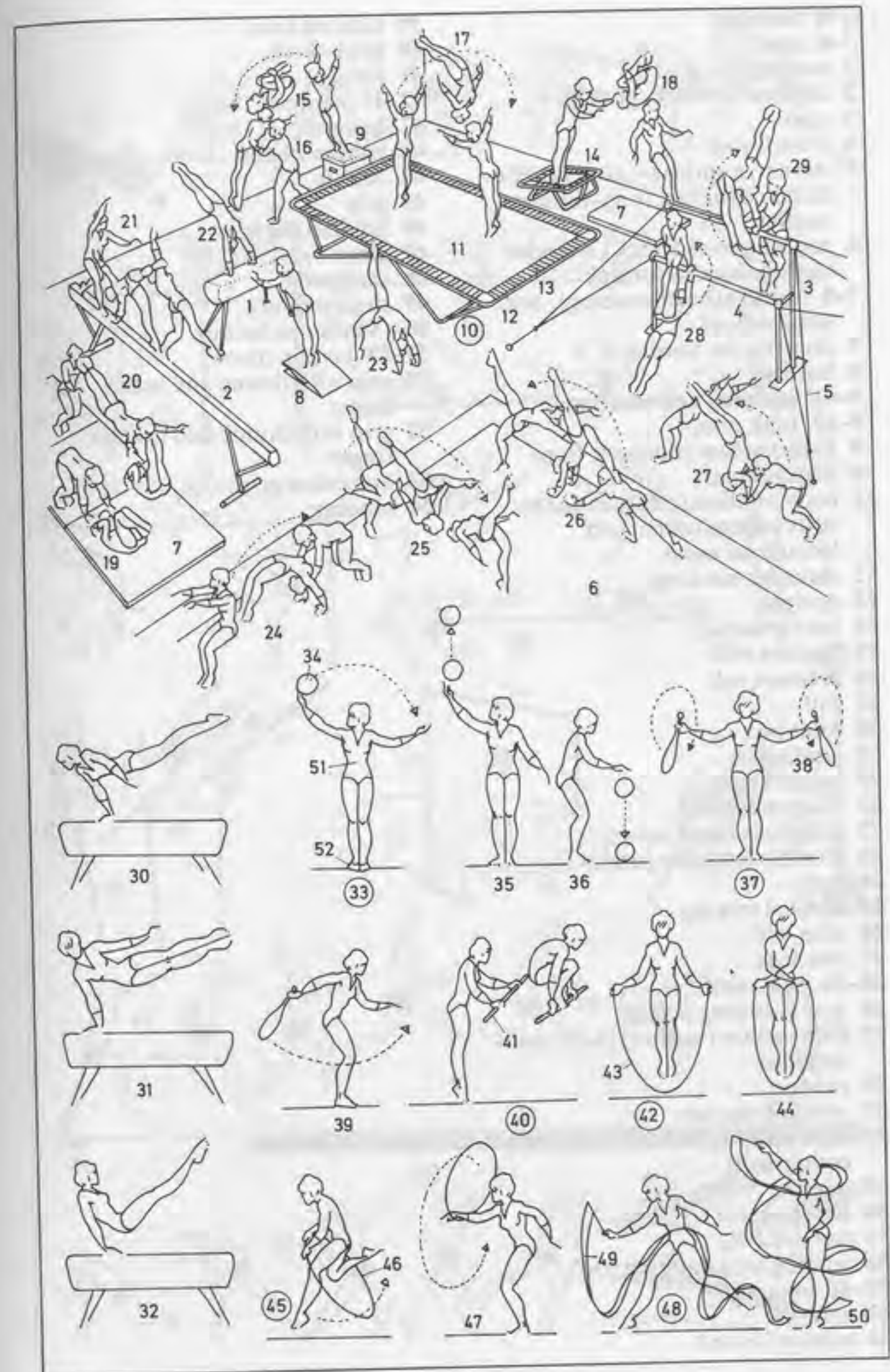



- 1-8 running
- 1-6 start
- 1 starting block
- 2 adjustable block (pedal)
- 3 start
- 4 crouch start
- 5 runner, a sprinter; *also*: middle-distance runner, long-distance runner
- 6 running track (track), a cinder track or synthetic track
- 7-8 hurdles (hurdle racing); *sim.*: steeplechase
- 7 clearing the hurdle
- 8 hurdle
- 9-41 jumping and vaulting
- 9-27 high jump
- 9 Fosbury flop (Fosbury, flop)
- 10 high jumper
- 11 body rotation (rotation on the body's longitudinal and latitudinal axes)
- 12 shoulder landing
- 13 upright
- 14 bar (crossbar)
- 15 Eastern roll
- 16 Western roll
- 17 roll
- 18 rotation
- 19 landing
- 20 height scale
- 21 Eastern cut-off
- 22 scissors (scissor jump)
- 23 straddle (straddle jump)
- 24 turn
- 25 vertical free leg
- 26 take-off
- 27 free leg
- 28-36 pole vault
- 28 pole (vaulting pole)
- 29 pole vaulter (vaulter) in the pull-up phase
- 30 swing
- 31 crossing the bar
- 32 high jump apparatus (high jump equipment)
- 33 upright
- 34 bar (crossbar)
- 35 box
- 36 landing area (landing pad)
- 37-41 long jump
- 37 take-off
- 38 take-off board

- 39 landing area
- 40 hitch-kick
- 41 hang
- 42-47 hammer throw
- 42 hammer
- 43 hammer head
- 44 handle
- 45 grip
- 46 holding the grip
- 47 glove
- 48 shot put
- 49 shot (weight)
- 50 O'Brien technique
- 51-53 javelin throw
- 51 grip with thumb and index finger
- 52 grip with thumb and middle finger
- 53 horseshoe grip
- 54 binding

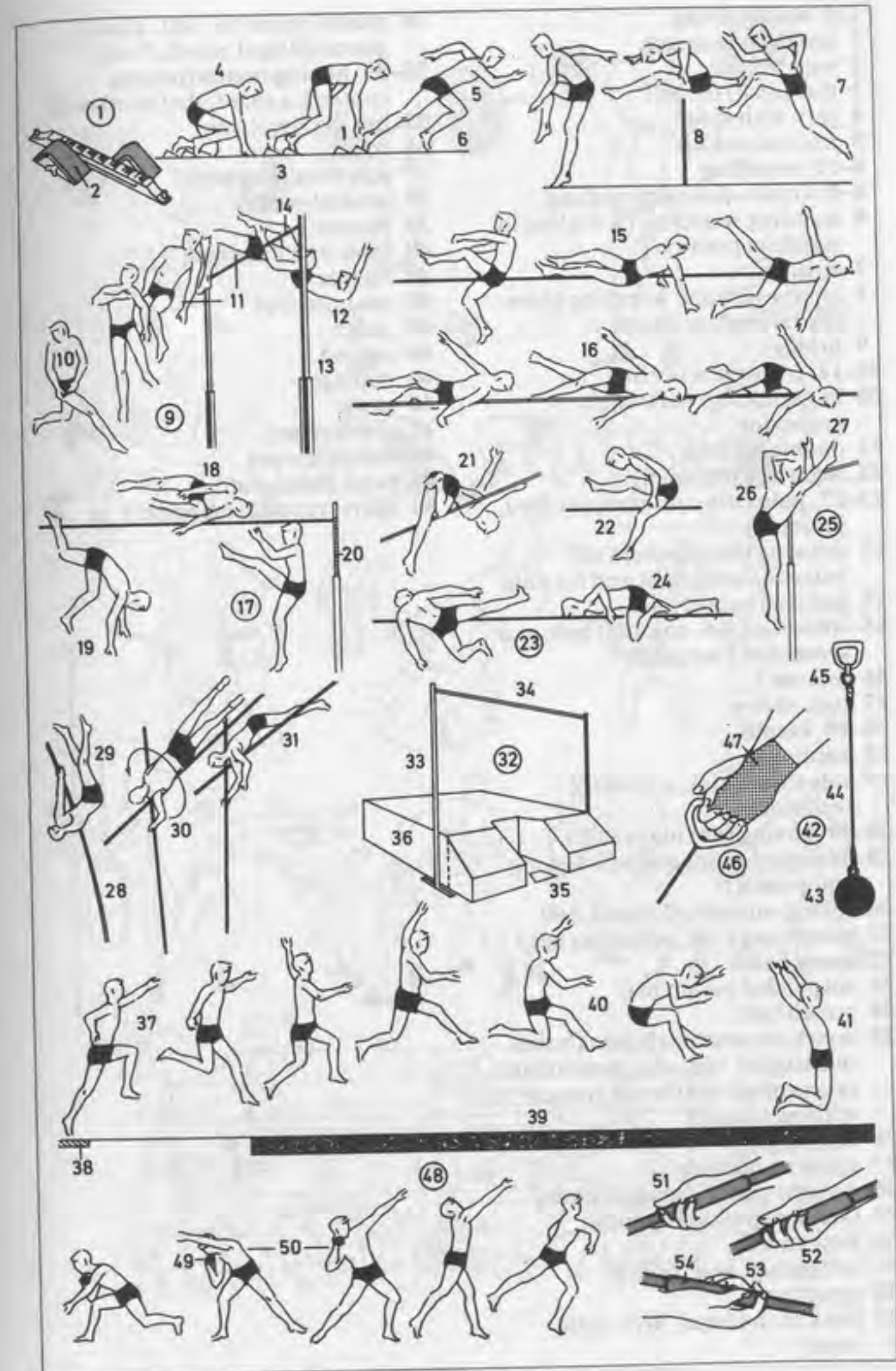



- 1-5 weightlifting  
 1 squat-style snatch  
 2 weightlifter  
 3 disc (disk) barbell  
 4 jerk with split  
 5 maintained lift  
 6-12 wrestling  
 6-9 Greco-Roman wrestling  
 6 standing wrestling (wrestling in standing position)  
 7 wrestler  
 8 on-the-ground wrestling (*here*: the referee's position)  
 9 bridge  
 10-12 freestyle wrestling  
 10 bar arm (arm bar) with grapevine  
 11 double leg lock  
 12 wrestling mat (mat)  
 13-17 judo (*sim.*: ju-jitsu, jiu jitsu, ju-jutsu)  
 13 drawing the opponent off balance to the right and forward  
 14 judoka (judoist)  
 15 coloured (*Am.* colored) belt, as a symbol of Dan grade  
 16 referee  
 17 judo throw  
 18-19 karate  
 18 karateka  
 19 side thrust kick, a kicking technique  
 20-50 boxing (boxing match)  
 20-24 training apparatus (training equipment)  
 20 spring-supported punch ball  
 21 punch bag (*Am.* punching bag)  
 22 speed ball  
 23 suspended punch ball  
 24 punch ball  
 25 boxer, an amateur boxer (boxes in a singlet, vest, *Am.* undershirt) or a professional boxer (boxes without singlet)  
 26 boxing glove  
 27 sparring partner  
 28 straight punch (straight blow)  
 29 ducking and sidestepping  
 30 headguard  
 31 infighting; *here*: clinch  
 32 uppercut  
 33 hook to the head; *here*: right hook

- 34 punch below the belt, a foul punch (illegal punch, foul)  
 35-50 boxing match (boxing contest), a title fight (title bout)  
 35 boxing ring (ring)  
 36 ropes  
 37 stay wire (stay rope)  
 38 neutral corner  
 39 winner  
 40 loser by a knockout  
 41 referee  
 42 counting out  
 43 judge  
 44 second  
 45 manager  
 46 gong  
 47 timekeeper  
 48 record keeper  
 49 press photographer  
 50 sports reporter (reporter)

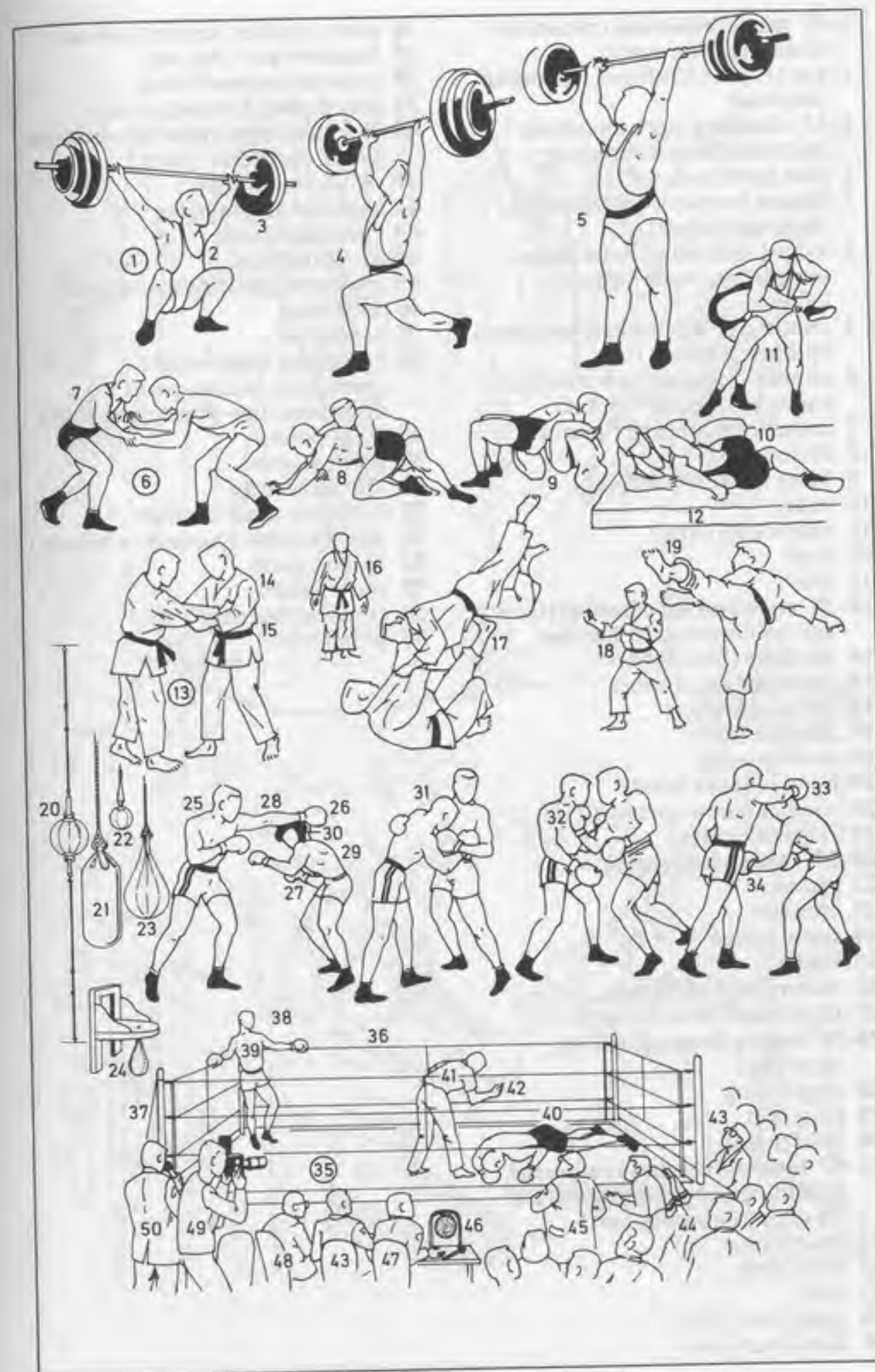



- 1-57 **mountaineering** (mountain climbing, Alpinism)
- 1 hut (Alpine Club hut, mountain hut, base)
- 2-13 **climbing** (rock climbing) [rock climbing technique]
- 2 rock face (rock wall)
- 3 fissure (vertical, horizontal, or diagonal fissure)
- 4 ledge (rock ledge, grass ledge, scree ledge, snow ledge, ice ledge)
- 5 mountaineer (climber, mountain climber, Alpinist)
- 6 anorak (high-altitude anorak, snowshirt, padded jacket)
- 7 breeches (climbing breeches)
- 8 chimney
- 9 belay (spike, rock spike)
- 10 belay
- 11 rope sling (sling)
- 12 rope
- 13 spur
- 14-21 **snow and ice climbing** [snow and ice climbing technique]
- 14 ice slope (firn slope)
- 15 snow and ice climber
- 16 ice axe (*Am. ax*)
- 17 step (ice step)
- 18 snow goggles
- 19 hood (anorak hood)
- 20 cornice (snow cornice)
- 21 ridge (ice ridge)
- 22-27 **rope** (roped party)
- 22 glacier
- 23 crevasse
- 24 snow bridge
- 25 leader
- 26 second man (belayer)
- 27 third man (non-belayer)
- 28-30 **roping down** (abseiling, rapelling)
- 28 abseil sling
- 29 sling seat
- 30 Dülfer seat
- 31-57 **mountaineering equipment** (climbing equipment, snow and ice climbing equipment)
- 31 ice axe (*Am. ax*)
- 32 wrist sling
- 33 pick
- 34 adze (*Am. adz*)
- 35 karabiner hole
- 36 short-shafted ice axe (*Am. ax*)
- 37 hammer axe (*Am. ax*)
- 38 general-purpose piton
- 39 abseil piton (ringed piton)
- 40 ice piton (semi-tubular screw ice piton, corkscrew piton)
- 41 drive-in ice piton
- 42 mountaineering boot
- 43 corrugated sole
- 44 climbing boot
- 45 roughened stiff rubber upper
- 46 karabiner
- 47 screwgate
- 48 crampons (lightweight crampons, twelve-point crampons, ten-point crampons)
- 49 front points
- 50 point guards
- 51 crampon strap
- 52 crampon cable fastener
- 53 safety helmet (protective helmet)
- 54 helmet lamp
- 55 snow gaiters
- 56 climbing harness
- 57 sit harness





- 1-72 skiing
- 1 compact ski
  - 2 safety binding (release binding)
  - 3 strap
  - 4 steel edge
  - 5 ski stick (ski pole)
  - 6 grip
  - 7 loop
  - 8 basket
  - 9 ladies' one-piece ski suit
  - 10 skiing cap (ski cap)
  - 11 skiing goggles
  - 12 cemented sole skiing boot
  - 13 crash helmet
  - 14-20 cross-country equipment
  - 14 cross-country ski
  - 15 cross-country rat trap binding
  - 16 cross-country boot
  - 17 cross-country gear
  - 18 peaked cap
  - 19 sunglasses
  - 20 cross-country poles made of bamboo
  - 21-24 ski-waxing equipment
  - 21 ski wax
  - 22 waxing iron (blowlamp, blowtorch)
  - 23 waxing cork
  - 24 wax scraper
  - 25 downhill racing pole
  - 26 herringbone, for climbing a slope
  - 27 sidestep, for climbing a slope
  - 28 ski bag
  - 29 slalom
  - 30 gate pole
  - 31 racing suit
  - 32 downhill racing
  - 33 'egg' position, the ideal downhill racing position
  - 34 downhill ski
  - 35 ski jumping
  - 36 lean forward
  - 37 number
  - 38 ski jumping ski
  - 39 grooves (3 to 5 grooves)
  - 40 cable binding
  - 41 ski jumping boots
  - 42 cross-country
  - 43 cross-country stretch-suit
  - 44 course
  - 45 course-marking flag
  - 46 layers of a modern ski

- 47 special core
- 48 laminates
- 49 stabilizing layer (stabilizer)
- 50 steel edge
- 51 aluminium (*Am.* aluminum) upper edge
- 52 synthetic bottom (artificial bottom)
- 53 safety jet
- 54-56 parts of the binding
- 54 automatic heel unit
- 55 toe unit
- 56 ski stop
- 57-63 ski lift
- 57 double chair lift
- 58 safety bar with footrest
- 59 ski lift
- 60 track
- 61 hook
- 62 automatic cable pulley
- 63 haulage cable
- 64 slalom
- 65 open gate
- 66 closed vertical gate
- 67 open vertical gate
- 68 transversal chicane
- 69 hairpin
- 70 elbow
- 71 corridor
- 72 Allais chicane





- 1-26 ice skating
- 1 ice skater, a solo skater
- 2 tracing leg
- 3 free leg
- 4 pair skaters
- 5 death spiral
- 6 pivot
- 7 stag jump (stag leap)
- 8 jump-sit-spin
- 9 upright spin
- 10 holding the foot
- 11-19 compulsory figures
- 11 curve eight
- 12 change
- 13 three
- 14 double-three
- 15 loop
- 16 change-loop
- 17 bracket
- 18 counter
- 19 rocker
- 20-25 ice skates
- 20 speed skating set (speed skate)
- 21 edge
- 22 hollow grinding (hollow ridge, concave ridge)
- 23 ice hockey set (ice hockey skate)
- 24 ice skating boot
- 25 skate guard
- 26 speed skater
- 27-28 skate sailing
- 27 skate sailor
- 28 hand sail
- 29-37 ice hockey
- 29 ice hockey player
- 30 ice hockey stick
- 31 stick handle
- 32 stick blade
- 33 shin pad
- 34 headgear (protective helmet)
- 35 puck, a vulcanized rubber disc (disk)
- 36 goalkeeper
- 37 goal
- 38-40 ice-stick shooting (Bavarian curling)
- 38 ice-stick shooter (Bavarian curler)
- 39 ice stick
- 40 block
- 41-43 curling
- 41 curler
- 42 curling stone (granite)
- 43 curling brush (curling broom, besom)
- 44-46 ice yachting (iceboating, ice sailing)
- 44 ice yacht (iceboat)
- 45 steering runner
- 46 outrigger runner

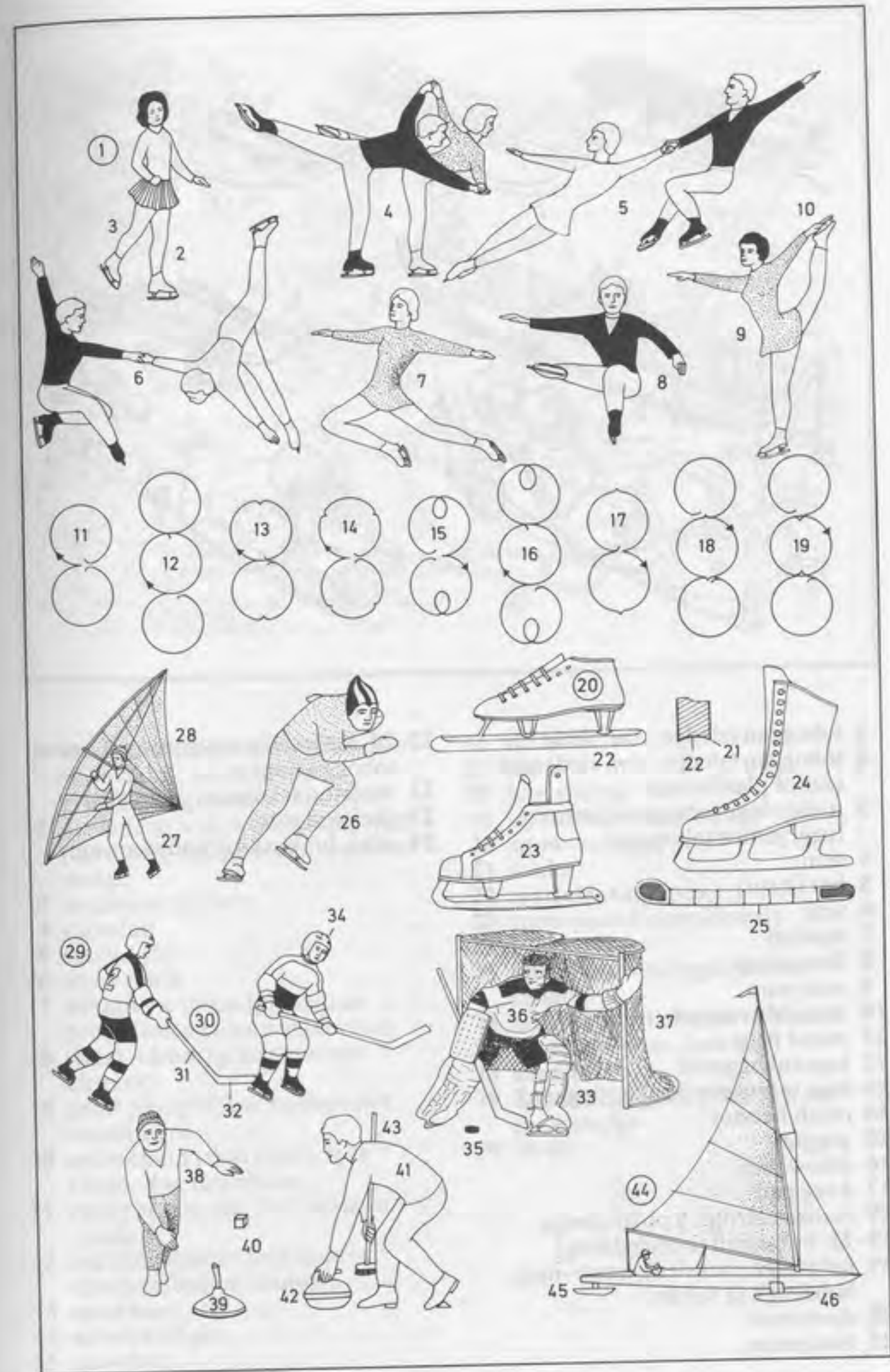



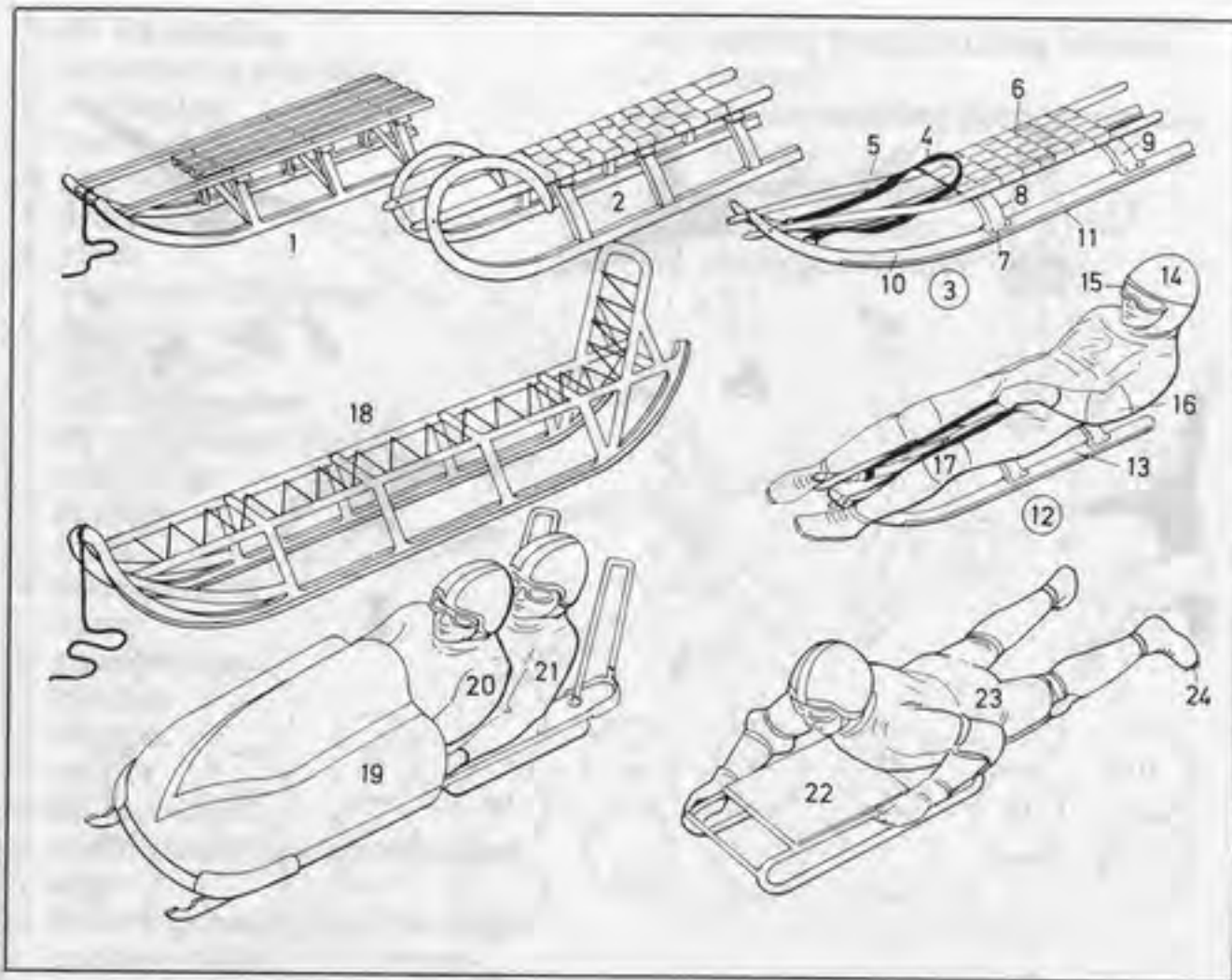

- 1 toboggan (sledge, *Am.* sled)  
 2 toboggan (sledge, *Am.* sled) with seat of plaid straps  
 3 junior luge toboggan (junior luge, junior toboggan)  
 4 rein  
 5 bar (strut)  
 6 seat  
 7 bracket  
 8 front prop  
 9 rear prop  
 10 movable runner  
 11 metal face  
 12 luge tobogganer  
 13 luge toboggan (luge, toboggan)  
 14 crash helmet  
 15 goggles  
 16 elbow pad  
 17 knee pad  
 18 Nansen sledge, a polar sledge  
 19-21 bobsleigh (bobsledding)  
 19 bobsleigh (bobsled), a two-man bobsleigh (a boblet)  
 20 steersman  
 21 brakeman  
 22-24 skeleton tobogganing (*Cresta* tobogganing)  
 22 skeleton (skeleton toboggan)  
 23 skeleton rider  
 24 rake, for braking and steering

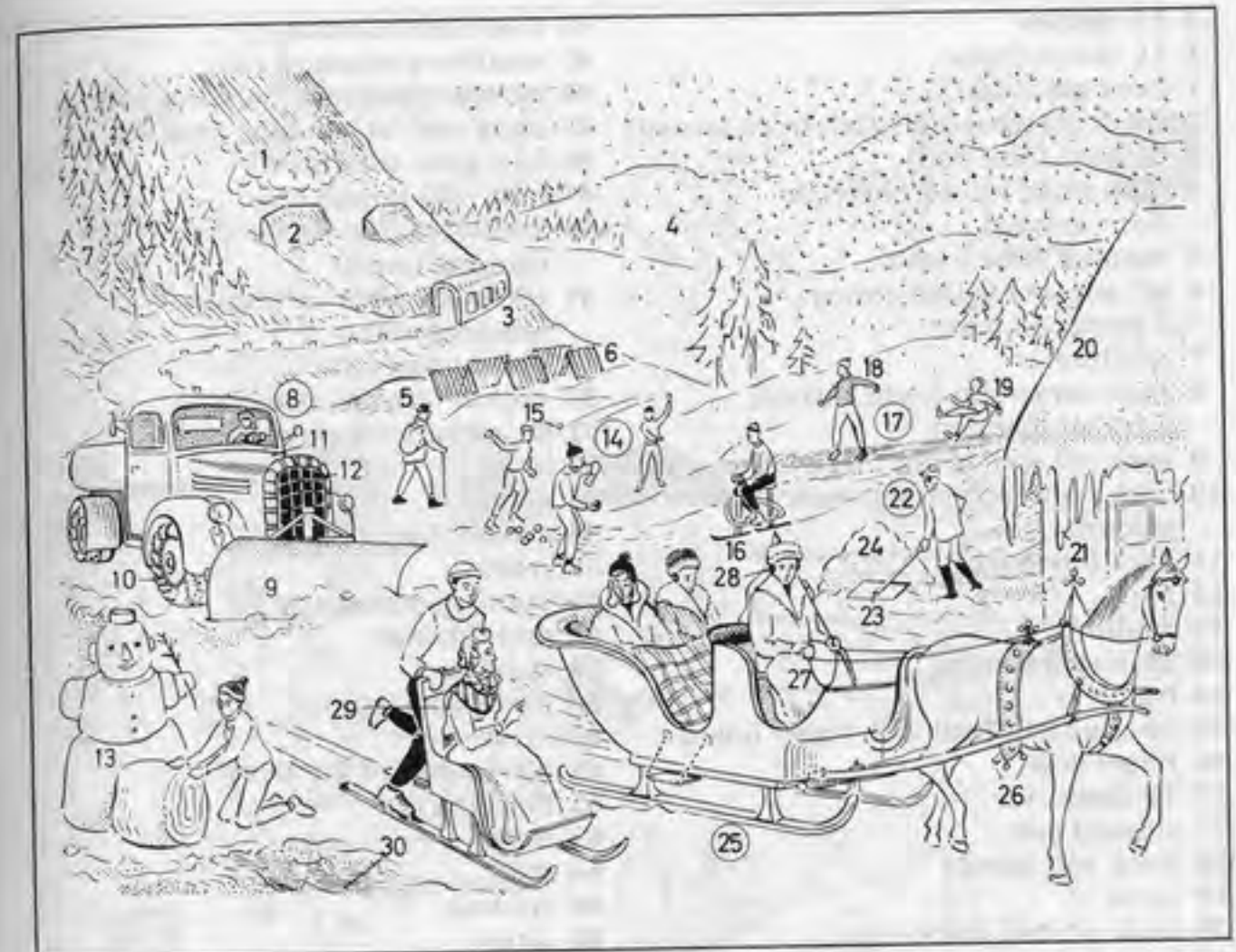

- 1 avalanche (snow avalanche, *Am.* snowslide); *kinds*: wind avalanche, ground avalanche  
 2 avalanche wall, a deflecting wall (diverting wall); *sim.*: avalanche wedge  
 3 avalanche gallery  
 4 snowfall  
 5 snowdrift  
 6 snow fence  
 7 avalanche forest [planted as protection against avalanches]  
 8 street-cleaning lorry (street cleaner)  
 9 snow plough (*Am.* snowplow) attachment  
 10 snow chain (skid chain, tyre chain, *Am.* tire chain)  
 11 radiator bonnet (*Am.* radiator hood)  
 12 radiator shutter and shutter opening (louvre shutter)  
 13 snowman  
 14 snowball fight  
 15 snowball  
 16 ski bob  
 17 slide  
 18 boy, sliding  
 19 icy surface (icy ground)  
 20 snow-covered roof  
 21 icicle  
 22 man clearing snow  
 23 snow push (snow shovel)  
 24 heap of snow  
 25 horse-drawn sleigh (horse sleigh)  
 26 sleigh bells (bells, set of bells)  
 27 foot muff (*Am.* foot bag)  
 28 earmuff  
 29 handsledge (tread sledge); *sim.*: push sledge  
 30 slush



- 1-13 skittles  
 1-11 skittle frame  
 1 front pin (front)  
 2 left front second pin (left front second)  
 3 running three [left]  
 4 right front second pin (right front second)  
 5 running three [right]  
 6 left corner pin (left corner), a corner (copper)  
 7 landlord  
 8 right corner pin (right corner), a corner (copper)  
 9 back left second pin (back left second)  
 10 back right second pin (back right second)  
 11 back pin (back)  
 12 pin  
 13 landlord  
 14-20 tenpin bowling  
 14 frame  
 15 bowling ball (ball with finger holes)  
 16 finger hole  
 17-20 deliveries  
 17 straight ball  
 18 hook ball (hook)  
 19 curve  
 20 back-up ball (back-up)  
 21 boules; *sim.*: Italian game of bocce, green bowls (bowls)  
 22 boules player  
 23 jack (target jack)  
 24 grooved boule  
 25 group of players  
 26 rifle shooting  
 27-29 shooting positions  
 27 standing position  
 28 kneeling position  
 29 prone position  
 30-33 targets  
 30 target for 50 m events (50 m target)  
 31 circle  
 32 target for 100 m events (100 m target)  
 33 bobbing target (turning target, running-boar target)  
 34-39 ammunition  
 34 air rifle cartridge  
 35 rimfire cartridge for zimmerstutzen (indoor target rifle), a smallbore German single-shot rifle  
 36 case head  
 37 caseless round  
 38 .22 long rifle cartridge  
 39 .222 Remington cartridge  
 40-49 sporting rifles  
 40 air rifle  
 41 optical sight  
 42 front sight (foresight)  
 43 smallbore standard rifle  
 44 international smallbore free rifle  
 45 palm rest for standing position  
 46 butt plate with hook  
 47 butt with thumb hole  
 48 smallbore rifle for bobbing target (turning target)  
 49 telescopic sight (riflescope, telescope sight)  
 50 optical ring sight  
 51 optical ring and bead sight  
 52-66 archery (target archery)  
 52 shot  
 53 archer  
 54 competition bow  
 55 riser  
 56 point-of-aim mark  
 57 grip (handle)  
 58 stabilizer  
 59 bow string (string)  
 60 arrow  
 61 pile (point) of the arrow  
 62 fletching  
 63 nock  
 64 shaft  
 65 crestring  
 66 target  
 67 Basque game of pelota (jai alai)  
 68 pelota player  
 69 wicker basket (cesta)  
 70-78 skeet (skeet shooting), a kind of clay pigeon shooting  
 70 skeet over-and-under shotgun  
 71 muzzle with skeet choke  
 72 ready position on call  
 73 firing position  
 74 shooting range  
 75 high house  
 76 low house  
 77 target's path  
 78 shooting station (shooting box)  
 79 aero wheel  
 80 handle  
 81 footrest  
 82 go-karting (karting)  
 83 go-kart (kart)  
 84 number plate (number)  
 85 pedals  
 86 pneumatic tyre (*Am.* tire)  
 87 petrol tank (*Am.* gasoline tank)  
 88 frame  
 89 steering wheel  
 90 bucket seat  
 91 protective bulkhead  
 92 two-stroke engine  
 93 silencer (*Am.* muffler)

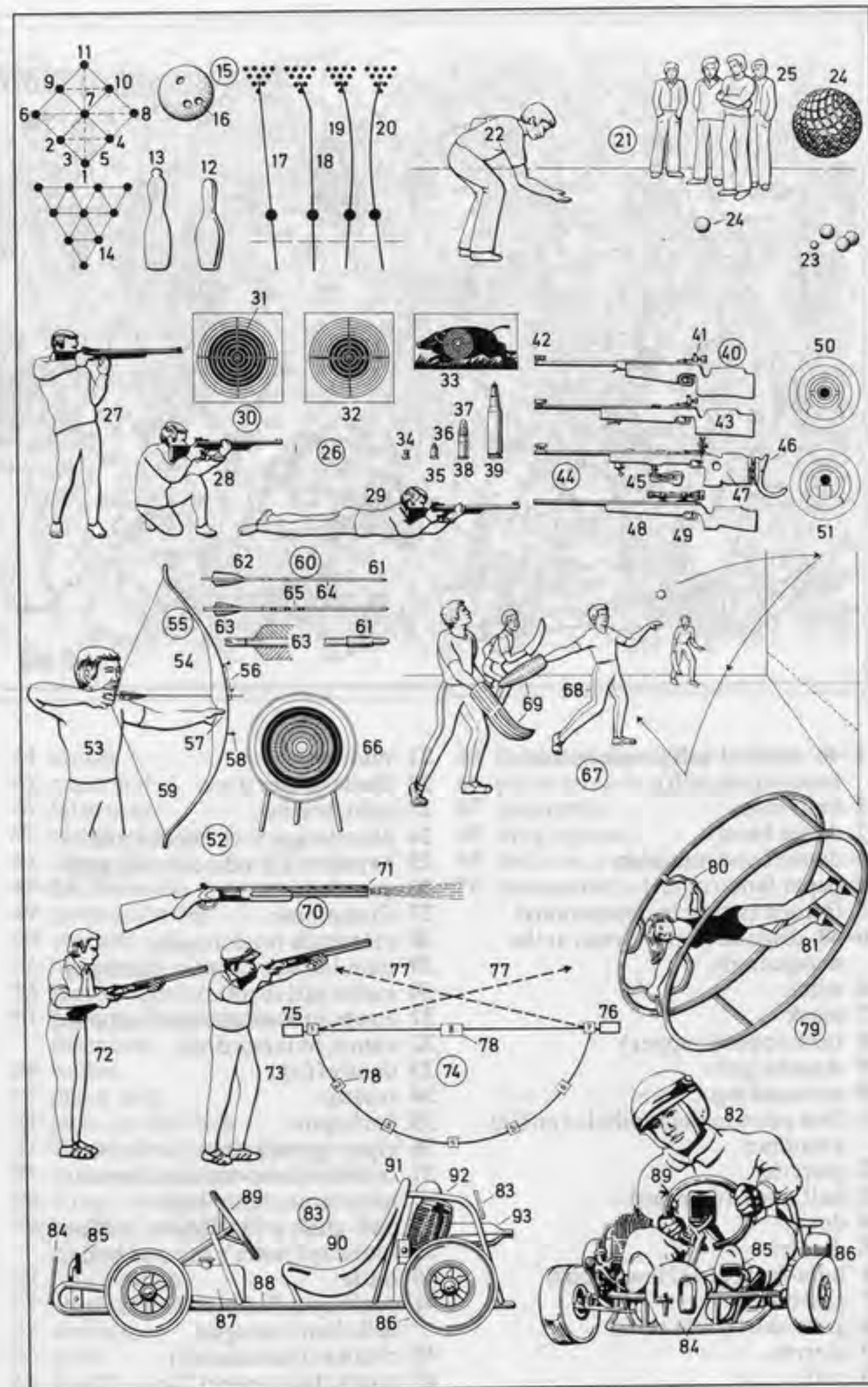





- 1-48 masked ball (masquerade, fancy-dress ball)  
 1 ballroom  
 2 dance band  
 3 dance band musician  
 4 paper lantern  
 5 festoon (string of decorations)  
 6-48 disguise (fancy dress) at the masquerade  
 6 witch  
 7 mask  
 8 fur trapper (trapper)  
 9 Apache girl  
 10 net stocking  
 11 first prize in the tombola (raffle), a hamper  
 12 pierette  
 13 half mask (domino)  
 14 devil  
 15 domino  
 16 hula-hula girl (Hawaii girl)  
 17 garland  
 18 grass skirt (hula skirt)  
 19 pierrot  
 20 ruff  
 21 midinette  
 22 Biedermeier dress  
 23 poke bonnet  
 24 décolletage with beauty spot  
 25 bayadère (Hindu dancing girl)  
 26 grandee  
 27 Columbine  
 28 maharaja (maharajah)  
 29 mandarin, a Chinese dignitary  
 30 exotic girl (exotic)  
 31 cowboy; *sim.*: gaucho (vaquero)  
 32 vamp, in fancy dress  
 33 dandy (fop)  
 34 rosette  
 35 harlequin  
 36 gipsy (gypsy) girl  
 37 cocotte (demi-monde, demi-mondaine, demi-rep)  
 38 owl-glass, a fool (jester, buffoon)  
 39 foolscap (jester's cap and bells)  
 40 rattle  
 41 odalisque, Eastern female slave in Sultan's seraglio  
 42 chalwar (pantaloon)  
 43 pirate (buccaneer)

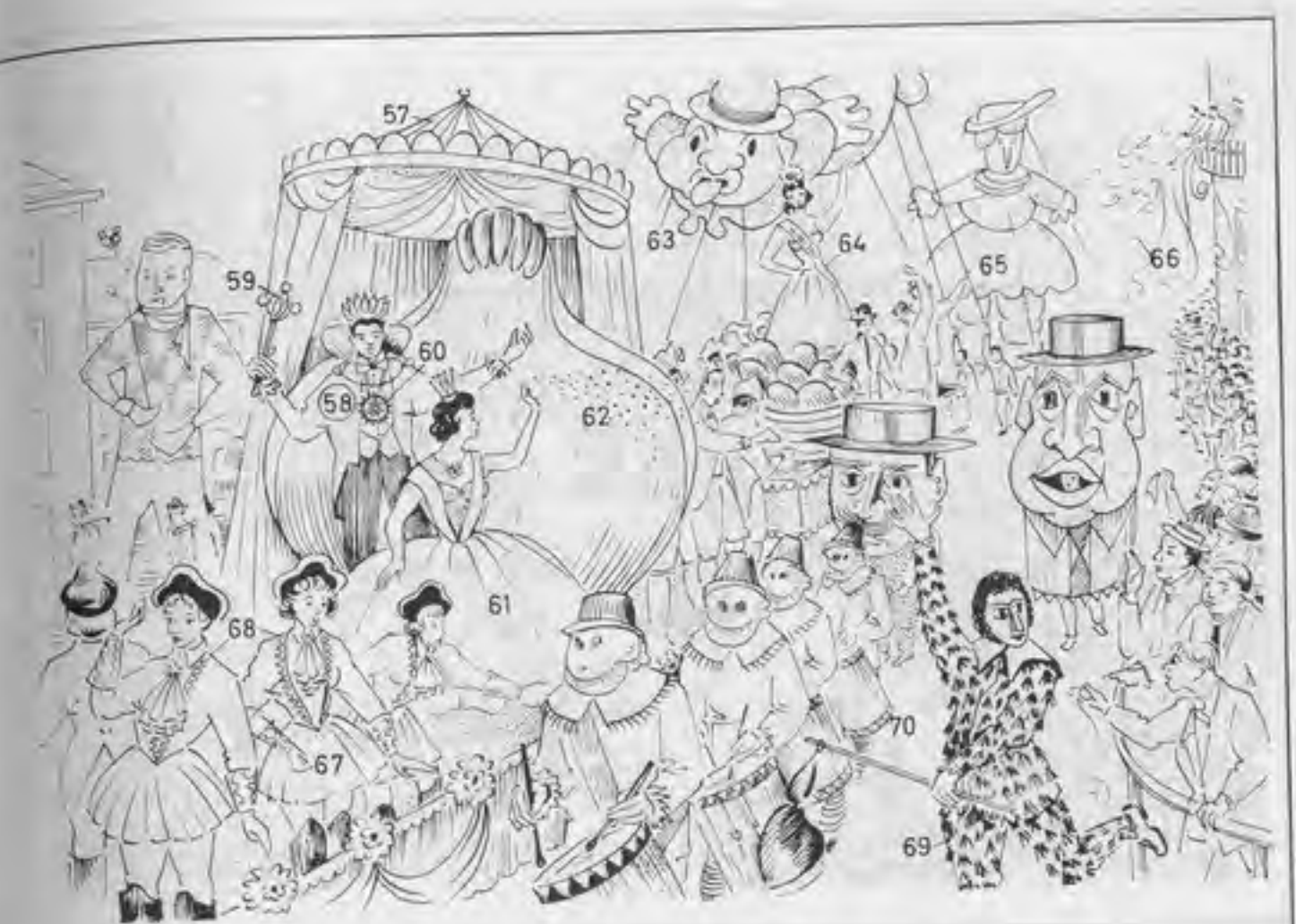

- 44 tattoo  
 45 paper hat  
 46 false nose  
 47 clapper (rattle)  
 48 slapstick  
 49-54 fireworks  
 49 percussion cap  
 50 cracker  
 51 banger  
 52 jumping jack  
 53 cannon cracker (maroon, marroon)  
 54 rocket  
 55 paper ball  
 56 jack-in-the-box  
 57-70 carnival procession  
 57 carnival float (carnival truck)  
 58 King Carnival  
 59 bauble (fool's sceptre, *Am.* scepter)  
 60 fool's badge  
 61 Queen Carnival  
 62 confetti  
 63 giant  
 64 beauty queen  
 65 fairy-tale figure  
 66 paper streamer  
 67 majorette  
 68 king's guard  
 69 buffoon, a clown  
 70 lansquenet's drum



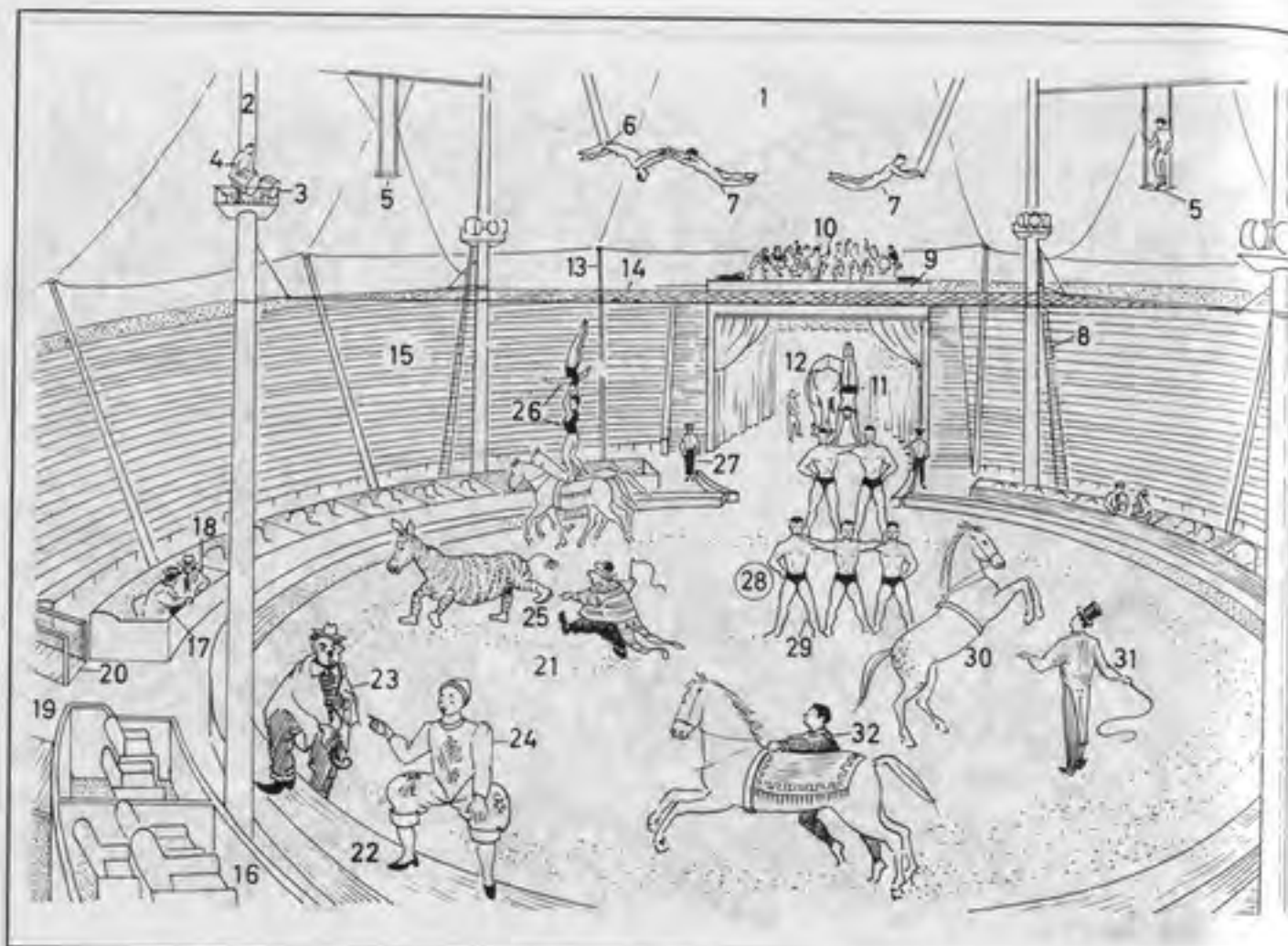

- 1-63 travelling (*Am.* traveling) circus
- 1 circus tent (big top), a four-pole tent
- 2 tent pole
- 3 spotlight
- 4 lighting technician
- 5 trapeze platform
- 6 trapeze
- 7 trapeze artist
- 8 rope ladder
- 9 bandstand
- 10 circus band
- 11 ring entrance (arena entrance)
- 12 wings
- 13 tent prop (prop)
- 14 safety net
- 15 seats for the spectators
- 16 circus box
- 17 circus manager
- 18 agent
- 19 entrance and exit
- 20 steps
- 21 ring (arena)
- 22 ring fence

- 23 musical clown (clown)
- 24 clown
- 25 comic turn (clown act), a circus act
- 26 circus riders (bareback riders)
- 27 ring attendant, a circus attendant
- 28 pyramid
- 29 support
- 30-31 performance by liberty horses
- 30 circus horse, performing the levade (*pesade*)
- 31 ringmaster
- 32 vaulter
- 33 emergency exit
- 34 caravan (circus caravan, *Am.* trailer)
- 35 springboard acrobat (springboard artist)
- 36 springboard
- 37 knife thrower
- 38 circus marksman
- 39 assistant
- 40 tightrope dancer
- 41 tightrope

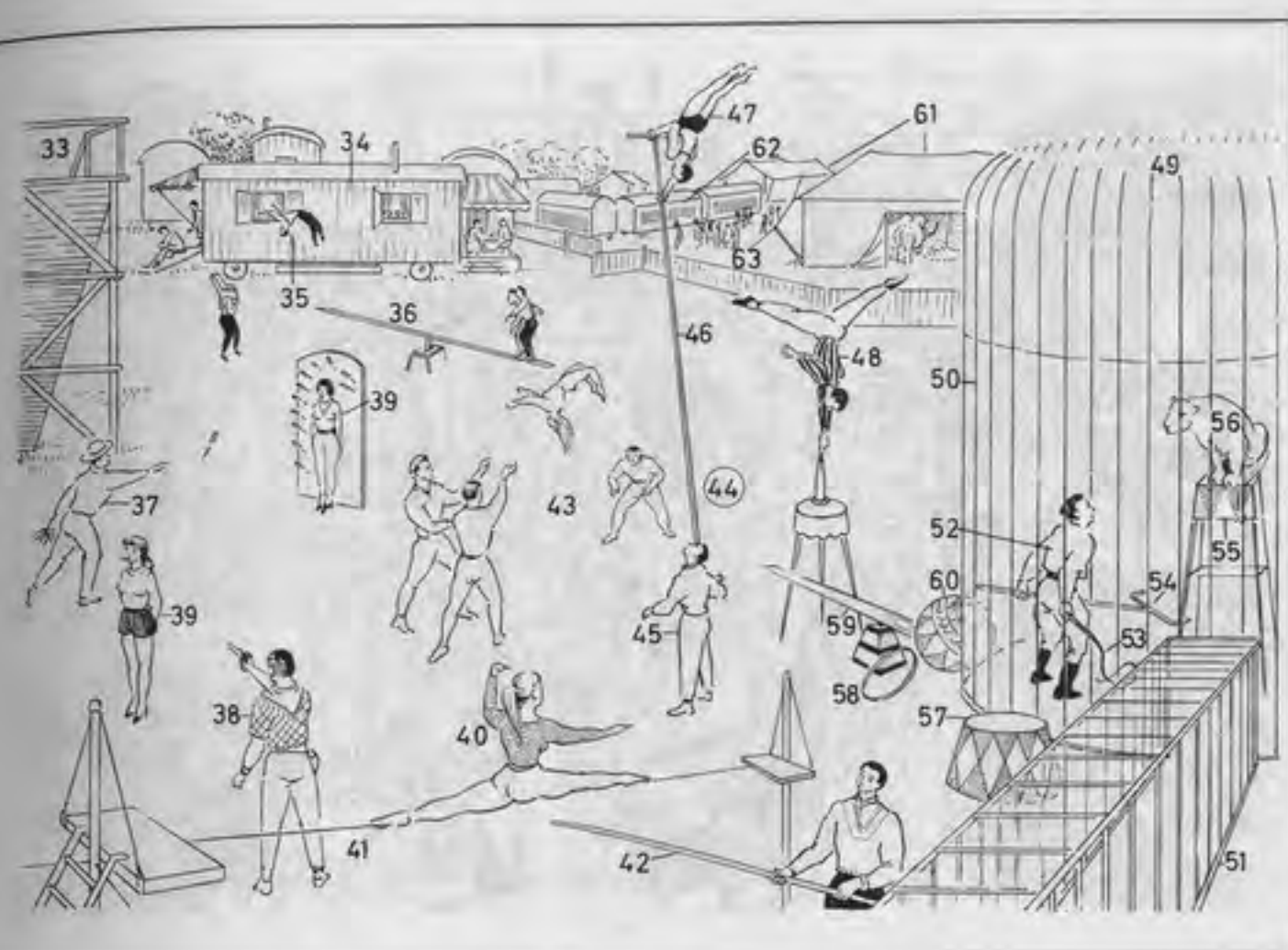

- 42 balancing pole
- 43 throwing act
- 44 balancing act
- 45 support
- 46 pole (bamboo pole)
- 47 acrobat
- 48 equilibrist (balancer)
- 49 wild animal cage, a round cage
- 50 bars of the cage
- 51 passage (barred passage, passage for the wild animals)
- 52 tamer (wild animal tamer)
- 53 whip
- 54 fork
- 55 pedestal
- 56 wild animal (tiger, lion)
- 57 stand
- 58 hoop (jumping hoop)
- 59 seesaw
- 60 ball
- 61 camp
- 62 cage caravan
- 63 menagerie





1-69 fair (annual fair)

- 1 fairground
- 2 children's merry-go-round, (whirligig), a roundabout (*Am.* carousel)
- 3 refreshment stall (drinks stall)
- 4 chairplane
- 5 up-and-down roundabout
- 6 show booth (booth)
- 7 box (box office)
- 8 barker
- 9 medium
- 10 showman
- 11 try-your-strength machine
- 12 hawker
- 13 balloon
- 14 paper serpent
- 15 windmill
- 16 pickpocket (thief)
- 17 vendor
- 18 Turkish delight
- 19 freak show
- 20 giant
- 21 fat lady
- 22 dwarfs (midgets)
- 23 beer marquee
- 24 sideshow
- 25-28 travelling (*Am.* traveling) artistes (travelling show people)
- 25 fire eater
- 26 sword swallower
- 27 strong man
- 28 escapologist
- 29 spectators
- 30 ice-cream vendor (ice-cream man)
- 31 ice-cream cornet
- 32 hot-dog stand
- 33 grill (*Am.* broiler)
- 34 hot dog
- 35 sausage tongs
- 36 fortune teller
- 37 big wheel (Ferris wheel)
- 38 orchestrion (automatic organ)
- 39 scenic railway (switchback)
- 40 toboggan slide (chute)
- 41 swing boats
- 42 swing boat, turning full circle
- 43 full circle
- 44 lottery booth (tombola booth)



- 45 wheel of fortune
- 46 devil's wheel (typhoon wheel)
- 47 throwing ring (quoit)
- 48 prizes
- 49 sandwich man on stilts
- 50 sandwich board (placard)
- 51 cigarette seller, an itinerant trader (a hawker)
- 52 tray
- 53 fruit stall
- 54 wall-of-death rider
- 55 hall of mirrors
- 56 concave mirror
- 57 convex mirror
- 58 shooting gallery
- 59 hippodrome
- 60 junk stalls (second-hand stalls)
- 61 first aid tent (first aid post)
- 62 dodgems (bumper cars)
- 63 dodgem car (bumper car)
- 64-66 pottery stand
- 64 barker
- 65 market woman
- 66 pottery
- 67 visitors to the fair
- 68 waxworks
- 69 wax figure









- 1-13 film studios** (studio complex, *Am.* movie studios)
- 1 lot (studio lot)
- 2 processing laboratories (film laboratories, motion picture laboratories)
- 3 cutting rooms
- 4 administration building (office building, offices)
- 5 film (motion picture) storage vault (film library, motion picture library)
- 6 workshop
- 7 film set (*Am.* movie set)
- 8 power house
- 9 technical and research laboratories
- 10 groups of stages
- 11 concrete tank for marine sequences
- 12 cyclorama
- 13 hill
- 14-60 shooting** (filming)
- 14 music recording studio (music recording theatre, *Am.* theater)
- 15 'acoustic' wall lining
- 16 screen (projection screen)
- 17 film orchestra
- 18 exterior shooting (outdoor shooting, exterior filming, outdoor filming)
- 19 camera with crystal-controlled drive
- 20 cameraman
- 21 assistant director
- 22 boom operator (boom swinger)
- 23 recording engineer (sound recordist)
- 24 portable sound recorder with crystal-controlled drive
- 25 microphone boom
- 26-60 shooting (filming) in the studio (on the sound stage, on the stage, in the filming hall)
- 26 production manager
- 27 leading lady (film actress, film star, star)
- 28 leading man (film actor, film star, star)
- 29 film extra (extra)
- 30 arrangement of microphones for stereo and sound effects

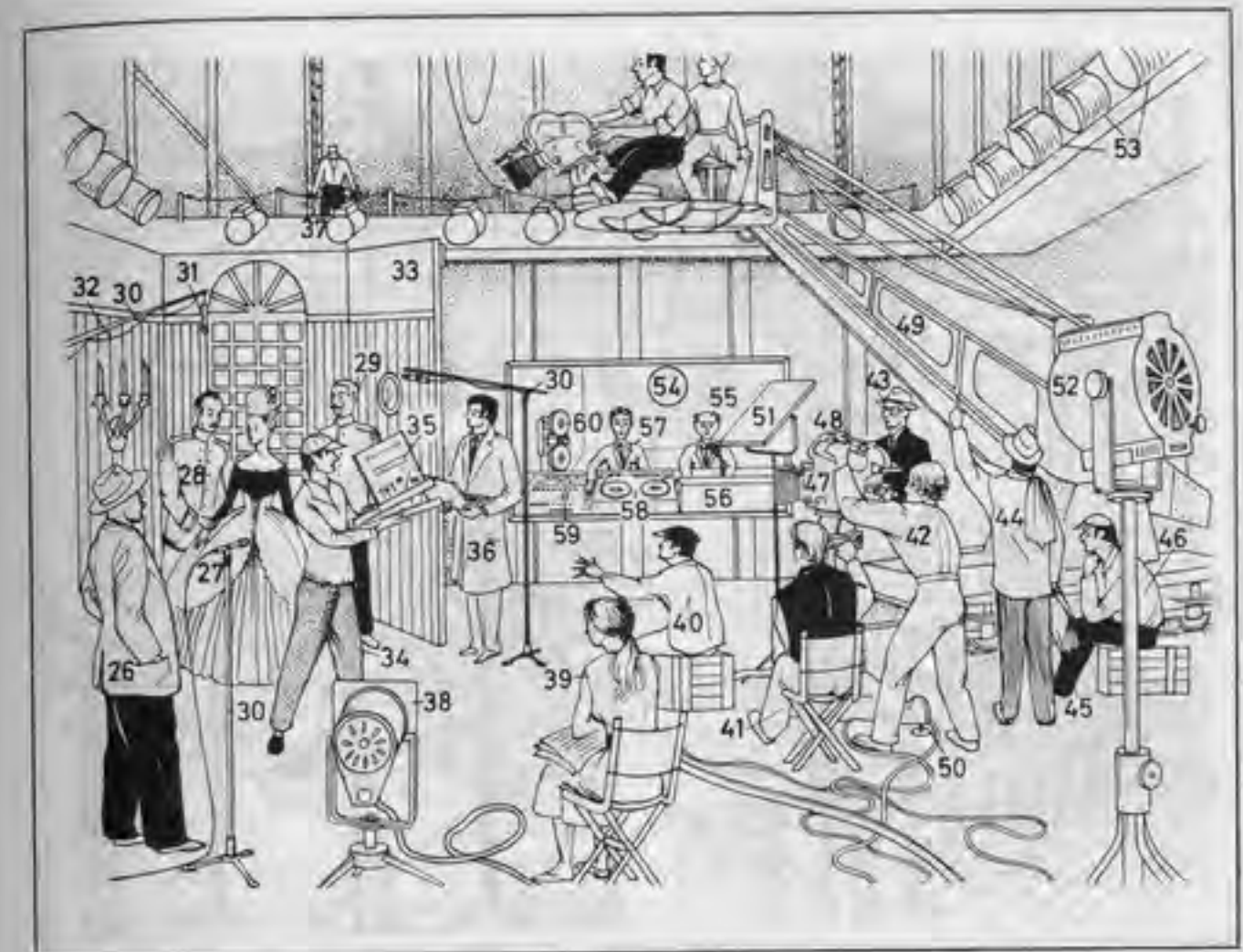

- 31 studio microphone
- 32 microphone cable
- 33 side flats and background
- 34 clapper boy
- 35 clapper board (clapper) with slates (boards) for the film title, shot number (scene number), and take number
- 36 make-up artist (hairstylist)
- 37 lighting electrician (studio electrician, lighting man, *Am.* gaffer)
- 38 diffusing screen
- 39 continuity girl (script girl)
- 40 film director (director)
- 41 cameraman (first cameraman)
- 42 camera operator, an assistant cameraman (camera assistant)
- 43 set designer (art director)
- 44 director of photography
- 45 filmscript (script, shooting script, *Am.* movie script)
- 46 assistant director
- 47 soundproof film camera (soundproof motion picture camera), a wide screen camera (cinemascope camera)
- 48 soundproof housing (soundproof cover, blimp)
- 49 camera crane (dolly)
- 50 hydraulic stand
- 51 mask (screen) for protection from spill light (gobo, nigger)
- 52 tripod spotlight (fill-in light, filler light, fill light, filler)
- 53 spotlight catwalk
- 54 recording room
- 55 recording engineer (sound recordist)
- 56 mixing console (mixing desk)
- 57 sound assistant (assistant sound engineer)
- 58 magnetic sound recording equipment (magnetic sound recorder)
- 59 amplifier and special effects equipment, e.g. for echo and sound effects
- 60 sound recording camera (optical sound recorder)



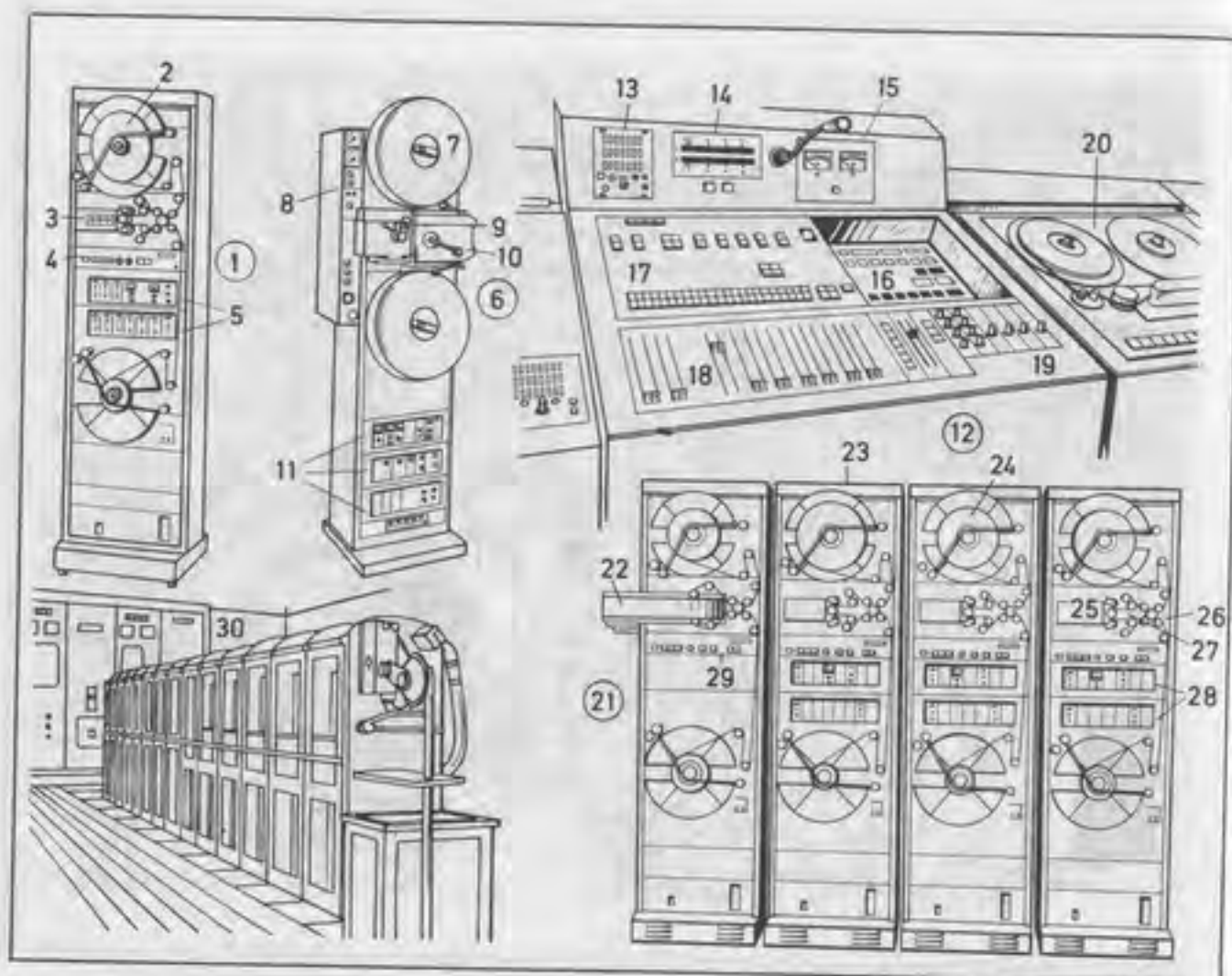

- 1-46 sound recording and re-recording (dubbing)**
- 1 magnetic sound recording equipment (magnetic sound recorder)
  - 2 magnetic film spool
  - 3 magnetic head support assembly
  - 4 control panel
  - 5 magnetic sound recording and playback amplifier
  - 6 optical sound recorder (sound recording camera, optical sound recording equipment)
  - 7 daylight film magazine
  - 8 control and monitoring panel
  - 9 eyepiece for visual control of optical sound recording
  - 10 deck
  - 11 recording amplifier and mains power unit
  - 12 control desk (control console)
  - 13 monitoring loudspeaker (control loudspeaker)
  - 14 recording level indicators
  - 15 monitoring instruments

- 16 jack panel
- 17 control panel
- 18 sliding control
- 19 equalizer
- 20 magnetic sound deck
- 21 mixer for magnetic film
- 22 film projector
- 23 recording and playback equipment
- 24 film reel (film spool)
- 25 head support assembly for the recording head, playback head, and erasing head (erase head)
- 26 film transport mechanism
- 27 synchronizing filter
- 28 magnetic sound amplifier
- 29 control panel
- 30 film-processing machines (film-developing machines) in the processing laboratory (film laboratory, motion picture laboratory)
- 31 echo chamber
- 32 echo chamber loudspeaker
- 33 echo chamber microphone

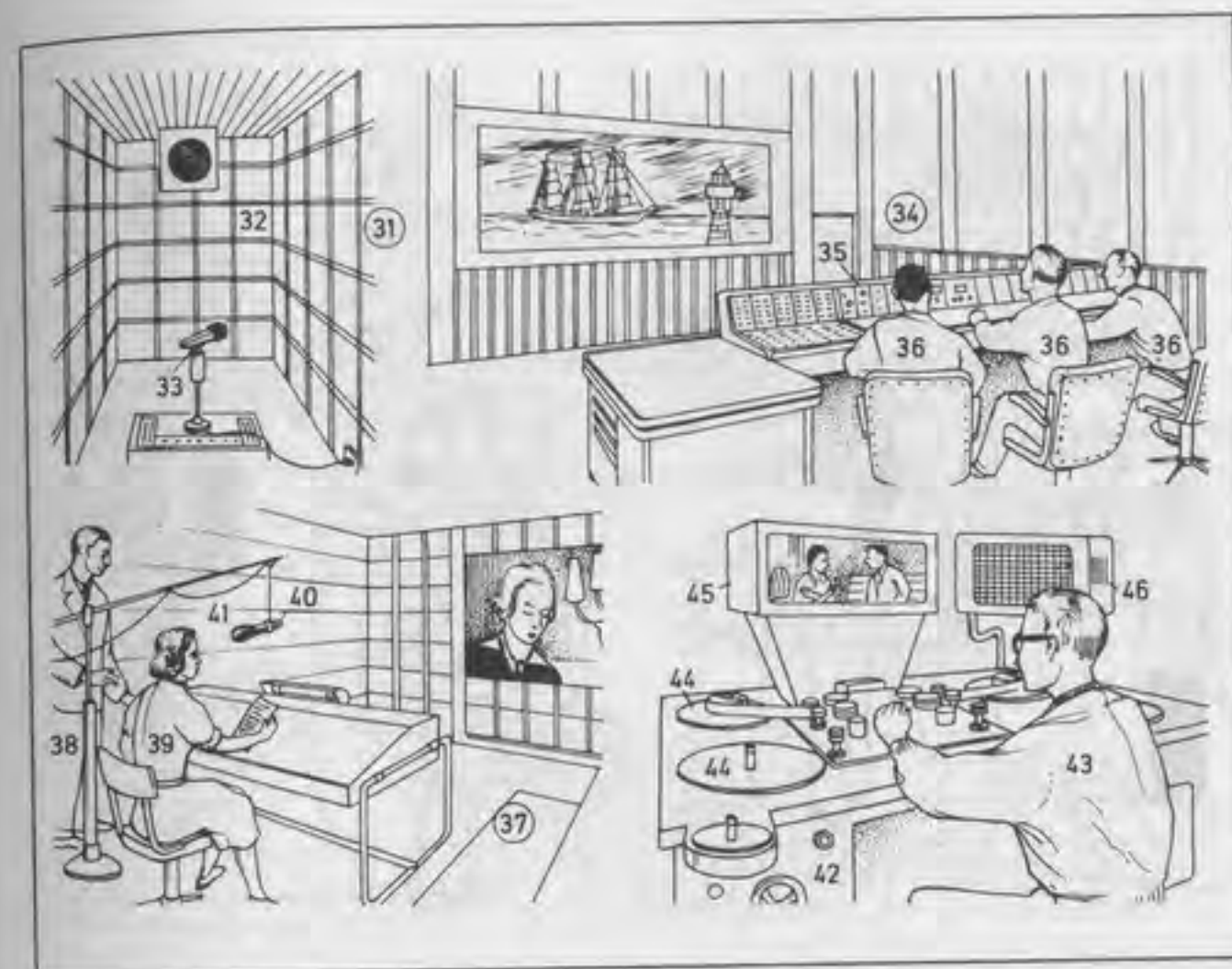

- 34-36 sound mixing (sound dubbing, mixing of several sound tracks)
- 34 mixing room (dubbing room)
- 35 mixing console (mixing desk) for mono or stereo sound
- 36 dubbing mixers (recording engineers, sound recordists) dubbing (mixing)
- 37-41 synchronization (syncing, dubbing, post-synchronization, post-syncing)
- 37 dubbing studio (dubbing theatre, Am. theater)
- 38 dubbing director
- 39 dubbing speaker (dubbing actress)
- 40 boom microphone
- 41 microphone cable

- 42-46 cutting (editing)
- 42 cutting table (editing table, cutting bench)
- 43 film editor (cutter)
- 44 film turntable, for picture and sound tracks
- 45 projection of the picture
- 46 loudspeaker



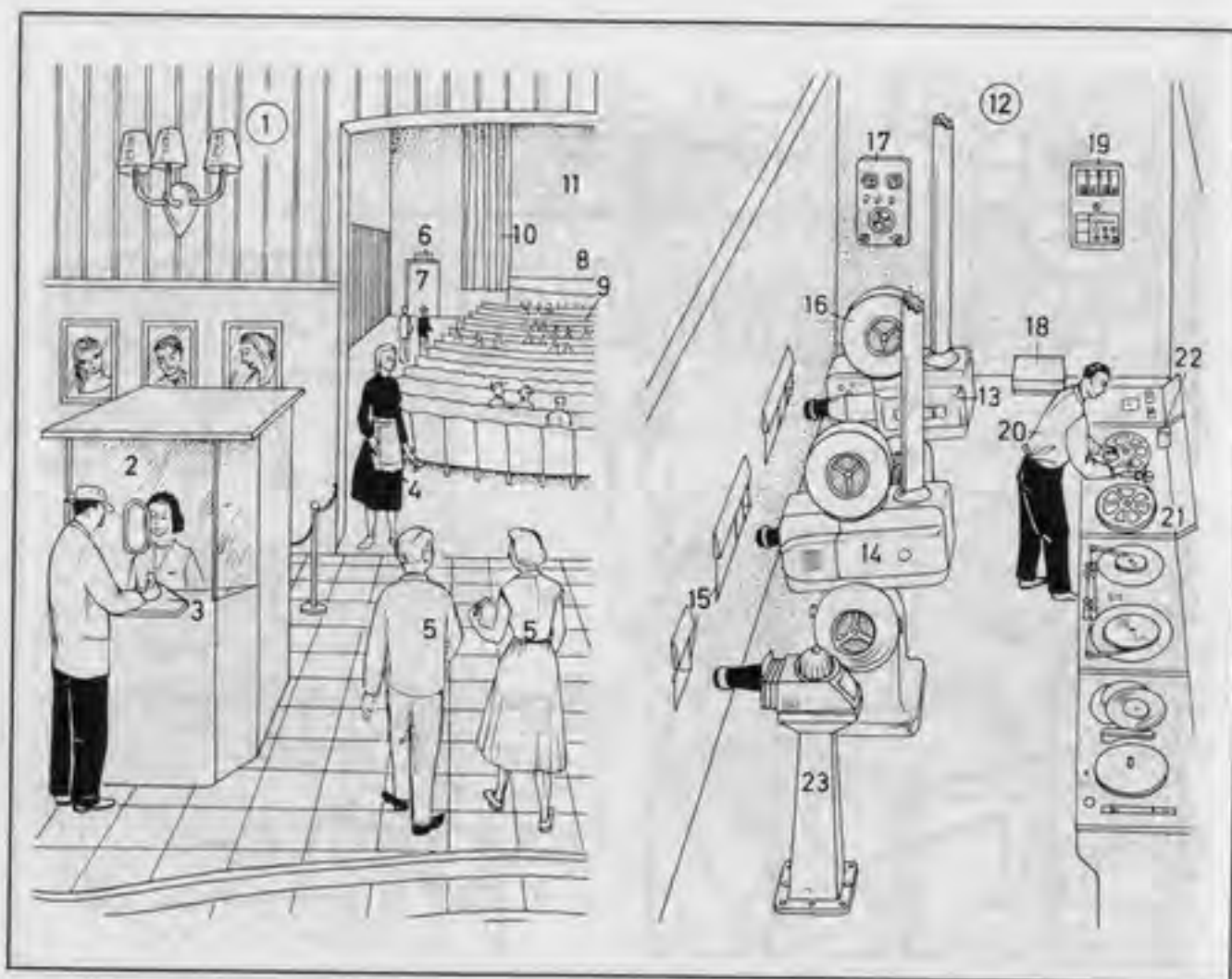

- 1-23 film projection** (motion picture projection)
- 1 cinema (picture house, *Am.* movie theater, movie house)
- 2 cinema box office (*Am.* movie theater box office)
- 3 cinema ticket (*Am.* movie theater ticket)
- 4 usherette
- 5 cinemagoers (filmgoers, cinema audience, *Am.* moviegoers, movie audience)
- 6 safety lighting (emergency lighting)
- 7 emergency exit
- 8 stage
- 9 rows of seats (rows)
- 10 stage curtain (screen curtain)
- 11 screen (projection screen)
- 12 projection room (projection booth)
- 13 lefthand projector
- 14 righthand projector
- 15 projection room window with projection window and observation port

- 16 reel drum (spool box)
- 17 house light dimmers (auditorium lighting control)
- 18 rectifier, a selenium or mercury vapour rectifier for the projection lamps
- 19 amplifier
- 20 projectionist
- 21 rewind bench for rewinding the film
- 22 film cement (splicing cement)
- 23 slide projector for advertisements
- 24-52 film projectors**
- 24 sound projector (film projector, cinema projector, theatre projector, *Am.* movie projector)
- 25-38 projector mechanism**
- 25 fireproof reel drums (spool boxes) with circulating oil cooling system
- 26 feed sprocket (supply sprocket)
- 27 take-up sprocket
- 28 magnetic head cluster
- 29 guide roller (guiding roller) with framing control

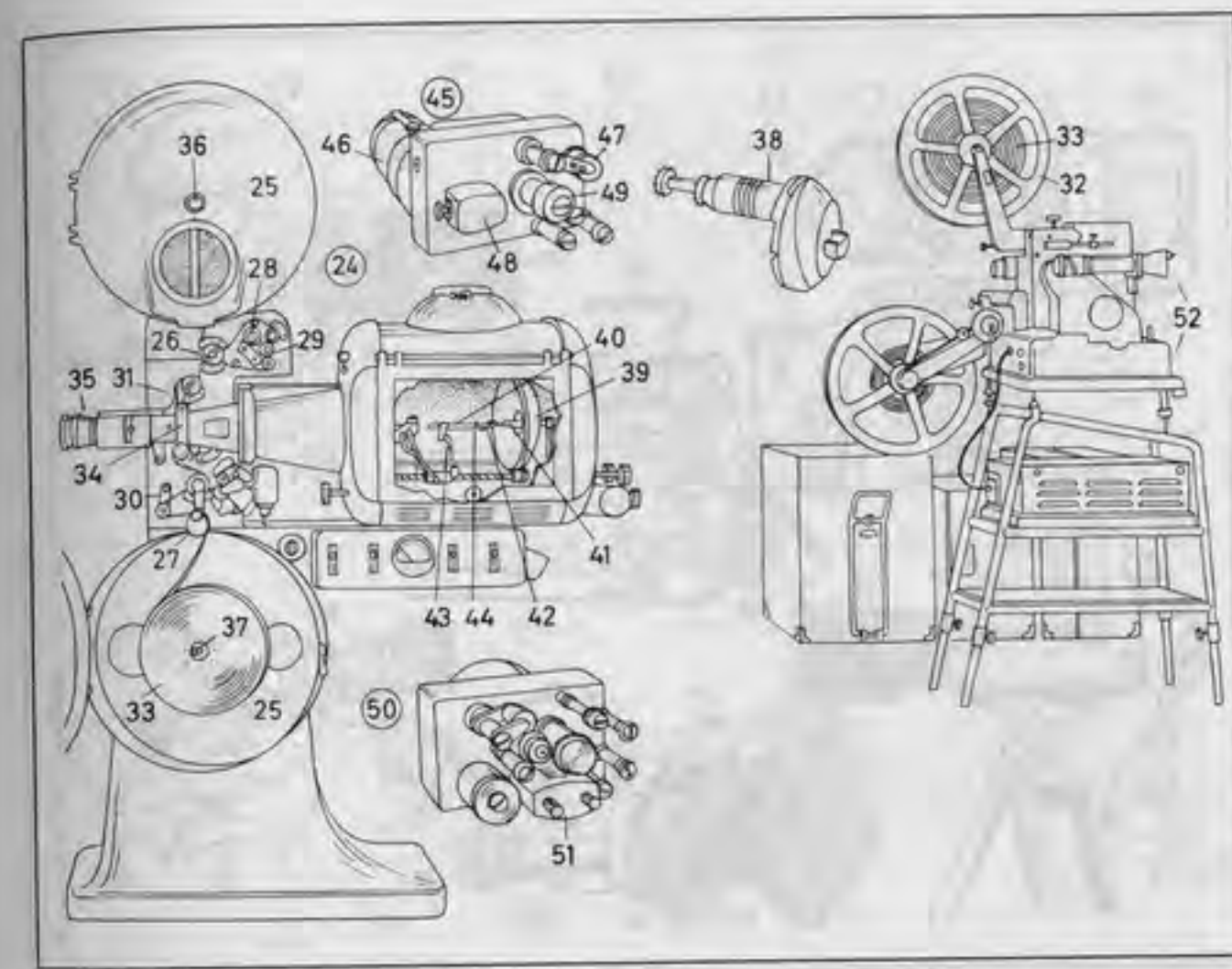

- 30 loop former for smoothing out the intermittent movement; *also*: film break detector
- 31 film path
- 32 film reel (film spool)
- 33 reel of film
- 34 film gate (picture gate, projector gate) with cooling fan
- 35 projection lens (projector lens)
- 36 feed spindle
- 37 take-up spindle with friction drive
- 38 maltese cross mechanism (maltese cross movement, Geneva movement)
- 39-44 lamphouse
- 39 mirror arc lamp, with aspherical (non-spherical) concave mirror and blowout magnet for stabilizing the arc (*also*: high-pressure xenon arc lamp)
- 40 positive carbon (positive carbon rod)
- 41 negative carbon (negative carbon rod)
- 42 arc
- 43 carbon rod holder
- 44 crater (carbon crater)
- 45 optical sound unit [also designed for multi-channel optical stereophonic sound and for push-pull sound tracks]
- 46 sound optics
- 47 sound head
- 48 exciter lamp in housing
- 49 photocell in hollow drum
- 50 attachable four-track magnetic sound unit (penthouse head, magnetic sound head)
- 51 four-track magnetic head
- 52 narrow-gauge (*Am.* narrow-gauge) cinema projector for mobile cinema



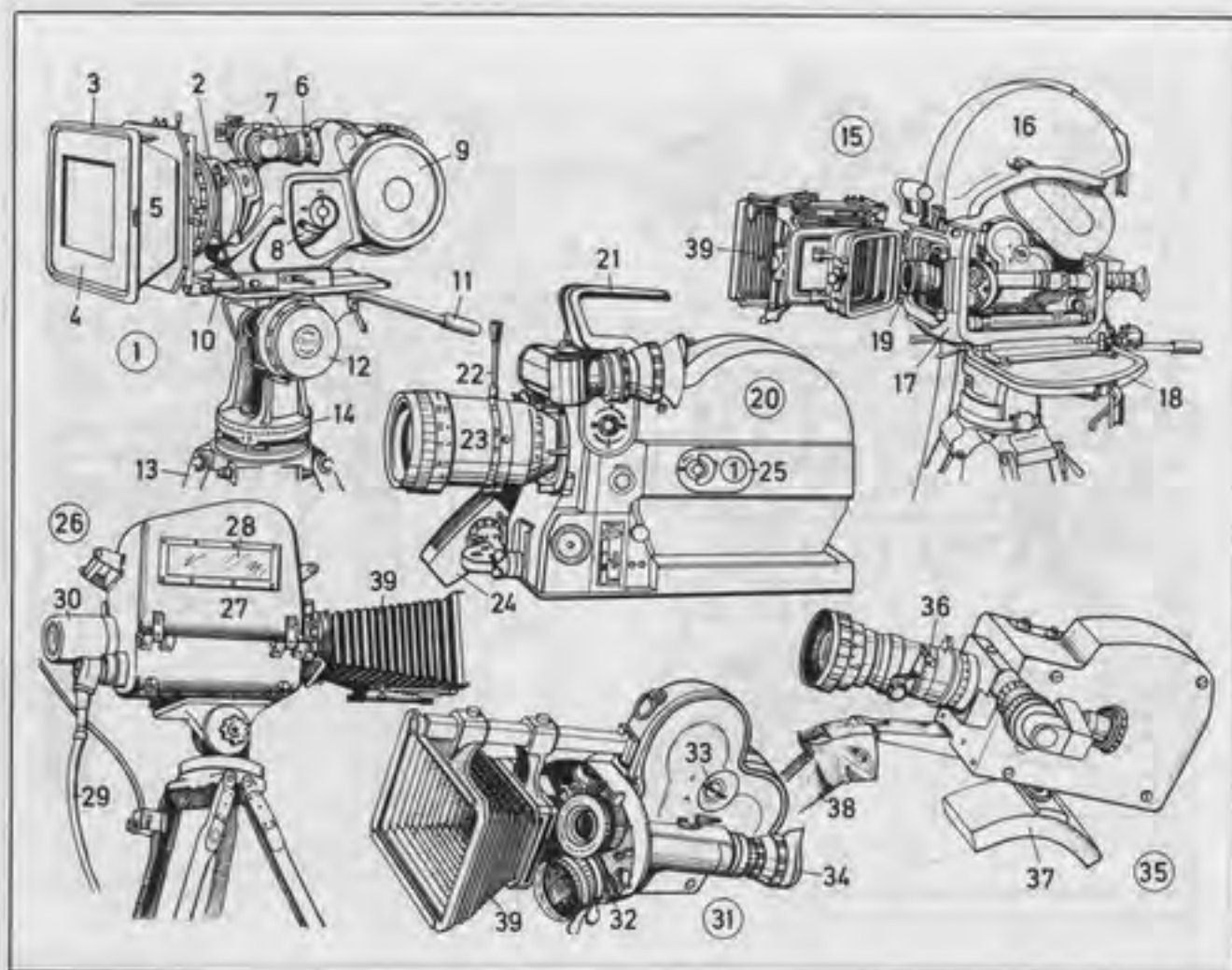

- 1-39 motion picture cameras (film cameras)
- 1 standard-gauge (*Am.* standard-gauge) motion picture camera (standard-gauge, *Am.* standard-gauge, 35 mm camera)
- 2 lens (object lens, taking lens)
- 3 lens hood (sunshade) with matte box
- 4 matte (mask)
- 5 lens hood barrel
- 6 viewfinder eyepiece
- 7 eyepiece control ring
- 8 opening control for the segment disc (disk) shutter
- 9 magazine housing
- 10 slide bar for the lens hood
- 11 control arm (control lever)
- 12 pan and tilt head
- 13 wooden tripod
- 14 degree scale
- 15 soundproof (blimped) motion picture camera (film camera)
- 16-18 soundproof housing (blimp)
- 16 upper section of the soundproof housing
- 17 lower section of the soundproof housing
- 18 open sidewall of the soundproof housing
- 19 camera lens
- 20 lightweight professional motion picture camera
- 21 grip (handgrip)
- 22 zooming lever
- 23 zoom lens (variable focus lens, varifocal lens) with infinitely variable focus
- 24 handgrip with shutter release
- 25 camera door
- 26 sound camera (newsreel camera) for recording sound and picture
- 27 soundproof housing (blimp)
- 28 window for the frame counters and indicator scales
- 29 pilot tone cable (sync pulse cable)
- 30 pilot tone generator (signal generator, pulse generator)
- 31 professional narrow-gauge (*Am.* narrow-gauge) motion picture camera, a 16 mm camera
- 32 lens turret (turret head)
- 33 housing lock
- 34 eyecup
- 35 high-speed camera, a special narrow-gauge (*Am.* narrow-gauge) camera
- 36 zooming lever
- 37 rifle grip
- 38 handgrip with shutter release
- 39 lens hood bellows

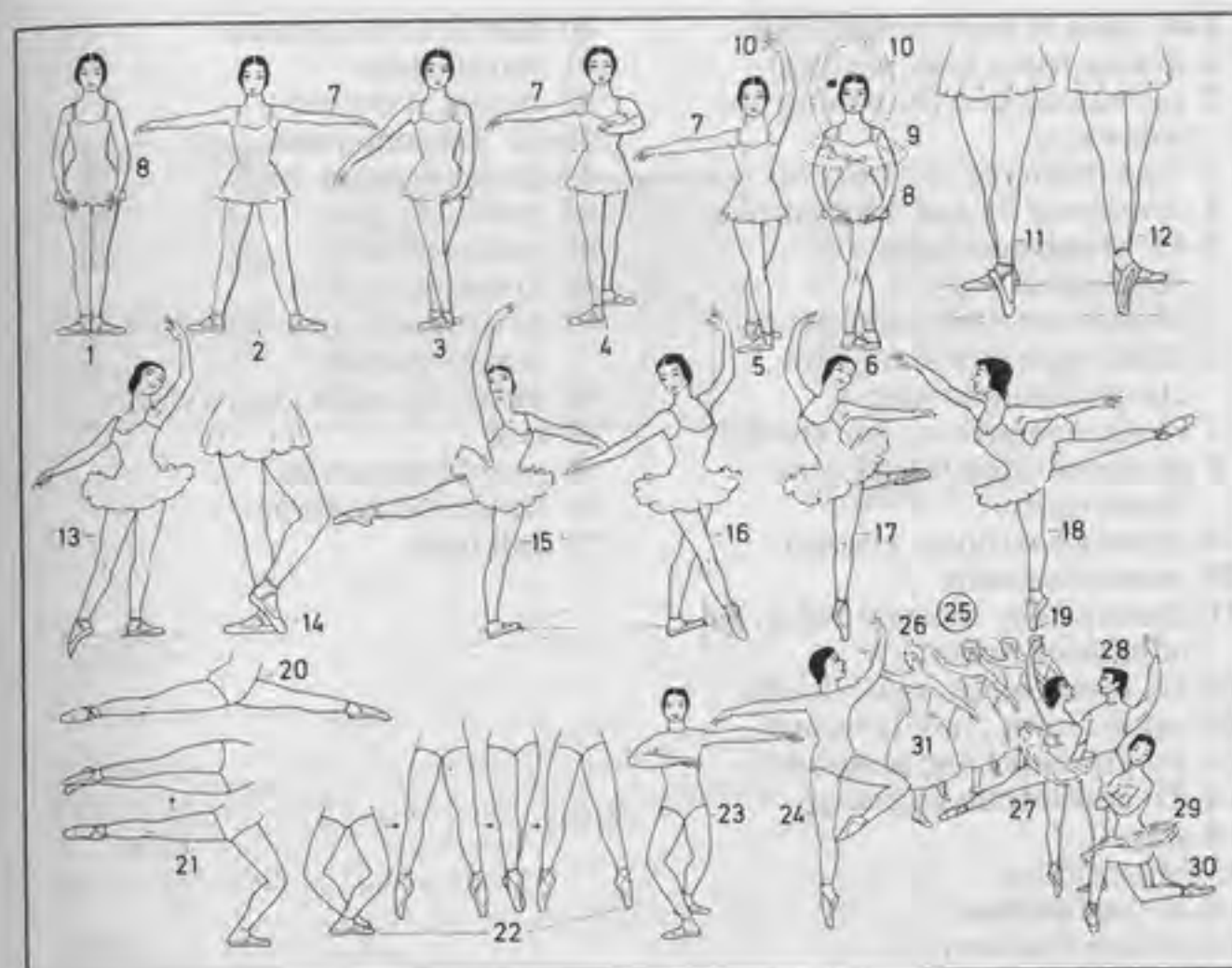

- 1-6 the five positions (ballet positions)
- 1 first position
- 2 second position
- 3 third position
- 4 fourth position [open]
- 5 fourth position [crossed; extended fifth position]
- 6 fifth position
- 7-10 ports de bras (arm positions)
- 7 port de bras à coté
- 8 port de bras en bas
- 9 port de bras en avant
- 10 port de bras en haut
- 11 dégagé à la quatrième devant
- 12 dégagé à la quatrième derrière
- 13 effacé
- 14 sur le cou-de-pied
- 15 écarté
- 16 croisé
- 17 attitude
- 18 arabesque
- 19 à pointe (on full point)
- 20 splits
- 21 cabriole (capriole)
- 22 entrechat (entrechat quatre)
- 23 préparation [e.g. for a pirouette]
- 24 pirouette
- 25 corps de ballet
- 26 ballet dancer (ballerina)
- 27-28 pas de trois
- 27 prima ballerina
- 28 principal male dancer (leading soloist)
- 29 tutu
- 30 point shoe, a ballet shoe (ballet slipper)
- 31 ballet skirt



- 1-4 types of curtain operation  
 1 draw curtain (side parting)  
 2 tableau curtain (bunching up sideways)  
 3 fly curtain (vertical ascent)  
 4 combined fly and draw curtain  
 5-11 cloakroom hall (Am. checkroom hall)  
 5 cloakroom (Am. checkroom)  
 6 cloakroom attendant (Am. checkroom attendant)  
 7 cloakroom ticket (Am. check)  
 8 playgoer (theatregoer, Am. theatergoer)  
 9 opera glass (opera glasses)  
 10 commissionaire  
 11 theatre (Am. theater) ticket, an admission ticket  
 12-13 foyer (lobby, crush room)  
 12 usher; *form.*: box attendant  
 13 programme (Am. program)  
 14-27 auditorium and stage  
 14 stage  
 15 proscenium  
 16-20 auditorium  
 16 gallery (balcony)  
 17 upper circle  
 18 dress circle (Am. balcony, mezzanine)  
 19 front stalls  
 20 seat (theatre seat, Am. theater seat)  
 21-27 rehearsal (stage rehearsal)  
 21 chorus  
 22 singer  
 23 singer  
 24 orchestra pit  
 25 orchestra  
 26 conductor  
 27 baton (conductor's baton)  
 28-42 paint room, a workshop  
 28 stagehand (scene shifter)  
 29 catwalk (bridge)  
 30 set piece  
 31 reinforcing struts  
 32 built piece (built unit)  
 33 backcloth (backdrop)  
 34 portable box for paint containers  
 35 scene painter  
 36 paint trolley  
 37 stage designer (set designer)  
 38 costume designer  
 39 design for a costume  
 40 sketch for a costume  
 41 model stage  
 42 model of the set  
 43-52 dressing room  
 43 dressing room mirror  
 44 make-up gown  
 45 make-up table  
 46 greasepaint stick  
 47 chief make-up artist (chief make-up man)  
 48 make-up artist (hairstylist)  
 49 wig  
 50 props (properties)  
 51 theatrical costume  
 52 call light

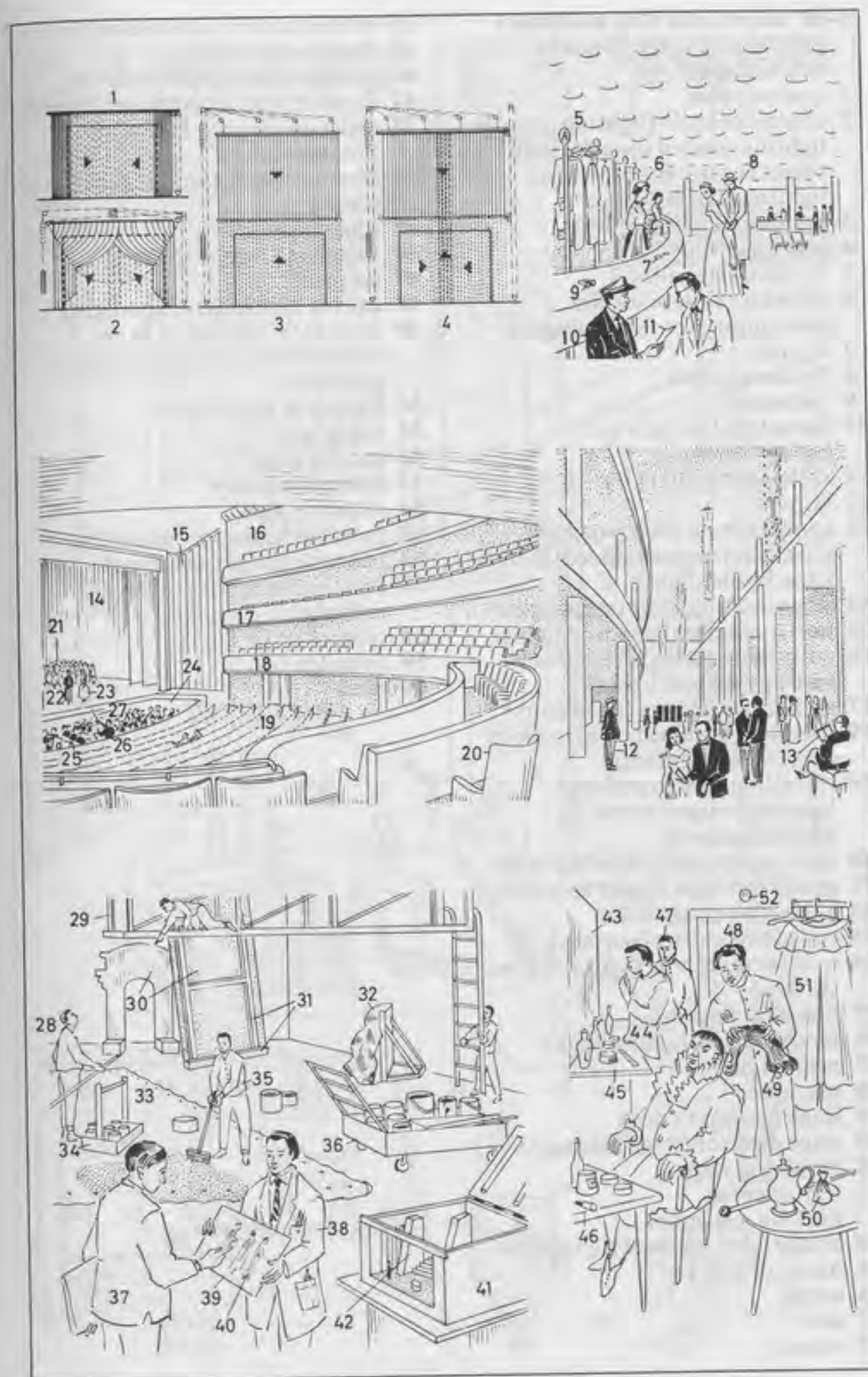



**1-60 stagehouse with machinery**

- (machinery in the flies and below stage)
- 1 control room
  - 2 control console (lighting console, lighting control console) with preset control for presetting lighting effects
  - 3 lighting plot (light plot)
  - 4 grid (gridiron)
  - 5 fly floor (fly gallery)
  - 6 sprinkler system for fire prevention (for fire protection)
  - 7 fly man
  - 8 fly lines (lines)
  - 9 cyclorama
  - 10 backcloth (backdrop, background)
  - 11 arch, a drop cloth
  - 12 border
  - 13 compartment (compartment-type, compartmentalized) batten (*Am. border light*)
  - 14 stage lighting units (stage lights)
  - 15 horizon lights (backdrop lights)
  - 16 adjustable acting area lights (acting area spotlights)
  - 17 scenery projectors (projectors)
  - 18 monitor (water cannon) (a piece of safety equipment)
  - 19 travelling (*Am. traveling*) lighting bridge (travelling lighting gallery)
  - 20 lighting operator (lighting man)
  - 21 portal spotlight (tower spotlight)
  - 22 adjustable proscenium
  - 23 curtain (theatrical curtain)
  - 24 iron curtain (safety curtain, fire curtain)
  - 25 forestage (apron)
  - 26 footlight (footlights, floats)
  - 27 prompt box
  - 28 prompter
  - 29 stage manager's desk
  - 30 stage director (stage manager)
  - 31 revolving stage
  - 32 trap opening
  - 33 lift (*Am. elevator*)
  - 34 bridge (*Am. elevator*), a rostrum
  - 35 pieces of scenery
  - 36 scene
  - 37 actor
  - 38 actress

- 39 extras (supers, supernumeraries)
- 40 director (producer)
- 41 prompt book (prompt script)
- 42 director's table (producer's table)
- 43 assistant director (assistant producer)
- 44 director's script (producer's script)
- 45 stage carpenter
- 46 stagehand (scene shifter)
- 47 set piece
- 48 mirror spot (mirror spotlight)
- 49 automatic filter change (with colour filters, colour mediums, gelatines)
- 50 hydraulic plant room
- 51 water tank
- 52 suction pipe
- 53 hydraulic pump
- 54 pressure pipe
- 55 pressure tank (accumulator)
- 56 pressure gauge (*Am. gage*)
- 57 level indicator (liquid level indicator)
- 58 control lever
- 59 operator
- 60 rams

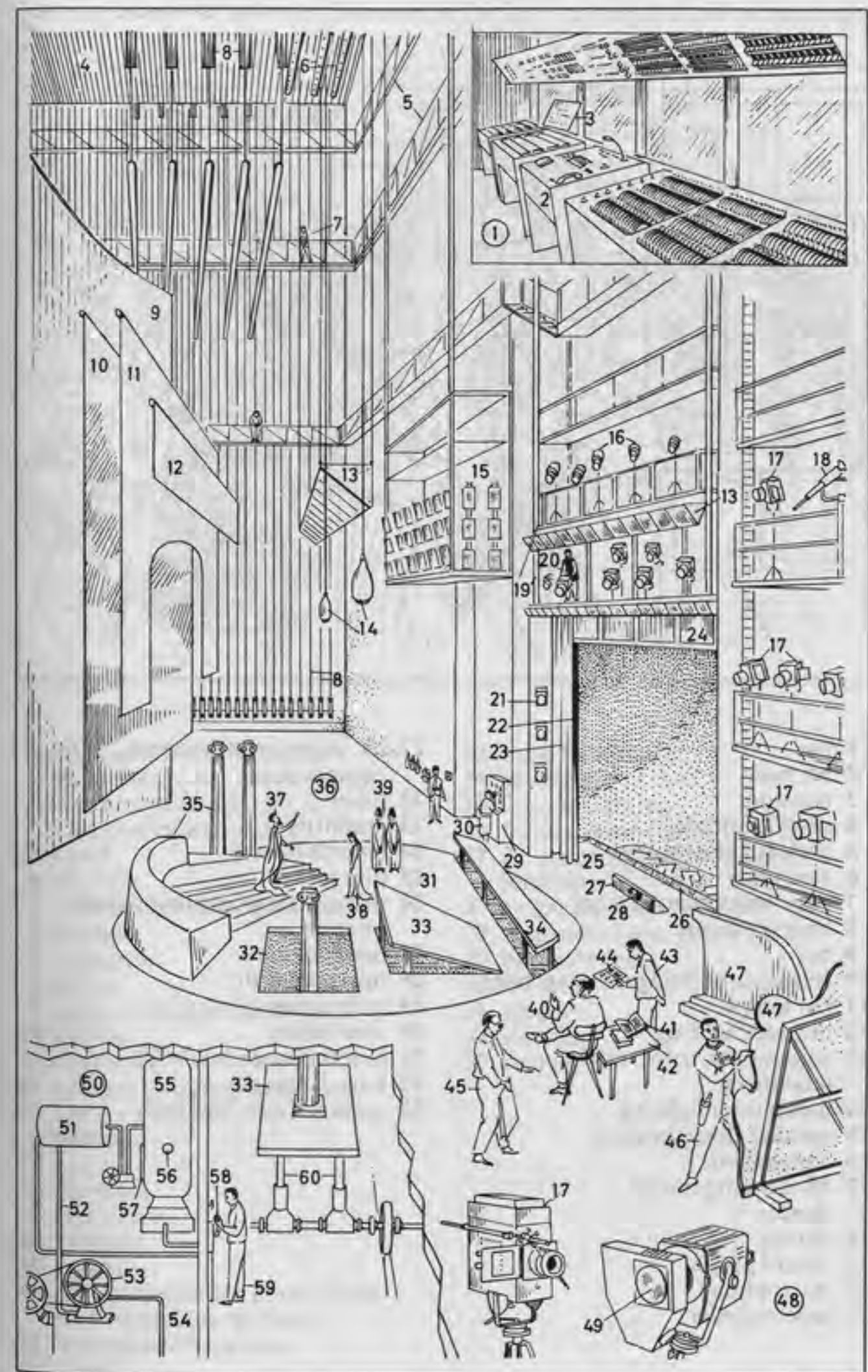



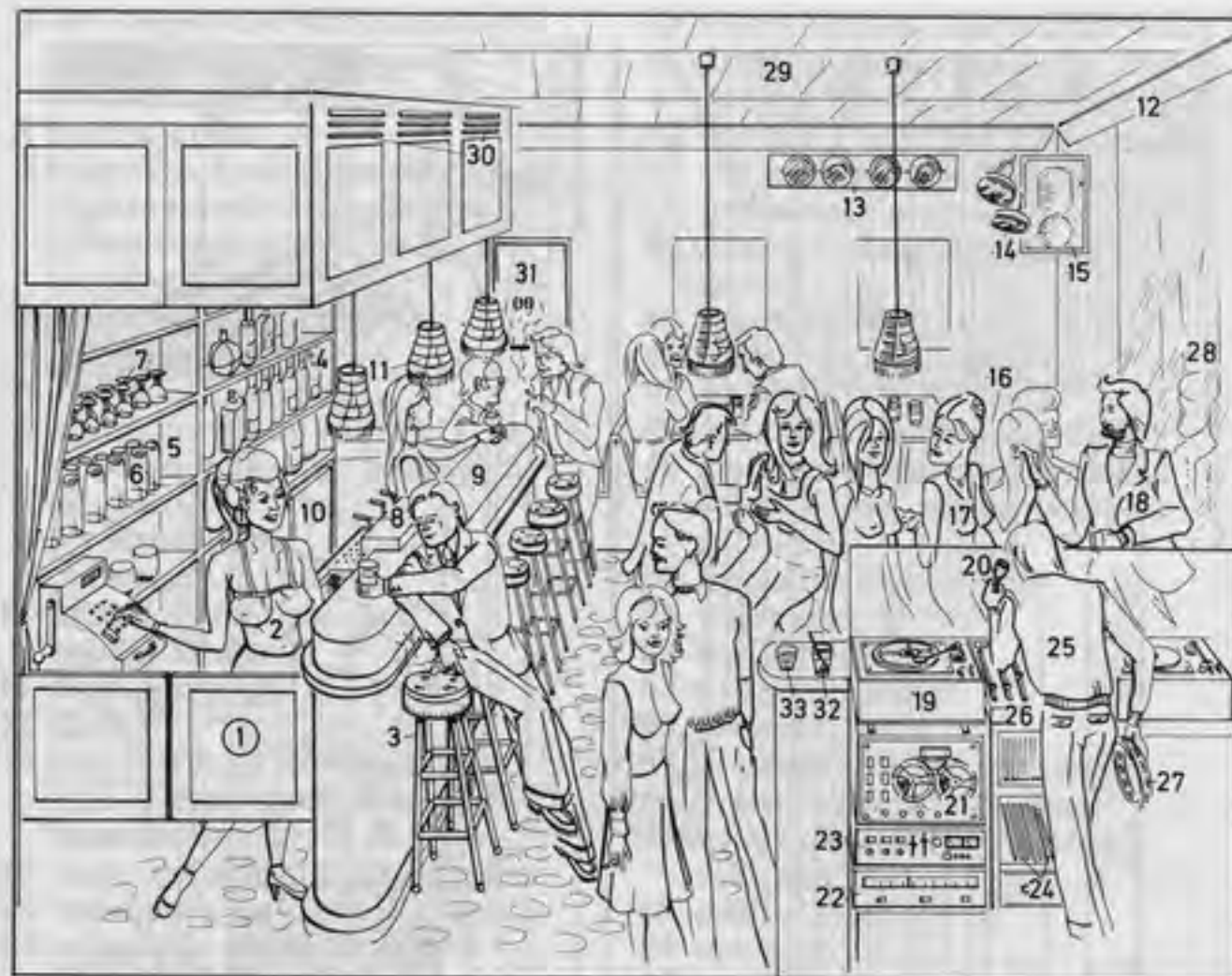

- |  |  |
|--|--|
| 1 bar  | 22-23 stereo system (stereo equipment) |
| 2 barmaid                                      | 22 tuner                               |
| 3 bar stool                                    | 23 amplifier                           |
| 4 shelf for bottles                            | 24 records (discs)                     |
| 5 shelf for glasses                            | 25 disc jockey                         |
| 6 beer glass                                   | 26 mixing console (mixing desk, mixer) |
| 7 wine and liqueur glasses                     | 27 tambourine                          |
| 8 beer tap (tap)                               | 28 mirrored wall                       |
| 9 bar  | 29 ceiling tiles                       |
| 10 refrigerator (fridge, <i>Am.</i> icebox)    | 30 ventilators                         |
| 11 bar lamps                                   | 31 toilets (lavatories, WC)            |
| 12 indirect lighting                           | 32 long drink                          |
| 13 colour ( <i>Am.</i> color) organ (clavilux) | 33 cocktail ( <i>Am.</i> highball)     |
| 14 dance floor lighting                        |  |
| 15 speaker (loudspeaker)                       |  |
| 16 dance floor                                 |  |
| 17-18 dancing couple                           |  |
| 17 dancer                                      |  |
| 18 dancer                                      |  |
| 19 record player                               |  |
| 20 microphone                                  |  |
| 21 tape recorder                               |  |



- |  |  |
|--|--|
| 1-33 nightclub (night spot)                                | 23 stage lighting                        |
| 1 cloakroom ( <i>Am.</i> checkroom)                        | 24 spotlight                             |
| 2 cloakroom attendant ( <i>Am.</i> checkroom attendant)    | 25 festoon lighting                      |
| 3 band   | 26 festoon lamp (lamp, light bulb)       |
| 4 clarinet   | 27-32 striptease act (striptease number) |
| 5 clarinetist ( <i>Am.</i> clarinetist)                    | 27 striptease artist (stripper)          |
| 6 trumpet  | 28 suspender ( <i>Am.</i> garter)        |
| 7 trumpeter  | 29 brassière (bra)                       |
| 8 guitar   | 30 fur stole                             |
| 9 guitarist (guitar player)                                | 31 gloves                                |
| 10 drums   | 32 stocking                              |
| 11 drummer   | 33 hostess                               |
| 12 speaker (loudspeaker)                                   |  |
| 13 bar   |  |
| 14 barmaid   |  |
| 15 bar   |  |
| 16 bar stool   |  |
| 17 tape recorder   |  |
| 18 receiver  |  |
| 19 spirits   |  |
| 20 cine projector for porno films (sex films, blue movies) |  |
| 21 box containing screen                                   |  |
| 22 stage   |  |



- 1-33 bullfight (corrida, corrida de toros)
- 1 mock bullfight
  - 2 novillero
  - 3 mock bull (dummy bull)
  - 4 novice banderillero (apprentice banderillero)
  - 5 bullring (plaza de toros) [diagram]
  - 6 main entrance
  - 7 boxes
  - 8 stands
  - 9 arena (ring)
  - 10 bullfighters' entrance
  - 11 torril door
  - 12 exit gate for killed bulls
  - 13 slaughterhouse
  - 14 bull pens (corrals)
  - 15 paddock
  - 16 lancer on horseback (picador)
  - 17 lance (pike pole, javelin)
  - 18 armoured (*Am.* armored) horse
  - 19 leg armour (*Am.* armor)
  - 20 picador's round hat
  - 21 banderillero, a torero
  - 22 banderillas (barbed darts)
  - 23 shirtwaist
  - 24 bullfight
  - 25 matador (swordsman), a torero
  - 26 queue, a distinguishing mark of the matador
  - 27 red cloak (capa)
  - 28 fighting bull
  - 29 montera [hat made of tiny black silk chenille balls]
  - 30 killing the bull (kill)
  - 31 matador in charity performances [without professional uniform]
  - 32 estoque (sword)
  - 33 muleta
  - 34 rodeo
  - 35 young bull
  - 36 cowboy
  - 37 stetson (stetson hat)
  - 38 scarf (necktie)
  - 39 rodeo rider
  - 40 lasso





- 1-2 **medieval (mediaeval) notes**  
 1 plainsong notation (neumes, neums, pneumes, square notation)  
 2 mensural notation  
 3-7 **musical note (note)**  
 3 note head  
 4 note stem (note tail)  
 5 hook  
 6 stroke  
 7 dot indicating augmentation of note's value  
 8-11 **clefs**  
 8 treble clef (G-clef, violin clef)  
 9 bass clef (F-clef)  
 10 alto clef (C-clef)  
 11 tenor clef  
 12-19 **note values**  
 12 breve (brevis, *Am.* double-whole note)  
 13 semibreve (*Am.* whole note)  
 14 minim (*Am.* half note)  
 15 crotchet (*Am.* quarter note)  
 16 quaver (*Am.* eighth note)  
 17 semiquaver (*Am.* sixteenth note)  
 18 demisemiquaver (*Am.* thirty-second note)  
 19 hemidemisemiquaver (*Am.* sixty-fourth note)  
 20-27 **rests**  
 20 breve rest  
 21 semibreve rest (*Am.* whole rest)  
 22 minim rest (*Am.* half rest)  
 23 crotchet rest (*Am.* quarter rest)  
 24 quaver rest (*Am.* eighth rest)  
 25 semiquaver rest (*Am.* sixteenth rest)  
 26 demisemiquaver rest (*Am.* thirty-second rest)  
 27 hemidemisemiquaver rest (*Am.* sixty-fourth rest)  
 28-42 **time** (time signatures, measure, *Am.* meter)  
 28 two-eight time  
 29 two-four time  
 30 two-two time  
 31 four-eight time  
 32 four-four time (common time)  
 33 four-two time  
 34 six-eight time  
 35 six-four time  
 36 three-eight time  
 37 three-four time  
 38 three-two time  
 39 nine-eight time  
 40 nine-four time  
 41 five-four time  
 42 bar (bar line, measure line)  
 43-44 **staff (stave)**  
 43 line of the staff  
 44 space  
 45-49 **scales**  
 45 C major scale naturals: c, d, e, f, g, a, b, c  
 46 A minor scale [natural] naturals: a, b, c, d, e, f, g, a  
 47 A minor scale [harmonic]  
 48 A minor scale [melodic]  
 49 chromatic scale  
 50-54 **accidentals** (inflections, key signatures)  
 50-51 signs indicating the raising of a note  
 50 sharp (raising the note a semitone or half-step)  
 51 double sharp (raising the note a tone or full-step)  
 52-53 signs indicating the lowering of a note  
 52 flat (lowering the note a semitone or half-step)  
 53 double flat (lowering the note a tone or full-step)  
 54 natural  
 55-68 **keys** (major keys and the related minor keys having the same signature)  
 55 C major (A minor)  
 56 G major (E minor)  
 57 D major (B minor)  
 58 A major (F sharp minor)  
 59 E major (C sharp minor)  
 60 B major (G sharp minor)  
 61 F sharp major (D sharp minor)  
 62 C major (A minor)  
 63 F major (D minor)  
 64 B flat major (G minor)  
 65 E flat major (C minor)  
 66 A flat major (F minor)  
 67 D flat major (B flat minor)  
 68 G flat major (E flat minor)

The image displays musical notation examples for the Magnificat and key signatures. At the top, the title "Magni - fi - cat" is written above a staff with notes. Below it, the text "Nu kom der heidē Heiland," is written above another staff with notes. The notation includes various clefs, time signatures, and accidentals. The examples are numbered 1 through 68, corresponding to the list on the left page. The notation is arranged in a grid-like format, with each example occupying a specific row and column. The examples show various musical notations, including notes, rests, and key signatures, illustrating the concepts listed on the left page.



- 1-5 chord
- 1-4 triad
- 1 major triad
- 2 minor triad
- 3 diminished triad
- 4 augmented triad
- 5 chord of four notes, a chord of the seventh (seventh chord, dominant seventh chord)
- 6-13 intervals
- 6 unison (unison interval)
- 7 major second
- 8 major third
- 9 perfect fourth
- 10 perfect fifth
- 11 major sixth
- 12 major seventh
- 13 perfect octave
- 14-22 ornaments (graces, grace notes)
- 14 long appoggiatura
- 15 acciaccatura (short appoggiatura)
- 16 slide
- 17 trill (shake) without turn
- 18 trill (shake) with turn
- 19 upper mordent (inverted mordent, pralltriller)
- 20 lower mordent (mordent)
- 21 turn
- 22 arpeggio
- 23-26 other signs in musical notation
- 23 triplet; corresponding groupings: duplet (couplet), quadruplet, quintuplet, sextolet (sextuplet), septolet (septuplet, septimole)
- 24 tie (bind)
- 25 pause (pause sign)
- 26 repeat mark
- 27-41 expression marks (signs of relative intensity)
- 27 marcato (marcando, markiert, attack, strong accent)
- 28 presto (quick, fast)
- 29 portato (lourer, mezzo staccato, carried)
- 30 tenuto (held)
- 31 crescendo (increasing gradually in power)
- 32 decrescendo (diminuendo, decreasing or diminishing gradually in power)

- 33 legato (bound)
- 34 staccato (detached)
- 35 piano (soft)
- 36 pianissimo (very soft)
- 37 pianissimo piano (as soft as possible)
- 38 forte (loud)
- 39 fortissimo (very loud)
- 40 forte fortissimo (double fortissimo, as loud as possible)
- 41 forte piano (loud and immediately soft again)
- 42-50 divisions of the compass
- 42 subcontra octave (double contra octave)
- 43 contra octave
- 44 great octave
- 45 small octave
- 46 one-line octave
- 47 two-line octave
- 48 three-line octave
- 49 four-line octave
- 50 five-line octave

The page contains musical notation for items 1 through 50. Items 1-5 are chords: 1 (major triad), 2 (minor triad), 3 (diminished triad), 4 (augmented triad), and 5 (chord of four notes, a chord of the seventh). Items 6-13 are intervals: 6 (unison), 7 (major second), 8 (major third), 9 (perfect fourth), 10 (perfect fifth), 11 (major sixth), 12 (major seventh), and 13 (perfect octave). Items 14-22 are ornaments: 14 (long appoggiatura), 15 (acciaccatura), 16 (slide), 17 (trill without turn), 18 (trill with turn), 19 (upper mordent), 20 (lower mordent), 21 (turn), and 22 (arpeggio). Items 23-26 are other signs: 23 (triplet), 24 (tie), 25 (pause), and 26 (repeat mark). Items 27-41 are expression marks: 27 (marcato), 28 (presto), 29 (portato), 30 (tenuto), 31 (crescendo), 32 (decrescendo), 33 (legato), 34 (staccato), 35 (piano), 36 (pianissimo), 37 (pianissimo piano), 38 (forte), 39 (fortissimo), 40 (forte fortissimo), and 41 (forte piano). Items 42-50 are divisions of the compass: 42 (subcontra octave), 43 (contra octave), 44 (great octave), 45 (small octave), 46 (one-line octave), 47 (two-line octave), 48 (three-line octave), 49 (four-line octave), and 50 (five-line octave). The notation includes treble and bass clefs, various note values, rests, and dynamic markings like *p*, *pp*, *ppp*, *f*, *ff*, *fff*, *fp*, *ten.*, *cresc.*, and *decre.*.

28 **Presto**

*p*    *pp*    *ppp*    *f*    *ff*    *fff*    *fp*  
 35    36    37    38    39    40    41

*8va sopra*.....  
 42    43    44    45    46    47    48    49    50  
*8va bassa*.....

${}_2A_2B_2H_1C$  usw  
 in Britain:  
 $A_2B_2C_1$  etc.

${}_1HCHc h c^1 h^1c^2h^2c^3h^3c^4h^4c^5$   
 $B_1CBc b c' b'c^{\#}b^{\#}c^{\#}b^{\#}c^{\#}b^{\#}c^{\#}$



- 1 lur, a bronze trumpet
- 2 panpipes (Pandean pipes, syrinx)
- 3 aulos, a double shawm
- 4 aulos pipe
- 5 phorbeia (peristomion, capistrum, mouth band)
- 6 crumhorn (crumhorn, cromorne, krumhorn, krummhorn)
- 7 recorder (fipple flute)
- 8 bagpipe; *sim.*: musette
- 9 bag
- 10 chanter (melody pipe)
- 11 drone (drone pipe)
- 12 curved cornett (zink)
- 13 serpent
- 14 shawm (schalmeyes); *larger*: bombard (bombarde, pommer)
- 15 cythara (cithara); *sim. and smaller*: lyre
- 16 arm
- 17 bridge
- 18 sound box (resonating chamber, resonator)
- 19 plectrum, a plucking device
- 20 kit (pochette), a miniature violin
- 21 cittern (cithern, cither, cister, citole), a plucked instrument; *sim.*: pandora (bandora, bandore)
- 22 sound hole
- 23 viol (descant viol, treble viol), a viola da gamba; *larger*: tenor viol, bass viol (viola da gamba, gamba), violone (double bass viol)
- 24 viol bow
- 25 hurdy-gurdy (vielle à roue, symphonia, armonie, organistrum)
- 26 friction wheel
- 27 wheel cover (wheel guard)
- 28 keyboard (keys)
- 29 resonating body (resonator, sound box)
- 30 melody strings
- 31 drone strings (drones, bourdons)
- 32 dulcimer
- 33 rib (resonator wall)
- 34 beater for the Valasian dulcimer
- 35 hammer (stick) for the Appenzell dulcimer

- 36 clavichord; *kinds*: fretted or unfretted clavichord
- 37 clavichord mechanism
- 38 key (key lever)
- 39 balance rail
- 40 guiding blade
- 41 guiding slot
- 42 resting rail
- 43 tangent
- 44 string
- 45 harpsichord (clavicembalo, cembalo), a wing-shaped stringed keyboard instrument; *sim.*: spinet (virginal)
- 46 upper keyboard (upper manual)
- 47 lower keyboard (lower manual)
- 48 harpsichord mechanism
- 49 key (key lever)
- 50 jack
- 51 slide (register)
- 52 tongue
- 53 quill plectrum
- 54 damper
- 55 string
- 56 portative organ, a portable organ; *larger*: positive organ (positive)
- 57 pipe (flue pipe)
- 58 bellows

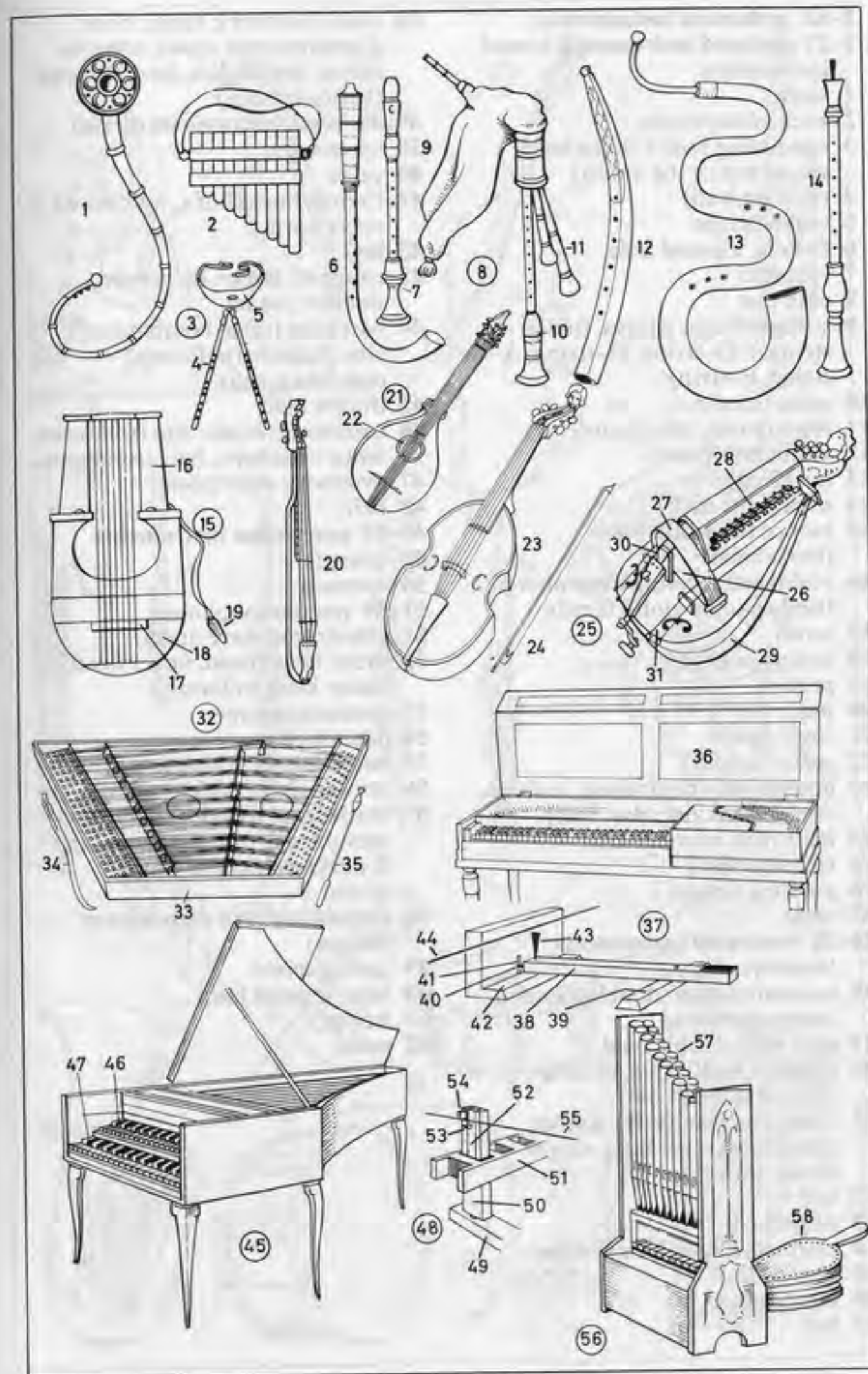



## 1-62 orchestral instruments

## 1-27 stringed instruments, bowed instruments

- 1 violin
- 2 neck of the violin
- 3 resonating body (violin body, sound box of the violin)
- 4 rib (side wall)
- 5 violin bridge
- 6 F-hole, a sound hole
- 7 tailpiece
- 8 chin rest
- 9 strings (violin strings, fiddle strings): G-string, D-string, A-string, E-string
- 10 mute (sordino)
- 11 resin (rosin, colophony)
- 12 violin bow (bow)
- 13 nut (frog)
- 14 stick (bow stick)
- 15 hair of the violin bow (horsehair)
- 16 violoncello (cello), a member of the da gamba violin family
- 17 scroll
- 18 tuning peg (peg)
- 19 pegbox
- 20 nut
- 21 fingerboard
- 22 spike (tailpin)
- 23 double bass (contrabass, violone, double bass viol, *Am.* bass)
- 24 belly (top, soundboard)
- 25 rib (side wall)
- 26 purfling (inlay)
- 27 viola

## 28-38 woodwind instruments (woodwinds)

- 28 bassoon; *larger*: double bassoon (contrabassoon)
- 29 tube with double reed
- 30 piccolo (small flute, piccolo flute, flauto piccolo)
- 31 flute (German flute), a cross flute (transverse flute, side-blown flute)
- 32 key
- 33 fingerhole
- 34 clarinet; *larger*: bass clarinet
- 35 key (brille)
- 36 mouthpiece
- 37 bell

- 38 oboe (hautboy); *kinds*: oboe d'amore; tenor oboes: oboe da caccia, cor anglais; heckelphone (baritone oboe)

## 39-48 brass instruments (brass)

- 39 tenor horn
- 40 valve
- 41 French horn (horn, waldhorn), a valve horn
- 42 bell
- 43 trumpet; *larger*: B $\flat$  cornet; *smaller*: cornet
- 44 bass tuba (tuba, bombardon); *sim.*: helicon (pellitone), contrabass tuba
- 45 thumb hold
- 46 trombone; *kinds*: alto trombone, tenor trombone, bass trombone
- 47 trombone slide (slide)
- 48 bell

## 49-59 percussion instruments

- 49 triangle
- 50 cymbals
- 51-59 membranophones
- 51 side drum (snare drum)
- 52 drum head (head, upper head, batter head, vellum)
- 53 tensioning screw
- 54 drumstick
- 55 bass drum (Turkish drum)
- 56 stick (padded stick)
- 57 kettledrum (timpano), a screw-tensioned drum; *sim.*: machine drum (mechanically tuned drum)
- 58 kettledrum skin (kettledrum vellum)
- 59 tuning screw
- 60 harp, a pedal harp
- 61 strings
- 62 pedal

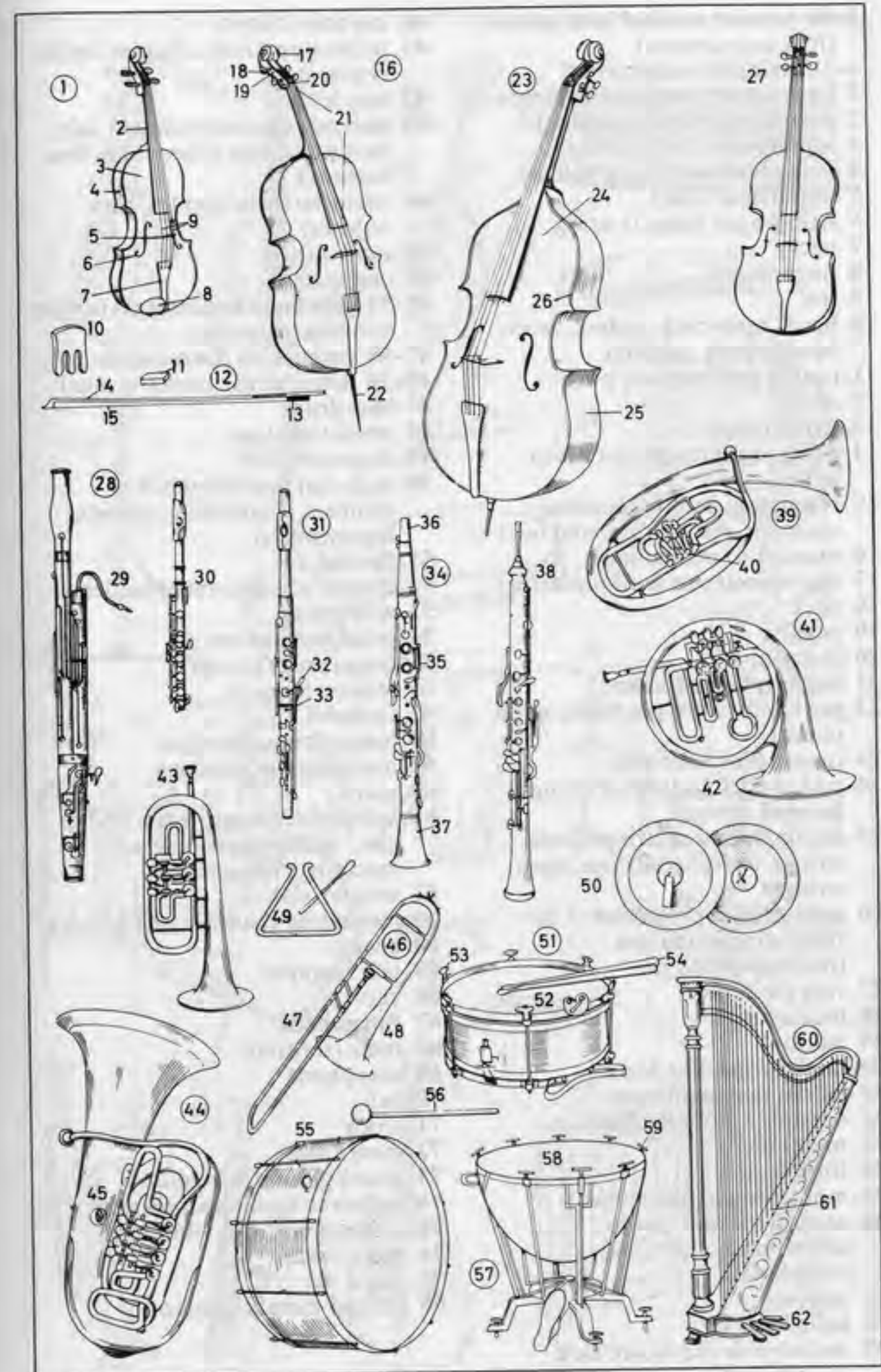



- 1-46 popular musical instruments (folk instruments)  
 1-31 stringed instruments  
 1 lute; *larger*: theorbo, chitarraone  
 2 resonating body (resonator)  
 3 soundboard (belly, table)  
 4 string fastener (string holder)  
 5 sound hole (rose)  
 6 string, a gut (catgut) string  
 7 neck  
 8 fingerboard  
 9 fret  
 10 head (bent-back pegbox, swan-head pegbox, pegbox)  
 11 tuning peg (peg, lute pin)  
 12 guitar  
 13 string holder  
 14 string, a gut (catgut) or nylon string  
 15 resonating body (resonating chamber, resonator, sound box)  
 16 mandolin (mandoline)  
 17 sleeve protector (cuff protector)  
 18 neck  
 19 pegdisc  
 20 plectrum  
 21 zither (plucked zither)  
 22 pin block (wrest pin block, wrest plank)  
 23 tuning pin (wrest pin)  
 24 melody strings (fretted strings, stopped strings)  
 25 accompaniment strings (bass strings, unfretted strings, open strings)  
 26 semicircular projection of the resonating sound box (resonating body)  
 27 ring plectrum  
 28 balalaika  
 29 banjo  
 30 tambourine-like body  
 31 parchment membrane  
 32 ocarina, a globular flute  
 33 mouthpiece  
 34 fingerhole  
 35 mouth organ (harmonica)  
 36 accordion; *sim.*: piano accordion, concertina, bandoneon  
 37 bellows  
 38 bellows strap  
 39 melody side (keyboard side, melody keys)

- 40 keyboard (keys)  
 41 treble stop (treble coupler, treble register)  
 42 stop lever  
 43 bass side (accompaniment side, bass studs, bass press-studs, bass buttons)  
 44 bass stop (bass coupler, bass register)  
 45 tambourine  
 46 castanets  
 47-78 jazz band instruments (dance band instruments)  
 47-58 percussion instruments  
 47-54 drum kit (drum set, drums)  
 47 bass drum  
 48 small tom-tom  
 49 large tom-tom  
 50 high-hat cymbals (choke cymbals, Charleston cymbals, cup cymbals)  
 51 cymbal  
 52 cymbal stand (cymbal holder)  
 53 wire brush  
 54 pedal mechanism  
 55 conga drum (conga)  
 56 tension hoop  
 57 timbales  
 58 bongo drums (bongos)  
 59 maracas; *sim.*: shakers  
 60 guiro  
 61 xylophone; *form.*: straw fiddle; *sim.*: marimbaphone (steel marimba), tubaphone  
 62 wooden slab  
 63 resonating chamber (sound box)  
 64 beater  
 65 jazz trumpet  
 66 valve  
 67 finger hook  
 68 mute (sordino)  
 69 saxophone  
 70 bell  
 71 crook  
 72 mouthpiece  
 73 struck guitar (jazz guitar)  
 74 hollow to facilitate fingering  
 75 vibraphone (*Am.* vibraharp)  
 76 metal frame  
 77 metal bar  
 78 tubular metal resonator





- 1 piano (pianoforte, upright piano, upright, vertical piano, spinet piano, console piano), a keyboard instrument (keyed instrument); *smaller form*: cottage piano (pianino); *earlier forms*: pantaleon, celesta, with steel bars instead of strings
- 2-18 piano action (piano mechanism)
- 2 iron frame
- 3 hammer; *collectively*: striking mechanism
- 4-5 keyboard (piano keys)
- 4 white key (ivory key)
- 5 black key (ebony key)
- 6 piano case
- 7 strings (piano strings)
- 8-9 piano pedals
- 8 right pedal (sustaining pedal, damper pedal; *loosely*: forte pedal, loud pedal) for raising the dampers
- 9 left pedal (soft pedal; *loosely*: piano pedal) for reducing the striking distance of the hammers on the strings
- 10 treble strings
- 11 treble bridge (treble belly bridge)
- 12 bass strings
- 13 bass bridge (bass belly bridge)
- 14 hitch pin
- 15 hammer rail
- 16 brace
- 17 tuning pin (wrest pin, tuning peg)
- 18 pin block (wrest pin block, wrest plank)
- 19 metronome
- 20 tuning hammer (tuning key, wrest)
- 21 tuning wedge
- 22-39 key action (key mechanism)
- 22 beam
- 23 damper-lifting lever
- 24 felt-covered hammer head
- 25 hammer shank
- 26 hammer rail
- 27 check (back check)
- 28 check felt (back check felt)
- 29 wire stem of the check (wire stem of the back check)
- 30 sticker (hopper, hammer jack, hammer lever)
- 31 button
- 32 action lever
- 33 pilot
- 34 pilot wire
- 35 tape wire
- 36 tape
- 37 damper (damper block)
- 38 damper lifter
- 39 damper rest rail
- 40 grand piano (horizontal piano, grand, concert grand); *smaller*: baby grand piano, boudoir piano; *sim.*: square piano, table piano
- 41 grand piano pedals; right pedal for raising the dampers; left pedal for softening the tone (shifting the keyboard so that only one string is struck 'una corda')
- 42 pedal bracket
- 43 harmonium (reed organ, melodium)
- 44 draw stop (stop, stop knob)
- 45 knee lever (knee swell, swell)
- 46 pedal (bellows pedal)
- 47 harmonium case
- 48 harmonium keyboard (manual)

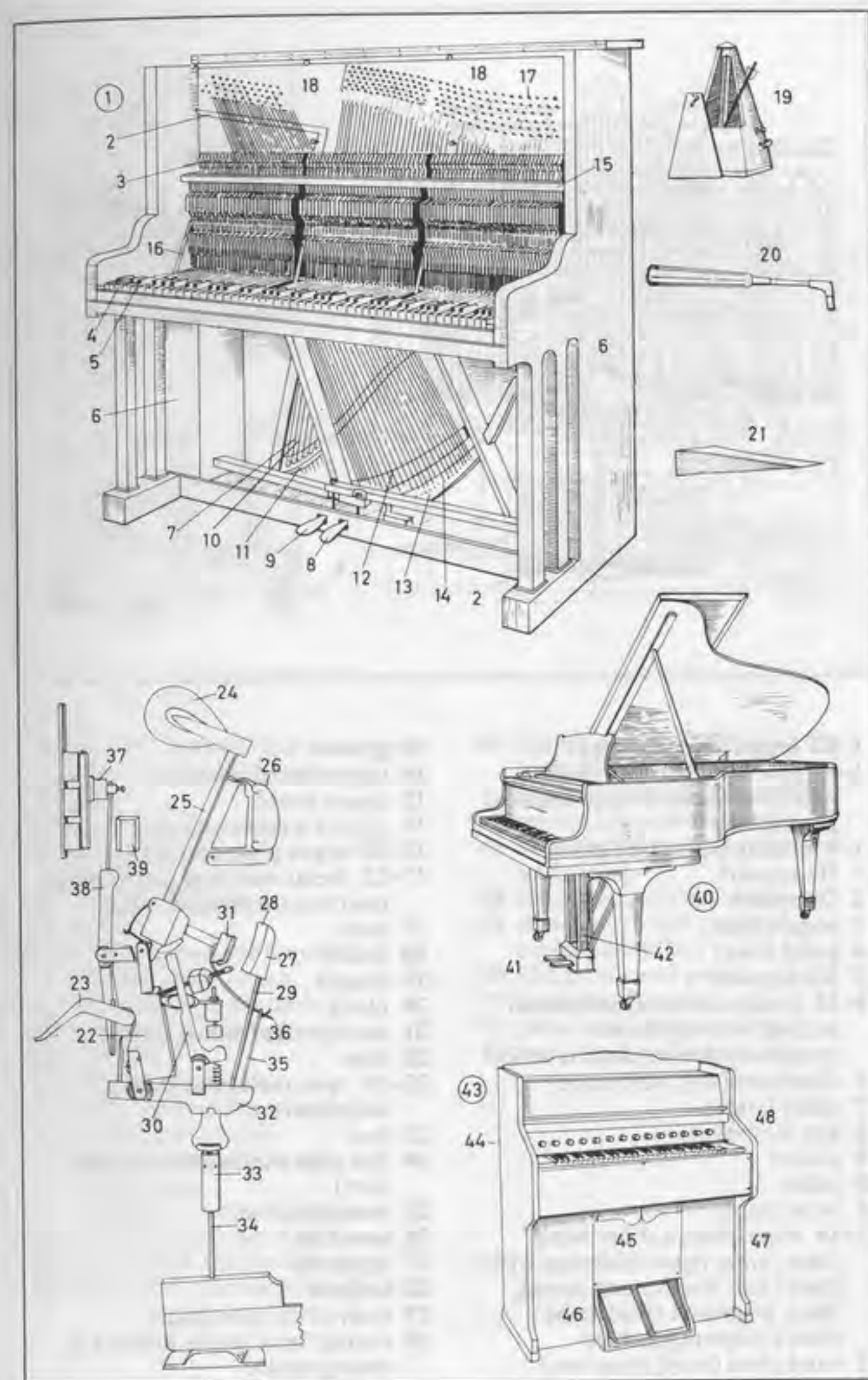



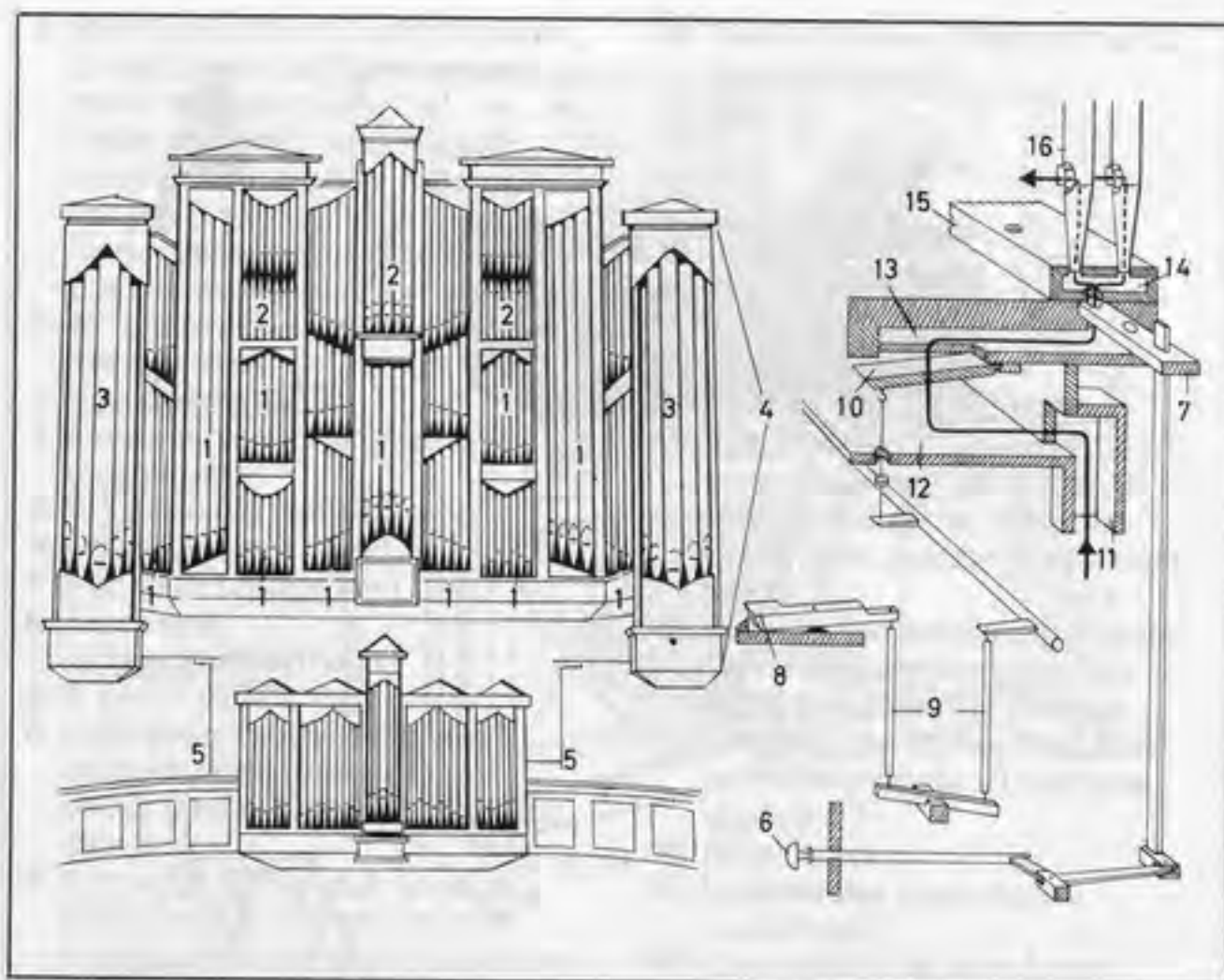

- 1-52 organ (church organ)**  
**1-5** front view of organ (organ case) [built according to classical principles]  
**1-3** display pipes (face pipes)  
**1** Hauptwerk  
**2** Oberwerk  
**3** pedal pipes  
**4** pedal tower  
**5** Rückpositiv  
**6-16** tracker action (mechanical action); *other systems:* pneumatic action, electric action  
**6** draw stop (stop, stop knob)  
**7** slider (slide)  
**8** key (key lever)  
**9** sticker  
**10** pallet  
**11** wind trunk  
**12-14** wind chest, a slider wind chest; *other types:* sliderless wind chest (unit wind chest), spring chest, kegellade chest (cone chest), diaphragm chest  
**12** wind chest (wind chest box)  
**13** groove  
**14** upper board groove  
**15** upper board  
**16** pipe of a particular stop  
**17-35** organ pipes (pipes)  
**17-22** metal reed pipe (*set of pipes:* reed stop), a posaune stop  
**17** boot  
**18** shallot  
**19** tongue  
**20** block  
**21** tuning wire (tuning crook)  
**22** tube  
**23-30** open metal flue pipe, a salicional  
**23** foot  
**24** flue pipe windway (flue pipe duct)  
**25** mouth (cutup)  
**26** lower lip  
**27** upper lip  
**28** languid  
**29** body of the pipe (pipe)  
**30** tuning flap (tuning tongue), a tuning device

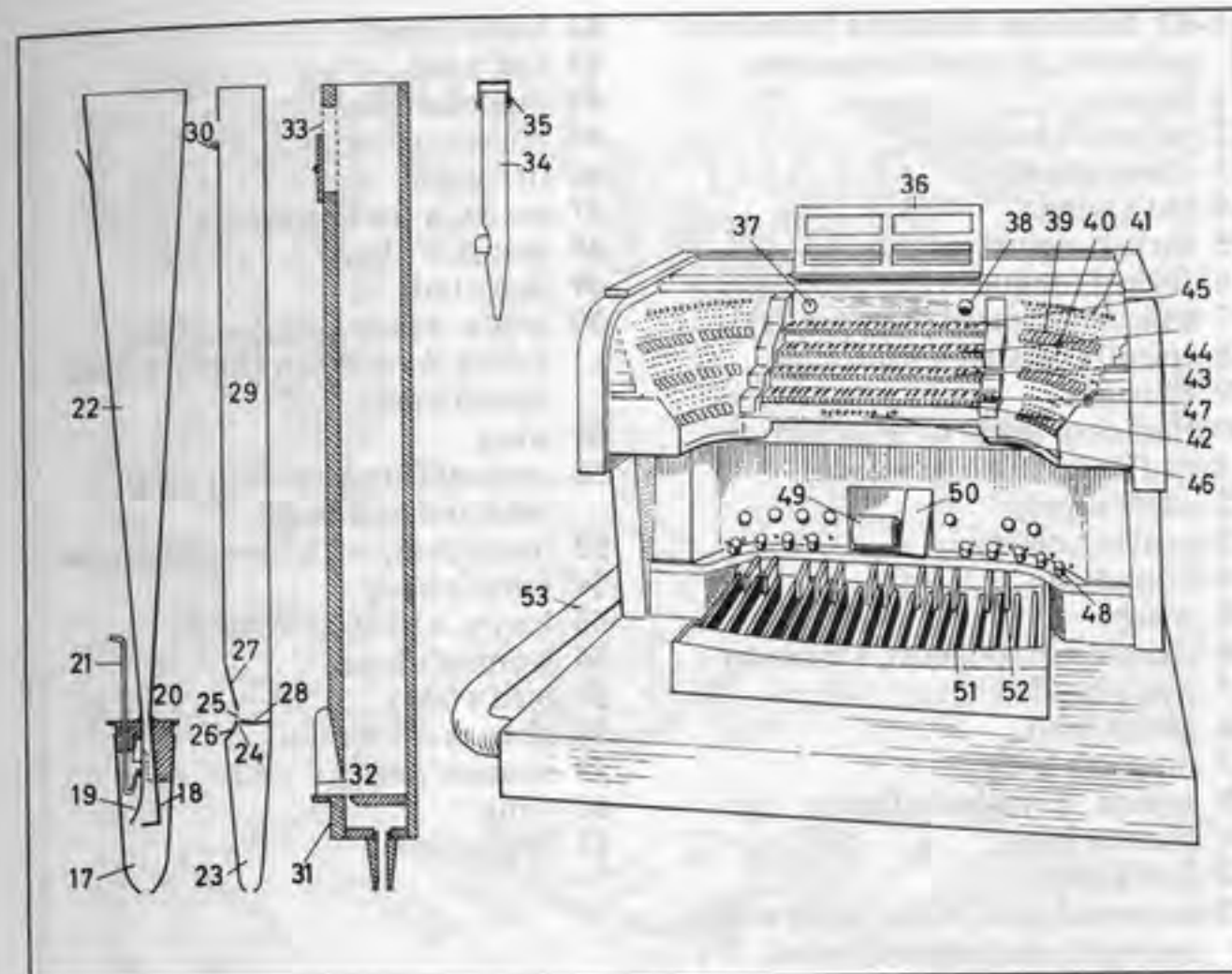

- 31-33** open wooden flue pipe (open wood), principal (diapason)  
**31** cap  
**32** ear  
**33** tuning hole (tuning slot), with slide  
**34** stopped flue pipe  
**35** stopper  
**36-52** organ console (console) of an electric action organ  
**36** music rest (music stand)  
**37** crescendo roller indicator  
**38** voltmeter  
**39** stop tab (rocker)  
**40** free combination stud (free combination knob)  
**41** cancel buttons for reeds, couplers etc.  
**42** manual I, for the Rückpositiv  
**43** manual II, for the Hauptwerk  
**44** manual III, for the Oberwerk  
**45** manual IV, for the Schwellwerk  
**46** thumb pistons controlling the manual stops (free or fixed combinations) and buttons for setting the combinations  
**47** switches for current to blower and action  
**48** toe piston, for the coupler  
**49** crescendo roller (general crescendo roller)  
**50** balanced swell pedal  
**51** pedal key [natural]  
**52** pedal key [sharp or flat]  
**53** cable (transmission cable)



- 1-61 fabulous creatures (fabulous animals), mythical creatures
- 1 dragon
  - 2 serpent's body
  - 3 claws (claw)
  - 4 bat's wing
  - 5 fork-tongued mouth
  - 6 forked tongue
  - 7 unicorn [symbol of virginity]
  - 8 spirally twisted horn
  - 9 Phoenix
  - 10 flames or ashes of resurrection
  - 11 griffin (griffon, gryphon)
  - 12 eagle's head
  - 13 griffin's claws
  - 14 lion's body
  - 15 wing
  - 16 chimera (chimaera), a monster
  - 17 lion's head
  - 18 goat's head
  - 19 dragon's body
  - 20 sphinx, a symbolic figure
  - 21 human head
  - 22 lion's body
  - 23 mermaid (nix, nixie, water nixie, sea maid, sea maiden, naiad, water nymph, water elf, ocean nymph, sea nymph, river nymph); *sim.*: Nereids, Oceanids (sea divinities, sea deities, sea goddesses); *male*: nix (merman, seaman)
  - 24 woman's trunk
  - 25 fish's tail (dolphin's tail)
  - 26 Pegasus (favourite, *Am.* favorite, steed of the Muses, winged horse); *sim.*: hippogryph
  - 27 horse's body
  - 28 wings
  - 29 Cerberus (hellhound)
  - 30 three-headed dog's body
  - 31 serpent's tail
  - 32 Lernaean (Lernean) Hydra
  - 33 nine-headed serpent's body
  - 34 basilisk (cockatrice)
  - 35 cock's head
  - 36 dragon's body
  - 37 giant (titan)
  - 38 rock
  - 39 serpent's foot
  - 40 triton, a merman (demigod of the sea)
  - 41 conch shell trumpet

- 42 horse's hoof
- 43 fish's tail
- 44 hippocampus
- 45 horse's trunk
- 46 fish's tail
- 47 sea ox, a sea monster
- 48 monster's body
- 49 fish's tail
- 50 seven-headed dragon of St. John's Revelation (Revelations, Apocalypse)
- 51 wing
- 52 centaur (hippocentaur), half man and half beast
- 53 man's body with bow and arrow
- 54 horse's body
- 55 harpy, a winged monster
- 56 woman's head
- 57 bird's body
- 58 siren, a daemon
- 59 woman's body
- 60 wing
- 61 bird's claw

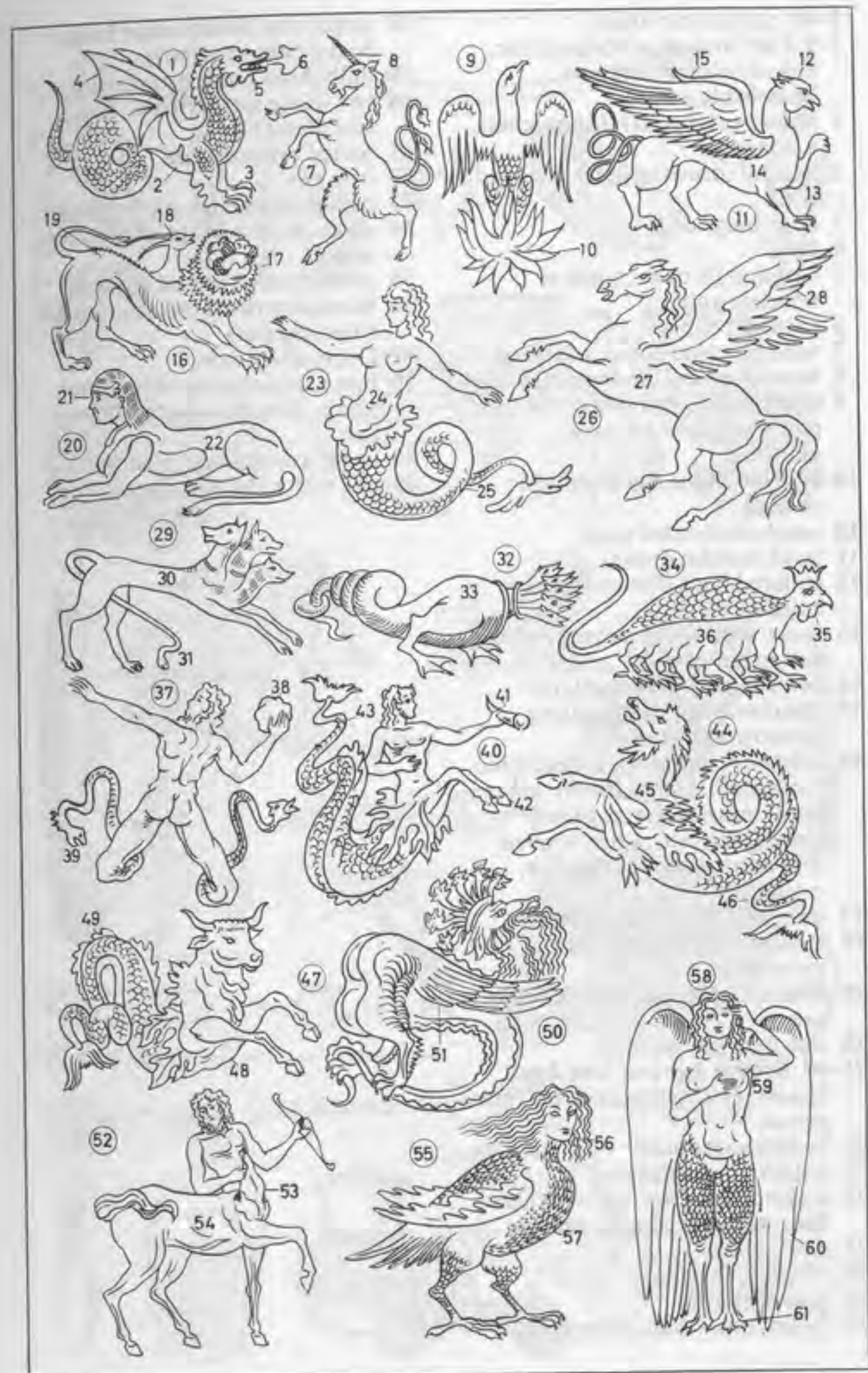



- 1-40 prehistoric finds  
**1-9 Old Stone Age (Palaeolithic, Paleolithic, period) and Mesolithic period**  
 1 hand axe (*Am. ax*) (fist hatchet), a stone tool  
 2 head of throwing spear, made of bone  
 3 bone harpoon  
 4 head  
 5 harpoon thrower, made of reindeer antler  
 6 painted pebble  
 7 head of a wild horse, a carving  
 8 Stone Age idol, an ivory statuette  
 9 bison, a cave painting (rock painting) [cave art, cave painting]  
**10-20 New Stone Age (Neolithic period)**  
 10 amphora [corded ware]  
 11 bowl [menhir group]  
 12 collared flask [Funnel-Beaker culture]  
 13 vessel with spiral pattern [spiral design pottery]  
 14 bell beaker [beaker pottery]  
 15 pile dwelling (lake dwelling, lacustrine dwelling)  
 16 dolmen (cromlech), a megalithic tomb (*coll.*: giant's tomb); *other kinds*: passage grave, gallery grave (long cist); *when covered with earth*: tumulus (barrow, mound)  
 17 stone cist, a contracted burial  
 18 menhir (standing stone), a monolith  
 19 boat axe (*Am. ax*), a stone battle axe  
 20 clay figurine (an idol)  
**21-40 Bronze Age and Iron Age; epochs: Hallstatt period, La Tène period**  
 21 bronze spear head  
 22 hafted bronze dagger  
 23 socketed axe (*Am. ax*) with haft fastened to rings, a bronze axe  
 24 girdle clasp  
 25 necklace (lunula)  
 26 gold neck ring  
 27 violin-bow fibula (safety pin)

- 28 serpentine fibula; *other kinds*: boat fibula, arc fibula  
 29 bulb-head pin, a bronze pin  
 30 two-piece spiral fibula; *sim.*: disc (disk) fibula  
 31 hafted bronze knife  
 32 iron key  
 33 ploughshare (*Am. plowshare*)  
 34 sheet-bronze situla, a funerary vessel  
 35 pitcher [chip-carved pottery]  
 36 miniature ritual cart (miniature ritual chariot)  
 37 Celtic silver coin  
 38 face urn, a cinerary urn; *other kinds*: domestic urn, embossed urn  
 39 urn grave in stone chamber  
 40 urn with cylindrical neck





- 1 knight's castle (castle)  
 2 inner ward (inner bailey)  
 3 draw well  
 4 keep (donjon)  
 5 dungeon  
 6 battlements (crenellation)  
 7 merlon  
 8 tower platform  
 9 watchman  
 10 ladies' apartments (bowers)  
 11 dormer window (dormer)  
 12 balcony  
 13 storehouse (magazine)  
 14 angle tower  
 15 curtain wall (curtains, enclosure wall)  
 16 bastion  
 17 angle tower  
 18 crenel (embrasure)  
 19 inner wall  
 20 battlemented parapet  
 21 parapet (breastwork)  
 22 gatehouse  
 23 machicolation (machicoulis)  
 24 portcullis  
 25 drawbridge  
 26 buttress  
 27 offices and service rooms  
 28 turret  
 29 chapel  
 30 great hall  
 31 outer ward (outer bailey)  
 32 castle gate  
 33 moat (ditch)  
 34 approach  
 35 watchtower (turret)  
 36 palisade (pallisade, palisading)  
 37 moat (ditch, fosse)  
 38-65 knight's armour (*Am. armor*)  
 38 suit of armour (*Am. armor*)  
 39 skull  
 40 visor (vizor)  
 41 beaver  
 42 throat piece  
 43 gorget  
 44 epaulière  
 45 palette (pauldron, besageur)  
 46 breastplate (cuirass)  
 47 brassard (rear brace and vambrace)  
 48 cubitière (coudière, couter)  
 49 tasse (tasset)  
 50 gauntlet  
 51 habergeon (haubergeon)  
 52 cuisse (cuish, cuissard, cuissart)  
 53 knee cap (knee piece, genouillère, poleyn)  
 54 jambeau (greave)  
 55 solleret (sabaton, sabbaton)  
 56 pavis (pavise, pavais)  
 57 buckler (round shield)  
 58 boss (umbo)  
 59 iron hat  
 60 morion  
 61 light casque  
 62 types of mail and armour (*Am. armor*)  
 63 mail (chain mail, chain armour, *Am. armor*)  
 64 scale armour (*Am. armor*)  
 65 plate armour (*Am. armor*)  
 66 accolade (dubbing, knighting)  
 67 liege lord, a knight  
 68 esquire  
 69 cup bearer  
 70 minstrel (minnesinger, troubadour)  
 71 tournament (tourney, joust, just, tilt)  
 72 crusader  
 73 Knight Templar  
 74 caparison (trappings)  
 75 herald (marshal at tournament)  
 76 tilting armour (*Am. armor*)  
 77 tilting helmet (jousting helmet)  
 78 panache (plume of feathers)  
 79 tilting target (tilting shield)  
 80 lance rest  
 81 tilting lance (lance)  
 82 vamplate  
 83-88 horse armour (*Am. armor*)  
 83 neck guard (neck piece)  
 84 chamfron (chaffron, chafron, chamfrain, chanfron)  
 85 poitrel  
 86 flanchard (flancard)  
 87 tournament saddle  
 88 rump piece (quarter piece)

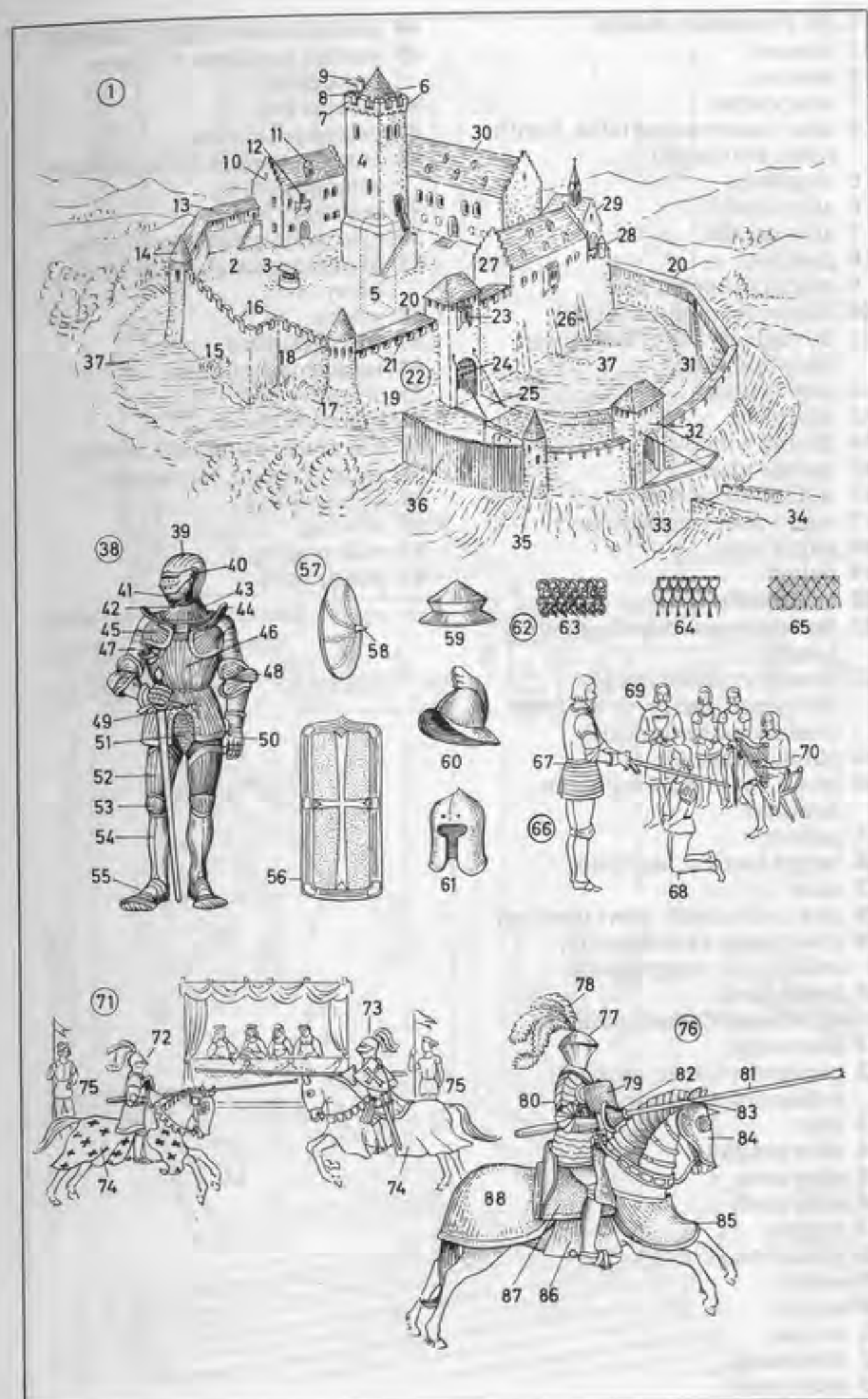



**1-30 Protestant church**

- 1 chancel
- 2 lectern
- 3 altar carpet
- 4 altar (communion table, Lord's table, holy table)
- 5 altar steps
- 6 altar cloth
- 7 altar candle
- 8 pyx (pix)
- 9 paten (patin, patine)
- 10 chalice (communion cup)
- 11 Bible (Holy Bible, Scriptures, Holy Scripture)
- 12 altar crucifix
- 13 altarpiece
- 14 church window
- 15 stained glass
- 16 wall candelabrum
- 17 vestry door (sacristy door)
- 18 pulpit steps
- 19 pulpit
- 20 antependium
- 21 canopy (soundboard, sounding board)
- 22 preacher (pastor, vicar, clergyman, rector) in his robes (vestments, canonicals)
- 23 pulpit balustrade
- 24 hymn board showing hymn numbers
- 25 gallery
- 26 vergers (sexton, sacristan)
- 27 aisle
- 28 pew; collectively: pews (seating)
- 29 churchgoer (worshipper); collectively: congregation
- 30 hymn book

**31-62 Roman Catholic church**

- 31 altar steps
- 32 presbytery (choir, chancel, sacrarium, sanctuary)
- 33 altar
- 34 altar candles
- 35 altar cross
- 36 altar cloth
- 37 lectern
- 38 missal (mass book)
- 39 priest
- 40 server
- 41 sedilia
- 42 tabernacle
- 43 stela (stela)

- 44 paschal candle (Easter candle)
- 45 paschal candlestick (Easter candlestick)
- 46 sanctus bell
- 47 processional cross
- 48 altar decoration (foliage, flower arrangement)
- 49 sanctuary lamp
- 50 altarpiece, a picture of Christ
- 51 Madonna, statue of the Virgin Mary
- 52 pricket
- 53 votive candles
- 54 station of the Cross
- 55 offertory box
- 56 literature stand
- 57 literature (pamphlets, tracts)
- 58 vergers (sexton, sacristan)
- 59 offertory bag
- 60 offering
- 61 man praying
- 62 prayer book

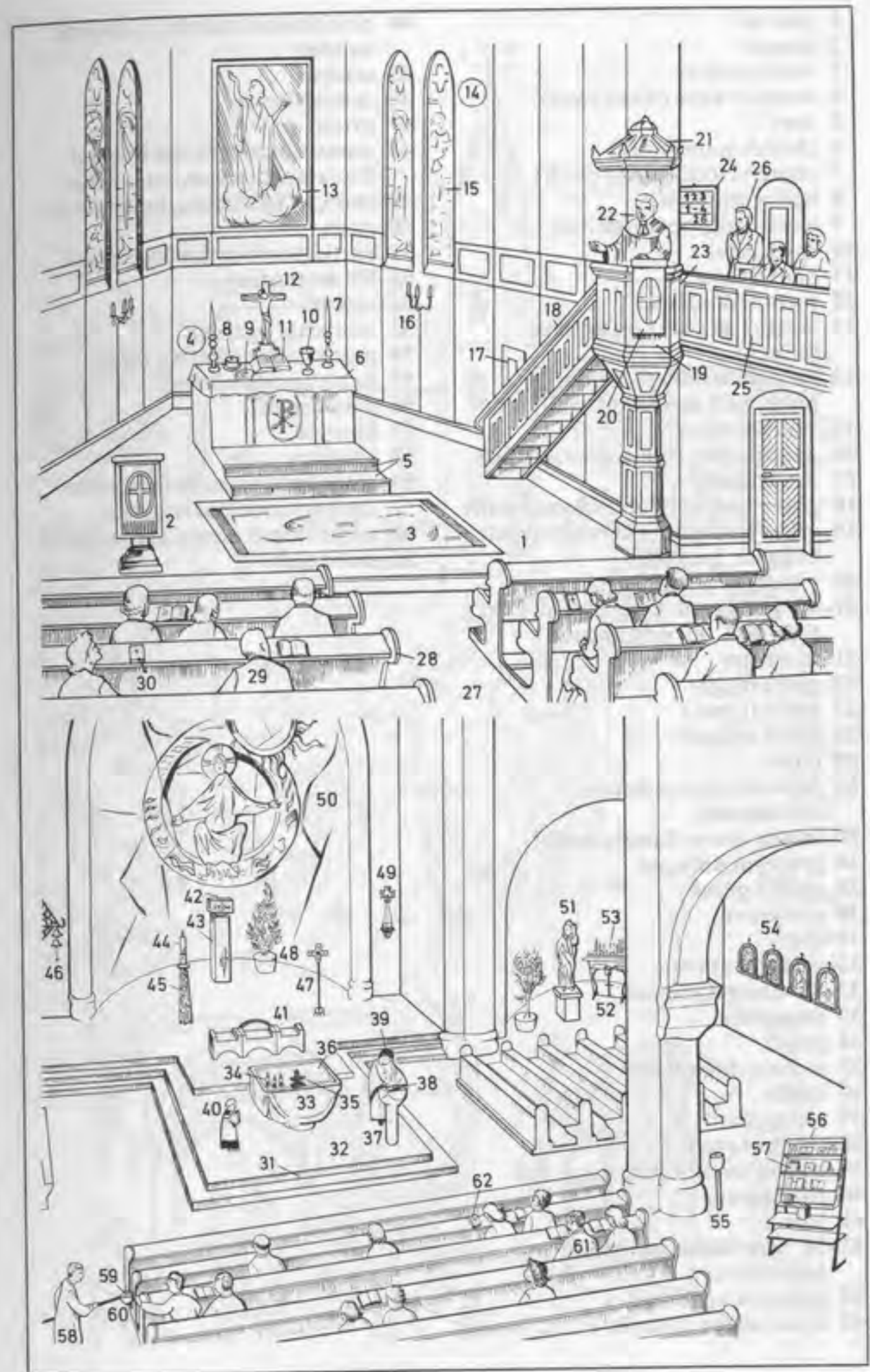



- 1 church  
 2 steeple  
 3 weathercock  
 4 weather vane (wind vane)  
 5 apex  
 6 church spire (spire)  
 7 church clock (tower clock)  
 8 belfry window  
 9 electrically operated bell  
 10 ridge cross  
 11 church roof  
 12 memorial chapel  
 13 vestry (sacristy), an annexe (annex)  
 14 memorial tablet (memorial plate, wall memorial, wall stone)  
 15 side entrance  
 16 church door (main door, portal)  
 17 churchgoer  
 18 graveyard wall (churchyard wall)  
 19 graveyard gate (churchyard gate, lichgate, lychgate)  
 20 vicarage (parsonage, rectory)  
 21-41 graveyard (churchyard, God's acre, *Am.* burying ground)  
 21 mortuary  
 22 grave digger  
 23 grave (tomb)  
 24 grave mound  
 25 cross  
 26 gravestone (headstone, tombstone)  
 27 family grave (family tomb)  
 28 graveyard chapel  
 29 child's grave  
 30 urn grave  
 31 urn  
 32 soldier's grave  
 33-41 funeral (burial)  
 33 mourners  
 34 grave  
 35 coffin (*Am.* casket)  
 36 spade  
 37 clergyman  
 38 the bereaved  
 39 widow's veil, a mourning veil  
 40 pallbearers  
 41 bier  
 42-50 procession (religious procession)  
 42 processional crucifix  
 43 cross bearer (crucifer)  
 44 processional banner, a church banner  
 45 acolyte  
 46 canopy bearer  
 47 priest  
 48 monstrance with the Blessed Sacrament (consecrated Host)  
 49 canopy (baldachin, baldaquin)  
 50 nuns  
 51 participants in the procession  
 52-58 monastery  
 52 cloister  
 53 monastery garden  
 54 monk, a Benedictine monk  
 55 habit (monk's habit)  
 56 cowl (hood)  
 57 tonsure  
 58 breviary  
 59 catacomb, an early Christian underground burial place  
 60 niche (tomb recess, arcosolium)  
 61 stone slab

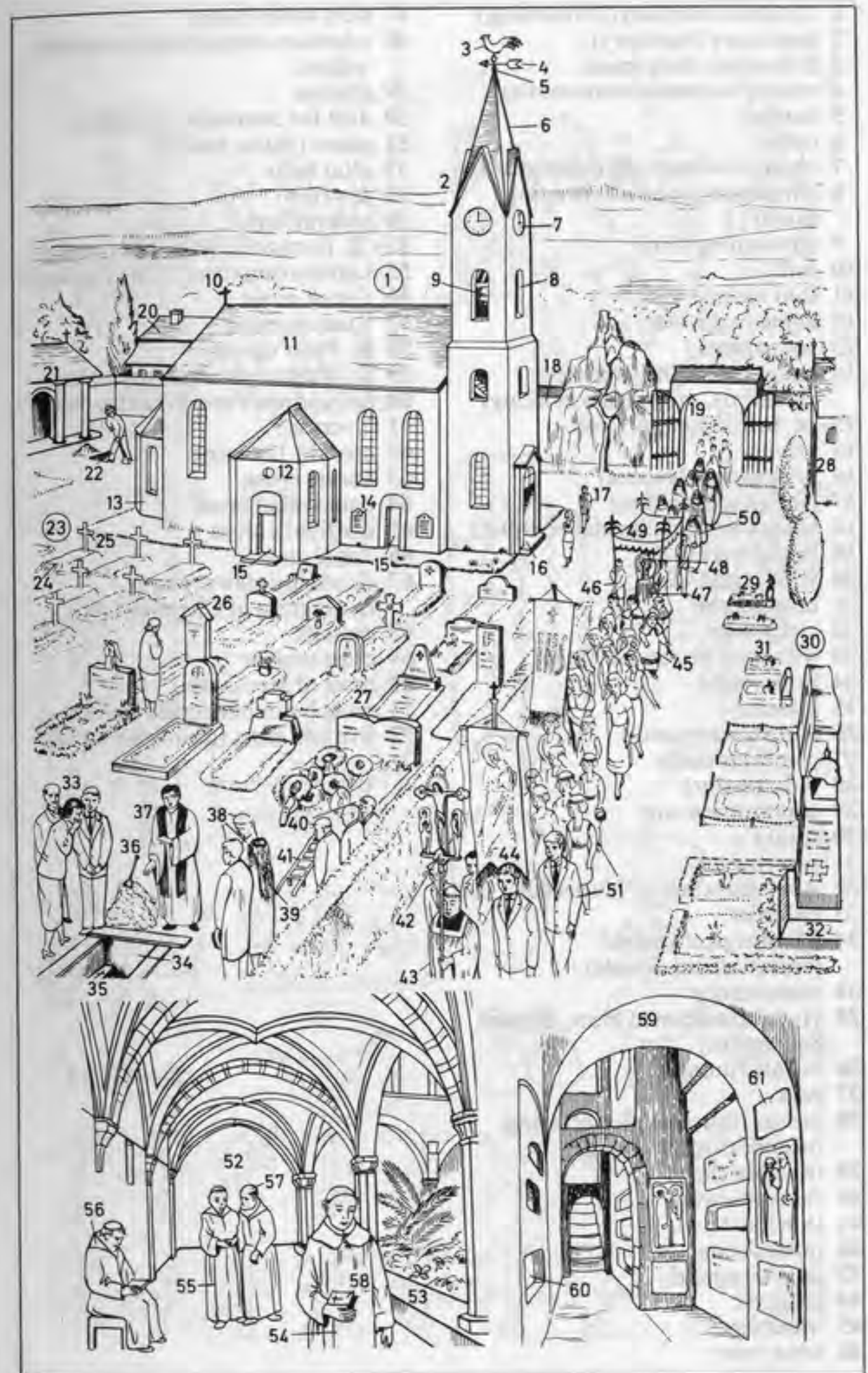



- 1 Christian baptism (christening)
- 2 baptistery (baptistry)
- 3 Protestant clergyman
- 4 robes (vestments, canonicals)
- 5 bands
- 6 collar
- 7 child to be baptized (christened)
- 8 christening robe (christening dress)
- 9 christening shawl
- 10 font
- 11 font basin
- 12 baptismal water
- 13 godparents
- 14 church wedding (wedding ceremony, marriage ceremony)
- 15-16 bridal couple
- 15 bride
- 16 bridegroom (groom)
- 17 ring (wedding ring)
- 18 bride's bouquet (bridal bouquet)
- 19 bridal wreath
- 20 veil (bridal veil)
- 21 buttonhole
- 22 clergyman
- 23 witnesses [to the marriage]
- 24 bridesmaid
- 25 kneeler
- 26 Holy Communion
- 27 communicants
- 28 Host (wafer)
- 29 communion cup
- 30 rosary
- 31 paternoster
- 32 Ave Maria; *set of 10*: decade
- 33 crucifix
- 34-54 liturgical vessels (ecclesiastical vessels)
- 34 monstrance
- 35 Host (consecrated Host, Blessed Sacrament)
- 36 lunula (lunule)
- 37 rays
- 38 censer (thurible), for offering incense (for incensing)
- 39 thurible chain
- 40 thurible cover
- 41 thurible bowl
- 42 incense boat
- 43 incense spoon
- 44 cruet set
- 45 water cruet
- 46 wine cruet
- 47 holy water basin
- 48 ciborium containing the sacred wafers
- 49 chalice
- 50 dish for communion wafers
- 51 paten (patin, patine)
- 52 altar bells
- 53 pyx (pix)
- 54 aspergillum
- 55-72 forms of Christian crosses
- 55 Latin cross (cross of the Passion)
- 56 Greek cross
- 57 Russian cross
- 58 St. Peter's cross
- 59 St. Anthony's cross (tau cross)
- 60 St. Andrew's cross (saltire cross)
- 61 Y-cross
- 62 cross of Lorraine
- 63 ansate cross
- 64 patriarchal cross
- 65 cardinal's cross
- 66 Papal cross
- 67 Constantinian cross, a monogram of Christ (CHR)
- 68 crosslet
- 69 cross moline
- 70 cross of Jerusalem
- 71 cross botonnée (cross treflée)
- 72 fivefold cross (quintuple cross)

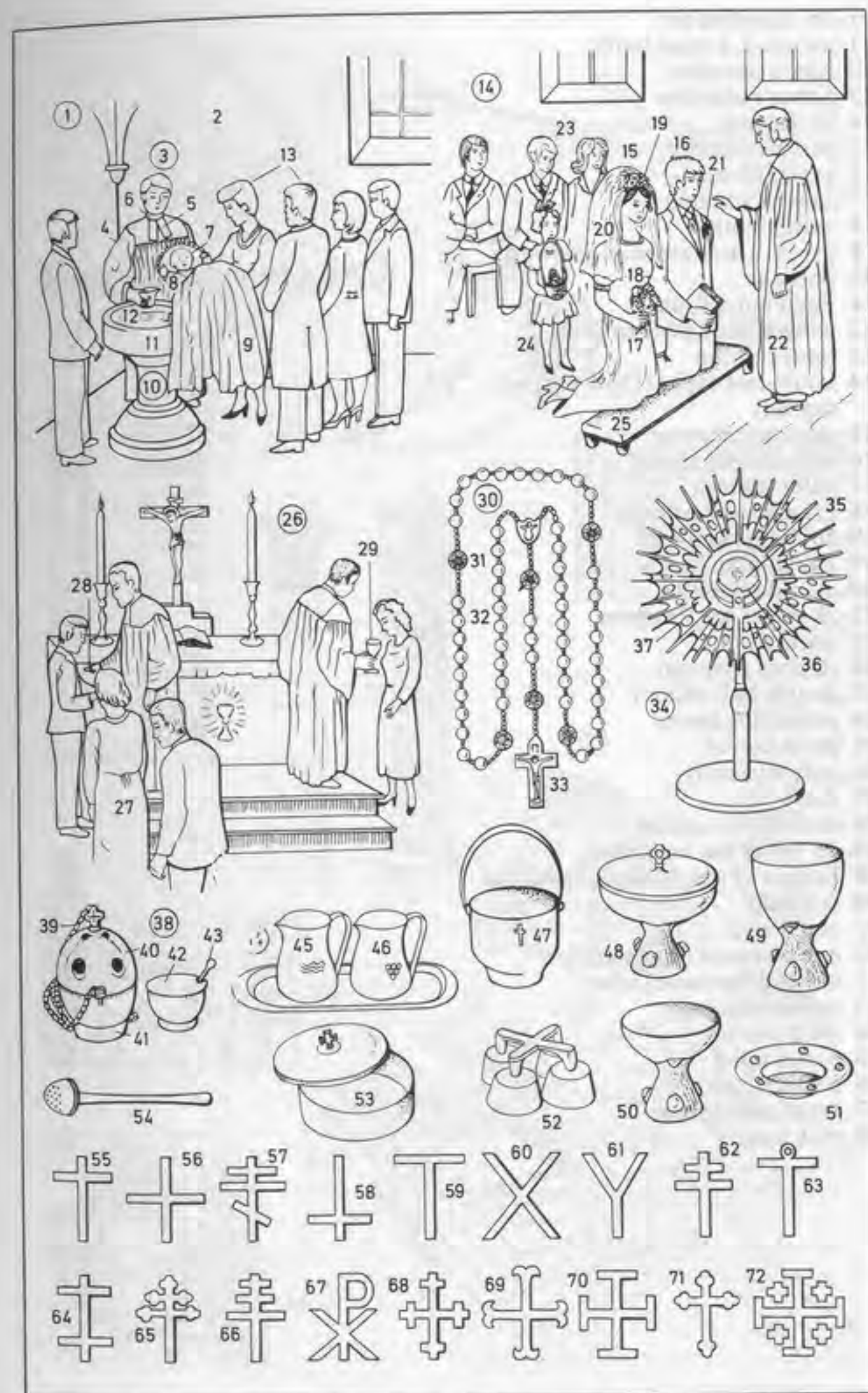



**1-18 Egyptian art**

- 1 pyramid, a royal tomb
- 2 king's chamber
- 3 queen's chamber
- 4 air passage
- 5 coffin chamber
- 6 pyramid site
- 7 funerary temple
- 8 valley temple
- 9 pylon, a monumental gateway
- 10 obelisks
- 11 Egyptian sphinx
- 12 winged sun disc (sun disk)
- 13 lotus column
- 14 knob-leaf capital (bud-shaped capital)

- 15 papyrus column
- 16 bell-shaped capital
- 17 palm column
- 18 ornamented column

**19-20 Babylonian art**

- 19 Babylonian frieze
- 20 glazed relief tile

**21-28 art of the Persians**

- 21 tower tomb
- 22 stepped pyramid
- 23 double bull column
- 24 projecting leaves
- 25 palm capital
- 26 volute (scroll)
- 27 shaft
- 28 double bull capital

**29-36 art of the Assyrians**

- 29 Sargon's Palace, palace buildings
- 30 city wall
- 31 castle wall
- 32 temple tower (ziggurat), a stepped (terraced) tower
- 33 outside staircase
- 34 main portal
- 35 portal relief
- 36 portal figure

**37 art of Asia Minor**

- 38 rock tomb

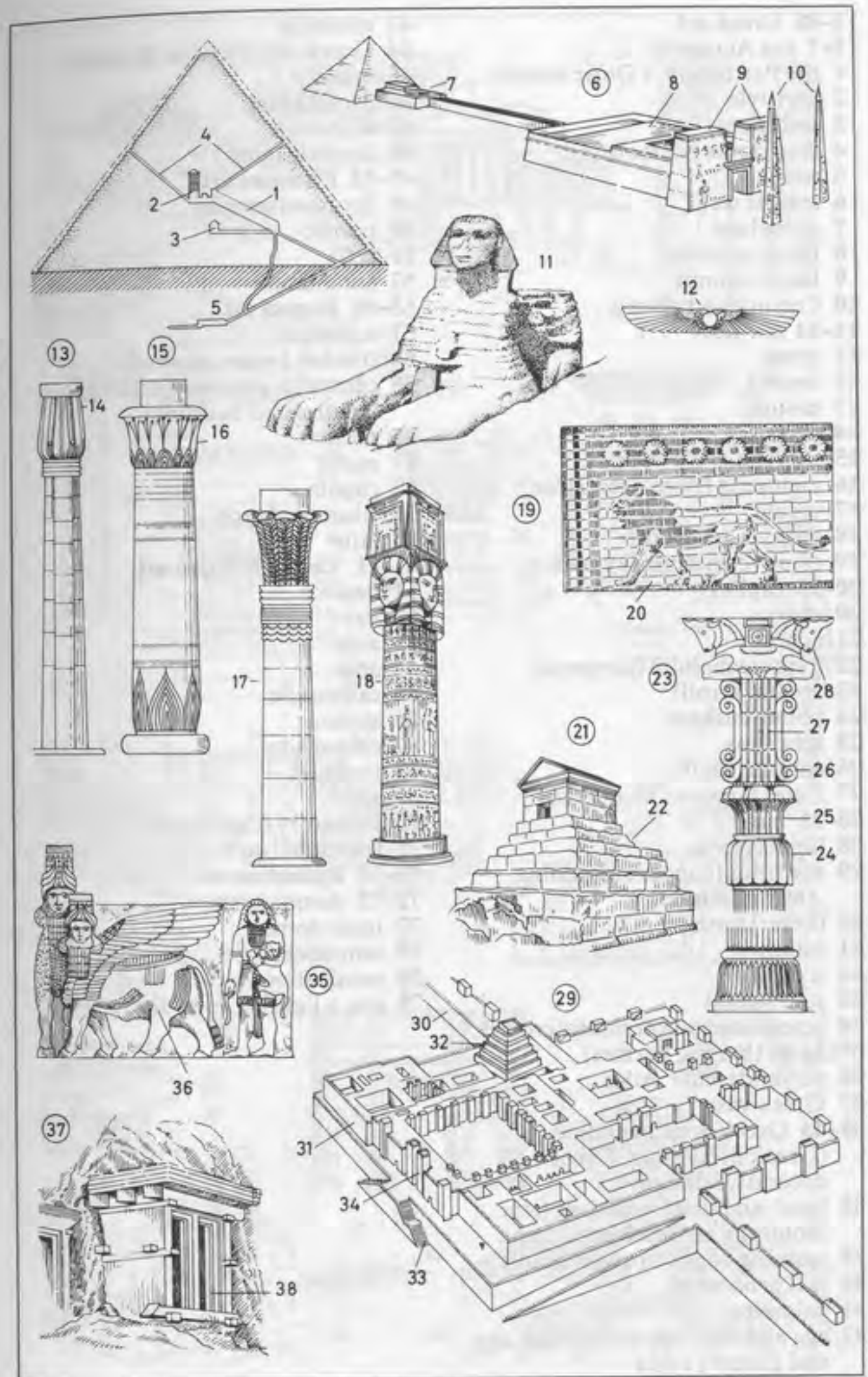



- 1-48 Greek art**  
 1-7 the Acropolis  
 1 the Parthenon, a Doric temple  
 2 peristyle  
 3 pediment  
 4 crepidoma (stereobate)  
 5 statue  
 6 temple wall  
 7 propylaea  
 8 Doric column  
 9 Ionic column  
 10 Corinthian column  
 11-14 cornice  
 11 cyma  
 12 corona  
 13 mutule  
 14 dentils  
 15 triglyph  
 16 metope, a frieze decoration  
 17 regula  
 18 epistyle (architrave)  
 19 cyma (cymatium, kymation)  
 20-25 capital  
 20 abacus  
 21 echinus  
 22 hypotrachelium (gorgerin)  
 23 volute (scroll)  
 24 volute cushion  
 25 acanthus  
 26 column shaft  
 27 flutes (grooves, channels)  
 28-31 base  
 28 [upper] torus  
 29 trochilus (concave moulding, *Am.* molding)  
 30 [lower] torus  
 31 plinth  
 32 stylobate  
 33 stele (stela)  
 34 acroterion (acroterium, acroter)  
 35 herm (herma, hermes)  
 36 caryatid; *male:* Atlas  
 37 Greek vase  
 38-43 Greek ornamentation  
 (Greek decoration, Greek decorative designs)  
 38 bead-and-dart moulding (*Am.* molding), an ornamental band  
 39 running dog (Vitruvian scroll)  
 40 leaf ornament  
 41 palmette  
 42 egg and dart (egg and tongue, egg and anchor) cyma  
 43 meander  
 44 Greek theatre (*Am.* theater)  
 45 scene  
 46 proscenium  
 47 orchestra  
 48 thymele (altar)
- 49-52 Etruscan art**  
 49 Etruscan temple  
 50 portico  
 51 cella  
 52 entablature
- 53-60 Roman art**  
 53 aqueduct  
 54 conduit (water channel)  
 55 centrally-planned building (centralized building)  
 56 portico  
 57 reglet  
 58 cupola  
 59 triumphal arch  
 60 attic
- 61-71 Early Christian art**  
 61 basilica  
 62 nave  
 63 aisle  
 64 apse  
 65 campanile  
 66 atrium  
 67 colonnade  
 68 fountain  
 69 altar  
 70 clerestory (clearstory)  
 71 triumphal arch
- 72-75 Byzantine art**  
 72-73 dome system  
 72 main dome  
 73 semidome  
 74 pendentive  
 75 eye, a lighting aperture

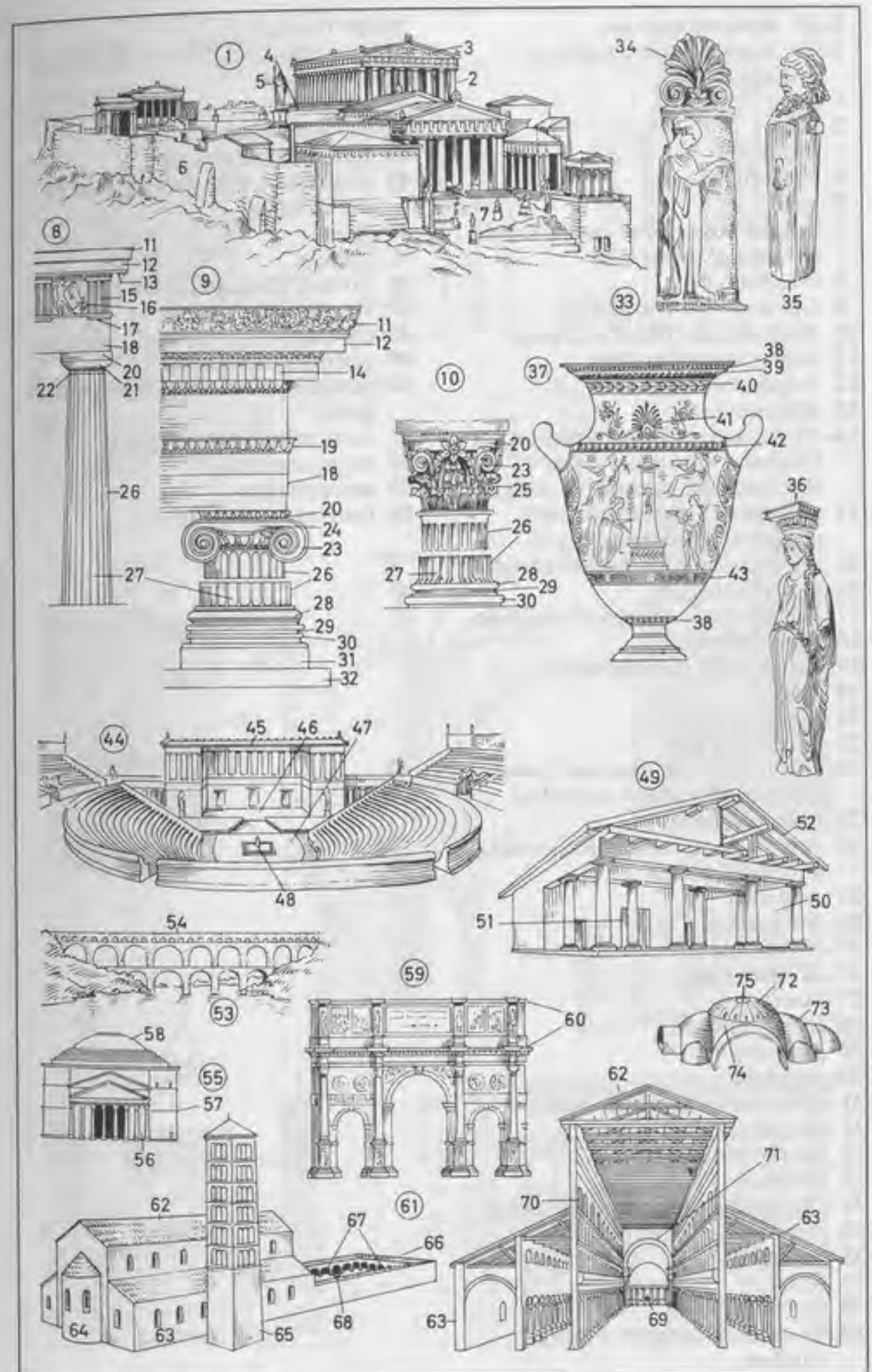



**1-21 Romanesque art**

1-13 Romanesque church, a cathedral

1 nave

2 aisle

3 transept

4 choir (chancel)

5 apse

6 central tower (*Am.* center tower)

7 pyramidal tower roof

8 arcading

9 frieze of round arcading

10 blind arcade (blind arcading)

11 lesene, a pilaster strip

12 circular window

13 side entrance

14-16 Romanesque ornamentation (Romanesque decoration, Romanesque decorative designs)

14 chequered (*Am.* checkered) pattern (chequered design)

15 imbrication (imbricated design)

16 chevron design

17 Romanesque system of vaulting

18 transverse arch

19 barrel vault (tunnel vault)

20 pillar

21 cushion capital

**22-41 Gothic art**

22 Gothic church [westwork, west end, west façade], a cathedral

23 rose window

24 church door (main door, portal), a recessed portal

25 archivolt

26 tympanum

27-35 Gothic structural system

27-28 buttresses

27 buttress

28 flying buttress

29 pinnacle

30 gargoyle

31-32 cross vault (groin vault)

31 ribs (cross ribs)

32 boss (pendant)

33 triforium

34 clustered pier (compound pier)

35 respond (engaged pillar)

36 pediment

37 finial

38 crocket

39-41 tracery window, a lancet window

39-40 tracery

39 quatrefoil

40 cinquefoil

41 mullions

**42-54 Renaissance art**

42 Renaissance church

43 projection, a projecting part of the building

44 drum

45 lantern

46 pilaster (engaged pillar)

47 Renaissance palace

48 cornice

49 pedimental window

50 pedimental window with round gable

51 rustication (rustic work)

52 string course

53 sarcophagus

54 festoon (garland)





- 1-8 Baroque art**  
 1 Baroque church  
 2 bull's eye  
 3 bulbous cupola  
 4 dormer window (dormer)  
 5 curved gable  
 6 twin columns  
 7 cartouche  
 8 scrollwork  
**9-13 Rococo art**  
 9 Rococo wall  
 10 coving, a hollow moulding (*Am.* moulding)  
 11 framing  
 12 ornamental moulding (*Am.* moulding)  
 13 rocaille, a Rococo ornament  
 14 table in Louis Seize style (Louis Seize table)  
 15 neoclassical building (building in neoclassical style), a gateway  
 16 Empire table (table in the Empire style)  
 17 Biedermeier sofa (sofa in the Biedermeier style)  
 18 Art Nouveau easy chair (easy chair in the Art Nouveau style)  
**19-37 types of arch**  
 19 arch  
 20 abutment  
 21 impost  
 22 springer, a voussoir (wedge stone)  
 23 keystone  
 24 face  
 25 pier  
 26 extrados  
 27 round arch  
 28 segmental arch (basket handle)  
 29 parabolic arch  
 30 horseshoe arch  
 31 lancet arch  
 32 trefoil arch  
 33 shouldered arch  
 34 convex arch  
 35 tented arch  
 36 ogee arch (keel arch)  
 37 Tudor arch  
**38-50 types of vault**  
 38 barrel vault (tunnel vault)  
 39 crown  
 40 side  
 41 cloister vault (cloistered vault)

- 42 groin vault (groined vault)  
 43 rib vault (ribbed vault)  
 44 stellar vault  
 45 net vault  
 46 fan vault  
 47 trough vault  
 48 trough  
 49 cavetto vault  
 50 cavetto

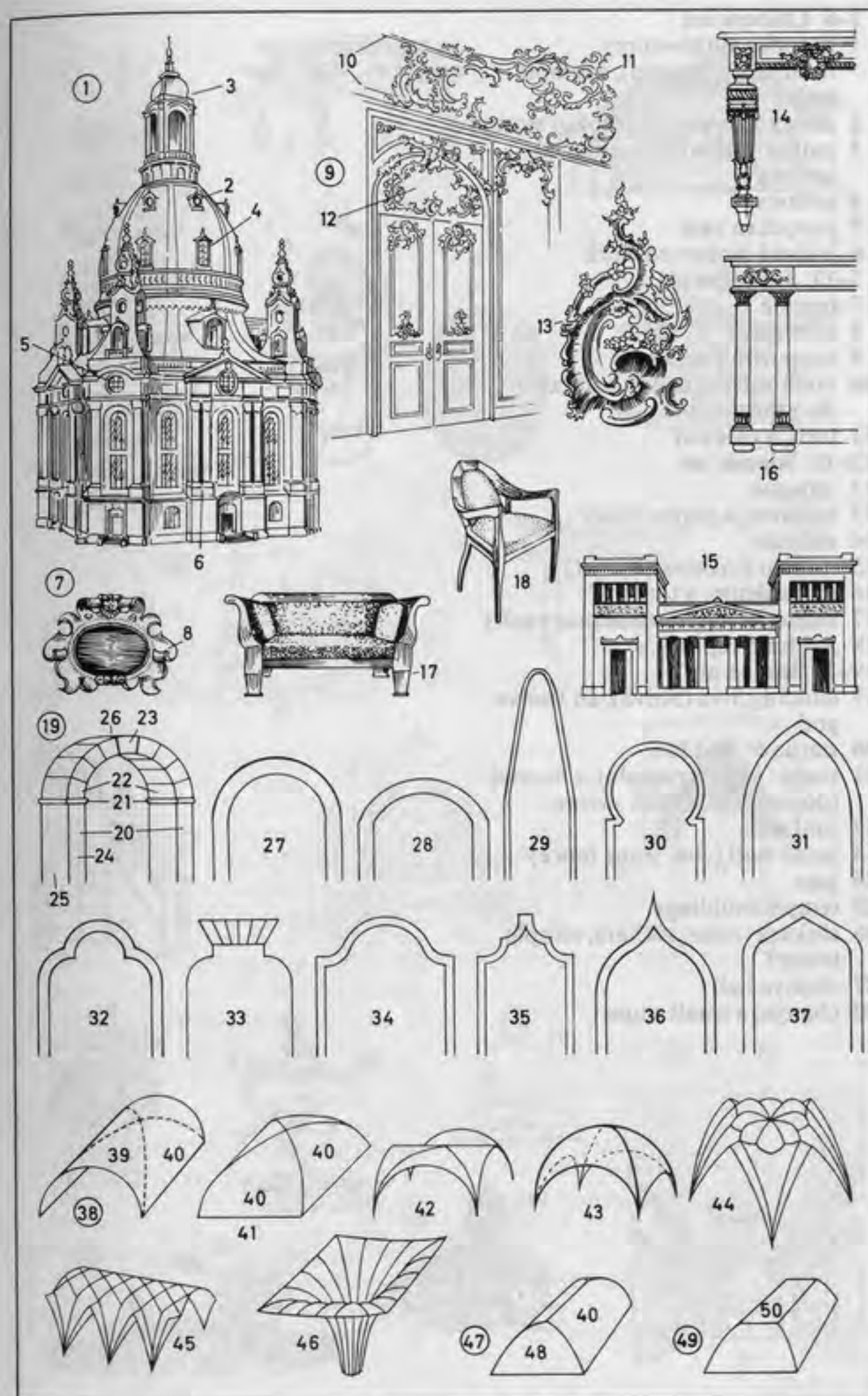



**1-6 Chinese art**

- 1 pagoda (multi-storey, multistory, pagoda), a temple tower  
 2 storey (story) roof (roof of storey)  
 3 pailou (pailoo), a memorial archway  
 4 archway  
 5 porcelain vase  
 6 incised lacquered work

**7-11 Japanese art**

- 7 temple  
 8 bell tower  
 9 supporting structure  
 10 bodhisattva (boddhisattva), a Buddhist saint  
 11 torii, a gateway

**12-18 Islamic art**

- 12 mosque  
 13 minaret, a prayer tower  
 14 mihrab  
 15 minbar (mimbar, pulpit)  
 16 mausoleum, a tomb  
 17 stalactite vault (stalactitic vault)  
 18 Arabian capital

**19-28 Indian art**

- 19 dancing Siva (Shiva), an Indian god  
 20 statue of Buddha  
 21 stupa (Indian pagoda), a mound (dome), a Buddhist shrine  
 22 umbrella  
 23 stone wall (*Am.* stone fence)  
 24 gate  
 25 temple buildings  
 26 shikara (sikas, sikhara, temple tower)  
 27 chaitya hall  
 28 chaitya, a small stupa





**1-43 studio**

- |  |  |
|--|--|
| 1 studio skylight                                | 22 piece of hardboard, with painting surface |
| 2 painter, an artist                             | 23 wooden board                              |
| 3 studio easel                                   | 24 fibreboard ( <i>Am.</i> fiberboard)       |
| 4 chalk sketch, a rough draft                    | 25 painting table                            |
| 5 crayon (piece of chalk)                        | 26 folding easel                             |
| 6-19 painting materials                          | 27 still life group, a motif                 |
| 6 flat brush                                     | 28 palette                                   |
| 7 camel hair brush                               | 29 palette dipper                            |
| 8 round brush                                    | 30 platform                                  |
| 9 priming brush                                  | 31 lay figure (mannequin, manikin)           |
| 10 box of paints (paintbox)                      | 32 nude model (model, nude)                  |
| 11 tube of oil paint                             | 33 drapery                                   |
| 12 varnish                                       | 34 drawing easel                             |
| 13 thinner                                       | 35 sketch pad                                |
| 14 palette knife                                 | 36 study in oils                             |
| 15 spatula                                       | 37 mosaic (tessellation)                     |
| 16 charcoal pencil (charcoal, piece of charcoal) | 38 mosaic figure                             |
| 17 tempera (gouache)                             | 39 tesserae                                  |
| 18 watercolour ( <i>Am.</i> watercolor)          | 40 fresco (mural)                            |
| 19 pastel crayon                                 | 41 sgraffito                                 |
| 20 wedged stretcher (canvas stretcher)           | 42 plaster                                   |
| 21 canvas  | 43 cartoon                                   |



- |  |   |
|--|---|
| 1 sculptor   | 21 mallet                                       |
| 2 proportional dividers                                      | 22 framework                                    |
| 3 calliper (caliper)   | 23 baseboard                                    |
| 4 plaster model, a plaster cast                              | 24 armature support (metal rod)                 |
| 5 block of stone (stone block)                               | 25 armature                                     |
| 6 modeller ( <i>Am.</i> modeler)                             | 26 wax model                                    |
| 7 clay figure, a torso                                       | 27 block of wood                                |
| 8 roll of clay, a modelling ( <i>Am.</i> modeling) substance | 28 wood carver (wood sculptor)                  |
| 9 modelling ( <i>Am.</i> modeling) stand                     | 29 sack of gypsum powder (gypsum)               |
| 10 wooden modelling ( <i>Am.</i> modeling) tool              | 30 clay box                                     |
| 11 wire modelling ( <i>Am.</i> modeling) tool                | 31 modelling ( <i>Am.</i> modeling) clay (clay) |
| 12 beating wood  | 32 statue, a sculpture                          |
| 13 claw chisel (toothed chisel, tooth chisel)                | 33 low relief (bas-relief)                      |
| 14 flat chisel   | 34 modelling ( <i>Am.</i> modeling) board       |
| 15 point (punch)   | 35 wire frame, wire netting                     |
| 16 iron-headed hammer  | 36 circular medallion (tondo)                   |
| 17 gouge (hollow chisel)                                     | 37 mask   |
| 18 spoon chisel  | 38 plaque                                       |
| 19 wood chisel, a bevelled-edge chisel                       |   |
| 20 V-shaped gouge  |   |





- 1-13 wood engraving (xylography),** a relief printing method (a letterpress printing method)
- 1 end-grain block for wood engravings, a wooden block  
 2 wooden plank for woodcutting, a relief image carrier  
 3 positive cut  
 4 plank cut  
 5 burin (graver)  
 6 U-shaped gouge  
 7 scorper (scauper, scalper)  
 8 scoop  
 9 V-shaped gouge  
 10 contour knife  
 11 brush  
 12 roller (brayer)  
 13 pad (wiper)
- 14-24 copperplate engraving (chalcography),** an intaglio process; *kinds:* etching, mezzotint, aquatint, crayon engraving
- 14 hammer  
 15 burin  
 16 etching needle (engraver)  
 17 scraper and burnisher  
 18 roulette  
 19 rocking tool (rocker)  
 20 round-headed graver, a graver (burin)  
 21 oilstone  
 22 dabber (inking ball, ink ball)  
 23 leather roller  
 24 sieve
- 25-26 lithography (stone lithography),** a planographic printing method
- 25 sponge for moistening the lithographic stone  
 26 lithographic crayons (greasy chalk)
- 27-64 graphic art studio, a printing office (Am. printery)**
- 27 broadside (broadsheet, single sheet)  
 28 full-colour (Am. full-color) print (colour print, chromolithograph)  
 29 platen press, a hand press  
 30 toggle  
 31 platen  
 32 type forme (Am. form)

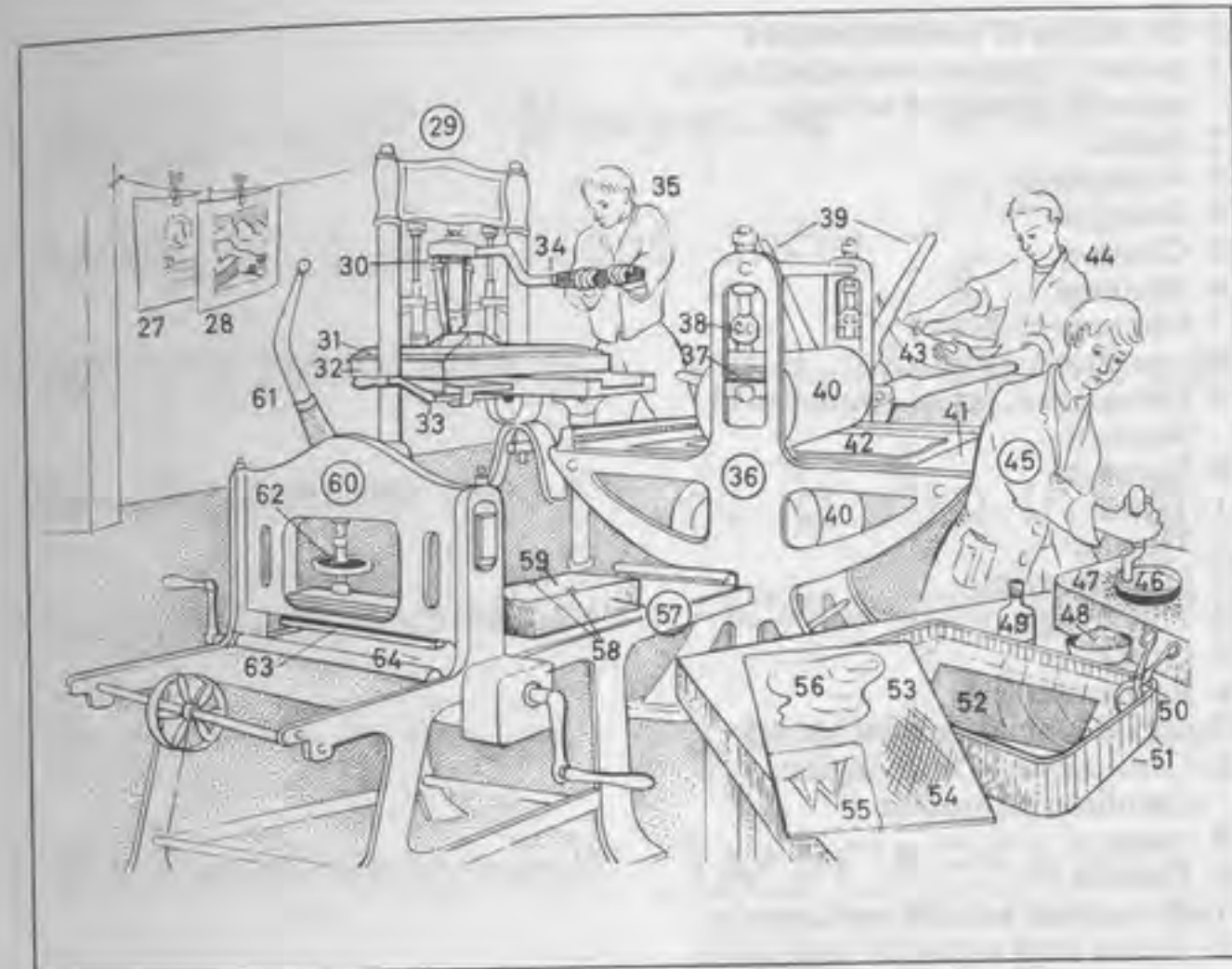







- 33 feed mechanism  
 34 bar (devil's tail)  
 35 pressman  
 36 copperplate press  
 37 tyman  
 38 pressure regulator  
 39 star wheel  
 40 cylinder  
 41 bed  
 42 felt cloth  
 43 proof (pull)  
 44 copperplate engraver  
 45 lithographer (litho artist), grinding the stone  
 46 grinding disc (disk)  
 47 grain (granular texture)  
 48 pulverized glass  
 49 rubber solution  
 50 tongs  
 51 etching bath for etching  
 52 zinc plate  
 53 polished copperplate  
 54 cross hatch  
 55 etching ground  
 56 non-printing area
- 57 lithographic stone  
 58 register marks  
 59 printing surface (printing image carrier)  
 60 lithographic press  
 61 lever  
 62 scraper adjustment  
 63 scraper  
 64 bed

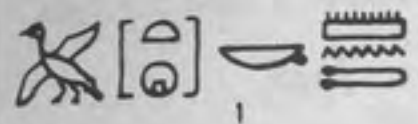
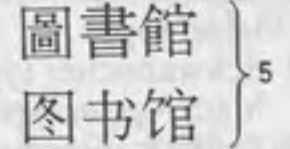
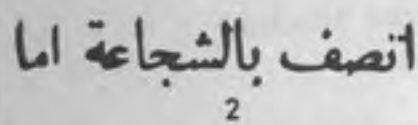
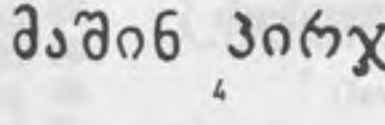
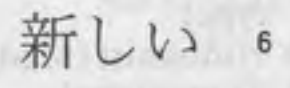

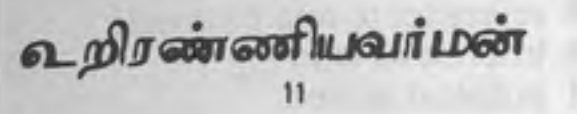
1-20 scripts of various peoples

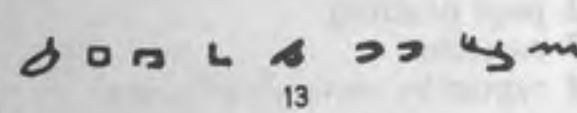
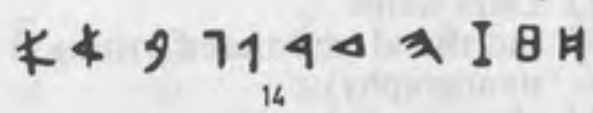
- 1 ancient Egyptian hieroglyphics, a pictorial system of writing
- 2 Arabic
- 3 Armenian
- 4 Georgian
- 5 Chinese
- 6 Japanese
- 7 Hebrew (Hebraic)
- 8 cuneiform script
- 9 Devanagari, script employed in Sanskrit
- 10 Siamese
- 11 Tamil
- 12 Tibetan
- 13 Sinaitic script
- 14 Phoenician
- 15 Greek
- 16 Roman capitals
- 17 uncial (uncials, uncial script)
- 18 Carolingian (Carlovingian, Caroline) minuscule
- 19 runes
- 20 Russian
- 21-26 ancient writing implements
- 21 Indian steel stylus for writing on palm leaves
- 22 ancient Egyptian reed pen
- 23 writing cane
- 24 brush
- 25 Roman metal pen (stylus)
- 26 quill (quill pen)
- 27 Korean

 <p>1</p>	 <p>3</p>	 <p>5</p>
 <p>2</p>	 <p>4</p>	 <p>6</p>
 <p>7</p>	 <p>8</p>	
 <p>9</p>	 <p>10</p>	
 <p>11</p>	 <p>12</p>	
 <p>13</p>	 <p>14</p>	
 <p>15</p>	 <p>16</p>	
 <p>17</p>	 <p>18</p>	
 <p>19</p>	 <p>20</p>	

책입니다 27

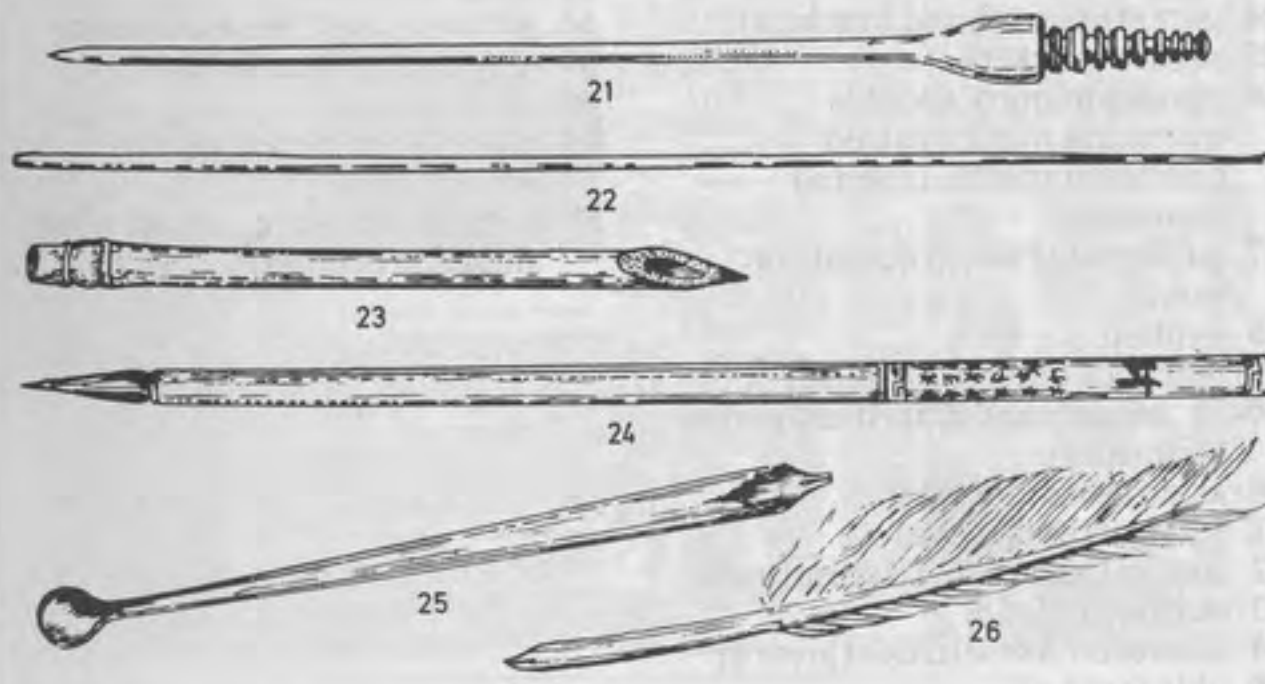



- 1-15 types (type faces)
- 1 Gothic type (German black-letter type)
  - 2 Schwabacher type (German black-letter type)
  - 3 Fraktur (German black-letter type)
  - 4 Humanist (Mediaeval)
  - 5 Transitional
  - 6 Didone
  - 7 Sanserif (Sanserif type, Grottesque)
  - 8 Egyptian
  - 9 typescript (typewriting)
  - 10 English hand (English handwriting, English writing)
  - 11 German hand (German handwriting, German writing)
  - 12 Latin script
  - 13 shorthand (shorthand writing, stenography)
  - 14 phonetics (phonetic transcription)
  - 15 Braille
- 16-29 punctuation marks (stops)
- 16 full stop (period, full point)
  - 17 colon
  - 18 comma
  - 19 semicolon
  - 20 question mark (interrogation point, interrogation mark)
  - 21 exclamation mark (*Am.* exclamation point)
  - 22 apostrophe
  - 23 dash (em rule)
  - 24 parentheses (round brackets)
  - 25 square brackets
  - 26 quotation mark (double quotation marks, paired quotation marks, inverted commas)
  - 27 guillemet (French quotation mark)
  - 28 hyphen
  - 29 marks of omission (ellipsis)
- 30-35 accents and diacritical marks (diacritics)
- 30 acute accent (acute)
  - 31 grave accent (grave)
  - 32 circumflex accent (circumflex)
  - 33 cedilla [under c]
  - 34 diaeresis (*Am.* dieresis) [over e]
  - 35 tilde [over n]
- 36 section mark
  - 37-70 newspaper, a national daily newspaper
  - 37 newspaper page
  - 38 front page
  - 39 newspaper heading
  - 40 contents
  - 41 price
  - 42 date of publication
  - 43 place of publication
  - 44 headline
  - 45 column
  - 46 column heading
  - 47 column rule
  - 48 leading article (leader, editorial)
  - 49 reference to related article
  - 50 brief news item
  - 51 political section
  - 52 page heading
  - 53 cartoon
  - 54 report by newspaper's own correspondent
  - 55 news agency's sign
  - 56 advertisement (*coll. ad*)
  - 57 sports section
  - 58 press photo
  - 59 caption
  - 60 sports report
  - 61 sports news item
  - 62 home and overseas news section
  - 63 news in brief (miscellaneous news)
  - 64 television programmes (*Am.* programs)
  - 65 weather report
  - 66 weather chart (weather map)
  - 67 arts section (feuilleton)
  - 68 death notice
  - 69 advertisements (classified advertising)
  - 70 job advertisement, a vacancy (a situation offered)





- 1 red
- 2 yellow
- 3 blue
- 4 pink
- 5 brown
- 6 azure (sky blue)
- 7 orange
- 8 green
- 9 violet
- 10 additive mixture of colours (*Am. colors*)
- 11 white
- 12 subtractive mixture of colours (*Am. colors*)
- 13 black
- 14 solar spectrum (colours, *Am. colors*, of the rainbow)
- 15 grey (*Am. gray*) scale
- 16 heat colours (*Am. colors*)

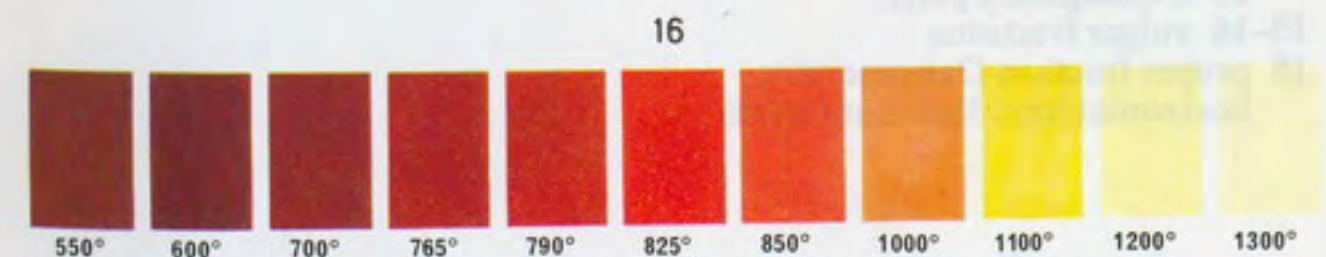
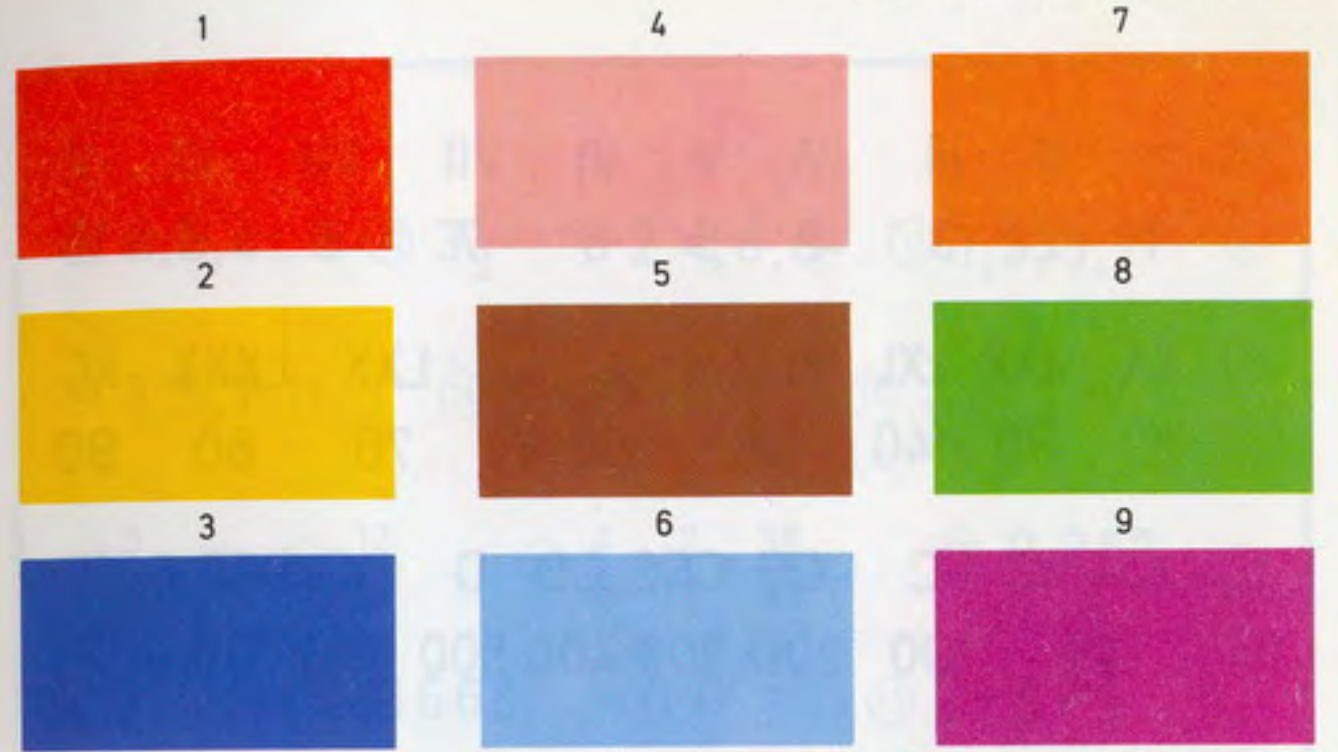

550° 600° 700° 765° 790° 825° 850° 1000° 1100° 1200° 1300°



- ① I II III IV V VI VII VIII IX X  
 ② 1 2 3 4 5 6 7 8 9 10
- ① XX XXX XL XLIX IL L LX LXX LXXX XC  
 ② 20 30 40 49 50 60 70 80 90
- ① XCIX IC C CC CCC CD D DC DCC DCCC  
 ② 99 100 200 300 400 500 600 700 800
- ① CM CMXC M  
 ② 900 990 1000
- ③ 9658 ④ 5 kg. ⑤ 2 ⑥ 2<sup>nd</sup> ⑦ +5 ⑧ -5

**1-26 arithmetic****1-22 numbers**

- 1 Roman numerals  
 2 Arabic numerals  
 3 abstract number, a four-figure number [8: units; 5: tens; 6: hundreds; 9: thousands]  
 4 concrete number  
 5 cardinal number (cardinal)  
 6 ordinal number (ordinal)  
 7 positive number [with plus sign]  
 8 negative number [with minus sign]  
 9 algebraic symbols  
 10 mixed number [3: whole number (integer);  $\frac{1}{3}$ : fraction]  
 11 even numbers  
 12 odd numbers  
 13 prime numbers  
 14 complex number [3: real part;  $2\sqrt{-1}$ : imaginary part]  
 15-16 vulgar fractions  
 15 proper fraction [2: numerator, horizontal line; 3: denominator]

- 16 improper fraction, also the reciprocal of item 15  
 17 compound fraction (complex fraction)  
 18 improper fraction [when cancelled down produces a whole number]  
 19 fractions of different denominations [35: common denominator]  
 20 proper decimal fraction with decimal point and decimal places [3: tenths; 5: hundredths; 7: thousandths]  
 21 recurring decimal  
 22 recurring decimal

- ⑨ a, b, c ... ⑩  $3\frac{1}{3}$  ⑪ 2, 4, 6, 8 ⑫ 1, 3, 5, 7
- ⑬ 3, 5, 7, 11 ⑭  $3+2\sqrt{-1}$  ⑮  $\frac{2}{3}$  ⑯  $\frac{3}{2}$
- ⑰  $\frac{5}{6}$  ⑱  $\frac{12}{4}$  ⑲  $\frac{4}{5} + \frac{2}{7} = \frac{38}{35}$  ⑳ 0.357
- ⑳  $\frac{3}{4}$  ㉑  $0.6666\dots = 0.\bar{6}$  ㉒  $3+2=5$
- ㉓  $3-2=1$  ㉔  $3 \cdot 2=6$  ㉕  $6 \div 2=3$   
 $3 \times 2=6$

**23-26 fundamental arithmetical operations**

- 23 addition (adding) [3 and 2: the terms of the sum; +: plus sign; =: equals sign; 5: the sum]  
 24 subtraction (subtracting); [3: the minuend; -: minus sign; 2: the subtrahend; 1: the remainder (difference)]  
 25 multiplication (multiplying); [3: the multiplicand;  $\times$ : multiplication sign; 2: the multiplier; 2 and 3: factors; 6: the product]  
 26 division (dividing); [6: the dividend;  $\div$ : division sign; 2: the divisor; 3: the quotient]



$$\begin{array}{lll} \textcircled{1} 3^2 = 9 & \textcircled{2} \sqrt[3]{8} = 2 & \textcircled{3} \sqrt{4} = 2 \\ & \textcircled{4} 3x + 2 = 12 & \\ & & \textcircled{6} \\ \textcircled{5} 4a + 6ab - 2ac = 2a(2 + 3b - c) & \log_{10} 3 = 0.4771 & \\ & & \\ \textcircled{7} \frac{P[\pounds 1000] \times R[5\%] \times T[2 \text{ years}]}{100} = I[\pounds 100] & & \end{array}$$

**1-24 arithmetic****1-10 advanced arithmetical operations**

- 1 raising to a power [three squared ( $3^2$ ): the power; 3: the base; 2: the exponent (index); 9: value of the power]  
 2 evolution (extracting a root); [cube-root of 8: cube root; 8: the radical; 3: the index (degree) of the root;  $\sqrt{\quad}$ : radical sign; 2: value of the root]  
 3 square root  
 4-5 algebra  
 4 simple equation [3, 2: the coefficients; x: the unknown quantity]  
 5 identical equation; [a, b, c: algebraic symbols]  
 6 logarithmic calculation (taking the logarithm, log); [log: logarithm sign; 3: number whose logarithm is required; 10: the base; 0: the characteristic; 4771:

the mantissa; 0.4771: the logarithm]

- 7 simple interest formula; [P: the principal; R: rate of interest; T: time; I: interest (profit); %: percentage sign]  
 8-10 rule of three (rule-of-three sum, simple proportion)  
 8 statement with the unknown quantity x  
 9 equation (conditional equation)  
 10 solution  
**11-14 higher mathematics**  
 11 arithmetical series with the elements 2, 4, 6, 8  
 12 geometrical series  
**13-14 infinitesimal calculus**  
 13 derivative [dx, dy: the differentials; d: differential sign]  
 14 integral (integration); [x: the variable; C: constant of integration; S: the integral sign; dx: the differential]

$$\begin{array}{ll} \textcircled{8} \begin{array}{l} 2 \text{ years @ } \pounds 50 \\ 4 \text{ years @ } \pounds x \end{array} & \textcircled{11} 2 + 4 + 6 + 8 \dots \\ \hline \textcircled{9} 2 : 50 = 4 : x & \textcircled{12} 2 + 4 + 8 + 16 + 32 \dots \quad \textcircled{13} \frac{dy}{dx} \\ \textcircled{10} x = \pounds 100 & \textcircled{14} \int ax dx = a \int x dx = \frac{ax^2}{2} + C \\ \textcircled{15} \infty & \textcircled{16} \equiv & \textcircled{17} \approx & \textcircled{18} \neq & \textcircled{19} > \\ \textcircled{20} < & \textcircled{21} \parallel & \textcircled{22} \sim & \textcircled{23} \sphericalangle & \textcircled{24} \triangle \end{array}$$

**15-24 mathematical symbols**

- 15 infinity  
 16 identically equal to (the sign of identity)  
 17 approximately equal to  
 18 unequal to  
 19 greater than  
 20 less than  
**21-24 geometrical symbols**  
 21 parallel (sign of parallelism)  
 22 similar to (sign of similarity)  
 23 angle symbol  
 24 triangle symbol



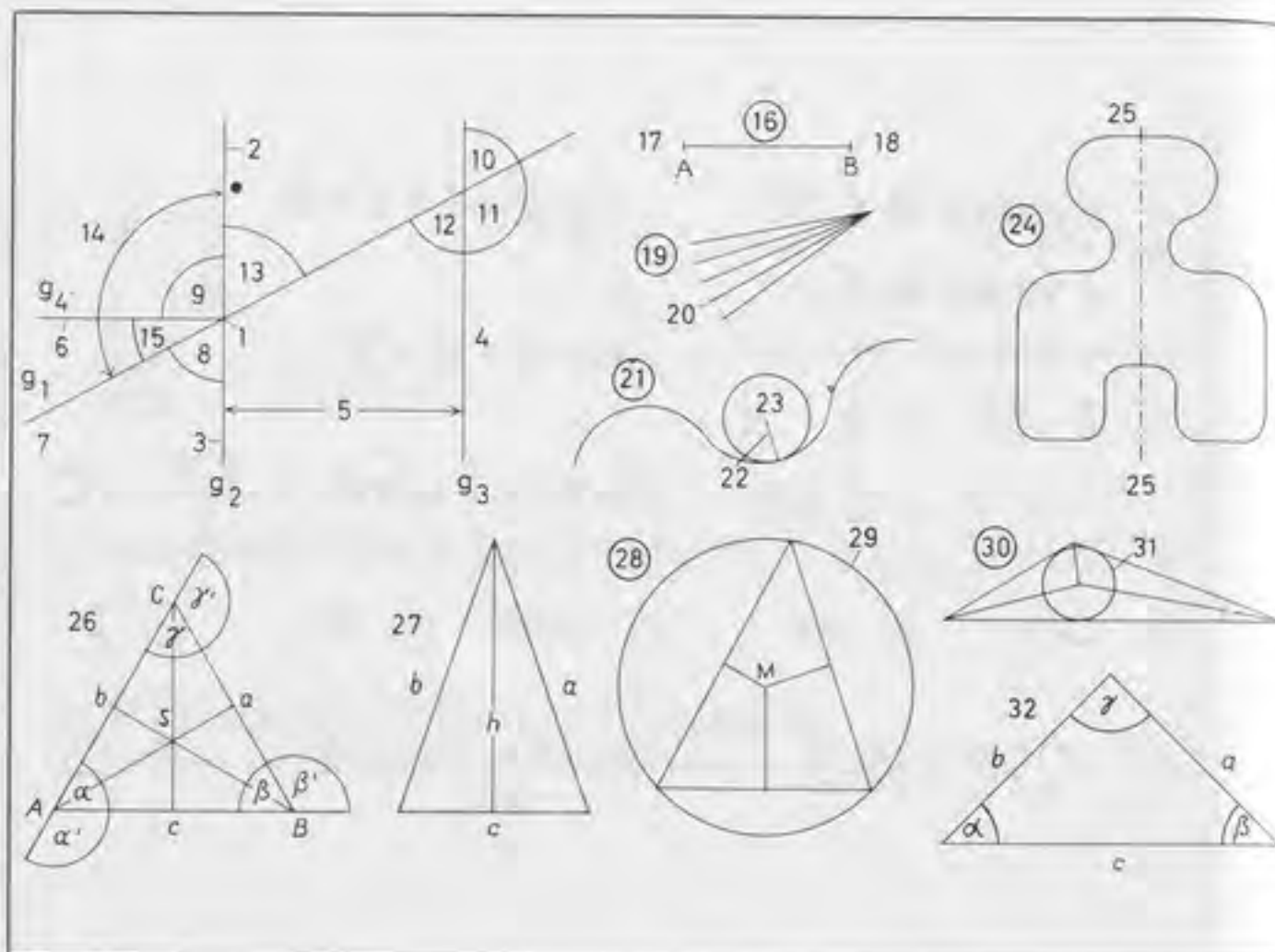

**1-58 plane geometry** (elementary geometry, Euclidian geometry)

**1-23 point, line, angle**

1 point [point of intersection of  $g_1$  and  $g_2$ ], the angular point of 8

2, 3 straight line  $g_2$

4 the parallel to  $g_2$

5 distance between the straight lines  $g_2$  and  $g_3$

6 perpendicular ( $g_4$ ) on  $g_2$

7, 3 the arms of 8

8, 13 vertically opposite angles

8 angle

9 right angle  $[90^\circ]$

10, 11, 12 reflex angle

10 acute angle, also the alternate angle to 8

11 obtuse angle

12 corresponding angle to 8

13, 9, 15 straight angle  $[180^\circ]$

14 adjacent angle; *here*: supplementary angle to 13

15 complementary angle to 8

16 straight line AB

17 end A

18 end B

19 pencil of rays

20 ray

21 curved line

22 radius of curvature

23 centre (*Am. center*) of curvature

**24-58 plane surfaces**

24 symmetrical figure

25 axis of symmetry

**26-32 plane triangles**

26 equilateral triangle; [A, B, C: the vertices; a, b, c: the sides;  $\alpha$  (alpha),  $\beta$  (beta),  $\gamma$  (gamma): the interior angles;  $\alpha'$ ,  $\beta'$ ,  $\gamma'$ : the exterior angles; S: the centre (*Am. center*)]

27 isosceles triangle [a, b: the sides (legs); c: the base; h: the perpendicular, an altitude]

28 acute-angled triangle with perpendicular bisectors of the sides

29 circumcircle (circumscribed circle)

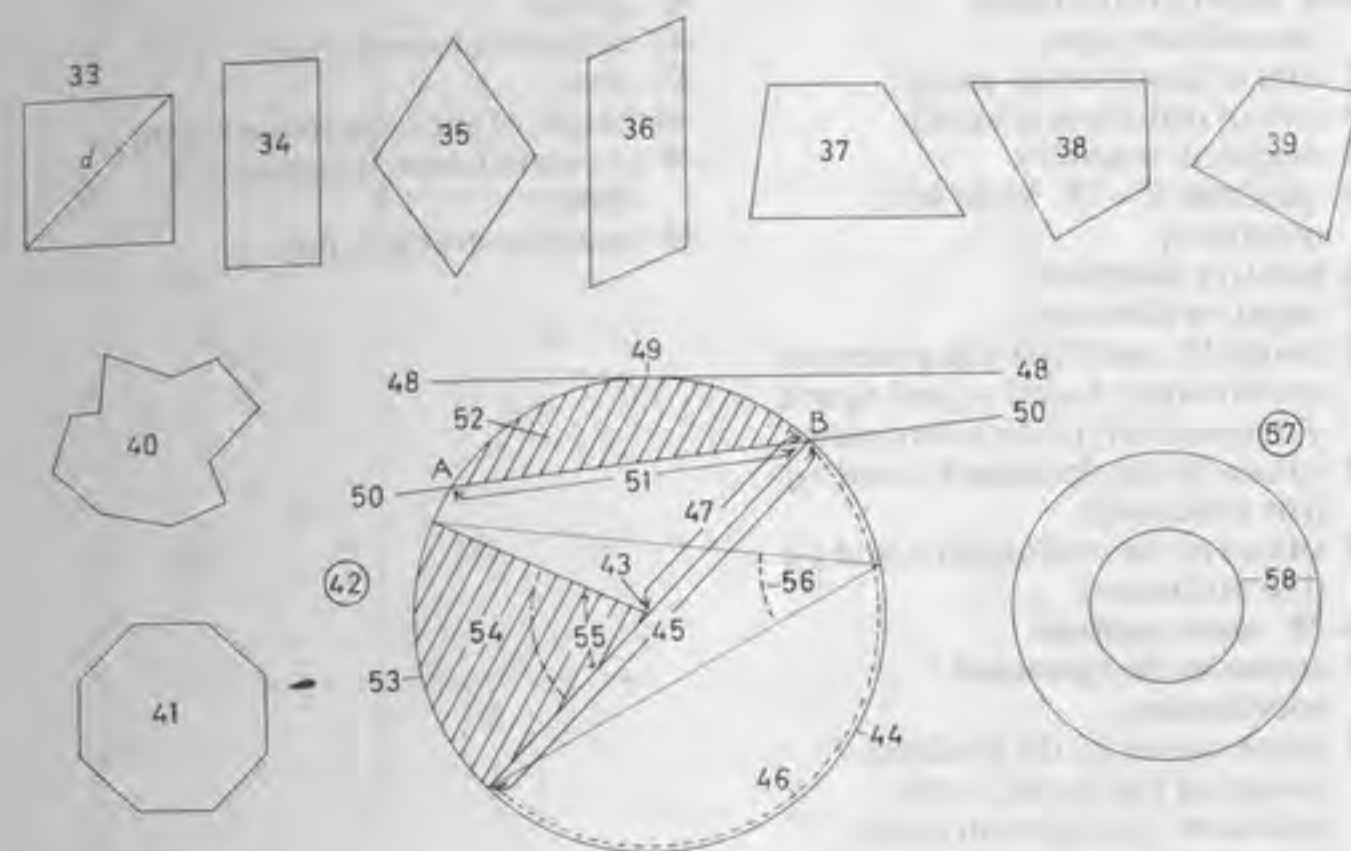

30 obtuse-angled triangle with

bisectors of the angles

31 inscribed circle

32 right-angled triangle and the trigonometrical functions of angles; [a, b: the catheti; c: the hypotenuse;  $\gamma$ : the right angle;  $\frac{a}{c} = \sin \alpha$  (sine);  $\frac{b}{c} = \cos \alpha$  (cosine);  $\frac{a}{b} = \tan \alpha$  (tangent);  $\frac{b}{a} = \cot \alpha$  (cotangent)]

**33-39 quadrilaterals**

**33-36 parallelograms**

33 square [d: a diagonal]

34 rectangle

35 rhombus (rhomb, lozenge)

36 rhomboid

37 trapezium

38 deltoid (kite)

39 irregular quadrilateral

40 polygon

41 regular polygon

42 circle

43 centre (*Am. center*)

44 circumference (periphery)

45 diameter

46 semicircle

47 radius (r)

48 tangent

49 point of contact (P)

50 secant

51 the chord AB

52 segment

53 arc

54 sector

55 angle subtended by the arc at the centre (*Am. center*) (centre, *Am. center*, angle)

56 circumferential angle

57 ring (annulus)

58 concentric circles



- 1 system of right-angled coordinates
- 2-3 axes of coordinates (coordinate axes)
- 2 axis of abscissae (x-axis)
- 3 axis of ordinates (y-axis)
- 4 origin of ordinates
- 5 quadrant [I - IV: 1st to 4th quadrant]
- 6 positive direction
- 7 negative direction
- 8 points  $[P_1$  and  $P_2]$  in the system of coordinates;  $x_1$  and  $y_1$  [and  $x_2$  and  $y_2$  respectively] their coordinates
- 9 values of the abscissae [ $x_1$  and  $x_2$ ] (the abscissae)
- 10 values of the ordinates [ $y_1$  and  $y_2$ ] (the ordinates)
- 11-29 conic sections
- 11 curves in the system of coordinates
- 12 plane curves [a: the gradient (slope) of the curve; b: the ordinates' intersection of the curve; c: the root of the curve]
- 13 inflected curves
- 14 parabola, a curve of the second degree
- 15 branches of the parabola
- 16 vertex of the parabola
- 17 axis of the parabola
- 18 a curve of the third degree
- 19 maximum of the curve
- 20 minimum of the curve
- 21 point of inflexion (of inflection)
- 22 ellipse
- 23 transverse axis (major axis)
- 24 conjugate axis (minor axis)
- 25 foci of the ellipse [ $F_1$  and  $F_2$ ]
- 26 hyperbola
- 27 foci [ $F_1$  and  $F_2$ ]
- 28 vertices [ $S_1$  and  $S_2$ ]
- 29 asymptotes [a and b]
- 30-46 solids
- 30 cube
- 31 square, a plane (plane surface)
- 32 edge
- 33 corner
- 34 quadratic prism
- 35 base
- 36 parallelepiped
- 37 triangular prism
- 38 cylinder, a right cylinder
- 39 base, a circular plane
- 40 curved surface
- 41 sphere
- 42 ellipsoid of revolution
- 43 cone
- 44 height of the cone (cone height)
- 45 truncated cone (frustum of a cone)
- 46 quadrilateral pyramid

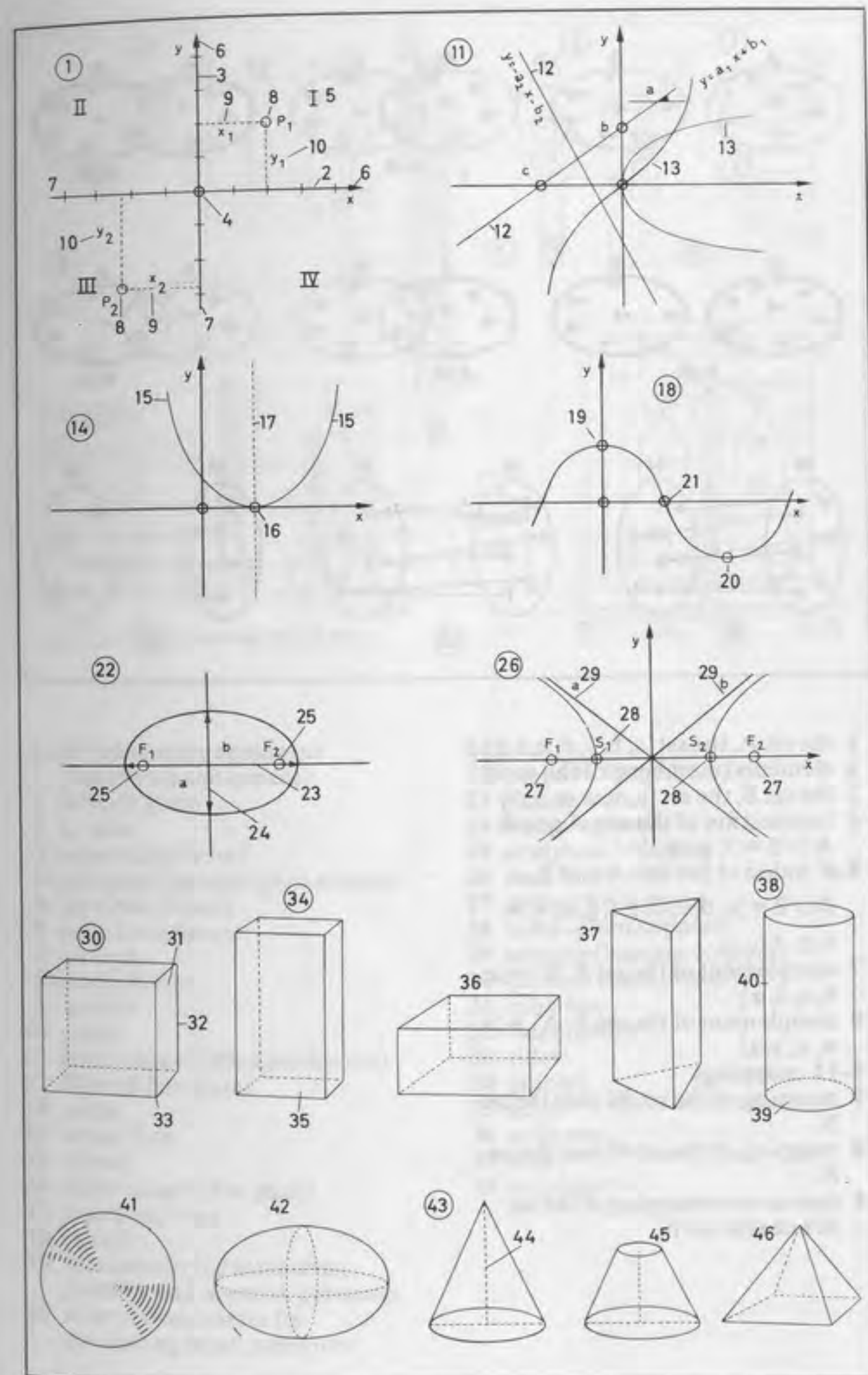



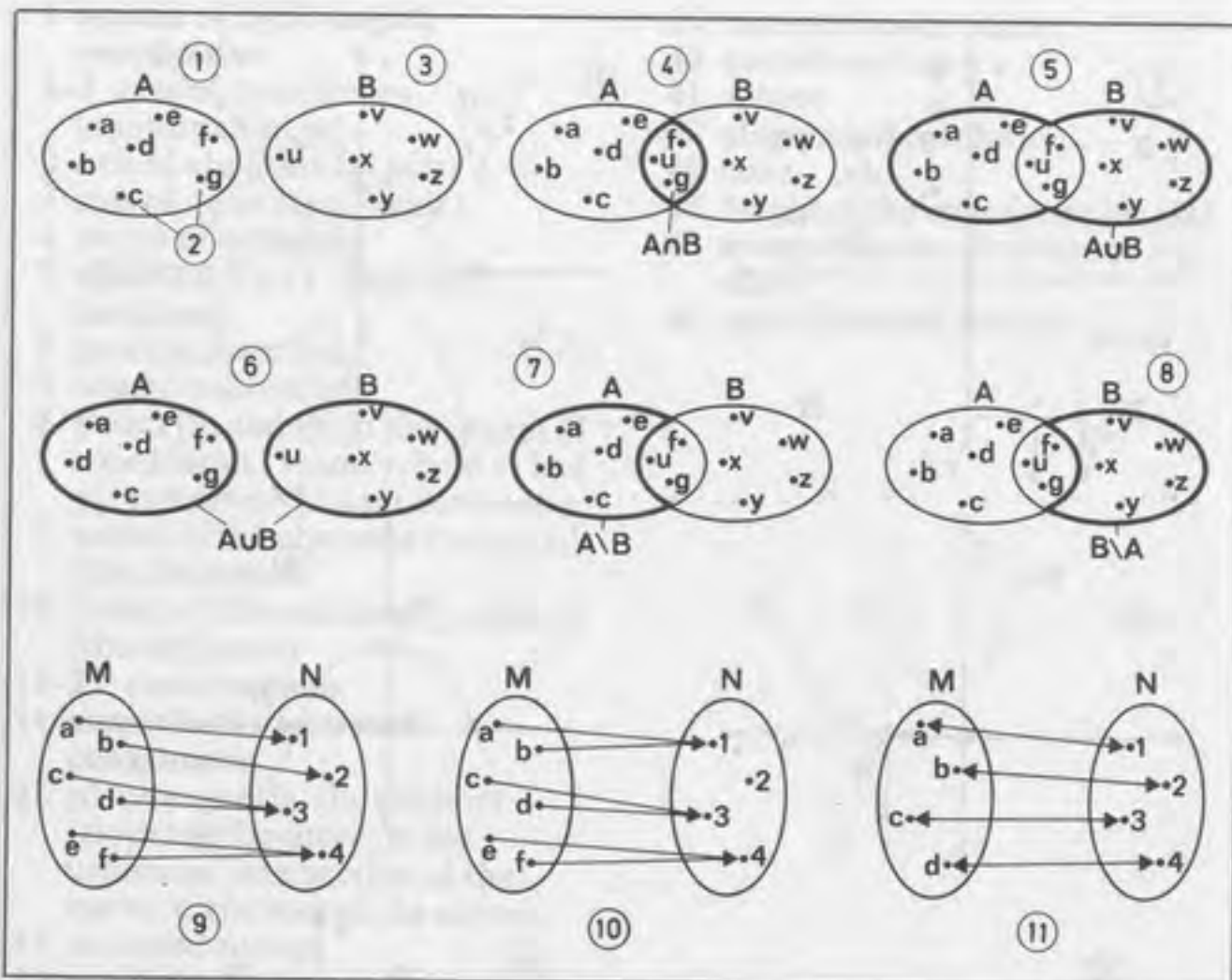

- 1 the set A, the set  $\{a, b, c, d, e, f, g\}$
- 2 elements (members) of the set A
- 3 the set B, the set  $\{u, v, w, x, y, z\}$
- 4 intersection of the sets A and B,  
 $A \cap B = \{f, g, u\}$
- 5-6 union of the sets A and B,  
 $A \cup B = \{a, b, c, d, e, f, g, u, v, w, x, y, z\}$
- 7 complement of the set B,  $B^c = \{a, b, c, d, e\}$
- 8 complement of the set A,  $A^c = \{v, w, x, y, z\}$
- 9-11 mappings
- 9 mapping of the set M onto the set N
- 10 mapping of the set M into the set N
- 11 one-to-one mapping of the set M onto the set N

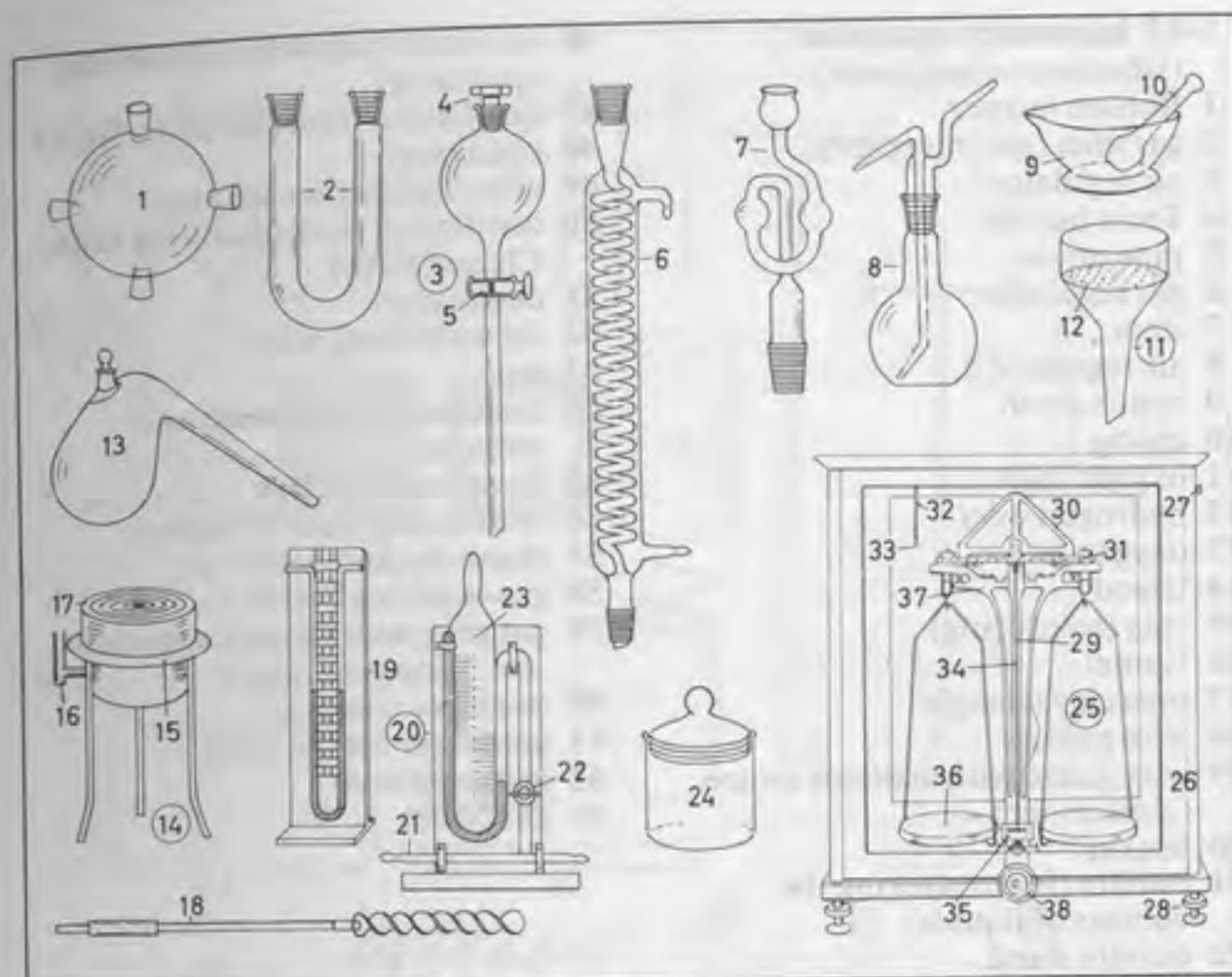

### 1-38 laboratory apparatus (laboratory equipment)

- 1 Scheidt globe
- 2 U-tube
- 3 separating funnel
- 4 octagonal ground-glass stopper
- 5 tap (Am. faucet)
- 6 coiled condenser
- 7 air lock
- 8 wash-bottle
- 9 mortar
- 10 pestle
- 11 filter funnel (Büchner funnel)
- 12 filter (filter plate)
- 13 retort
- 14 water bath
- 15 tripod
- 16 water gauge (Am. gage)
- 17 insertion rings
- 18 stirrer
- 19 manometer for measuring positive and negative pressures
- 20 mirror manometer for measuring small pressures
- 21 inlet
- 22 tap (Am. faucet)
- 23 sliding scale
- 24 weighing bottle
- 25 analytical balance
- 26 case
- 27 sliding front panel
- 28 three-point support
- 29 column (balance column)
- 30 balance beam (beam)
- 31 rider bar
- 32 rider holder
- 33 rider
- 34 pointer
- 35 scale
- 36 scale pan
- 37 stop
- 38 stop knob



1-63 laboratory apparatus  
(laboratory equipment)

- 1 Bunsen burner
- 2 gas inlet (gas inlet pipe)
- 3 air regulator
- 4 Teclu burner
- 5 pipe union
- 6 gas regulator
- 7 stem
- 8 air regulator
- 9 bench torch
- 10 casing
- 11 oxygen inlet
- 12 hydrogen inlet
- 13 oxygen jet
- 14 tripod
- 15 ring (retort ring)
- 16 funnel
- 17 pipe clay triangle
- 18 wire gauze
- 19 wire gauze with asbestos centre  
(*Am.* center)
- 20 beaker
- 21 burette (for measuring the  
volume of liquids)
- 22 burette stand
- 23 burette clamp
- 24 graduated pipette
- 25 pipette
- 26 measuring cylinder (measuring  
glass)
- 27 measuring flask
- 28 volumetric flask
- 29 evaporating dish (evaporating  
basin), made of porcelain
- 30 tube clamp (tube clip,  
pinchcock)
- 31 clay crucible with lid
- 32 crucible tongs
- 33 clamp
- 34 test tube
- 35 test tube rack
- 36 flat-bottomed flask
- 37 ground glass neck
- 38 long-necked round-bottomed  
flask
- 39 Erlenmeyer flask (conical flask)
- 40 filter flask
- 41 fluted filter
- 42 one-way tap
- 43 calcium chloride tube
- 44 stopper with tap
- 45 cylinder
- 46 distillation apparatus (distilling  
apparatus)
- 47 distillation flask (distilling flask)
- 48 condenser
- 49 return tap, a two-way tap
- 50 distillation flask (distilling flask,  
Claisen flask)
- 51 desiccator
- 52 lid with fitted tube
- 53 tap
- 54 desiccator insert made of  
porcelain
- 55 three-necked flask
- 56 connecting piece (Y-tube)
- 57 three-necked bottle
- 58 gas-washing bottle
- 59 gas generator (Kipp's apparatus,  
*Am.* Kipp generator)
- 60 overflow container
- 61 container for the solid
- 62 acid container
- 63 gas outlet

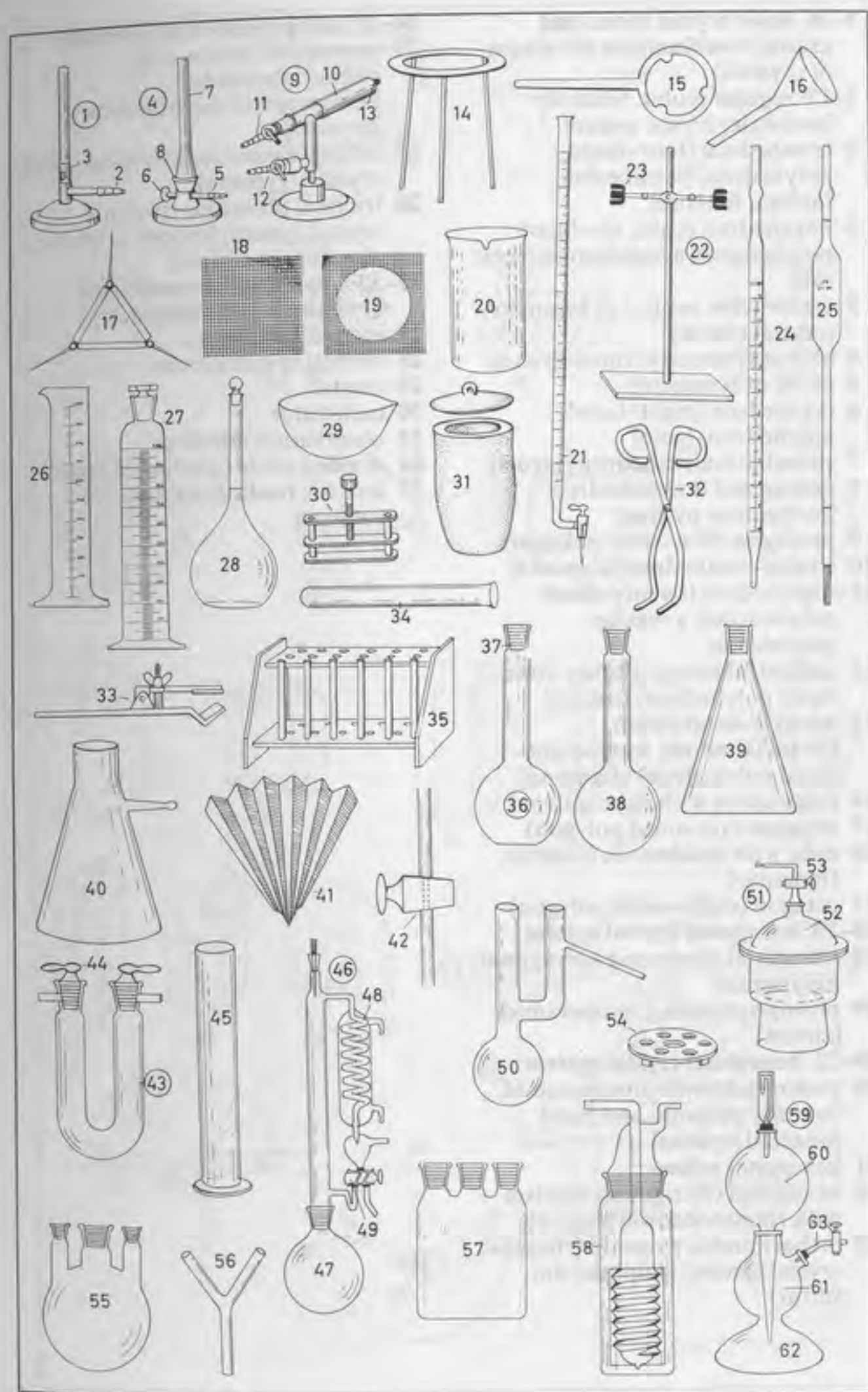



- 1-26 basic crystal forms and crystal combinations** (structure of crystals)
- 1-17 regular** (cubic, tesseral, isometric) crystal system
- 1 tetrahedron (four-faced polyhedron) [tetrahedrite, fahlerz, fahl ore]
- 2 hexahedron (cube, six-faced polyhedron), a holohedron [rock salt]
- 3 centre (*Am.* center) of symmetry (crystal centre)
- 4 axis of symmetry (rotation axis)
- 5 plane of symmetry
- 6 octahedron (eight-faced polyhedron) [gold]
- 7 rhombic dodecahedron [garnet]
- 8 pentagonal dodecahedron [pyrite, iron pyrites]
- 9 pentagon (five-sided polygon)
- 10 triakis-octahedron [diamond]
- 11 icosahedron (twenty-faced polyhedron), a regular polyhedron
- 12 icositetrahedron (twenty-four-faced polyhedron) [leucite]
- 13 hexakis-octahedron (hexoctahedron, forty-eight-faced polyhedron) [diamond]
- 14 octahedron with cube [galena]
- 15 hexagon (six-sided polygon)
- 16 cube with octahedron [fluorite, fluorspar]
- 17 octagon (eight-sided polygon)
- 18-19 tetragonal crystal system**
- 18 tetragonal dipyramid (tetragonal bipyramid)
- 19 protoprism with protopyramid [zircon]
- 20-22 hexagonal crystal system**
- 20 protoprism with protopyramid, deutero-pyramid and basal pinacoid [apatite]
- 21 hexagonal prism
- 22 hexagonal (ditrigonal) biprism with rhombohedron [calcite]
- 23 orthorhombic pyramid (rhombic crystal system) [sulphur, *Am.* sulfur]

- 24-25 monoclinic crystal system**
- 24 monoclinic prism with clinopinacoid and hemipyramid (hemihedron) [gypsum]
- 25 orthopinacoid (swallow-tail twin crystal) [gypsum]
- 26 triclinic pinacoids (triclinic crystal system) [copper sulphate, *Am.* copper sulfate]
- 27-33 apparatus for measuring crystals** (for crystallography)
- 27 contact goniometer
- 28 reflecting goniometer
- 29 crystal
- 30 collimator
- 31 observation telescope
- 32 divided circle (graduated circle)
- 33 lens for reading the angle of rotation

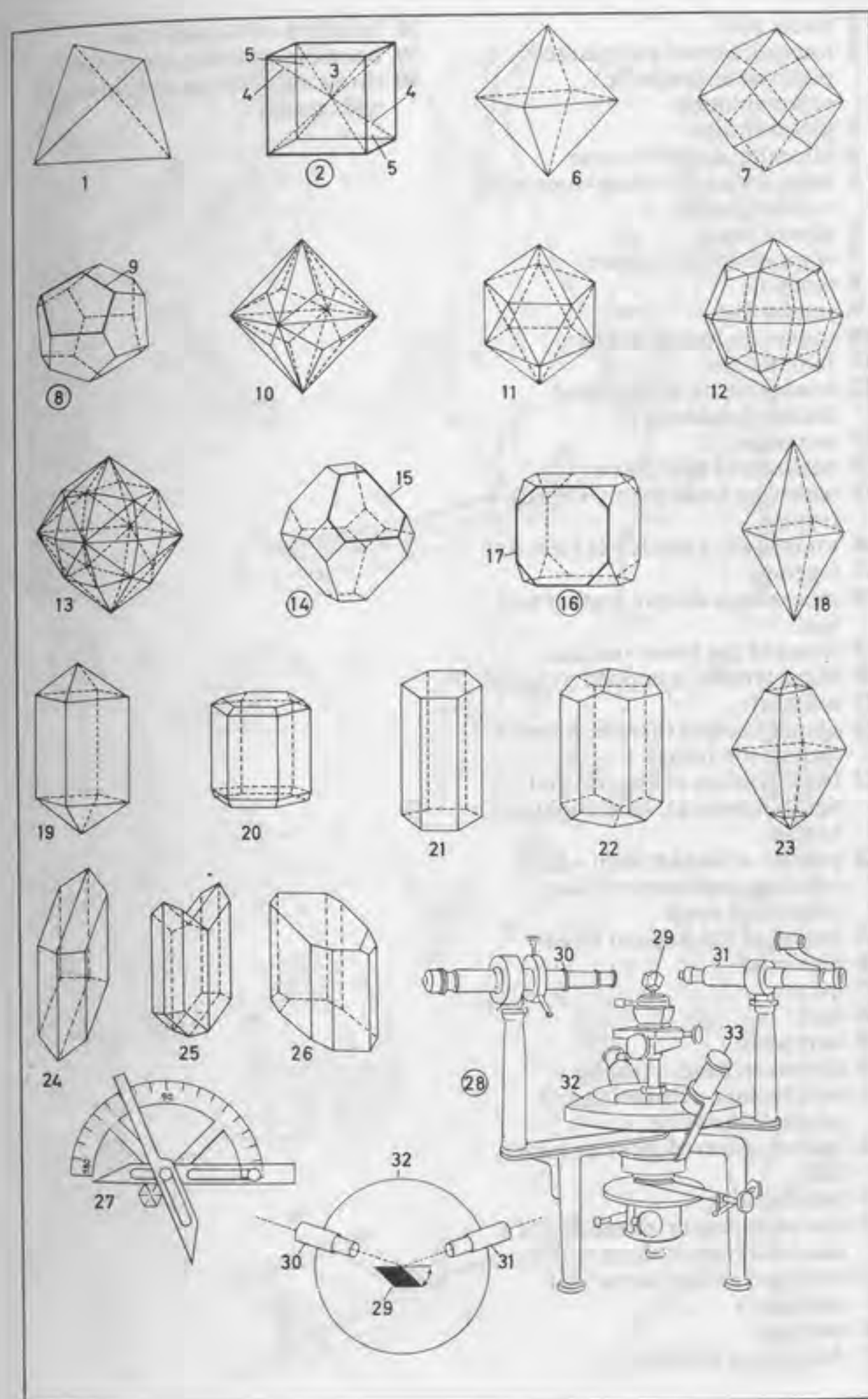



- 1 totem pole
- 2 totem, a carved and painted pictorial or symbolic representation
- 3 plains Indian
- 4 mustang, a prairie horse
- 5 lasso, a long throwing-rope with running noose
- 6 pipe of peace
- 7 wigwam (tepee, teepee)
- 8 tent pole
- 9 smoke flap
- 10 squaw, an Indian woman
- 11 Indian chief
- 12 headdress, an ornamental feather headdress
- 13 war paint
- 14 necklace of bear claws
- 15 scalp (cut from enemy's head), a trophy
- 16 tomahawk, a battle axe (*Am. ax*)
- 17 leggings
- 18 moccasin, a shoe of leather and bast
- 19 canoe of the forest Indians
- 20 Maya temple, a stepped pyramid
- 21 mummy
- 22 quipa (knotted threads, knotted code of the Incas)
- 23 Indio (Indian of Central and South America); *here*: highland Indian
- 24 poncho, a blanket with a head opening used as an armless cloak-like wrap
- 25 Indian of the tropical forest
- 26 blowpipe
- 27 quiver
- 28 dart
- 29 dart point
- 30 shrunken head, a trophy
- 31 bola (bolas), a throwing and entangling device
- 32 leather-covered stone or metal ball
- 33 pile dwelling
- 34 duk-duk dancer, a member of a duk-duk (men's secret society)
- 35 outrigger canoe (canoe with outrigger)
- 36 outrigger
- 37 Australian aborigine

- 38 loincloth of human hair
- 39 boomerang, a wooden missile
- 40 throwing stick (spear thrower) with spears

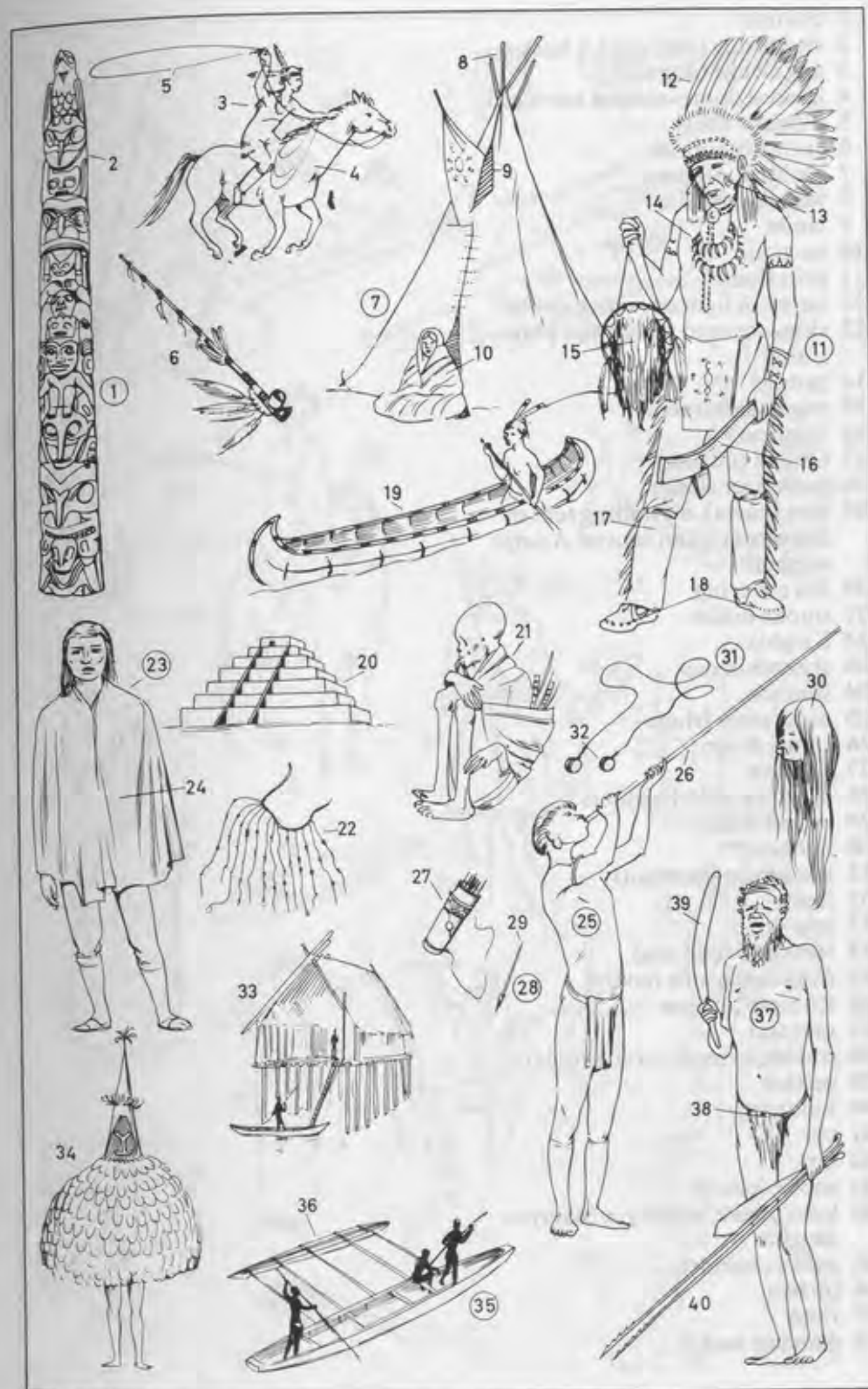



- 1 Eskimo
- 2 sledge dog (sled dog), a husky
- 3 dog sledge (dog sled)
- 4 igloo, a dome-shaped snow hut
- 5 block of snow
- 6 entrance tunnel
- 7 blubber-oil lamp
- 8 wooden missile
- 9 lance
- 10 harpoon
- 11 skin float
- 12 kayak, a light one-man canoe
- 13 skin-covered wooden or bone frame
- 14 paddle
- 15 reindeer harness
- 16 reindeer
- 17 Ostyak (Ostiak)
- 18 passenger sledge
- 19 yurt (yurta), a dwelling tent of the western and central Asiatic nomads
- 20 felt covering
- 21 smoke outlet
- 22 Kirghiz
- 23 sheepskin cap
- 24 shaman
- 25 decorative fringe
- 26 frame drum
- 27 Tibetan
- 28 flintlock with bayonets
- 29 prayer wheel
- 30 felt boot
- 31 houseboat (sampan)
- 32 junk
- 33 mat sail
- 34 rickshaw (ricksha)
- 35 rickshaw coolie (cooly)
- 36 Chinese lantern
- 37 samurai
- 38 padded armour (*Am. armor*)
- 39 geisha
- 40 kimono
- 41 obi
- 42 fan
- 43 coolie (cooly)
- 44 kris (creese, crease), a Malayan dagger
- 45 snake charmer
- 46 turban
- 47 flute
- 48 dancing snake





- 1 camel caravan
- 2 riding animal
- 3 pack animal
- 4 oasis
- 5 grove of palm trees
- 6 bedouin (beduin)
- 7 burnous
- 8 Masai warrior
- 9 headdress (hairdress)
- 10 shield
- 11 painted ox hide
- 12 long-bladed spear
- 13 negro
- 14 dance drum
- 15 throwing knife
- 16 wooden mask
- 17 figure of an ancestor
- 18 slit gong
- 19 drumstick
- 20 dugout, a boat hollowed out of a tree trunk
- 21 negro hut
- 22 negress
- 23 lip plug (labret)
- 24 grinding stone
- 25 Herero woman
- 26 leather cap
- 27 calabash (gourd)
- 28 beehive-shaped hut
- 29 bushman
- 30 earplug
- 31 loincloth
- 32 bow
- 33 knobkerry (knobkerrie), a club with round, knobbed end
- 34 bushman woman making a fire by twirling a stick
- 35 windbreak
- 36 Zulu in dance costume
- 37 dancing stick
- 38 bangle
- 39 ivory war horn
- 40 string of amulets and bones
- 41 pigmy
- 42 magic pipe for exorcising evil spirits
- 43 fetish





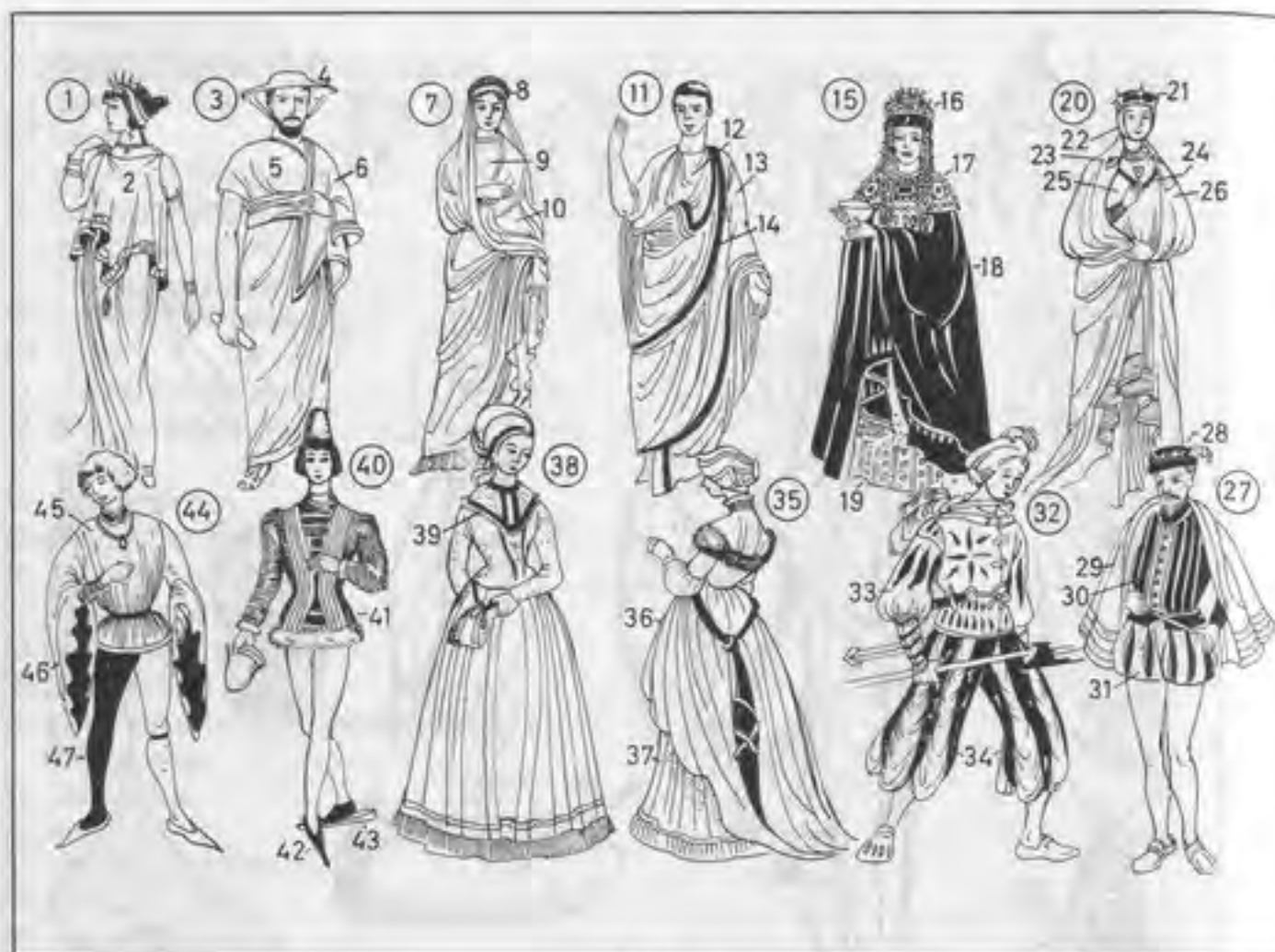

- 1 Greek woman
- 2 peplos
- 3 Greek
- 4 petasus (Thessalonian hat)
- 5 chiton, a linen gown worn as a basic garment
- 6 himation, woollen (*Am.* woolen) cloak
- 7 Roman woman
- 8 toupee wig (partial wig)
- 9 stola
- 10 palla, a coloured (*Am.* colored) wrap
- 11 Roman
- 12 tunica (tunic)
- 13 toga
- 14 purple border (purple band)
- 15 Byzantine empress
- 16 pearl diadem
- 17 jewels
- 18 purple cloak
- 19 long tunic
- 20 German princess [13th cent.]
- 21 crown (diadem)
- 22 chinband
- 23 tassel
- 24 cloak cord
- 25 girt-up gown (girt-up surcoat, girt-up tunic)
- 26 cloak
- 27 German dressed in the Spanish style [ca. 1575]
- 28 wide-brimmed cap
- 29 short cloak (Spanish cloak, short cape)
- 30 padded doublet (stuffed doublet, peasecod)
- 31 stuffed trunk-hose
- 32 lansquenet (German mercenary soldier) [ca. 1530]
- 33 slashed doublet (paned doublet)
- 34 Pluderhose (loose breeches, paned trunk-hose, slops)
- 35 woman of Basle [ca. 1525]
- 36 overgown (gown)
- 37 undergown (petticoat)
- 38 woman of Nuremberg [ca. 1500]
- 39 shoulder cape
- 40 Burgundian [15th cent.]
- 41 short doublet
- 42 piked shoes (peaked shoes, copped shoes, crackowes, poulaines)
- 43 pattens (clogs)



- 44 young nobleman [ca. 1400]
- 45 short, padded doublet (short, quilted doublet, jerkin)
- 46 dagged sleeves (petal-scalloped sleeves)
- 47 hose
- 48 Augsburg patrician lady [ca. 1575]
- 49 puffed sleeve
- 50 overgown (gown, open gown, sleeveless gown)
- 51 French lady [ca. 1600]
- 52 millstone ruff (cartwheel ruff, ruff)
- 53 corseted waist (wasp waist)
- 54 gentleman [ca. 1650]
- 55 wide-brimmed felt hat (cavalier hat)
- 56 falling collar (wide-falling collar) of linen
- 57 white lining
- 58 jack boots (bucket-top boots)
- 59 lady [ca. 1650]
- 60 full puffed sleeves (puffed sleeves)
- 61 gentleman [ca. 1700]
- 62 three-cornered hat
- 63 dress sword
- 64 lady [ca. 1700]
- 65 lace fontange (high headdress of lace)
- 66 lace-trimmed loose-hanging gown (loose-fitting housecoat, robe de chambre, negligée, contouche)
- 67 band of embroidery
- 68 lady [ca. 1880]
- 69 bustle
- 70 lady [ca. 1858]
- 71 poke bonnet
- 72 crinoline
- 73 gentleman of the Biedermeier period
- 74 high collar (choker collar)
- 75 embroidered waistcoat (vest)
- 76 frock coat
- 77 pigtail wig
- 78 ribbon (bow)
- 79 ladies in court dress [ca. 1780]
- 80 train
- 81 upswept Rococo coiffure
- 82 hair decoration
- 83 panniered overskirt



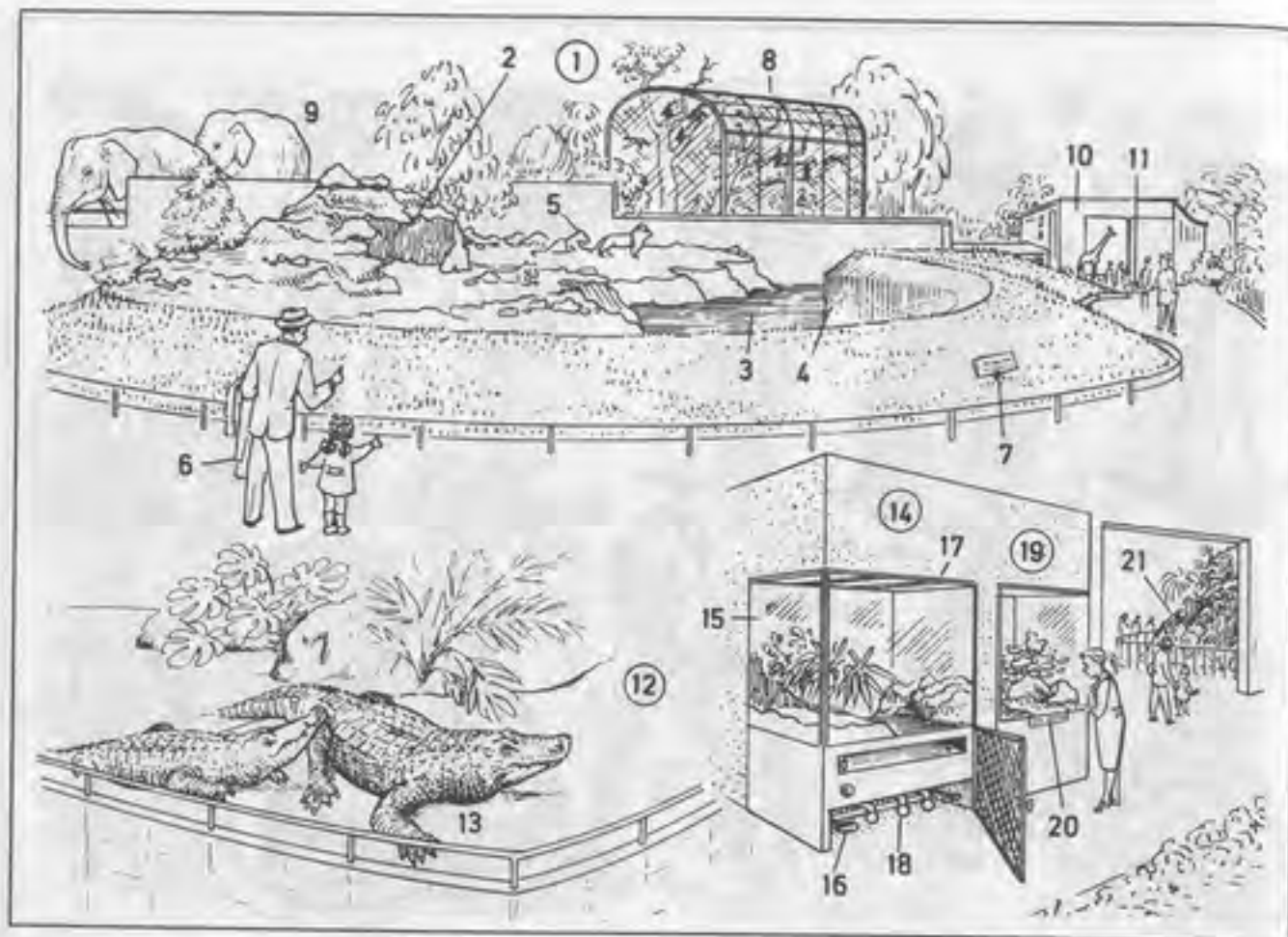

- 1 outdoor enclosure (enclosure)
- 2 rocks
- 3 moat
- 4 enclosing wall
- 5 animals on show; here: a pride of lions
- 6 visitor to the zoo
- 7 notice
- 8 aviary
- 9 elephant enclosure
- 10 animal house (e.g. carnivore house, giraffe house, elephant house, monkey house)
- 11 outside cage, animals' summer quarters
- 12 reptile enclosure
- 13 Nile crocodile
- 14 terrarium and aquarium
- 15 glass case
- 16 fresh-air inlet
- 17 ventilator
- 18 underfloor heating
- 19 aquarium
- 20 information plate
- 21 flora in artificially maintained climate

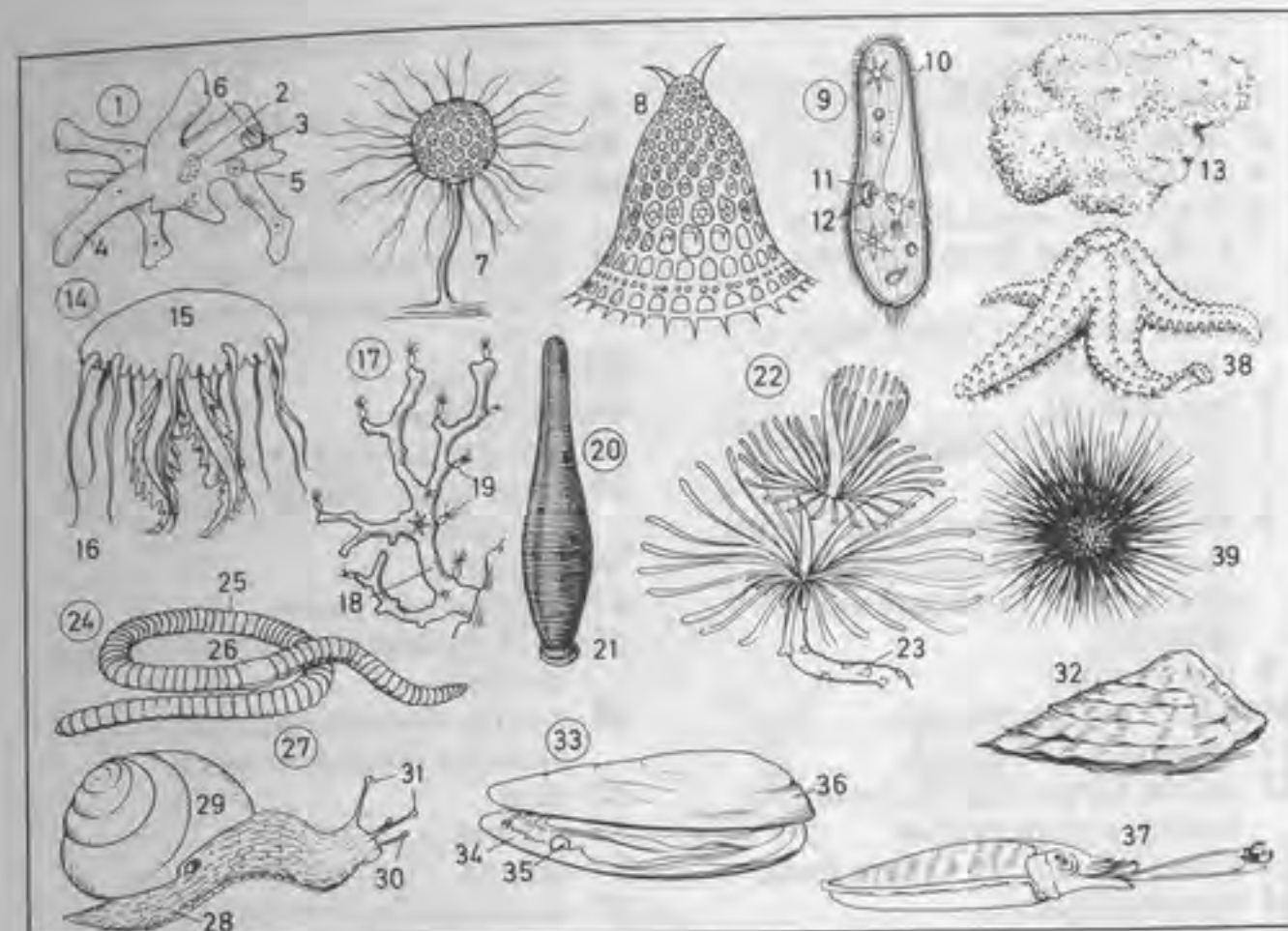

- 1-12 unicellular (one-celled, single-celled) animals (protozoans)
- 1 amoeba, a rhizopod
- 2 cell nucleus
- 3 protoplasm
- 4 pseudopod
- 5 excretory vacuole (contractile vacuole, an organelle)
- 6 food vacuole
- 7 Actinophrys, a heliozoan
- 8 radiolarian; here: siliceous skeleton
- 9 slipper animalcule, a Paramecium
- 10 cilium
- 11 macronucleus (meganucleus)
- 12 micronucleus
- 13-39 multicellular animals (metazoans)
- 13 bath sponge, a porifer (sponge)
- 14 medusa, a discomedusa (jellyfish), a coelenterate
- 15 umbrella
- 16 tentacle
- 17 red coral (precious coral), a coral animal (anthozoan, reef-building animal)
- 18 coral colony
- 19 coral polyp
- 20-26 worms (Vermes)
- 20 leech, an annelid
- 21 sucker
- 22 Spirographis, a bristle worm
- 23 tube
- 24 earthworm
- 25 segment
- 26 clitellum [accessory reproductive organ]
- 27-36 molluscs (*Am.* mollusks)
- 27 edible snail, a snail
- 28 creeping foot
- 29 shell (snail shell)
- 30 stalked eye
- 31 tentacle (horn, feeler)
- 32 oyster
- 33 freshwater pearl mussel
- 34 mother-of-pearl (nacre)
- 35 pearl
- 36 mussel shell
- 37 cuttlefish, a cephalopod
- 38-39 echinoderms
- 38 starfish (sea star)
- 39 sea urchin (sea hedgehog)



- 1-23 arthropods  
 1-2 crustaceans  
 1 mitten crab, a crab  
 2 water slater  
 3-23 insects  
 3 dragonfly (water nymph), a homopteran (homopterous insect)  
 4 water scorpion (water bug), a rhynchophore  
 5 raptorial leg  
 6 mayfly (dayfly, ephemeropterid)  
 7 compound eye  
 8 green grasshopper (green locust, meadow grasshopper), an orthopteron (orthopterous insect)  
 9 larva (grub)  
 10 adult insect, an imago  
 11 leaping hind leg  
 12 caddis fly (spring fly, water moth), a neuropteran  
 13 aphid (greenfly), a plant louse  
 14 wingless aphid  
 15 winged aphid  
 16-20 dipterous insects (dipterans)  
 16 gnat (mosquito, midge), a culicid  
 17 proboscis (sucking organ)  
 18 bluebottle (blowfly), a fly  
 19 maggot (larva)  
 20 chrysalis (pupa)  
 21-23 Hymenoptera  
 21-22 ant  
 21 winged female  
 22 worker  
 23 bumblebee (humblebee)  
 24-39 beetles (Coleoptera)  
 24 stag beetle, a lamellicorn beetle  
 25 mandibles  
 26 trophi  
 27 antenna (feeler)  
 28 head  
 29-30 thorax  
 29 thoracic shield (prothorax)  
 30 scutellum  
 31 tergites  
 32 stigma  
 33 wing (hind wing)  
 34 nervure  
 35 point at which the wing folds  
 36 elytron (forewing)  
 37 ladybird (ladybug), a coccinellid

- 38 Ergates faber, a longicorn beetle (longicorn)  
 39 dung beetle, a lamellicorn beetle  
 40-47 arachnids  
 40 Euscorpis flavicandus, a scorpion  
 41 cheliped with chelicer  
 42 maxillary antenna (maxillary feeler)  
 43 tail sting  
 44-46 spiders  
 44 wood tick (dog tick), a tick  
 45 cross spider (garden spider), an orb spinner  
 46 spinneret  
 47 spider's web (web)  
 48-56 Lepidoptera (butterflies and moths)  
 48 mulberry-feeding moth (silk moth), a bombycid moth  
 49 eggs  
 50 silkworm  
 51 cocoon  
 52 swallowtail, a butterfly  
 53 antenna (feeler)  
 54 eyespot  
 55 privet hawkmoth, a hawkmoth (sphinx)  
 56 proboscis

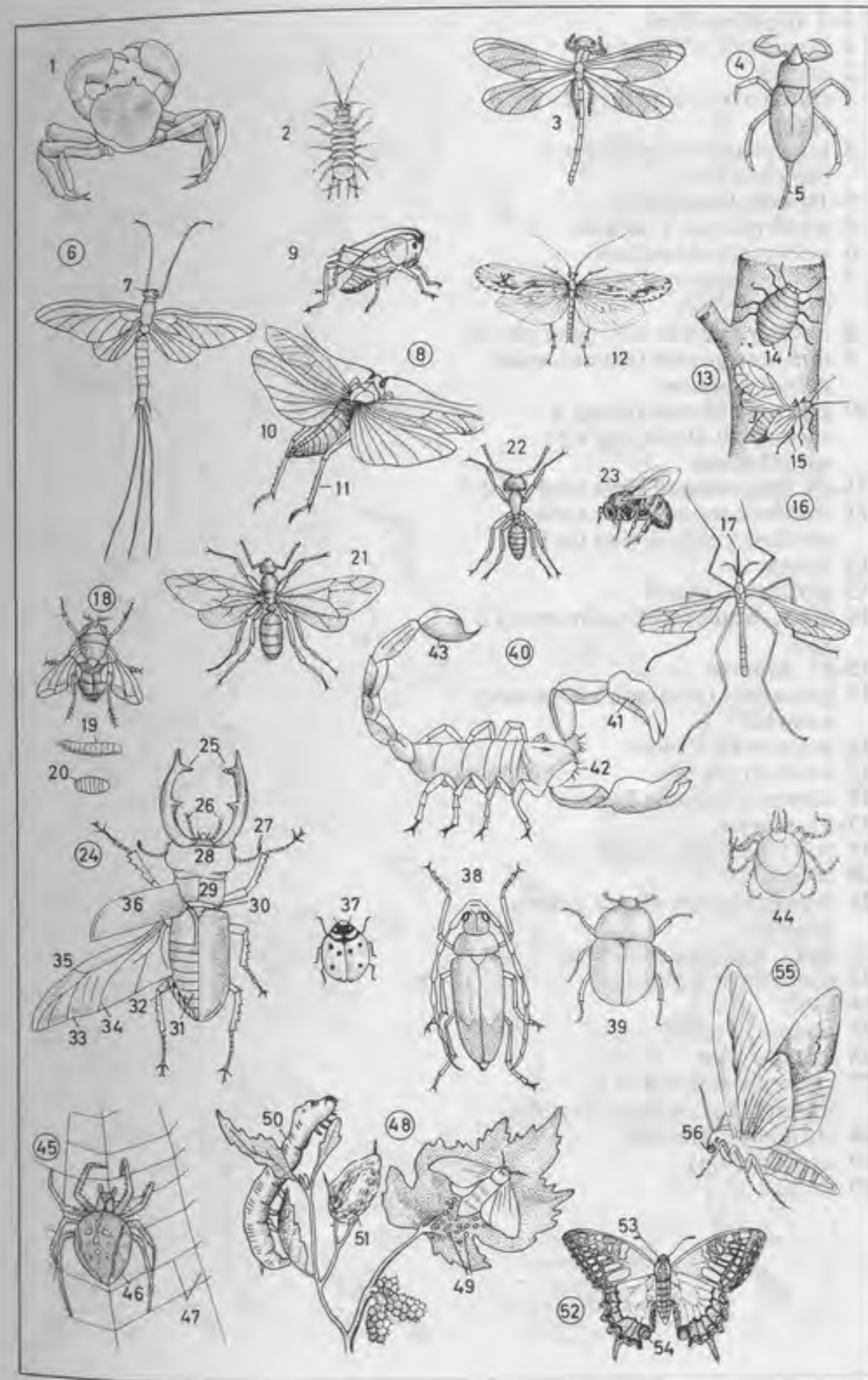



- 1-3 **flightless birds**  
 1 cassowary; *sim.*: emu  
 2 ostrich  
 3 clutch of ostrich eggs [12 - 14 eggs]  
 4 king penguin, a penguin, a flightless bird  
 5-10 **web-footed birds**  
 5 white pelican, a pelican  
 6 webfoot (webbed foot)  
 7 web (palmations) of webbed foot (palmate foot)  
 8 lower mandible with gular pouch  
 9 northern gannet (gannet, solan goose), a gannet  
 10 green cormorant (shag), a cormorant displaying with spread wings  
 11-14 **long-winged birds** (seabirds)  
 11 common sea swallow, a sea swallow (tern); diving for food  
 12 fulmar  
 13 guillemot, an auk  
 14 black-headed gull (mire crow), a gull  
 15-17 **Anseres**  
 15 goosander (common merganser), a sawbill  
 16 mute swan, a swan  
 17 knob on the bill  
 18 common heron, a heron  
 19-21 **plovers**  
 19 stilt (stilt bird, stilt plover)  
 20 coot, a rail  
 21 lapwing (green plover, peewit, pewit)  
 22 quail, a gallinaceous bird  
 23 turtle dove, a pigeon  
 24 swift  
 25 hoopoe, a roller  
 26 erectile crest  
 27 spotted woodpecker, a woodpecker; *related*: wryneck  
 28 entrance to the nest  
 29 nesting cavity  
 30 cuckoo





- 1, 3, 4, 5, 7, 9, 10 songbirds  
 1 goldfinch, a finch  
 2 bee eater  
 3 redstart (star finch), a thrush  
 4 bluetit, a tit (titmouse), a resident bird (non-migratory bird)  
 5 bullfinch  
 6 common roller (roller)  
 7 golden oriole, a migratory bird  
 8 kingfisher  
 9 white wagtail, a wagtail  
 10 chaffinch



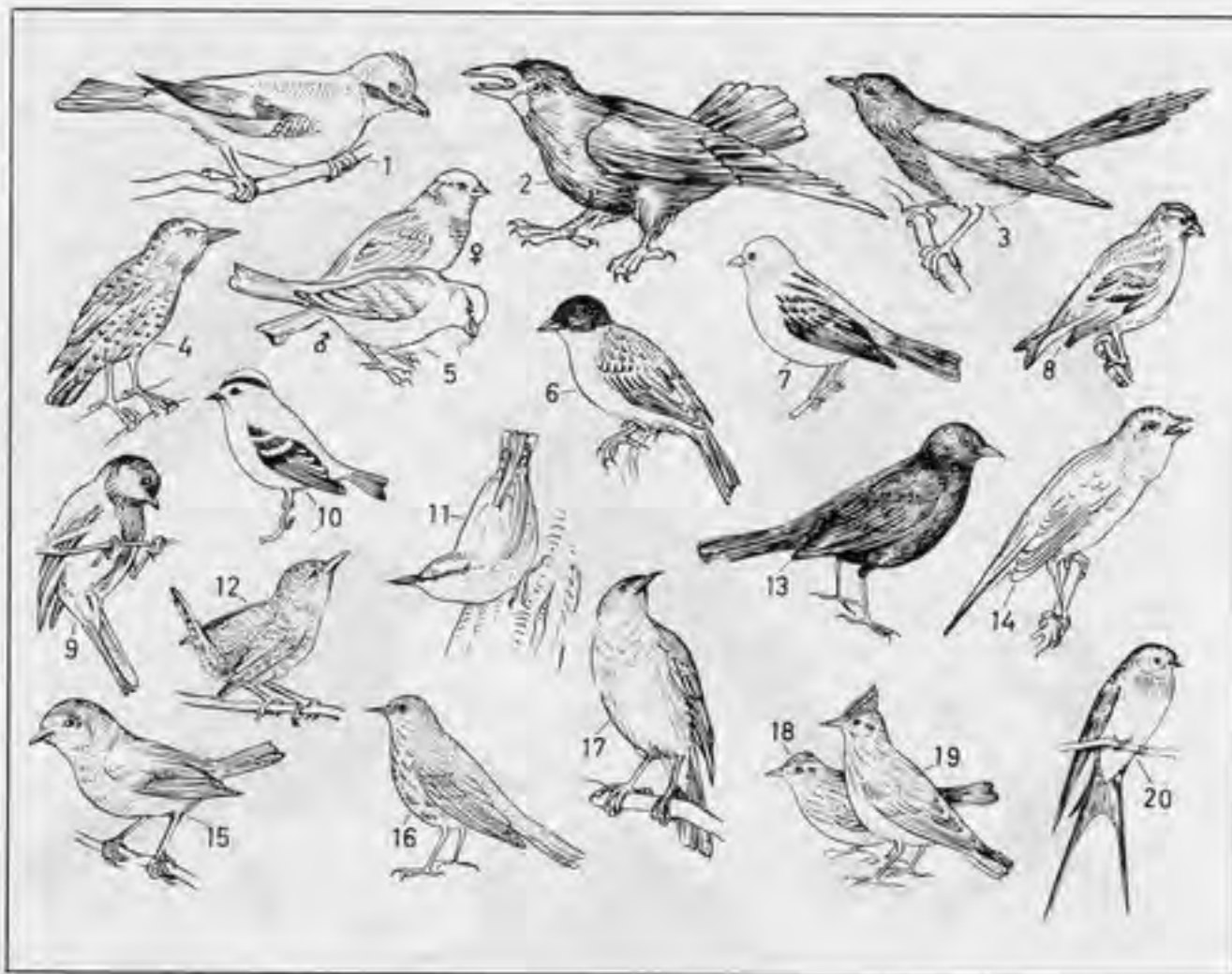

**1-20 songbirds**

**1-3 Corvidae** (corvine birds, crows)

1 jay (nutcracker)

2 rook, a crow

3 magpie

4 starling (pastor, shepherd bird)

5 house sparrow

**6-8 finches**

6-7 buntings

6 yellowhammer (yellow bunting)

7 ortolan (ortolan bunting)

8 siskin (aberdevine)

9 great titmouse (great tit, ox eye), a titmouse (tit)

10 golden-crested wren (goldcrest); *sim.*: firecrest, one of the Regulidae

11 nuthatch

12 wren

**13-17 thrushes**

13 blackbird

14 nightingale (*poet.*: philomel, philomela)

15 robin (redbreast, robin redbreast)

16 song thrush (throstle, mavis)

17 thrush nightingale

**18-19 larks**

18 woodlark

19 crested lark (tufted lark)

20 common swallow (barn swallow, chimney swallow), a swallow

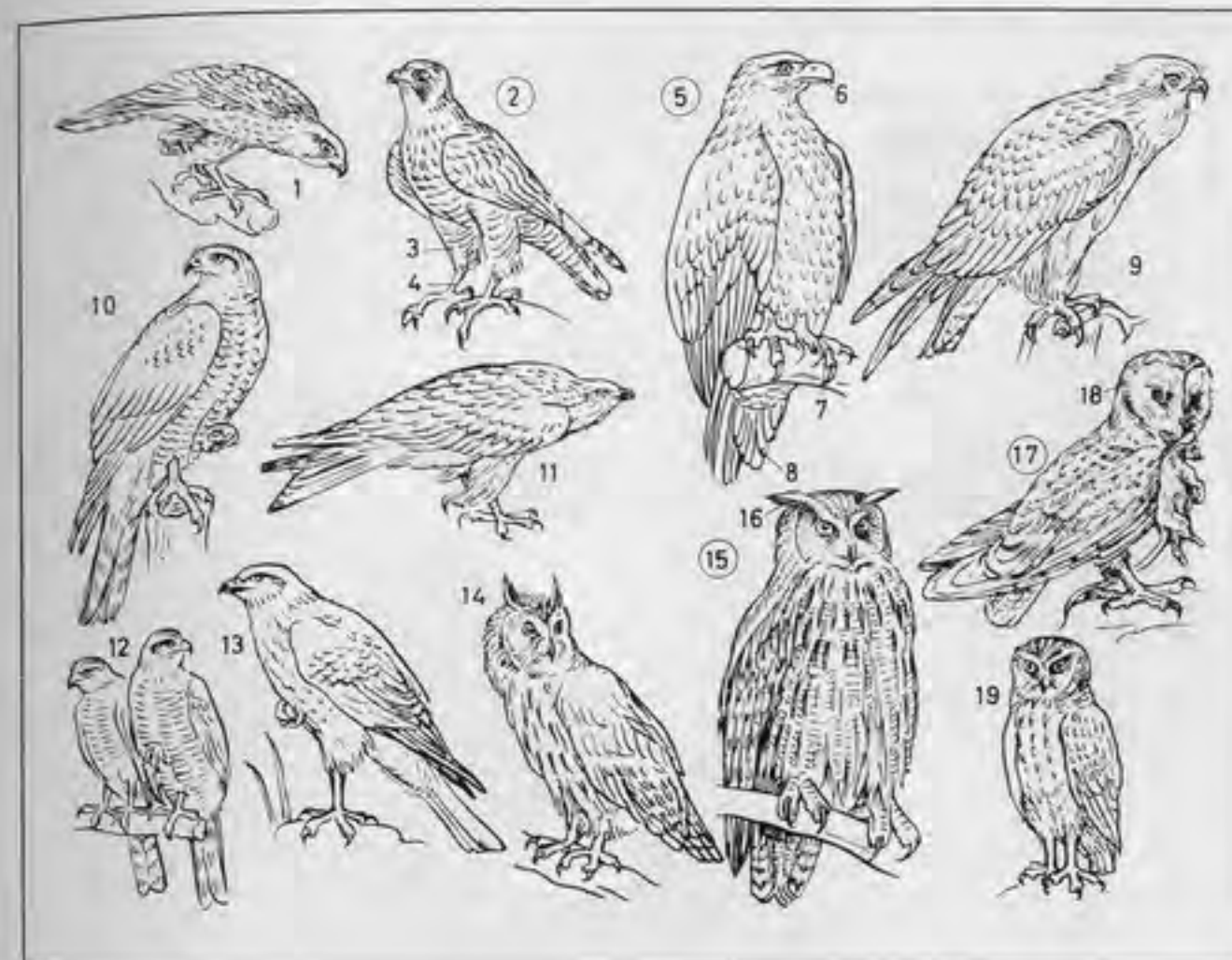
**1-13 diurnal birds of prey**

**1-4 falcons**

1 merlin

2 peregrine falcon

3 leg feathers

4 tarsus

**5-9 eagles**

5 white-tailed sea eagle (white-tailed eagle, grey sea eagle, erne)

6 hooked beak

7 claw (talon)

8 tail

9 common buzzard

**10-13 accipiters**

10 goshawk

11 common European kite (glede, kite)

12 sparrow hawk (spar-hawk)

13 marsh harrier (moor buzzard, moor harrier, moor hawk)

**14-19 owls** (nocturnal birds of prey)

14 long-eared owl (horned owl)

15 eagle-owl (great horned owl)

16 plumicorn (feathered ear, ear tuft, ear, horn)

17 barn owl (white owl, silver owl, yellow owl, church owl, screech owl)

18 facial disc (disk)

19 little owl (sparrow owl)



- 1 sulphur-crested cockatoo, a parrot
- 2 blue-and-yellow macaw
- 3 blue bird of paradise
- 4 sappho
- 5 cardinal (cardinal bird)
- 6 toucan (red-billed toucan), one of the Piciformes



*[Faint, illegible text, likely bleed-through from the reverse side of the page.]*





- 1-18 fishes**  
 1 man-eater (blue shark, requin), a shark  
 2 nose (snout)  
 3 gill slit (gill cleft)  
 4 mirror carp, a carp  
 5 gill cover (operculum)  
 6 dorsal fin  
 7 pectoral fin  
 8 pelvic fin (abdominal fin, ventral fin)  
 9 anal fin  
 10 caudal fin (tail fin)  
 11 scale  
 12 catfish (sheatfish, sheathfish, wels)  
 13 barbel  
 14 herring  
 15 brown trout, a trout  
 16 pike (northern pike)  
 17 freshwater eel (eel)  
 18 sea horse (Hippocampus, horsefish)  
 19 tufted gills  
**20-26 Amphibia (amphibians)**  
 20-22 salamanders  
 20 greater water newt (crested newt), a water newt  
 21 dorsal crest  
 22 fire salamander, a salamander  
**23-26 salientians (anurans, batrachians)**  
 23 European toad, a toad  
 24 tree frog (tree toad)  
 25 vocal sac (vocal pouch, croaking sac)  
 26 adhesive disc (disk)  
**27-41 reptiles**  
**27, 30-37 lizards**  
 27 sand lizard  
 28 hawksbill turtle (hawksbill)  
 29 carapace (shell)  
 30 basilisk  
 31 desert monitor, a monitor lizard (monitor)  
 32 common iguana, an iguana  
 33 chameleon, one of the Chamaeleontidae (Rhiptoglossa)  
 34 prehensile foot  
 35 prehensile tail  
 36 wall gecko, a gecko  
 37 slowworm (blindworm), one of the Anguidae

- 38-41 snakes**  
 38 ringed snake (ring snake, water snake, grass snake), a colubrid  
 39 collar  
**40-41 vipers (adders)**  
 40 common viper, a poisonous (venomous) snake  
 41 asp (asp viper)

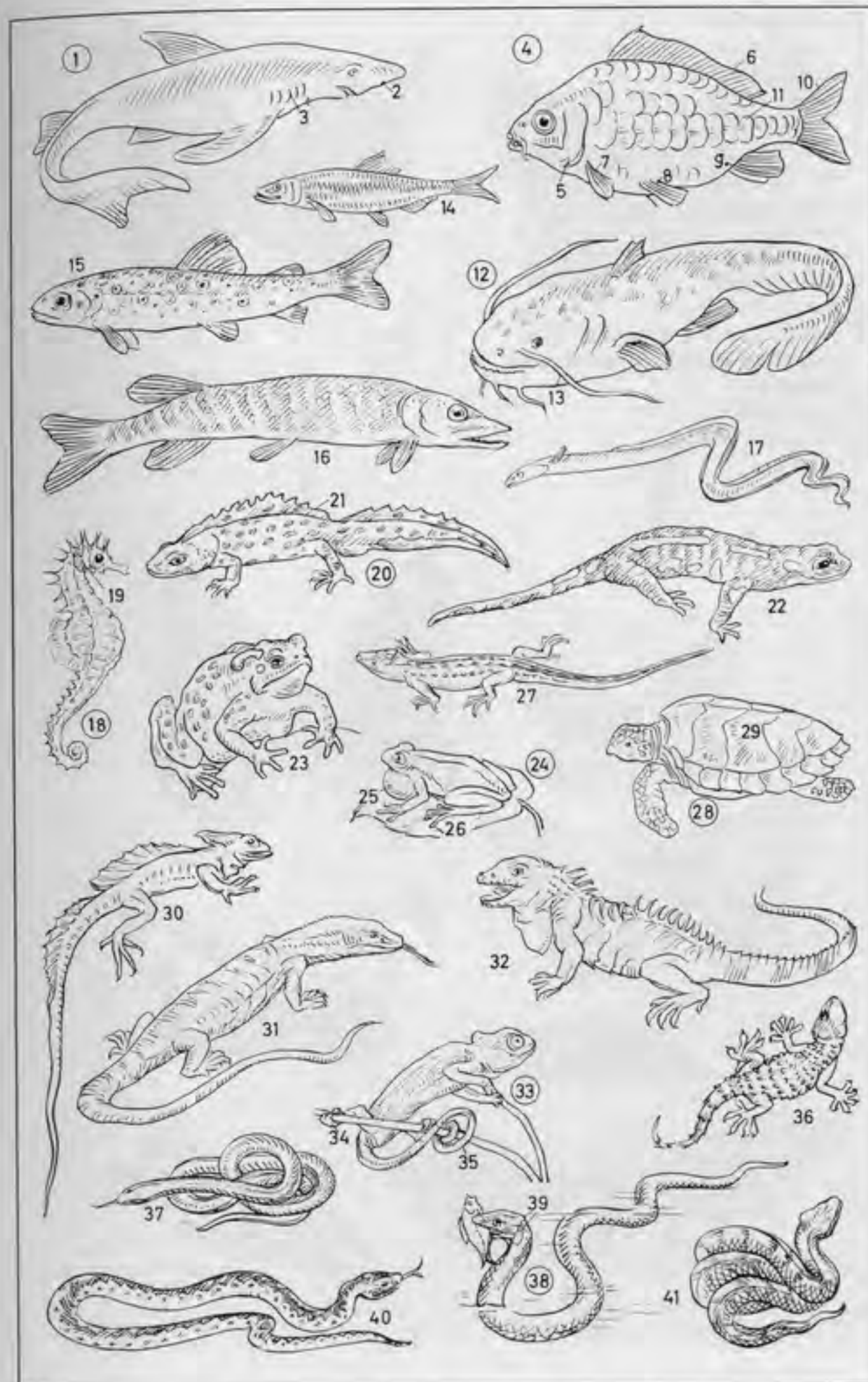



1-6 butterflies

- 1 red admiral
  - 2 peacock butterfly
  - 3 orange tip (orange tip butterfly)
  - 4 brimstone (brimstone butterfly)
  - 5 Camberwell beauty (mourning cloak, mourning cloak butterfly)
  - 6 blue (lycaenid butterfly, lycaenid)
- 7-11 moths (Heterocera)
- 7 garden tiger
  - 8 red underwing
  - 9 death's-head moth (death's-head hawkmoth), a hawkmoth (sphinx)
  - 10 caterpillar
  - 11 chrysalis (pupa)

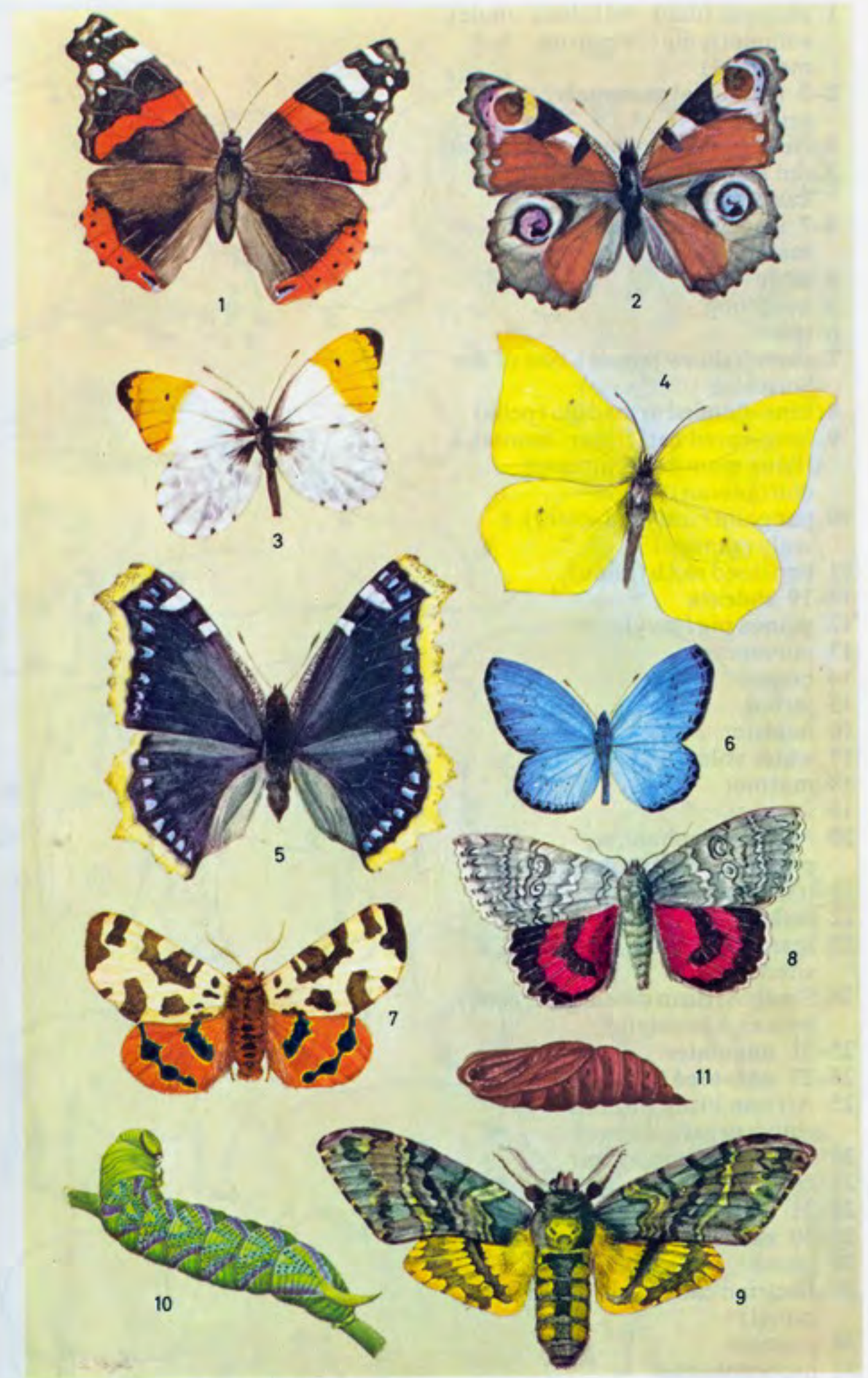



- 1 platypus (duck-bill, duck-mole), a monotreme (oviparous mammal)
- 2-3 marsupial mammals (marsupials)
- 2 New World opossum, a didelphid
- 3 red kangaroo (red flyer), a kangaroo
- 4-7 insectivores (insect-eating mammals)
- 4 mole
- 5 hedgehog
- 6 spine
- 7 shrew (shrew mouse), one of the Soricidae
- 8 nine-banded armadillo (peba)
- 9 long-eared bat (flutter-mouse), a flying mammal (chiropter, chiropteran)
- 10 pangolin (scaly ant-eater), a scaly mammal
- 11 two-toed sloth (unau)
- 12-19 rodents
- 12 guinea pig (cavy)
- 13 porcupine
- 14 beaver
- 15 jerboa
- 16 hamster
- 17 water vole
- 18 marmot
- 19 squirrel
- 20 African elephant, a proboscidean (proboscidian)
- 21 trunk (proboscis)
- 22 tusk
- 23 manatee (manati, lamantin), a sirenian
- 24 South African dassie (das, coney, hyrax), a procaviid
- 25-31 ungulates
- 25-27 odd-toed ungulates
- 25 African black rhino, a rhinoceros (nasicorn)
- 26 Brazilian tapir, a tapir
- 27 zebra
- 28-31 even-toed ungulates
- 28-30 ruminants
- 28 llama
- 29 Bactrian camel (two-humped camel)
- 30 guanaco
- 31 hippopotamus

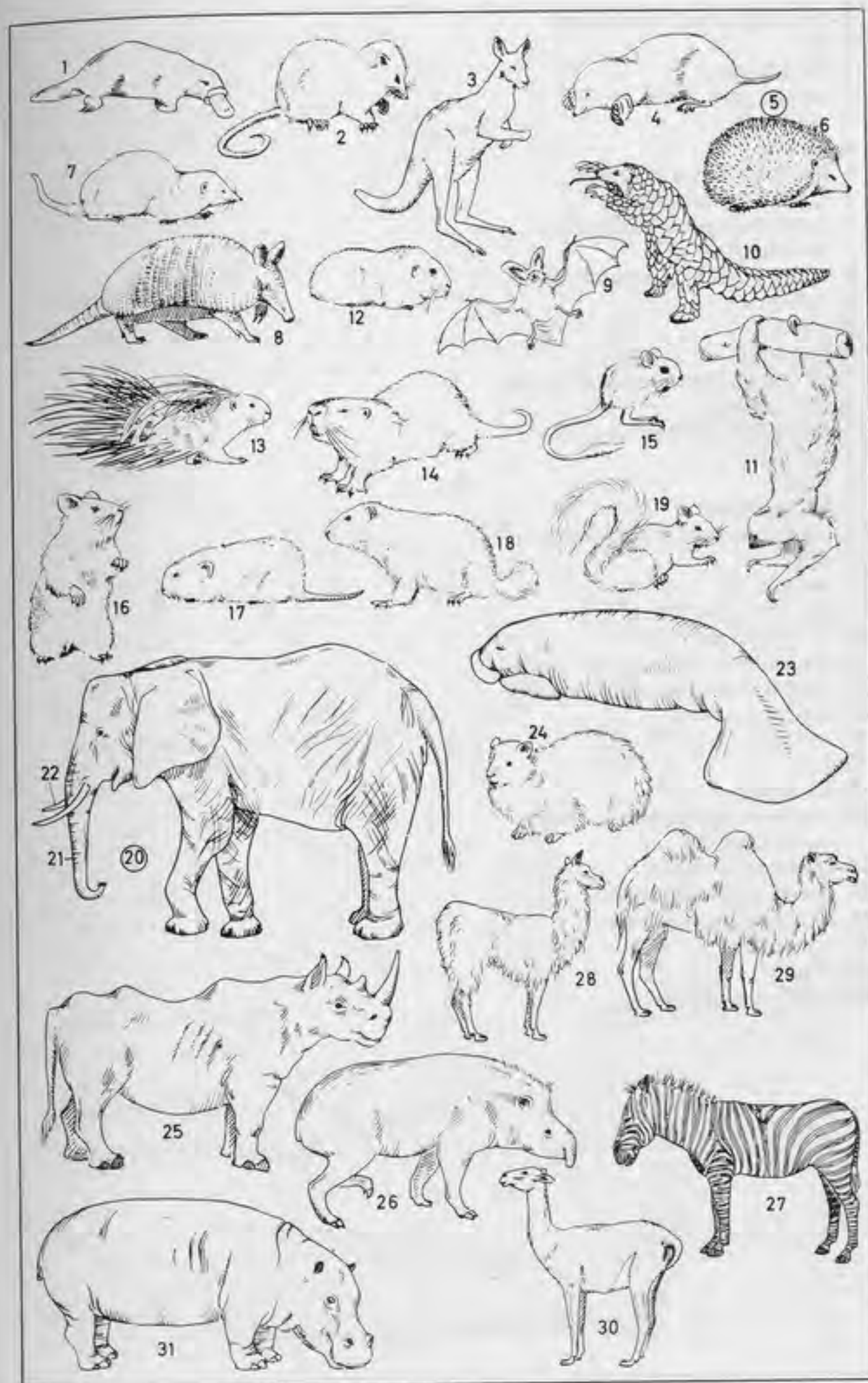



- 1-10 ungulates, ruminants**  
**1-10**  
 1 elk (moose)  
 2 wapiti (*Am. elk*)  
 3 chamois  
 4 giraffe  
 5 black buck, an antelope  
 6 mouflon (mouflon)  
 7 ibex (rock goat, bouquetin, steinbock)  
 8 water buffalo (Indian buffalo, water ox)  
 9 bison  
 10 musk ox  
**11-22 carnivores (beasts of prey)**  
**11-13 Canidae**  
 11 black-backed jackal (jackal)  
 12 red fox  
 13 wolf  
**14-17 martens**  
 14 stone marten (beach marten)  
 15 sable  
 16 weasel  
 17 sea otter, an otter  
**18-22 seals (pinnipeds)**  
 18 fur seal (sea bear, ursine seal)  
 19 common seal (sea calf, sea dog)  
 20 walrus (morse)  
 21 whiskers  
 22 tusk  
**23-29 whales**  
 23 bottle-nosed dolphin (bottle-nose dolphin)  
 24 common dolphin  
 25 sperm whale (cachalot)  
 26 blowhole (spout hole)  
 27 dorsal fin  
 28 flipper  
 29 tail flukes (tail)

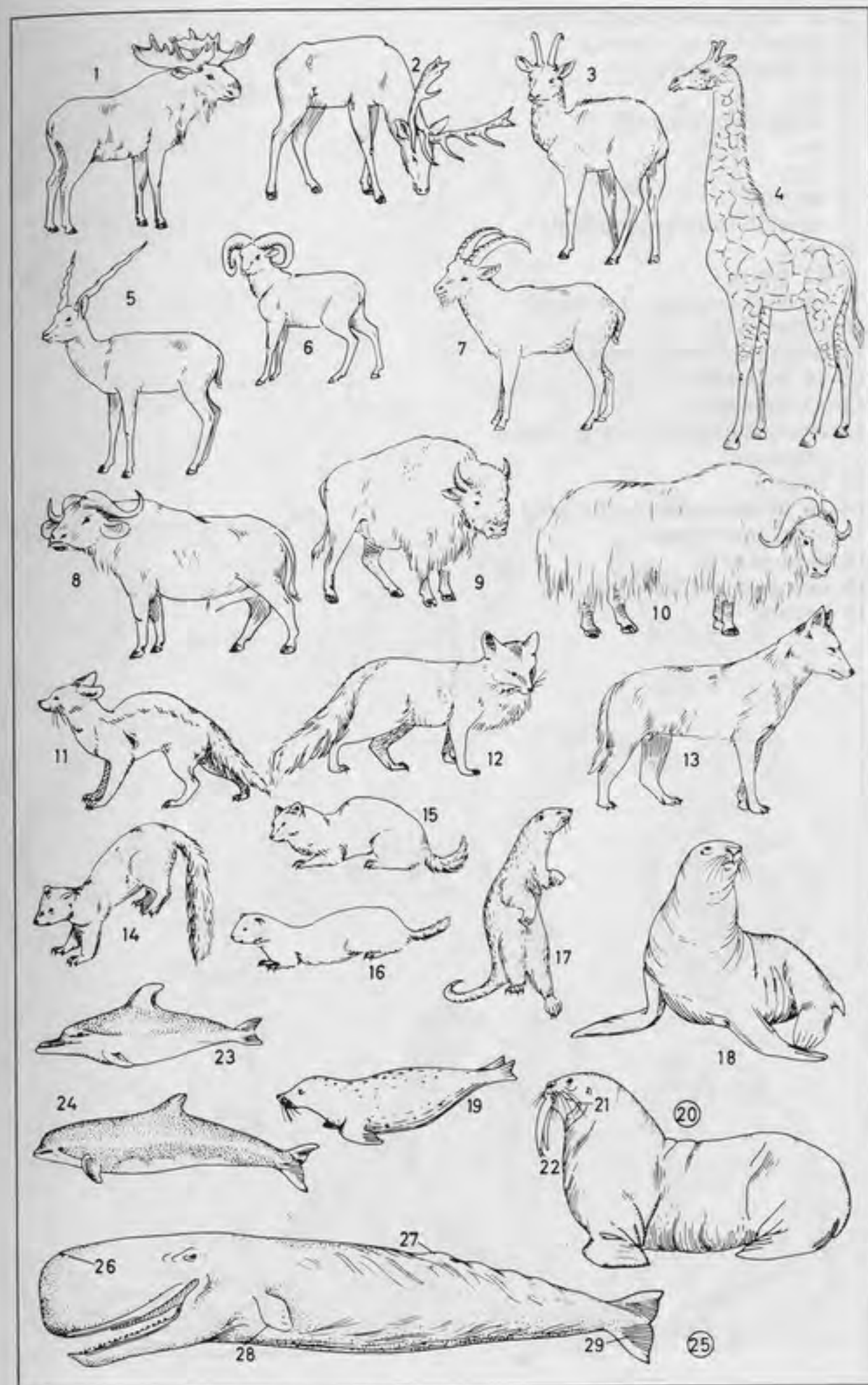



- 1-11 carnivores (beasts of prey)  
 1 striped hyena, a hyena  
 2-8 felines (cats)  
 2 lion  
 3 mane (lion's mane)  
 4 paw  
 5 tiger  
 6 leopard  
 7 cheetah (hunting leopard)  
 8 lynx  
 9-11 bears  
 9 raccoon (raccoon, *Am. coon*)  
 10 brown bear  
 11 polar bear (white bear)  
 12-16 primates  
 12-13 monkeys  
 12 rhesus monkey (rhesus, rhesus macaque)  
 13 baboon  
 14-16 anthropoids (anthropoid apes, great apes)  
 14 chimpanzee  
 15 orang-utan (orang-outan)  
 16 gorilla

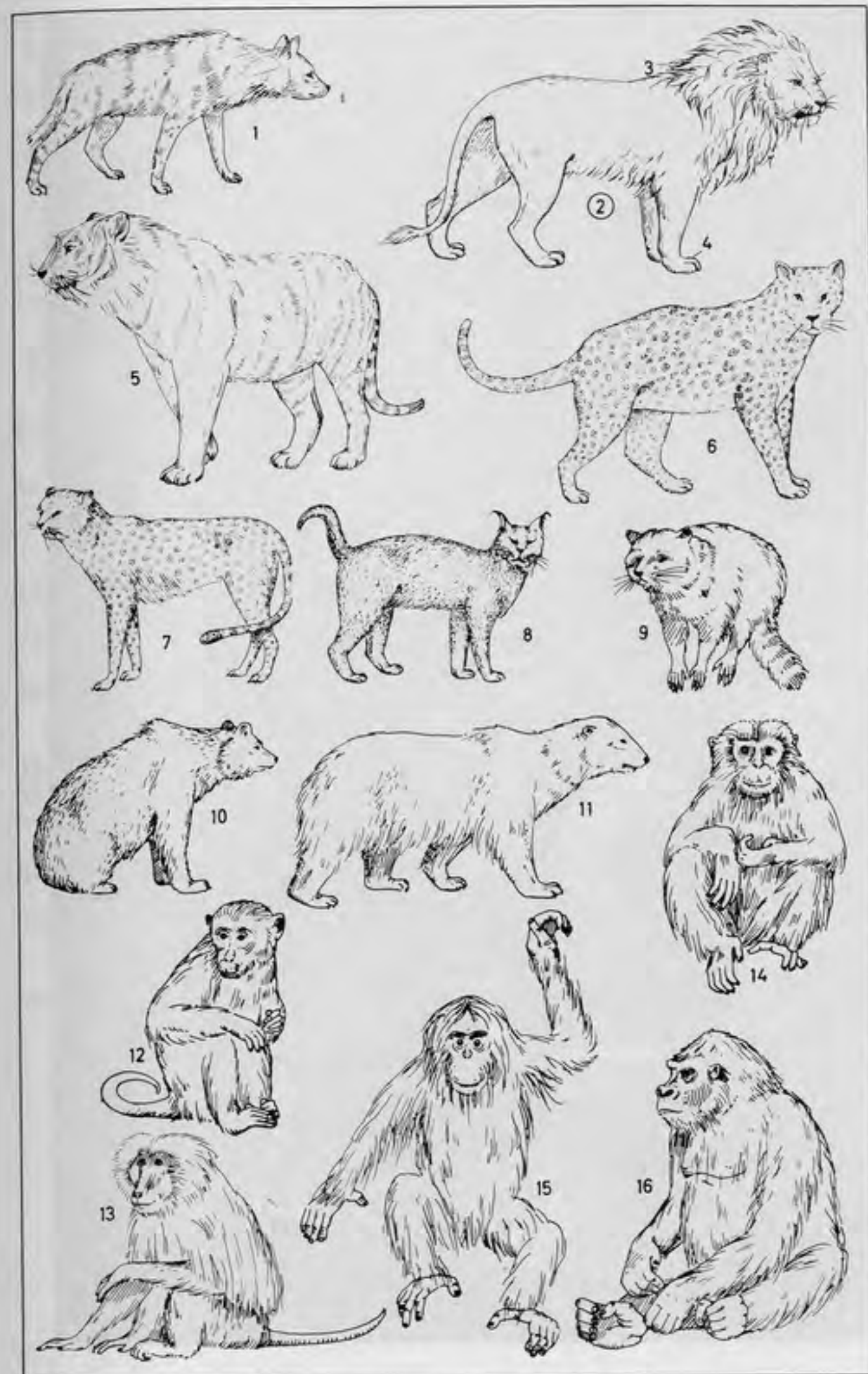



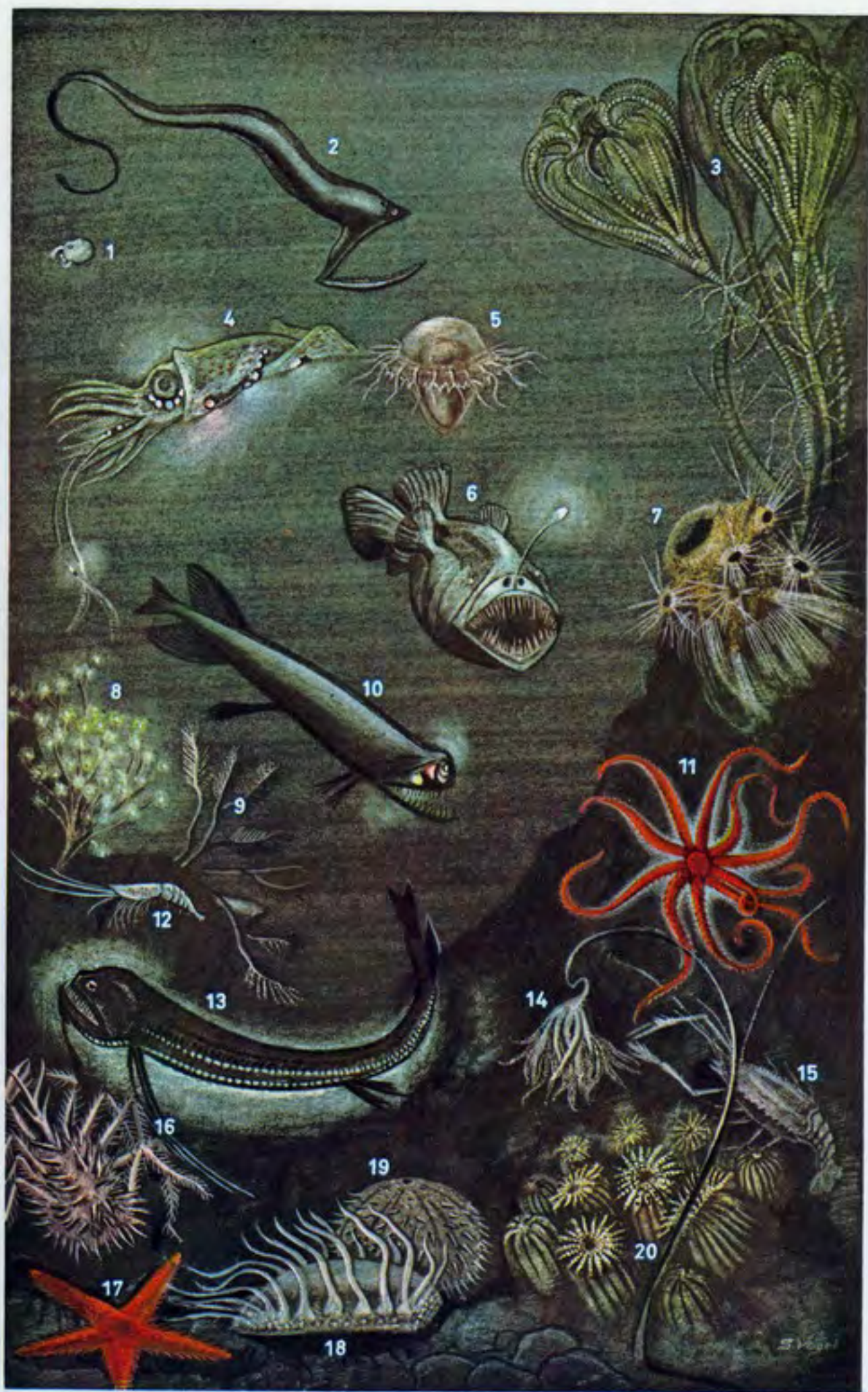

- 1 *Gigantocypris agassizi*
- 2 *Macropharynx longicaudatus* (pelican eel)
- 3 *Pentacrinus* (feather star), a sea lily, an echinoderm
- 4 *Thaumatolampas diadema*, a cuttlefish [luminescent]
- 5 *Atolla*, a deep-sea medusa, a coelenterate
- 6 *Melanocetes*, a pediculate [luminescent]
- 7 *Lophocalyx philippensis*, a glass sponge
- 8 Mopsea, a sea fan [colony]
- 9 *Hydrallmania*, a hydroid polyp, a coelenterate [colony]
- 10 *Malacosteus indicus*, a stomiatid [luminescent]
- 11 *Brisinga endecacnemos*, a sand star (brittle star), an echinoderm [luminescent only when stimulated]
- 12 *Pasiphaea*, a shrimp, a crustacean
- 13 *Echiostoma*, a stomiatid, a fish [luminescent]
- 14 *Umbellula encrinus*, a sea pen (sea feather), a coelenterate [colony, luminescent]
- 15 *Polycheles*, a crustacean
- 16 *Lithodes*, a crustacean, a crab
- 17 *Archaster*, a starfish (sea star), an echinoderm
- 18 *Oneirophanta*, a sea cucumber, an echinoderm
- 19 *Palaeopneustes niasicus*, a sea urchin (sea hedgehog), an echinoderm
- 20 *Chitonactis*, a sea anemone (actinia), a coelenterate



- 1 tree
- 2 bole (tree trunk, trunk, stem)
- 3 crown of tree (crown)
- 4 top of tree (treetop)
- 5 bough (limb, branch)
- 6 twig (branch)
- 7 bole (tree trunk) [cross section]
- 8 bark (rind)
- 9 phloem (bast sieve tissue, inner fibrous bark)
- 10 cambium (cambium ring)
- 11 medullary rays (vascular rays, pith rays)
- 12 sapwood (sap, alburnum)
- 13 heartwood (duramen)
- 14 pith
- 15 plant
- 16-18 root
- 16 primary root
- 17 secondary root
- 18 root hair
- 19-25 shoot (sprout)
- 19 leaf
- 20 stalk
- 21 side shoot (offshoot)
- 22 terminal bud
- 23 flower
- 24 flower bud
- 25 leaf axil with axillary bud
- 26 leaf
- 27 leaf stalk (petiole)
- 28 leaf blade (blade, lamina)
- 29 venation (veins, nervures, ribs)
- 30 midrib (nerve)
- 31-38 leaf shapes
- 31 linear
- 32 lanceolate
- 33 orbicular (orbiculate)
- 34 acerose (acerous, acerate, acicular, needle-shaped)
- 35 cordate
- 36 ovate
- 37 sagittate
- 38 reniform
- 39-42 compound leaves
- 39 digitate (digitated, palmate, quinquefoliolate)
- 40 pinnatifid
- 41 abruptly pinnate
- 42 odd-pinnate
- 43-50 leaf margin shapes
- 43 entire
- 44 serrate (serrulate, saw-toothed)
- 45 doubly toothed
- 46 crenate
- 47 dentate
- 48 sinuate
- 49 ciliate (ciliated)
- 50 cilium
- 51 flower
- 52 flower stalk (flower stem, scape)

- 53 receptacle (floral axis, thalamus, torus)
- 54 ovary
- 55 style
- 56 stigma
- 57 stamen
- 58 sepal
- 59 petal
- 60 ovary and stamen [section]
- 61 ovary wall
- 62 ovary cavity
- 63 ovule
- 64 embryo sac
- 65 pollen
- 66 pollen tube
- 67-77 inflorescences
- 67 spike (racemose spike)
- 68 raceme (simple raceme)
- 69 panicle
- 70 cyme
- 71 spadix (fleshy spike)
- 72 umbel (simple umbel)
- 73 capitulum
- 74 composite head (discoid flower head)
- 75 hollow flower head
- 76 bostryx (helicoid cyme)
- 77 cincinnus (scorpioid cyme, curled cyme)
- 78-82 roots
- 78 adventitious roots
- 79 tuber (tuberous root, swollen taproot)
- 80 adventitious roots (aerial roots)
- 81 root thorns
- 82 pneumatophores
- 83-85 blade of grass
- 83 leaf sheath
- 84 ligule (ligula)
- 85 leaf blade (lamina)
- 86 embryo (seed, germ)
- 87 cotyledon (seed leaf, seed lobe)
- 88 radicle
- 89 hypocotyl
- 90 plumule (leaf bud)
- 91-102 fruits
- 91-96 dehiscent fruits
- 91 follicle
- 92 legume (pod)
- 93 siliqua (pod)
- 94 schizocarp
- 95 pyxidium (circumscissile seed vessel)
- 96 poricidal capsule (porose capsule)
- 97-102 indehiscent fruits
- 97 berry
- 98 nut
- 99 drupe (stone fruit) (cherry)
- 100 aggregate fruit (compound fruit) (rose hip)
- 101 aggregate fruit (compound fruit) (raspberry)
- 102 pome (apple)

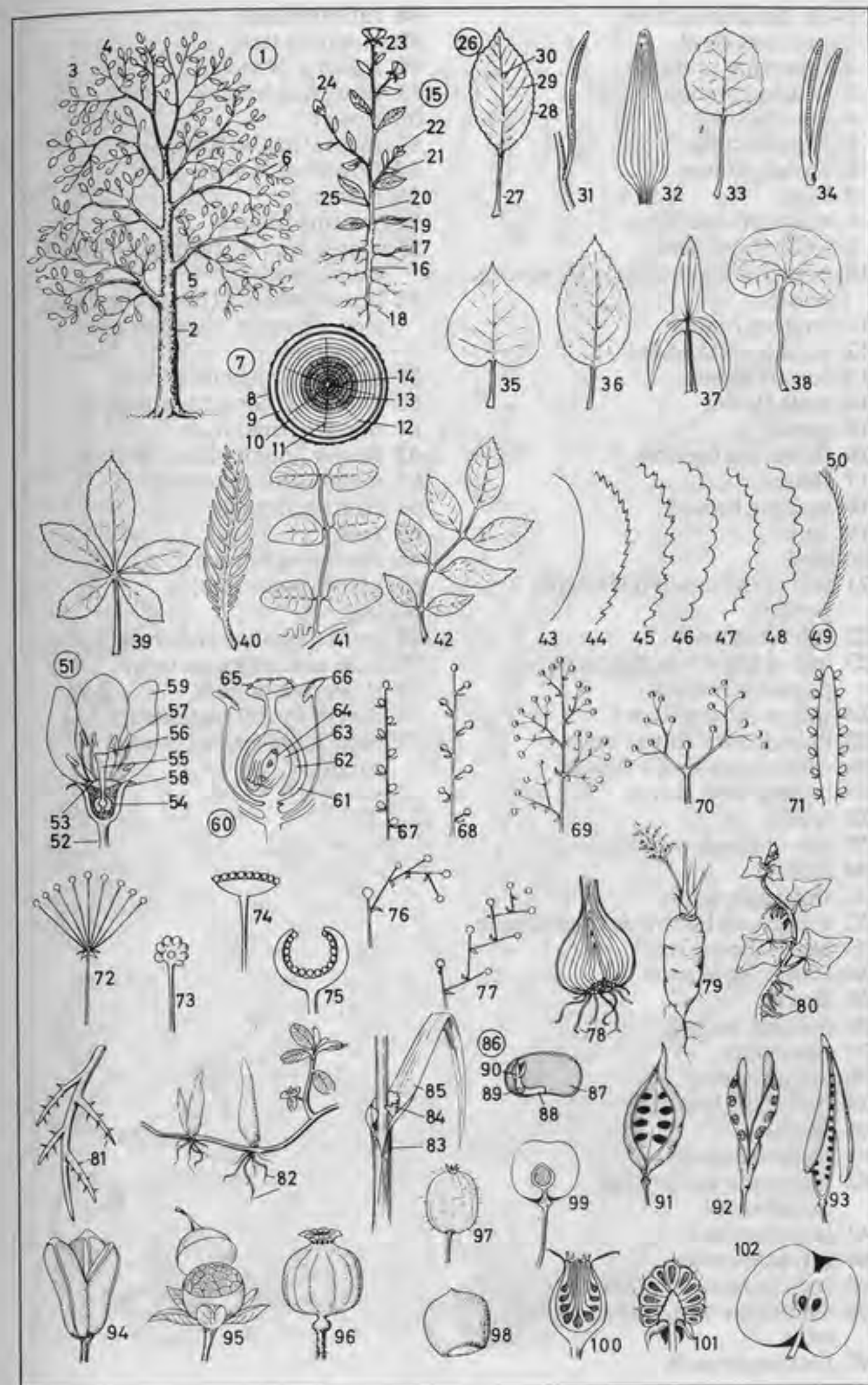



- 1-73 deciduous trees  
 1 oak (oak tree)  
 2 flowering branch  
 3 fruiting branch  
 4 fruit (acorn)  
 5 cupule (cup)  
 6 female flower  
 7 bract  
 8 male inflorescence  
 9 birch (birch tree)  
 10 branch with catkins, a flowering branch  
 11 fruiting branch  
 12 scale (catkin scale)  
 13 female flower  
 14 male flower  
 15 poplar  
 16 flowering branch  
 17 flower  
 18 fruiting branch  
 19 fruit  
 20 seed  
 21 leaf of the aspen (trembling poplar)  
 22 infructescence  
 23 leaf of the white poplar (silver poplar, silverleaf)  
 24 willow (goat willow)  
 25 branch with flower buds  
 26 catkin with single flower  
 27 branch with leaves  
 28 fruit  
 29 osier branch with leaves  
 30 alder  
 31 fruiting branch  
 32 branch with previous year's cone  
 33 beech (beech tree)  
 34 flowering branch  
 35 flower  
 36 fruiting branch  
 37 beech nut  
 38 ash (ash tree)  
 39 flowering branch  
 40 flower  
 41 fruiting branch  
 42 mountain ash (rowan, quickbeam)  
 43 inflorescence  
 44 infructescence  
 45 fruit [longitudinal section]  
 46 lime (lime tree, linden, linden tree)  
 47 fruiting branch  
 48 inflorescence  
 49 elm (elm tree)  
 50 fruiting branch  
 51 flowering branch  
 52 flower  
 53 maple (maple tree)  
 54 flowering branch  
 55 flower  
 56 fruiting branch  
 57 maple seed with wings (winged maple seed)  
 58 horse chestnut (horse chestnut tree, chestnut, chestnut tree, buckeye)  
 59 branch with young fruits  
 60 chestnut (horse chestnut)  
 61 mature (ripe) fruit  
 62 flower [longitudinal section]  
 63 hornbeam (yoke elm)  
 64 fruiting branch  
 65 seed  
 66 flowering branch  
 67 plane (plane tree)  
 68 leaf  
 69 infructescence and fruit  
 70 false acacia (locust tree)  
 71 flowering branch  
 72 part of the infructescence  
 73 base of the leaf stalk with stipules





- 1-71 coniferous trees (conifers)  
 1 silver fir (European silver fir, common silver fir)  
 2 fir cone, a fruit cone  
 3 cone axis  
 4 female flower cone  
 5 bract scale (bract)  
 6 male flower shoot  
 7 stamen  
 8 cone scale  
 9 seed with wing (winged seed)  
 10 seed [longitudinal section]  
 11 fir needle (needle)  
 12 spruce (spruce fir)  
 13 spruce cone  
 14 cone scale  
 15 seed  
 16 female flower cone  
 17 male inflorescence  
 18 stamen  
 19 spruce needle  
 20 pine (Scots pine)  
 21 dwarf pine  
 22 female flower cone  
 23 short shoot with bundle of two leaves  
 24 male inflorescences  
 25 annual growth  
 26 pine cone  
 27 cone scale  
 28 seed  
 29 fruit cone of the arolla pine (Swiss stone pine)  
 30 fruit cone of the Weymouth pine (white pine)  
 31 short shoot [cross section]  
 32 larch  
 33 flowering branch  
 34 scale of the female flower cone  
 35 anther  
 36 branch with larch cones (fruit cones)  
 37 seed  
 38 cone scale  
 39 arbor vitae (tree of life, thuja)  
 40 fruiting branch  
 41 fruit cone  
 42 scale  
 43 branch with male and female flowers  
 44 male shoot  
 45 scale with pollen sacs  
 46 female shoot

- 47 juniper (juniper tree)  
 48 female shoot [longitudinal section]  
 49 male shoot  
 50 scale with pollen sacs  
 51 fruiting branch  
 52 juniper berry  
 53 fruit [cross section]  
 54 seed  
 55 stone pine  
 56 male shoot  
 57 fruit cone with seeds [longitudinal section]  
 58 cypress  
 59 fruiting branch  
 60 seed  
 61 yew (yew tree)  
 62 male flower shoot and female flower cone  
 63 fruiting branch  
 64 fruit  
 65 cedar (cedar tree)  
 66 fruiting branch  
 67 fruit scale  
 68 male flower shoot and female flower cone  
 69 mammoth tree (Wellingtonia, sequoia)  
 70 fruiting branch  
 71 seed





- 1 forsythia
- 2 ovary and stamen
- 3 leaf
- 4 yellow-flowered jasmine  
(jasmin, jessamine)
- 5 flower [longitudinal section] with  
styles, ovaries and stamens
- 6 privet (common privet)
- 7 flower
- 8 infructescence
- 9 mock orange (sweet syringa)
- 10 snowball (snowball bush,  
guelder rose)
- 11 flower
- 12 fruits
- 13 oleander (rosebay, rose laurel)
- 14 flower [longitudinal section]
- 15 red magnolia
- 16 leaf
- 17 japonica (japanese quince)
- 18 fruit
- 19 common box (box, box tree)
- 20 female flower
- 21 male flower
- 22 fruit [longitudinal section]
- 23 weigela (weigelia)
- 24 yucca [part of the inflorescence]
- 25 leaf
- 26 dog rose (briar rose, wild briar)
- 27 fruit
- 28 kerria
- 29 fruit
- 30 cornelian cherry
- 31 flower
- 32 fruit (cornelian cherry)
- 33 sweet gale (gale)

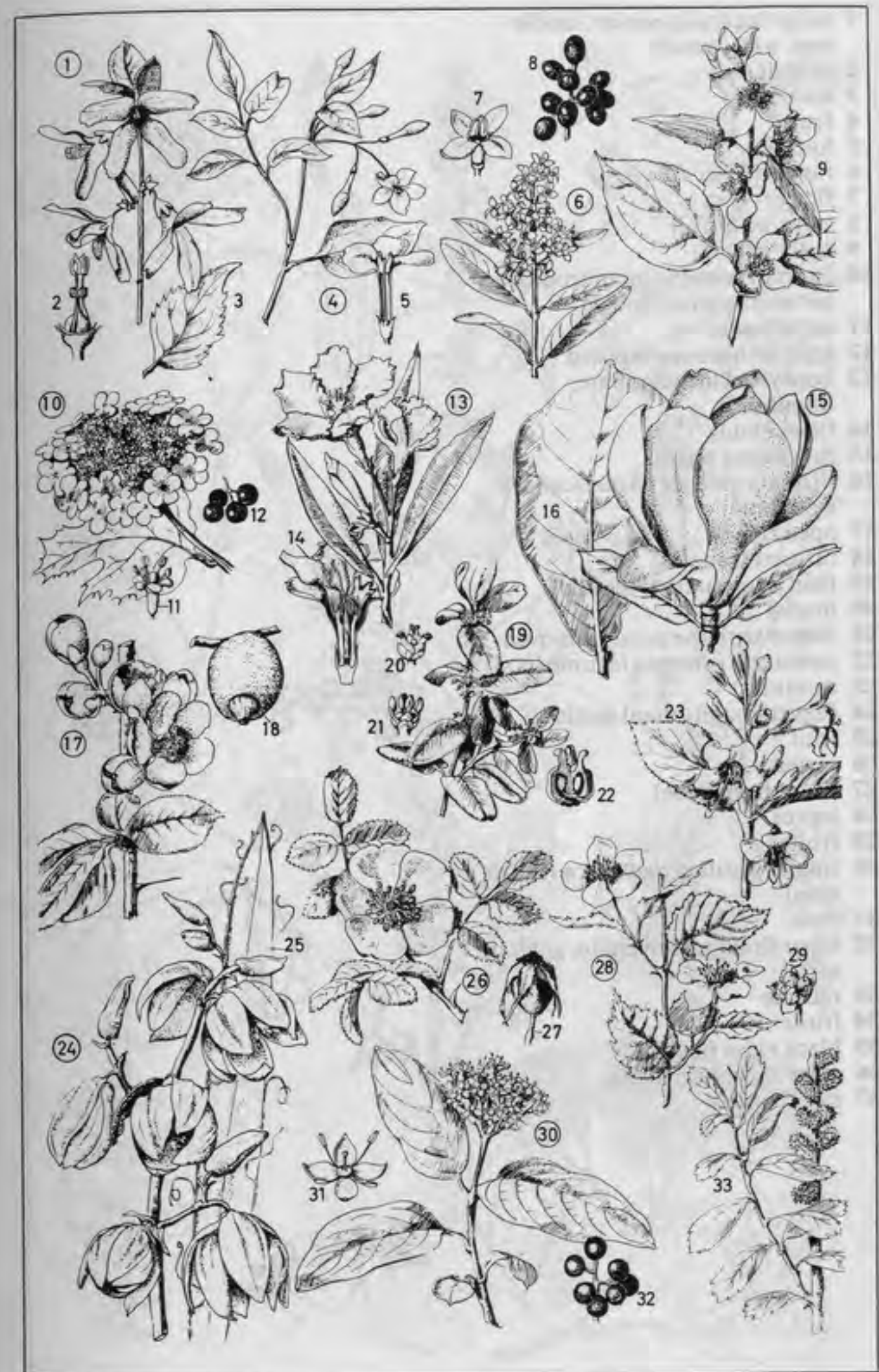



- 1 tulip tree (tulip poplar, saddle tree, whitewood)
- 2 carpels
- 3 stamen
- 4 fruit
- 5 hyssop
- 6 flower [front view]
- 7 flower
- 8 calyx with fruit
- 9 holly
- 10 androgynous (hermaphroditic, hermaphrodite) flower
- 11 male flower
- 12 fruit with stones exposed
- 13 honeysuckle (woodbine, woodbind)
- 14 flower buds
- 15 flower [cut open]
- 16 Virginia creeper (American ivy, woodbine)
- 17 open flower
- 18 infructescence
- 19 fruit [longitudinal section]
- 20 broom
- 21 flower with the petals removed
- 22 immature (unripe) legume (pod)
- 23 spiraea
- 24 flower [longitudinal section]
- 25 fruit
- 26 carpel
- 27 blackthorn (sloe)
- 28 leaves
- 29 fruits
- 30 single-pistilled hawthorn (thorn, may)
- 31 fruit
- 32 laburnum (golden chain, golden rain)
- 33 raceme
- 34 fruits
- 35 black elder (elder)
- 36 elder flowers (cymes)
- 37 elderberries





- 1 rotundifoliate (rotundifolious)  
saxifrage (rotundifoliate  
breakstone)
- 2 leaf
- 3 flower
- 4 fruit
- 5 anemone (windflower)
- 6 flower [longitudinal section]
- 7 fruit
- 8 buttercup (meadow buttercup,  
butterflower, goldcup, king cup,  
crowfoot)
- 9 basal leaf
- 10 fruit
- 11 lady's smock (ladysmock, cuckoo  
flower)
- 12 basal leaf
- 13 fruit
- 14 harebell (hairbell, bluebell)
- 15 basal leaf
- 16 flower [longitudinal section]
- 17 fruit
- 18 ground ivy (ale hoof)
- 19 flower [longitudinal section]
- 20 flower [front view]
- 21 stonecrop
- 22 speedwell
- 23 flower
- 24 fruit
- 25 seed
- 26 moneywort
- 27 dehisced fruit
- 28 seed
- 29 small scabious
- 30 basal leaf
- 31 flower of outer series
- 32 flower of inner series
- 33 involucre with pappus  
bristles
- 34 ovary with pappus
- 35 fruit
- 36 lesser celandine
- 37 fruit
- 38 leaf axil with bulbil
- 39 annual meadow grass
- 40 flower
- 41 spikelet [side view]
- 42 spikelet [front view]
- 43 caryopsis (indehiscent fruit)
- 44 tuft of grass (clump of grass)
- 45 comfrey
- 46 flower [longitudinal section]
- 47 fruit

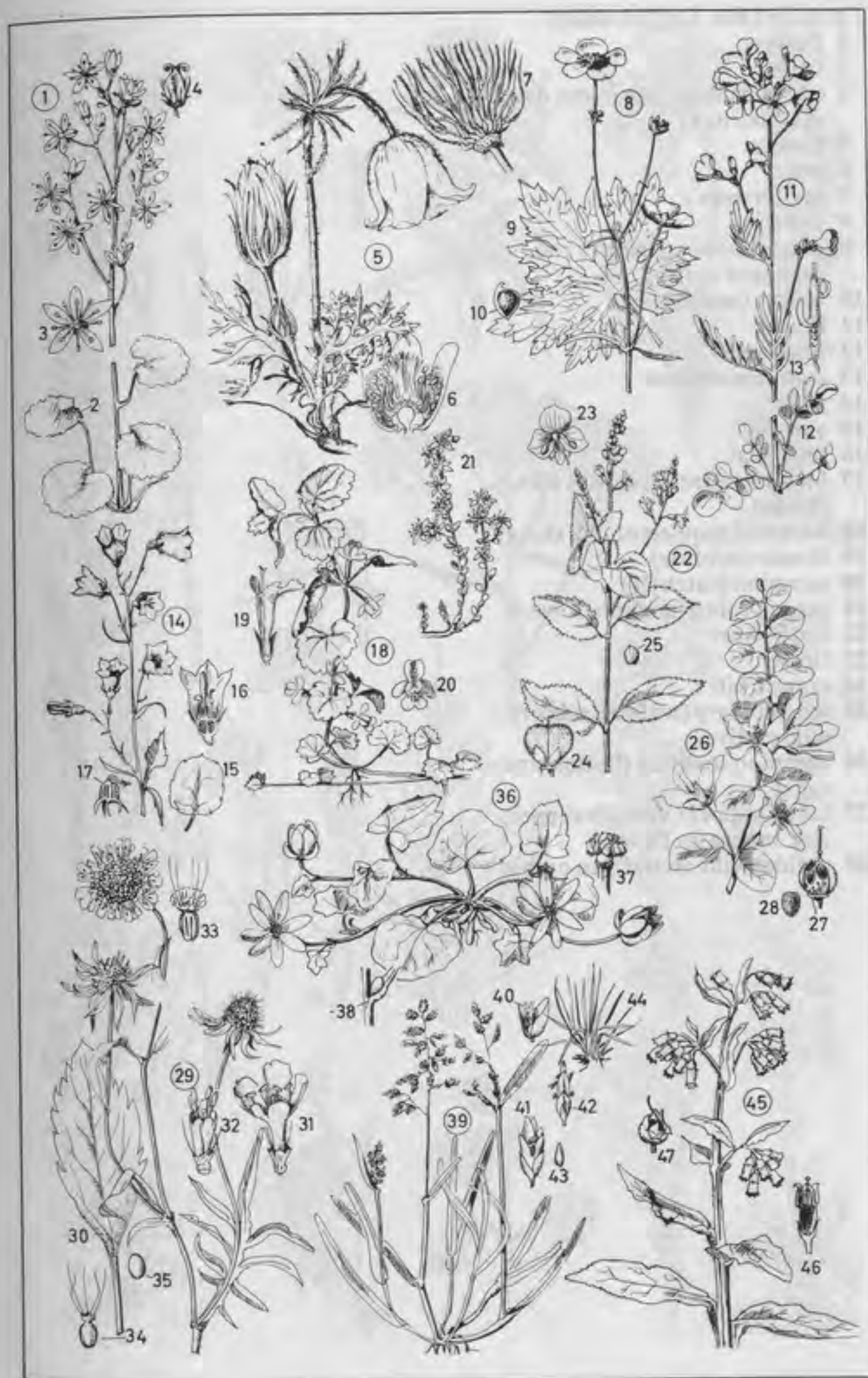



- 1 daisy (*Am.* English daisy)
- 2 flower
- 3 fruit
- 4 oxeye daisy (white oxeye daisy, marguerite)
- 5 flower
- 6 fruit
- 7 masterwort
- 8 cowslip
- 9 great mullein (*Aaron's rod, shepherd's club*)
- 10 bistort (*snakeweed*)
- 11 flower
- 12 knapweed
- 13 common mallow
- 14 fruit
- 15 yarrow
- 16 self-heal
- 17 bird's foot trefoil (*bird's foot clover*)
- 18 horsetail (*equisetum*) [a shoot]
- 19 flower (strobile)
- 20 campion (catchfly)
- 21 ragged robin (*cuckoo flower*)
- 22 birth-wort
- 23 flower
- 24 crane's bill
- 25 wild chicory (*witloof, succory, wild endive*)
- 26 common toadflax (*butter-and-eggs*)
- 27 lady's slipper (*Venus's slipper, Am. moccasin flower*)
- 28 orchis (*wild orchid*), an orchid

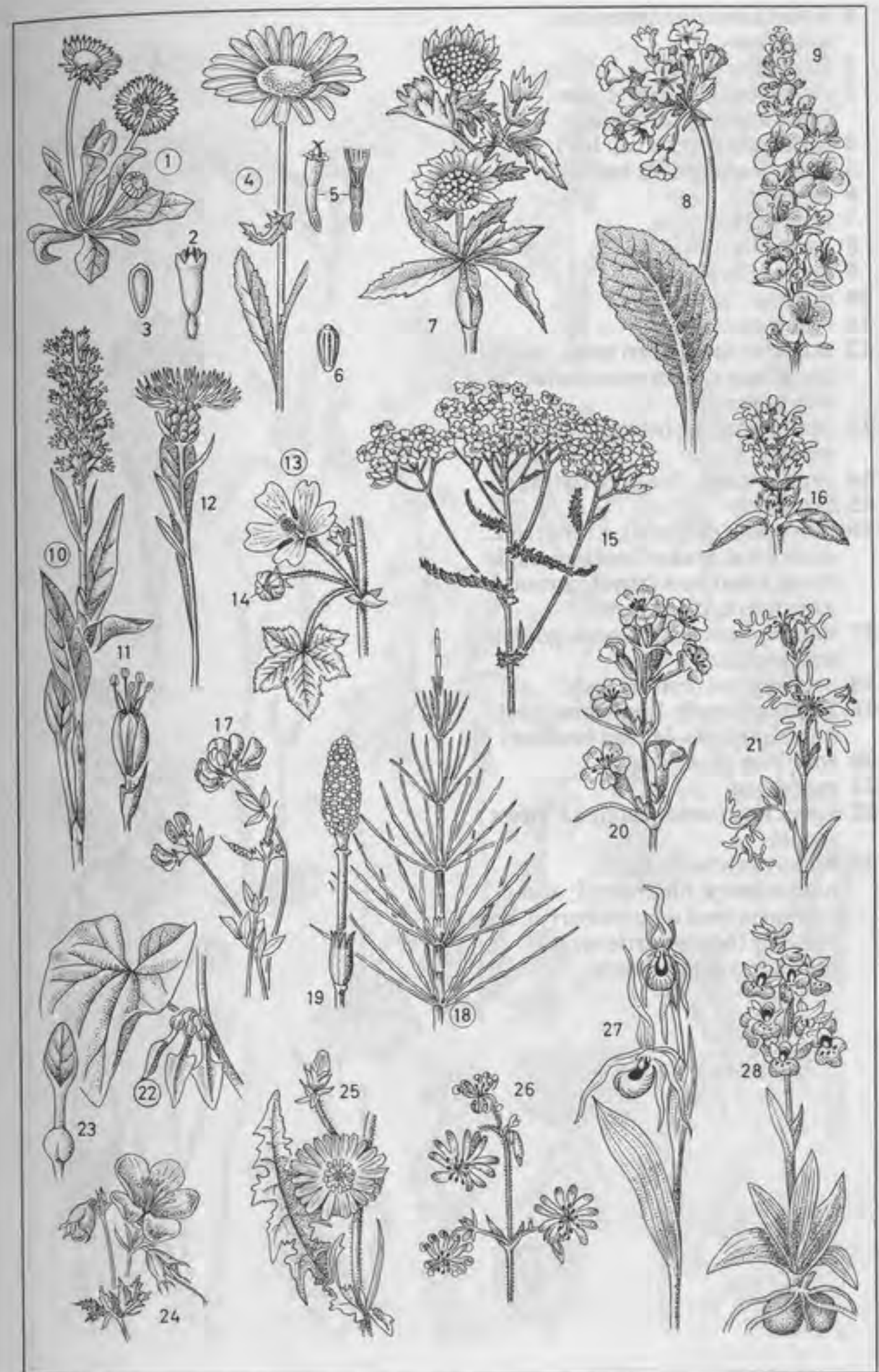



- 1 wood anemone (anemone, windflower)
- 2 lily of the valley
- 3 cat's foot (milkwort); *sim.*: sandflower (everlasting)
- 4 turk's cap (turk's cap lily)
- 5 goatsbeard (goat's beard)
- 6 ramson
- 7 lungwort
- 8 corydalis
- 9 orpine (livelong)
- 10 daphne
- 11 touch-me-not
- 12 staghorn (stag horn moss, stag's horn, stag's horn moss, coral evergreen)
- 13 butterwort, an insectivorous plant
- 14 sundew; *sim.*: Venus's flytrap
- 15 bearberry
- 16 polypody (polypod), a fern; *sim.*: male fern, brake (bracken, eagle fern), royal fern (royal osmund, king's fern, ditch fern)
- 17 haircap moss (hair moss, golden maidenhair), a moss
- 18 cotton grass (cotton rush)
- 19 heather (heath, ling); *sim.*: bell heather (cross-leaved heather)
- 20 rock rose (sun rose)
- 21 marsh tea
- 22 sweet flag (sweet calamus, sweet sedge)
- 23 bilberry (whortleberry, huckleberry, blueberry); *sim.*: cowberry (red whortleberry), bog bilberry (bog whortleberry), crowberry (crakeberry)





**378 Alpine Plants, Aquatic Plants (Water Plants),  
and Marsh Plants**

- 1-13 alpine plants
- 1 alpine rose (alpine rhododendron)
- 2 flowering shoot
- 3 alpine soldanella (soldanella)
- 4 corolla opened out
- 5 seed vessel with the style
- 6 alpine wormwood
- 7 inflorescence
- 8 auricula
- 9 edelweiss
- 10 flower shapes
- 11 fruit with pappus tuft
- 12 part of flower head (of capitulum)
- 13 stemless alpine gentian
- 14-57 aquatic plants (water plants) and marsh plants
- 14 white water lily
- 15 leaf
- 16 flower
- 17 Queen Victoria water lily (Victoria regia water lily, royal water lily, Amazon water lily)
- 18 leaf
- 19 underside of the leaf
- 20 flower
- 21 reed mace bulrush (cattail, cat's tail, cattail flag, club rush)
- 22 male part of the spadix
- 23 male flower
- 24 female part
- 25 female flower
- 26 forget-me-not
- 27 flowering shoot
- 28 flower [section]
- 29 frog's bit
- 30 watercress
- 31 stalk with flowers and immature (unripe) fruits
- 32 flower
- 33 siliqua (pod) with seeds
- 34 two seeds
- 35 duckweed (duck's meat)
- 36 plant in flower
- 37 flower
- 38 fruit
- 39 flowering rush
- 40 flower umbel
- 41 leaves
- 42 fruit
- 43 green alga
- 44 water plantain

- 45 leaf
- 46 panicle
- 47 flower
- 48 honey wrack, a brown alga
- 49 thallus (plant body, frond)
- 50 holdfast
- 51 arrow head
- 52 leaf shapes
- 53 inflorescence with male flowers [above] and female flowers [below]
- 54 sea grass
- 55 inflorescence
- 56 Canadian waterweed (Canadian pondweed)
- 57 flower

**Alpine Plants, Aquatic Plants (Water Plants), 378  
and Marsh Plants**





- 1 aconite (monkshood, wolfsbane, helmet flower)
- 2 foxglove (*Digitalis*)
- 3 meadow saffron (naked lady, naked boys)
- 4 hemlock (*Conium*)
- 5 black nightshade (common nightshade, petty morel)
- 6 henbane
- 7 deadly nightshade (belladonna, banewort, dwale), a solanaceous herb
- 8 thorn apple (stramonium, stramony, *Am.* jimson weed, jimpson weed, Jamestown weed, stinkweed)
- 9 cuckoo pint (lords-and-ladies, wild arum, wake-robin)
- 10-13 poisonous fungi (poisonous mushrooms, toadstools)
- 10 fly agaric (fly amanita, fly fungus), an agaric
- 11 amanita
- 12 Satan's mushroom
- 13 woolly milk cap

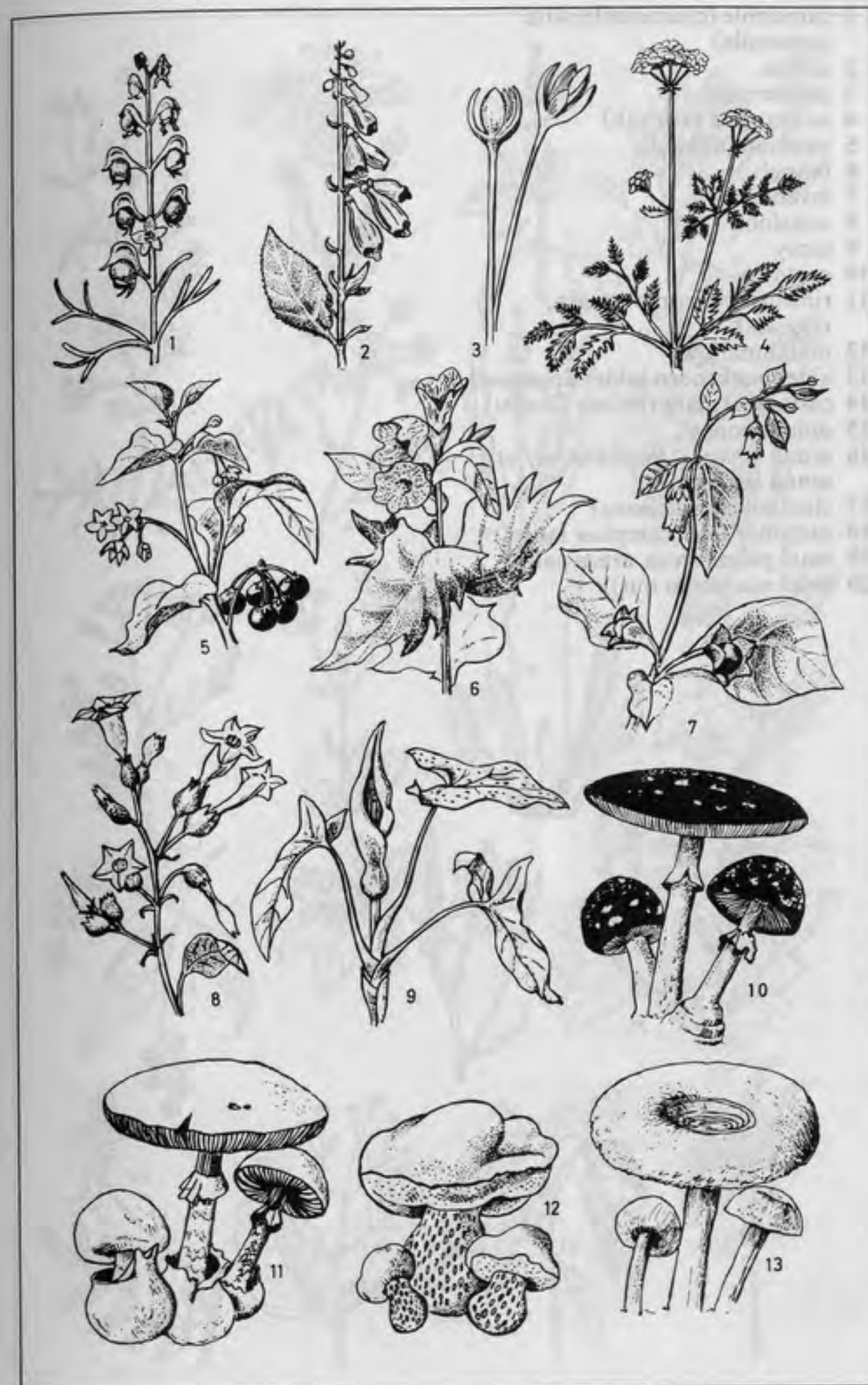



- 1 camomile (chamomile, wild camomile)
- 2 arnica
- 3 peppermint
- 4 wormwood (absinth)
- 5 valerian (allheal)
- 6 fennel
- 7 lavender
- 8 coltsfoot
- 9 tansy
- 10 centaury
- 11 ribwort (ribwort plantain, ribgrass)
- 12 marshmallow
- 13 alder buckthorn (alder dogwood)
- 14 castor-oil plant (Palma Christi)
- 15 opium poppy
- 16 senna (cassia); *the dried leaflets:* senna leaves
- 17 cinchona (chinchona)
- 18 camphor tree (camphor laurel)
- 19 betel palm (areca, areca palm)
- 20 betel nut (areca nut)

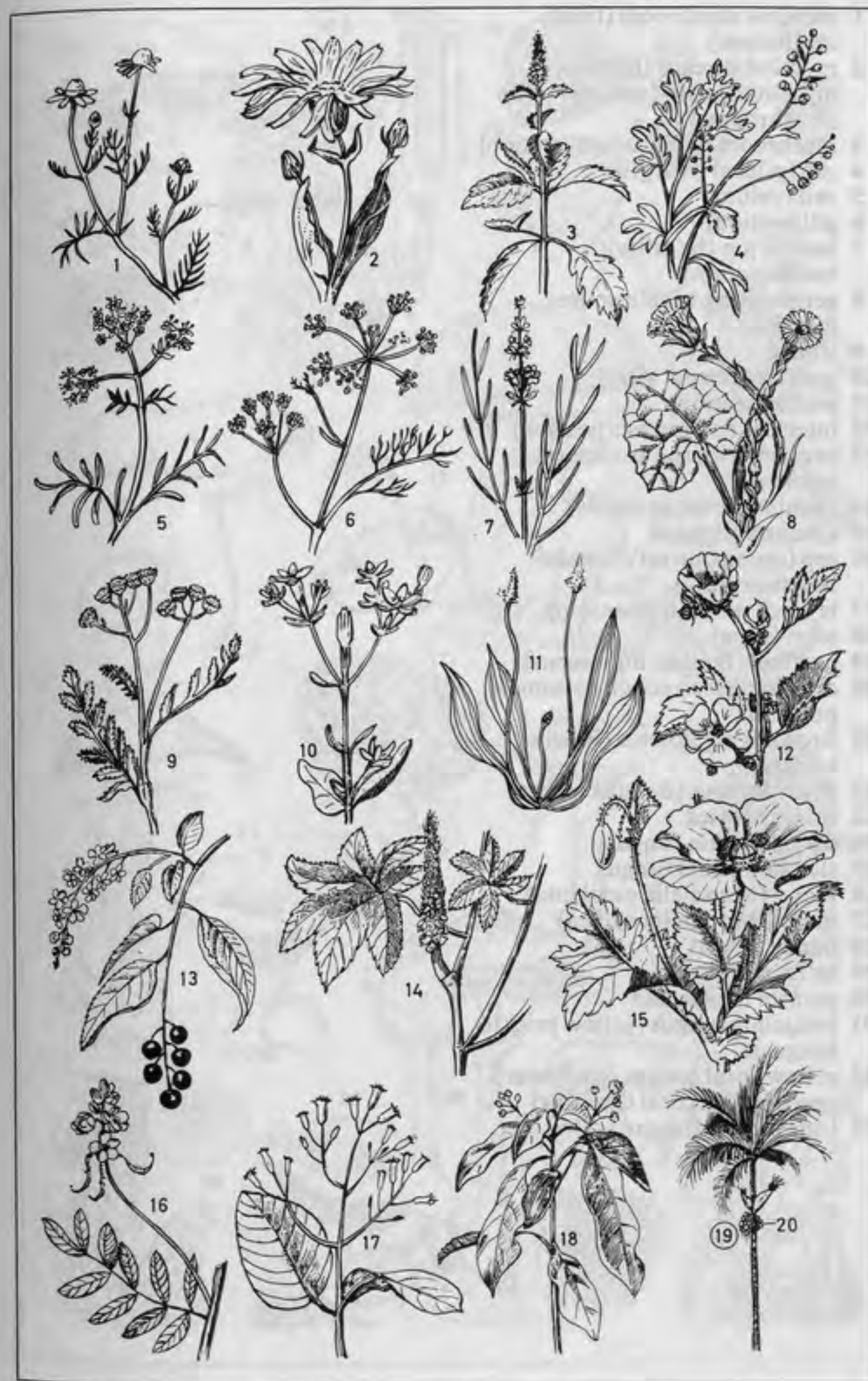



- 1 meadow mushroom (field mushroom)
- 2 mycelial threads (hyphae, mycelium) with fruiting bodies (mushrooms)
- 3 mushroom [longitudinal section]
- 4 cap (pileus) with gills
- 5 veil (velum)
- 6 gill [section]
- 7 basidia [on the gill with basidiospores]
- 8 germinating basidiospores (spores)
- 9 truffle
- 10 truffle [external view]
- 11 truffle [section]
- 12 interior showing asci [section]
- 13 two asci with the ascospores (spores)
- 14 chanterelle (chantarelle)
- 15 Chestnut Boletus
- 16 cep (cepe, squirrel's bread, *Boletus edulis*)
- 17 layer of tubes (hymenium)
- 18 stem (stipe)
- 19 puffball (*Bovista nigrescens*)
- 20 devil's tobacco pouch (common puffball)
- 21 Brown Ring Boletus (*Boletus luteus*)
- 22 Birch Boletus (*Boletus scaber*)
- 23 *Russula vesca*
- 24 scaled prickle fungus
- 25 slender funnel fungus
- 26 morel (*Morchella esculenta*)
- 27 morel (*Morchella conica*)
- 28 honey fungus
- 29 saffron milk cap
- 30 parasol mushroom
- 31 hedgehog fungus (yellow prickle fungus)
- 32 yellow coral fungus (goatsbeard, goat's beard, coral *Clavaria*)
- 33 little cluster fungus





**382 Tropical Plants used as Stimulants, Spices,  
and Flavourings (Am. Flavorings)**

- 1 coffee tree (coffee plant)
- 2 fruiting branch
- 3 flowering branch
- 4 flower
- 5 fruit with two beans  
[longitudinal section]
- 6 coffee bean; *when processed:*  
coffee
- 7 tea plant (tea tree)
- 8 flowering branch
- 9 tea leaf; *when processed:* tea
- 10 fruit
- 11 maté shrub (maté, yerba maté,  
Paraguay tea)
- 12 flowering branch with  
androgynous (hermaphroditic,  
hermaphrodite) flowers
- 13 male flower
- 14 androgynous (hermaphroditic,  
hermaphrodite) flower
- 15 fruit
- 16 cacao tree (cacao)
- 17 branch with flowers and fruits
- 18 flower [longitudinal section]
- 19 cacao beans (cocoa beans); *when  
processed:* cocoa, cocoa powder
- 20 seed [longitudinal section]
- 21 embryo
- 22 cinnamon tree (cinnamon)
- 23 flowering branch
- 24 fruit
- 25 cinnamon bark; *when crushed:*  
cinnamon
- 26 clove tree
- 27 flowering branch
- 28 flower bud; *when dried:* clove
- 29 flower
- 30 nutmeg tree
- 31 flowering branch
- 32 female flower [longitudinal  
section]
- 33 mature (ripe) fruit
- 34 nutmeg with mace, a seed with  
lacinate aril
- 35 seed [cross section]; *when dried:*  
nutmeg
- 36 pepper plant
- 37 fruiting branch
- 38 inflorescence
- 39 fruit [longitudinal section] with  
seed (peppercorn); *when ground:*  
pepper
- 40 Virginia tobacco plant

- 41 flowering shoot
- 42 flower
- 43 tobacco leaf; *when cured:*  
tobacco
- 44 mature (ripe) fruit capsule
- 45 seed
- 46 vanilla plant
- 47 flowering shoot
- 48 vanilla pod; *when cured:* stick of  
vanilla
- 49 pistachio tree
- 50 flowering branch with female  
flowers
- 51 drupe (pistachio, pistachio nut)
- 52 sugar cane
- 53 plant in bloom
- 54 panicle
- 55 flower

**Tropical Plants used as Stimulants, Spices, 382  
and Flavourings (Am. Flavorings)**

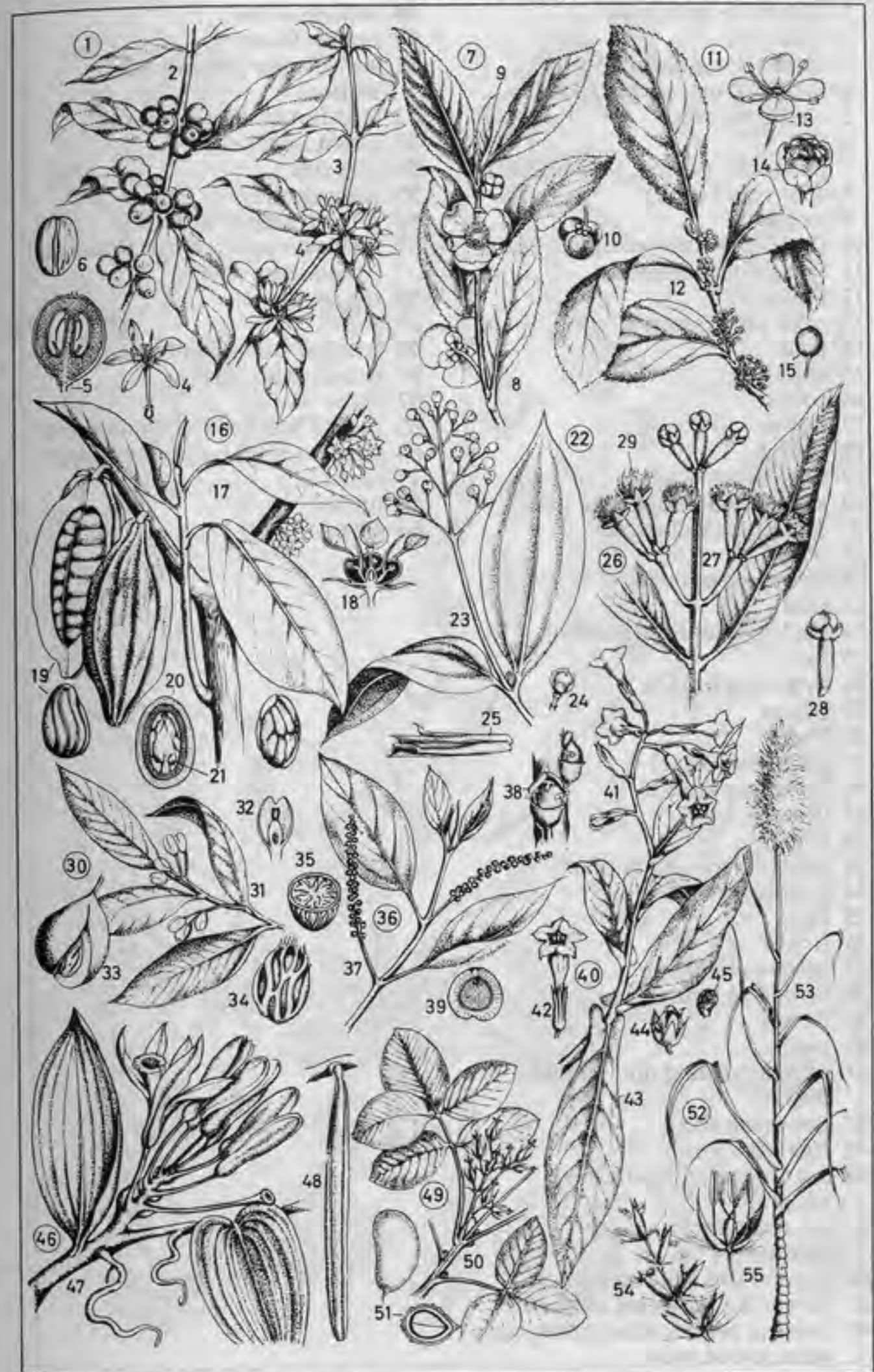



- 1 rape (cole, coleseed)
- 2 basal leaf
- 3 flower [longitudinal section]
- 4 mature (ripe) siliqua (pod)
- 5 oleiferous seed
- 6 flax
- 7 peduncle (pedicel, flower stalk)
- 8 seed vessel (boll)
- 9 hemp
- 10 fruiting female (pistillate) plant
- 11 female inflorescence
- 12 flower
- 13 male inflorescence
- 14 fruit
- 15 seed
- 16 cotton
- 17 flower
- 18 fruit
- 19 lint [cotton wool]
- 20 silk-cotton tree (kapok tree, capoc tree, ceiba tree)
- 21 fruit
- 22 flowering branch
- 23 seed
- 24 seed [longitudinal section]
- 25 jute
- 26 flowering branch
- 27 flower
- 28 fruit
- 29 olive tree (olive)
- 30 flowering branch
- 31 flower
- 32 fruit
- 33 rubber tree (rubber plant)
- 34 fruiting branch
- 35 fig
- 36 flower
- 37 gutta-percha tree
- 38 flowering branch
- 39 flower
- 40 fruit
- 41 peanut (ground nut, monkey nut)
- 42 flowering shoot
- 43 root with fruits
- 44 nut (kernel) [longitudinal section]
- 45 sesame plant (simsim, benniseed)
- 46 flowers and fruiting branch
- 47 flower [longitudinal section]
- 48 coconut palm (coconut tree, coco palm, cocoa palm)
- 49 inflorescence
- 50 female flower
- 51 male flower [longitudinal section]
- 52 fruit [longitudinal section]
- 53 coconut (cokernut)
- 54 oil palm
- 55 male spadix
- 56 infructescence with fruit
- 57 seed with micropyles (foramina) (foraminate seed)
- 58 sago palm
- 59 fruit
- 60 bamboo stem (bamboo culm)
- 61 branch with leaves
- 62 spike
- 63 part of bamboo stem with joints
- 64 papyrus plant (paper reed, paper rush)
- 65 umbel
- 66 spike

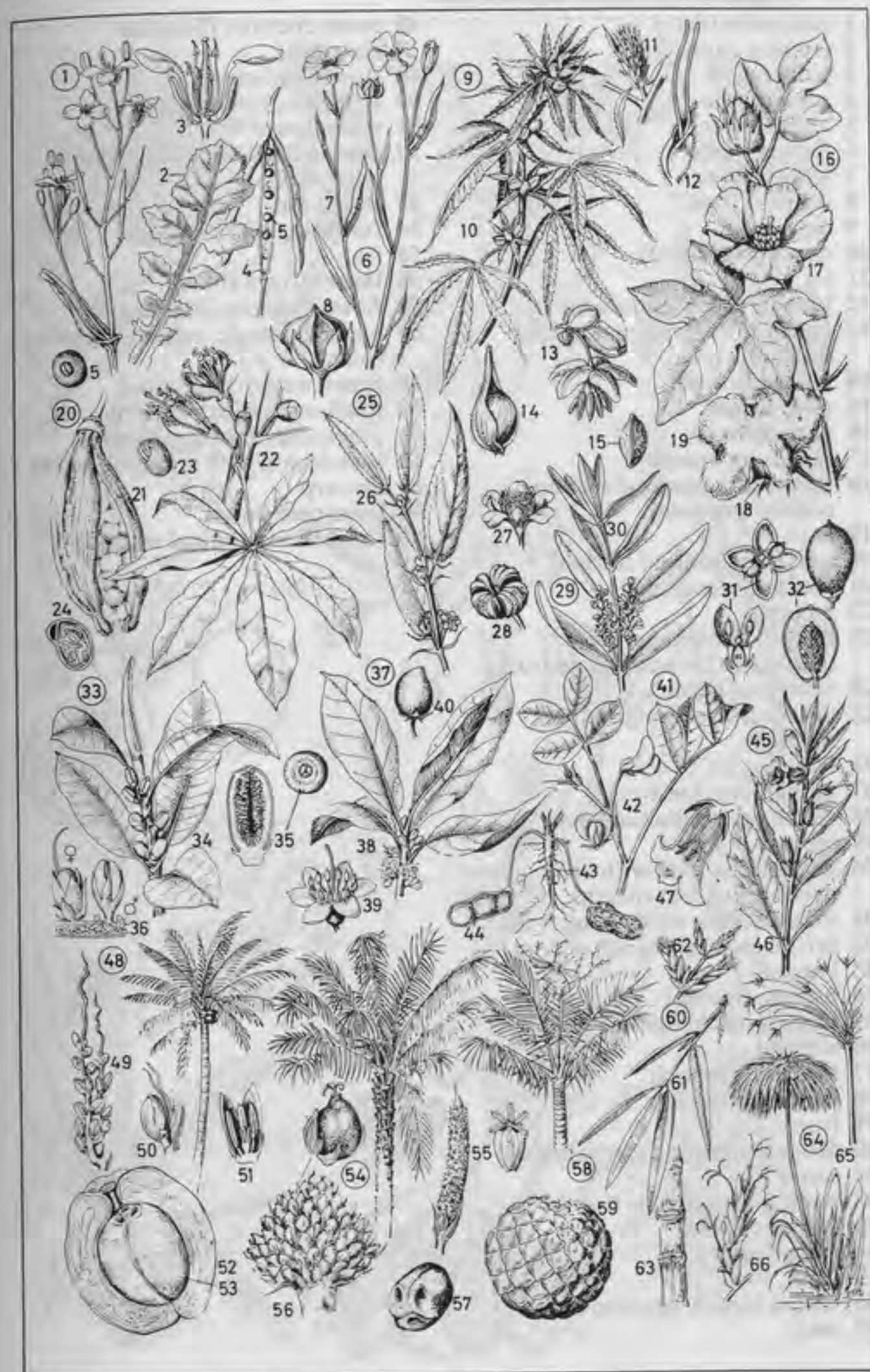



- 1 date palm (date)
- 2 fruiting palm
- 3 palm frond
- 4 male spadix
- 5 male flower
- 6 female spadix
- 7 female flower
- 8 stand of fruit
- 9 date
- 10 date kernel (seed)
- 11 fig
- 12 branch with pseudocarps
- 13 fig with flowers [longitudinal section]
- 14 female flower
- 15 male flower
- 16 pomegranate
- 17 flowering branch
- 18 flower [longitudinal section, corolla removed]
- 19 fruit
- 20 seed [longitudinal section]
- 21 seed [cross section]
- 22 embryo
- 23 lemon; *sim.*: tangerine (mandarin), orange, grapefruit
- 24 flowering branch
- 25 orange flower [longitudinal section]
- 26 fruit
- 27 orange [cross section]
- 28 banana plant (banana tree)
- 29 crown
- 30 herbaceous stalk with overlapping leaf sheaths
- 31 inflorescence with young fruits
- 32 infructescence (bunch of fruit)
- 33 banana
- 34 banana flower
- 35 banana leaf [diagram]
- 36 almond
- 37 flowering branch
- 38 fruiting branch
- 39 fruit
- 40 drupe containing seed [almond]
- 41 carob
- 42 branch with female flowers
- 43 female flower
- 44 male flower
- 45 fruit
- 46 siliqua (pod) [cross section]
- 47 seed

- 48 sweet chestnut (Spanish chestnut)
- 49 flowering branch
- 50 female inflorescence
- 51 male flower
- 52 cupule containing seeds (nuts, chestnuts)
- 53 Brazil nut
- 54 flowering branch
- 55 leaf
- 56 flower [from above]
- 57 flower [longitudinal section]
- 58 opened capsule, containing seeds (nuts)
- 59 Brazil nut [cross section]
- 60 nut [longitudinal section]
- 61 pineapple plant (pineapple)
- 62 pseudocarp with crown of leaves
- 63 syncarp
- 64 pineapple flower
- 65 flower [longitudinal section]





In the index the entries are ordered as follows:

1. Entries consisting of single words, e.g.: 'hair'.
2. Entries consisting of noun + adjective. Within this category the adjectives are entered alphabetically, e.g. 'hair, bobbed' is followed by 'hair, closely-cropped'.

Where adjective and noun are regarded as elements of a single lexical item, they are not inverted, e.g.: 'blue spruce', not 'spruce, blue'.

3. Entries consisting of other phrases, e.g. 'hair curler', 'ham on the bone', are alphabetized as headwords.

Where a whole phrase makes the meaning or use of a headword highly specific, the whole phrase is entered alphabetically. For example 'ham on the bone' follows 'hammock'.

## References

The numbers in bold type refer to the sections in which the word may be found, and those in normal type refer to the items named in the pictures. Homonyms, and in some cases uses of the same word in different fields, are distinguished by section headings (in italics), some of which are abbreviated, to help to identify at a glance the field required. In most cases the full form referred to by the abbreviations will be obvious. Those which are not are explained in the following list:

<i>Agr.</i>	Agriculture/Agricultural	<i>Hydr. Eng.</i>	Hydraulic Engineering
<i>Alp. Plants</i>	Alpine Plants	<i>Impl.</i>	Implements
<i>Art. Studio</i>	Artist's Studio	<i>Inf. Tech.</i>	Information Technology
<i>Bldg.</i>	Building	<i>Intern. Combust. Eng.</i>	Internal Combustion Engine
<i>Carp.</i>	Carpenter	<i>Moon L.</i>	Moon Landing
<i>Cement Wks.</i>	Cement Works	<i>Music Not.</i>	Musical Notation
<i>Cost.</i>	Costumes	<i>Overh. Irrign.</i>	Overhead Irrigation
<i>Cyc.</i>	Cycle	<i>Platem.</i>	Platemaking
<i>Decid.</i>	Deciduous	<i>Plant. Propagn.</i>	Propagation of Plants
<i>D.I.Y.</i>	Do-it-yourself	<i>Rm.</i>	Room
<i>Dom. Anim.</i>	Domestic Animals	<i>Sp.</i>	Sports
<i>Equest.</i>	Equestrian Sport	<i>Text.</i>	Textile[s]
<i>Gdn.</i>	Garden	<i>Veg.</i>	Vegetable[s]
<b>A</b>			
Aaron's rod <b>376 9</b>		accessory shoe <b>114 4</b> ; <b>115 20</b>	actinia <b>369 20</b>
abacus <b>309 77</b>		accessory shop <b>196 24</b>	Actinophrys <b>357 7</b>
abacus <i>Art</i> <b>334 20</b>		access ramp <b>199 15</b>	action <b>326 6-16</b>
abattoir <b>94</b>		acciaccatura <b>321 15</b>	action lever <b>325 32</b>
abdomen <i>Man</i> <b>16 35-37, 36</b>		accipiters <b>362 10-13</b>	activated blade attachment <b>84 33</b>
abdomen <i>Bees</i> <b>77 10-19</b>		accolade <b>329 66</b>	actor <b>316 37</b>
abdomen <i>Forest Pests</i> <b>82 9</b>		accommodation <b>146 33</b>	actress <b>316 38</b>
abdomen, lower ~ <b>16 37</b>		accommodation bureau <b>204 28</b>	actuating transistor <b>195 19</b>
abdomen, upper ~ <b>16 35</b>		accommodation ladder <b>221 98</b>	acuity projector <b>111 47</b>
abductor hallucis <b>18 49</b>		accommodation module <b>146 33</b>	acute <b>342 30</b>
abductor of the hallux <b>18 49</b>		accompaniment side <b>324 43</b>	ad <b>342 56</b>
aberdervine <b>361 8</b>		accompaniment string <b>324 25</b>	Adam's apple <b>19 13</b>
aborigine, Australian ~ <b>352 37</b>		accordion <b>324 36</b>	adapter <b>112 55</b>
abrasion platform <b>13 31</b>		account, private ~ <b>250 4</b>	adapter, four-socket ~ <b>127 8</b>
abrasive wheel combination <b>111 28, 35</b>		accounting machine <b>236 26</b>	adapter, four-way ~ <b>127 8</b>
abscissa <b>347 9</b>		accumulator <b>309 41</b>	adapter ring <b>115 82</b>
abseiling <b>300 28-30</b>		accumulator <i>Theatre</i> <b>316 55</b>	adapter unit <b>242 34</b>
abseil piton <b>300 39</b>		accumulator railcar <b>211 55</b>	adders <b>364 40-41</b>
abseil sling <b>300 28</b>		accuracy jump <b>288 55</b>	adding <b>344 23</b>
absinth <b>380 4</b>		acerate <b>370 34</b>	adding machine <b>309 74</b>
absorber attachment <b>27 44</b>		acerose <b>370 34</b>	adding mechanism <b>271 9</b>
absorption dynamometer <b>143 97-107</b>		acerous <b>370 34</b>	addition <b>344 23</b>
absorption muffler <b>190 16</b>		acetylene connection <b>141 31</b>	address <b>236 42</b>
absorption silencer <b>190 16</b>		acetylene control <b>141 32</b>	address display <b>236 41</b>
abutment <i>Bridges</i> <b>215 27, 29, 45</b>		acetylene cylinder <b>141 2, 22</b>	addressing machine, transfer-type ~ <b>245 7</b>
abutment <i>Art</i> <b>336 20</b>		achene <b>58 23</b>	address label <b>236 4</b>
abutment pier <b>215 29</b>		achievement <b>254 1-6</b>	address system, ship's ~ <b>224 30</b>
acanthus <b>334 25</b>		achievement, marital ~ <b>254 10-13</b>	A-deck <b>223 28-30</b>
acceleration rocket <b>234 22, 48</b>		achievement of arms <b>254 1-6</b>	adhesion railcar <b>214 1</b>
accelerator <b>191 46</b>		Achilles' tendon <b>18 48</b>	adhesive, hot ~ <b>249 61</b>
accelerator lock <b>85 17</b>		acicular <b>370 34</b>	adhesive binder <i>Bookbind.</i> <b>184 1</b>
accelerator pedal <b>191 46, 94</b>		acid container <b>350 62</b>	adhesive binder <i>Office</i> <b>249 61</b>
accelerometer <b>230 10</b>		Ackermann steering system <b>85 31, 37</b>	adhesive tape dispenser <b>247 27</b>
accent, acute ~ <b>342 30</b>		acolyte <b>331 45</b>	adhesive tape dispenser, roller-type ~ <b>247 28</b>
accent, circumflex ~ <b>342 32</b>		aconite <b>379 1</b>	adhesive tape holder <b>247 28</b>
accent, grave ~ <b>342 31</b>		acorn <b>371 4</b>	adjusting cone <b>187 58</b>
accent, strong ~ <b>321 27</b>		acorns <b>276 42</b>	adjusting equipment <b>148 61-65</b>
accents <b>342 30-35</b>		acrobat <b>307 47</b>	adjusting knob <b>116 54</b>
acceptance <b>250 12, 23</b>		Acropolis <b>334 1-7</b>	adjusting nut <b>143 35</b>
access balcony <b>37 72-76</b>		acroter <b>334 34</b>	adjusting screw <i>Bldg. Site</i> <b>119 79</b>
access flap <b>6 21, 25</b>		acroterion <b>334 34</b>	
accessories <b>115 43-105</b>		acroterium <b>334 34</b>	
		acting area light <b>316 16</b>	
		acting area spotlight <b>316 16</b>	



## adjusting screw

adjusting screw *Mach. Parts etc.* 143 107  
 adjusting screw *Inf. Tech.* 242 78  
 adjusting spindle 226 51  
 adjusting washer 187 55  
 adjustment, circular ~ 14 62  
 adjustment, coarse ~ 112 4  
 adjustment, fine ~ *Optic. Instr.* 112 5  
 adjustment, fine ~ *Photog.* 116 33  
 adjustment, fine ~ *Joiner* 133 36  
 adjustment, fine ~ *Drawing Off.* 151 66  
 adjustment knob 11 41  
 administration area 5 17  
 administration building *Coal* 144 18  
 administration building *Airport* 233 16  
 administration building *Films* 310 4  
 Admiralty anchor 286 15  
 admission ticket 315 11  
 adult insect 358 10  
 advance booking office 271 26  
 adventure playground 273 21  
 advertisement 98 2; 204 10; 268 43, 71; 271 25; 312 23; 342 56, 69  
 advertising, classified ~ 342 69  
 advertising calendar 22 10  
 advertising pillar 268 70  
 adze 300 34  
 aerator 56 15  
 aerial 213 4  
 aerial ladder 270 9  
 aerial sports 288  
 aerobatic manoeuvres 288 1-9  
 aerobatics 288 1-9  
 aero engines 232 33-60  
 aerofoil, rear ~ 290 35  
 aerogenerator 55 34; 155 42  
 aeroplane 230 67-72  
 aeroplane, propeller-driven ~ 231 1-6  
 aeroplane, types of ~ 231 1-33  
 aeroplane tow launch 287 1  
 aerotowing 287 1  
 aero wheel 305 79  
 Afghan 70 23  
 Afghan hound 70 23  
 A flat major 320 66  
 Africa 14 14  
 African hemp 53 9  
 African marigold 60 20  
 Afro look 34 26  
 afterburner exhaust nozzle 256 13  
 aftercastle 218 23  
 after deck 223 32  
 afterpeak 227 28  
 aftershave lotion 49 38  
 aft fan-jet 232 42  
 aft ship 286 34, 37, 41  
 agaric 379 10

agate 175 22  
 agent 307 18  
 aggregate scraper 200 13  
 agitator *Agr. Mach.* 64 70  
 agitator *Paperm.* 172 47  
 agricultural implements 66  
 agricultural machinery 64; 65  
 agricultural worker 63 5  
 agriculture 63  
 Agulhas Current 14 37  
 aileron 230 52; 287 41; 288 28  
 aileron, inner ~ 229 43  
 aileron, outer ~ 229 41  
 aileron actuator 257 39  
 aiming position 86 34  
 air-bed, inflatable ~ 278 31  
 air blast 139 56  
 air-blast circuit breaker 152 34; 153 51-62  
 air-bleed duct *Roof & Boilerr.* 38 51  
 air-bleed duct *Intern. Combust. Eng.* 190 12  
 air blower, primary ~ 160 11  
 air brake 229 44; 256 12  
 airbus 231 17  
 air cleaner 191 55  
 air compressor *Painter* 129 33  
 air compressor *Offshore Drill.* 146 23  
 air compressor *Railw.* 211 14, 44; 212 34, 58, 72  
 air compressor, diesel-powered ~ 200 39  
 air compressor, mobile ~ 200 39  
 air-conditioning 26 20  
 air-conditioning equipment 239 15  
 air correction jet 192 3  
 aircraft 229; 230; 231; 232  
 aircraft, propeller-driven ~ 231 1-6  
 aircraft, single-engine ~ 230 1-31, 32-66; 231 1, 2  
 aircraft, tilt-wing ~ 232 26  
 aircraft, twin-boom ~ 229 34  
 aircraft, twin-engine ~ 231 3  
 aircraft, twin-jet ~ 231 7  
 aircraft, types of ~ 231 1-33  
 aircraft cannon 256 3  
 aircraft carrier, nuclear-powered ~ 259 1  
 aircraft elevator 259 4, 13  
 aircraft engines 232 33-60  
 aircraft lift 259 4, 13  
 aircraft tractor 233 23  
 aircraft tug 233 23  
 air currents 9 25-29  
 air cushion 286 66  
 air-cushion vehicle 286 63  
 air duct 155 35  
 ailer 50 32  
 ailer, extending ~ 50 34  
 air extraction vent 154 21  
 air extractor duct 258 57  
 air extractor pipe 133 40  
 air feed pipe 147 29  
 air filler neck 196 21  
 air filter 191 55  
 air flow 199 45

air flow, secondary ~ 232 50  
 air force 256; 257  
 air hose *Garage* 195 54  
 air hose *Serv. Stat.* 196 18  
 air inlet *Lorries etc.* 194 16  
 air inlet *Warships* 259 73  
 air inlet *Fire Brig.* 270 60  
 air inlet and outlet 92 14  
 air intake *Car* 192 60  
 air intake *Railw.* 209 11  
 air intake *Air Force* 256 5; 257 12  
 air intake, annular ~ 232 52  
 air intake duct 257 14  
 air jet pipe 281 41  
 air line 75 28  
 airliner, four-jet ~ 231 13  
 airliner, supersonic ~ 231 15  
 airliner, tri-jet ~ 231 12  
 airliner, twin-jet ~ 231 11, 17  
 airliner, wide-body ~ 231 14, 17  
 air lock *Coal* 144 38  
 air lock *Offshore Drill.* 146 24  
 air lock *Space* 235 27  
 air lock *Chem.* 349 7  
 air masses, homogeneous ~ 8 1-4  
 air mattress 278 31  
 air outlet 168 29  
 air oxidation passage 165 48  
 air passage 333 4  
 airplane see aeroplane  
 airport 233  
 'airport' 233 24  
 airport fire service 233 7  
 airport information symbols 233 24-53  
 airport restaurant 233 19  
 air preheater *Forging* 139 53  
 air preheater *Power Plant* 152 11  
 air pump *Paperm.* 172 40  
 air pump *Letterpress* 181 6, 35  
 air receiver 269 17, 50  
 air refuelling probe 256 7  
 air regenerator chamber 147 30  
 air regulator *Offset Print.* 180 74  
 air regulator *Chem.* 350 3, 8  
 air reservoir, auxiliary ~ 212 61  
 air reservoir, main ~ 211 8; 212 57, 71  
 air rifle 305 40  
 air rifle cartridge 305 34  
 airscrew 230 32; 288 36  
 air space 74 61  
 air-speed indicator 230 2  
 airsports 288  
 airstream, cold ~ 9 29  
 airstream, main ~ 192 5  
 airstream, warm ~ 9 28  
 air supply 155 24  
 air survey camera 14 63  
 air temperature 280 8  
 air vent cap 38 52  
 air vessel 269 17, 50  
 aisle *Map* 15 112  
 aisle *Forestry* 84 1

aisle *Church* 330 27  
 aisle *Art* 334 63, 335 2  
 alarm clock 110 19  
 alarm clock, electric ~ 43 16  
 albumen 74 62  
 albumum *Corp.* 120 85  
 albumum *Bot.* 370 12  
 Alcor 3 29  
 Aldebaran 3 25  
 alder 371 30  
 alder buckthorn 380 13  
 alder dogwood 380 13  
 alder-swamp peat 13 18  
 ale 93 26  
 ale hoof 375 18  
 Alençon lace 102 30  
 alfalfa grass 136 26  
 alga, brown ~ 378 48  
 alga, green ~ 378 43  
 algebra 345 4-5  
 alighting board 77 49  
 alkali-cellulose 169 9  
 alkali-cellulose crumbs 169 7  
 Allais chicane 301 72  
 all-container ship 221 21; 226 5  
 Aller rock salt 154 63  
 allheal 380 5  
 allonge periwig 34 2  
 allotment 52 1-32  
 allotment holder 52 24  
 all-purpose gun 258 70  
 all-purpose gun, radar-controlled ~ 258 47, 48  
 all-purpose trailer 62 40  
 all-purpose vehicle 255 96  
 all-speed aileron 229 43  
 alluvial deposit 216 52  
 all-weather roof 200 38  
 all-wheel drive 194 1  
 almond *Tablew. etc.* 45 41  
 almond *South, Fruits* 384 36  
 aloe 53 13  
 alphanumeric disc store 176 33  
 alpha particle 1-31; 227  
 alpha radiation 1 30-31  
 Alpine Club hut 300 1  
 alpine rhododendron 378 1  
 alpine rose 378 1  
 alpine soldanella 378 3  
 alpine strawberry 58 16  
 alpine wormwood 378 6  
 Alpinism 300 1-57  
 Alpinist 300 5  
 Alsatian 70 25  
 alsike 69 3  
 alsike clover 69 3  
 Altair 3 9  
 altar 330 4, 33; 334 48, 69  
 altar bell 332 52  
 altar candle 330 7, 34  
 altar carpet 330 3  
 altar cloth 330 6, 36  
 altar cross 330 35  
 altar crucifix 330 12  
 altar decoration 330 48  
 altarpiece 330 13, 50  
 altar steps 330 5, 31  
 alternative school 261 1-45  
 alternator 152 23; 153 1

altimeter 230 4  
 altitude 346 27  
 altitude scale 7 35  
 alto clef 320 10  
 altocumulus 8 15  
 altocumulus castellanus 8 16  
 altocumulus floccus 8 16  
 altostratus 8 8  
 altostratus praecipitans 8 9  
 alto trombone 323 46  
 aluminium foil, asphalted ~ 155 29  
 aluminium see aluminium  
 A major 320 58  
 amanita 379 11  
 amaryllis 53 8  
 Amazon water lily 378 17  
 ambulance 270 19  
 ambulance, armoured ~ 255 79  
 ambulance attendant 270 21  
 ambulance car 270 19  
 ambulance man 270 21  
 America 14 12-13  
 American blight 80 32  
 American football 292 22  
 American ivy 51 5; 374 16  
 A minor 320 55, 62  
 A minor scale 320 46, 47, 48  
 ammeter *Car* 191 78  
 ammeter *Aircraft* 230 18  
 ammonia 170 24  
 ammonia scrubber 156 23  
 ammonia wet collector 156 23  
 ammonium sulphate 156 36  
 ammonium sulphate, production of ~ 156 35  
 ammonium sulphate solution 170 26  
 ammunition 87 19; 305 34-49  
 amoeba 357 1  
 amoreto 272 20  
 amorino 272 20  
 Amphibia 364; 364 20-26  
 amphibian 232 8  
 amphibians 364 20-26  
 amplifier 241 40; 312 19; 317 23  
 amplifier, underwater ~ 237 57  
 amplifier and mains power unit 238 3  
 amplifier equipment 310 59  
 amplitude adjustment 10 11  
 amulet 354 40  
 anaesthesia and breathing apparatus 26 1  
 anaesthesia and respiratory apparatus 26 24  
 anaesthetic, local ~ 24 53  
 analog see analogue  
 analogue control 242 38  
 analogue output 112 45  
 analyser 23 53  
 analysis, automatic ~ 25 48  
 analytical balance 349 25  
 anchor 223 52; 259 81  
 anchor, lightweight ~ 286 16-18  
 anchor, stocked ~ 222 79; 286 15

## animals, one-celled

anchor, stockless ~ 222 78; 258 5; 286 17  
 anchorage 216 13  
 anchor cable 218 18; 222 77; 223 50; 227 12  
 anchor capstan 258 6  
 anchor hawser 218 18  
 anchor rib 287 32  
 anchor rope 218 18  
 anchors 286 15-18  
 anchor winch 259 82  
 ancillary brake valve 211 23  
 Andromeda 3 24  
 anemometer 10 28  
 anemone 375 5; 377 1  
 aneroid barometer 10 4  
 aneroid box 10 6  
 aneroid capsule 10 6  
 angiographic examination table 27 26  
 angiography room 27 12  
 angle *Mach. Parts etc.* 143 1  
 angle *Maths.* 346 1-23; 346 8-13, 8, 55  
 angle, acute ~ 346 10  
 angle, adjacent ~ 346 14  
 angle, alternate ~ 346 10  
 angle, circumferential ~ 346 56  
 angle, exterior ~ 346 26  
 angle, interior ~ 346 26  
 angle, obtuse ~ 346 11  
 angle, straight ~ 346 13, 9-15  
 angle brace 118 25; 119 63; 121 57  
 angle deck 259 12  
 angle iron 143 1  
 angle of departure 87 75  
 angle of descent 87 78  
 angle of dip 12 3  
 angle of elevation 87 76  
 angle of rotation 351 33  
 angle of the mouth 16 14; 19 19  
 angle shears 125 2  
 angle symbol 345 23  
 angle tie 118 25; 121 57  
 angle tongs 137 37  
 angle tower 329 14, 17  
 angling 89 20-94  
 angling fence 133 19  
 Angora cat 73 17  
 Angoumois grain moth 81 29  
 Angoumois grain moth caterpillar 81 30  
 Angoumois moth 81 29  
 Anguidae 364 37  
 animal, cloven-hoofed ~ 73 9  
 animal, inflatable ~ 280 33  
 animal, rubber ~ 280 33  
 animal, toy ~ 46 13; 47 6  
 animal, wild ~ 307 56  
 animal enclosure 272 49  
 animal house 356 10  
 animals, domestic ~ 73 18-36  
 animals, fabulous ~ 327 1-61  
 animals, multicellular ~ 357 13-39  
 animals, one-celled ~ 357 1-12



animals, single-celled ~ 357  
 1-12  
 animals, unicellular ~ 357  
 1-12  
 ankle guard 291 33  
 ankle sock, children's ~ 29 30  
 annealing lehr 162 18  
 annelid 357 20  
 annexe 331 13  
 annuity 251 11-19  
 annulus 346 57  
 Annunciation lily 60 12  
 anode, copper ~ 178 5  
 anode rod 178 5  
 anorak *Child. Clothes* 29 62  
 anorak *Mountain* 300 6  
 anorak hood 300 19  
 Anseres 359 15-17  
 ant 358 21-22  
 Antarctica 14 18  
 Antarctic Circumpolar Drift  
 14 44  
 Antarctic Continent 14 18  
 Antarctic Ocean 14 22  
 antelope 367 5  
 antenna *Meteorol. Instr.* 10  
 59, 68  
 antenna *Forest Pests* 82 3  
 antenna *Air Force* 256 17  
 antenna *Warships* 258 16, 46;  
 259 7, 47, 89  
 antenna *Airsports* 288 20, 88  
 antenna *Articulates* 358 27, 53  
 antenna, maxillary ~ 358 42  
 antenna, trichotomous ~ 81 5  
 antenna down-lead 223 4  
 antenna lead-in 223 4  
 antenna mast 259 6  
 antepodium 330 20  
 anther *Soft Fruit* 58 45  
 anther *Drupes & Nuts* 59 10  
 anther *Conifers* 372 35  
 anthozoan 357 17  
 anthropoid apes 368 14-16  
 anthropoids 368 14-16  
 anti-aircraft gun 258 73  
 anti-aircraft gun, automatic  
 ~ 259 34  
 anti-aircraft machine gun  
 255 63  
 anti-aircraft missile launcher  
 258 32; 259 5, 20  
 anti-aircraft rocket launcher  
 258 32; 259 5, 20  
 anticline 12 16, 27  
 anticlinorium 12 20  
 anticollision light 230 64  
 anticyclone 9 6  
 antifriction bearing 143 69  
 anti-frost layer 198 1; 200 60  
 antimacassar 207 48  
 anti-mist windscreen 189 46  
 anti-mist windshield 189 46  
 anti-radiation screen 154 74  
 anti-rolling system 224 26  
 antirrhinum 51 32  
 anti set-off apparatus 181 10  
 anti set-off spray 181 10  
 anti-skate control 241 25  
 anti-skid brake switch 211 33  
 anti-slosh baffle 234 13

anti-submarine missile  
 launcher 258 30, 50  
 anti-submarine rocket  
 launcher 258 30, 50  
 anti-submarine torpedo tube  
 258 33  
 anti-syphon trap *Bathrm. etc.*  
 49 27  
 anti-syphon trap *Plumb. etc.*  
 126 26  
 anti-tank rocket launcher  
 255 25  
 anti-tank tank 255 88  
 anti-torque rotor 232 14  
 anti-vortex system 234 11  
 antler, palmate ~ 88 40  
 antler, royal ~ 88 8  
 antler, surroyal ~ 88 9  
 antlers 88 5-11, 29-31  
 anurans 364 23-26  
 anus 20 62  
 anvil *Plumb.* 125 22  
 anvil *Blacksm.* 137 11, 11-16;  
 138 33  
 anvil *Forging* 139 17, 31, 40  
 anvil *Office* 247 5  
 anvil, clockmaker's ~ 109 7  
 aorta 18 10; 20 54  
 aorta, abdominal ~ 18 16  
 Apache girl 306 9  
 apartment 37 64-68, 69-71;  
 46  
 apartment, ladies' ~ 329 10  
 apartment building 37 72-76  
 apartment building, high-rise  
 ~ 37 82  
 apartment building,  
 multistory ~ 37 77-81  
 apartment house 37 72-76  
 apartment house, high-rise ~  
 37 82  
 apartment house, multistory  
 ~ 37 77-81  
 apatite 351 20  
 aperture 115 62, 63  
 aperture control, automatic ~  
 117 20  
 aperture control ring 115 5;  
 117 4  
 aperture ring 115 5; 117 4  
 aperture seal 115 56  
 aperture setting 117 4  
 aperture-setting control 114  
 34  
 aperture-setting ring 115 5;  
 117 4  
 aperture-stop slide 112 16  
 apex *Hunt.* 87 77  
 apex *Airsports* 288 47  
 apex *Church* 331 5  
 aphid 80 32; 358 13  
 aphid, winged ~ 82 39; 358 15  
 aphid, wingless ~ 358 14  
 apiarist 77 57  
 apiary 77 56  
 apiculture 77  
 à pointe 314 19  
 Apollo booster 234 1, 2  
 Apollo service module 234 56  
 Apollo space capsule 6 9  
 Apollo spacecraft 6 1

apostrophe 342 22  
 apparatus, auxiliary ~ 296  
 12-21; 297 7-14  
 apparatus exercises 297 15-32  
 apparatus gymnastics 296;  
 297  
 appendix 20 18  
 appendix, vermiform ~ 20 18  
 Appenzell dulcimer 322 35  
 apple 58 56; 99 86; 370 102  
 apple blossom 58 54  
 appleblossom weevil 80 10  
 apple core 58 59  
 apple pip 58 60  
 apple skin 58 57  
 apple stalk 58 61  
 apple tree 58 51, 52  
 appliance room 270 1  
 appliqué 29 20  
 appoggiatura 321 14, 15  
 appointments book 22 11  
 appointments diary 246 8  
 approach 329 34  
 approach sign 203 26, 27, 28,  
 29  
 approach signs 203 26-29  
 apricot 59 35  
 apricot blossom 59 34  
 apricot branch, flowering ~  
 59 33  
 apricot flower 59 34  
 apricot leaf 59 36  
 apricot tree 59 33-36  
 apron *Mach. Tools* 149 16  
 apron *Electrotyp. etc.* 178 9  
 apron *Airport* 233 3  
 apron *Theatre* 316 25  
 apron, butcher's ~ 96 39  
 apron, composition ~ 164 16  
 apron, frilled ~ 31 33  
 apron, leather ~ *Arc Weld.*  
 142 11  
 apron, leather ~ *Cotton Spin.*  
 164 16  
 apron taxiway 233 4  
 apse 334 64; 335 5  
 aquafer 12 22; 269 2, 38  
 aqualung 279 19  
 aquarium 356 14, 19  
 Aquarius 4 63  
 aquatint 340 14-24  
 aqueduct 334 53  
 aquifer 12 22; 269 2, 38  
 Aquila 3 9  
 aquilegia 60 10  
 arabesque *Free Exerc.* 295 30  
 arabesque *Ballet* 314 18  
 arachnids 358 40-47  
 araucaria 53 16  
 arbor 272 17  
 arbor vitae 372 39  
 arbour 272 17  
 arc *Films* 312 42  
 arc *Maths.* 346 53, 55  
 arc, graduated ~ 224 2  
 arcade, blind ~ 335 10  
 arcading 335 8  
 arcading, blind ~ 335 10  
 arcading, round ~ 335 9  
 arc fibula 328 28  
 arch *Bldg. Site* 119 6

arch *Bridges* 215 20  
 arch *Free Exerc.* 295 34  
 arch *Theatre* 316 11  
 arch *Art* 336 19  
 arch, convex ~ 336 34  
 arch, longitudinal ~ 19 61  
 arch, parabolic ~ 336 29  
 arch, reinforced concrete ~  
 215 50  
 arch, round ~ 336 27  
 arch, segmental ~ 336 28  
 arch, shouldered ~ 336 33  
 arch, superciliary ~ 16 5  
 arch, tented ~ 336 35  
 arch, transverse ~ 335 18  
 arch, trellis ~ 52 12  
 arch, triumphal ~ 334 59, 71  
 arch, trussed ~ 215 25  
 arch, Tudor ~ 336 37  
 arch, types of ~ 336 19-37  
 Archaster 369 17  
 arch board file 247 40  
 arch bridge, spandrel-braced  
 ~ 215 28  
 arch bridge, stone ~ 215 19  
 arched front support 295 24  
 Archer *Astron.* 3 37; 4 61  
 archer *Sports* 305 53  
 archery 305 52-66  
 archimedes drill 108 4  
 architrave 334 18  
 archivolt 335 25  
 arch span 215 26  
 arch unit 247 41  
 archway 337 4  
 archway, memorial ~ 337 3  
 arcing horn 152 47; 153 61  
 arcossium 331 60  
 Arctic Ocean 14 21  
 arc welder 142 2  
 arc welding, gas-shielded ~  
 142 33  
 arc welding helmet 142 3, 39  
 area, epicentral ~ 11 38  
 area spraying 83 1  
 area 380 19  
 areca nut 380 20  
 areca palm 380 19  
 arena *Equest.* 289 1  
 arena *Circus* 307 21  
 arena *Bullfight. etc.* 319 9  
 arena entrance 307 11  
 areola 16 29  
 argent 254 25  
 Argo 3 45  
 Aries 4 53  
 aril, lacinate ~ 382 34  
 arista 68 12  
 arithmetic 344 1-26; 345 1-24  
 arithmetic unit 244 6  
 arm *Man* 16 43-48; 17 12-14  
 arm *Living Rm.* 42 22  
 arm *Flat* 46 28  
 arm *Shoem.* 100 25  
 arm *Photog.* 115 93  
 arm *Joiner* 132 63  
 arm *Mach. Parts etc.* 143 88  
 arm *Mach. Tools* 150 24  
 arm *Music. Instr.* 322 16  
 arm *Maths.* 346 7-3  
 arm, adjustable ~ 195 26

arm, hydraulic ~ 85 21  
 arm, supplementary ~ 203 22,  
 23  
 arm, upper ~ 16 43  
 armadillo 366 8  
 armament 258 29-37  
 armature 339 25  
 armature support 339 24  
 armband 263 11; 270 22  
 armband, fluorescent ~ 199 7  
 arm bandage 21 1  
 arm bar 299 10  
 armchair 42 21; 267 26  
 armed forces 255; 256; 257  
 armlet 263 11; 270 22  
 armonie 322 25  
 armor *see* armour  
 armour 329 38, 62  
 armour, knight's ~ 329 38-65  
 armour, padded ~ 353 38  
 armour, steel tape ~ 153 50  
 armour, steel wire ~ 153 50  
 armoured car 264 16  
 armoured vehicles 255 79-95  
 armour plating 246 24  
 armpit 16 26  
 armpit hair 16 27  
 arm positions 314 7-10  
 armrest 106 18; 109 3; 207 45,  
 69; 208 26  
 arm sling 21 2  
 arms of the baron 254 10  
 arms of the family of the  
 femme 254 11-13  
 arms of the family of the wife  
 254 11-13  
 arms of the husband 254 10  
 armstand dive 282 45  
 army 255  
 army weaponry 255 1-98  
 arnica 380 2  
 A road 15 83  
 arolla pine 372 29  
 arpeggio 321 22  
 arrangement of desks 260 1  
 arrester 152 35  
 arrester wire 259 16  
 arris 121 12  
 arris fillet 121 31  
 'arrivals' 233 26  
 arrivals and departures board  
 204 18  
 arrival schedule 204 19  
 arrival timetable 204 19  
 arrow 305 60  
 arrow head *Drawing Off.* 151  
 26  
 arrow head *Alp. Plants etc.*  
 378 51  
 art 333; 334; 335; 336; 337  
 art, Babylonian ~ 333 19-20  
 art, Baroque ~ 336 1-8  
 art, Byzantine ~ 334 72-75  
 art, Chinese ~ 337 1-6  
 art, computer-generated ~  
 248 19  
 art, Early Christian ~ 334  
 61-71  
 art, Egyptian ~ 333 1-18  
 art, Etruscan ~ 334 49-52  
 art, Gothic ~ 335 22-41

art, Greek ~ 334 1-48  
 art, Indian ~ 337 19-28  
 art, Islamic ~ 337 12-18  
 art, Japanese ~ 337 7-11  
 art, Renaissance ~ 335 42-54  
 art, Rococo ~ 336 9-13  
 art, Roman ~ 334 53-60  
 art, Romanesque ~ 335 1-21  
 art director 310 43  
 artery, carotid ~ 18 1  
 artery, femoral ~ 18 19  
 artery, frontal ~ 18 5  
 artery, iliac ~ 18 17  
 artery, pulmonary ~ 18 11; 20  
 55  
 artery, radial ~ 18 21  
 artery, subclavian ~ 18 7  
 artery, temporal ~ 18 3  
 artery, tibial ~ 18 20  
 artery forceps 26 49  
 arthropods 358 1-23  
 articulates 358  
 artillery weapons 255 49-74  
 artist 338 2  
 artistes, travelling ~ 308  
 25-28  
 Art Nouveau easy chair 336 18  
 art of Asia Minor 333 37  
 art of the Assyrians 333 29-36  
 art of the Persians 333 21-28  
 arts section 342 67  
 ascent, vertical ~ 315 3  
 ascent stage 6 37-47  
 ascospore 381 13  
 ascus 381 12, 13  
 ash box door 38 39  
 ashpan 210 6, 7  
 ash pit 152 8  
 ashtray 42 29; 104 5; 207 46,  
 69; 208 29; 246 33  
 ashtray, spherical ~ 266 5  
 ash tree 371 38  
 Asia 14 16  
 asp 364 41  
 asparagus 57 14  
 asparagus bed 52 25  
 asparagus cutter 56 10  
 asparagus knife 56 10  
 asparagus patch 52 25  
 asparagus server 45 77  
 asparagus slice 45 77  
 aspen 371 21  
 aspergillum 332 54  
 asphalt drying and mixing  
 plant 200 48  
 asphalt mixer drum 200 50  
 asphalt-mixing drum 200 50  
 aspiration psychrometer 10 33  
 asp viper 364 41  
 assay balance 108 35  
 assembler 174 23  
 assembling machine 249 59  
 assembling station 249 60  
 assembly of a circuit 242 72  
 assembly point *Airport*  
 233 11  
 'assembly point' *Airport*  
 233 29  
 assistant *Univ.* 262 7  
 assistant *Store* 271 63  
 assistant *Circus* 307 39



assistant, cellarer's ~ 79 12  
 assistant, dentist's ~ 24 18  
 assistant, doctor's ~ 22 19  
 assistant cameraman 310 42  
 assistant director *Films* 310 21, 46  
 assistant director *Theatre* 316 43  
 assistant producer 316 43  
 assistant professor 262 3  
 assistant sound engineer 310 57  
 association flag 286 6, 9  
 association football 291  
 asterisk 185 61  
 asteroids 4 47  
 astride jump 295 35, 37  
 astronaut 6 11; 235 67  
 astronomy 3; 4; 5  
 asymmetric bars 297 3  
 asymptote 347 29  
 athletics 298  
 Atlantic Ocean 14 20  
 Atlas 334 36  
 atmosphere 7  
 atoll 13 32  
 Atolla 369 5  
 atom 1; 2  
 atomic pile casing 259 67  
 atomic power plant 154 19  
 atom layer 7 32  
 atom models 1 1-8  
 atrium *Man* 20 45  
 atrium *Art* 334 66  
 attachment to Orbiter 235 49  
 attack 321 27  
 attack area 293 64  
 attacker *Ball Games* 292 3  
 attacker *Fencing* 294 5  
 attacking fencer 294 5  
 attack line 293 65  
 attack periscope 259 88  
 attic 38 1-29, 18; 334 60  
 attitude 314 17  
 attitude control rocket 234 38  
 aubretia 51 7  
 auction room 225 58  
 audience 263 8  
 audio cassette 242 17  
 audio coding equipment 242 11-14  
 audio head 243 35  
 audio level control 117 16  
 audio recording level control 243 11  
 audio sync head 243 24  
 audio systems 241  
 audio track 243 32  
 audio typist 248 33  
 audiovision 243  
 audio-visual camera 243 1-4  
 audio-visual projector 242 16  
 auditorium 315 14-27, 16-20  
 auditorium lighting control 312 17  
 auger *Agr. Mach.* 64 6, 25  
 auger *Carp.* 120 65  
 augmented triad 321 4  
 auk 359 13  
 aulos 322 3  
 aulos pipe 322 4

aural syringe 22 74  
 aureus 252 3  
 auricle 17 56; 20 24  
 auricula 378 8  
 Auriga 3 27  
 auriscope 22 74  
 aurora 7 30  
 Australia 14 17  
 Australopithecus 261 20  
 auto 191 1-56; 195 34  
 autoclave 170 12, 33  
 autofocus override switch 117 11  
 automatic flight control panel 235 23  
 automatic-threading button 117 83  
 automobile 191 1-56; 192; 193; 195 34  
 automobile models 193 1-36  
 automobile tire 191 15; 196 27  
 automotive mechanic 195 53  
 autopilot 224 18  
 auto-soling machine 100 2  
 auxiliaries 258 92-97  
 auxiliary brake valve 211 23  
 auxiliary-cable tensioning mechanism 214 48  
 auxiliary engine room 223 70; 259 56  
 auxiliary parachute bay 235 59  
 AV 243  
 avalanche 304 1  
 avalanche forest 304 7  
 avalanche gallery 304 3  
 avalanche wall 304 2  
 avalanche wedge 304 2  
 Ave Maria 332 32  
 avenue 274 11  
 aviary 356 8  
 aviation fuel 145 57  
 avionics bay, front ~ 257 11  
 avionics bay, rear ~ 257 18  
 avionics console 235 22  
 awn 68 12  
 awner 64 10  
 awning *Dwellings* 37 71  
 awning *Ship* 218 15; 221 116  
 awning *Camping* 278 28, 37  
 awning crutch 218 14  
 ax *see* axe  
 axe 85 1; 120 73; 270 43  
 axe, bronze ~ 328 23  
 axe, socketed ~ 328 23  
 axial-flow pump 217 47-52  
 axis *Astron.* 4 22  
 axis *Maths.* 347 17  
 axis, anticlinal ~ 12 17  
 axis, celestial ~ 4 10  
 axis, conjugate ~ 347 24  
 axis, coordinate ~ 347 2-3  
 axis, earth's ~ 4 22-28  
 axis, floral ~ 370 53  
 axis, lateral ~ 230 68  
 axis, longitudinal ~ 230 72  
 axis, major ~ 347 23  
 axis, minor ~ 347 24  
 axis, normal ~ 230 70  
 axis, polar ~ 113 15, 18

axis, synclinal ~ 12 19  
 axis, transverse ~ 347 23  
 axis, vertical ~ 230 70  
 axis mount, English-type ~ 113 22  
 axis mounting, English-type ~ 113 22  
 axis of abscissae 347 2  
 axis of ordinates 347 3  
 axis of rotation, instantaneous ~ 4 25  
 axis of rotation, mean ~ 4 27  
 axis of symmetry *Maths.* 346 25  
 axis of symmetry *Crystals* 351 4  
 axle 187 61, 76, 81  
 axle, coupled ~ 210 36  
 axle, floating ~ *Agr. Mach.* 65 33  
 axle, floating ~ *Motorcycle* 189 34  
 axle, live ~ 192 65-71  
 axle, rigid ~ 192 65-71  
 axle bearing 210 10  
 axle drive shaft 201 13  
 azalea 53 12  
 azimuth 87 74  
 azure *Heraldry* 254 28  
 azure *Colour* 343 6

## B

baboon 368 13  
 baby 28 5  
 baby bath 28 3  
 baby carriage 28 34; 272 71; 273 31  
 baby clothes 29 1-12  
 baby doll 48 25  
 baby grand piano 325 40  
 baby pants 28 22  
 baby pants, rubber ~ 29 10  
 baby powder 28 14  
 baby scales 22 42  
 back *Man* 16 22-25  
 back *Tablew. etc.* 45 56  
 back *Horse* 72 29  
 back *Mills* 91 2  
 back *Roof* 122 86  
 back *Bookbind.* 185 41  
 back *Car* 193 35  
 back *Swim.* 282 49  
 back *Ball Games* 293 77  
 back *Sports* 305 11  
 backband 71 19  
 backboard 292 30  
 backbone *Man* 17 2-5  
 backbone *Bookbind.* 185 41  
 back check 325 27  
 back check felt 325 28  
 backcloth 315 33; 316 10  
 back comb 105 6  
 back crease 292 71  
 back cushion 42 25  
 back cut 84 29  
 backdrop 315 33; 316 10  
 backdrop light 316 15  
 back fat 95 40  
 backfilling 217 7

back flip 297 24  
 backgammon 276 18  
 backgammon board 276 22  
 back gauge 183 17; 185 4, 7  
 background *Films* 310 33  
 background *Theatre* 316 10  
 backhand stroke 293 39  
 backing 269 29  
 backing disc, rubber ~ 134 22  
 backing paper *Photog.* 114 21  
 backing paper *Paperhanger* 128 5  
 back left second pin 305 9  
 back loop 288 50  
 back of the hand 19 83  
 backpack unit 6 20  
 back-pedal brake 187 63  
 back pin 305 11  
 back plate 140 36  
 back-pressure valve, hydraulic ~ 141 8  
 backrest *Weaving* 166 37  
 backrest *Railw.* 207 66  
 backrest, reclining ~ 191 35  
 back right second pin 305 10  
 back scouring valve 216 61  
 backside 16 40  
 back sight leaf 87 67  
 back sight slide 87 69  
 back standard adjustment 114 55  
 backstay 219 19  
 backstitch seam 102 1  
 back support 295 22; 296 29  
 back-up ball 305 20  
 back vault 297 32  
 backward grand circle 296 60  
 backward somersault *Swim.* 282 42  
 backward somersault *Gymn.* 297 15  
 backward underswing 296 59  
 backward walkover 297 23  
 backwater 172 26  
 bacon 96 2  
 Bactrian camel 366 29  
 badge, fool's ~ 306 60  
 badger 88 48  
 badging 191 12  
 badminton 293 43-44  
 badminton game 273 6  
 badminton racket 293 43  
 badminton racquet 293 43  
 baffle board *Warships* 259 27  
 baffle board 309 17  
 baffle board, hinged ~ 259 15  
 baffle board, movable ~ 259 15  
 bag *Doc.* 22 33  
 bag *Hunt.* 86 38  
 bag *Music. Instr.* 322 9  
 bag, girl's ~ 29 56  
 bag, heat-sealed ~ 76 29  
 bag, paper ~ 98 48  
 bag, postman's ~ 236 54  
 bag filter 83 54  
 bag-full indicator 50 61, 73  
 baggage compartment 257 19  
 baggage loader 233 22  
 baggage man 267 17  
 'baggage retrieval' 233 38

baggage terminal 233 5, 16  
 bagging nozzle 83 55  
 bag net 77 54  
 bagpipe 322 8  
 bag sealer 40 47  
 baguette 97 12  
 bag wig 34 4  
 bail 292 70  
 bailey, inner ~ 329 2  
 bailey, outer ~ 329 31  
 bait 86 21  
 bait, poisoned ~ 83 31  
 bait, weighted ~ 89 36  
 bait needle 89 41  
 baits 89 65-76  
 bait tin 89 24  
 bakehouse 97 55-74  
 baker's shop 97 1-54  
 bakery 97 55-74  
 baking ingredient 99 62  
 baking ingredients 98 8-11  
 balalaika 324 28  
 Balance *Astron.* 3 19; 4 59  
 balance *Papern.* 173 9  
 balance beam 349 30  
 balance cable 214 46  
 balance cable sleeve 214 74  
 balance column 349 29  
 balancer 307 48  
 balance rail 322 39  
 balance weight 242 50  
 balance wheel 110 39  
 balancing act 307 44  
 balancing cabins 214 25  
 balancing knob 116 39  
 balancing pole 307 42  
 balcony *Dwellings* 37 18, 69, 73  
 balcony *Theatre* 315 16; 315 18  
 balcony *Chivalry* 329 12  
 balcony, projecting ~ 218 57  
 baldachin 331 49  
 baldquin 331 49  
 bald patch 34 21  
 bale 55 31; 63 34; 75 7; 83 13; 169 34; 170 62; 206 10, 11, 23  
 bale arm 89 62  
 bale breaker 163 7  
 bale loader, hydraulic ~ 63 37  
 bale opener 163 7  
 baler, high-pressure ~ 63 35  
 baling press 169 33  
 balk 63 3  
 ball *Infant Care etc.* 28 16  
 ball *Bicycle* 187 31  
 ball *Aircraft* 230 12  
 ball *Ball Games* 292 27  
 ball *Circus* 307 60  
 ball, ivory ~ 277 1  
 ball, metal ~ 352 32  
 ball, paper ~ 306 55  
 ball, plastic ~ 277 1  
 ball, steel ~ 143 70  
 ball, stone ~ 352 32  
 ball and socket head 114 47  
 ballast *Station* 205 61  
 ballast *Railw.* 212 66  
 ballast *Sailing* 285 33  
 ballast *Airports* 288 65

ballast keel 285 32  
 ballast tank 223 78  
 ball bearing 143 69; 187 56, 68  
 ball boy 293 22  
 ballerina 314 26  
 ballet 314  
 ballet dancer 314 26  
 ballet positions 314 1-6  
 ballet shoe 314 30  
 ballet skirt 314 31  
 ballet slipper 314 30  
 ball games 291; 292; 293  
 ballistics 87 73  
 ball mill 161 1  
 ball of clay 161 9  
 ball of the foot 19 58  
 ball of the thumb 19 75  
 balloon 308 13  
 balloon, gas ~ 288 63  
 balloon, hot-air ~ 288 79  
 balloon, manned ~ 7 16  
 balloon basket 288 64  
 ballooning 288 63-84  
 ballot box 263 29  
 ballot envelope 263 21  
 ballot paper 263 20  
 ball race 187 68  
 ballroom 306 1  
 Balmer series 1 21  
 baluster 38 29; 123 51  
 balustrade 38 25; 123 22, 50  
 bamboo cane 136 31  
 bamboo culm 383 60  
 bamboo stem 383 60, 63  
 banana 99 90; 384 33  
 banana flower 384 34  
 banana-handling terminal 226 22  
 banana leaf 384 35  
 banana plant 384 28  
 banana saddle 188 59  
 banana tree 384 28  
 band *Ball Games* 291 25  
 band *Nightclub* 318 3  
 band *Church* 332 5  
 band, fluorescent ~ 199 8  
 band, iron ~ 130 16  
 band, ornamental ~ 334 38  
 band, steel ~ 163 5  
 bandage *First Aid* 21 9  
 bandage *Equest.* 289 15  
 bandages, emergency ~ 21 1-13  
 band brake 143 104  
 banderilla 319 22  
 banderillero 319 4, 21  
 band of barrel 130 8  
 bandoneon 324 36  
 bandora 322 21  
 bandsaw 134 50; 157 48  
 bandsaw, horizontal ~ 157 48  
 bandsaw blade 157 53  
 bandstand 274 19; 307 9  
 band wheel 104 15  
 bandwheel cover 133 32  
 banewort 379 7  
 banger 306 51  
 bangle *Jewell.* 36 17  
 bangle *Ethnal.* 354 38  
 bangle, asymmetrical ~ 36 26



bangs 34 36  
 banjo 324 29  
 bank *Phys. Geog.* 13 4  
 bank *Post* 237 43  
 bank *Bank* 250  
 bank *Roulette* 275 11  
 bank acceptance 250 12  
 bank branch 204 31  
 bank clerk 250 5  
 bank employee 251 7  
 banknotes 252 29-39  
 bank of circulation 252 30  
 bank of issue 252 30  
 bank of oars 218 12  
 bank protection 216 51-55  
 bank slope 217 28  
 bank stabilization 216 51-55  
 bank statement 247 44  
 banner *Flags* 253 12  
 banner *Election* 263 12  
 banner, processional ~ 331 44  
 banquet room 267 39  
 bantam 74 56  
 baptism, Christian ~ 332 1  
 baptistery 332 2  
 bar *Horse* 71 41  
 bar *Office* 246 29  
 bar *Restaurant* 266 1-11  
 bar *Hotel* 267 54  
 bar *Park* 272 34  
 bar *Playground* 273 32  
 bar *Gymn.* 296 3, 8; 297 4, 41  
 bar *Athletics* 298 14, 34  
 bar *Winter Sp.* 303 5  
 bar *Circus* 307 50  
 bar *Disco* 317 1, 9  
 bar *Nightclub* 318 13, 15  
 bar *Music. Not.* 320 42  
 bar *Graphic Art* 340 34  
 bar, flat ~ 143 10  
 bar, metal ~ 324 77  
 bar, round ~ 143 8  
 bar, sliding ~ 75 21  
 bar arm 299 10  
 barb *Bees* 77 10  
 barb *Fish Farm.* 89 80  
 barb *Mach. Parts etc.* 143 44  
 barbecue 278 47  
 barbel 364 13  
 bar bender 119 21  
 barber 106 1  
 barber's shop 106 1-42  
 barchan 13 40  
 barchane 13 40  
 bar customer 267 55  
 bareback rider 307 26  
 barge 216 22, 25; 225 8  
 barge and push tug assembly 221 92  
 bargeboard 37 8  
 bargee 216 26  
 bargeman 216 26  
 barge sucker 216 59  
 bark *Carp.* 120 86  
 bark *Ship* 219 1-72; 220 21-23  
 bark *Bot.* 370 8  
 bark, five-masted ~ 220 32-34  
 bark, four-masted ~ 220 29  
 bark beetle 82 22  
 bark brush 56 23  
 barkeep 266 8; 267 62  
 barkeeper 266 8; 267 62  
 barker 308 8, 64  
 barkhan 13 40  
 barking 85 23  
 barking iron 85 8  
 bark schooner 220 20  
 bark scraper 56 14  
 bark spud 85 8  
 bark stripping 85 23  
 bar lamp 317 11  
 barley 68 1, 26  
 barley, germinated ~ 92 23  
 barley elevator 92 33  
 barley hopper 92 2  
 barley reception 92 41  
 barley silo 92 31  
 bar line 320 42  
 barmaid 267 63; 317 2; 318 14  
 barman 266 8; 267 62  
 barn owl 362 17  
 barn swallow 361 20  
 barograph 10 4  
 barouche 186 35  
 barque 219 1-72; 220 21-23  
 barque, five-masted ~ 220 32-34  
 barque, four-masted ~ 220 29  
 barque schooner 220 20  
 barrage 217 57-64, 65-72  
 barrel *Cooper* 130 5  
 barrel *Mach. Tools* 149 27  
 barrel *Army* 255 2, 17, 41  
 barrel, aluminium ~ 93 17  
 barrel, rifled ~ 87 26  
 barrel, semi-oval ~ 89 3  
 barrel, smooth-bore ~ 87 27  
 barrel casing 87 35; 255 33  
 barrel clamp 255 11, 62  
 barrel-clamping nut 255 11  
 barrel cradle 255 60  
 barrelhead 130 10  
 barrel organ 309 13  
 barrel recuperator 255 61  
 barrel-shape 36 75  
 barrel-shape, standard ~ 36 56  
 barrel stave 130 9  
 barrel store 93 16  
 barrel vault 335 19; 336 38  
 barricade 264 17  
 barrier *Supermkt.* 99 5  
 barrier *Railw.* 202 40  
 barrier *Hydr. Eng.* 217 65  
 barrow *Station* 205 32  
 barrow *Prehist.* 328 16  
 barrow, road sweeper's ~ 199 9  
 barrow, street sweeper's ~ 199 9  
 bars 75 5  
 bar set 246 30  
 bar stool 267 53; 317 3; 318 16  
 bartender 266 8; 267 62  
 bar trio 267 44  
 barysphere 11 5  
 basal pinacoid 351 20  
 base *Dining Rm.* 44 23  
 base *Mills* 91 33

base *Optic. Instr.* 112 3; 113 2  
 base *Floor etc. Constr.* 123 21, 63  
 base *Bookbind.* 183 25  
 base *Road Constr.* 200 59  
 base *Heraldry* 254 22-23  
 base *Mountain.* 300 1  
 base *Art* 334 28-31  
 base *Maths.* 345 1, 6; 346 27; 347 35, 39  
 base, horizontal ~ 112 72  
 base, round ~ *Hairdresser* 105 27  
 base, round ~ *Basketm.* 136 19  
 base, round ~ *Electrotyp. etc.* 178 10  
 base, woven ~ 136 20  
 baseball 292 40-69, 61  
 baseball glove 292 59-60  
 baseball mitt 292 59-60  
 baseboard *Photog.* 116 27  
 baseboard *Sculpt. Studio* 339 23  
 base course *Dwellings* 37 17  
 base course *Carp.* 120 28  
 base course *Street Sect.* 198 3  
 base course *Road Constr.* 200 59  
 base course, concrete ~ 118 2  
 base course, natural stone ~ 37 85  
 base frame 177 40  
 base line 292 48; 293 3-10, 72  
 base line judge 293 26  
 baseman 292 44  
 basement 37 1; 118 1  
 basement stairs 123 16  
 basement wall 123 1  
 basement window 37 27; 118 3  
 base of goblet 162 42  
 base of machine 168 54  
 base of statue 272 11  
 base of support 214 81  
 base plate *Optic. Instr.* 112 27  
 base plate *Iron Foundry etc.* 148 56  
 base plate *Mach. Tools* 150 19  
 base plate *Knitting* 167 34  
 base plate *Railw.* 202 5  
 base plate *Army* 255 46  
 base plate *Ball Games* 292 67  
 base unit 39 9  
 basic knits 171 30-48  
 basic position 295 1  
 basidia 381 7  
 basidiospore 381 8  
 basilica 334 61  
 basilisk *Fabul. Creat.* 327 34  
 basilisk *Fish etc.* 364 30  
 basin *Doc.* 23 25  
 basin *Dent.* 24 12  
 basin *Park* 272 24  
 basis weight 173 9  
 basket *Kitch. Utensils* 40 42  
 basket *Butch.* 96 18  
 basket *Supermkt.* 99 8  
 basket *Basketm.* 136 16  
 basket *Station* 204 3  
 basket *Ball Games* 292 32  
 basket *Winter Sp.* 301 8  
 basket, rotating ~ 168 17  
 basket, wicker ~ 305 69  
 basket, wire ~ 55 50; 66 25; 188 23  
 basketball 292 28, 29  
 basketball player 292 35  
 basket handle 336 28  
 basket maker 136 33  
 basket making 136 1-40  
 basket post 292 31  
 basket ring 292 33  
 basketry 136 1-40  
 basket weave 171 11  
 basketwork 136 1-40, 16  
 bas-relief 339 33  
 bass 323 23  
 bass belly bridge 325 13  
 bass bridge 325 13  
 bass button 324 43  
 bass clarinet 323 34  
 bass clef 320 9  
 bass coupler 324 44  
 bass drum 323 55; 324 47  
 bassinet 28 30  
 bassinet covers 28 31  
 bassoon 323 28  
 bass press-stud 324 43  
 bass register 324 44  
 bass side 324 43  
 bass stop 324 44  
 bass string 324 25; 325 12  
 bass stud 324 43  
 bass trombone 323 46  
 bass tuba 323 44  
 bass tuning 241 43  
 bass viol 322 23  
 bast 136 29  
 bastard title 185 44  
 bastion 329 16  
 bat 292 62, 75  
 batch 162 2  
 batch feeder 162 13  
 batch funnel 162 13  
 batching and mixing plant, automatic ~ 201 19  
 batch of eggs 80 2, 30  
 bath *Bathrm. etc.* 49 1  
 bath *Hotel* 267 27-38  
 bath *Swim.* 281 36  
 bath, cold ~ 281 30  
 bat handle 293 46  
 bather 280 30  
 bathing beach 280  
 bathing cap 280 29, 44; 281 8  
 bathing gown 280 25  
 bathing platform 280 9  
 bathing shoe 280 23  
 bathing suit 280 42  
 bathing suit, two-piece ~ 280 26  
 bathing towel 281 14  
 bathing trunks 280 43  
 bathing wrap 280 25  
 bath mat 49 48  
 batholite 11 29  
 bath robe 29 24  
 bathroom 49  
 bathroom cabinet, mirrored ~ 49 31

bathroom mule 49 46  
 bathroom scales 49 47  
 bathroom tissue 49 11  
 bathroom tissue holder 49 10  
 bath salts 49 5; 99 34  
 bath sponge *Bathrm. etc.* 49 6  
 bath sponge *Invertebr.* 357 13  
 bat of clay 161 9  
 baton 264 19  
 baton, conductor's ~ 315 27  
 batrachians 364 23-26  
 batsman 292 74  
 batten *Roof* 122 17  
 batten *Sailing* 284 44  
 batten, compartmentalized ~ 316 13  
 batten, compartment-type ~ 316 13  
 batten cleat 284 43  
 batten door 37 34  
 batten gauge 122 18  
 batten pocket 284 43  
 batter 292 52, 63  
 batterboard 118 69  
 batter's position 292 51  
 battery *Agr. Mach.* 65 53  
 battery *Poultry Farm* 74 19  
 battery *Photog.* 114 66  
 battery *Car* 191 50  
 battery *Warships* 259 83  
 battery, rotary ~ 166 5  
 battery box 207 5, 25; 211 56  
 battery cage 74 20  
 battery cell 110 7  
 battery chamber *Photog.* 115 10  
 battery chamber *Cine Film* 117 5  
 battery compartment 188 22  
 battery container 207 5, 25; 211 56  
 battery feeding 74 23  
 battery holder 115 76  
 battery housing 257 17  
 battery railcar 211 55  
 battery switch 115 13  
 battery system 74 18  
 battery tester 25 52  
 battery unit 115 75  
 batting crease 292 72  
 batting order 292 58  
 battle axe 352 16  
 battle axe, stone ~ 328 19  
 battlement 329 6  
 battleships, light ~ 258 1-63  
 bauble 306 59  
 baulk *Agr.* 63 3  
 baulk *Carp.* 120 87  
 baumkuchen 97 46  
 Bavarian curler 302 38  
 Bavarian curling 302 38-40  
 bay *Phys. Geog.* 13 7  
 bay *Game* 88 7  
 bay *Carp.* 120 59  
 bayadère 306 25  
 bay antler 88 7  
 bayonet 353 28  
 bayonet fitting 127 65, 69  
 B-deck 223 32-42  
 beach 13 35-44  
 beach, raised ~ 11 54

beach area 281 2  
 beach attendant 280 34  
 beach bag 280 24  
 beach ball 280 18  
 beach chair, roofed ~ 280 36  
 beach chair, wicker ~ 280 36  
 beach grass 15 7  
 beach hat 280 20  
 beach jacket 280 21  
 beach marten 367 14  
 beach mattress, inflatable ~ 280 17  
 beach shoe 280 23  
 beach suit 33 24; 280 19  
 beach tent 280 45  
 beach trousers 280 22  
 beachwear 280 19-23.  
 beacon 15 10, 49  
 bead 87 72  
 bead-and-dart moulding 334 38  
 beading 123 64  
 beading hammer 125 15  
 beading iron 125 8  
 beading pin 128 30  
 beading swage 125 15  
 beak 88 84  
 beak, flat ~ 137 12  
 beak, hooked ~ 362 6  
 beak, round ~ 137 13  
 beaker 350 20  
 beaker pottery 328 14  
 beam *Agr. Mach.* 65 9, 71  
 beam *Game* 88 11, 30  
 beam *Carp.* 120 19, 24  
 beam *Gymn.* 297 2  
 beam *Music. Instr.* 325 22  
 beam *Chem.* 349 30  
 beam, central ~ 273  
 beam, dipped ~ 191 20  
 beam, high ~ 191 20  
 beam, low ~ 191 20  
 beam, main ~ *Carp.* 120 38  
 beam, main ~ *Roof* 121 66  
 beam, main ~ *Car* 191 20  
 beam, tied ~ 215 44  
 beam bridge 215 7  
 beam compass 125 11  
 beam compass, glazier's ~ 124 22  
 beam entry point 1 64  
 beam flange 165 30; 166 49; 167 26  
 beam head 121 33  
 beaming machine 165 55  
 beam motion control 166 60  
 beam of light 224 83  
 beam setter 195 24  
 beam splitter 240 35  
 beam-splitting prism *Optic. Instr.* 112 13  
 beam-splitting prism *Broadcast.* 240 35  
 beam trammel 125 11  
 bean 57 8, 11  
 bean, bush ~ 57 8  
 bean, climbing ~ 57 8  
 bean flower 57 9  
 bean plant 52 28; 57 8  
 bean pole 52 28  
 beanstalk 57 10



bearberry 377 15  
 beard *Arable Crops* 68 12  
 beard *Dom. Anim.* 73 15  
 beard *Game* 88 73  
 beard, circular ~ 34 15  
 beard, full ~ 34 15  
 beard, round ~ 34 15  
 bearded couch grass 61 30  
 beards 34 1-25  
 bearer cable 119 37; 271 52  
 bearer share 251 11  
 bearing, axial-radial ~ 113 3  
 bearing, centre ~ 177 65  
 bearing, fixed ~ 215 11  
 bearing, hydrostatic ~ 5 10  
 bearing, jewelled ~ 110 33  
 bearing, lower ~ 192 83  
 bearing, main ~ 192 23  
 bearing, movable ~ *Bridges* 215 12  
 bearing, movable ~ *Sailing* 284 6  
 bearing, upper ~ 192 73  
 bearing block 177 61  
 bearing cup 187 68  
 bears 368 9-11  
 beasts of prey 367 11-22; 368 1-11  
 beater *Hunt.* 86 37  
 beater *Bakery* 97 70  
 beater *Music. Instr.* 322 34; 324 64  
 beater, revolving ~ 64 13  
 beater, three-blade ~ 163 25  
 beater drive motor 163 23  
 beater driving shaft 163 24  
 beating 86 34-39  
 beating machine 131 4  
 beating wood 339 12  
 beauty parlor 105 1-39  
 beauty queen 306 64  
 beauty salon 105 1-39  
 beauty shop 105 1-39  
 beauty spot 306 24  
 beaver *Chivalry* 329 41  
 beaver *Mammals* 366 14  
 beck, flat ~ 137 12  
 beck, round ~ 137 13  
 bed *Phys. Geog.* 13 49  
 bed *Hosp.* 25 10  
 bed *Joiner* 133 50  
 bed *Mach. Tools* 150 19, 29  
 bed *Offset Print.* 180 78  
 bed *Letterpress* 181 17  
 bed *Bookbind.* 183 25  
 bed *Station* 205 61  
 bed *Graphic Art* 340 41, 64  
 bed, children's ~ 47 1  
 bed, double ~ 43 4-13; 267 38  
 bed, rear ~ 85 49  
 bed bug 81 39  
 bedder 91 23  
 bed frame 43 5  
 bed linen 271 57  
 Bedlington terrier 70 18  
 bed monitor 25 19  
 bedouin 354 6  
 bedrock 13 70  
 bedroom 43  
 bedroom, twin-berth 207 38  
 bedroom, two-berth ~ 207 38

bedroom, two-seat ~ 207 38  
 bedroom lamp 43 19  
 bedside cabinet 43 17  
 bedside rug 43 22  
 bed slide 149 24  
 bedspread 43 7  
 bedstead 43 4-6  
 bed stone 91 23  
 beduin 354 6  
 bed unit 46 16  
 bed unit drawer 46 18  
 bed unit shelf 46 19  
 bed warmer 309 88  
 bee 77 1-25  
 bee, male ~ 77 5  
 beech cellulose 169 1  
 beech gall 82 37  
 beech nut 371 37  
 beech tree 371 33  
 bee eater 360 2  
 beef 95 14-37  
 beehive 77 45-50  
 beehive kiln 161 3  
 bee house 77 56  
 beekeeper 77 57  
 beekeeping 77  
 beeman 77 57  
 beer 99 72  
 beer, bottled ~ 93 26  
 beer, canned ~ 99 73  
 beer barrel 93 17  
 beer bottle 93 26; 205 50  
 beer can 93 25  
 beer crate 93 24  
 beer filter 93 15  
 beer glass 45 91; 93 30; 266 3, 6; 317 6  
 beer marquee 308 23  
 beer mat 266 26  
 beer mug 266 6; 309 53  
 beerpull 266 1, 68  
 beer pump 266 1, 68  
 beer tap 317 8  
 beer warmer 266 7  
 bees 77  
 bee shed 77 51  
 bee smoker 77 59  
 bee sting ointment 77 68  
 beeswax 77 67  
 beet 68 44, 45  
 beet carrion beetle 80 45  
 beet cleaner 64 89  
 beet elevator 64 94  
 beet elevator belt 64 95  
 beet harvester 64 85-96  
 beet hopper 64 96  
 beetle 82 26, 42  
 beet leaf 68 47  
 beetles 358 24-39  
 beet top 68 46  
 bee veil 77 58  
 begonia 53 10  
 begonia, tuberos ~ 51 19  
 belay 300 9, 10  
 belayer 300 26  
 bellfry window 331 8  
 bell *Plumb. etc.* 126 16  
 bell *Iron & Steel* 147 6  
 bell *Railw.* 212 49  
 bell *Navig.* 224 75  
 bell *Election* 263 4

bell *Winter Countr.* 304 26  
 bell *Music. Instr.* 323 37, 42, 48; 324 70  
 bell, electric ~ 127 15  
 bell, electrically operated ~ 331 9  
 belladonna 379 7  
 Bellatrix 3 13  
 bell beaker 328 14  
 bell boy 267 18  
 bell end 278 27  
 bellows *Photog.* 114 53; 116 31  
 bellows *Photomech. Reprod.* 177 10, 26  
 bellows *Camping* 278 49  
 bellows *Flea Market* 309 26  
 bellows *Music. Instr.* 322 58; 324 37  
 bellows pedal 325 46  
 bellows strap 324 38  
 bellows unit 115 85  
 bell push 127 2  
 bells 276 45  
 bell sleeve, pleated ~ 30 54  
 bell tent 278 8  
 bell tower 337 8  
 beer 99 72  
 belly *Sea Fish.* 90 20  
 belly *Meat* 95 39, 41  
 belly *Music. Instr.* 323 24; 324 3  
 belly-band 71 36  
 belt 30 11; 31 10; 32 39  
 belt, coloured ~ 299 15  
 belt, flat ~ 163 49  
 belt, stretch ~ 31 63  
 belt buckle 31 12  
 belt-changing flap 255 35  
 belt conveying 144 40  
 belt conveyor 156 2  
 belt delivery 185 13  
 belt drive 165 33  
 belt guard 133 31  
 beltline 270 45  
 belt roller 133 18  
 belt-tensioning lever 133 16  
 bench *Goldsm. etc.* 108 20  
 bench *Plumb.* 125 10  
 bench *Blacksm.* 137 21  
 bench *Metalwkr.* 140 7  
 bench *Playground* 273 58  
 bench *Gymn.* 296 14  
 bench, collapsible ~ 134 41  
 bench, oarsman's ~ 278 17  
 bench, paperhanger's ~ 128 31  
 bench, pupil's ~ 261 11  
 bench, student's ~ 261 11  
 bench, teacher's ~ 261 3  
 bench, tiered ~ 281 20  
 bench, woodworker's ~ 132 29-37  
 bench apron 108 21  
 bench brush 108 33  
 bench covering 141 16  
 bench holdfast 132 36  
 bench stop 132 36  
 bench top 132 34  
 bench torch 350 9  
 bend 126 46  
 bending iron *Bldg. Site* 119 77

bending iron *Blacksm.* 137 39  
 bending machine 125 28, 30  
 bending table 119 20  
 bending tool 136 34  
 bend of hook 89 81  
 bend sinister wavy 254 6  
 Benguela Current 14 43  
 benniseed 383 45  
 bent hang 296 39  
 benzene chlorination 170 8  
 benzene extraction 170 6  
 benzene ring 242 66  
 benzene scrubber 156 24  
 benzol scrubber 156 24  
 beret 35 27  
 berlin 186 1  
 berm 216 38  
 Bermuda shorts 31 44  
 berry 58 9, 11; 370 97  
 berry bush 52 19  
 berry bushes 58 1-30  
 berry tree, standard ~ 52 11  
 besageur 329 45  
 besom *Roof & Boilerm.* 38 36  
 besom *Winter Sp.* 302 43  
 Bessemer converter 147 55-69  
 best end of loin 95 7  
 beta particle 1 32  
 beta radiation 1 32  
 Betelgeuse 3 13  
 betel nut 380 20  
 betel palm 380 19  
 bevel *Carp.* 120 81  
 bevel *Mach. Parts etc.* 143 62  
 bevel edge 178 44  
 bevel gear 91 25  
 bevel gearing 91 25  
 bevel gear wheel 143 91  
 bevel wheel 143 91  
 bez antler 88 7  
 bez tine 88 7  
 B flat major 320 64  
 B flat minor 320 67  
 bib *Infant Care etc.* 28 43  
 bib *Ladies' Wear* 30 24  
 bib and brace *Child. Clothes* 29 40  
 bib and brace *Ladies' Wear* 30 21  
 bib and brace overalls 33 44  
 Bible 330 11  
 bib skirt 29 41  
 biceps brachii 18 37  
 biceps femoris 18 61  
 bick, flat ~ 137 12  
 bick, round ~ 137 13  
 bicycle 187  
 bicycle, child's ~ 273 9  
 bicycle, folding ~ 188 1  
 bicycle, gent's ~ 187 1  
 bicycle, motor-assisted ~ 188 6  
 bicycle bell 187 4  
 bicycle drive 187 35-42  
 bicycle frame 187 14-20  
 bicycle kick 291 45  
 bicycle lamp 187 7  
 bicycle lock 187 49  
 bicycle pedal 187 78  
 bicycle pump 187 48

bicycles 188  
 bicycle saddle 187 22  
 bicycle speedometer 187 33  
 bidet 49 7  
 Biedermeier dress 306 22  
 Biedermeier sofa 336 17  
 bier 331 41  
 bifurcation 224 89  
 Big Dipper 3 29  
 big top 307 1  
 big wave riding 279 4  
 big wheel 308 37  
 bike 187 1  
 bikini 280 26  
 bikini bottom 280 27  
 bikini briefs 32 15  
 bikini top 280 28  
 bilberry 377 23  
 bile duct, common ~ 20 37-38  
 bilge block 222 40  
 bilge keel 222 47  
 bilge shore 222 40  
 bilge strake 222 46  
 bill *Game* 88 84  
 bill *Bank* 250 12  
 bill *Birds* 359 17  
 billboard 118 45  
 bill clause 250 17  
 billhook 56 9; 85 11  
 billiard ball 277 1  
 billiard clock 277 17  
 billiard cloth 277 15  
 billiard cue 277 9  
 billiard marker 277 18  
 billiard parlor 277 7-19  
 billiard player 277 8  
 billiard room 277 7-19  
 billiards 277 1-19  
 billiards, English ~ 277 7  
 billiards, French ~ 277 7  
 billiards, German ~ 277 7  
 billiard saloon 277 7-19  
 billiard strokes 277 2-6  
 billiard table 277 14  
 bill of exchange 250 12  
 bills 252 29-39  
 bin 200 45  
 bind 321 24  
 binder 107 6  
 binder course 198 4  
 binder injector 200 53  
 binding *Bookbind.* 185 40-42  
 binding *Athletics* 298 54  
 binding, parts of ~ 301 54-56  
 binding, rubber ~ 286 57-58  
 bindweed 61 26  
 binoculars 86 6; 111 17; 221 128  
 biology preparation room 261 14-34  
 biopsy forceps 23 17  
 biplane 229 10  
 bipod 255 42  
 bipod mast 221 24  
 biprism, ditrigonal ~ 351 22  
 biprism, hexagonal ~ 351 22  
 bipyramid, tetragonal ~ 351 18  
 birch 51 13; 272 40; 281 27  
 Birch Boletus 381 22  
 birch rod 281 27

birch tree 51 13; 272 40; 371 9  
 bird 86 50  
 bird, flightless ~ 359 4  
 bird, gallinaceous ~ 359 22  
 bird, migratory ~ 360 7  
 bird, non-migratory ~ 360 4  
 bird, resident ~ 360 4  
 bird cherry 59 5  
 bird-foot 69 11  
 birds 359; 360; 361; 362; 363  
 birds, corvine ~ 361 1-3  
 birds, European ~ 360  
 birds, exotic ~ 363  
 birds, flightless ~ 359 1-3  
 birds, long-winged ~ 359 11-14  
 birds, web-footed ~ 359 5-10  
 bird's foot 69 11  
 bird's foot clover 376 17  
 bird's foot trefoil 69 11; 376 17  
 birdsmouth 84 28  
 birds of prey 362  
 birds of prey, diurnal ~ 362 1-13  
 birds of prey, nocturnal ~ 362 14-19  
 birth-wort 376 22  
 biscuit tin, decorative ~ 46 12  
 bisector 346 28, 30  
 bishop 276 10  
 bismarck 97 29  
 bison 328 9; 367 9  
 bistort 376 10  
 bit 140 35  
 bitch 73 16  
 biting housefly 81 4  
 bitt 284 25  
 bitter 93 26  
 bitumen 145 64  
 bituminous distributor 200 46  
 black 343 13  
 black arches moth 82 17  
 black-backed jackal 367 11  
 black beetle 81 17  
 blackberry 58 29  
 blackbird 361 13  
 blackboard 47 13; 48 16; 261 36  
 blackboard, three-part ~ 260 29  
 blackboard chalk 48 15  
 blackboard compass 260 40  
 blackboard drawing 260 33  
 blackboard sponge 260 42  
 black buck 367 5  
 blackcock 86 11; 88 66  
 black elder 374 35  
 Black Forest clock 109 31  
 Black Forest gateau 97 24  
 black-headed gull 359 14  
 black liquor filter 172 28  
 black liquor storage tank 172 29  
 black nightshade 379 5  
 black rhino 366 25  
 black salsify 57 35  
 blacksmith 137; 138  
 blacksmith's tools 137 22-39  
 blackthorn 374 27  
 bladder 20 33, 78



- blade *Kitch. Utensils* 40 40  
 blade *Tablew. etc.* 45 54  
 blade *Gdn. Tools* 56 36  
 blade *Arable Crops* 68 20  
 blade *Paperm.* 172 74  
 blade *Bookbind.* 185 29  
 blade *Rowing* 283 38, 53  
 blade *Fencing* 294 44  
 blade *Bot.* 370 28  
 blade, flexible ~ 85 20  
 blade, front ~ 85 35  
 blade, lower ~ 23 14  
 blade, rear ~ 85 40  
 blade, rotating ~ 39 24  
 blade bit 145 21  
 bladebone 95 22, 30, 32, 42  
 blade coater 173 29-35  
 blade coating machine 173 29-35  
 blade covering 293 47  
 bladed cone, rotating ~ 172 75  
 bladed plug, rotating ~ 172 75  
 bladed shell, stationary ~ 172 76  
 blade of grass 370 83-85  
 blade-slewing gear 200 22  
 blancmange powder 98 50  
 blank 252 43  
 blanket 71 44; 168 56  
 blanket, rubber ~ 180 54, 79  
 blanket cylinder 180 24, 37, 54, 63  
 blast burner 108 16  
 blast furnace 147 1  
 blast furnace plant 147 1-20  
 blast furnace shaft 147 7  
 blasting cartridge 158 27  
 blasting fuse 158 28  
 blast inlet 148 2  
 blast lamp 108 16  
 blast main 147 17, 68; 148 2  
 blastodisc 74 65  
 blast pipe *Blacksm.* 137 6  
 blast pipe *Iron Foundry etc.* 148 2  
 blast pipe *Railw.* 210 25  
 blazer 33 54  
 blazing star 51 31  
 blazon 254 17-23  
 blazonry 254 1-36  
 bleach 105 1  
 bleach-hardener 116 10  
 bleaching 169 21  
 bleach tube 105 3  
 bleed 192 27  
 bleeder 38 65  
 bleeding heart 60 5  
 blender 40 46  
 blending pump 196 1  
 Blessed Sacrament 331 48; 332 35  
 blimp 310 48; 313 16-18, 27  
 blind *Hosp.* 25 9  
 blind *Hunt.* 86 9  
 blinder 71 26  
 blind spot 19 50  
 blindworm 364 37  
 blinker 71 26  
 blob marker 83 9  
 blob marking 83 6  
 block *Headgear* 35 3
- block *Plumb.* 125 21  
 block *Mach. Tools* 150 20  
 block *Ship* 221 28, 105  
 block *Winter Sp.* 302 40  
 block *Music. Instr.* 326 20  
 block, adjustable ~ 298 2  
 block, charcoal ~ 108 37  
 block, clay ~ 159 22, 23  
 block, halftone ~ 178 38  
 block, hollow ~ 119 24, 159 21-22, 22, 23  
 block, pumice concrete ~ 119 24  
 block, rubber ~ 187 85  
 block, tongued and grooved ~ 123 74  
 block, travelling ~ 145 8  
 block, wooden ~ 340 1  
 block and tackle 137 20  
 block board 132 73  
 block brake 143 97  
 blocker 293 60  
 blocking saw 157 54  
 block instruments 203 59  
 block making 178  
 block mount 178 41  
 block mountain 12 4-11  
 block mounting 178 41  
 block of flats 37 72-76  
 block of flats, high-rise ~ 37 82  
 block of flats, multi-storey ~ 37 77-81  
 block section panel 203 60  
 block step 123 17  
 blood, arterial ~ 18 12  
 blood, venous ~ 18 11  
 blood circulation 18 1-21  
 blood pressure 23 32; 25 1  
 blood sausage 99 56  
 blood sedimentation 23 42  
 blood smear 23 50  
 bloodstone 108 48  
 blood vessel 19 33  
 bloomer 97 8  
 blooming train 148 50, 70  
 bloom shears 148 52  
 blossom 59 9; 69 14; 80 11  
 blotter 46 23; 246 6; 260 25  
 blouse 30 9  
 blouse, girl's ~ 29 58  
 blow, straight ~ 299 28  
 blow-and-blow process 162 22  
 blower *Furrier* 131 10  
 blower *Paperm.* 172 4  
 blower *Railw.* 211 11  
 blower, travelling ~ 165 2, 3  
 blower aperture 165 5  
 blower fan 191 48; 192 62  
 blower oil pump 211 45  
 blower rail 165 6  
 blowfly 358 18  
 blowhole 367 26  
 blowing 162 28, 36  
 blowing, first ~ 162 24  
 blowing assembly 165 4  
 blowing iron 162 39  
 blowing processes 162 22-37  
 blowlamp 126 74; 301 22  
 blow mould 162 26, 34
- blowout magnet 312 39  
 blowpipe *Gas Weld.* 141 11, 19; 141 28  
 blowpipe *Ethnol.* 352 26  
 blowpipe lighter 141 27  
 blow pit 172 13  
 blow position 147 57  
 blow tank 172 11  
 blowtorch 126 74; 301 22  
 blow valve 172 12  
 blubber-oil lamp 353 7  
 blue *Colour* 343 3  
 blue *Lepidopt.* 365 6  
 blue-and-yellow macaw 363 2  
 bluebell 375 14  
 blueberry 377 23  
 blue bird of paradise 363 3  
 bluebottle 61 1; 358 18  
 blue light 264 11; 270 6  
 Blue Peter 253 26  
 blue shark 364 1  
 blue spruce 51 10  
 bluetit 360 4  
 blurb 185 39  
 B minor 320 57, 60  
 boar *Dom. Anim.* 73 9  
 boar *Game* 88 51  
 boar, young ~ 88 51  
 board *Bldg. Site* 118 22, 87; 119 16  
 board *Carp.* 120 1, 91  
 board *Sawmill* 157 35  
 board *Games* 276 1  
 board, illuminated ~ 268 3  
 board, presawn ~ 273 57  
 board, squared ~ 120 95  
 board, unsquared ~ 120 94  
 board, wooden ~ 338 23  
 board cutter 183 16  
 board cutter, rotary ~ 184 20  
 board-cutting machine, rotary ~ 184 20  
 board feed hopper 184 7  
 board games 276  
 boarding 121 75  
 boarding, horizontal ~ 37 84  
 boarding platform 194 39  
 boardman 251 7  
 board platform 118 28  
 board-sawing machine 132 68  
 board support 132 70  
 boarhound 86 33  
 boar hunt 86 31  
 boaster 158 37  
 boat, carvel-built ~ 283 9  
 boat, inflatable ~ 228 18; 258 82; 278 14; 279 27  
 boat, ship's ~ 221 107; 258 12, 45; 259 35  
 boat, V-bottom ~ 286 35-37  
 boat, vee-bottom ~ 286 35-37  
 boat axe 328 19  
 boat carriage 278 20; 283 66  
 boat deck 223 19-21  
 boat elevator 217 29-38  
 boater 35 35  
 boat fibula 328 28  
 boathouse 283 24  
 boat-launching crane 258 13

- boat lift 217 29-38  
 boat neck 30 34  
 boats, folding ~ 283 54-66  
 boatswain 221 114  
 boat tank 217 33  
 boat trailer 278 20; 283 66  
 bobbin *Shoem.* 100 29  
 bobbin *Dressm.* 103 12  
 bobbin *Cotton Spin.* 164 52, 56, 60  
 bobbin creel 164 28  
 bobbin lace 102 18  
 bobbin thread 104 16  
 bobble 29 4  
 bobblet 303 19  
 bobsled 303 19  
 bobsledding 303 19-21  
 bobsleigh 303 19-21  
 bobsleigh, two-man ~ 303 19  
 bobstay 219 15  
 bob wig 34 2  
 boccie 305 21  
 bock beer 93 26  
 bodhisattva 337 10  
 bodice 31 30  
 bodkin *Basketm.* 136 35  
 bodkin *Composing Rm.* 174 17  
 bodkin beard 34 13  
 body *Flat* 46 3  
 body *Joiner* 132 24  
 body *Lorries etc.* 194 3, 23  
 body *Aircraft* 230 54  
 body *Airsports* 288 26  
 body, bird's ~ 327 57  
 body, dog's ~ 327 30  
 body, dragon's ~ 327 19, 36  
 body, fibre glass ~ 193 14  
 body, horse's ~ 327 27, 54  
 body, human ~ 16 1-54  
 body, interchangeable ~ 213 40  
 body, lion's ~ 327 14, 22  
 body, man's ~ 327 53  
 body, monocoque ~ 191 1  
 body, monster's ~ 327 48  
 body, pituitary ~ 174 3  
 body, serpent's ~ 327 2, 33  
 body, tambourine-like ~ 324 30  
 body, unitary ~ 191 1  
 body, woman's ~ 327 59  
 body brush 71 55  
 body-fixing plate 192 72  
 body hammer 195 46  
 bodyline 175 43  
 body louse 81 41  
 body of barrel 130 6  
 body of wall 217 2  
 body paper 173 29  
 body plan 259 2-11  
 body rotation 298 11  
 body size 175 46  
 body temperature 23 3  
 body tube 113 8, 31-39  
 bog 13 14-24  
 bog bilberry 377 23  
 bogie *Bldg. Site* 119 32  
 bogie *Power Plant* 152 41  
 bogie *Tram* 197 9
- bogie *Railw.* 207 4; 208 4; 212 2; 213 11, 13  
 bogie open freight car 213 24  
 bogie open wagon 213 24  
 bogie wagon 213 26  
 bog pool 13 23  
 bog whortleberry 377 23  
 Bohr-Sommerfeld model 1 26  
 boiler *Roof & Boilerr.* 38 24, 68  
 boiler *Bakery* 97 69  
 boiler *Energy Sources* 155 13  
 boiler *Railw.* 210 16  
 boiler, radiant-type ~ 152 5  
 boiler, vertical ~ 210 62  
 boiler barrel 210 16  
 boiler feed pump 152 18  
 boiler house *Market Gdn.* 55 7  
 boiler house *Power Plant* 152 1-21  
 boiler pressure 210 3  
 boiler pressure gauge 210 47  
 boiler room *Roof & Boilerr.* 38 38-43  
 boiler room *Market Gdn.* 55 7  
 boiler shop 222 9  
 boiler suit 30 21  
 boiling fowl 99 60  
 boiling water system 154 49  
 bola 352 31  
 bolas 352 31  
 bold 175 2  
 bold condensed 175 10  
 boldface 175 2  
 bole 84 19, 22; 85 23, 41; 370 2, 7  
 Boletus edulis 381 16  
 Boletus luteus 381 21  
 Boletus scaber 381 22  
 boll 383 8  
 bollard 217 12  
 bollard, cross-shaped ~ 217 13, 14; 227 10  
 bollard, double ~ 217 11, 14  
 bollard, recessed ~ 217 10  
 bolster *Bedrm.* 43 11  
 bolster *Tablew. etc.* 45 55  
 bolster plate 85 48  
 bolt *Slaughterho.* 94 4  
 bolt *Roof* 121 98  
 bolt *Metalwkr.* 140 39  
 bolt *Mach. Parts etc.* 143 31  
 bolt *Office* 246 23  
 bolt, collar-head ~ 143 32  
 bolt, countersunk-head ~ 143 28  
 bolt, hexagonal-head ~ 143 13  
 bolt, square-head ~ 143 39  
 bolt, T-head ~ 143 41  
 bolter 91 26  
 bolt guide pin 140 41  
 bolt handle 87 22  
 bolt lever 87 22  
 bolts 143 13-50  
 bombard 322 14  
 bombardon 323 44  
 bomber jacket 31 42  
 bombycid moth 358 48

- bond *Bldg. Site* 118 30  
 bond *Stock Exch.* 251 1-10, 11-19  
 bond, convertible ~ 251 11-19  
 bond, English ~ 118 62  
 bond, industrial ~ 251 11-19  
 bond, municipal ~ 251 11-19  
 bonding, rubber ~ 192 82  
 bone 70 33; 354 40  
 bone, ethmoid ~ 17 39  
 bone, frontal ~ 17 30  
 bone, hyoid ~ 20 2  
 bone, jugal ~ 16 8  
 bone, lachrymal ~ 17 40  
 bone, malar ~ 16 8  
 bone, metacarpal ~ 17 16  
 bone, nasal ~ 17 41  
 bone, occipital ~ 17 32  
 bone, parietal ~ 17 31  
 bone, sphenoid ~ 17 38  
 bone, tarsal ~ 17 26  
 bone, temporal ~ 17 33  
 bone, zygomatic ~ 16 8; 17 37  
 bone chisel 24 49  
 bone-cutting forceps 26 51  
 bone lace 102 18  
 bone nippers 26 51  
 bones 17 1-29  
 bone saw *Slaughterho.* 94 19  
 bone saw *Buich.* 96 56  
 bongo drum 324 58  
 boning knife 96 36  
 bonnet *Car* 191 8  
 bonnet *Garage* 195 36  
 bonnet *Ship* 218 34  
 bonnet support 195 37  
 book 42 4; 46 8; 185 36, 52  
 book, children's ~ 47 17; 48 23  
 book, second-hand ~ 309 55  
 book, sewn ~ 185 22  
 book, unbound ~ 183 32  
 bookbinder 183 2  
 bookbinding 183; 184; 185  
 bookbinding machines 184 1-23; 185 1-35  
 bookcase unit 46 7  
 book cover 185 40  
 book delivery 184 5  
 bookjacket 185 37  
 bookmark, attached ~ 185 70  
 bookmark, loose ~ 185 71  
 bookmarker, attached ~ 185 70  
 bookmarker, loose ~ 185 71  
 bookplate 185 51  
 book-sewing machine 185 16  
 bookshelf 42 3; 43 14; 262 12  
 bookshelf unit 46 7  
 bookshop 268 37  
 book stack 262 11  
 boom *Bldg. Site* 119 36  
 boom *Docks* 226 49  
 boom *Sailing* 284 7, 39  
 boom, double ~ 229 35  
 boomerang 352 39  
 boom foresail 220 12  
 boom microphone 311 40  
 boom operator 310 22  
 boom swinger 310 22  
 booster rocket 234 1, 2



boost gauge 230 7  
 boot *Shoem.* 100 57  
 boot *Car* 191 24; 193 23  
 boot *Mus. Instr.* 326 17  
 boot, baby's ~ 101 56  
 boot, felt ~ 353 30  
 boot, ladies' ~ 101 12  
 boot, men's ~ 101 5  
 boot, pony-skin ~ 101 10  
 boot, rubber ~ 289 32  
 boot, Western ~ 101 9  
 bootee 28 45; 29 5  
 Boötes 3 30  
 booth 308 6  
 bootlace 100 64; 291 32  
 boot lid 191 7  
 bootmaker 100  
 boot space 193 17  
 borage family 69 13  
 Boraginaceae 69 13  
 border *Fruit & Veg. Gdn.* 52  
 18, 22  
 border *Basketm.* 136 17  
 border *Park* 272 37  
 border *Theatre* 316 12  
 border light 316 13  
 bore 143 86  
 bore axis 87 38  
 bore diameter 87 40  
 borehole 158 12  
 borer 80 18  
 boring machine 175 49  
 boring mill 138 22  
 boring mill column 150 31  
 boring motor 133 7  
 boring tool 149 51  
 borrower's ticket 262 25  
 bosage 272 4  
 bosh 137 8  
 bo's'n 221 114  
 bosom 16 30  
 boss *Chivalry* 329 58  
 boss *Art* 335 32  
 bostryx 370 76  
 bo'sun 221 114  
 botany 370  
 bottle *Brew.* 93 21  
 bottle *Restaurant* 266 16  
 bottle *Swim.* 279 19  
 bottle, collapsible ~ 116 9  
 bottle, non-returnable ~ 93  
 29  
 bottle, three-necked ~ 350 57  
 bottle, wicker ~ 206 13  
 bottle, wickered ~ 206 13  
 bottle basket 79 13  
 bottle bobbin 167 4  
 bottle-capping machine 76 46  
 bottle kiln 161 3  
 bottle-making machine 162  
 21  
 bottle-nosed dolphin 367 23  
 bottle-opener 45 47  
 bottle rack *Kitch.* 39 6  
 bottle rack *Wine Cell.* 79 11  
 bottlescrew 284 19  
 bottle warmer 28 21  
 bottle washer 93 19  
 bottle-washing machine 93  
 19  
 bottle-washing plant 93 18

bottling 93 22  
 bottling machine, circular ~  
 79 9  
 bottling machine, semi-  
 automatic ~ 79 9  
 bottom 16 40  
 bottom, artificial ~ 301 52  
 bottom, cellular ~ 222 60  
 bottom, cut-in ~ 119 56  
 bottom, double ~ 222 60  
 bottom, synthetic ~ 301 52  
 bottom bracket bearing 187  
 42  
 bottom outlet 269 34  
 bottom plating 222 48  
 bottom plating, inner ~ 222  
 54  
 bott stick 148 10  
 boudoir piano 325 40  
 bough 370 5  
 bouillon cube 98 27  
 boule, grooved ~ 305 24  
 boules 305 21  
 boules player 305 22  
 bounce 297 36  
 bouncing ball 273 20  
 boundary layer control flap  
 256 6; 257 13  
 boundary ridge 63 3  
 boundary stone 63 2  
 bouquet, bridal ~ 332 18  
 bouquetin 367 7  
 bourgeois 175 26  
 bout 294 5-6  
 Bovista nigrescens 381 19  
 bow *Ladies' Wear* 30 46  
 bow *Hairst. etc.* 34 7  
 bow *Metalwkr.* 140 34  
 bow *Shipbuild.* 222 74-79  
 bow *Warships* 258 3  
 bow *Rowing* 283 13  
 bow *Mus. Instr.* 323 12  
 bow *Ethnol.* 354 32  
 bow *Hist. Cost.* 355 78  
 bow, bulbous ~ 221 45; 222  
 74  
 bow, fully enclosed ~ 259 9  
 bow, sliding ~ 205 36  
 bow and arrow 327 53  
 bow bilge 259 80  
 Bowden cable 188 37;  
 189 12  
 bow door 221 30  
 bowed instruments 323 1-27  
 bowels 20 14-22  
 bower 272 17  
 bower, ladies' ~ 329 10  
 bower anchor 258 39; 286 15  
 bow fender 227 17  
 bow gin 87 48  
 bowl 40 6; 45 63; 105 1; 107  
 36  
 bowler 292 76  
 bowler hat 35 28  
 bow light, green and red ~ 286  
 13  
 bowline 218 35  
 bowling ball 305 15  
 bowling crease 292 71  
 bowl lid 107 37  
 bowls 305 21

bow-manoeuving propeller  
 224 23  
 bow propeller 228 33  
 bow ramp 258 90  
 bowsprit 218 20; 219 1  
 bow stick 323 14  
 bow string 305 59  
 bow thruster 224 23  
 bow-tie 32 47; 33 11, 16  
 bow trap 87 48  
 bow wave 223 81  
 box *Livestock* 75 2  
 box *Carriages* 186 8  
 box *Gymn.* 296 15  
 box *Athletics* 298 35  
 box *Fair* 308 7  
 box *Bullfight. etc.* 319 7  
 box, centrifugal ~ 169 17  
 box, coach's ~ 292 56  
 box, crossing keeper's ~ 202  
 43  
 box, gateman's ~ 202 43  
 box, racer's ~ 290 7  
 box, rider's ~ 290 7  
 box, small ~ 296 16; 297 9  
 box attendant 315 12  
 box camera 309 30  
 boxcar 213 14, 22  
 boxer *Dog* 70 10  
 boxer *Sports* 299 25  
 box feeder 159 7  
 box gutter 122 83  
 boxing 299 20-50  
 boxing contest 299 35-50  
 boxing glove 299 26  
 boxing match 299 20-50,  
 35-50  
 boxing ring 299 35  
 box office 308 7  
 box pile 217 6  
 boxroom door 38 20  
 box spar 287 30  
 box spur 71 50  
 box trap 86 20  
 box tree 373 19  
 boy scout 278 11  
 bra 32 1; 318 29  
 bra, longline ~ 32 4  
 brace *Bldg. Site* 119 63  
 brace *Carp.* 120 27, 54  
 brace *Roof* 121 41, 58, 69, 82  
 brace *Ship* 219 67  
 brace *Mus. Instr.* 325 16  
 brace, diagonal ~ *Bldg. Site*  
 118 88; 119 51  
 brace, diagonal ~ *Bridges* 215  
 4  
 bracelet 36 3  
 bracelet, cultured pearl ~ 36 9  
 bracelet, gemstone ~ 36 25  
 bracelet watch 36 33  
 braces 29 26, 34; 32 30  
 braces, adjustable ~ 33 45  
 braces clip 32 31  
 brachioradialis 18 39  
 bracing 215 3  
 bracing, diagonal ~ 119 14  
 bracken 15 5; 377 16  
 bracket *Doc.* 23 10  
 bracket *Plumb. etc.* 126 6  
 bracket *Bicycle* 187 77

bracket *School* 260 30  
 bracket *Winter Sp.* 302 17;  
 303 7  
 bracket, chrome ~ 188 60  
 bracket, round ~ 342 24  
 bracket, square ~ 342 25  
 Brackett series 1 23  
 bract 371 7; 372 5  
 bracteate 252 4  
 bract scale 372 5  
 braid, floral ~ 30 28  
 braid embroidery 102 31  
 braid work 102 31  
 Braille 342 15  
 brain-stem 17 47; 18 24  
 brake *Mills* 91 8  
 brake *Carriages* 186 2, 16  
 brake *Car* 191 45  
 brake *Air Force* 257 10  
 brake *Forest Plants etc.* 377 16  
 brake, automatic ~ 181 47  
 brake, auxiliary ~ 212 10  
 brake, covered ~ 186 33  
 brake, front ~ 187 5  
 brake, hydraulic ~ 212 44  
 brake arm 187 66  
 brake arm cone 187 67  
 brake axle 143 99  
 brake band 143 105  
 brake block *Mach. Parts etc.*  
 143 100  
 brake block *Carriages* 186 16  
 brake cable 188 37; 189 12  
 brake casing 187 70  
 brake chute housing 257 24  
 brake cone 187 71  
 brake cylinder pressure gauge  
 212 7  
 brake disc 191 17; 192 48  
 brake drum 138 11, 20  
 brake flap *Aircraft* 229 44  
 brake flap *Air Force* 256 12  
 brake flap *Gliding* 287 38  
 brake fluid reservoir 191 49  
 brake line *Motorcycle* 189 12  
 brake line *Car* 192 53  
 brake lining *Blacksm.* 138 13  
 brake lining *Mach. Parts etc.*  
 143 106  
 brake lining *Car* 192 52  
 brake lock 56 38  
 brake magnet 143 102  
 brakeman 303 21  
 brake pedal *Gdn. Tools* 56 40  
 brake pedal *Offset Platem.*  
 179 12, 30  
 brake pedal *Car* 191 45, 95  
 brake pressure gauge 210 50  
 brake pulley 143 98  
 brake shaft 143 99  
 brake shoe *Blacksm.* 138 12  
 brake shoe *Mach. Parts etc.*  
 143 100  
 brake shoe *Car* 192 51  
 brake system, dual-circuit ~  
 191 72  
 brake-testing equipment 138  
 16  
 brake weight 143 103  
 brake wheel 91 7  
 braking disc 191 17; 192 48

braking distance 203 29  
 braking roller 138 18  
 branch *Railw.* 203 48  
 branch *Fire Brig.* 270 33  
 branch *Maths.* 347 15  
 branch *Bot.* 370 5, 6  
 branch *Decid. Trees* 371 10,  
 25, 27, 32, 59  
 branch *Conifers* 372 36, 43  
 branch *Trop. Plants* 382 17  
 branch *Industr. Plants* 383 61  
 branch *South. Fruits* 384 12,  
 42  
 branch, flowering ~ 58 32,  
 52; 59 1, 26, 37  
 branch, fruit-bearing ~ 59 19,  
 48  
 branch, fruiting ~ 59 30  
 branch, left ~ 203 47  
 branch, right ~ 203 46  
 branch line 15 23  
 branchman 270 34  
 brandy 98 59  
 brandy glass 45 88  
 brushing 84 12  
 brass 323 39-48  
 brassard *Fire Brig.* 270 22  
 brassard *Chivalry* 329 47  
 brassica 57 32  
 brassicas 57 28-34  
 brassie 293 91  
 brassière 32 1; 318 29  
 brassière, longline ~ 32 4  
 brass instruments 323 39-48  
 brayer 340 12  
 Brazil Current 14 35  
 Brazil nut 384 53, 59  
 breach 13 34  
 bread 45 22; 97 2  
 bread, kinds of ~ 97 6-12; 99  
 11  
 bread, wrapped ~ 97 48-50  
 bread basket 45 20  
 bread-corn 68 1-37  
 bread counter 99 9  
 bread crust 97 4  
 breadth scale 157 58  
 bread unit 97 56-57  
 break *Brew.* 93 2  
 break *Composing Rm.* 175 15  
 break *Carriages* 186 2  
 break, covered ~ 186 33  
 break-bulk cargo, unitized ~  
 226 11  
 break-bulk cargo elevator,  
 floating ~ 226 31  
 break-bulk cargo transit shed  
 225 9  
 break-bulk carrier 225 14;  
 226 13  
 breakdown lorry 270 47  
 breaker *Overh. Irrign.* 67 34  
 breaker *Swim.* 279 6  
 breaker spring 67 35  
 break removal 93 1-5  
 breakstone, rotundifoliate ~  
 375 1  
 breakwater *Hydr. Eng.* 217 16  
 breakwater *Docks* 225 65  
 breakwater *Warships* 258 7,  
 76

breast *Man* 16 28-29  
 breast *Horse* 72 19  
 breast beam 166 46  
 breast beam board 166 16  
 breastbone *Man* 17 8  
 breastbone *Meat* 95 27  
 breastbox 173 11  
 breast collar 71 28  
 breast collar ring 71 27  
 breast drill 140 58  
 breast harness 71 26-36  
 breast of veal 95 4  
 breastplate 329 46  
 breast pocket 33 9  
 breasts 16 28-29  
 breaststroke 282 33  
 breastwork 329 21  
 breather 153 10  
 breathing apparatus 26 1; 270  
 39  
 breathing tube 27 37  
 breccia 11 27  
 breeches 300 7  
 breeches, loose ~ 355 34  
 breeches, white ~ 289 5  
 breeches buoy 228 13  
 breech ring 255 54  
 breeding comb 77 46  
 breeds of dog 70  
 breeze 120 44  
 breve 320 12  
 breve rest 320 20  
 breviary 331 58  
 brevier 175 25  
 brevis 320 12  
 brewer 92 49  
 brewery 93 1-31  
 brewhouse 93 1-31  
 brewing 92; 93  
 briar grain 107 41  
 briar rose 373 26  
 brick 118 40  
 brick, cellular ~ 159 28  
 brick, green ~ 159 16  
 brick, perforated ~ 159 21-22,  
 21  
 brick, radial ~ 159 25  
 brick, radiating ~ 159 25  
 brick, solid ~ 159 20  
 brick, standard ~ 118 58  
 brick, unfired ~ 159 16  
 brick cutter 159 15  
 brickfield 159  
 brick hammer 118 53  
 brick kiln 159 19  
 bricklayer 118 18  
 bricklayer's tools 118 50-57  
 brickmason 118 18  
 brickmason's tools 118 50-57  
 brick-pressing machine 159  
 11  
 brickwork, frost-resistant ~  
 122 39  
 brickwork base 123 15  
 brickworks *Map* 15 89  
 brickworks 159  
 brickyard 159  
 bride 332 15  
 bridegroom 332 16  
 bridesmaid 332 24  
 bridge *Map* 15 44



bridge *Optics* 111 11  
 bridge *Station* 205 3  
 bridge *Ship* 221 6, 12; 223 12-18  
 bridge *Shipbuild.* 222 26  
 bridge *Warships* 258 14; 259 3, 28  
 bridge *Park* 272 47  
 bridge *Free Exerc.* 295 19  
 bridge *Sports* 299 9  
 bridge *Theatre* 315 29; 316 34  
 bridge *Music. Instr.* 322 17  
 bridge, cable-stayed ~ 215 46  
 bridge, covered ~ 215 32  
 bridge, cross-section of ~ 215 1  
 bridge, dental ~ 24 26  
 bridge, flat ~ 215 52  
 bridge, iron ~ 15 56  
 bridge, reinforced concrete ~ 215 49  
 bridge, rope ~ 215 15  
 bridge, solid ~ 215 19  
 bridge, stone ~ 15 50  
 bridge bearing 215 55  
 bridge deck 223 12-18  
 bridge over railway 15 40  
 bridge ring 89 58  
 bridges 215  
 bridge strut 215 30  
 bridge superstructure 258 14  
 bridge support 222 12  
 bridge under railway 15 42  
 bridle 71 7-13  
 bridle path 12 46  
 briefcase 41 17  
 briefs 32 26  
 brig 220 17  
 brigantine 220 14  
 brightness control 240 33  
 brille 323 35  
 brilliant 175 21  
 brilliant cut 36 44  
 brimstone butterfly 365 4  
 brine channel 274 3  
 brine pipe 274 4  
 briolette, faceted ~ 36 86  
 Brisinga endecacnemus 369 11  
 brisket, hind ~ 95 25  
 brisket, middle ~ 95 26  
 brisket of beef 95 23  
 bristle 88 52  
 bristles *Hairst. etc.* 34 23  
 bristles *Household* 50 47  
 bristletail 81 14  
 bristle worm 357 22  
 broach 109 8  
 broaching tap 93 14  
 broach roof, conical ~ 121 24  
 B road 15 36  
 broad axe 120 70  
 broad bean *Veg.* 57 8  
 broad bean *Fodder Plants* 69 15  
 broadcasting 238; 239; 240  
 broadcasting centre 238 16-26  
 broadcasting station 15 33  
 broadsheet 340 27

broadside 340 27  
 broadside fire 218 59  
 broadtail *Ladies' Wear* 30 60  
 broadtail *Furrier* 131 21  
 brochure 250 7  
 broderie anglaise 102 11  
 broiler 98 6; 308 33  
 broiler chicken 74 12  
 broiler rearing 74 11-17  
 broken thread detector roller 164 4  
 broken thread stop motion 165 19  
 broker, commercial ~ 251 5  
 broker, inside ~ 251 4  
 broker, outside ~ 251 5  
 bronchus 20 5  
 Bronze Age 328 21-40  
 brooch, ivory ~ 36 30  
 brooch, modern-style ~ 36 19  
 brooch, pearl ~ 36 7  
 brood bud bulblet 54 27, 29  
 brood cell 77 31  
 brood chamber 77 46  
 brooder 74 3  
 brook 13 8; 15 80  
 broom 38 36; 50 46; 62 5; 199 6; 268 21; 272 67  
 broom *Shrubs etc.* 374 20  
 broom, circular ~ 199 40  
 broom, cylinder ~ 199 42  
 broom, inverted ~ 224 99  
 broom, upward-pointing ~ 224 100  
 broom handle 38 37; 50 49  
 broom head 50 48  
 broomstick 38 37; 50 49  
 brougham 186 3  
 brow antler 88 6  
 browband 71 9  
 brown 343 5  
 brown ale 93 26  
 brown bear 368 10  
 brown leaf-eating weevil 80 49  
 Brown Ring Boletus 381 21  
 brown-tail moth 80 28  
 brown trout 364 15  
 brow point 88 6  
 brow snag 88 6  
 brow tine 88 6  
 brush *Roof & Boilerm.* 38 32  
 brush *Household* 50 42, 53  
 brush *Bees* 77 7  
 brush *Forestry* 84 5  
 brush *Game* 88 47  
 brush *School* 260 59  
 brush *Graphic Art* 340 11  
 brush *Script* 341 24  
 brush, camel hair ~ 338 7  
 brush, dry ~ 128 49  
 brush, flat ~ *Painter* 129 17  
 brush, flat ~ *Art. Studio* 338 6  
 brush, rotating ~ 168 46  
 brush, round ~ 338 8  
 brush, stiff-bristle ~ 105 16  
 brush, wire ~ *Gas Weld.* 141 26  
 brush, wire ~ *Arc Weld.* 142 18

brush, wire ~ *Music. Instr.* 324 53  
 brush head 50 79  
 brush head, detachable ~ 49 30  
 brushwood *Map* 15 15  
 brushwood *Forestry* 84 5  
 brushwood *Spa* 274 2  
 Brussels lace 102 18  
 Brussels sprout 57 30  
 bubble bath 49 3  
 bubble chamber 1 58  
 bubble float, oval ~ 89 47  
 buccaneer 306 43  
 Büchner funnel 349 11  
 buck *Dom. Anim.* 73 18  
 buck *Game* 88 28, 40, 59  
 buck *Gymn.* 296 17  
 buck, young ~ 88 39  
 bucket *Household* 50 54  
 bucket *Mills* 91 36  
 bucket *Bldg. Site* 118 82  
 bucket *Road Constr.* 200 5  
 bucket chain 226 42  
 bucket dredger 226 41  
 bucket elevator 200 49; 201 21  
 bucket elevator chain 216 57  
 bucket ladder 226 43  
 bucket pump 269 7  
 bucket seat *Car* 193 11  
 bucket seat *Sports* 305 90  
 bucket teeth 200 6  
 bucket-top boot 355 58  
 buckeye 371 58  
 buckle 101 52  
 buckle and knife folder 185 8  
 buckle and knife folding machine 185 8  
 buckle fold 185 11  
 buckler 329 57  
 bucksaw 120 61  
 bud 54 23, 26; 58 27; 59 22; 60 16; 61 3  
 bud, axillary ~ 370 25  
 bud, terminal ~ 370 22  
 bud cutting 54 22  
 Buddha 337 20  
 budding 54 30  
 budding knife 54 31  
 buffalo 367 8  
 buffalo horn 254 34  
 buffer *Station* 206 51  
 buffer *Railw.* 213 7  
 buffer *Army* 255 27, 44, 52  
 buffer recuperator 255 52  
 buffer ring 255 44  
 buffer storage 242 33  
 buffet 207 78-79  
 buffet car, quick-service ~ 207 73  
 buffet compartment 207 78-79  
 buffing machine 108 46  
 buffing wheel 100 10  
 buffoon 306 38, 69  
 bug 81 39  
 buggy 193 12  
 buggy, American ~ 186 49  
 buggy, English ~ 186 48  
 bugle 309 54  
 building, centralized ~ 334 55

building, centrally-planned ~ 334 55  
 building, model ~ 48 28  
 building, neoclassical ~ 336 15  
 building, public ~ 15 54  
 building berth 222 11-18  
 building berths 222 11-26  
 building block 28 41; 48 27  
 building board, lightweight ~ 123 58  
 building brick *Infant Care etc.* 28 41  
 building brick *Kindergart.* 48 27  
 building brick *Brickwks.* 159 20  
 building glazier 124 8  
 building site 118; 119  
 building slips 222 11-26  
 building timber 120 10, 83-96  
 built piece 315 32  
 built unit 315 32  
 bulb, glass ~ 127 57  
 bulb, old ~ 54 28  
 bulb-head pin 328 29  
 bulbil 54 27, 29; 375 38  
 bulk cargo 221 11  
 bulk cargo handling 226 29  
 bulk carrier *Ship* 221 9  
 bulk carrier *Docks* 225 67; 226 30  
 bulk goods 221 11  
 bulkhead, protective ~ 305 91  
 bulk material 200 12  
 bulk transporter barge 226 35  
 Bull *Astron.* 3 25; 4 54  
 bull *Dom. Anim.* 73 1  
 bull *Heraldry* 254 15  
 bull, mock ~ 319 3  
 bull, young ~ 319 35  
 bulldog 70 1  
 bulldozer 199 16; 200 28  
 bulldozer blade 200 29  
 bulldozer for dumping and compacting 199 18  
 bullfight 319 1-33, 24  
 bullfight, mock ~ 319 1  
 bullfighting 319  
 bullfinch 360 5  
 bull pen 319 14  
 bullring 319 5  
 bull's eye 336 2  
 bull's-eye glass 124 6  
 bull terrier 70 16  
 bulrush 136 27  
 bulwark 221 120; 222 67  
 bumblebee 358 23  
 bumper *Tram* 197 12  
 bumper *Station* 206 51  
 bumper, front ~ 191 13  
 bumper, integral ~ 193 33  
 bumper car 308 62, 63  
 bumper steel 166 44  
 bumper steel stop rod 166 45  
 bump rubber 192 82  
 bun 34 29  
 bun, iced ~ 97 39  
 bun, plaited ~ 97 41  
 bunches 34 30  
 bunch of fruit 384 32

bunch of grapes 78 5; 99 89  
 bunch pink 60 6  
 bungalow 278 7  
 bunghole 130 7  
 bunk, folding ~ 259 84  
 bunk, rear ~ 85 49  
 bunk-bed 47 1  
 bunker 293 81  
 bunkering boat 225 13  
 Bunsen burner 173 5; 350 1  
 Bunter downthrow 154 61  
 bunting 253 3, 11  
 buntings 361 6-7  
 bunt line 218 36; 219 71  
 buoy 90 2; 216 12; 224 71; 285 17, 18; 286 31  
 buoy, conical ~ 224 76  
 buoy, green ~ 224 84  
 buoy, port hand ~ 224 95  
 buoy, starboard hand ~ 224 96  
 buoyancy tube 286 27  
 buoy rope 90 3  
 bur 24 37  
 burden chain 139 44  
 burette 350 21  
 burette clamp 350 23  
 burette stand 350 22  
 burgee 253 22; 284 48  
 Burgundian 355 40  
 burial 331 33-41  
 burial place, underground ~ 331 59  
 burin 175 33; 340 5, 15, 20  
 burner *Power Plant* 152 6  
 burner *Glass Prod.* 162 6  
 burner, gas ~ 139 3, 48  
 burner platform 288 80  
 burner ventilator 92 17  
 burning-in oven 179 32  
 burnisher *Goldsm. etc.* 108 51  
 burnisher *Watchm.* 109 17  
 burnishing 109 17  
 burnous 354 7  
 burr 88 5, 29  
 burrow *Soft Fruit* 58 63  
 burrow *Hunt.* 86 26  
 burying ground 331 21-41  
 bus 194 17  
 bus, double-deck ~ 194 36  
 bus, double-decker ~ 194 36  
 bus, electrical system ~ 235 55  
 busbar 152 29  
 buses *Lorries etc.* 194  
 'buses' *Airport* 233 35  
 bush, rubber ~ 192 67  
 bushing 162 50  
 bushing chain, double ~ 190 49  
 bushing tip 162 51  
 bushman 354 29  
 bushman woman 354 34  
 business and passenger aircraft 231 3, 7  
 business letter 245 33; 246 7; 248 30  
 business trip 209 29  
 bust 42 17  
 bustle 355 69  
 bustle pipe 147 53  
 butane gas 278 33  
 butane gas bottle 278 34

butcher 96 38, 58  
 butcher knife 94 15; 96 37  
 butcher's shop 96 1-30  
 butt *Hunt.* 86 47-52, 51; 87 3, 7  
 butt *Meat* 95 50  
 butt *Army* 255 9, 24, 31, 39  
 butt *Sports* 305 47  
 butt, bound ~ 89 55  
 butt, cork ~ 89 50  
 butt end 85 41  
 butter 98 22; 99 47  
 butter, branded ~ 76 37  
 butter-and-eggs 376 26  
 butter churn 76 33  
 butter-cream cake 97 24  
 buttercup 375 8  
 butter dish 45 36  
 butterflies 358 48-56; 365 1-6  
 butterflower 375 8  
 butterfly *Free Exerc.* 295 35  
 butterfly *Articulates* 358 52  
 butterfly nut 143 42; 187 39  
 butterfly stroke 282 34  
 butterfly tail 229 31  
 butterfly valve 192 9  
 butter knife 45 73  
 butter-making, continuous ~ 76 33  
 buttermilk tank 76 18  
 butter shaping and packing machine 76 32  
 butter supply pipe 76 34  
 butterwort 377 13  
 button *Tram* 197 32  
 button *Fencing* 294 45  
 button *Music. Instr.* 325 31  
 button, staghorn ~ 29 33  
 button box 103 15  
 buttonhole 332 21  
 buttonhole stitch 102 6  
 button stitch 102 6  
 butt plate *Hunt.* 87 14  
 butt plate *Sports* 305 46  
 buttress *Chivalry* 329 26  
 buttress *Art* 335 27  
 buttresses 335 27-28  
 butt ring 89 58  
 buzzer, electric ~ 127 15  
 buzz saw 119 19; 125 24; 134 50  
 buzz saw blade 132 59  
 by-line 291 7  
 bypass air flow 232 50  
 bypass duct 232 41, 44  
 bypass engine 232 46  
 bypass switch 211 25

**C**

cab *Carriages* 186 26, 28  
 cab *Lorries etc.* 194 2  
 cab *Town* 268 64  
 cab, driver's ~ 64 36; 194 2, 15; 200 11; 208 14; 209 6; 210 39-63, 49; 211 19, 57; 212 5; 213 2  
 cab, engineer's ~ 208 14; 209 6; 210 39-63, 49; 211 19, 57; 212 5; 213 2



- cabbage, green ~ 57 32  
 cabbage, red ~ 57 32  
 cabbage, round ~ 57 32  
 cabbage lettuce 57 36  
 cabbage white butterfly 80 47, 48  
 cab frame 65 21  
 cab heating switch 211 39  
 cab horse 186 28  
 cabin *Railw.* 214 20, 28  
 cabin *Ship* 218 45  
 cabin *Sailing* 285 39  
 cabin *Airsports* 288 19  
 cabin, admiral's ~ 218 27  
 cabin, captain's ~ 223 13  
 cabin, commanding officer's ~ 259 85  
 cabin, coxswain's ~ 228 31  
 cabin, crane driver's ~ 119 35; 222 16; 226 52  
 cabin, de luxe ~ 223 30  
 cabin, double-berth ~ 223 29  
 cabin, large-capacity ~ 214 52  
 cabin, officer's ~ 223 21  
 cabin, single-berth ~ 223 46; 228 32  
 cabin cruiser 286 3  
 cabinet 22 40; 246 20  
 cabinet maker 132 38  
 cabin pulley cradle 214 66  
 cabin superstructure 285 39  
 cable *Sea Fish.* 90 26  
 cable *Power Plant* 153 41  
 cable *Music. Instr.* 326 53  
 cable, auxiliary ~ 214 47  
 cable, electric ~ 56 32  
 cable, endless ~ 214 21  
 cable, high-voltage ~ 153 42  
 cable, lower ~ 214 46  
 cable, moisture-proof ~ 127 42  
 cable, submarine ~ 237 56  
 cable, thermoplastic ~ 127 42  
 cable, three-core ~ 127 44  
 cable binding 301 40  
 cable boom 195 15  
 cable box 153 33  
 cable clip 127 40  
 cable connection 6 26  
 cable connection panel 239 3  
 cable crane berth 222 11-18  
 cable drum 85 39; 270 55  
 cable duct 234 29, 47; 235 61  
 cable ferry 216 1  
 cable guide 201 7  
 cable guide rail 214 33  
 cable manhole 198 17  
 cable parachute 287 7  
 cable pattern 30 39  
 cable pulley, automatic ~ 301 62  
 cable railway 214 12  
 cable release 23 9; 114 38; 115 101  
 cable release, double ~ 115 102  
 cable release socket 117 6  
 cable support 214 76  
 cable suspension lines 214 15-38  
 cable tunnel 152 20
- cable vault 152 21  
 cableway 214 30  
 cableway, endless ~ 214 19  
 cableway gondola 214 52  
 cableways 214 15-38  
 cable winch 85 38, 46; 255 69; 258 85  
 cabochoon, high ~ 36 79  
 cabochoon, octagonal ~ 36 81  
 cabochoon, oval ~ 36 80  
 cabochoon, round ~ 36 78  
 cabochoon, simple ~ 36 78  
 cabochoons 36 78-81  
 caboose 223 42  
 cabriole 314 21  
 cabriolet 186 29  
 cacao bean 382 19  
 cacao tree 382 16  
 cachalot 367 25  
 caddis fly 358 12  
 caecum 20 17  
 café 265 1-26  
 café, open-air ~ 272 57  
 café customers 265 22-24  
 café table 265 11  
 cage *Fish Farm.* 89 1  
 cage *Coal* 144 23  
 cage *Circus* 307 50  
 cage, crane driver's ~ 119 35; 222 16; 226 52  
 cage, outside ~ 356 11  
 cage, rotating ~ 168 17  
 cage, round ~ 307 49  
 cage, stepped ~ 74 20  
 cage, tiered ~ 74 20  
 cage caravan 307 62  
 cage system 74 18  
 cage-winding system 144 23  
 caisson 217 33; 222 32; 259 19  
 cake 169 19-27, 22  
 cake counter 99 9; 265 1  
 cake plate 97 25  
 cakes 97 17-47  
 cake tin 40 28, 29  
 calabash 354 27  
 calcaneum 17 27  
 calcite 351 22  
 calcium chloride tube 350 43  
 calculating machine 309 80  
 calculation, logarithmic ~ 345 6  
 calculator 309 80  
 calculator, electronic ~ 246 12  
 calculator dial *Photog.* 114 57  
 calculator dial *Photograv.* 182 19  
 calculus, infinitesimal ~ 345 13-14  
 calendar 22 10  
 calendar clock 110 19  
 calendar sheet 247 33  
 calendar 173 36  
 calendaring machine 168 38  
 calendar roll 173 26, 38  
 calendar roller 163 20, 37, 59  
 calf *Man* 16 53  
 calf *Farm Bldgs.* 62 33  
 calf *Dom. Anim.* 73 1  
 calf *Game* 88 1  
 calf *Meat* 95 1-13  
 caliber 87 40
- calibre 87 40  
 California Current 14 39  
 caliper *see* calliper  
 call, local ~ 237 3  
 call, long-distance ~ 237 3  
 call box 204 46; 236 8; 237 1; 251 10; 268 56  
 call button 25 6; 127 3; 246 15  
 calliper *Car* 191 18  
 calliper *Sculpt. Studio* 339 3  
 calliper, fixed ~ 192 49  
 calliper, inside ~ 135 23  
 calliper, outside ~ 135 18  
 calliper gauge 149 59  
 calliper square 85 10  
 call light 315 52  
 callosity 72 27  
 calls for luring game 87 43-47  
 calm 9 11  
 calm belts 9 46-47  
 calms, equatorial ~ 9 46  
 calvarium 261 16, 18  
 calyx 58 8; 374 8  
 calyx, involucre ~ 375 33  
 calyx, renal ~ 20 30  
 cam 190 60  
 Camberwell beauty 365 5  
 cambium ring 370 10  
 came 124 13  
 camel 366 29  
 camel caravan 354 1  
 camera *Atom* 1 60  
 camera *Optic. Instr.* 112 14, 20  
 camera *Cine Film* 117 28  
 camera *Audiovis.* 243 1  
 camera *Films* 310 19  
 camera, cartridge-loading ~ 114 11  
 camera, compact ~ *Cine Film* 117 51  
 camera, compact ~ *Photomech. Reprod.* 177 32  
 camera, folding ~ 114 49; 309 25  
 camera, high-speed ~ 313 35  
 camera, large-format ~ *Optic. Instr.* 112 25, 36  
 camera, large-format ~ *Photog.* 114 49, 61  
 camera, miniature ~ *Doc.* 23 7  
 camera, miniature ~ *Optic. Instr.* 112 26  
 camera, miniature ~ *Photog.* 114 1; 115 1  
 camera, 35 mm ~ *Photog.* 114 1  
 camera, 16 mm ~ *Cine Film* 117 43  
 camera, 35 mm ~ *Films* 313 1  
 camera, 16 mm ~ *Films* 313 31  
 camera, narrow-gauge ~ 313 35  
 camera, photogrammetric ~ 112 68  
 camera, professional press-type ~ 117 66  
 camera, rapid-sequence ~ 115 77

- camera, single-lens reflex ~ 115 1  
 camera, spectrographic ~ 5 6  
 camera, stereometric ~ 112 71  
 camera, subminiature ~ 114 16  
 camera, Super-8 ~ 117 51  
 camera, underwater ~ 279 24  
 camera assistant 117 68; 310 42  
 camera back 114 54; 115 23  
 camera body *Photog.* 115 2  
 camera body *Photomech. Reprod.* 177 25, 33  
 camera cable 239 2  
 camera case 115 103  
 camera control 242 36  
 camera crane 310 49  
 camera door 313 25  
 camera head 240 27  
 camera lens 313 19  
 cameraman 117 67; 310 20  
 cameraman, first ~ 310 41  
 camera monitor 238 65; 239 12; 240 28  
 camera operator 310 42  
 camera tube switch 242 23  
 cam housing 167 13  
 camomile *Weeds* 61 8  
 camomile *Med. Plants* 380 1  
 camp *Games* 276 27  
 camp *Circus* 307 61  
 campanile 334 65  
 camp bed 278 59  
 camp chair, folding ~ 278 vp  
 camp cot 278 59  
 camper 278 46  
 camp fire 278 10  
 campground 278 1-59  
 camphor laurel 380 18  
 camphor tree 380 18  
 camping 278  
 camping site 278 1-59  
 camping tableware 278 45  
 campion 376 20  
 camp site 278 1-59  
 camp site attendant 278 2  
 camp table, folding ~ 278 44  
 camshaft 166 56; 190 11, 14  
 camshaft bearing 192 24  
 camshaft lubrication 190 13  
 camshaft wheel 166 55  
 can *Butch.* 96 26  
 can *Supermkt.* 99 91  
 can *Painter* 129 7  
 can *Weaving* 166 21  
 Canadian pondweed 378 56  
 Canadian waterweed 378 56  
 canal *Map* 15 57  
 canal *Hydr. Eng.* 217 15-28  
 canal, auditory ~ 17 34, 58  
 canal, stomachic-intestinal ~ 77 15-19  
 canal administration 217 24  
 canal bed 217 30  
 canal entrance 217 15-16  
 Canary Current 14 41  
 can buoy 224 77, 94  
 cancel button 326 41  
 cancellation button 271 4  
 Cancer 4 56

- candelabra 45 16  
 candidate 263 20  
 candies 47 31, 32  
 candies *Grocer* 98 75-86  
 candle, cast ~ 260 76  
 candle, paschal ~ 330 44  
 candle, wax ~ 77 66; 260 76  
 candlestick 309 45  
 candlestick, paschal ~ 330 45  
 candlewick yarn 35 9  
 candy 98 75  
 cane, flowering ~ 58 14  
 can holder 163 36  
 Canidae 367 11-13  
 canine 19 17  
 Canis Major 3 14  
 Canis Minor 3 15  
 canister 84 35; 129 16  
 canned vegetables 98 17  
 cannon *Horse* 72 23  
 cannon *Army* 255 49, 92  
 cannon cracker 306 53  
 canoe 352 19  
 canoe, Alaskan ~ 283 4  
 canoe, Canadian ~ 283 3  
 canoeing 283  
 canoeist 283 55  
 canoes 283 54-66  
 canoe stern 285 44  
 canoe with outrigger 352 35  
 cañon 13 45  
 canonicals *Church* 330 22; 332 4  
 canopy *Infant Care etc.* 28 32  
 canopy *Dwellings* 37 67  
 canopy *Child. Rm.* 47 12  
 canopy *Kindergart.* 48 26  
 canopy *Supermkt.* 99 24  
 canopy *Aircraft* 230 39  
 canopy *Airsports* 288 38  
 canopy *Church* 330 21; 331 49  
 canopy bearer 331 46  
 canopy jack 257 5  
 cant chisel 132 11  
 canteen 119 45  
 canter 72 42  
 cant hook 85 7  
 canting table 133 17  
 cantle 71 39, 46  
 canvas 338 21  
 canvas hull, rubber-covered ~ 283 58  
 canvas stretcher 338 20  
 canyon 13 45  
 canyon river 13 51  
 cap *Bees* 77 39  
 cap *Drawing Off.* 151 40  
 cap *Refuse Coll.* 199 8  
 cap *Music. Instr.* 326 31  
 cap *Edib. Fungi* 381 4  
 cap, astrakhan ~ 35 34  
 cap, corduroy ~ 35 25  
 cap, fox ~ 35 31  
 cap, leather ~ 35 32; 354 26  
 cap, linen ~ 35 8  
 cap, mink ~ 35 17, 20  
 cap, musquash ~ 35 33  
 cap, peaked ~ 35 17, 29; 264 8; 301 18  
 cap, sheepskin ~ 353 23  
 cap, white ~ 268 32

- cap, wide-brimmed ~ 355 28  
 cap, workman's ~ 35 40  
 capa 319 27  
 capacitor 211 17  
 cap and bells 306 39  
 caparison 329 74  
 cape 30 65; 105 34; 106 4  
 cape, short ~ 355 29  
 cape chisel 140 25  
 capeline 21 3  
 Capella 3 27  
 caper 98 42  
 capercaillie 88 72  
 capillary tube stand 23 42  
 capistrum 322 5  
 capital *Composing Rm.* 175 11  
 capital *Art* 334 20-25  
 capital, Arabian ~ 337 18  
 capital, bell-shaped ~ 333 16  
 capital, bud-shaped ~ 333 14  
 capital, Roman ~ 341 16  
 capital, small ~ 175 14  
 capitulum 61 14; 370 73; 378 12  
 capoc tree 383 20  
 cap of typing element 249 30  
 capon 73 21  
 capper 76 46  
 capping *Bees* 77 39  
 capping *Coal* 144 48  
 Capricorn 3 36; 4 62  
 capriole 71 5  
 caprolactam 170 28  
 caprolactam oil 170 25  
 caps, ladies' ~ 35 1-21  
 caps, men's ~ 35 22-40  
 capstan *Cine Film* 117 34  
 capstan *Hydr. Eng.* 217 22  
 capstan *Audiovis.* 243 23  
 capstan *Warships* 258 23  
 capstan idler 117 35  
 capsule 384 58  
 capsule, poricidal ~ 370 96  
 capsule, porose ~ 370 96  
 captain 224 38  
 caption 185 67; 342 59  
 car *Car* 191 1-56  
 car *Garage* 195 34  
 car *Railw.* 213 18  
 car, four-axled ~ 208 3  
 car, large-capacity ~ 213 28  
 car, open ~ 207 59  
 car accessory 196 28  
 carapace 364 29  
 caravan 278 52; 307 34  
 caravan, collapsible ~ 278 3  
 caravan, showman's ~ 206 20  
 caravan awning 278 57  
 caravanning 278  
 caravel 218 27-43; 220 37  
 caraway roll 97 31  
 caraway stick 97 31  
 carbide, cemented ~ 149 46  
 carbine 86 30  
 carbolic acid 170 14  
 carbon, active ~ 270 58  
 carbon, negative ~ 312 41  
 carbon, positive ~ 312 40  
 carbon atom 242 63  
 carbon crater 312 44



carbon disulfide 169 8  
 carbon disulphide 169 8  
 carbon disulphide injector 83 33  
 carbon rod, negative ~ 312 41  
 carbon rod, positive ~ 312 40  
 carbon rod holder 312 43  
 carbon tissue 182 1, 10  
 carbon tissue, printed ~ 182 8  
 carbon tissue transfer machine 182 6  
 carburetor *see* carburettor  
 carburettor 189 4; 192 1-15  
 carburettor, cross-draught ~ 190 79  
 car carrier, double-deck ~ 213 35  
 car carrier, two-tier ~ 213 35  
 carcase 118 1-49  
 carcass 118 1-49  
 carcassing 118 1-49  
 car coat 33 63  
 card *Cotton Spin.* 163 34, 51  
 card *Games* 276 37  
 card, patient's ~ 25 5  
 card, used ~ 195 14  
 cardan coupling 67 6  
 cardan joint 67 6, 28  
 cardan mount 6 36  
 cardan shaft 64 40, 48; 67 16; 211 51; 212 29, 83  
 cardan shaft connection 64 63  
 cardan transmission 189 47  
 cardboard 260 50-52  
 card can 163 35  
 card catalogue 262 22  
 card catalogue drawer 262 23  
 car deck 221 79  
 cardiac rhythm 25 1  
 cardiac sulcus, longitudinal ~ 20 25  
 cardigan 31 50; 33 30  
 cardinal *Maths.* 344 5  
 cardinal *Birds* 363 5  
 cardinal bird 363 5  
 card index 245 23  
 card index box 46 10; 248 27  
 carding can 163 35  
 carding engine 163 34, 51  
 carding machine 163 34  
 car door 191 4  
 card sliver 163 38  
 card stacker 244 13  
 car ferry 216 10  
 cargo 223 77  
 cargo and passenger liner 221 96  
 cargo and passenger ship 223 1-71  
 cargo barge 216 25  
 cargo boom 221 26, 59; 223 36  
 cargo gear 221 24-29, 59  
 cargo handling, horizontal ~ 226 7  
 cargo-handling berth 226 1  
 cargo-handling gear 221 24-29, 59  
 cargo hatchway 221 11, 63; 226 14  
 cargo hold 231 21  
 cargo ship 221 23

cargo warehouse 233 10  
 'car hire' 233 33  
 Carina 3 46  
 carload 206 52  
 car location number 195 48  
 car models 193 1-36  
 carnation 60 6  
 carnival 306  
 carnival float 306 57  
 carnival procession 306 57-70  
 carnival truck 306 57  
 carnivore house 356 10  
 carnivores 367 11-22; 368 1-11  
 carob 384 41  
 carom billiards 277 7  
 carousel 308 2  
 carp 89 26; 364 4  
 carpel 58 36, 59; 59 13; 374 2, 26  
 carpenter 120 12  
 carpenter's tools 120 60-82  
 carpenter's yard 120 1-59  
 carpet 44 16  
 carpet, fitted ~ 41 18; 43 23  
 carpet, oriental ~ 46 36  
 carpet, velour ~ 267 35  
 carpet beater head 50 79  
 carpet beater nozzle 50 71  
 carpet brush 50 45  
 carpet cleaning 50 53-86  
 carpeting 191 43  
 carpet sweeper 50 57  
 carpet sweeper and shampooer, combined ~ 50 76  
 carp hook 89 86  
 carp pond 89 6  
 carpus *Man* 17 15; 19 76  
 carpus *Horse* 72 22  
 car radio 191 90  
 carriage *Hosp.* 26 36  
 carriage *Sawmill* 157 12, 52  
 carriage *Knitting* 167 39  
 carriage *Tram* 197 5, 6, 7  
 carriage, auxiliary ~ 157 11  
 carriage, one-horse ~ 186 18, 29  
 carriage, open ~ 207 61; 208 9  
 carriage, three-horse ~ 186 45  
 carriage, two-horse ~ 186 36  
 carriage apron 149 16  
 carriage handle 167 41  
 carriage heating pressure gauge 210 44  
 carriage horse 186 28  
 carriage motor 157 15  
 carriage rail 167 45  
 carriages 186 1-54, 1-3, 26-39, 45, 51-54  
 carriages, horse-drawn ~ 186  
 carriage sprayer 83 38  
 carriage step 186 13  
 carrier *Bicycle* 187 44  
 carrier *Docks* 226 4  
 carrier return lever 249 21  
 carrion flower 53 15  
 carrot 57 17  
 carrot, stump-rooted ~ 57 18  
 carrycot 28 48  
 carry-home pack 93 28

carrying axle 210 35  
 carrying bar 148 16  
 carrying bogie 197 10  
 carrying cart 56 26  
 carrying grip 21 22  
 carrying handle 241 2  
 carrying rope 215 16  
 carrying saddle 73 4  
 carrying strap 115 9  
 carrying wheel 214 7  
 cart 86 39  
 cart, electric ~ 206 34  
 carte engagement 294 47  
 cartilage, costal ~ 17 11  
 cartilage, thyroid ~ 20 3  
 cartoon *Art. Studio* 338 43  
 cartoon *Script* 342 53  
 cartouche 336 7  
 cartridge *Hunt.* 87 19, 54  
 cartridge *Cine Film* 117 30  
 cartridge *Slaughterho.* 94 5  
 cartridge, full-jacketed ~ 87 55  
 cartridge, instamatic ~ 114 15  
 cartridge, magnetic ~ 241 26  
 cartridge, subminiature ~ 114 17  
 cartridge chamber 87 15  
 cartwheel 297 21  
 cartwheel ruff 355 52  
 car tyre 191 15; 196 27  
 carvel 218 27-43; 220 37  
 carvel planking 285 53  
 carvel planking, diagonal ~ 285 56  
 carver 96 35  
 carving knife 45 69; 96 35  
 carving set 45 69-70  
 car-wash hose 196 23  
 car wheel 191 14  
 car window, crank-operated ~ 191 22  
 caryatid 334 36  
 caryopsis 375 43  
 cascade 272 9  
 case *Meteorol. Instr.* 10 18  
 case *Doc.* 22 33  
 case *Composing Rm.* 174 3, 8  
 case *Bookbind.* 185 40  
 case *Lorries etc.* 194 19  
 case *Station* 204 6; 205 7  
 case *Chem.* 349 26  
 case, cardboard ~ 87 50  
 case cabinet 174 4  
 case head 305 36  
 case maker 184 6  
 case-making machine 184 6  
 case rack 174 4  
 case room 174; 175; 176  
 cash desk 196 29; 266 69; 275 2  
 cash drawer 271 5  
 cashier 99 94; 250 2; 266 70; 271 1  
 cash readout 196 4  
 cash register 47 34; 99 93; 207 86  
 cash register, electric ~ 271 2  
 cash total 271 8  
 casing *Mach. Parts etc.* 143 79  
 casing *Oil, Petr.* 145 18

casing *Power Plant* 153 37  
 casing *Text. Finish.* 168 16  
 casing *Army* 255 10  
 casing *Chem.* 350 10  
 casing, outer ~ 168 17  
 casing, protective ~ *Meteorol. Instr.* 10 39  
 casing, protective ~ *Railw.* 202 35  
 casing cover 143 80  
 casing-in machine 185 27  
 casino 274 8; 275 1  
 cask 130 5  
 casket 331 35  
 casque, light ~ 329 61  
 Cassegrain cage 5 4  
 casserole dish 40 14  
 cassette, compact ~ 241 10  
 cassette, daylight ~ 177 50  
 cassette, 35 mm ~ 114 7  
 cassette, single-8 ~ 117 39  
 cassette box 241 11, 47  
 cassette cabinet 241 11, 47  
 cassette compartment 241 6, 34; 243 8; 249 72  
 cassette deck 241 52  
 cassette exit slot 114 10  
 cassette holder 241 11, 47  
 cassette recorder 117 73; 261 42  
 cassette recorder unit 241 3  
 cassette slit 114 10  
 cassette tape 241 12  
 cassia 380 16  
 Cassiopeia 3 33  
 cassowary 359 1  
 cast 89 64, 78  
 cast, long ~ 89 58  
 castanets 324 46  
 caster 148 8  
 castes of bees 77 1, 4, 5  
 cast glass 124 6  
 casting 148 42  
 casting, continuous ~ 148 24-29  
 casting mechanism 174 25  
 casting net 89 31  
 casting off 167 66  
 casting team 148 13  
 castle *Games* 276 12  
 castle, knight's ~ 329 1  
 castle gate 329 32  
 castle nut 143 77  
 castle wall 333 31  
 cast line 174 27  
 cast of skull 261 15  
 castor *Household* 50 81  
 castor *Horse* 72 27  
 castor *Pest Contr.* 83 61  
 Castor and Pollux 3 28  
 castor-oil plant 380 14  
 casual 101 34  
 casualty 21 20  
 cat 62 3; 73 17  
 catacomb 331 59  
 catalogue, main ~ 262 21  
 catalogue room 262 18  
 catalytic cracking plant 145 70  
 catamaran 284 64; 286 21  
 cataract 11 45

catch *Mach. Parts etc.* 143 29  
 catch *Railw.* 203 57  
 catcher 292 54, 64  
 catchfly 376 20  
 catchment area 12 24  
 catchup 45 43  
 cat cracker 145 48  
 caterpillar 58 64; 82 16, 20, 31, 44, 47; 365 10; 80 3, 8, 14, 17, 29, 44, 48  
 caterpillar hauling scraper 200 16  
 caterpillar mounting 200 3  
 caterpillar tractor 200 3  
 catfish 364 12  
 cathedral 335 1-13, 22  
 catheter 26 31  
 catheter, cardiac ~ 25 53  
 catheter gauge unit 27 30  
 catheter holder 26 30  
 catheterization 27 30  
 cathetus 346 32  
 cathode 178 6  
 cathode ray tube 242 40  
 catkin 59 39; 371 10, 26  
 catkin scale 371 12  
 cat ladder 38 4; 122 63  
 cat litter 99 38  
 cats 368 2-8  
 cat's foot 377 3  
 cat's tail 378 21  
 catsuit 29 19  
 catsup 45 43  
 cattail 378 21  
 cattail flag 378 21  
 cattleship 221 68  
 cattle vessel 221 68  
 catwalk *Iron & Steel* 147 38  
 catwalk *Ship* 221 3  
 catwalk *Theatre* 315 29  
 cauliflower 57 31; 99 84  
 causticizing agitator 172 49  
 causticizing stirrer 172 49  
 caustic soda 169 3, 4, 5, 10; 170 11  
 caustic soda solution 170 10  
 cautery 24 43  
 cavalier hat 355 55  
 cavalry saddle 71 45-49  
 cavalry standard 253 13  
 cave *Phys. Geog.* 13 76  
 cave *Map* 15 85  
 cave, dripstone ~ 13 79  
 cave, limestone ~ 13 79  
 cave art 328 9  
 cave formations 13 80-81  
 cave painting 328 9  
 cavern *Phys. Geog.* 13 76  
 cavern *Park* 272 1  
 cavetto 336 50  
 cavetto vault 336 49  
 caviare knife 45 81  
 cavity 91 36  
 cavity, nasal ~ 17 53  
 cavity, tympanic ~ 17 60  
 cavity of the uterus 20 80  
 cavy 366 12  
 C-clef 320 10  
 cecum 20 17

cedar tree 372 65  
 cedilla 342 33  
 ceiba tree 383 20  
 ceiling 222 63  
 ceiling, concrete ~ 123 28  
 ceiling, false ~ 123 61, 68-69  
 ceiling beam 120 38  
 ceiling construction 123  
 ceiling hook 270 15  
 ceiling joint 126 48  
 ceiling joist 119 5; 120 38; 121 54  
 ceiling light 24 20; 75 8  
 ceiling paper 128 53  
 ceiling paperhanger 128 50  
 ceiling plaster 123 59, 72  
 ceiling tile 317 29  
 celeriac 57 27  
 celesta 325 1  
 Celestial River 3 12  
 Celestial Ship 3 45  
 cell 77 26-30, 27  
 cell, sealed ~ 77 32, 33  
 cella 334 51  
 cellarman 79 18  
 cellar steps, outside ~ 118 4  
 cellar window 37 27; 118 3  
 cell nucleus 357 2  
 cello 323 16  
 cellulose, refined ~ 172 78  
 cellulose, unrefined ~ 172 77  
 cellulose sheet 169 2, 4, 6  
 cellulose xanthate 169 9  
 cembalo 322 45  
 cement *Man* 19 29  
 cement *Bldg. Site* 118 43  
 cement factory 160  
 cement-grinding mill 160 12  
 cementing pump, high-pressure ~ 146 34  
 cement-packing plant 160 16  
 cement screed 123 14  
 cement silo 119 30; 160 15  
 cement storage tank 146 15  
 cement store 201 22  
 cement track racing 290 24-28  
 cementum, dental ~ 19 29  
 cement works 160  
 cemetery 15 106  
 censer 332 38  
 cent 252 19, 33  
 Centaur *Astron.* 3 39  
 Centaur *Fabul. Creat.* 327 52  
 Centaurus 3 39  
 centaur 61 1; 380 10  
 centavo 252 23  
 center *see* centre  
 centerboard *see* centreboard  
 centering *see* centring  
 centime 252 15, 16  
 centimeter *see* centimetre  
 centimetre graduation 247 36  
 centimo 252 22  
 central heating, full ~ 38 38-81  
 central heating furnace 38 57  
 central heating system, coke-fired ~ 38 38  
 central heating system, oil-fired ~ 38 44-60



centre *Turner* 135 8  
 centre *Ball Games* 293 76  
 centre *Maths* 346 26, 43, 55  
 centre, asbestos ~ 350 19  
 centre, live ~ 135 11  
 centre angle 346 55  
 centreboard 284 26  
 centreboard, retractable ~ 284 8; 285 41  
 centreboard case 284 24  
 centre circle 291 2  
 centre console 191 38  
 centre flag 291 64  
 centre girder 222 53  
 centre lathe 149 1  
 centre line *Drawing Off.* 151 30  
 centre line *Sailing* 285 5  
 centre line *Ball Games* 293 8-9, 54  
 centre line *Fencing* 294 4  
 centre line judge 293 25  
 centre mark 293 11  
 centre of curvature 346 23  
 centre of symmetry 351 3  
 centre plate girder 222 53  
 centre punch 134 31; 140 64  
 centre-section fuel tank 257 30  
 centre strake 222 55  
 centrifuge 23 59  
 centrifuge, pendulum-type ~ 168 14  
 centrifuge lid 168 18  
 centring apparatus, universal ~ 111 21  
 centring control 243 10  
 centring ring 240 23  
 centring suction holder 111 22  
 centrosphere 11 5  
 cep 381 16  
 cepe 381 16  
 cephalopod 357 37  
 Cerberus 327 29  
 cereal 68 1  
 cereal product 99 62  
 cereal products 98 35-39  
 cereals 68 1-37  
 cerebellum 17 45; 18 23  
 cerebrum 17 42; 18 22  
 cesta 305 69  
 Cetus 3 11  
 chaffinch 360 10  
 chaffron 329 84  
 chafron 329 84  
 chain 74 14; 75 15; 99 95; 118 30  
 chain *Bicycle* 187 36  
 chain *Cyc. Racing* 290 20  
 chain armour 329 63  
 chain cable 222 77; 223 50; 227 12  
 chain compressor 223 51  
 chain curtain 139 50  
 chain cutter 120 17  
 chain delivery 180 43  
 chain drive 187 35-42  
 chain feeder 74 25  
 chain ferry 216 1

chain grinder, continuous ~ 172 53, 66  
 chain gripper 180 56  
 chain guard 187 37; 188 46  
 chain guide 120 15  
 chain mail 329 63  
 chain mortiser 132 49  
 chain mortising machine 132 49  
 chain reaction 1 41, 48  
 chain saw 120 14  
 chain sling *Forging* 139 44  
 chain sling *Docks* 226 26  
 chain stay 187 20  
 chain stitch 102 2  
 chain-tensioning device 157 41  
 chain transmission 187 35-39  
 chain wheel 187 35  
 chair 42 34; 271 35  
 chair, adjustable ~ 105 17; 106 16  
 chair, barber's ~ 106 16  
 chair, cane ~ 43 3  
 chair, dentist's ~ 24 3  
 chair, double ~ 214 18  
 chair, folding ~ 28 33  
 chair, gaffer's ~ 162 45  
 chair, glassmaker's ~ 162 45  
 chair, hairdresser's ~ 105 17; 106 16  
 chair, single ~ 214 16  
 chair, steel ~ 67 2  
 chair, tubular steel ~ 41 21  
 chair, two-seater ~ 214 17, 18  
 chair, umpire's ~ 293 20  
 chair, visitor's ~ 246 21  
 chair grip 21 21  
 chair lift 214 16-18  
 chair lift, double ~ 301 57  
 chairman 263 1  
 chairman of board of directors 251 16  
 chairman of board of governors 251 15  
 chairplane 308 4  
 chaise 186 34  
 chaise, closed ~ 186 54  
 chaise, covered ~ 186 54  
 chaise, one-horse ~ 186 29  
 chaitya 337 28  
 chaitya hall 337 27  
 chalaza 74 63  
 chalcography 340 14-24  
 chalet 278 7  
 chalice 330 10; 332 49  
 chalk 48 15; 260 32; 338 5  
 chalk, French ~ 104 24  
 chalk, tailor's ~ 104 24  
 chalk ledge 260 31  
 chalk sketch 338 4  
 chalwar 306 42  
 Chamaeleontidae 364 33  
 chamber *Atom* 1 66  
 chamber *Forest Pests* 82 36  
 chamber *Hunt.* 87 20  
 chamber *Water* 269 24  
 chamber, king's ~ 333 2  
 chamber, photographic ~ 113 40  
 chamber, queen's ~ 333 3

chamber, stone ~ 328 39  
 chamber wall 269 25  
 chameleon 364 33  
 chamfer 143 62  
 chamfering hammer 125 14  
 chamfrain 329 84  
 chamfron 329 84  
 chamois 367 3  
 chamomile 61 8; 380 1  
 chamotte slab 141 16  
 champagne 99 78  
 champagne bucket 267 59  
 champagne cooler 267 59  
 champagne cork 267 58  
 champagne glass 45 86  
 champagne glasses 45 85-86  
 chancel 330 1, 32; 335 4  
 chandelier 267 21  
 chanfron 329 84  
 'change' *Airport* 233 51  
 change *Winter Sp.* 302 12  
 change-gear box 149 7  
 change-gear handle 132 56  
 change gears 10 14  
 change-loop 302 16  
 change machine 197 33; 204 22; 236 28  
 changemaker 236 28  
 changeover switch 50 59; 243 15  
 change points, electric ~ 197 37  
 change rack 236 23  
 change-speed gear 163 29; 211 50  
 change wheel 164 40  
 changing booth 271 32  
 changing cubicle 282 1  
 changing room 282 3  
 changing top 28 4  
 changing unit 28 11  
 channel *Overh. Irrign.* 67 13  
 channel *Railw.* 202 32  
 channel *Swim.* 281 9  
 channel *Rowing* 283 60  
 channel *Art* 334 27  
 channel, distributary ~ 13 2  
 channel, navigable ~ 224 92, 93  
 channel iron 143 7  
 channel markings 224 84-102  
 channel marks 224 68-83  
 chantarelle 381 14  
 chanter 322 10  
 chanterelle 381 14  
 chapel *Map* 15 61, 107  
 'chapel' *Airport* 233 49  
 chapel *Chivalry* 329 29  
 chaplet 34 32  
 chaplet hairstyle 34 31  
 chaps 70 26  
 chapter heading 185 60  
 char-a-banc, covered ~ 186 33  
 character 174 7, 44; 175 38  
 characteristic 345 6  
 characteristic light 221 48; 224 105  
 character storage 242 37  
 charcoal 278 48  
 charcoal, activated ~ 270 58

charcoal grill 278 47  
 charcoal pencil 338 16  
 chard 57 28  
 charge postmark 236 58  
 charger 25 51  
 charging car 144 8; 156 6  
 charging chamber 154 79  
 charging conveyor 144 42  
 charging door 38 61; 139 4  
 charging machine 147 25  
 charging opening 139 49  
 charging platform 147 4  
 charging position 147 55, 56  
 Charioteer 3 27  
 charity performance 319 31  
 Charles's Wain 3 29  
 Charleston cymbals 324 50  
 charlock 61 18  
 charm 36 35  
 chart 22 32; 76 8; 260 30  
 chart, illustrated ~ 22 16  
 chase 181 38  
 chasing 87 28  
 chasing hammer 108 41  
 chassis *Overh. Irrign.* 67 14  
 chassis *Blacksm.* 138 28  
 chassis *Car* 191 2  
 check *Roulette* 275 12  
 check *Theatre* 315 7  
 check *Music. Instr.* 325 27  
 check brake 143 97  
 checker 276 18, 19  
 checkerboard 276 17  
 checkerman 276 18, 19  
 checkers 276 17-19  
 check felt 325 28  
 check light 195 21, 22  
 checkmate 276 15  
 checkout 99 92  
 check rail 202 23  
 checkroom 315 5; 318 1  
 checkroom attendant 315 6; 318 2  
 checkroom hall 315 5-11  
 check side 277 6  
 cheek *Man* 16 9  
 cheek *Hunt.* 87 4  
 cheekbone 16 8; 17 37  
 cheek piece 71 8  
 cheek rest 255 30  
 cheek strap 71 8  
 cheese 98 5; 99 49; 266 52  
 cheese, cross-wound ~ 164 58  
 cheese, round ~ 99 42  
 cheese, whole ~ 99 40  
 cheeseboard 45 35  
 cheesecake 97 23  
 cheese counter 99 39  
 cheese dish 40 7  
 cheese fly 81 15  
 cheese knife 45 72  
 cheese machine 76 47  
 cheetah 368 7  
 chef 207 34  
 chelicer 358 41  
 cheliped 358 41  
 chemical bottle 116 10; 261 23  
 'chemist' 233 45  
 chemistry 261 1-13  
 chemistry laboratory 261 1; 349; 350

chemistry teacher 261 2  
 chequer-board cut 36 66  
 cheroot 107 4  
 cherry *Drupes & Nuts* 59 5, 6-8  
 cherry *Goldsm. etc.* 108 7  
 cherry *Bot.* 370 99  
 cherry blossom 59 3  
 cherry fan 97 22  
 cherry flower 59 3  
 cherry fruit 59 6-8  
 cherry fruit fly 80 18  
 cherry leaf 59 2  
 cherry stone 59 7  
 cherry tree 59 1, 11-18  
 cherub 272 20  
 chess 265 17; 276 1-16  
 chessboard 47 20; 276 1  
 chessboard square 276 2  
 chess championship 276 16  
 chess clock 276 16  
 chessman 276 1, 4, 5, 7  
 chess match 276 16  
 chess move 276 6  
 chess player 265 17  
 chess problem 276 6  
 chess square 276 6  
 chest *Man* 16 28-30; 17 8-11  
 chest *Paperm.* 172 25  
 chest grip 21 37  
 chestnut *Horse* 72 27  
 chestnut *Decid. Trees* 371 60  
 chestnut *South. Fruits* 384 52  
 Chestnut Boletus 381 15  
 chestnut tree 371 58  
 chest of drawers 41 8  
 chevron design 335 16  
 chew 107 19  
 chewing tobacco 107 19  
 Chianti 98 61; 99 77  
 chibonk 107 32  
 chibonque 107 32  
 chick 74 2  
 chicken 62 36; 73 19-26; 96 24  
 chicken run 74 11  
 chick-pea 69 19  
 chick unit 74 1  
 chicory 57 40  
 chief 254 18-19  
 chignon 34 29  
 child 260 3  
 child, small ~ 28 42  
 child carrier seat 187 21  
 children's room 47  
 chilling roll 180 28  
 chill roller 180 28  
 chimera 327 16  
 chimney *Map* 15 38  
 chimney *Dwellings* 37 10  
 chimney *Roof & Boilerr.* 38 5  
 chimney *Bldg. Site* 118 21  
 chimney *Carp.* 120 47  
 chimney *Roof* 122 13  
 chimney *Blacksm.* 137 7  
 chimney *Power Plant* 152 15  
 chimney *Energy Sources* 155 12  
 chimney *Railw.* 210 22  
 chimney *Mountain.* 300 8  
 chimney bond 118 66

chimney brick 159 28  
 chimney flashing 122 14  
 chimney swallow 361 20  
 chimney sweep 38 31  
 chimney sweeper 38 31  
 chimpanzee 368 14  
 chin 16 15  
 china, broken ~ 260 61  
 china cabinet 44 26  
 china manufacture 161  
 china painter 161 17  
 China rose 60 15  
 chinband 355 22  
 chinch 81 39  
 chinchona 380 17  
 Chinese lantern 52 15  
 chine strake 258 8  
 chin rest 323 8  
 chintuft 34 10  
 chip *Basketm.* 136 12  
 chip *Roulette* 275 12  
 chip basket 136 11  
 chip container 170 40  
 chip crusher 172 5  
 chip distributor 172 3  
 chip extractor 157 51  
 chip-extractor opening 132 48  
 chip packer 172 3  
 chip pan 40 41  
 chipper 172 1  
 chipping hammer *Blacksm.* 137 38  
 chipping hammer *Gas Weld.* 141 25  
 chipping hammer *Arc Weld.* 142 17  
 chip remover 157 50  
 chiropter 366 9  
 chiropteran 366 9  
 chisel 120 71  
 chisel, bevelled-edge ~ 132 7; 339 19  
 chisel, blacksmith's ~ 137 38  
 chisel, broad ~ 158 37  
 chisel, flat ~ 140 26; 339 14  
 chisel, hollow ~ 339 17  
 chisel, pneumatic ~ 148 45  
 chisel, toothed ~ 339 13  
 chisels 132 7-11  
 chitarrone 324 1  
 chiton 355 5  
 Chitonactis 369 20  
 chivalry 329  
 hive 57 22  
 chlorine 170 7  
 chlorine ion 1 10  
 chlorobenzene 170 9, 11  
 chock *Bldg. Site* 119 40  
 chock *Iron Foundry etc.* 148 61  
 chocolate 98 80  
 chocolate, bar of ~ 98 78  
 chocolate box 98 79  
 chocolate liqueur 98 83  
 choir 330 32; 335 4  
 choke cymbals 324 50  
 choke flap 192 6  
 choker 36 16  
 choker collar 355 74  
 cholecystography 27 4



Chopper 188 56  
 chopper drum 64 34  
 chopping board 96 57  
 chord *Aircraft* 230 56  
 chord *Music. Not.* 321 1-5, 5  
 chord *Maths.* 346 51  
 chord, lower ~ 121 73, 79  
 chord, upper ~ 121 74, 80  
 chorus 315 21  
 chow 70 21  
 christening 332 1  
 christening dress 332 8  
 christening robe 332 8  
 christening shawl 332 9  
 chromatic scale 320 49  
 chromolithograph 340 28  
 chronometer 230 11  
 chrysalis 77 30, 32; 80 4, 25,  
 43; 81 3, 21, 24; 82 13, 21,  
 32; 358 20; 365 11  
 chrysanthemum 51 29; 61 7  
 chuck *Meat* 95 19  
 chuck *D.I.Y.* 134 48  
 chuck *Turner* 135 6  
 chuck, four-jaw ~ 149 35  
 chuck, independent ~ 149 35  
 chuck, quick-action ~ 132 54  
 chuck, self-centring ~ 149 37  
 chuck, three-jaw ~ 149 37  
 chuck, two-jaw ~ 135 10  
 church 15 53, 61, 107; 330;  
 331 1; 332  
 church, Baroque ~ 336 1  
 church, Gothic ~ 335 22  
 church, Protestant ~ 330 1-30  
 church, Renaissance ~ 335 42  
 church, Roman Catholic ~  
 330 31-62  
 church, Romanesque ~ 335  
 1-13  
 church banner 331 44  
 church clock 331 7  
 church door *Church* 331 16  
 church door *Art* 335 24  
 churchgoer 330 29; 331 17  
 church landmark 15 64  
 church organ 326 1-52  
 church owl 362 17  
 church roof 331 11  
 church spire 331 6  
 church wedding 332 14  
 church window 330 14  
 churchyard 331 21-41  
 churchyard gate 331 19  
 churchyard wall 331 18  
 chute *Docks* 226 45  
 chute *Fair* 308 40  
 chute, spiral ~ 144 28  
 chute, three-way ~ 92 34  
 ciborium 332 48  
 cigar, Brazilian ~ 107 2  
 cigar and cigarette boy 267 49  
 cigar box 107 1  
 cigar case 107 8  
 cigar cutter 107 9  
 cigarette, filter-tipped ~ 107  
 12  
 cigarette, Russian ~ 107 14  
 cigarette beetle 81 25  
 cigarette case 107 10  
 cigarette holder 107 16

cigarette lighter 107 27, 30  
 cigarette machine 268 69  
 cigarette packet 107 11  
 cigarette paper 107 17  
 cigarette roller 107 15  
 cigarettes and tobacco kiosk  
 204 47  
 cigarette seller 308 51  
 cigarette tip 107 13  
 cigarette tray 267 50  
 cigarillo 107 3  
 cigar lighter 191 88  
 ciliate 370 49  
 cilium *Man* 19 41  
 cilium *Invertebr.* 357 10  
 cilium *Bot.* 370 50  
 cinchona 380 17  
 cinnabum 77 30, 32; 80 4, 25,  
 43; 81 3, 21, 24; 82 13, 21,  
 32; 358 20; 365 11  
 cine camera 117 1  
 cine film 117  
 cinema 312 1  
 cinema, mobile ~ 312 52  
 cinema advertisement 268 57  
 cinema audience 312 5  
 cinema box office 312 2  
 cinemagoer 312 5  
 cinema projector 312 24  
 cinema projector, narrow-  
 gauge ~ 312 52  
 cinemascope camera 310 47  
 cinema ticket 312 3  
 cine projector 117 78; 318 20  
 cinnamon 382 25  
 cinnamon bark 382 25  
 cinnamon tree 382 22  
 cinquefoil 335 40  
 circle *Sports* 305 31  
 circle *Maths.* 346 42  
 circle, circumscribed ~ 346 29  
 circle, divided ~ *Optic. Instr.*  
 113 27  
 circle, divided ~ *Crystals* 351  
 32  
 circle, graduated ~ *Optic.*  
*Instr.* 113 27  
 circle, graduated ~ *Crystals*  
 351 32  
 circle, inner ~ 288 57  
 circle, inscribed ~ 346 31  
 circle, middle ~ 288 58  
 circle, outer ~ 288 59  
 circle, upper ~ 315 17  
 circles, concentric ~ 346 58  
 circles, polar ~ 14 11  
 circle template 151 70  
 circling engagement 294 49  
 circuit, integrated ~ *Clocks*  
 110 16  
 circuit, integrated ~ *Inf.*  
*Tech.* 242 68  
 circuit, primary ~ 154 2, 42  
 circuit, secondary ~ 154 7, 45  
 circuit breaker 127 19, 33, 36;  
 152 34; 153 51-62  
 circuit breaker, miniature ~  
 41 20  
 circuit breaker consumer unit  
 127 33  
 circular broom 199 40  
 circular saw attachment 84  
 33; 134 52

circular saw blade 132 59  
 circulation, atmospheric ~ 9  
 46-52  
 circulation pump 154 43, 54  
 circulatory system 18 1-21  
 circumcircle 346 29  
 circumference *Cooper* 130 23  
 circumference *Maths.* 346 44  
 circumference, staved ~ 130 2  
 circumflex 342 32  
 circus 307  
 circus, travelling ~ 307 1-63  
 circus act 307 25  
 circus attendant 307 27  
 circus band 307 10  
 circus box 307 16  
 circus caravan 206 20; 307 34  
 circus horse 307 30  
 circus manager 307 17  
 circus marksman 307 38  
 circus rider 307 26  
 circus tent 307 1  
 circus trailer 307 34  
 cirrocumulus 8 14  
 cirrostratus 8 7  
 cirrus 8 6  
 cist, long ~ 328 16  
 cist, stone ~ 328 17  
 cistern 49 16  
 cithara 322 15  
 cittern 322 21  
 city 15 51  
 city banner 218 22  
 city wall 333 30  
 Claisen flask 350 50  
 clamp *Atom* 2 43  
 clamp *Overh. Irrign.* 67 30  
 clamp *Goldsm. etc.* 108 34  
 clamp *Joiner* 132 51; 133 9  
 clamp *Bookbind.* 183 18; 185  
 3  
 clamp *Chem.* 350 33  
 clamp, horizontal ~ 14 57  
 clamp, vertical ~ 14 55  
 clamp handle 133 8  
 clamping device *Atom* 2 43  
 clamping device *Mach. Tools*  
 150 15  
 clamping plate, hinged ~ 117  
 90  
 clamping screw 133 23  
 clamping shoe 133 10  
 clamp lever 132 67  
 clamp tip 149 46  
 clamp tip tool 149 45  
 clapper *Carnival* 306 47  
 clapper *Films* 310 35  
 clapper board 310 35  
 clapper boy 310 34  
 clappers 162 42  
 clarinet 318 4; 323 34  
 clarinetist 318 5  
 clasp, white gold ~ 36 10  
 clasp nut 149 19  
 classes, social ~ of bees 77  
 1, 4, 5  
 classification siding 206 47  
 classification track 206 47  
 classification yard 206 42  
 classification yard switch  
 tower 206 44

classifier 172 50  
 classroom 260 1-45  
 classroom cupboard 260 43  
 clavicembalo 322 45  
 clavichord 322 36  
 clavichord mechanism 322 37  
 clavicle 17 6  
 clavilux 317 13  
 claw 327 3; 362 7  
 claw, bird's ~ 327 61  
 claw, double ~ 77 8  
 claw chisel 339 13  
 claw head 120 75  
 claws, griffin's ~ 327 13  
 clay 160 1; 260 79; 339 8, 31  
 clay, impure ~ 159 2  
 clay, raw ~ 159 2  
 clay box 339 30  
 clay column *Brickwks.* 159 14  
 clay column *Porcelain.*  
*Manuf.* 161 8  
 clay pigeon shooting 305  
 70-78  
 clay pit *Map* 15 88  
 clay pit *Brickwks.* 159 1  
 cleaner, centrifugal ~ 173 11  
 cleaner, ultrasonic ~ 109 23  
 cleaning brush *Hunt.* 87 62  
 cleaning brush *Office* 247 10  
 cleaning fluid 111 32  
 cleaning machine *Brew.* 92 36  
 cleaning machine *Watchm.*  
 109 30  
 cleaning plant 144 20  
 cleaning rag 50 55  
 cleaning rod 87 61  
 cleaning shop 148 38-45  
 cleaning tank 178 1  
 cleaning tow 87 63  
 cleanout door 38 39  
 cleansing pond 89 6  
 clear-felling system 84 4-14  
 clearing *Map* 15 2  
 clearing *Forestry* 84 13  
 clearstory 334 70  
 clear *Carp.* 120 45  
 cleat *Floor etc. Constr.* 123 67  
 cleaver, butcher's ~ 94 18  
 cleaving hammer 85 5  
 clefs 320 8-11  
 cleft, anal ~ 16 41  
 clench planking 285 50-52  
 clerestory 334 70  
 clergyman 330 22; 331 37;  
 332 22  
 clergyman, Protestant ~ 332 3  
 clerical assistant 248 7  
 clerk 263 26, 27  
 clew 284 41  
 click 110 34  
 click beetle 80 37, 38  
 click wheel 110 35  
 cliff 13 28  
 cliff face 13 28  
 cliffline 13 25-31  
 cliffs 13 25-31  
 climate, artificially  
 maintained ~ 356 21  
 climate, boreal ~ 9 56  
 climate, equatorial ~ 9 53  
 climates 9 53-58

climates, polar ~ 9 57-58  
 climatic map 9 40-58  
 climatology 9  
 climber *Flower Gdn.* 51 5  
 climber *Fruit & Veg. Gdn.* 52  
 5  
 climber *Indoor Plants* 53 2  
 climber *Veg.* 57 8  
 climber *Mountain.* 300 5  
 climbing 300 2-13  
 climbing boot 300 44  
 climbing breeches 300 7  
 climbing equipment 300  
 31-57  
 climbing frame 273 47  
 climbing harness 300 56  
 climbing net 273 50  
 climbing plant 53 2  
 climbing roof 273 60  
 climbing rope 273 48; 296 19  
 climbing tower 273 17  
 clinch 299 31  
 clinker cooler 160 9  
 clinker pit 152 8  
 clinker planking 285 50-52  
 clinker store 160 10  
 clinopinacoid 351 24  
 clip *Atom* 2 18  
 clip *Bicycle* 187 62  
 clip *Railw.* 202 9  
 clipper display 238 44  
 clippers, electric ~ 105 21; 106  
 32  
 clipper ship, English ~ 220 36  
 clitelium 357 26  
 Clitoria 20 88  
 Clivia minata 53 8  
 cloak 355 18, 26  
 cloak, red ~ 319 27  
 cloak, short ~ 355 29  
 cloak, Spanish ~ 355 29  
 cloak, woollen ~ 355 6  
 cloak cord 355 24  
 cloakroom 48 34; 207 70; 315  
 5; 318 1  
 cloakroom attendant 315 6;  
 318 2  
 cloakroom hall 315 5-11  
 cloakroom ticket 315 7  
 cloche 35 12  
 clock 191 38; 211 37; 212 16  
 clock, double ~ 276 16  
 clock, electric ~ 191 79  
 clock, main ~ 245 18  
 clock case 110 26; 309 57  
 clockmaker 109 1  
 clocks 110  
 clockwork 110 36  
 clockwork drive 10 14  
 clockwork mechanism 110 36  
 clod 63 7  
 clog 101 44; 355 43  
 cloister 331 52  
 cloister vault 336 41  
 closed vertical gate 301 66  
 close-up bellows attachment  
 115 85  
 close-up equipment 115  
 81-98  
 close-up lens 117 55  
 closing gear 90 27

closing head 143 59  
 closure rail 202 26  
 cloth 166 12; 271 59  
 cloth, damask ~ 45 2  
 cloth, felt ~ 340 42  
 cloth, flannel ~ 128 48  
 cloth, linen ~ 206 11  
 cloth, sterile ~ 26 38  
 cloth, unraised ~ 168 33  
 clothes, children's ~ 29  
 clothes, teenagers' ~ 29 48-68  
 clothes brush 50 44; 104 31  
 clothes closet 43 1  
 clothes closet door 46 2  
 clothes compartment 212 63;  
 267 30  
 clothes line 38 23; 50 33  
 clothes louse 81 41  
 clothes moth 81 13  
 clothes rack 271 31  
 clothes rack, movable ~ 103  
 17  
 clothes shop 268 9  
 clothing, protective ~ 84 26;  
 270 46  
 cloth roller 166 20  
 cloth-shearing machine,  
 rotary ~ 168 42  
 cloth take-up motion 166 19  
 cloth take-up roller 166 47  
 cloth temple 166 13  
 cloud, lenticular ~ 287 19  
 cloud chamber photograph 2  
 26  
 cloud chamber track 2 27  
 cloud cover 9 20-24  
 clouds 8 1-19, 1-4, 5-12,  
 13-17  
 clouds, luminous ~ 7 22  
 clouds, noctilucent ~ 7 22  
 clout 121 94  
 clout nail 121 94; 122 96  
 clove 382 28  
 clove carnation 60 7  
 clove pink 60 7  
 clover, four-leaf ~ 69 5  
 clover broadcaster 66 26  
 clove tree 382 26  
 clown 306 69; 307 24  
 clown, musical ~ 307 23  
 clown act 307 25  
 club 283 23  
 club hammer 126 77  
 clubhouse 283 23  
 club membership 286 8  
 club rush 378 21  
 clubs 276 38  
 clump of grass 375 44  
 cluster of eggs 80 2, 30  
 cluster of grapes 78 5  
 cluster of stars 3 26  
 clutch 191 44  
 clutch, dry ~ 190 78  
 clutch, fluid ~ 65 37  
 clutch, main ~ 65 39  
 clutch, multi-plate ~ 190 78  
 clutch, single-plate ~ 190 71  
 clutch coupling 227 23  
 clutch flange 177 55  
 clutch lever 188 32  
 clutch pedal 191 44, 96; 192 28



C major 320 55, 62  
 C major scale 320 45  
 C minor 320 59, 65  
 coach *Lorries etc.* 194 17  
 coach *Ball Games* 291 55; 292 57  
 coach, four-axled ~ 208 3  
 coach, second ~ 209 7  
 coach body 186 5; 207 2; 208 6  
 coach bolt 202 7  
 coach box 186 8  
 coach door 186 11  
 coaches 186  
 1-3, 26-39, 45, 51-54  
 coach horse 186 28  
 coachman 186 32  
 coach screw 202 7  
 coach step 186 13  
 coach wagons 186  
 1-3, 26-39, 45, 51-54  
 coagulating bath 169 15  
 coal 170 1  
 coal bunker 152 2; 225 19  
 coal conveyor 152 1  
 coal distillation, dry ~ 170 2  
 coal feed conveyor 199 37  
 coal mill 152 4  
 coal mine 144 1-51  
 coal scuttle 309 9  
 coal seam 144 50  
 coal shovel 38 43  
 coal tar 170 3  
 coal tar extraction 156 18  
 coal tower 156 5  
 coal tower conveyor 156 4  
 coal wharf 225 18  
 coaming 283 59  
 coarse dirt hose 50 84  
 coarse fishing 89 20-31  
 coastal cruiser 284 60  
 coastal lake 13 44  
 coaster 221 99  
 coaster brake 187 63  
 coasting vessel 221 99  
 coat 29 54; 30 60  
 coat, black ~ 289 4  
 coat, braided ~ 186 23  
 coat, cloth ~ 30 61; 33 66  
 coat, dark ~ 289 4, 13  
 coat, fur ~ 30 60  
 coat, gallooned ~ 186 23  
 coat, loden ~ 29 31; 30 64  
 coat, loose-fitting ~ 271 41  
 coat, mink ~ 131 24  
 coat, ocelot ~ 131 25  
 coat, oilskin ~ 228 7  
 coat, poncho-style ~ 30 68  
 coat, poplin ~ 33 60  
 coat, red ~ 289 13  
 coat, three-quarter length ~ 271 21  
 coat belt 33 59  
 coat button 33 64  
 coat collar 33 58  
 coater 173 31, 34  
 coat hanger 41 3  
 coat hook 41 2; 207 50; 266 14  
 coating, bituminous ~ 200 58

coating of fluorescent material 240 19  
 coat-of-arms 254 1-6  
 coat-of-arms, marshalled ~ 254 10-13  
 coat-of-arms, provincial ~ 252 12, 14  
 coat pocket 33 61  
 coat rack 41 1  
 coat stand 266 12  
 coat-tail 33 14  
 cob 59 49  
 cobalt bomb 2 28  
 cobnut 59 49  
 coccinellid 358 37  
 coccyx 17 5; 20 60  
 cochlea 17 63  
 cock *Farm Bldgs.* 62 37  
 cock *Dom. Anim.* 73 21  
 cockade 264 8  
 cockatrice 327 34  
 cockchafer 82 1  
 cockchafer grub 82 12  
 cocker spaniel 70 38  
 cocking handle 255 12  
 cocking lever 255 12  
 cocking piece 121 30  
 cock pheasant 88 77  
 cock pigeon 73 33  
 cockpit *Aircraft* 230 1-31, 35; 231 19  
 cockpit *Police* 264 2  
 cockpit *Rowing* 283 8  
 cockpit *Sailing* 285 38  
 cockpit *Airports* 288 10  
 cockpit canopy 230 39; 257 4  
 cockpit coaming 283 59  
 cockpit hood 230 39; 257 4  
 cockroach 81 17  
 cockscorb 73 22  
 cock's foot 69 25  
 cock's head 69 10  
 cock's tread 74 65  
 cocktail 317 33  
 cocktail fork 45 76  
 cocktail glass 267 56  
 cocktail shaker 267 61  
 cocoa *Grocer* 98 66  
 cocoa *Trop. Plants* 382 19  
 cocoa bean 382 19  
 cocoa palm 383 48  
 cocoa powder 382 19  
 coconut 383 53  
 coconut oil 98 23  
 coconut palm 383 48  
 coconut tree 383 48  
 cocoon *Forest Pests* 82 21  
 cocoon *Articulates* 358 51  
 coco palm 383 48  
 cocotte 306 37  
 cod 90 22  
 code flag halyard 223 10  
 code flag signal 223 9  
 cod end 90 22  
 code pendant 253 29  
 code pennant 253 29  
 coding keyboard 242 11  
 coding station 236 35  
 cod line 90 23  
 codling moth 58 62  
 codlin moth 58 62

coefficient 345 4  
 coelenterate 357 14; 369 5, 9, 14, 20  
 coffee 98 65-68, 67; 99 68-70, 68; 265 19  
 coffee *Trop. Plants* 382 6  
 coffee, instant ~ 99 70  
 coffee, pure ~ 98 65  
 coffee bean 382 6  
 coffee cup 44 29  
 coffee grinder, electric ~ 39 24; 98 69  
 coffee maker 39 38  
 coffee plant 382 1  
 coffee pot 44 28  
 coffee roaster 98 70  
 coffee service 44 27  
 coffee set 44 27; 265 18  
 coffee table 42 28  
 coffee tree 382 1  
 coffee urn 265 2  
 cofferdam 259 19  
 coffin 331 35  
 coffin chamber 333 5  
 cog *Mach. Parts etc.* 143 83  
 cog *Ship* 218 18-26  
 cog, wooden ~ 91 9  
 cognac 98 59  
 cog railroad 214 4-5  
 cog railway 214 4-5  
 cog wheels 143 82-96  
 coiffure, upswept ~ 355 81  
 coiffures 34 27-38  
 coil 89 21  
 coiled-coil filament 127 58  
 coiler 148 72  
 coiler top 163 62  
 coil spring 191 28; 192 68  
 coin 252 1-28  
 coin, Celtic ~ 328 37  
 coin, gold ~ 36 37  
 coin, silver ~ 328 37  
 coinage 252 1-28, 40-44  
 coin-box telephone 236 9; 237 3  
 coin bracelet 36 36  
 coin disc 252 43  
 coining dies 252 40-41  
 coining press 252 44  
 coins 252 1-28  
 coins, aluminium ~ 252 1-28  
 coins, copper ~ 252 1-28  
 coins, gold ~ 252 1-28  
 coins, nickel ~ 252 1-28  
 coins, silver ~ 252 1-28  
 coin setting 36 38  
 coke 147 2  
 coke guide 156 9  
 coke loading 156 15  
 coke loading bay 156 12  
 coke oven 144 7; 156 8, 16  
 coke-oven gas processing 156 16-45  
 coke-quenching car 144 11  
 coke-quenching tower 144 10  
 cokernut 383 53  
 coke side bench 156 13  
 coke wharf 156 12  
 coking coal 156 1  
 coking coal tower 144 9  
 coking plant *Coal* 144 7-11

coking plant *Coking* 156 1-15  
 coking plant *Synth. Fibres* 170 2  
 col 12 47  
 cold-drawing 170 46  
 cold house 55 33  
 cold light source 23 8  
 cold room 94 21-24  
 cold shelf 96 12; 98 3  
 cold storage room 223 56  
 cold store 94 21-24; 225 50  
 cold tap 126 29  
 cold water tank 92 9  
 cole 383 1  
 Coleoptera 358 24-39  
 coleseed 383 1  
 collar *Jewell.* 36 16  
 collar *Dog* 70 13  
 collar *Game* 88 27  
 collar *Roof* 121 35, 70  
 collar *Money* 252 42  
 collar *Church* 332 6  
 collar *Fish etc.* 364 39  
 collar, braided ~ 186 22  
 collar, cowl ~ 30 3  
 collar, Dutch ~ 71 28  
 collar, fur ~ 30 63  
 collar, fur-trimmed ~ 30 63  
 collar, gallooned ~ 186 22  
 collar, ground glass ~ 115 53, 64  
 collar, high ~ 355 74  
 collar, integral ~ 143 33  
 collar, knitted ~ 33 31  
 collar, matt ~ 115 53, 64  
 collar, padded ~ 101 20  
 collar, pointed ~ 71 15  
 collar, stand-up ~ 30 43  
 collar, turndown ~ 30 5; 31 69  
 collar, wide-falling ~ 355 56  
 collar beam 121 35, 38, 70  
 collar beam roof 121 34  
 collar beam roof structure 121 37  
 collar bearing 148 73  
 collarbone 17 6  
 collating machine 249 59  
 collating station 249 60  
 collecting bin 201 20  
 collecting hopper 92 20  
 collecting tank 172 26  
 collecting vessel 10 40, 45  
 collection 74 36  
 collection bag 236 51  
 collector 155 19  
 collector bow 205 36  
 collector well 269 4  
 college 262 1-25  
 colliery 144 1-51  
 collimator 111 46; 351 30  
 colon 342 17  
 colon, ascending ~ 20 19  
 colon, descending ~ 20 21  
 colon, transverse ~ 20 20  
 colonnade 274 9; 334 67  
 colophony 323 11  
 color see colour  
 Colorado beetle 80 52  
 colour 343  
 colour analyser 116 36  
 colour analyser lamp 116 37

colour chemicals 116 52  
 colour computer 177 51  
 colour conversion filter step 117 38  
 colour correction, selective ~ 177 51  
 colour correction unit 177 39  
 colour decoder module 240 5  
 colour developer 116 10  
 colour enlarger 116 40  
 colour filter 316 49  
 colour indicator 127 37  
 colour light distant signal 203 9, 14  
 colour light signal 203 3  
 colour medium 316 49  
 colour-mixing knob 116 43-45  
 colour organ 317 13  
 colour output stage module 240 13  
 colour pickup tube 240 36  
 colour picture tube 240 15  
 colour print 340 28  
 colour printing paper 116 51  
 colour processing chemicals 116 52  
 colours of the rainbow 343 14  
 colour television receiver 240 1  
 colour television set 240 1  
 colposcope 23 5  
 coltsfoot 380 8  
 colubrid 364 38  
 Columbian 175 30  
 columbine *Gdn. Flowers* 60 10  
 Columbine *Carnival* 306 27  
 column *Photog.* 116 42  
 column *Forging* 139 10  
 column *Mach. Tools* 150 10  
 column *Bookbind.* 185 65  
 column *Script* 342 45  
 column *Chem.* 349 29  
 column, angled ~ 116 28  
 column, bent ~ 113 21  
 column, central ~ 114 46  
 column, Corinthian ~ 334 10  
 column, Doric ~ 334 8  
 column, Ionic ~ 334 9  
 column, ornamented ~ 333 18  
 column, spinal ~ 17 2-5  
 column, vertebral ~ 17 2-5  
 column box 119 11, 73  
 column heading 342 46  
 column rule 342 47  
 column shaft 334 26  
 coma position 21 24  
 comb *Infant Care etc.* 28 8  
 comb *Dom. Anim.* 73 22  
 comb *Hairdresser* 105 6  
 comb, adjustable ~ 165 26  
 comb, top ~ 163 67  
 combat sports 299  
 comber 163 56, 63  
 comber draw box 163 60  
 comb foundation 77 43  
 combination, two-piece ~ 30 45  
 combination cutting pliers 126 60; 127 53

combination lever 210 30  
 combination rib weave 171 25  
 combination toolholder 149 41  
 combine 64 1-33  
 combined grasp 296 42  
 combine harvester 63 31; 64 1-33  
 combing cylinder 163 68  
 combing machine 163 56  
 comb setting 165 36  
 combustion chamber 232 37  
 combustion chamber, external ~ 147 16  
 comfrey 375 45  
 comic turn 307 25  
 comma 342 18  
 command key 247 21  
 command module 6 9  
 command section 234 65  
 commencement of speed restriction 203 39, 42  
 commissionaire 267 1; 271 44; 315 10  
 commissure, labial ~ 16 14; 19 19  
 committee 263 1-2  
 committee boat 285 15  
 committee member 263 2  
 committee table 263 3  
 common box 373 19  
 common buzzard 362 9  
 common comfrey 69 13  
 common denominator 344 19  
 common dolphin 367 24  
 common European kite 362 11  
 common flea 81 42  
 common groundsel 61 12  
 common heron 359 18  
 common housefly 81 2  
 common iguana 364 32  
 common mallow 376 13  
 common merganser 359 15  
 common myrtle 53 11  
 common nightshade 379 5  
 common orache 61 24  
 common pheasant 88 77  
 common privet 373 6  
 common puffball 381 20  
 common roller 360 6  
 common salt 170 13  
 common seal 367 19  
 common sea-swallow 359 11  
 common silver fir 372 1  
 common swallow 361 20  
 common time 320 32  
 common toadflax 376 26  
 common vetch 69 18  
 common viper 364 40  
 communicant 332 27  
 communication line 127 23  
 communication link 237 50  
 communications satellite 237 52  
 communion cup 330 10; 332 29  
 communion table 330 4  
 communion wafer 332 50  
 commutator cover 211 18  
 companion hatch 258 24



companion ladder 221 123; 223 24; 258 24  
 companionway 221 123; 222 23; 223 24; 258 24  
 company account 250 4  
 company messenger 236 17  
 compartment *Forestry* 84 2  
 compartment *Railw.* 207 13; 208 24  
 compartment *Store* 271 6  
 compartment, secretarial ~ 205 37; 209 25  
 compartment, special ~ 205 26  
 compartment, twin-berth ~ 207 38  
 compartment, two-berth ~ 207 38  
 compartment, two-seat ~ 207 38  
 compartment batten 316 13  
 compartment door 207 14  
 compartment window 207 52; 208 8  
 compass *Drawing Off.* 151 52  
 compass *Airsports* 288 12  
 compass, divisions of ~ 321 42-50  
 compass, fluid ~ 224 46  
 compass, gyroscopic ~ 224 31, 51-53  
 compass, liquid ~ 224 46  
 compass, magnetic ~ 223 6; 224 46; 230 6  
 compass, mariner's ~ 223 6  
 compass, ratchet-type ~ 151 64  
 compass, spirit ~ 224 46  
 compass, wet ~ 224 46  
 compass bowl 224 49  
 compass brick 159 25  
 compass bridge 223 4-11; 227 24  
 compass card 224 47  
 compasses 224 46-53  
 compass flat 223 4-11; 227 24  
 compass head 151 53  
 compass plane 132 28  
 compass platform 223 4-11; 227 24  
 compass repeater 224 31, 52, 53  
 compass saw 120 63; 126 70; 132 3  
 compendium of games 47 18  
 compensating airstream 192 4  
 compensating roller 181 45  
 compensation pendulum 109 33  
 compensator 181 45  
 compensator level 112 69  
 competition bow 305 54  
 competitor 282 28  
 complementary angle 346 15  
 complement of set 348 7, 8  
 composing frame 174 2  
 composing room 174; 175; 176  
 composing rule 174 14  
 composing stick 174 13  
 composition 175 1-17

composition, computer-controlled ~ 176 14  
 compositor 174 5  
 compost heap 52 6  
 comprehensive school 261 1-45  
 compress 27 4  
 compressed-air bottle 279 21  
 compressed-air braking system 208 21  
 compressed-air cylinder 279 21  
 compressed-air hose 174 38  
 compressed-air inlet 153 53  
 compressed-air line *Joiner* 133 45  
 compressed-air line *Blacksm.* 138 5  
 compressed-air pipe *Forging* 139 22  
 compressed-air pipe *Metalwkr.* 140 17  
 compressed-air pressure gauge 279 13  
 compressed-air reservoir *Agr. Mach.* 64 92  
 compressed-air reservoir *Offshore Drill.* 146 21  
 compressed-air supply 213 20  
 compressed-air system 138 1  
 compressed-air tank *Blacksm.* 138 4  
 compressed-air tank *Power Plant* 153 51  
 compressed-air vessel 269 17, 50  
 compressed-gas container 234 32  
 compressed-helium bottle 234 14  
 compressed-helium tank 234 43, 50  
 compression bandage 21 17  
 compression plate 2 25  
 compressor *Painter* 129 33  
 compressor *Blacksm.* 138 3  
 compressor *Oil, Petr.* 145 45  
 compressor *Energy Sources* 155 4  
 compressor *Ship* 223 51  
 compressor *Office* 247 43  
 compressor, high-pressure ~ 232 36  
 compressor, low-pressure ~ 232 35  
 computer 23 53; 177 70; 195 1  
 computer cable 195 3, 38  
 computer centre 244  
 computer data 238 13  
 computer harness 195 3, 38  
 computer plug, main ~ 195 2  
 computer socket, main ~ 195 39  
 computer test, automatic ~ 195 33  
 computing scale 98 12  
 concave 64 11  
 concave ridge 302 22  
 concentrator 172 24, 42, 44, 48, 62  
 concert grand 325 40

concertina 324 36  
 conch shell trumpet 327 41  
 concrete, heavy ~ 119 72  
 concrete, rammed ~ 118 1  
 concrete, tamped ~ 118 1  
 concrete aggregate 118 36; 119 26  
 concrete bucket 119 38  
 concrete mixer 47 40; 118 33; 119 29; 201 23  
 concrete-mixing plant 201 19  
 concrete pump hopper 201 24  
 concreter 119 9  
 concrete road construction 201 1-24  
 concrete scraper 200 13  
 concrete spreader 201 5  
 concrete spreader box 201 6  
 concrete tamper 119 83  
 concrete test cube 119 84  
 concrete-vibrating compactor 201 10  
 concrete vibrator 119 88  
 condensate 172 17  
 condenser *Brew.* 92 6  
 condenser *Optic. Instr.* 112 8; 113 32  
 condenser *Oil, Petr.* 145 44  
 condenser *Nucl. Energy* 154 17, 35  
 condenser *Energy Sources* 155 8  
 condenser *Synth. Fibres* 170 5  
 condenser *Paperm.* 172 30  
 condenser *Warships* 259 64  
 condenser *Chem.* 350 48  
 condenser, coiled ~ 349 6  
 condenser, universal ~ 112 66  
 condensing locomotive 210 69  
 condensing tender 210 69  
 condition report 195 7  
 conductor *Power Plant* 153 34, 43  
 conductor *Spa* 274 21  
 conductor *Theatre* 315 26  
 conductor, copper ~ 127 43  
 conductor, electrostatic ~ 230 51; 231 27  
 conductor, high-voltage ~ 152 33  
 conduit 334 54  
 cone *Phys. Geog.* 11 24  
 cone *Mach. Parts etc.* 143 67  
 cone *Synth. Fibres* 169 27  
 cone *Bicycle* 187 58  
 cone *Maths.* 347 43  
 cone *Decid. Trees* 371 32  
 cone, cross-wound ~ 165 8, 24  
 cone, pyrometric ~ 161 6  
 cone, truncated ~ 347 45  
 cone axis 372 3  
 cone breaker 172 82  
 cone chest 326 12-14  
 cone creel 165 9  
 cone drum box 163 30  
 cone height 347 44  
 cone nozzle 83 23  
 cone refiner 172 27, 60, 73, 83  
 cone scale 372 8, 14, 27, 38  
 cone-winding frame 165 1

cone-winding machine 169 26  
 coney 366 24  
 confectionery 97 17-47; 98 75-86  
 confectionery unit 97 67-70  
 conference circuit 242 22  
 conference connection 242 22  
 conference grouping 246 31-36  
 conference hook-up 242 22  
 conference table 246 31  
 confetti 306 62  
 configuration, angular ~ 248 39  
 confluence 224 90  
 conga drum 324 55  
 congregation 330 29  
 conifers 372 1-71  
 Conium 379 4  
 connecting corridor 208 11  
 connecting door, sliding ~ 207 19  
 connecting element 248 48  
 connecting hose 208 16, 21  
 connecting lead 25 20, 56  
 connecting piece 350 56  
 connecting rod *Agr.* 63 20  
 connecting rod *Intern. Combust. Eng.* 190 21  
 connecting rod *Railw.* 210 11  
 connecting-rod bearing 192 25  
 connecting seal, rubber ~ 207 8; 208 12  
 connecting shaft 63 20  
 connecting system, automatic ~ 237 25  
 connection, internal ~ 245 14  
 connection, pneumatically sprung ~ 194 45  
 connection, rubber ~ 194 45  
 connection of modules 242 70  
 connection rebar 119 10, 71  
 connector *Moon L.* 6 28  
 connector *Weaving* 166 52  
 connector, thermoplastic ~ 127 29  
 connector fitting 287 31  
 consignment, general ~ 206 4  
 consignment, mixed ~ 206 4  
 consignment note 206 30  
 console *Joiner* 133 24  
 console *Serv. Stat.* 196 29  
 console *School* 261 37  
 console *Music. Instr.* 326 36-52  
 console operator 244 3  
 console piano 325 1  
 console typewriter 244 4  
 consolidating beam 201 2  
 constant of integration 345 14  
 constellations 3 9-48  
 construction, close-seamed ~ 285 54  
 construction, wooden ~ 260 72  
 construction of circuit 242 72  
 construction set 48 22  
 construction site 118; 119

construction unit, precast ~ 215 58  
 construction vehicle 255 75  
 consulting room 23 1  
 contact, auxiliary ~ 153 57  
 contact, magnetic ~ 242 71  
 contact arc 237 43  
 contact arm 237 44  
 contact arm tag 237 46  
 contact breaker 242 49  
 contact field 237 45  
 contact goniometer 351 27  
 contact maker 127 38-39  
 contact sleeve, metal ~ 166 31  
 contact spring 127 28  
 contact wire maintenance vehicle 211 41, 44-54  
 contact wire voltage indicator 211 28  
 container 206 57; 221 22; 226 3, 6  
 container *Chem.* 350 61  
 container, plastic ~ 83 25  
 container, railroad-owned ~ 206 19  
 container, railway-owned ~ 206 19  
 container, shielded ~ 154 82  
 container berth 225 48; 226 1  
 container car 206 58  
 container carrier truck 225 47  
 container for vegetables 96 51  
 container platform 194 27  
 container ship 221 89; 225 45  
 container station 206 54  
 container terminal 225 48; 226 1  
 container wagon 206 58  
 containment, steel ~ 154 21  
 contents 342 40  
 continents 14 12-18  
 continuity girl 310 39  
 continuity tester 127 55  
 continuous feed grate 199 34  
 continuous filament process 162 48  
 continuous reheating furnace 148 69  
 continuous rolling mill train 148 66-75  
 contouche 355 66  
 contour 15 62  
 contour, submarine ~ 15 11  
 contour knife 340 10  
 contrabass 323 23  
 contrabassoon 323 28  
 contrabass tuba 323 44  
 contracted burial 328 17  
 contractile vacuole 357 5  
 contra octave 321 43  
 contrast control 240 32; 249 36  
 contrast medium injector 27 15  
 control, digital ~ 242 35  
 control, manual ~ 115 52  
 control, sliding ~ 311 18  
 control and monitoring panel 311 8  
 control arm 240 29; 313 11  
 control board 153 1

control box *Moon L.* 6 23  
 control box *Mach. Tools* 150 36  
 control box *Offset Platem.* 179 33  
 control button *Hosp.* 25 30  
 control button *Cine Film* 117 98  
 control button *Text. Finish.* 168 40  
 control button *Navig.* 224 32  
 control button *Audiovis.* 243 13  
 control button *Office* 246 19  
 control button *School* 261 45  
 control cable 271 53  
 control column 230 24; 257 8; 288 14  
 control console *Power Plant* 153 1-6  
 control console *Photomech. Reprod.* 177 5  
 control console *Films* 311 12  
 control console *Theatre* 316 2  
 control desk *Hosp.* 27 10  
 control desk *Brew.* 93 1  
 control desk *Iron & Steel* 147 66  
 control desk *Power Plant* 153 1-6  
 control desk *Nucl. Energy* 154 80  
 control desk *Offset Print.* 180 16  
 control desk *Photograv.* 182 28  
 control desk *Films* 311 12  
 control desk, driver's ~ 212 32  
 control desk, engineer's ~ 212 32  
 control device 26 7  
 control frame 287 46  
 control gear 164 38  
 control grip *Pest Contr.* 83 19  
 control grip *Photog.* 115 76  
 control handle, cranked ~ 168 52  
 control knob *Hosp.* 25 49; 27 41  
 control knob *Electrotyp. etc.* 178 15  
 controller 197 27  
 controller, rear ~ 197 8  
 controller handwheel 211 20; 212 12  
 control lever *Agr. Mach.* 64 59  
 control lever *Pest Contr.* 83 21  
 control lever *Cine Film* 117 63  
 control lever *Cotton Spin.* 163 28  
 control lever *Road Constr.* 201 8, 12  
 control lever *Navig.* 224 19  
 control lever *Broadcast.* 240 29  
 control lever *Films* 313 11  
 control lever *Theatre* 316 58  
 control line model 288 89  
 control linkage 190 30  
 control loudspeaker 311 13



control mechanism 181 26  
 control module 238 45; 240 11  
 control panel *Hosp.* 26 20; 27 10  
 control panel *Roof & Boilerr.* 38 67  
 control panel *Dairy* 76 11  
 control panel *Brew.* 93 1, 20  
 control panel *Offshore Drill.* 146 28  
 control panel *Power Plant* 153 1  
 control panel *Nucl. Energy* 154 80  
 control panel *Paperm.* 173 43  
 control panel *Photomech.* *Reprod.* 177 36, 60  
 control panel *Offset Platem.* 179 10, 17  
 control panel *Offset Print.* 180 74  
 control panel *Bookbind.* 185 2  
 control panel *Broadcast.* 240 31  
 control panel *Films* 311 4, 17, 29  
 control panel, bracket-mounted ~ 177 6  
 control panel, electric ~ 168 25, 58  
 control panel, hinged ~ 177 6  
 control platform 226 55  
 control point 203 25  
 control rod *Nucl. Energy* 154 24  
 control rod *Warships* 259 69  
 control rod drive 154 23  
 control room *Hosp.* 25 1-9  
 control room *Offshore Drill.* 146 32  
 control room *Power Plant* 152 19, 28; 153 1-8  
 control room *Railw.* 214 65  
 control room *Broadcast.* 238 17  
 control room *Theatre* 316 1  
 control room, central ~ *Dairy* 76 7  
 control room, central ~ *Brew.* 92 25  
 control room window 238 38  
 controls 25 29; 153 6; 271 48  
 control speaker 238 15  
 control station 217 45  
 control stick 230 24; 257 8; 288 14  
 control switch *Hosp.* 25 29  
 control switch *Electrotyp. etc.* 178 36  
 control switch *Offset Print.* 180 74  
 control switch *Navig.* 224 23  
 control tap 172 9  
 control tower 233 17; 287 12  
 control unit *Hosp.* 26 7  
 control unit *Optien.* 111 29  
 control unit *Blacksm.* 138 31  
 control unit *Mach. Tools* 150 36  
 control unit *Photomech.* *Reprod.* 177 51

control unit *Electrotyp. etc.* 178 29  
 control unit *Offset Platem.* 179 33  
 control unit *Audio* 241 40  
 control unit, central ~ *Hosp.* 25 1, 20  
 control unit, central ~ *Inf. Tech.* 242 2  
 control unit, electric ~ 168 58  
 control valve 153 52  
 control weight 166 63  
 control well 117 98  
 control wheel *Text. Finish.* 168 40  
 control wheel *Railw.* 212 81  
 convenience outlet 127 5  
 convenience outlet, double ~ 127 6  
 convent 15 63  
 convergence 224 90  
 convergence module 240 12  
 conversion filter step 117 38  
 converter 92 42  
 converter bottom, solid ~ 147 47  
 converter chimney 147 67  
 converter top, conical ~ 147 45  
 converter tube 27 19  
 convertible 193 9  
 convertiplane 232 31  
 conveyances 186 1-54  
 conveyor *Poultry Farm* 74 22  
 conveyor *Dairy.* 76 23  
 conveyor *Bldg. Site* 118 77  
 conveyor *Synth. Fibres* 169 32  
 conveyor *Paperm.* 172 79  
 conveyor *Photograv.* 182 30  
 conveyor *Refuse Coll.* 199 36  
 conveyor *Docks* 225 51  
 conveyor belt *Dairy.* 76 23  
 conveyor belt *Bldg. Site* 118 77  
 conveyor belt *Synth. Fibres* 169 32  
 conveyor belt *Paperm.* 172 79  
 conveyor belt *Photograv.* 182 30  
 conveyor belt *Docks* 225 51  
 conveyor brattice 163 13  
 conveyor trolley 74 39  
 conveyor unit 83 59  
 cook, head ~ 207 34  
 cooker 96 47  
 cooker, calor gas ~ 278 33  
 cooker, double-burner ~ 278 33  
 cooker, electric ~ 39 12; 46 32  
 cooker, gas ~ 39 12; 278 33  
 cooker hood 39 17; 46 31  
 cooker unit 39 12-17  
 cooking liquor 172 46  
 cooking pot 39 29; 40 12  
 cookroom 223 42  
 coolant 149 44  
 coolant bore 242 54  
 coolant-collecting plant 92 7  
 coolant feed line 235 38  
 coolant flow passage 154 29  
 coolant pump 190 61

coolant pump, primary ~ 154 25  
 coolant supply pipe 138 26; 149 25  
 coolant system 154 55  
 coolant tray 149 44  
 cooler *Oil, Petr.* 145 44  
 cooler *Coking* 156 27  
 coolie 353 43  
 cooling 170 34  
 cooling compressor 92 22  
 cooling cylinder 170 27  
 cooling fan 312 34  
 cooling rib 189 20; 190 80; 242 60  
 cooling roll 173 25  
 cooling roller 180 28  
 cooling room 281 28  
 cooling system 154 48  
 cooling table 97 67  
 cooling tank 162 15  
 cooling tower *Coal* 144 15  
 cooling tower *Nucl. Energy* 154 39  
 cooling tower *Synth. Fibres* 170 43  
 cooling unit 209 21; 212 26, 77  
 cooling water *Nucl. Energy* 154 18  
 cooling water *Railw.* 212 65, 78  
 cooling water bore 242 54  
 cooling water flow circuit 154 10  
 cooling water heat exchanger 155 3  
 cooling water pipe *Optien.* 111 31  
 cooling water pipe *Power Plant* 152 27  
 cooling water pipe *Car* 191 10  
 cooling water temperature gauge 212 21  
 cooling water thermostat 190 62  
 cool shelf 266 49  
 coon 368 9  
 cooper 130 11  
 coordinate 347 2-3, 8  
 coordinate, right-angled ~ 347 1  
 coot 359 20  
 cop, full ~ 163 2  
 cope 148 19  
 copier, automatic ~ 249 32  
 copier, web-fed ~ 249 32  
 coping stone 37 37  
 copper 305 6, 18  
 copper, unworked ~ 260 64  
 copper cylinder, polished ~ 182 7  
 copper plate 179 9  
 copperplate, polished ~ 340 53  
 copperplate engraver 340 44  
 copperplate engraving 340 14-24  
 copperplate press 340 36  
 copper sulphate 351 26  
 copy 176 3; 177 18  
 copy, received ~ 245 2

copy, transmitted ~ 245 2  
 copyboard 177 14, 22, 30  
 copy cylinder 177 64  
 copy delivery 249 43  
 copyholder 177 15  
 copying camera, overhead ~ 177 1  
 copying stand 115 90, 92, 93  
 cypod 115 90  
 copy stand 115 90, 92, 93  
 coquille 294 38, 43  
 coral, precious ~ 357 17  
 coral, red ~ 357 17  
 coral animal 357 17  
 coral *Clavaria* 381 32  
 coral colony 357 18  
 coral evergreen 377 12  
 coral polyp 357 19  
 coral reef 13 32  
 cor anglais 323 38  
 cord 206 12  
 cord, warp-faced ~ 171 26, 27  
 cordate 370 35  
 corded ware 328 10  
 cordon, horizontal ~ 52 17, 29  
 cordon, quadruple ~ 52 1  
 cordon, vertical ~ 52 2  
 core *Phys. Geog.* 11 5  
 core *Soft Fruit* 58 36, 59  
 core *Iron Foundry etc.* 148 36  
 core *Power Plant* 153 17, 36  
 core *Electrotyp. etc.* 178 18  
 core, soft-lead ~ 87 56  
 core, special ~ 301 47  
 core bit 145 21  
 core print 148 37  
 corking machine, semi-automatic ~ 79 10  
 corkscrew 40 18; 45 46  
 corkscrew piton 300 40  
 cormorant 359 10  
 corn 68 1, 31  
 corn camomile 61 8  
 corn champion 61 6  
 corn cob 68 36  
 corn cockle 61 6  
 cornea 19 47  
 cornelian cherry 373 30, 32  
 corner *Games* 276 27  
 corner *Ball Games* 291 41; 292 18  
 corner *Sports* 305 6; 305 8  
 corner *Maths.* 347 33  
 corner bottom slate 122 77  
 corner brace 120 26  
 corner flag 291 8  
 corner kick 291 41  
 corner peg 292 79  
 corner seat 207 58; 265 10; 266 38  
 corner section 42 26  
 corner stile 120 52  
 corner strut 120 52  
 corner stud 120 52  
 corner table 246 34; 266 39  
 corner unit 39 27  
 corner work 149 51  
 cornet 323 43  
 cornet, curved ~ 322 12  
 cornfield 63 32  
 corn flower 61 1

corn head 64 35  
 cornice *Carp.* 120 34  
 cornice *Mountain.* 300 20  
 cornice *Art* 334 11-14; 335 48  
 corn marigold 61 7  
 corn poppy 61 2  
 corn removal 92 38  
 corn salad 57 38  
 corn spurrey 69 12  
 corn stem 68 5  
 corn weevil 81 26  
 corolla 59 11; 378 4  
 corolla, papilionaceous ~ 57 1  
 corona 334 12  
 corona, solar ~ 4 39  
 Corona *Borealis* 3 31  
 coronet, baronet's ~ 254 43  
 coronet, baronial ~ 254 44  
 coronet, count's ~ 254 45  
 coronet, ducal ~ 254 39  
 coronet, elector's ~ 254 41  
 coronet, prince's ~ 254 40  
 coronets 254 37-46  
 coronets of rank 254 43-45  
 corporation stock 251 11-19  
 corps de ballet 314 25  
 corpus callosum 17 44  
 corpus cavernosum and spongiosum 20 67  
 corral 319 14  
 correcting fluid 247 13  
 correcting lens 115 22  
 correcting paper 247 12  
 correction lens 115 72  
 corrector, universal ~ 238 48  
 corrector plate 113 11  
 correspondence 245 19  
 correspondence file 22 12  
 correspondent 342 54  
 corresponding angle 346 12  
 corrida 319 1-33  
 corridor *Railw.* 207 11  
 corridor *Winter Sp.* 301 71  
 corridor compartment coach 207 1-21  
 Corvidae 361 1-3  
 corydalis 377 8  
 cosine 346 32  
 cosmetics 99 27-35  
 cosmetics gondola 99 23  
 cossack trousers 30 44  
 costume, theatrical ~ 315 51  
 costume designer 315 38  
 costumes, historical ~ 355  
 cot, collapsible ~ 28 1  
 cotangent 346 32  
 cottage, dikereeve's ~ 216 45  
 cottage, ferryman's ~ 216 45  
 cottage piano 325 1  
 cotter punch 137 31  
 cotton *Cotton Spin.* 163 1-13  
 cotton *Industr. Plants* 383 16  
 cotton bale, compressed ~ 163 3  
 cotton bobbin 100 29  
 cotton boll, ripe ~ 163 1  
 cotton feed 163 9  
 cotton-feeding brattice 163 8  
 cotton grass 377 18  
 cotton reel 104 9  
 cotton rush 377 18

cotton spinning 163; 164  
 cotton wool 99 28  
 cotton wool ball 99 30  
 cotyledon 370 87  
 couch *Doc.* 22 43  
 couch *Weeds* 61 30  
 coucher 173 49  
 couch grass 61 30  
 couchman 173 49  
 coudé ray path 5 3  
 coudière 329 48  
 coulee 13 45  
 couler 65 10  
 coultter, disc ~ 64 66; 65 69  
 coultter, drill ~ 65 76  
 coultter, rolling ~ 64 66; 65 69  
 coultter, skim ~ 65 68  
 counter *Child. Rm.* 47 28  
 counter *Shoem.* 100 59  
 counter *Shoes* 101 37  
 counter *Cotton Spin.* 163 61  
 counter *Composing Rm.* 175 41  
 counter *Offset Print.* 180 74  
 counter *Railw.* 207 31  
 counter *Café* 265 1  
 counter *Restaurant* 266 1-11  
 counter *Water* 269 59  
 counter *Ball Games* 291 23  
 counter *Winter Sp.* 302 18  
 counter *Flea Market* 309 83  
 counter, cashier's ~ 250 1  
 counter, extra ~ 271 64  
 counter, special ~ 271 64  
 counter assistant 265 7  
 counterbalance 241 22  
 counterbalance weight 242 50  
 counterblow hammer 139 5  
 counterbrace 215 35  
 counter clerk 236 16  
 counter gear assembly 269 55  
 counter officer 236 16  
 counterpoise *Optic. Instr.* 113 19  
 counterpoise *Hydr. Eng.* 217 76  
 counterpoise *Docks* 226 50  
 counterpoise *Army* 255 78  
 counter stamp machine 236 19  
 counter tube 2 21  
 counter tube casing 2 20  
 counterweight *Overh. Irrign.* 67 37  
 counterweight *Optic. Instr.* 113 19  
 counterweight *Bldg. Site* 119 33  
 counterweight *Forging* 139 34  
 counterweight *Hydr. Eng.* 217 76  
 counterweight *Docks* 226 50  
 counterweight *Audio* 241 22  
 counterweight *Army* 255 78  
 counting, automatic ~ 74 52  
 counting beads 47 14  
 counting blocks 48 17  
 counting mechanism 309 83  
 counting out 299 42  
 country estate 15 94  
 countryside in winter 304



coupé *Carriages* 186 3  
 coupé *Car* 193 28  
 couple 267 46; 272 72; 317 17-18  
 couple, bridal ~ 332 15-16  
 coupler *Bldg. Site* 119 53  
 coupler *Plumb. etc.* 126 43  
 coupler *Music. Instr.* 326 41  
 couplet 321 23  
 coupling *Agr. Mach.* 65 61  
 coupling *Bldg. Site* 119 53  
 coupling *Railw.* 208 16; 210 2; 212 82; 214 18  
 coupling, front ~ 65 50  
 coupling, unlinked ~ 208 19  
 coupling bolt 202 15  
 coupling hook 122 64  
 coupling hose 208 21  
 coupling link 208 17  
 coupling screw 208 18  
 coupling spindle 148 58  
 coupon 251 17  
 coupon sheet 251 17  
 courbette 71 6  
 course *Weaves* 171 42  
 course *Rivers* 216 9  
 course *Winter Sp.* 301 44  
 course, damp-proof ~ 123 4  
 course, first ~ 118 67  
 course, second ~ 118 68  
 course, triangular ~ 285 16  
 course counter 167 43  
 course-marking flag 301 45  
 course markings 289 19  
 courser 70 24  
 court dress 355 79  
 courtesy light 191 77  
 court shoe 101 29  
 court shoe, fabric ~ 101 54  
 court shoe, sling-back ~ 101 53  
 couter 329 48  
 cove 13 7  
 cover *Atom* 2 14  
 cover *Dining Rm.* 44 5  
 cover *Tablew. etc.* 45 3-12  
 cover *Optic. Instr.* 113 13  
 cover *Photog.* 115 11  
 cover *Bldg. Site* 118 22  
 cover *Bookbind.* 185 40  
 cover *Bicycle* 187 30  
 cover *Water* 269 56  
 cover, canvas ~ 255 98  
 cover, glass ~ *Kitch. Utensils* 40 7  
 cover, glass ~ *Energy Sources* 155 33  
 cover, hinged ~ 309 27  
 cover, nylon ~ 207 68  
 cover, porous ~ 199 21  
 cover, screw-in ~ 115 11  
 cover, screw-on ~ 83 40  
 cover, soundproof ~ 310 48  
 cover, terry ~ 49 14  
 cover, transparent ~ 249 27  
 coverall 29 23  
 cover cylinder 184 10  
 covering 287 40  
 covering, felt ~ 353 20  
 covering, green baize ~ 277 15

covering material 184 12  
 cover projection 243 47  
 coving 336 10  
 cow 73 1  
 cowberry 377 23  
 cowboy 306 31; 319 36  
 cowboy boot 101 9  
 cowcatcher 210 34  
 cow corn 68 31  
 cowl *Blacksm.* 137 7  
 cowl *Warships* 258 21; 59  
 cowl *Church* 331 56  
 cowl collar 30 3  
 cow neck jumper 30 2  
 Cowper's gland 20 75  
 cowshed 62 7  
 cowslip 376 8  
 cox 283 11  
 coxed single 283 18  
 coxless four 283 9  
 coxless pair 283 15  
 CQR anchor 286 16  
 Crab *Astron.* 4 56  
 crab *Shipbuild.* 222 14, 28  
 crab *Articulates* 358 1  
 crab *Deep Sea Fauna* 369 16  
 crab apple tree 58 51  
 crab louse 81 40  
 cracker 306 50  
 cracker, catalytic ~ 145 48  
 crackowe 355 42  
 cradle 237 13  
 cradle, bouncing ~ 28 2  
 cradle, double ~ 214 68  
 cradle, two-wheel ~ 214 69  
 cradle frame, lightweight ~ 189 17  
 cradle switch 237 13  
 craft room 260 46-85  
 craneberry 377 23  
 cramp 119 58; 120 66  
 cramp iron 119 58; 121 97  
 crampon 300 48  
 crampon cable fastener 300 52  
 crampon strap 300 51  
 Crane *Astron.* 3 42  
 crane *Warships* 258 88  
 crane, floating ~ 225 10; 226 48  
 crane, flying ~ 232 16  
 crane, hammer-headed ~ 222 7  
 crane, overhead ~ 222 20  
 crane, polar ~ 154 38  
 crane, revolving ~ 146 3  
 crane, travelling ~ 147 41; 222 20  
 crane cable 222 13  
 crane framework 226 53  
 crane hoist, auxiliary ~ 147 61  
 crane hook 139 45  
 crane motor 157 28  
 crane's bill 53 1; 376 24  
 crane track 119 27  
 crane truck 270 47  
 crank *Agr. Mach.* 64 43  
 crank *Bicycle* 187 41  
 crank *Road Constr.* 201 18  
 crankcase 190 40; 242 51  
 crankcase scavenging 242 59

crank drive 217 53  
 crankshaft 166 50; 190 23; 192 29  
 crankshaft, counterbalanced ~ 242 50  
 crankshaft bearing 190 22; 192 23  
 crankshaft bleed 192 22  
 crankshaft drilling 192 22  
 crankshaft tributary 192 22  
 crankshaft wheel 166 51  
 crash bar 188 18  
 crash barrier 259 17  
 crash hat 290 3  
 crash helmet 301 13; 303 14  
 crate 76 30; 206 5  
 crater 312 44  
 crater, volcanic ~ 11 16  
 cravat 32 40  
 crawl 73 20  
 crawl 282 37  
 crawl stroke 282 37  
 crayon 47 26; 338 5  
 crayon, wax ~ 48 11; 260 6  
 crayon engraving 340 14-24  
 cream 99 27, 46  
 cream, whipped ~ 97 28; 265 5  
 cream cake 97 21, 24  
 creamer 265 21  
 creamery butter machine 76 33  
 cream heater 76 13  
 cream jar 28 13  
 cream jug 265 21  
 cream maturing vat 76 31  
 cream pie 97 24  
 cream puff 97 27  
 cream roll 97 17  
 cream separator 76 14  
 cream supply pump 76 40  
 cream tank 76 19  
 crease *Men's Wear* 33 6  
 crease *Ball Games* 292 72  
 crease *Ethnol.* 353 44  
 creatures, fabulous ~ 327 1-61  
 creatures, mythical ~ 327 1-61  
 creek *Phys. Geog.* 13 8  
 creek *Map* 15 80  
 creel *Fish Farm.* 89 25  
 creel *Cotton Spin.* 164 28, 58  
 creel *Weaving* 165 25  
 creel, full ~ 164 41  
 creeper 51 5; 52 5; 53 2; 57 8  
 creeping foot 357 28  
 creese 353 44  
 crenate 370 46  
 crenel 329 18  
 crenellation 329 6  
 crepe paper 49 11  
 crepidoma 334 4  
 crescendo 321 31  
 crescendo roller 326 49  
 crescendo roller indicator 326 37  
 crescent *Astron.* 4 3, 7  
 crescent *Bakery* 97 32  
 crescent *Supermkt.* 99 13  
 Crescent *Flags* 253 19

crescent-forming machine 97 64  
 crescent moon 4 3, 7  
 crescent roll 97 32; 99 13  
 crescent wing 229 18  
 crest *Horse* 72 12, 14  
 crest *Dom. Anim.* 73 22  
 crest *Heraldry* 254 1  
 crest, dorsal ~ 364 21  
 crest, erectile ~ 359 26  
 Cresta tobogganing 303 22-24  
 crest coronet 254 12  
 crested lark 361 19  
 crested newt 364 20  
 cresting 305 65  
 crest of dam 217 59  
 crests 254 1, 11, 30-36  
 crevasse 12 50; 300 23  
 crew compartment 6 41; 235 16  
 crew cut 34 11  
 crew entry tunnel 235 71  
 cricket 292 70-76  
 cricket bat 292 75  
 crimping 170 59  
 crimping iron 106 26  
 crimson clover 69 4  
 crinoline 355 72  
 crispbread 97 50  
 criss-cross skip 297 44  
 cristobalite 1 12  
 croaking sac 364 25  
 crocket 335 38  
 croisé 314 16  
 croissant 97 32; 99 13  
 crojack 220 26  
 crojack yard 220 25  
 cromlech 328 16  
 crook 324 71  
 crook of the arm 16 44  
 crop 73 20  
 crops, arable ~ 68  
 croquant 98 85  
 croquet 292 77-82  
 croquet ball 292 82  
 croquet mallet 292 81  
 croquet player 292 80  
 Cross *Astron.* 3 44  
 cross *Plumb. etc.* 126 50  
 cross *School* 260 28  
 cross *Church* 331 25  
 cross, ansate ~ 332 63  
 cross, cardinal's ~ 332 65  
 cross, Constantinian ~ 332 67  
 cross, fivefold ~ 332 72  
 cross, Greek ~ 332 56  
 cross, Latin ~ 332 55  
 cross, Papal ~ 332 66  
 cross, patriarchal ~ 332 64  
 cross, processional ~ 330 47  
 cross, quintuple ~ 332 72  
 cross, Russian ~ 332 57  
 cross, saltire ~ 332 60  
 cross, St. Andrew's ~ 332 60  
 cross, St. Anthony's ~ 332 59  
 cross, St. Peter's ~ 332 58  
 cross arm 152 37  
 cross arms 10 30  
 crossbar *Goldsm. etc.* 108 5  
 crossbar *Bicycle* 187 16  
 crossbar *Ball Games* 291 36

crossbar *Athletics* 298 14, 34  
 cross beam 119 57  
 cross bearer 331 43  
 cross bond, English ~ 118 65  
 cross botonée 332 71  
 crossbrace 215 35  
 cross bracing wire 229 12  
 crossbuck 202 41  
 cross chain conveyor 157 22  
 cross conveyor 157 20  
 cross-country *Equest.* 289 17  
 cross-country *Winter Sp.* 301 42  
 cross-country binding 301 15  
 cross-country boot 301 16  
 cross-country equipment 301 14-20  
 cross-country gear 301 17  
 cross-country lorry 194 1  
 cross-country motorcycle 189 16  
 cross-country pole 301 20  
 cross-country race 290 33  
 cross-country ski 301 14  
 cross-country stretch-suit 301 43  
 cross-country tyre 194 4  
 cross-cut 144 31  
 cross-cut, octagonal ~ 36 53  
 cross-cut, oval hexagonal ~ 36 63  
 cross-cut, round hexagonal ~ 36 65  
 cross-cut, trapezium ~ 36 58  
 cross-cut chain saw 157 38  
 cross-cut chisel 140 25  
 cross-cut saw 120 14  
 crosses, Christian ~ 332 55-72  
 crossfall 200 57  
 cross fold knife 185 12  
 cross fold unit, third ~ 185 14  
 cross grasp 296 43  
 cross hairs 87 32  
 cross hairs, double ~ 115 66  
 cross hatch 340 54  
 cross head *Forging* 139 37  
 cross head *Railw.* 210 27  
 crossing 205 15  
 crossing, intercom-  
 controlled ~ 202 47  
 crossing, telephone-  
 controlled ~ 202 47  
 crossing keeper 202 42  
 crossing the bar 298 31  
 crossjack 220 26  
 crossjack yard 220 25  
 cross joint 151 50  
 cross lacing 29 37  
 crosslet 332 68  
 cross moline 332 69  
 cross of Jerusalem 332 70  
 cross of Lorraine 332 62  
 cross of the Passion 332 55  
 crossover 241 14  
 crossover, double ~ 203 49-52  
 crossover network 241 14  
 cross piece *Bldg. Site* 119 61  
 cross piece *Shipbuild.* 222 15  
 cross piece *Fencing* 294 42  
 cross rib 335 31  
 cross slide 149 23, 39; 150 12

cross-slide guide 174 48  
 cross spider 358 45  
 cross stitch 102 5  
 cross stitch, Russian ~ 102 9  
 cross strut 119 67  
 cross tie *Roof* 121 30  
 crosstie *Station* 205 60  
 crosstie, concrete ~ 202 37  
 crosstie, coupled ~ 202 14, 38  
 crosstie, steel ~ 202 36  
 cross total counter 242 3  
 crosstrees 223 37; 284 13  
 crosstrees, starboard ~ 286 9  
 cross trellée 332 71  
 cross vault 335 31-32  
 crosswalk 198 11; 268 24, 51  
 cross-winding the threads 165 11  
 cross wire, overhead ~ 197 42  
 cross wires 87 32  
 crotchet 320 15  
 crotchet rest 320 23  
 crouch 295 6, 23  
 crouch start 298 4  
 croup 72 31  
 croupier 275 4  
 croupier, head ~ 275 6  
 crow 86 50, 51; 361 2  
 crowbar 158 32  
 crowberry 377 23  
 crowfoot 375 8  
 crown *Man* 16 1; 19 37  
 crown *Dent.* 24 28  
 crown *Forging* 139 36  
 crown *Bridges* 215 31  
 crown *Park* 272 60  
 crown *Art* 336 39  
 crown *Hist. Cost.* 355 21  
 crown *South. Fruits* 384 29  
 crown, gold ~ 24 28  
 crown, mural ~ 254 46  
 crown block 145 4  
 crown cork 93 27  
 crown cork bottle-opener 45 47  
 crown cork closure 93 27  
 crown cork opener 45 47  
 crown of hooks 81 38  
 crown-of-the-field 61 6  
 crown of tree 370 3  
 crownpiece 71 10  
 crowns 254 37-46  
 crown safety platform 145 3  
 crown wheel *Clocks* 110 41  
 crown wheel *Mach. Parts etc.* 143 93  
 crows 361 1-3  
 crow's nest 223 38  
 crucible, clay ~ 350 31  
 crucible, graphite ~ 108 10  
 crucible tongs 108 11; 350 32  
 crucifer 331 43  
 crucifix *Gymn.* 296 50  
 crucifix *Church* 332 33  
 crucifix, processional ~ 331 42  
 crude benzene, production of ~ 156 41  
 crude benzene tank 156 42  
 crude benzol, production of ~ 156 41



crude benzol tank 156 42  
 crude oil production 145 22-27  
 crude phenol tank 156 40  
 crude tar tank 156 32  
 cruet set 332 44  
 cruet stand 266 22  
 cruiser 286 5  
 cruiser keelboat 285 29-34  
 cruiser stern 285 45  
 cruising yacht 284 60  
 crumb 97 3  
 crumhorn 322 6  
 crupper 71 34; 72 31  
 crupper-strap 71 34  
 crusader 329 72  
 crushed grape transporter 78 16  
 crusher 172 5  
 crusher, coarse ~ 158 19  
 crusher, fine ~ 158 19  
 crusher, gyratory ~ 158 19  
 crusher, primary ~ 158 17  
 crusher, rotary ~ 158 19  
 crush hat 35 36  
 crush room 315 12-13  
 crust 97 4, 5  
 crust, earth's ~ 11 1  
 crust, outer ~ 11 1  
 crustacean 369 12, 15, 16  
 crustaceans 358 1-2  
 crusta petrosa 19 29  
 crutch 148 15  
 Crux 3 44  
 cryosurgery 22 63  
 Cryptolestes 81 27  
 crystal 351 29  
 crystal centre 351 3  
 crystal combinations 351 1-26  
 crystal cone 77 21  
 crystal detector 309 23  
 crystal forms 351 1-26  
 crystallography 351  
 crystallography 351  
 crystallography 351 27-33  
 crystal plate glass 124 5  
 crystals 351 1-26  
 crystal set 309 23  
 crystal system 351 1-17  
 cub 88 42  
 cube *Kindergart.* 48 21  
 cube *Maths.* 347 30  
 cube *Crystals* 351 2, 14, 16  
 cube root 345 2  
 cube sugar 98 53  
 cubic crystal system 351 1-17  
 cubitière 329 48  
 cuckoo 359 30  
 cuckoo clock 109 31  
 cuckoo flower 375 11; 376 21  
 cuckoo pint 379 9  
 cucumber 57 13; 99 83  
 cue 277 9  
 cue ball, white ~ 277 11  
 cue rack 277 19  
 cue tip, leather ~ 277 10  
 cuff 25 16; 30 14; 32 45  
 cuff, fur ~ 30 62  
 cuff, fur-trimmed ~ 30 62  
 cuff, inflatable ~ 23 34

cuff, ribbed ~ 30 30  
 cuff link 32 46; 36 21  
 cuff protector 324 17  
 cuff slit 30 48  
 cuirass 329 46  
 cuish 329 52  
 cuissard 329 52  
 cuisse 329 52  
 culicid 358 16  
 culm *Arable Crops* 68 6  
 culm *Coking* 156 14  
 culotte 31 48; 29 59  
 cultivator *Market Gdn.* 55 21  
 cultivator *Agr. Mach.* 65 55  
 cultivator, three-pronged ~ 56 13  
 cultivator attachment 56 21  
 culture, bacteriological ~ 261 29  
 cumulonimbus 8 17; 287 26  
 cumulonimbus cloud 287 26  
 cumulus 8 1; 287 22  
 cumulus cloud 287 22  
 cumulus congestus 8 2  
 cumulus humilis 8 1  
 cup *Bicycle* 187 79  
 cup *Decid. Trees* 371 5  
 cup, baby's ~ 28 27  
 cup, hemispherical ~ 10 30  
 cup, rust-proof ~ 122 102  
 cup, zinc ~ 122 102  
 cup bearer 329 69  
 cupboard 246 5  
 cupboard, children's ~ 47 21  
 cupboard, sliding-door ~ 248 38  
 cupboard base unit 42 6  
 cupboard unit 42 7  
 cupboard unit, two-door ~ 46 6  
 cup cymbals 324 50  
 cupid 272 20  
 cupola *Iron Foundry etc.* 148 1  
 cupola *Art* 334 58  
 cupola, bulbous ~ 336 3  
 cupola furnace 148 1  
 cupule 59 42; 371 5; 384 52  
 curb 198 6; 272 25  
 curb bit 71 13, 52  
 curb chain 71 12  
 curbstone 198 7  
 curbstone broker 251 5  
 curbstoner 251 5  
 curd cheese 76 38  
 curd cheese, packeted ~ 76 45  
 curd cheese machine 76 38  
 curd cheese packing machine 76 44  
 curd cheese pump 76 39  
 curds separator 76 41  
 curettage 26 52  
 curette 22 50; 26 52  
 curing floor 92 18  
 curing kiln 92 30  
 curl 34 3  
 curl brush 105 13  
 curl clip 105 14  
 curler *Hairdresser* 105 4  
 curler *Winter Sp.* 302 41  
 curling 302 41-43

curling broom 302 43  
 curling brush 302 43  
 curling iron 105 5; 106 31  
 curling stone 302 42  
 curling tongs 105 5; 106 31  
 curly kale 57 34  
 currant 58 12, 14; 98 9  
 currant bush 52 19; 58 10  
 current 216 9  
 current, cold ~ 9 29  
 current, three-phase ~ 153 42  
 current, warm ~ 9 28  
 current collector *Lorries etc.* 194 41  
 current collector *Tram* 197 2, 23  
 current collector *Railw.* 207 24, 75; 211 2, 30  
 current meter *Railw.* 212 18  
 current meter *Rivers* 216 43  
 current rating 127 37  
 currents, oceanic ~ 14 30-45  
 current transformer 153 58  
 current/voltage meter 242 77  
 currycomb 71 54  
 curtail step 123 18, 42  
 curtain *Dining Rm.* 44 13  
 curtain *Railw.* 207 56  
 curtain *Chivalry* 329 15  
 curtain, iron ~ 316 24  
 curtain, theatrical 316 23  
 curtain department 271 66  
 curtain lace 167 29  
 curtain operation, types of ~ 315 1-4  
 curtain rail 44 15  
 curtain wall 329 15  
 curvature 346 22  
 curve *Sports* 305 19  
 curve *Maths.* 347 11, 18  
 curve, ballistic ~ 87 79  
 curve, hypsographic ~ 11 6-12  
 curve, inflected ~ 347 13  
 curve, plane ~ 347 12  
 curved electrotype casting machine 178 13  
 curved plate casting machine 178 13  
 curve eight 302 11  
 curvet 71 6  
 cushion 42 23; 47 8; 202 6  
 cushion, gilder's ~ 129 50  
 cushion, rubber ~ 277 16  
 cushion capital 335 21  
 cusp 20 48  
 customer 98 43; 99 2, 18; 111 2; 248 18; 250 6; 266 25; 271 16, 55  
 customer accounts office 271 24  
 customer area 207 78  
 customer card index 248 24  
 customer service representative 248 17  
 customs 217 24  
 customs barrier 225 4  
 customs boat pendant 253 35  
 customs boat pennant 253 35  
 customs entrance 225 5  
 customs flags 253 35-38

customs launch 221 100  
 customs signal flag 253 37  
 cut *Metalwkr.* 140 28  
 cut *Fencing* 294 23  
 cut, antique ~ 36 49  
 cut, cold ~ 96 14  
 cut, positive ~ 340 3  
 cut, round ~ 36 42-43  
 cut, standard ~ 36 48  
 cut and thrust weapon 294 34  
 cutlery 45; 309 47  
 cutlery chest 266 41  
 cutlery drawer 39 10; 44 21  
 cutlery holder 266 48  
 cutlet 95 12  
 cut nippers, detachable-jaw ~ 140 67  
 cutoff knife and roughing station 184 3  
 cuts 36 42-86  
 cuts, fancy ~ 36 68-71  
 cutter *Paperhanger* 128 42  
 cutter *Joiner* 132 20  
 cutter *Drawing Off.* 151 15  
 cutter *Brickwks.* 159 15  
 cutter *Papern.* 173 44  
 cutter *Composing Rm.* 175 33, 51  
 cutter *Ship* 220 8  
 cutter *Warships* 258 12, 61  
 cutter *Films* 311 43  
 cutter, automatic ~ 162 19  
 cutter, fine ~ 133 37  
 cutter, rotary ~ *Forestry* 85 26  
 cutter, rotary ~ *Bookbind.* 184 22  
 cutter, spherical ~ 108 7  
 cutter, universal ~ 134 28  
 cutter bar 64 3  
 cutter for metal watch straps 109 19  
 cutter spindle 175 60  
 cutting *Map* 15 84  
 cutting *Plant Propagn.* 54 19, 20  
 cutting *Synth. Fibres* 170 60  
 cutting *Films* 311 42-46  
 cutting, shooting ~ 54 24  
 cutting, sprouting ~ 54 24  
 cutting attachment 141 19  
 cutting bench 117 96; 311 42  
 cutting blade 183 19  
 cutting cylinder *Gdn. Tools* 56 35  
 cutting cylinder *Text. Finish.* 168 44  
 cutting drum 64 34  
 cutting edge 45 57; 66 14; 85 2  
 cutting edge, cemented carbide ~ 149 48, 50  
 cutting edge, razor's ~ 106 40  
 cutting head 175 51  
 cutting-in brush 129 20  
 cutting machine *Furrier* 131 5  
 cutting machine *Gas Weld.* 141 34  
 cutting machine *Synth. Fibres* 169 30  
 cutting machine, universal ~ 141 36

cutting nozzle 141 38  
 cutting-off machine 125 16  
 cutting pliers 127 51  
 cutting point 136 35  
 cutting room 310 3  
 cutting scale, illuminated ~ 185 6  
 cutting shears 103 3  
 cutting table *Dressm.* 103 4  
 cutting table *Cine Film* 117 96  
 cutting table *Composing Rm.* 175 52  
 cutting table *Films* 311 42  
 cutting template 103 13  
 cutting tip, adjustable ~ 149 45, 46  
 cutting tip, cemented carbide ~ 149 50  
 cutting unit *Gdn. Tools* 56 33, 41  
 cutting unit *Agr. Mach.* 64 8  
 cuttlefish 357 37; 369 4  
 cuttling device 168 35  
 cutup 326 25  
 cutwater 215 56  
 cutworm 80 44  
 cyan filter adjustment 116 45  
 cyclamen 53 5  
 cycle 187 1  
 cycle, motor-paced ~ 290 15  
 cycle racing 290 1-23  
 cycle serial number 187 51  
 cycle track 290 1  
 cycling track 290 1  
 cyclohexanol, pure ~ 170 18  
 cyclohexanol, raw ~ 170 16  
 cyclohexanone 170 20  
 cyclohexanoxime 170 22  
 cyclone 4 38; 9 5  
 cyclone heat exchanger 160 6  
 cyclorama 310 12; 316 9  
 cyclotron 2 49  
 Cygnus 3 23  
 cylinder *Cooper* 130 27  
 cylinder *Metalwkr.* 140 45  
 cylinder *Cotton Spin.* 163 43  
 cylinder *Offset Print.* 180 79  
 cylinder *Railw.* 210 32  
 cylinder *Swim.* 279 19  
 cylinder *Graphic Art* 340 40  
 cylinder *Chem.* 350 45  
 cylinder, developed ~ 182 13  
 cylinder, grooved ~ 165 10  
 cylinder, high-pressure ~ 153 23  
 cylinder, hydraulic ~ 64 8; 194 26  
 cylinder, low-pressure ~ 153 25  
 cylinder, medium-pressure ~ 153 24  
 cylinder, perforated ~ 163 21  
 cylinder, right ~ 347 38  
 cylinder, steel ~ 180 54  
 cylinder arm 177 68  
 cylinder crankcase 190 19  
 cylinder diameter 167 16  
 cylinder head 190 45; 242 47  
 cylinder head gasket 190 48  
 cylinder lock 140 44  
 cylinder oil 145 63

cylinder-processing machine 182 9  
 cylinder temperature gauge 230 9  
 cylinder trimmer 85 25  
 cylinder trolley 141 23  
 cylinder undercasing 163 55  
 cyma 334 11, 19  
 cymatium 334 19  
 cymbal 324 51  
 cymbal holder 324 52  
 cymbals 323 50  
 cymbal stand 324 52  
 cyme 370 70; 374 36  
 cyme, curled ~ 370 77  
 cyme, helicoid ~ 370 76  
 cyme, scorpioid ~ 370 77  
 cypress 372 58  
 cythara 322 15

## D

dabber 340 22  
 dachshund 70 39  
 dactyloscopy 264 28  
 dado, oil-painted ~ 129 15  
 daemon 327 58  
 da gamba violin 323 16  
 dagger, bronze ~ 328 22  
 dagger, hafted ~ 328 22  
 dagger, Malayan ~ 353 44  
 dahlia 51 20; 60 23  
 dairy 76 1-48  
 dairy cow 62 34; 75 17  
 dairy cow shed 75 14  
 dairy plant 76 1-48  
 dairy product 99 43  
 daisy 376 1  
 dam *Map* 15 69  
 dam *Game* 88 1  
 dam *Energy Sources* 155 38  
 dam *Hydr. Eng.* 217 57-64  
 damp course 123 4  
 dampener 180 23, 52, 61  
 dampening roller 180 23, 52, 61  
 dampening unit 180 39, 61  
 damper *Offset Print.* 180 23, 52, 61  
 damper *Car* 191 26; 192 69  
 damper *Music. Instr.* 322 54; 325 37  
 damper, electromagnetic ~ 11 40  
 damper block 325 37  
 damper door 210 6  
 damper lifter 325 38  
 damper-lifting lever 325 23  
 damper pedal 325 8  
 damper rest rail 325 39  
 damping roller 180 23, 52, 61  
 damping unit 180 39, 61  
 dam sill 217 79  
 dance band 306 2  
 dance band instruments 324 47-78  
 dance band musician 306 3  
 dance costume 354 36  
 dance drum 354 14  
 dance floor 317 16



dance floor lighting 317 14  
 dancer 317 17, 18  
 dancer, principal ~ 314 28  
 dancing girl, Hindu ~ 306 25  
 dancing snake 353 48  
 dancing stick 354 37  
 dandelion 51 34; 61 13  
 dandy 306 33  
 dandy brush 71 55  
 Danebrog 253 17  
 Danforth anchor 286 18  
 danger zone 2 50  
 Dan grade 299 15  
 Danish pastry 97 30  
 Dannebrog 253 17  
 daphne 377 10  
 dark beer 93 26  
 darkroom equipment 116 1-60  
 darkroom lamp 116 21  
 dark slide 114 64  
 darning stitch 102 17  
 dart 352 28  
 dart, barbed ~ 319 22  
 dart point 352 29  
 das 366 24  
 dash 342 23  
 dashboard *Carriages* 186 6  
 dashboard *Car* 191 57-90  
 dashboard *Tram* 197 29  
 dashboard lighting 197 30  
 dassie 366 24  
 data, technical ~ 151 32  
 data carrier 237 59, 62-64  
 data centre 248 43  
 data collection station, central ~ 242 20  
 data display terminal 238 2, 11; 248 16, 44  
 data output 112 44  
 data print-out 195 7  
 data processor 237 60  
 data recording back 115 67  
 data service 237 58  
 data storage unit 242 32  
 data terminal 242 19  
 data transmission 237 58  
 data transmission service 237 41  
 date 384 9  
 date and second button 110 4  
 date indicator display 237 39  
 date kernel 384 10  
 date of issue 250 14  
 date of maturity 250 16  
 date of publication 342 42  
 date palm 384 1  
 date sheet 247 33  
 date stamp postmark 236 57  
 daughter boat 228 17  
 davit 221 78, 101; 223 20; 258 13, 83, 88  
 day cream 99 27  
 dayfly 358 6  
 daylight film magazine 311 7  
 daylight-loading tank 116 5  
 day nursery 48  
 dead axle 210 35  
 deadly nightshade 379 7  
 dead man's handle 211 21; 212 13

deadwood 285 47  
 de-aerator 152 16  
 de-airing pug mill 161 7  
 de-airing pug press 161 7  
 dealer 275 3  
 death notice 342 68  
 death's-head hawkmoth 365 9  
 death's-head moth 365 9  
 death spiral 302 5  
 debarking 85 23  
 debenture bond 251 11-19  
 debenzoling 156 27  
 decade 332 32  
 decatizing cylinder, perforated ~ 168 50  
 decay, spontaneous ~ 1 28  
 Decca navigation system 224 39  
 decimal, recurring ~ 344 21, 22  
 decimal fraction, proper ~ 344 20  
 decimal key 247 19  
 decimal place 344 20  
 decimal point 344 20  
 deck *Rowing* 283 57  
 deck *Films* 311 10  
 deck, lower ~ *Offshore Drill* 146 35  
 deck, lower ~ *Lorries etc.* 194 37  
 deck, lower ~ *Space* 235 28  
 deck, main ~ *Offshore Drill* 146 37  
 deck, main ~ *Ship* 221 80; 223 32-42  
 deck, main ~ *Warships* 258 9  
 deck, middle ~ 146 36  
 deck, orthotropic ~ 215 2  
 deck, top ~ 146 37  
 deck, upper ~ *Lorries etc.* 194 38  
 deck, upper ~ *Railw.* 213 36  
 deck, woven ~ 215 18  
 deck beam 222 57  
 deck bucket 221 113  
 deck-chair 37 47; 51 2; 221 111; 274 13  
 deck crane 221 5, 61  
 deck crane *Warships* 259 10  
 decker 172 24, 42, 44, 48, 62  
 deck hand 221 112  
 deckhouse 221 6, 39; 223 34; 258 72  
 decking, woven ~ 215 18  
 deck plan 259 12-20  
 deck plating 222 56  
 deck slab 215 6  
 deck space 223 28  
 deck tennis 280 31  
 declination axis 113 5, 17  
 declination bearing 113 6  
 declination gear 113 4  
 decoder 110 18  
 décolletage 306 24  
 decometer 279 17  
 decoration, Greek ~ 334 38-43  
 decoration, Romanesque ~ 335 14-16

decorative glass worker 124 8  
 decorative pieces 35 4  
 decoy bird 86 48  
 decrescendo 321 32  
 dedication, handwritten ~ 185 50  
 dedusting fan 83 53  
 dedusting screen 83 56  
 deep-sea cable 237 56  
 deep-sea fauna 369  
 deep-sea fishing 90 1-23  
 deep-sea floor 11 10  
 deep-sea medusa 369 5  
 deep-sea salvage tug 258 96  
 deep-sea trench 11 12  
 deep tank 223 78  
 deep-water start 286 46  
 deer, antlerless ~ 88 1  
 deer fence 84 7  
 deer stalking 86 1-8  
 defence area 293 66  
 defender *Ball Games* 292 4  
 defender *Fencing* 294 6  
 defending fencer 294 6  
 deflection system 240 23  
 deflector piston 242 56  
 defroster vent 191 42; 192 64  
 dégagé 314 11, 12  
 degree 345 2  
 degree scale 313 14  
 dehydrogenation 170 19  
 delayed-action release 115 15  
 delay indicator 205 24  
 delicatessen shop 98 1-87  
 deliveries 305 17-20  
 delivery 184 5; 185 23, 35  
 delivery blower 181 33  
 delivery cylinder 180 42, 65  
 delivery hose 270 31  
 delivery mechanism *Offset Print* 180 45  
 delivery mechanism *Post* 236 49  
 delivery pile 180 44; 181 9  
 delivery pipe *Docks* 226 34  
 delivery pipe *Water* 269 16, 49, 52  
 delivery pouch 236 54  
 delivery reel 173 28  
 delivery roller 164 59  
 delivery table 181 31; 184 14, 19  
 delivery tray 185 15  
 delivery tube 65 77  
 delivery unit 180 45  
 delivery valve 67 9  
 delphinium 60 13  
 delta 13 1  
 delta connection 153 21  
 delta wing 229 19  
 deltoid 346 38  
 demand regulator, two-tube ~ 279 20  
 demesne 15 94  
 demi-goat 254 32  
 demigod 327 40  
 demijohn 206 13  
 demi-man 254 11  
 demi-mondaine 306 37  
 demi-monde 306 37  
 demi-rep 306 37

demisemiquaver 320 18  
 demisemiquaver rest 320 26  
 demi-woman 254 11  
 demonstration bench 261 3  
 demonstration equipment 242 45-84  
 demonstration model 242 45, 55  
 demonstrator 262 6  
 den 273 56  
 Deneb 3 23  
 denims 31 60; 33 22  
 denomination *Money* 252 32  
 denomination *Maths* 344 19  
 denominator 344 15  
 dental surgeon 24 1  
 dentate 370 47  
 dent corn 68 31  
 dentil 334 14  
 dentine 19 31  
 denting draft 171 6  
 dentist 24 1  
 denture 24 25  
 department manager 271 60  
 department store 268 41; 271  
 departure building 233 15  
 'departures' 233 25  
 departure schedule 204 20  
 departure time indicator 205 23  
 departure timetable 204 20  
 deposit counter 236 25  
 deposit slip 236 27  
 depot 144 17  
 depression 9 5  
 depth adjustment 64 88; 65 60; 157 45  
 depth-charge thrower 258 34  
 depth gauge *D.I.Y.* 134 47  
 depth gauge *Swim.* 279 15  
 depth gauge attachment rule 149 68  
 depth of focus 11 34  
 depth reading 224 67  
 depth recorder 224 24  
 depth recording 224 67  
 depth scale 224 66  
 depth wheel 65 59, 63  
 derailment guard 214 75  
 derivative 345 13  
 derrick *Phys. Geog.* 12 33  
 derrick *Offshore Drill* 146 12  
 derrick *Ship* 221 67  
 derrick boom 221 26, 59; 223 36  
 derrick boom, heavy-lift ~ 221 25, 62  
 derrick mast 221 60  
 descant viol 322 23  
 descent stage 6 28-36  
 desert monitor 364 31  
 desert zone 9 54  
 desiccator 350 51  
 desiccator insert 350 54  
 design 151 16  
 design, chequered ~ 335 14  
 design, computer-generated ~ 248 19  
 design, imbricated ~ 335 15  
 design, knitted ~ 30 37  
 design, modular ~ 240 1

design, quilted ~ 30 31  
 design for costume 315 39  
 designs, decorative ~ 334 38-43; 335 14-16  
 desk 46 22; 246 2  
 desk, cashier's ~ 250 1  
 desk, clerical assistant's ~ 248 11  
 desk, double ~ 260 2  
 desk, instructor's ~ 242 2  
 desk, stage manager's ~ 316 29  
 desk, teacher's ~ 260 22  
 desk chair 46 27  
 desk diary 247 32  
 desk drawer 46 26; 246 4  
 desk lamp 246 11  
 desk mat 46 23; 246 6; 260 25  
 desk set 246 9  
 desk top 246 3  
 desk unit 46 21  
 dessert bowl 45 6  
 dessert plate 45 6  
 dessert spoon 45 61, 66  
 destination board 205 21, 38  
 destination indicator 205 22  
 destination sign 197 20  
 destroyer 258 1, 38  
 desulfurization see desulphurization  
 desulfurizing see desulphurizing  
 desulphurization 156 28  
 desulphurizing 169 20  
 desulphurizing plant 145 46, 68  
 detaching roller 163 71  
 detangling brush 105 2  
 detective 264 33  
 detector indicator unit 224 34  
 detonator cap 87 58  
 detritus 12 45  
 deutero-pyramid 351 20  
 Deutschmark 252 7  
 Devanagari 341 9  
 developer 27 33  
 developer, first ~ 116 10  
 developing dish 116 25  
 developing dish, semi-automatic ~ 116 56  
 developing dish, thermostatically controlled ~ 116 56  
 developing solution 116 9  
 developing spiral 116 2  
 developing tank *Photog.* 116 1, 20  
 developing tank *Photograv.* 182 11  
 developing tank, multi-unit ~ 116 3  
 developing tank (thermometer) 116 8  
 developing tray 116 25  
 deviation mirror 113 11  
 device 252 12  
 devil 306 14  
 devil's tail 340 34  
 devil's tobacco pouch 381 20  
 devil's wheel 308 46  
 de-waxing 145 50

dew claw 88 23, 57  
 dewlap 73 24  
 dexter 254 18, 20, 22  
 D (flat major) 320 67  
 diabetics file 22 26  
 diacritics 342 30-35  
 diadem 355 21  
 diadem, pearl ~ 355 16  
 diaeresis 342 34  
 diagnostic test bay 195 1-23  
 diagonal 346 33  
 diagram *Drawing Off.* 151 11  
 diagram *School* 260 34  
 diagram *Univ.* 262 8  
 dial 204 5; 237 10; 245 16  
 dial finger plate 237 11  
 dial finger stop 237 12  
 dialling unit 237 67  
 dial wind-up plate 237 11  
 diameter 346 45  
 diamond *Composing Rm.* 175 21  
 diamond *Audio* 241 26  
 diamond *Crystals* 351 10, 13  
 diamonds 276 41  
 diaper, disposable ~ 28 22  
 diaphragm *Meteorol. Instr.* 10 27  
 diaphragm *Man* 20 9, 26  
 diaphragm *Dent.* 24 33  
 diaphragm *Inf. Tech.* 242 82  
 diaphragm, bladed ~ 233  
 diaphragm chest 326 12-14  
 diaphragm spring 190 29  
 diathermy unit 23 22  
 diazo plate 179 32, 34  
 dibber 54 7; 56 1  
 dibble 54 7; 56 1  
 dice 276 29, 31  
 dice cup 47 42; 276 30  
 dicing 276 29  
 dictating machine 22 27; 209 30; 246 17; 248 34  
 dictating machine, pocket-sized ~ 246 32  
 dictionary 262 17  
 dictionary, medical ~ 22 22  
 didelphid 366 2  
 Didone 342 6  
 die *Metalwkr.* 140 32  
 die *Brickwks.* 159 13  
 die, lower ~ 252 41  
 die, steel ~ 175 36  
 die, upper ~ 252 40  
 die and stock 140 32  
 die blank 175 35  
 die block, lower ~ 139 14, 39  
 die block, upper ~ 139 13, 38  
 die case 174 42, 46  
 die head 143 57  
 diesel-electric drive 223 68-74; 259 75  
 diesel engine *Energy Sources* 155 5  
 diesel engine *Intern. Combust. Eng.* 190 4  
 diesel engine *Railw.* 211 47; 212 25, 51  
 diesel engine *Ship* 223 73  
 diesel engine, auxiliary ~ 209 19



diesel engine, eight-cylinder ~ 212 73  
 diesel engine, five-cylinder in-line ~ 190 3  
 diesel engine, four-cylinder ~ 65 44  
 diesel engine, six-cylinder ~ *Agr. Mach.* 64 28  
 diesel engine, six-cylinder ~ *Railw.* 209 23  
 diesel engine, underfloor ~ 209 23  
 diesel fuel 146 26  
 diesel generator 259 94  
 diesel generator unit 209 5  
 diesel-hydraulic locomotive 212 1, 24, 47; 213 1  
 diesel locomotive 212 1, 68  
 diesel locomotive, single-engine ~ 208 1  
 diesel locomotives 212 1-84  
 diesel oil 145 56  
 diesel railcar 208 13; 211 41  
 diesel tank 146 13  
 diesel trainset 209 1  
 die stock 125 27  
 diet meal 266 62  
 difference 344 24  
 differential *Agr. Mach.* 65 32  
 differential *Intern. Combust. Eng.* 190 75  
 differential *Maths.* 345 13, 14  
 differential gear 65 32; 190 75  
 differential sign 345 13  
 diffuser *Photog.* 114 60  
 diffuser *Paperm.* 172 11, 13  
 diffuser *Space* 234 15  
 diffusing screen 310 38  
 digester 172 7  
 digger 64 59  
 digger, toy ~ 273 65  
 digging bucket 200 5  
 digging bucket arm 200 4  
 digging bucket teeth 200 6  
 digging fork 66 22  
 Digitalis 379 2  
 digital readout *Clocks* 110 2  
 digital readout *Optic. Instr.* 112 47  
 digitate 370 39  
 digitated 370 39  
 digitus I 19 52, 64  
 digitus II 19 53, 65  
 digitus III 19 54, 66  
 digitus IV 19 55, 67  
 digitus V 19 56, 68  
 digitus anularis 19 67  
 digitus medius 19 66  
 digitus minimus 19 56, 68  
 dike 216 34, 39  
 dike, main ~ 216 32  
 dike batter 216 40  
 dike ramp 216 47  
 dikereeve 216 46  
 dike slope 216 40  
 diligence 186 39  
 dimension line 151 25  
 diminished triad 321 3  
 diminuendo 321 32  
 dimmer switch 127 17  
 dimple 16 16  
 dinar 252 28  
 diner 207 22-32  
 dinghy, inflatable ~ 228 18; 258 82; 278 14; 279 27  
 dinghy cruiser 284 61  
 dining area 266 73  
 dining car 207 22-32  
 dining car kitchen 207 33  
 dining chair 44 10  
 dining compartment 207 32, 77  
 dining room 44; 223 44; 267 20  
 dining set 42 33-34; 44 1-11  
 dining table 42 33; 44 1; 45 1; 46 34  
 dinner dress 33 7  
 dinner plate 39 42; 44 7; 45 4  
 dinner service 44 33  
 dinner set 44 33  
 diopter control ring 117 15  
 dioptic adjustment ring 117 15  
 dip, true ~ 12 3  
 diploma 106 42  
 dipole antenna 230 65  
 dipper stick 200 4  
 dipstick 190 47  
 dipterans 358 16-20  
 dipyrmaid, tetragonal ~ 351 18  
 direct current motor 150 9  
 direction, negative ~ 347 7  
 direction, positive ~ 347 6  
 directional antenna *Moon L.* 6 4, 44  
 directional antenna *Post* 237 51, 52  
 directional antenna assembly 234 64  
 directional gyro 230 13  
 direction finder, automatic ~ 230 5  
 direction finder antenna 223 5  
 director 310 40; 316 40  
 director of photography 310 44  
 directory enquiries 237 33  
 directory holder 236 11  
 direct-vision frame finder 117 58  
 dirndl 31 26  
 dirndl, girl's ~ 29 36  
 dirndl apron 31 31  
 dirndl blouse 31 29  
 dirndl dress 31 26  
 dirndl necklacc 31 28  
 disc *Flat* 46 15  
 disc *Agr. Mach.* 65 83  
 disc *Disco* 317 24  
 disc, adhesive ~ 364 26  
 disc, carborundum ~ 24 35  
 disc, facial ~ 362 18  
 disc, germinal ~ 74 65  
 disc, insertable ~ 115 96  
 disc, metal ~ 309 15  
 disc, plain ~ 65 84  
 disc, revolving ~ 275 31  
 disc, serrated-edge ~ 65 85

disc, silver ~ 10 24  
 disc, solar ~ 4 36  
 disc barbell 299 3  
 disc brake *Intern. Combust. Eng.* 190 74  
 disc brake *Car* 191 17-18; 192 48-55  
 disc brake *Railw.* 208 4  
 disc brake, front ~ 189 32  
 disc brake calliper 189 33  
 disc clutch 139 21  
 disc coupler drive 64 68  
 disc fibula 328 30  
 discharge, pneumatic ~ 213 18  
 discharge connection valve 213 21  
 discharge conveyor 64 83  
 discharge door 139 2; 213 25  
 discharge flap 213 25  
 discharge flume 91 41  
 discharge opening *Forging* 139 2  
 discharge opening *Sawmill* 157 56  
 discharge opening *Hydr. Eng.* 217 56  
 discharge pipe 64 37  
 discharge structure 217 44  
 discharging chute 147 39  
 discharging position 147 58  
 disc jockey 317 25  
 discomedusa 357 14  
 discotheque 317  
 disc pack 176 34  
 disc slot 243 38  
 disc stack 176 34  
 disc store 244 1  
 discussion tube arrangement 112 22  
 disc wheel 191 14  
 disgorging 89 40  
 disguise 306 6-48  
 dish 332 50  
 dish, three-compartment ~ 40 8  
 dish drainer 39 33  
 dish rack 39 41  
 dish thermometer 116 13  
 dishwasher 39 40  
 dishwashing machine 39 40  
 disinfectant powder 83 60  
 disintegrator 172 5  
 disk *see* disc  
 dislocation 11 50  
 dispenser 22 64  
 displacement 11 50  
 displacement boats 286 32-37  
 display 47 30; 271 67  
 display, digital ~ *Clocks* 110 20  
 display, digital ~ *Optic. Instr.* 112 47  
 display, individual ~ 242 3  
 display, visual ~ *Railw.* 211 34  
 display, visual ~ *Broadcast.* 238 2, 43  
 display cabinet 44 26; 46 9  
 display cabinet unit 42 5  
 display case 271 13

display counter 99 10  
 display pipes 326 1-3  
 display window, indoor ~ 271 13  
 dissecting bench 261 22  
 dissolver 172 37  
 dissolving tank 172 37  
 distance 346 5  
 distance-measuring instrument 112 70  
 distance piece *Bees* 77 41  
 distance piece *Bldg. Site* 119 81  
 distance scale 115 4  
 distance setting 114 28; 117 3  
 distance-setting ring 114 39; 115 8  
 distant signal identification plate 203 24  
 distillation 170 17  
 distillation, gradual ~ 170 4  
 distillation apparatus 350 46  
 distillation column 145 37, 49  
 distillation flask 350 47, 50  
 distillation plant 145 66  
 distillation product, heavy ~ 145 40  
 distillation product, light ~ 145 39  
 distilling apparatus 350 46  
 distilling flask 350 47, 50  
 distributary 13 2  
 distributing machine 236 38  
 distributing mechanism 174 20  
 distributing pipe 126 8  
 distributing roller 181 7, 62; 249 51  
 distribution board 157 67  
 distribution main 269 22  
 distribution pipe, main ~ 38 71  
 distribution steel 119 69  
 distributor *Composing Rm.* 174 20  
 distributor *Letterpress* 181 7, 62  
 distributor *Intern. Combust. Eng.* 190 9, 27  
 distributor *Office* 249 51  
 distributor cylinder 62 23  
 distributor roller 181 7, 62  
 distributor shaft 190 27  
 distributor unit 62 22  
 district boundary 15 103  
 district heating main 198 28  
 ditch 329 33, 37  
 ditch fern 377 16  
 divan, double ~ 43 4-13  
 diver 282 5  
 dividend 344 26  
 dividend coupon 251 18  
 dividend coupon sheet 251 17  
 dividend warrant 251 18  
 divider *Agr. Mach.* 64 1  
 divider *Bakery* 97 56  
 divider and rounder 97 63  
 dividing 344 26  
 dividing breeching 270 32  
 diving, acrobatic ~ 282 40-45

diving, competitive ~ 282 40-45  
 diving, fancy ~ 282 40-45  
 diving apparatus 279 12, 19; 282 5-10  
 diving board 282 9  
 diving boards 282 5-10  
 diving goggles 280 38  
 diving mask 279 10  
 diving plane, aft ~ 259 95  
 diving platform 282 6  
 diving pool 282 11  
 division *Navig.* 224 89  
 division *School* 260 39  
 division *Maths.* 344 26  
 division sign 344 26  
 divisor 344 26  
 D major 320 57  
 D minor 320 63  
 Dobermann terrier 70 27  
 dock *Horse* 72 34  
 dock *Shipbuild.* 222 36-43  
 dock, emptied ~ 222 43  
 dock, floating ~ *Shipbuild.* 222 34-43, 41  
 dock, floating ~ *Docks* 225 16  
 dock area 225 1  
 dock basin 222 36  
 dock bottom 222 31  
 dock crane 222 34  
 dock floor 222 31  
 dock gate 222 32  
 docking a ship 222 41-43  
 docking hatch 6 45  
 docking target recess 6 47  
 docks 225; 226  
 dockside crane 222 34  
 dock structure 222 37-38  
 dockyard 222 1-43  
 doctor 22; 23  
 'doctor' *Airport* 233 44  
 doctor blade 168 44  
 document 245 19  
 document, confidential ~ 246 25  
 document file 245 6; 247 37; 248 5  
 document glass 249 39  
 dodecahedron, pentagonal ~ 351 8  
 dodecahedron, rhombic ~ 351 7  
 dodgem 308 62  
 dodgem car 308 63  
 dodger 223 17  
 doe *Dom. Anim.* 73 18  
 doe *Game* 88 40, 59  
 doe, barren ~ 88 34  
 doe, young ~ 88 39  
 doffer 163 42  
 doffer comb, vibrating ~ 163 39  
 dog *Dom. Anim.* 73 16  
 dog *Game* 88 42  
 dog *Bldg. Site* 119 58  
 dog *Roof* 121 97  
 dog *Intern. Combust. Eng.* 190 39  
 dog, three-headed ~ 327 30  
 dog, toy ~ 47 7, 41  
 dog biscuit 99 37

dog bowl 70 32  
 dog brush 70 28  
 dogcart 186 18  
 dog comb 70 29  
 dog flange 190 39  
 dog food 99 36  
 dog lead 70 30  
 dog rose 373 26  
 dogs *Dog* 70  
 dogs *Forging* 139 33  
 dog sled 353 3  
 dog sledge 353 3  
 Dog Star 3 14  
 dog tick 358 44  
 do-it-yourself 134  
 do-it-yourself enthusiast 134 61  
 do-it-yourself work 134 1-34  
 doldrums 9 46  
 dolina 13 71  
 doll 309 11  
 doll, sleeping ~ 47 11  
 doll, walking ~ 273 63  
 dollar 252 33  
 doll's pram 47 10; 48 24  
 dolly *Flea Market* 309 68  
 dolly *Films* 310 49  
 dolmen 328 16  
 dolphin 225 12  
 dolphin butterfly stroke 282 35  
 dome *Brew.* 92 45  
 dome *Art* 337 21  
 dome, high ~ 36 79  
 dome, imperial ~ 121 25  
 dome, main ~ 334 72  
 dome, revolving ~ 5 12  
 dome cover 38 48  
 dome shutter 5 14  
 dome system 334 72-73  
 domiciliation 250 22  
 dominant seventh chord 321 5  
 domino *Games* 276 34  
 domino *Carnival* 306 13, 15  
 dominoes 276 33  
 domino panel 203 66  
 donjon 329 4  
 donkey 73 3  
 door *Farm Bldgs.* 62 17  
 door *Carriages* 186 11  
 door *Tram* 197 32  
 door *Railw.* 207 20, 22  
 door, bottom ~ 210 7  
 door, double ~ *Tram* 197 14  
 door, double ~ *Railw.* 208 7  
 door, double ~ *Hotel* 267 27  
 door, driver's ~ 193 2  
 door, folding ~ *Tram* 197 14  
 door, folding ~ *Railw.* 207 39; 208 7  
 door, front ~ *Dwellings* 37 65  
 door, front ~ *Hall* 41 25  
 door, front ~ *Household* 50 30  
 door, front ~ *Floor etc. Constr.* 123 24  
 door, front ~ *Car* 193 5  
 door, glass ~ 44 18  
 door, hinged ~ 194 12  
 door, ledged ~ 37 34  
 door, main ~ *Church* 331 16



door, main ~ *Art* 335 24  
 door, outer ~ 259 78  
 door, outward-opening ~ 194 35  
 door, rear ~ *Car* 193 3, 6, 20  
 door, rear ~ *Lorries etc.* 194 11  
 door, revolving ~ 213 9  
 door, side ~ *Lorries etc.* 194 8, 12  
 door, side ~ *Railw.* 213 9  
 door, sliding ~ *Farm Bldgs.* 62 16  
 door, sliding ~ *Brew.* 92 47  
 door, sliding ~ *Lorries etc.* 194 8  
 door, sliding ~ *Railw.* 213 15  
 door, vertical-lift ~ 139 51  
 doorbell 127 2  
 door frame 41 26  
 door handle *Hall* 41 28  
 door handle *Carriages* 186 12  
 door handle *Car* 191 5  
 door-lifting mechanism 139 55  
 door lock *Hall* 41 27  
 door lock *Metalwkr.* 140 36-43  
 door lock *Car* 191 6  
 doorman 267 1; 271 44  
 dormer 37 56; 38 7; 121 6; 329 11; 336 4  
 dormer window 37 56; 38 7; 121 6; 329 11; 336 4  
 dormer window, hipped ~ 121 13  
 dorsum manus 19 83  
 dorsum of the foot 19 61  
 dorsum of the hand 19 83  
 dorsum pedis 19 61  
 dosimeter 2 8-23  
 dosing mechanism 83 60  
 dossier 78 15  
 dossier carrier 78 14  
 dot 178 39  
 dot, French ~ 102 13  
 dot ball, white ~ 277 13  
 double 276 35  
 double backward somersault 282 42  
 double bass 323 23  
 double bassoon 323 28  
 double bass viol 322 23; 323 23  
 double bull capital 333 28  
 double bull column 333 23  
 double edger 157 57  
 double flat 320 53  
 double-lap roofing 122 2  
 double leg circle 296 54  
 double leg lock 299 11  
 double mill 276 25  
 double overarm stroke 282 37  
 doubles 293 2-3  
 doubles, mixed ~ 293 49  
 double sharp 320 51  
 doubles match 293 2-3  
 doubles sideline 293 2-3  
 doublet, padded ~ 355 30, 45  
 doublet, paned ~ 355 33  
 doublet, quilted ~ 355 45

doublet, short ~ 355 41, 45  
 doublet, slashed ~ 355 33  
 doublet, stuffed ~ 355 30  
 double-three 302 14  
 double unit for black 180 12-13  
 double unit for cyan 180 8-9  
 double unit for magenta 180 10-11  
 double unit for yellow 180 6-7  
 double-whole note 320 12  
 doubling frame 164 57  
 doubling of slivers 164 5  
 dough mixer 97 55, 59  
 doughnut 97 29  
 douze dernier 275 27  
 douze milieu 275 26  
 douze premier 275 25  
 dovetail halving 121 89  
 dowel hole 120 22, 23  
 dowel hole borer 133 6  
 dowel hole boring machine 133 6  
 down-draught carburettor 192 1-15  
 down-gate 148 21  
 downhill racing 301 32  
 downhill racing pole 301 25  
 downhill racing position 301 33  
 downhill ski 301 34  
 downpipe 37 13; 38 10; 122 29; 147 63  
 downspout 37 13; 38 10  
 downtake 147 13  
 down-town 268  
 down tube 187 17  
 downy mildew 80 20, 21  
 drachma 252 39  
 Draco 3 32  
 draft 92 50  
 draft see draught  
 draft *Weaves* 171 4, 11, 13, 19, 21, 27  
 draft *Bank* 250 12  
 draft, rough ~ 338 4  
 draft board 168 7  
 draft clause 250 17  
 drafting 164 12, 13  
 drafting machine 151 2  
 drafting roller 164 21, 22, 29  
 draft mark 222 73  
 drag *Iron Foundry etc.* 148 20  
 drag *Equest.* 289 48  
 drag chute housing 257 24  
 drag hook *Horse* 71 14  
 drag hook *Fire Brig.* 270 49  
 drag hunt 289 41-49  
 drag lift 214 15  
 Dragon *Astron.* 3 32  
 dragon *Sailing* 284 57  
 dragon *Fabul. Creat.* 327 1, 50  
 dragon, seven-headed ~ 327 50  
 dragon beam 120 42  
 dragon figurehead 218 16  
 dragonfly 358 3  
 dragon piece 120 42  
 dragon ship 218 13-17  
 drain *Street Sect.* 198 23

drain *Rivers* 216 37  
 drain *Town* 268 8  
 drainage 144 46  
 drainage basin 12 24  
 drainage ditch *Road Constr.* 200 63  
 drainage ditch *Rivers* 216 33  
 drainage layer 199 25  
 drainage sluice 216 34  
 drainage tube 26 47  
 drain cock 178 34  
 drain cover 198 24  
 drain pipe 198 25; 199 26  
 drain plug 284 36  
 drake 73 35  
 drapery 338 33  
 draught beam 65 18  
 draughtboard 276 17  
 draught mark 222 73  
 draughts 276 17-19  
 draughtsman 276 18, 19  
 drawbar 64 47, 61; 65 18  
 drawbar coupling *Agr. Mach.* 65 30  
 drawbar coupling *Camping* 278 55  
 drawbar frame 65 26  
 drawbar support 64 62  
 drawbar trailer 194 22  
 drawbench 108 2  
 drawbridge 329 25  
 draw cord 29 67  
 draw curtain 315 1  
 drawee 250 20  
 drawer *Dent.* 24 17  
 drawer *Hall* 41 9  
 drawer *Bedrm.* 43 18  
 drawer *Flar* 46 11  
 drawer *Bathrm. etc.* 49 34  
 drawer *Bank* 250 21  
 draw frame 164 1  
 draw frame, four-roller ~ 164 9  
 draw frame, simple ~ 164 9  
 draw frame cover 164 7  
 draw hoe 66 1  
 draw hook 270 49  
 drawing *Drawing Off.* 151 16  
 drawing *Synth. Fibres* 170 55  
 drawing, final ~ 170 47  
 drawing, preliminary ~ 170 45  
 drawing, rolled ~ 151 10  
 drawing bench 108 2  
 drawing board 151 1  
 drawing board adjustment 151 5  
 drawing easel 338 34  
 drawing floor 120 11  
 drawing head 151 4  
 drawing ink cartridge 151 36  
 drawing ink container 151 63  
 drawing-in roller 168 12  
 drawing knife 120 79  
 drawing machine 162 7  
 drawing office 151  
 drawing pen, tubular ~ 151 37, 38  
 drawing roll 162 11  
 drawing table 151 6  
 draw-in wire 127 30

drawknife 120 79  
 draw-off tap 126 34  
 drawshave 120 79  
 draw stop 325 44; 326 6  
 drawstring 29 64, 67  
 drawstring waist 31 66  
 draw well 329 3  
 draw wire 127 30  
 draw works 145 11  
 dredger 216 56; 226 41  
 dredger, hydraulic ~ 216 59  
 dredger bucket 226 44  
 dredging bucket 216 58  
 dredging machine, floating ~ 216 56  
 dress 31 9  
 dress, button-through ~ 30 10  
 dress, jersey ~ 29 28  
 dress, knitted ~ 29 28; 30 33  
 dress, off-the-peg ~ 271 29  
 dress, peasant-style ~ 30 27  
 dress, ready-made ~ 271 29  
 dress, ready-to-wear ~ 271 29  
 dress, shirt-waister ~ 30 10  
 dress, two-piece ~ 30 33; 31 11  
 dress, wrap-around ~ 30 25  
 dress, wrapover ~ 30 25  
 dressage 289 1-7  
 dressage arena 289 1  
 dress and jacket combination 31 6  
 dress circle 315 18  
 dress form 103 6  
 dress guard 104 14  
 dressing, sterile gauze ~ 21 6  
 dressing axe 158 38  
 dressing comb 105 15; 106 28  
 dressing floor 92 8  
 dressing gown 29 24; 32 35  
 dressing machine 83 52  
 dressing material 26 34  
 dressing room 315 43-52  
 dressing room mirror 315 43  
 dressing stool 43 24  
 dressing table 43 25; 105 19  
 dressing-table mirror 43 29  
 dressmaker 103 1  
 dress shirt 32 43  
 dress sword 355 63  
 dribble 291 52  
 drier *Synth. Fibres* 170 38  
 drier *Paperm.* 173 22  
 drier *Offset Print.* 180 14, 27  
 drier, swivel-mounted ~ 105 25  
 drier felt 173 23  
 driers 50 23-34  
 drift net fishing 90 1-10  
 drill *Dent.* 24 6, 17  
 drill *Agr. Mach.* 65 74  
 drill *Goldsm. etc.* 108 4  
 drill *Turner* 135 22  
 drill, electric ~ 56 19; 120 21; 134 16, 50-55  
 driller 158 9  
 drilling bit 145 21  
 drilling cable 145 7  
 drilling line 145 7  
 drilling machine, electric ~ 108 6

drilling machine, radial-arm ~ 150 18  
 drilling machine, suspended ~ 108 6  
 drilling pipe 145 19  
 drilling platform 146 1-37; 221 66  
 drilling rig 145 1; 146 1-39  
 drilling vessel, semisubmersible ~ 221 64  
 drill pipe 145 6  
 drill spindle 150 23  
 drill stand 134 54  
 drill tower 270 3  
 drink, soft ~ 96 30; 99 72  
 drinker, mechanical ~ 74 16  
 drinking bowl, mechanical ~ 74 16  
 drinking fountain 205 33  
 drinking straw 266 46  
 drinking trough 74 6  
 drinking water carrier 278 32  
 drinking water supply 269 1-66  
 drinking water tank 146 16  
 drinks cabinet 246 29  
 drinks cupboard 42 20  
 drinks gondola 99 71  
 drinks shelf 266 59  
 drinks stall 308 3  
 drip, intravenous ~ 25 13; 26 9  
 drip fuel line 190 53  
 drip ring 283 40  
 dripstone 13 80  
 drip tray 266 2  
 drive *Composing Rm.* 175 37  
 drive *Railw.* 214 2  
 drive, clockwork ~ 10 14  
 drive, conventional ~ 259 75  
 drive, crystal-controlled ~ 310 19, 24  
 drive, fluid ~ 65 37  
 drive, hydraulic ~ 139 9, 15  
 drive, main ~ 214 63  
 drive belt 103 10  
 drive-belt gear 109 21  
 drive chain 188 17  
 drive clutch 177 54  
 drive connection 67 19  
 drive gearbox 163 57; 168 10, 32  
 drive mechanism 110 43  
 drive motor *Poultry Farm* 74 37  
 drive motor *Dressm.* 103 9  
 drive motor *Forging* 139 25  
 drive motor *Mach. Tools* 150 9  
 drive motor *Cotton Spin.* 163 12, 23, 49  
 drive motor *Text. Finish.* 168 55  
 drive motor *Composing Rm.* 175 61  
 drive motor *Electrotyp. etc.* 178 12, 28  
 drive motor *Offset Platem.* 179 11  
 drive motor *Hydr. Eng.* 217 47

drive pulley, fast-and-loose ~ 163 50  
 drive pulley, main ~ 163 50  
 driver *Carriages* 186 32  
 driver *Bicycle* 187 72  
 driver *Serv. Stat.* 196 8  
 driver *Ship* 219 30  
 driver *Equest.* 289 26  
 driver *Ball Games* 293 91  
 driver plate 149 55  
 driver's brake valve 210 53; 211 22; 212 11  
 driver's position *Agr. Mach.* 64 33  
 driver's position *Tram* 197 25  
 drive shaft *Car* 192 30  
 drive shaft *Hydr. Eng.* 217 49  
 drive unit *Shoem.* 100 8  
 drive unit *Photomech. Reprod.* 177 56  
 drive unit, central ~ 238 57  
 drive well 269 60  
 drive wheel *Agr. Mach.* 65 80  
 drive wheel *Shoem.* 100 8  
 drive wheel *Text. Finish.* 168 4  
 drive wheel *Offset Print.* 180 66  
 drive wheel *Army* 255 50  
 drive wheel unit 209 3  
 driving 86 34-39  
 driving axle 210 37  
 driving axle gearing 64 30  
 driving barrel 187 73  
 driving cylinder 165 32  
 driving drum 165 32, 35  
 driving gear *Cotton Spin.* 163 57  
 driving gear *Railw.* 210 2-37  
 driving guide rail 226 39  
 driving pinion 214 8  
 driving plate *Turner* 135 9  
 driving plate *Mach. Tools* 149 55  
 driving shaft 163 24  
 driving trailer car 211 62  
 driving unit 209 2  
 driving wheel tyre 64 31  
 drizzle 9 33  
 drone *Bees* 77 5  
 drone *Music. Instr.* 322 11  
 drone cell 77 36  
 drone pipe 322 11  
 drone string 322 31  
 droop flap 229 54  
 droop nose 231 16  
 drop 98 76  
 drop, plain ~ 36 85  
 drop board 267 5  
 drop cloth 316 11  
 drop compass 151 59  
 drop forging 139  
 drop grate 210 5  
 drop grate lever 210 40  
 drop hammer, air-lift ~ 139 24  
 drop hammer, short-stroke ~ 139 11  
 drop net 89 29  
 drop pin 165 37  
 droppings removal 74 23-27



dropping worm 149 18  
 drop pin roller 165 39  
 drop windscreen 255 97  
 drop windshield 255 97  
 drop wire 166 34  
 drop worm 149 18  
 drove 158 37  
 drove chisel 158 37  
 'druggist' 233 45  
 drum *Meteorol. Instr.* 10 5, 16, 20  
 drum *Household* 50 29  
 drum *Agr. Mach.* 64 12  
 drum *Painter* 129 9  
 drum *Cooper* 130 13  
 drum *Nucl. Energy* 154 77  
 drum *Nightclub* 318 10  
 drum *Music. Instr.* 323 57  
 drum *Art* 335 44  
 drum, hollow ~ 312 49  
 drum, lansquenets ~ 306 70  
 drum, revolving ~ 273 45  
 drum brake 188 36  
 drum brake, front ~ 189 11  
 drum brake, rear ~ 189 13  
 drum head 323 52  
 drum kit 324 47-54  
 drummer 318 11  
 drum of paint 129 9  
 drums 324 47-54  
 drum set 324 47-54  
 drumstick *Supermkt.* 99 59  
 drumstick *Music. Instr.* 323 54  
 drumstick *Ethnol.* 354 19  
 drupe 59 41, 43, 49; 370 99; 382 51; 384 40  
 drupes 59 59, 1-36  
 dryas 51 7  
 dry bulb thermometer 10 34  
 dry cell battery 127 27  
 dry cooling tower 154 39  
 dry dock 222 31-33; 225 17  
 drying 169 24; 170 58  
 drying cabinet 116 23  
 drying chamber 170 49  
 drying cylinder 165 50, 53; 173 22  
 drying cylinder, heated ~ 173 33  
 drying floor 92 16  
 drying kiln 92 29  
 drying machine 169 31  
 drying rack *Agr.* 63 28, 29  
 drying rack *Flea Market* 309 49  
 drying section 168 28  
 drying shed 159 17  
 dry-seed dressing 83 52  
 dry zone, equatorial ~ 9 54  
 D sharp minor 320 61  
 dual film-tape recording 117 70  
 dual film-tape reproduction 117 75  
 dual film-tape system 117 7  
 dubbing *Films* 311 1-46, 37-41  
 dubbing *Chivalry* 329 66  
 dubbing actress 311 39  
 dubbing director 311 38

dubbing mixer 311 36  
 dubbing room 311 34  
 dubbing speaker 311 39  
 dubbing studio *Broadcast.* 238 28  
 dubbing studio *Films* 311 37  
 dubbing theatre *Broadcast.* 238 28  
 dubbing theatre *Films* 311 37  
 duck 73 35  
 duck, toy ~ 49 4; 273 30  
 duck, wild ~ 86 41; 272 51  
 duck-bill 366 1  
 duck hunting 86 40  
 ducking 299 29  
 duckling 73 35  
 duck-mole 366 1  
 duck shooting 86 40  
 duck's meat 378 35  
 duckweed 378 35  
 duct 163 11  
 duct, cystic ~ 20 38  
 duct, hepatic ~ 20 37  
 duct, spermatic ~ 20 74  
 ductor 181 63  
 ductor roller 181 63  
 duct roller 181 64  
 due date 250 16  
 duffle coat 271 21  
 dugout 218 7; 354 20  
 duk-duk dancer 352 34  
 dulcimer 322 32  
 Dülfer seat 300 30  
 dumb barge 225 8  
 dumb barge, tug-pushed ~ 221 94  
 dummy *Infant Care etc.* 28 15  
 dummy *Store* 271 34  
 dummy, dressmaker's ~ 103 6  
 dummy bull 319 3  
 dummy funnel 221 16  
 dump body 194 25; 200 8  
 dump car 213 37  
 dump chest 172 81  
 dumping bucket 214 34  
 dumping device 147 44, 59  
 dump truck 47 38; 147 64; 200 7  
 dump truck, three-way ~ 194 24  
 dune, crescentic ~ 13 40  
 dune, migratory ~ 13 39  
 dune, travelling ~ 13 39  
 dune, wandering ~ 13 39  
 dune buggy 193 12  
 dung 63 15  
 dungarees 29 40; 30 21  
 dung beetle 358 39  
 dungeon 329 5  
 dunging, mechanical ~ 74 23-27  
 dunging chain 74 27  
 dunging conveyor 74 27  
 dung tank 221 72  
 dunnage 222 62u.63  
 duodenum 20 14, 43  
 duplet 321 23  
 duplicate list 263 27  
 duramen 120 84; 370 13  
 dust, fine ~ 158 22  
 dust, lunar ~ 6 14

dust bag container 50 62  
 dustbin 199 3  
 dustbin-tipping device 199 2  
 dust brush 109 18  
 dust cap 187 57, 82  
 dust catcher *Goldsm. etc.* 108 45  
 dust catcher *Iron & Steel* 147 14  
 dust-collecting chamber 163 11  
 dust-collecting machine 147 14  
 dust collector *Goldsm. etc.* 108 45  
 dust collector *Cement Wks.* 160 7  
 dust collector *Refuse Coll.* 199 47  
 dust container 50 86  
 dust counter 112 42  
 dust cover *Bookbind.* 185 37  
 dust cover *Audio* 241 32  
 dust cover *Store* 271 30  
 dust discharge flue 163 22  
 dust escape flue 163 22  
 dust exhauster 108 43  
 dust extraction fan 163 10  
 dust extractor 92 40; 172 1  
 dust filter 270 59  
 dust hood 133 20  
 dust jacket 185 37  
 dust pan 50 52; 260 60  
 dust removal fan 83 53  
 dust removal screen 83 56  
 dust-settling chamber 172 6  
 dust shield 2 48  
 Dutch clover 69 2  
 'duty free shop' 233 52  
 duty presentation officer 238 22  
 duvet, quilted ~ 43 8  
 dwale 379 7  
 dwarf 308 22  
 dwarf French bean 57 8  
 dwarf pine 372 21  
 dwelling 37  
 dwelling, lacustrine ~ 328 15  
 dye liquor padding trough 165 47  
 dye spray 100 35  
 dyke *see* dike  
 dynamo 187 8  
 dynastarter 209 13

## E

Eagle 3 9  
 eagle fern 377 16  
 eagle owl *Hunt.* 86 48, 51  
 eagle owl *Birds* 362 15  
 eagles 362 5-9  
 ear *Man* 16 18  
 ear *Arable Crops* 68 2  
 ear *Dog* 70 2  
 ear *Horse* 72 1  
 ear *Dom. Anim.* 73 11  
 ear *Game* 88 16, 32, 44, 61  
 ear *Music. Instr.* 326 32  
 ear *Birds* 362 16

ear, external ~ 17 56-58  
 ear, feathered ~ *Game* 88 78  
 ear, feathered ~ *Birds* 362 16  
 ear, internal ~ 17 62-64  
 ear, middle ~ 17 59-61  
 earcup 241 69; 261 40  
 earflap 35 31  
 ear lobe 17 57  
 earmuff 304 28  
 earphone *Hairst. etc.* 34 38  
 earphone *Audio* 241 69  
 earphone *Office* 248 35; 249 63  
 earphones 34 37  
 earphone socket *Cine Film* 117 10  
 earphone socket *Office* 249 68  
 ear piece *Forestry* 84 23  
 earpiece *Post* 237 8  
 earplug 354 30  
 earrings 36 13  
 earrings, drop ~ 36 11  
 earrings, pendant ~ 36 11  
 earth 4 8, 30  
 Earth 4 45  
 earth 6 17  
 earth, composted ~ 55 15  
 earth, excavated ~ 118 78  
 earth, prepared ~ 55 15  
 earth core 11 5  
 earthing button 237 21  
 earthing clamp 142 35  
 earth moth 80 42  
 earthquake 11 32-38  
 earthquake, submarine ~ 11 53  
 earthquake focus 11 32  
 earth station 237 51  
 earthworm 357 24  
 earthworm, artificial ~ 89 67  
 ear tuft 362 16  
 earwig 81 11  
 easel 116 35  
 easel, folding ~ 338 26  
 East Australian Current 14 38  
 Easter candle 330 44  
 Easter candlestick 330 45  
 easterlies 9 48, 49  
 Eastern cut-off 298 21  
 Eastern roll 298 15  
 east point 4 14  
 easy chair 336 18  
 eaves 38 11; 121 4; 122 36  
 eaves, rafter-supported ~ 37 9  
 eaves course 122 49, 76  
 eaves fascia 122 42  
 eaves joint 122 76  
 E-boat 258 69, 75  
 écarté 314 15  
 ECG 23 28  
 ECG amplitude 25 49  
 ECG analyser 25 45  
 ECG analysis 25 50  
 ECG impulse 25 46  
 ECG lead 25 43  
 ECG machine, portable ~ 23 46  
 ECG monitor 25 2, 21, 28, 47  
 ECG recorder 25 41  
 ECG recording unit 25 27

ECG rhythm 25 48  
 E-channel 143 7  
 echinoderm 369 3, 11, 17, 18, 19  
 echinoderms 357 38-39  
 Echinops 53 14  
 echinus 334 21  
 Echiostoma 369 13  
 echo 224 63  
 echo chamber 311 31  
 echo chamber loudspeaker 311 32  
 echo chamber microphone 311 33  
 echogram 224 67  
 echograph 224 24, 65  
 echo receiver 224 64  
 echo recorder 224 24  
 echo signal 224 63  
 echo sounder 224 61-67  
 echo sounding machine 224 61-67  
 echo sounding machine recorder 224 65  
 eclipse 4 33  
 eclipse, lunar ~ 4 29-35, 34-35  
 eclipse, solar ~ 4 29-35, 32, 39, 41  
 ecliptic 3 2; 4 22  
 economizer *Power Plant* 152 26  
 economizer *Railw.* 210 23  
 Edam cheese 99 42  
 edelweiss 378 9  
 edge *Tablew. etc.* 45 57  
 edge *Forestry* 85 2  
 edge *Winter Sp.* 302 21  
 edge *Maths.* 347 32  
 edge, aluminium ~ 301 51  
 edge, front ~ 122 88  
 edge, hidden ~ 151 24  
 edge, matching ~ 128 21  
 edge, non-matching ~ 128 22  
 edge, razor's ~ 106 40  
 edge, steel ~ 301 4, 50  
 edge, upper ~ 301 51  
 edge, visible ~ 151 23  
 edge board, lower ~ 118 74  
 edge board, upper ~ 118 73  
 edge mill 159 8  
 edge of platform 205 19  
 edge of pool 281 3  
 edge runner mill 159 8  
 edge sander 133 12  
 edge-sanding machine 133 12  
 edge-veneering machine 133 26  
 edging *Flower Gdn.* 51 15  
 edging *Optics.* 111 35  
 edging, concrete ~ 52 20  
 edging, hoop ~ 55 38  
 edging machine 111 24  
 editing 311 42-46  
 editing table 117 96; 311 42  
 editorial 342 48  
 EDP print-out 248 47  
 education, nursery ~ 48 1-20  
 education, pre-school ~ 48 1-20  
 eel 364 17

eel hook 89 87  
 effacé 314 13  
 efflux viscometer 129 38  
 E flat major 320 65  
 E flat minor 320 68  
 egg *Man* 20 84  
 egg *Poultry Farm* 74 58  
 egg *Bees* 77 26, 27  
 egg *Gdn. Pests* 80 15, 55  
 egg *Forest Pests* 82 19  
 egg *Supermkt.* 99 50  
 egg *Articulates* 358 49  
 egg and anchor cyma 334 42  
 egg and dart cyma 334 42  
 egg and tongue cyma 334 42  
 egg box 74 42, 45  
 egg collection 74 22, 34  
 egg collection system 74 34  
 egg-counting board 89 19  
 egg gallery 82 23  
 egg integument 74 59  
 egg-packing machine, fully automatic ~ 74 46  
 egg position 301 33  
 egg production 74 34-53  
 eggshell 74 59  
 egg timer 110 31  
 egg weigher 74 43  
 Egyptian 342 8  
 eight 283 10  
 eighth note 320 16  
 eighth rest 320 24  
 ejection seat 257 6, 7  
 ejector seat 257 6, 7  
 E-layer 7 27  
 elbow *Man* 16 45  
 elbow *Overh. Irrign.* 67 6  
 elbow *Horse* 72 20  
 elbow *Winter Sp.* 301 70  
 elbow boot 289 31  
 elbow coupling 126 40  
 elbow joint 126 51, 52  
 elbow pad 303 16  
 elbow screw joint 126 40, 45  
 elbow snips 125 2  
 elder 374 35  
 elderberry 374 37  
 elder flower 374 36  
 election 263 16-30  
 election meeting 263 1-15  
 election officer 263 17  
 election regulations 263 25  
 election speaker 263 5  
 election supervisor 263 28  
 elector 263 24  
 electoral register 263 18  
 electric action organ 326 36-52  
 electrical fitter 127 1  
 electrical point 261 12  
 electrical socket 261 12  
 electrical system bus 235 55  
 electric engine room 223 68  
 electrician 127 1  
 electricity cable 198 14, 19  
 electricity meter 127 32  
 electricity meter cupboard 127 31  
 electricity transmission line 15 113  
 electric light bulb 127 56



electric power plant 152 1-28  
 electrocardiogram monitor 25 2, 21, 28  
 electrocardiograph 23 28; 25 41  
 electrode *Hosp.* 25 26, 35, 38  
 electrode *Slaughterho.* 94 8  
 electrode *Arc Weld.* 142 10  
 electrode *Iron & Steel* 147 52  
 electrode, central ~ 2 3  
 electrode, platinum-iridium ~ 24 44  
 electrode, strap-on ~ 23 30  
 electrode arm 142 24  
 electrode case 142 7  
 electrode exit point 25 34  
 electrode holder 142 9, 20  
 electrode lead 25 25  
 electrode-pressure cylinder 142 26  
 electromagnet 237 47  
 electron 1 3, 17, 27, 32  
 electron, free ~ 1 25  
 electron beam 240 16  
 electron gun 113 31  
 electron gun assembly 240 24  
 electronic circuits 242 68-72  
 electronics, remote ~ 112 53  
 electronics cabinet 177 69  
 electron microscope 113 30  
 electron shell 1 6, 8  
 electron spin 1 4  
 electroplating bath 178 4  
 electroplating tank 178 4  
 electroplating vat 178 4  
 electrotome 22 38  
 electrotype, curved ~ 178 21  
 electrotyping 178  
 electrotyping plant 178 1-6  
 element, electronic ~ 242 69  
 element, fissionable ~ 1 49  
 element, front ~ 115 7  
 element, fusible ~ 127 36  
 element, oscillating ~ 110 9  
 element of set 348 2  
 elephant 366 20  
 elephant, toy ~ 47 6  
 elephant enclosure 356 9  
 elephant house 356 10  
 elevating conveyor 200 49  
 elevating drum, rotary ~ 64 74  
 elevating gear 255 67  
 elevating piston 255 51  
 elevation, front ~ 151 17  
 elevation, side ~ 151 18  
 elevator *Offshore Drill.* 146 8  
 elevator *Synth. Fibres* 170 36  
 elevator *Aircraft* 229 27; 230 63  
 elevator *Air Force* 257 22  
 elevator *Store* 271 45  
 elevator *Airports* 288 24  
 elevator *Theatre* 316 33, 34  
 elevator, chain and slat ~ 64 7  
 elevator, open-web ~ 64 69  
 elevator bridge 226 25  
 elevator car 271 46  
 elevator carrier 174 22  
 elevator controls 271 48  
 elevator operator 271 47

elevator shaft *Offshore Drill.* 146 20  
 elevator shaft *Store* 271 51  
 elevon section, movable ~ 235 33  
 elevon structure, heat-resistant ~ 235 34  
 elk 367 1, 2  
 ellipse 347 22  
 ellipse template 151 71  
 ellipsis 342 29  
 ellipsoid of revolution 347 42  
 elm tree 371 49  
 elytron 82 10; 358 36  
 E major 320 59  
 embankment *Map* 15 104  
 embankment *Refuse Coll.* 199 14  
 embankment *Rivers* 216 49  
 embossing platen 183 29  
 embrace 205 53  
 embrasure 329 18  
 embroidery 29 29; 30 42; 355 67  
 embryo *Arable Crops* 68 16  
 embryo *Bot.* 370 86  
 embryo *Trop. Plants* 382 21  
 embryo *South. Fruits* 384 22  
 embryo plant 68 14  
 embryo sac 370 64  
 emergency brake 214 3, 71  
 emergency brake valve 210 57  
 emergency cable 214 47  
 emergency-cable tensioning mechanism 214 48  
 emergency crash barrier 259 17  
 'emergency exit' *Airport* 233 41  
 emergency exit 307 33; 312 7  
 emergency flare stack 146 11  
 emergency lighting 312 6  
 emergency telephone 237 4  
 emery paper 135 25  
 eminence, frontal ~ 16 4  
 eminence, thenar ~ 19 75  
 E minor 320 56  
 emission control 190 73  
 Emmental cheese 99 41  
 empennage shapes 229 23-36  
 Empire table 336 16  
 empress, Byzantine ~ 355 15  
 emptying system, dust-free ~ 199 2  
 em rule 342 23  
 emu 359 1  
 emulsion 129 4  
 emulsion paint 129 4  
 emulsion paste 128 28  
 emulsion tube 192 10  
 enamel 19 30  
 enamelling 260 62  
 enamelling stove, electric ~ 260 63  
 enamel powder 260 65  
 enchasing hammer 108 41  
 enclosing wall 356 4  
 enclosure, outdoor ~ 356 1  
 enclosure wall 329 15  
 encyclopaedia 42 18; 262 17  
 end *Baskem.* 136 23

end *Mach. Parts etc.* 143 23  
 end, hipped ~ 122 10  
 end, partial-hipped ~ 121 17  
 end, round ~ 143 50  
 end, rounded ~ 143 20  
 end, west ~ 335 22  
 end frame, hemispherical ~ 235 48  
 end-grain block 340 1  
 endive 57 39  
 endive leaf 57 39  
 endleaf 185 49  
 end line 292 36  
 end mill 150 43  
 end moraine 12 55  
 endorsee 250 26  
 endorsement 250 25  
 endorser 250 27  
 endpaper 185 49  
 end pier 215 27  
 end plate 229 33  
 end rib, hemispherical ~ 235 48  
 end ring 89 52  
 end support 150 40  
 end switch 241 60  
 endurance competition 289 16  
 energy 1 55  
 energy, solar ~ 155 17-36  
 energy level 1 15, 27  
 energy sources 155  
 energy system 6 6, 8  
 engagement 294 46  
 engine *Moon L.* 6 30  
 engine *Oil, Petr.* 145 12  
 engine *Aircraft* 231 26  
 engine *Airports* 288 35  
 engine, air-cooled ~ 188 7; 189 3, 50  
 engine, auxiliary ~ *Ship* 223 71  
 engine, auxiliary ~ *Aircraft* 231 33  
 engine, eight-cylinder ~ 190 1  
 engine, four-cylinder ~ 189 50  
 engine, four-stroke ~ 189 3, 50  
 engine, main ~ *Railw.* 209 4  
 engine, main ~ *Ship* 221 81; 223 73  
 engine, rear ~ *Garage* 195 49  
 engine, rear ~ *Aircraft* 231 10  
 engine, side ~ 228 29  
 engine, single-cylinder ~ 188 26; 189 3  
 engine, twin-shaft ~ 232 51  
 engine, two-stroke ~ 188 7, 26; 242 55; 305 92  
 engine, water-cooled ~ 189 31, 39  
 engine and propeller room 227 22  
 engine and transmission control wheel 212 67  
 engine compartment 195 35  
 engine compartment structure 235 2  
 engine control system 235 39  
 engine driver 208 2

engineer 208 2  
 engineering workshop 222 8  
 engineer's brake valve 210 53; 211 22; 212 11  
 engine fairing, aerodynamic ~ 234 6  
 engine mount 234 21  
 engine mounting 190 38; 191 53; 226 58  
 engine oil 196 15  
 engine oil temperature gauge 212 19  
 engine order (telegraph) 224 25  
 engine pod 231 26; 256 25  
 engine room *Ship* 221 10  
 engine room *Fire Brig.* 270 1  
 engine room ventilator 212 37  
 engine superstructure 226 58  
 engine telegraph 224 25  
 English *Composing Rm.* 175 29  
 English *Billiards* 277 5  
 English daisy 376 1  
 English hand 342 10  
 English ryegrass 69 26  
 English setter 70 41  
 engraver 340 16  
 engraving 36 41  
 engraving ball 108 34  
 engraving machine 177 52  
 engraving system 177 66  
 enlarger 116 26  
 enlarger head 116 41  
 enlarging meter 116 53  
 enlarging photometer 116 53  
 ensign of head of state 253 14  
 ensign staff 223 31; 258 25  
 entablature 334 52  
 entire 370 43  
 entrance 77 48; 99 4; 208 10; 307 19  
 'entrance' *Airport* 233 36  
 entrance, bullfighters' ~ 319 10  
 entrance, main ~ 319 6  
 entrance, side ~ 331 15; 335 13  
 entrance and exit door 197 14  
 entrance hall 41 1-29  
 entrance tunnel 353 6  
 entrechat 314 22  
 entrepôt 225 7  
 entry/exit hatch 6 38  
 entry hatch 6 10; 235 26  
 epaulière 329 44  
 épée 294 25-33, 36  
 épée, electric ~ 294 26  
 épéeist 294 25  
 épée point 294 27  
 ephemerid 358 6  
 epicalyx 58 22  
 epicenter 11 33  
 epicentre 11 33  
 epididymis 20 73  
 epiglottis 17 51  
 epistyle 334 18  
 equalizer 311 19  
 equalizer, universal ~ 238 48  
 'equals' key 247 20  
 equals sign 344 23  
 equation, conditional ~ 345 9

equation, identical ~ 345 5  
 equation, simple ~ 345 4  
 equator 14 1  
 equator, celestial ~ 3 3  
 Equatorial Countercurrent 14 33  
 equestrian sport 289  
 equilibrist 307 48  
 equinoxes 3 6-7  
 equipment carrier 177 58  
 equipment locker 212 35  
 equipment section 239 1  
 equisetum 376 18  
 equitation 71 1-6  
 erase head 241 59; 243 20; 311 25  
 eraser 151 42  
 eraser, glass ~ 151 47  
 eraser, pencil-type ~ 151 41  
 erasing head 241 59; 243 20; 311 25  
 erasing knife 151 43  
 erasing knife blade 151 44  
 erasing shield 151 35  
 erasing table 249 26  
 erasion 26 52  
 erection shop 222 4  
 Ergates faber 358 38  
 ergometer, bicycle ~ 23 26  
 ergometry 23 26-31  
 ergot 68 4  
 Eridamus 3 12  
 Erlenmeyer flask 173 2; 350 39  
 ermine moth 80 5  
 erne 362 5  
 error indicator 244 7  
 eruption 7 21  
 escalator 271 22  
 escape wheel 110 40  
 escapologist 308 28  
 escarpment 13 57  
 escudo 252 23  
 Eskimo 353 1  
 Eskimo kayak 283 68  
 esophagus 17 49  
 espalier 37 33; 52 1, 2, 16, 17, 29  
 espalier, free-standing ~ 52 16  
 espalier fruit tree 52 1, 2, 16, 17, 29  
 esparto grass 136 26  
 espresso bar 265 1-26  
 esquire 329 68  
 estate 193 15  
 estate car 193 15  
 estoque 319 32  
 etchant 178 24; 182 16  
 etching 340 14-24  
 etching bath 178 31; 340 51  
 etching ground 340 55  
 etching machine *Electrotyp.* etc. 178 23  
 etching machine *Photograv.* 182 15  
 etching needle 340 16  
 etching solution 178 24; 182 16  
 etching tank 178 24, 31; 182 16  
 ethmoid 17 39

ethnology 352; 353; 354  
 ethylene molecule 242 61  
 Eurobottle 93 26  
 Europe 14 15  
 European silver fir 372 1  
 European Southern Observatory 5 1-16  
 European toad 364 23  
 Euscorpius flavicandus 358 40  
 evacuating pump, centrifugal ~ 67 11, 23  
 evaporating basin 350 29  
 evaporating dish 350 29  
 evaporator 155 6  
 evening dress 33 13  
 evening gown 30 53  
 evening sandal 101 27  
 evening suit 33 7  
 everlasting 377 3  
 ever-ready case 115 103  
 evolution 345 2  
 ewe 73 13; 75 10  
 examination couch 22 43; 23 4  
 examination table 27 1, 26  
 excavation *Bldg. Site* 118 69-82  
 excavation *Garage* 195 28  
 excavation side 118 72  
 excavator 118 76, 81; 200 1  
 excavator, large-scale ~ 159 3  
 excavator, toy ~ 273 65  
 excavator, universal ~ 158 13  
 excess water conduit 269 23  
 exchange *Post* 237 17, 22  
 exchange *Stock Exch.* 251 1-10  
 exchange broker 251 4  
 exchange floor 251 1  
 exchange golf ball 249 28  
 exchange hall 251 1  
 exchange rate 204 32  
 exchange typing element 249 28  
 excited state 1 19  
 exciter lamp 312 48  
 exclamation mark 342 21  
 exclamation point 342 21  
 exclusion principle 1 7  
 excretory vacuole 357 5  
 excursion steamer 221 101-128; 225 29  
 executive-secretary system 246 13  
 exercise book 47 24; 260 4, 18  
 exercises 296 48-60  
 exergue 252 10  
 exhaust *Agr. Mach.* 64 38  
 exhaust *Railw.* 209 12, 22  
 exhaust, upswept ~ 188 15; 189 15  
 exhaust bubbles 279 26  
 exhaust casing 212 69  
 exhaust escape flue 258 79  
 exhaust fan *Brew.* 92 15  
 exhaust fan *Joiner* 133 33  
 exhaust gas 160 4  
 exhaust gas stack 154 37  
 exhaust manifold 190 36, 73  
 exhaust mast 221 17



exhaust muffler 212 42, 48  
 exhaust outlet 259 92  
 exhaust pipe *Photograv.* 182 25  
 exhaust pipe *Car* 191 51  
 exhaust pipe *Ship* 221 76  
 exhaust pipe *Warships* 258 44  
 exhaust pipe, four-pipe ~ 189 51  
 exhaust port 242 58  
 exhaust repair 195 52  
 exhaust silencer 212 42, 48  
 exhaust system 195 51  
 exhaust valve 190 46; 242 53  
 'exit' *Airport* 233 37  
 exit 307 19  
 exit, emergency ~ 99 79  
 exit gate 319 12  
 ex libris 185 51  
 exosphere 7 31  
 exotic 306 30  
 expansion line 1 61  
 expansion tank 38 24  
 experimental apparatus 261 11  
 explosion, atomic ~ 7 11  
 exponent 345 1  
 exposing lamp 182 3  
 exposure bath 228 21  
 exposure control device 176 9  
 exposure control switch 117 17  
 exposure counter 115 17  
 exposure meter 114 29  
 exposure meter, hand-held ~ 114 56  
 exposure meter control step 117 37  
 exposure meter needle 115 57  
 exposure system 249 42  
 exposure time balancing knob 116 39  
 exposure timer 116 24; 179 18  
 expression marks 321 27-41  
 express locomotive 205 35  
 express train car 207 1-21  
 express train carriage 207 1-21  
 express train coach 207 1-21  
 express train compartment 207 43  
 extension *Joiner* 133 13  
 extension *Post* 237 17, 19, 21, 22-26, 26  
 extension arm 132 63  
 extension bar 151 57  
 extension bellows 115 85  
 extension cord 127 10  
 extension ladder 270 14  
 extension lead 127 10  
 extension plug 127 11  
 extension socket 127 12  
 extension tube *Household* 50 70  
 extension tube *Photog.* 115 81  
 extensor, common ~ 18 57, 63  
 extensor, radial ~ 18 56  
 extensor carpi radialis longus 18 56

extensor communis digitorum 18 57, 63  
 extinguisher, mobile ~ 270 63  
 extra 310 29; 316 39  
 extra bold 175 9  
 extracting a root 345 2  
 extraction fan 199 32  
 extraction forceps 24 47  
 extraction of phenol 170 3  
 extraction vent 49 20  
 extractor 170 37  
 extractor duct, movable ~ 142 15  
 extractor fan 133 33  
 extractor grid 100 13  
 extractor support 142 16  
 extrados 336 26  
 extremity, fimbriated ~ 20 82  
 extrusion press 159 11; 161 7  
 eye *Man* 16 7; 19 38-51  
 eye *Horse* 72 4  
 eye *Dom. Anim.* 73 32  
 eye *Game* 88 15, 33, 43, 60  
 eye *Fish Farm* 89 82  
 eye *Mills* 91 19  
 eye *Blacksm.* 137 29  
 eye *Weaving* 166 28, 29  
 eye *Art* 334 75  
 eye, compound ~ *Bees* 77 20-24  
 eye, compound ~ *Articulates* 358 7  
 eye, simple ~ 77 2  
 eye, stalked ~ 357 30  
 eyeball 19 45  
 eye-bright 61 27  
 eyebrow *Man* 19 38  
 eyebrow *Roof* 121 23  
 eyecup 115 73; 117 14; 313 34  
 eyeground 22 32  
 eyelash 19 41  
 eyelet *Shoem.* 100 63  
 eyelet *Glaz.* 124 23  
 eyelet *Weaving* 166 28  
 eyelet, hook, and press-stud setter 100 53  
 eyelet embroidery 102 11  
 eyelid, lower ~ 19 40  
 eyelid, upper ~ 19 39  
 eye muscles 19 44  
 eyepiece 113 20; 115 42; 117 14; 311 9  
 eyepiece, binocular ~ 23 6  
 eyepiece control ring 313 7  
 eyepiece focusing knob 112 56  
 eyespot 358 54

## F

fabled beings 327  
 fabric *Bldg. Site* 118 1-49  
 fabric *Knitting* 167 29, 48  
 fabric *Text. Finish.* 168 39, 51, 64  
 fabric *Weaves* 171 29  
 fabric *Store* 271 59  
 fabric, air-dry ~ 168 22  
 fabric, metallic ~ 270 46  
 fabric, non-woven ~ 103 27

fabric, printed ~ 168 57  
 fabric, raised ~ 168 36  
 fabric, shrink-resistant ~ 168 26  
 fabric, tubular ~ 167 1, 9  
 fabric, woollen ~ *Dressm.* 103 27  
 fabric, woollen ~ *Text. Finish.* 168 1  
 fabric, woven ~ 166 12  
 fabric box 167 10  
 fabric container 167 10  
 fabric department 271 58  
 fabric drum 167 10  
 fabric-finishing machine, decatizing ~ 168 49  
 fabric for upholstery 134 60  
 fabric guide roller 168 5  
 fabric-plaiting device 168 30  
 fabric-raising machine 168 31  
 fabric roll 167 29  
 fabric roller 166 20  
 fabric shaft 171 21, 23  
 fabric wallhanging 128 18  
 fabulous creatures 327  
 façade, west ~ 335 22  
 face *Man* 16 4-17  
 face *Horse* 72 5  
 face *Clocks* 110 25  
 face *Blacksm.* 137 28  
 face *Composing Rm.* 174 31; 175 42  
 face *Art* 336 24  
 face, metal ~ 303 11  
 face compress 106 25  
 face guard 292 11, 25  
 face mask *Fire Brig.* 270 40  
 face mask *Swim.* 279 10  
 face mask filter 270 57  
 face par 251 12  
 face pipes 326 1-3  
 facet 77 20  
 face urn 328 38  
 face vault 297 30  
 facing 24 32  
 facing, decorative ~ 30 47  
 facsimile signature 252 34  
 facsimile telegraph 245 1  
 factor 344 25  
 factory number 187 51  
 factory ship *Sea Fish.* 90 11  
 factory ship *Ship* 221 86  
 fahlerz 351 1  
 fahl ore 351 1  
 fair 308  
 fair, annual ~ 308 1-69  
 fairground 308 1  
 fairing 189 43  
 fairing, integrated ~ 189 44  
 fairing, metal ~ 188 50  
 fairlead 284 29  
 fairway 216 21  
 fairway, main ~ 224 92  
 fairway, secondary ~ 224 93  
 fairway markings 224 84-102  
 fairway marks 224 68-83  
 fair-weather cumulus 8 1  
 fairy-tale figure 306 65  
 falcon 86 46  
 falconer 86 42

falconry 86 42-46  
 falcons 362 1-4  
 fall 221 106  
 falling wedge 85 4  
 fallow 63 1  
 fallow buck 88 40  
 fallow deer 88 40-41  
 falls 11 45  
 falls, artificial ~ 272 9  
 false acacia 371 70  
 false oat 69 22  
 family grave 331 27  
 family tomb 331 27  
 fan *Roof & Boilerr.* 38 58  
 fan *Agr. Mach.* 64 15; 65 52  
 fan *Pest Contr.* 83 49  
 fan *Game* 88 75  
 fan *Energy Sources* 155 14  
 fan *Weaving* 165 23  
 fan *Intern. Combust. Eng.* 190 7  
 fan *Refuse Coll.* 199 35, 46  
 fan *Aircraft* 232 34, 43  
 fan *Ethnol.* 353 42  
 fan, low-pressure ~ 199 33  
 fan blower 179 22  
 fan clutch 190 8  
 fancy appliqué 35 7  
 fancy dress 306 6-48, 32  
 fancy-dress ball 306 1-48  
 fan drift 144 22  
 fan drive, hydrostatic ~ 212 62  
 fan fold sheet, continuous ~ 248 47  
 fan 19 36  
 fan-jet turbine 232 38  
 fanlight 37 35  
 fan nozzle 83 4  
 fan tail 73 29  
 fan vault 336 46  
 faradization unit 23 37  
 farm 15 101  
 farm buildings 62  
 farmer 62 6  
 farmhand 63 5  
 farming 63  
 farm labourer 63 5  
 farmland 63 17  
 farm produce 68 1-47  
 farm road 63 18  
 farmstead 62  
 farm track 63 18  
 farm vehicle engineering 138  
 farmworker 63 5  
 farmyard 62 31  
 farmyard hedge 62 35  
 farmyard manure 63 15  
 farrowing and store pen 75 40  
 farrowing rails 75 43  
 fascia panel 191 57-90  
 fascine 216 53  
 fashion catalogue 104 6  
 fashion doll 47 9; 48 32  
 fashion house 268 9  
 fashion journal 104 4; 271 36  
 fashion magazine 104 4; 271 36  
 fast and slow motion switch 117 87  
 fastback 193 29

fast breeder 154 1  
 fast-breeder reactor 154 1  
 fastening *Plant Propagn.* 54 13  
 fastening *Station* 206 12  
 fat end 95 53  
 fat lady 308 21  
 fattening pond 89 6  
 faucet *Kitch.* 39 36  
 faucet *Plumb. etc.* 126 34  
 faucet *Electrotyp. etc.* 178 34  
 faucet *Chem.* 349 5, 22  
 faucet, outside ~ 37 41  
 fault *Phys. Geog.* 12 4  
 fault *Coal* 144 51  
 fault, distributive ~ 12 8  
 fault, multiple ~ 12 8  
 fault, normal ~ 12 7  
 fault-block mountain 12 4-11  
 faulting 12 4-20  
 fault line 12 5  
 fault repair service 237 27  
 faults, complex ~ 12 8-11  
 fault throw 12 6  
 fault trace 12 5  
 faustball 293 72-78, 74  
 favorite 289 52  
 favourite 289 52  
 fawn 88 39  
 fawn, female ~ 88 34  
 F-clef 320 9  
 F-contact 115 14  
 feather *Headgear* 35 6, 12  
 feather *Dom. Anim.* 73 31  
 feather *Mach. Parts etc.* 143 73  
 feather *Chivalry* 329 78  
 feather, falcate ~ 88 68  
 feather, peacock's ~ 254 36  
 feather star 369 3  
 feed *Iron & Steel* 147 51  
 feed *Mach. Tools* 149 9  
 feed adjustment 100 28  
 feed board 180 32, 49, 67; 181 4, 21, 30; 185 9  
 feed chain 172 67  
 feed chain drive 172 69  
 feed channel 157 55  
 feed conveyor 236 33  
 feed conveyor, endless-chain ~ 74 25  
 feed dispenser 74 13  
 feed drum 180 33, 34  
 feeder *Agr. Mach.* 64 72  
 feeder *Poultry Farm* 74 49-51  
 feeder *Brickwks.* 159 7  
 feeder *Offset Print.* 180 31, 48, 68, 74  
 feeder *Letterpress* 181 22, 24  
 feeder *Bookbind.* 185 25  
 feeder, automatic ~ 181 5  
 feeder, mechanical ~ 74 13, 23  
 feeder broom 199 44  
 feeder mechanism 181 22  
 feeder panel 153 4  
 feeder-selecting device 167 40  
 feeder skip 118 35  
 feed gearbox 149 8  
 feed gear lever 149 10  
 feed guide 184 23

feed hopper *Poultry Farm* 74 24  
 feed hopper *Bookbind.* 185 26  
 feed-in 173 13  
 feed indicator 157 9  
 feeding, mechanical ~ 74 23-27  
 feeding apparatus 181 22  
 feeding bottle 28 19  
 feeding bowl 70 32  
 feeding-in 164 15  
 feeding passage 75 3  
 feeding place 86 28  
 feeding site 80 50  
 feeding trough *Poultry Farm* 74 21  
 feeding trough *Livestock* 75 37  
 feeding trough, adjustable ~ 74 4  
 feed mechanism *Agr. Mach.* 65 78  
 feed mechanism *Mach. Tools* 149 18  
 feed mechanism *Post* 236 48  
 feed mechanism *Graphic Art* 340 33  
 feed motor 177 43  
 feed pawl 157 44  
 feed pipe 96 50  
 feed pump *Nucl. Energy* 154 13  
 feed pump *Railw.* 210 9  
 feed roll 85 19  
 feed roller 85 24; 157 4, 40  
 feed roller, fluted ~ 163 52  
 feed runner 147 22  
 feed screw 149 15  
 feed setting 100 28  
 feed shaft 149 33  
 feed spindle 312 36  
 feed spool 117 31  
 feed sprocket 312 26  
 feed supply pipe 74 15  
 feed table *Sawmill* 157 63  
 feed table *Offset Print.* 180 32, 49, 67  
 feed table *Letterpress* 181 4, 21, 30  
 feed table *Bookbind.* 184 12, 21; 185 9, 34  
 feed-through insulator 153 12, 35  
 feed-through terminal 153 12, 35  
 feed trip 149 18  
 feed tripping device 149 18  
 feed valve 210 20  
 feedwater heater 210 23  
 feedwater line 154 12, 30  
 feedwater preheater 210 23  
 feedwater steam circuit 154 45  
 feedwater tank 152 17  
 feedwater tray, top ~ 210 29  
 feeler *Agr. Mach.* 64 86  
 feeler *Forest Pests* 82 3  
 feeler *Weaving* 166 32  
 feeler *Invertebr.* 357 31  
 feeler *Articulates* 358 27, 53  
 feeler, maxillary ~ 358 42



feeler gauge 140 53  
 feeler support wheel 64 88  
 feet-first jump 282 13  
 felines 368 2-8  
 feller 84 20  
 felling 84 27  
 felling wedge 84 4, 30  
 felling wedge, hydraulic ~ 84 25  
 felt 173 51  
 felt, dry ~ 173 23  
 felt nail 122 96  
 felt pen 48 18  
 felt tip pen 247 11; 260 19  
 female, winged ~ 358 21  
 femur 17 22  
 fence *Joiner* 132 65  
 fence *Refuse Coll.* 199 13  
 fence *Aircraft* 231 8  
 fence *Swim.* 281 17  
 fence *Equest.* 289 8  
 fence, electrified ~ 62 46  
 fence, paling ~ 52 10  
 fence, protective ~ 84 7  
 fence, stone ~ 337 23  
 fence, timber ~ 118 44  
 fence, wicker ~ 216 54  
 fence, wire ~ 15 39  
 fence, wire netting ~ 84 7  
 fence, wooden ~ 37 53  
 fence adjustment handle 132 66  
 fence rack 63 28  
 fencers 294 5-6  
 fencer's salute 294 18  
 fencing 294  
 fencing, modern ~ 294 1-33  
 fencing glove 294 12  
 fencing instructor 294 1  
 fencing jacket 294 16  
 fencing mask 294 13, 14  
 fencing master 294 1  
 fencing measure 294 10  
 fencing movement 294 7  
 fencing shoe, heelless ~ 294 17  
 fencing weapons 294 34-45  
 fender *Horse* 71 40  
 fender *Tram* 197 12  
 fender *Hydr. Eng.* 217 9  
 fender *Docks* 225 12  
 fender, front ~ *Bicycle* 187 13  
 fender, front ~ *Car* 191 3; 191 3, 13  
 fender, integral ~ 193 33  
 fender, wooden ~ 218 26  
 fender pile *Hydr. Eng.* 217 9  
 fender pile *Shipbuild.* 222 35  
 F-1 engine 234 4  
 fennel 380 6  
 fen peat 13 17  
 fermentation room 97 72  
 fermentation thermometer 93 9  
 fermentation trolley 97 73  
 fermentation vessel 93 8  
 fermenter 93 8  
 fermenting cellar 93 7  
 fern 377 16  
 ferret 86 24  
 ferreter 86 25

ferreting 86 23  
 ferris 221  
 Ferris wheel 308 37  
 ferroconcrete construction 119 1-89  
 ferrule 45 53  
 ferry, flying ~ 216 10  
 ferryboat 216 11, 15; 225 11  
 ferry cable 216 2  
 ferry landing stage 216 7  
 ferryman 216 17  
 ferry rope 216 2  
 fertilizer, artificial ~ 63 14  
 fertilizer, chemical ~ 63 14  
 fertilizer, lime ~ 63 14  
 fertilizer, nitrogen ~ 63 14  
 fertilizer, phosphoric acid ~ 63 14  
 fertilizer, potash ~ 63 14  
 fertilizer spreader 62 21  
 fescue 69 24  
 festoon *Carnival* 306 5  
 festoon *Art* 335 54  
 festoon lamp 318 26  
 festoon lighting 318 25  
 fetish 354 43  
 fetlock 72 24  
 fettle 148 43  
 fettling shop 148 38-45  
 feuilleton 342 67  
 F-hole 323 6  
 fiber see fibre  
 fibre 77 23  
 fibre, glass ~ 151 48  
 fibre, loose ~ 168 43  
 fibreboard 338 24  
 fibula 17 24  
 fibula, serpentine ~ 328 28  
 fibula, spiral ~ 328 30  
 fibula, two-piece ~ 328 30  
 fiddle string 323 9  
 field *Agr.* 63 4, 17  
 field *Equest.* 289 41, 51  
 field *Ball Games* 291 1; 292 40-58  
 field, fallow ~ 63 1  
 field bean 69 15  
 field bindweed 61 26  
 field camomile 61 8  
 field chopper, self-propelled ~ 64 34-39  
 fielder 292 76  
 field eryngo 61 32  
 field glasses 86 6  
 field guard 63 13  
 field illumination 112 33  
 fielding side 292 73  
 field lens 115 40  
 field mangel 69 21  
 field marigold 61 7  
 field mushroom 381 1  
 field pests 80 37-55  
 field player 292 2  
 field poppy 61 2  
 field sprinkler 67 32  
 fig 383 35; 384 11, 13  
 fighter-bomber 256 1, 29  
 fighting bull 319 28  
 fighting ships 258 64-91  
 fighting ships, modern ~ 259  
 figure, clay ~ 48 13; 339 7

figure, plasticine ~ 48 13  
 figure, symbolic ~ 327 20  
 figure, symmetrical ~ 346 24  
 figure, wax ~ 308 69  
 figurehead 218 16  
 figures, compulsory ~ 302 11-19  
 figure ski 286 56  
 figurine, clay ~ 328 20  
 filament 169 17, 22; 170 44  
 filament, continuous ~ 169 1-34  
 filament, solid ~ 169 15  
 filament lamp 127 56  
 filament tow 169 28, 30  
 file *Doc.* 22 12, 26  
 file *Metabwkr.* 140 16  
 file *Office* 245 6; 247 37; 248 5  
 file, flat ~ 108 49; 140 27  
 file, half-round ~ 140 29  
 file, rough ~ 140 8  
 file, round ~ 108 47; 140 29  
 file, smooth ~ 140 8  
 file handle 108 50  
 filet 102 22  
 file tab 248 4  
 filigree work 102 30  
 filing cabinet 245 4  
 filing clerk 248 6  
 filing drawer 248 2, 23  
 filing machine 140 15  
 filing shelf 248 10  
 fill, sanitary ~ 199 10  
 filler *Tobacc. etc.* 107 7  
 filler *Paperhanger* 128 3  
 filler *Power Plant* 153 38  
 filler *Films* 310 52  
 filler hoist 200 51  
 filler hole 213 19  
 filler light 310 52  
 filler opening 200 52  
 filler rod 141 12  
 fillet *Meat* 95 13  
 fillet *Carp.* 120 45  
 fillet *Floor etc. Constr.* 123 57, 67  
 fillet *Bookbind.* 183 3  
 fillet, tilting ~ 121 31  
 fillet gauge 142 36  
 filleting knife 89 38  
 fillet of beef 95 24  
 fillet of pork 95 44  
 filling *Dent.* 24 30  
 filling *Tablew. etc.* 45 38  
 filling *Hydr. Eng.* 217 7  
 filling *Water* 269 29  
 filling compound 153 38  
 filling end 162 2  
 filling inlet 50 12  
 filling knife 128 35  
 filling machine 76 21, 26  
 filling material 24 51  
 filling station 196 1-29  
 fill-in light 310 52  
 fill light 310 52  
 film *Atom* 2 10, 13  
 film *Photog.* 114 9  
 film *Composing Rm.* 176 25  
 film, cine ~ 117  
 film, exposed ~ 117 42

film, unexposed ~ 117 41  
 film actor 310 28  
 film actress 310 27  
 film advance 114 32  
 film advance lever, single-stroke ~ 115 16  
 film agitator, automatic ~ 116 19  
 film and sound cutting table 117 96  
 film and tape synchronizing head 117 102  
 film back 115 80  
 film break detector 312 30  
 film camera 27 20  
 film camera, soundproof ~ 310 47; 313 15  
 film cameras 313 1-39  
 film cassette 112 65  
 film cassette, miniature ~ 114 7  
 film cassette, universal ~ 242 44  
 film cement 312 22  
 film clip 116 14  
 film copier, automatic ~ 176 28  
 film-developing machine 311 30  
 film director 310 40  
 film dosimeter 2 8  
 film drier 116 23  
 film editor 311 43  
 film extra 310 29  
 film feed spool 117 79  
 film former 178 24  
 film gate 117 30; 312 34  
 film gate opening 117 40  
 filmgoer 312 5  
 filming 310 14-60, 26-60  
 filming, exterior ~ 310 18  
 filming, outdoor ~ 310 18  
 filming agent 178 24  
 filming speed selector 117 12  
 film laboratory 310 2, 30  
 film library 310 5  
 film magazine 113 40  
 film marker 117 95  
 film matrix case 176 17  
 film of fluorescent material 240 19  
 film orchestra 310 17  
 film path 312 31  
 film perforator 117 95; 242 10  
 film poster 268 57  
 film-processing machine 311 30  
 film processor, automatic ~ 177 72  
 film projection 312 1-23  
 film projector 311 22; 312 24  
 film projectors 312 24-52  
 film reel 311 24; 312 32  
 film-ring dosimeter 2 11  
 films 310; 311; 312; 313  
 filmstrip 310 45  
 film set 310 7  
 filmsetter 176 7  
 filmsetting 176  
 film speed setting 117 18

film spool 114 8; 311 24; 312 32  
 film spool holder 238 6  
 film star 310 27, 28  
 film storage vault 310 5  
 film studios 310 1-13  
 film title 310 35  
 film transport 114 32  
 film transport handle 116 7  
 film transport mechanism 311 26  
 film turntable 117 99; 311 44  
 film viewer 117 91; 242 8  
 film wind 114 32  
 film window 114 18; 115 28, 34  
 filter *Atom* 2 9, 12, 14  
 filter *Weaving* 165 14  
 filter *Synth. Fibres* 170 32  
 filter *Papern.* 172 20  
 filter *Water* 269 62  
 filter *Chem.* 349 12  
 filter, fluted ~ 350 41  
 filter adjustment 116 43, 44, 45  
 filter bed 269 10  
 filter bottom 269 11  
 filter cake 161 13  
 filter change, automatic ~ 316 49  
 filtered water outlet 269 12  
 filter flask 350 40  
 filter funnel 349 11  
 filter gravel 269 10  
 filter lens 142 40  
 filter mount 115 6  
 filter pick-up 112 57  
 filter plate 349 12  
 filter press *Porcelain Manuf.* 161 12  
 filter press *Synth. Fibres* 169 12  
 filter screen 116 22  
 fimbria 20 82  
 fin *Swim.* 279 18  
 fin *Bathing* 280 41  
 fin *Motorboats etc.* 286 43  
 fire alarm siren 270 4  
 fire alarm ~ 364 8  
 fin, anal ~ 364 9  
 fin, caudal ~ 364 10  
 fin, dorsal ~ *Fish etc.* 364 6  
 fin, dorsal ~ *Mammals* 367 27  
 fin, fixed ~ 286 61  
 fin, pectoral ~ 364 7  
 fin, pelvic ~ 364 8  
 fin, ventral ~ 364 8  
 fin, vertical ~ *Aircraft* 229 24; 230 59; 231 6; 232 7  
 fin, vertical ~ *Space* 235 1  
 fin, vertical ~ *Air Force* 256 32  
 fin, vertical ~ *Airsports* 288 21  
 final image tube 113 39  
 final picture quality checking room 238 60-65  
 finch 360 1  
 finches 361 6-8  
 finds, prehistoric ~ 328 1-40  
 fine cut 107 25  
 fine focusing indicator 224 36  
 finger, fifth ~ 19 68  
 finger, fourth ~ 19 67

finger, little ~ 19 68  
 finger, middle ~ 19 66  
 finger, pivoted ~ 74 36  
 finger, second ~ 19 65  
 finger, third ~ 19 66  
 fingerboard 323 21; 324 8  
 finger guard 83 20; 85 15  
 finger hole *Office* 247 39  
 finger hole *Sports* 305 16  
 fingerhole *Music. Instr.* 323 33; 324 34  
 finger hook 324 67  
 fingernail 19 80  
 finger pad 19 78  
 finger paint 260 26  
 finger painting 260 26  
 finger plate 237 11  
 fingerprint 264 29  
 fingerprint identification 264 28  
 finger roll 97 15  
 finger stop 237 12  
 fingertip 19 79  
 finial 335 37  
 fining bath 162 4  
 fining lap 111 37, 38  
 finish 286 28  
 finish, gloss ~ 128 32  
 finished malt collecting hopper 92 20  
 finishing 168 1-65; 170 57  
 finishing bur 24 38  
 finishing layer 123 40  
 finishing line 282 28; 286 30  
 finishing machine 100 3  
 finishing of textile fabrics 168  
 finishing press 183 4  
 finishing train 148 71  
 Finn 284 51  
 Finn dinghy 284 51  
 fin post 235 3  
 fipple flute 322 7  
 fir cone 372 2  
 fire, blacksmith's ~ 137 1-8; 138 34  
 fire, open ~ 267 25  
 fire alarm 270 4  
 fire alarm siren 270 4  
 fire appliance building 233 8  
 fire-arm 87 2  
 fireboat 270 65  
 firebox 210 4  
 fire control radar antenna 258 51  
 fire control system 255 74  
 firecrest 361 10  
 fire curtain 316 24  
 fire department 270  
 fire door handle handgrip 210 63  
 fire eater 308 25  
 fire engine 270 5  
 fire extinguisher 196 9  
 fire extinguisher, portable ~ 270 61  
 fire extinguisher, wheeled ~ 270 63  
 firefighter 270 37  
 fire-fighting equipment 227 25; 228 20  
 fire gable 121 9



fire gun 221 4  
 fire hat 270 38  
 firehole door 210 61  
 firehole shield 210 60  
 fireman 270 37  
 fire nozzle 221 4  
 fireplace 267 23  
 fire plug 270 35  
 fire prevention 316 6  
 fire protection 316 6  
 fire salamander 364 22  
 fire service 270  
 fire service drill 270 1-46  
 fireside 267 22  
 fire siren 270 4  
 fire station 270 1-3  
 fire tube 210 17  
 firewood basket 309 10  
 fireworks 306 49-54  
 firing mechanism 255 29  
 firing mould 161 4  
 firing pin 87 21  
 firing position 305 73  
 firing process 161 2  
 firing sequence insert 195 13  
 firing trigger 87 11  
 firmer chisel 134 30  
 firm basin 12 48  
 fir needle 372 11  
 firm field 12 48  
 firm slope 300 14  
 first aid 21  
 first aid dressing 21 5  
 first aid kit 21 4  
 first aid post 308 61  
 first aid station 204 44  
 first aid tent 308 61  
 first base 292 46  
 first-class section 207 17  
 first floor 37 2; 118 7  
 first-floor landing 123 23  
 first position 294 18  
 Fish *Astron.* 4 64  
 fish *Grocer* 98 19  
 fish *Fish etc.* 364  
 fish, canned ~ 96 28  
 fish, female ~ 89 13  
 fish basket 89 25  
 fishbolt 202 13  
 fishbone stitch 102 7  
 fish-canning factory 225 59  
 fish culture 89 1-19  
 fish dish 266 53  
 fish dock 225 56  
 fish egg 89 12  
 fishes 364 1-18  
 fisheye 115 44  
 fish farming 89 1-19  
 fish fork 45 8, 65  
 fish hook 89 79  
 fishing 89 26  
 fishing boat 89 27; 90 24  
 fishing line 89 63  
 fishing lugger 90 1  
 fishing pliers 89 37  
 fishing tackle 89 37-94  
 fishing tackle, suspended ~ 90 29  
 fish knife *Tablew. etc.* 45 8, 64  
 fish knife *Fish Farm.* 89 39  
 fish ladder 89 93

fish lance 280 40  
 fish market 225 57  
 fish pass 89 93  
 fishplate 202 12  
 fishpole antenna 258 60  
 fish spawn 89 12  
 fish spear 280 40  
 fishtail bit 145 21  
 fish way 89 93  
 fission 1 43, 46  
 fission, nuclear ~ 1 34  
 fission fragment 1 44, 47, 51  
 fission fragments 1 37-38  
 fissure 11 52  
 fissure, diagonal ~ 300 3  
 fissure, horizontal ~ 300 3  
 fissure, vertical ~ 300 3  
 fissure bur 24 39  
 fist 16 48  
 fist hatchet 328 1  
 fitch 129 19  
 fitter 140 1  
 fitting booth 271 32  
 fitting of the frame 111 10  
 fitting-out quay 222 5-9  
 fittings 126 38-52  
 five-four time 320 41  
 fix 224 45  
 flag *Flags* 253 7-11  
 flag *Town* 268 44  
 flag *Ball Games* 293 86  
 flag, club's ~ 283 25  
 flag, linesman's ~ 291 60  
 flag, Olympic ~ 253 5  
 flag, swallow-tailed ~ 253 22  
 flag at half-mast 253 6  
 flag at half-staff 253 6  
 flag dressing 221 85  
 flag of the Council of Europe 253 4  
 flag of the United Nations 253 1-3  
 flagpole 253 1, 7; 273 61  
 flags 253  
 flags, national ~ 253 15-21  
 flags, triangular ~ 253 30-32  
 flagstaff 253 1, 7; 258 4; 259 87; 273 61  
 flagstick 293 88  
 flagstone 51 17  
 flail rotor 64 73  
 flame regulator 107 31  
 flamingo 272 53  
 flan 252 43  
 flancard 329 86  
 flan case 97 47  
 flanchard 329 86  
 flange *Cooper* 130 28  
 flange *Mach. Parts etc.* 143 2, 5  
 flange *Electrotyp. etc.* 178 44  
 flange *Hydr. Eng.* 217 67  
 flange, bottom ~ 215 10  
 flange, top ~ 215 9  
 flange mount 130 20  
 flanging, swaging, and wiring machine 125 25  
 flank *Man* 16 32  
 flank *Game* 88 26  
 flank *Meat* 95 2, 15-16  
 flank *Bldg. Site* 119 6  
 flank, thick ~ 95 15, 36

flank, thin ~ 95 16  
 flank vault 297 31  
 flans 97 22-24  
 flap *Child. Clothes* 29 35  
 flap *Horse* 71 40, 47  
 flap *Aircraft* 229 37  
 flap, double-slotted ~ 229 48  
 flap, extending ~ 229 51  
 flap, fur ~ 35 32  
 flap, normal ~ 229 46  
 flap, outer ~ 259 78  
 flap, slotted ~ 229 47  
 flap, split ~ 229 49  
 flap extension 78 19  
 flaps, plain ~ 229 46-48  
 flaps, simple ~ 229 46-48  
 flaps, split ~ 229 49-50  
 flap valve 192 63  
 flare, pork ~ 95 45  
 flash, battery-portable ~ 114 65  
 flash, electronic ~ 114 65, 68; 309 40-41  
 flash, single-unit ~ 114 68  
 flash bar 114 75  
 flash bulb 309 39  
 flash contact 114 30  
 flash cube 114 74  
 flash cube contact 114 13  
 flash cube unit 114 73  
 flash eliminator 255 18  
 flashgun 114 68; 309 38  
 flashgun, electronic ~ 309 40-41  
 flash head 114 67; 309 40  
 flash hider 255 18  
 flash lamp *Photomech. Reprod.* 177 37  
 flash lamp *Inf. Tech.* 242 43  
 flashlight *Electr.* 127 26  
 flashlight *Fire Brig.* 270 6  
 flashlight, underwater ~ 279 25  
 flash socket 115 14  
 flash switch 114 33  
 flash tube 176 26  
 flask, collared ~ 328 12  
 flask, conical ~ 350 39  
 flask, flat-bottomed ~ 350 36  
 flask, long-necked ~ 350 38  
 flask, round-bottomed ~ 350 38  
 flask, three-necked ~ 350 55  
 flask, volumetric ~ 173 3  
 flat *Dwellings* 37 64-68, 69-71  
 flat *Flat* 46  
 flat *Music. Not.* 320 52  
 flat-bed cylinder press, two-revolution ~ 181 1  
 flat-bed knitting machine 167 35  
 flat-bed offset machine 180 75  
 flat-bed offset press 180 75  
 flatcar 206 24; 213 5, 11, 40  
 flat clearer 163 44  
 flat four engine 230 34  
 flat glass production 162 1-20  
 flat plate keel 222 49  
 flats *Cotton Spin.* 163 45, 46  
 flats *Navig.* 224 87, 97

flatter 137 35  
 flatworm 81 35  
 flauto piccolo 323 30  
 flavourings 382  
 flax 383 6  
 flay brush 129 21  
 flaying knife 94 13  
 flea 81 42  
 flea beetle 80 39  
 flea market 309  
 fleet of lorries 206 25  
 fleet submarine, nuclear-powered ~ 259 54  
 flesh *Soft Fruit* 58 24, 35, 58  
 flesh *Drapes & Nuts* 59 6  
 fletching 305 62  
 fleur-de-lis 254 13  
 flews 70 26  
 flex 50 66, 77  
 flex hook 50 65  
 flexor, radial ~ 18 40  
 flexor, ulnar ~ 18 58  
 flexor carpi radialis 18 40  
 flexor carpi ulnaris 18 58  
 flies 316 1-60  
 flight, negative ~ 288 9  
 flight board 77 49  
 flight deck *Space* 235 16  
 flight deck *Warships* 259 2, 12  
 flight instrument 288 68  
 flight of wild ducks 86 41  
 flight refuelling probe 256 7  
 flik-flak 297 24  
 flint 107 28  
 flint corn 68 31  
 flintlock 353 28  
 flint maize 68 31  
 flip-over numeral 110 20  
 flipper *Swim.* 279 18  
 flipper *Bathing* 280 41  
 flipper *Mammals* 367 28  
 flip-up window 142 4  
 flitch of bacon 96 2  
 flitter-mouse 366 9  
 float *Bldg. Site* 118 57  
 float *Plumb. etc.* 126 15  
 float *Weaves* 171 40  
 float *Car* 192 15  
 float *Rivers* 216 12  
 float *Hydr. Eng.* 217 34  
 float *Aircraft* 232 6  
 float *Swim.* 282 18  
 float *Motorboats etc.* 286 44  
 float *Theatre* 316 26  
 float, cork ~ *Fish Farm.* 89 43  
 float, cork ~ *Swim.* 282 32  
 float, lead-weighted ~ 89 48  
 float, plastic ~ 89 44  
 float, polystyrene ~ 89 46  
 float, quill ~ 89 45  
 float, skin ~ 353 11  
 float, sliding ~ 89 43, 48  
 float, spherical ~ 90 19  
 float, wooden ~ 90 6  
 float bath 162 16  
 float chamber 192 14  
 float glass process 162 12  
 floating thread, diagonal ~ 171 38  
 floating thread, loose ~ 171 41  
 floating vessel 221 65

floating yarn, diagonal ~ 171 38  
 floating yarn, loose ~ 171 41  
 float lever 65 43  
 float line 90 4  
 floatplane 232 5  
 floats 89 43-48  
 float seaplane 232 5  
 float shaft 217 35  
 flood bed 216 41  
 flood containment area 216 42  
 flood damage 216 5  
 floodgate 217 77  
 flood plain 13 62  
 flood wall 216 32  
 floor 296 11; 297 6  
 floor, blind ~ 123 38, 73  
 floor, concrete ~ 118 16  
 floor, false ~ 120 43; 123 68  
 floor, ferroconcrete ~ 119 8  
 floor, first ~ 37 2, 3; 118 7, 14  
 floor, inserted ~ 120 43; 123 68  
 floor, reinforced concrete ~ 119 8; 123 35  
 floor, ribbed ~ 123 35  
 floor, second ~ 37 3; 118 14  
 floor, upper ~ 37 3; 118 14  
 floor and carpet cleaning 50 53-86  
 floorboard 120 36  
 floor brick 159 24  
 floor brush 129 27  
 floor ceiling 222 63  
 floor cleaning 50 53-86  
 floor cloth 50 55  
 floor construction 123  
 floor filling 120 44; 123 69  
 floor grinding machine 138 7  
 floor indicator 271 49  
 flooring block, hollow ~ 159 26  
 floor manager 271 33  
 floor nozzle 50 71  
 floor plate 222 59  
 floor socket 127 23  
 floor socket, sunken ~ 127 24  
 floor trader 251 6  
 floorwalker 271 33  
 flop 298 9  
 floppy disc reader 244 8  
 flora 356 21  
 florin 252 19  
 flour 91 28; 97 52  
 flour beetle 81 18  
 flour corn 68 31  
 flour silo 97 74  
 flow 216 9  
 flow chart 76 9  
 flow coating machine 129 34  
 flow diagram 76 9; 92 25  
 flower *Soft Fruit* 58 4  
 flower *Drapes & Nuts* 59 9  
 flower *Weeds* 61 10, 19, 22  
 flower *Arable Crops* 68 42  
 flower *Fodder Plants* 69 7, 14  
 flower *Gdn. Pests* 80 11  
 flower *Bot.* 370 23, 51  
 flower *Decid. Trees* 371 17, 26, 35, 40, 52, 55, 62

flower *Shrubs etc.* 373 5, 7, 11, 14, 31; 374 6, 7, 15, 21, 24  
 flower *Flowers etc.* 375 3, 6, 16, 19, 20, 23, 40, 46; 376 2, 5, 11, 19, 23  
 flower *Alp. Plants etc.* 378 16, 20, 28, 31, 32, 37, 47, 57  
 flower *Trop. Plants* 382 4, 17, 18, 29, 42, 55  
 flower *Industr. Plants* 383 12, 17, 27, 31, 36, 39, 46, 47  
 flower *South. Fruits* 384 13, 18, 56, 57, 65  
 flower, amaranthine ~ 60 21  
 flower, androgynous ~ *Shrubs etc.* 374 10  
 flower, androgynous ~ *Trop. Plants* 382 12, 14  
 flower, female ~ *Drapes & Nuts* 59 38  
 flower, female ~ *Decid. Trees* 371 6, 13  
 flower, female ~ *Conifers* 372 43  
 flower, female ~ *Shrubs etc.* 373 20  
 flower, female ~ *Alp. Plants etc.* 378 25; 378 53  
 flower, female ~ *Trop. Plants* 382 32, 50  
 flower, female ~ *Industr. Plants* 383 50  
 flower, female ~ *South. Fruits* 384 7, 14, 42, 43  
 flower, forced ~ 55 24  
 flower, fumaricaceous ~ 60 5  
 flower, hermaphroditic ~ *Shrubs etc.* 374 10  
 flower, hermaphroditic ~ *Trop. Plants* 382 12, 14  
 flower, male ~ *Drapes & Nuts* 59 39  
 flower, male ~ *Decid. Trees* 371 14  
 flower, male ~ *Conifers* 372 43  
 flower, male ~ *Shrubs etc.* 373 21; 374 11  
 flower, male ~ *Alp. Plants etc.* 378 23, 53  
 flower, male ~ *Trop. Plants* 382 13  
 flower, male ~ *Industr. Plants* 383 51  
 flower, male ~ *South. Fruits* 384 5, 15, 44, 51  
 flower, open ~ 374 17  
 flower, withered ~ 58 55  
 flower arrangement 266 78; 267 37; 330 48  
 flower basket 266 29  
 flower bed *Fruit & Veg. Gdn.* 52 18  
 flower bed *Market Gdn.* 55 37  
 flower bed *Park* 272 41  
 flower box 37 20  
 flower bud *Soft Fruit* 58 27  
 flower bud *Bot.* 370 24  
 flower bud *Decid. Trees* 371 25  
 flower bud *Shrubs etc.* 374 14



flower bud *Trop. Plants* 382 28  
 flower cone, female ~ 372 4, 16, 22, 34, 62, 68  
 flower garden 51 1-35  
 flower girl 266 28  
 flower head *Weeds* 61 14  
 flower head *Alp. Plants etc.* 378 12  
 flower head, discoid ~ 370 74  
 flower head, hollow ~ 370 75  
 flowering branch *Decid. Trees* 371 2, 10, 16, 34, 39, 51, 54, 66, 71  
 flowering branch *Conifers* 372 33  
 flowering branch *Trop. Plants* 382 8, 12, 23, 27, 31, 50  
 flowering branch *Industr. Plants* 383 22, 26, 30, 38  
 flowering branch *South. Fruits* 384 17, 24, 37, 49, 54  
 flowering rush 378 39  
 flowering shoot *Alp. Plants etc.* 378 2, 27  
 flowering shoot *Trop. Plants* 382 41, 47  
 flowering shoot *Industr. Plants* 383 42  
 flower of inner series 375 32  
 flower of outer series 375 31  
 flower pot 54 8  
 flowers, wild ~ 375; 376  
 flower seller 266 28  
 flower shoot 59 28  
 flower shoot, male ~ 372 6, 62, 68  
 flower stalk *Drapes & Nuts* 59 4  
 flower stalk *Bot.* 370 52  
 flower stalk *Industr. Plants* 383 7  
 flower stand 204 48; 267 36  
 flower stem 370 52  
 flower umbel 378 40  
 flower vase 309 2  
 flower window 37 68  
 flowmeter *Hosp.* 26 3  
 flowmeter *Dairy.* 76 4  
 flow path 154 51  
 flow pipe *Roof & Boilerr.* 38 74  
 flow pipe *Plumb. etc.* 126 23  
 flow pipe *Energy Sources* 155 10  
 fluat 128 7  
 flue 155 25  
 flueblock 38 40  
 flue brush 38 35  
 flue pipe 322 57  
 flue pipe, metal ~ 326 23-30  
 flue pipe, open ~ 326 23-30, 31-33  
 flue pipe, stopped ~ 326 34  
 flue pipe, wooden ~ 326 31-33  
 flue pipe duct 326 24  
 flue pipe windway 326 24  
 flue tube 210 8  
 fluid container 247 9  
 fluid reservoir 247 9  
 fluid transmission 212 27, 52

fluorescent display, eight-digit ~ 247 15  
 fluorescent material 240 18  
 fluorescent tube 127 61, 62  
 fluorite 351 16  
 fluoroscope, mobile ~ 26 14  
 fluorspar 351 16  
 fluothane container 26 26  
 flush-deck vessel 258 2; 259 22  
 flushing lever *Bathrm. etc.* 49 17  
 flushing lever *Plumb. etc.* 126 19  
 flushing valve 126 37  
 flush pipe 126 17  
 flute *Mills* 91 17  
 flute *Music. Instr.* 323 31  
 flute *Art* 334 27  
 flute *Ethnol.* 353 47  
 flute, globular ~ 324 32  
 flute, small ~ 323 30  
 fluting 157 6  
 flux *Goldsm. etc.* 108 36  
 flux *Plumb.* 125 7  
 flux *Gas Weld.* 141 18  
 flux *Iron & Steel* 147 2  
 fly *Men's Wear* 33 48  
 fly *Fish Farm.* 89 65  
 fly *Articulates* 358 18  
 fly agaric 379 10  
 fly amanita 379 10  
 fly and draw curtain 315 4  
 fly curtain 315 3  
 flyer 164 25  
 fly floor 316 5  
 fly frame 164 19  
 fly frame operative 164 24  
 fly frame operator 164 24  
 fly front 33 62  
 fly fungus 379 10  
 fly gallery 316 5  
 flying boat 232 1  
 flying boat, amphibian ~ 232 8  
 flying buttress 335 28  
 Flying Dutchman 284 49  
 fly leaf 185 49  
 fly line 316 8  
 fly man 316 7  
 fly nut *Mach. Parts etc.* 143 42  
 fly nut *Bicycle* 187 39  
 flyover 268 48  
 flysheet 278 22  
 fly swat 83 32  
 fly title 185 44  
 flywheel *Weaving* 166 15  
 flywheel *Intern. Combust. Eng.* 190 20  
 F major 320 63  
 F minor 320 66  
 foal 73 2  
 foam bath 49 3  
 foam can 228 28  
 foam canister 83 6  
 foam feed pipe 83 10  
 foam gun 270 64  
 foam-making branch 270 64  
 focal length setting 117 3  
 focimeter 111 33

fo'c'sle 218 10, 19; 221 13; 223 48  
 focus 347 25, 27  
 focus, seismic ~ 11 32  
 focusing adjustment 240 30  
 focusing aid 115 60  
 focusing device 5 11  
 focusing hood 114 23; 115 68  
 focusing ring 114 39; 115 8  
 focusing screen *Optic. Instr.* 112 21  
 focusing screen *Photog.* 115 39  
 focusing screen *Photomech. Reprod.* 177 2, 34  
 focusing screens, interchangeable ~ 115 58-66  
 focusing stage 115 86  
 focusing telescope 115 74  
 focusing wedge 115 55  
 focus setting 114 28; 117 3  
 fodder plants 69 1-28  
 fodder silo 62 11, 43  
 fodder tank 221 73  
 fog 9 31  
 fog, high ~ 8 4  
 fog headlamp and rear lamp switch 191 64  
 fog horn 223 3  
 fog horn, ship's ~ 224 32  
 fog lamp, rear ~ 191 67  
 fog lamp warning light 191 63  
 foil 294 1-18, 11  
 foil, electric ~ 294 26  
 foil, French ~ 294 37  
 foil, Italian ~ 294 39  
 foil fencers 294 5-6  
 foillists 294 5-6  
 foil mask 294 13  
 foil pommel 294 40  
 foilsman 294 5-6  
 fold 185 54  
 fold, asymmetrical ~ 12 13  
 fold, gluteal ~ 16 42  
 fold, nasolabial ~ 16 11  
 fold, normal ~ 12 12  
 fold, reclined ~ 12 15  
 fold, recumbent ~ 12 15  
 fold, symmetrical ~ 12 12  
 fold-away table 207 53  
 foldboats 283 54-66  
 folder *Offset Print.* 180 15, 29  
 folder *Letterpress* 181 55  
 folder *Photograv.* 182 27  
 folder *Office* 245 19  
 folder-feeding station 184 17  
 folder unit *Offset Print.* 180 15, 29  
 folder unit *Letterpress* 181 55  
 folder unit *Photograv.* 182 27  
 folding 12 4-20  
 folding machine 249 58  
 folding mechanism 249 46  
 fold mountains 12 12-20  
 fold plate 185 10  
 fold unit 74 1  
 foliage 330 48  
 foliage plant 39 37  
 folk instruments 324 1-46  
 follicle *Man* 20 84

follicle *Bot.* 370 91  
 follower *Metalwkr.* 140 43  
 follower *Composing Rm.* 175 57  
 follow-through 293 84  
 font 332 10  
 fontange, lace ~ 355 65  
 font basin 332 11  
 food, canned ~ 96 25; 98 15-20  
 food, frozen ~ 99 58-61  
 food compartment 207 83  
 food pests 81 15-30  
 food price list 266 65  
 food slicer 40 38  
 food store, self-service ~ 99 1-96  
 food vacuole 357 6  
 fool 306 38  
 foolscap 306 39  
 fool *Man* 16 54; 17 26-29; 19 52-63  
 foot *Shoem.* 100 23  
 foot *Photog.* 114 71  
 foot *Joiner* 132 29  
 foot *Blacksm.* 137 15  
 foot *Bookbind.* 185 58  
 foot *Sailing* 284 40  
 foot *Music. Instr.* 326 23  
 foot, palmate ~ 73 36; 359 7  
 foot, prehensile ~ 364 34  
 foot, rubber ~ 114 45  
 foot, second ~ 286 59  
 foot, serpent's ~ 327 39  
 foot, webbed ~ 73 36; 359 6, 7  
 footage counter 117 52  
 foot bag *Infant Care etc.* 28 38  
 foot bag *Winter Countr.* 304 27  
 football 273 10, 12; 291 17; 292 22  
 football boot 291 21  
 football pad 291 33  
 football pitch 291 1-16  
 football player 292 23  
 football sock 291 58  
 footband 185 42  
 foot bar lever 100 27  
 footbath 282 22  
 footbed, surgical ~ 101 50  
 foot binding, front ~ 286 57  
 footboard 186 7, 13  
 foot brake 188 52  
 footbridge 15 78  
 foot control 139 27  
 foot control socket 249 66  
 foot-fault judge 293 24  
 foot ferry 15 60  
 foot gear-change control 188 55; 190 77  
 foot gearshift control 188 55; 190 77  
 footing 123 2  
 foot lever 83 34  
 footlight 316 26  
 footman 186 20  
 foot margin 185 58  
 foot muff *Infant Care etc.* 28 38  
 foot muff *Winter Countr.* 304 27

foot muscle 18 49  
 footnote 185 62  
 foot of bed 43 4  
 foot of goblet 162 42  
 foot of machine 133 25  
 foot of mast 284 20  
 foot passenger ferry 15 60  
 footpath 15 43  
 footpath under railway 15 44  
 foot pedal *Pest Contr.* 83 34  
 foot pedal *Forging* 139 27  
 foot pedal *Arc Weld.* 142 31  
 foot pedal *Letterpress* 181 12  
 foot pedal *Bookbind.* 183 18  
 footpiece *Mach. Tools* 149 12  
 footpiece *Carriages* 186 13  
 footprints 126 59  
 foot rail 267 52  
 footrest *Hairdresser* 105 18; 106 19  
 footrest *Bicycle* 187 47  
 footrest *Motorcycles etc.* 188 44  
 footrest *Railw.* 207 57  
 footrest *Winter Sp.* 301 58  
 footrest *Sports* 305 81  
 footrope *Sea Fish.* 90 9, 18  
 footrope *Ship* 219 46  
 foot scraper 123 25  
 foot switch *Hosp.* 27 21  
 foot switch *Dressm.* 103 26  
 foot switch *Sawmill* 157 66  
 foot switch, electric ~ 50 2  
 foot treadle 83 34  
 foot valve 269 6, 14, 43  
 footwear 101  
 fop 306 33  
 forage harvester, self-propelled ~ 64 34-39  
 forage plants *Fodder Plants* 69 1-28  
 foramen 383 57  
 forceps 22 52  
 forceps, obstetrical ~ 26 53  
 forcing 55 24  
 forcing bed 55 16  
 forcing house 55 4  
 forearm *Man* 16 46  
 forearm *Horse* 72 21  
 forearm balance 295 26  
 forearm stand 295 26  
 forebay 217 39  
 forecarriage 65 14-19  
 forecastle 218 10, 19; 221 13; 223 48  
 fore course 218 41; 219 55  
 foredeck 223 47; 284 10  
 foredeck, flooded ~ 258 65; 259 77  
 fore edge 185 57  
 fore edge margin 185 57  
 fore end 95 51  
 forefinger 19 65  
 forefoot 72 22-26  
 foregrip 87 13  
 forehead 72 18-27  
 forehead stroke 293 40  
 forehead volley 293 41  
 forehead *Man* 16 4-5  
 forehead *Horse* 72 3  
 foreign counter 204 31

foreign exchange counter 204 31; 250 10  
 foreign trade zone 225 2  
 foreleg 70 5; 88 25, 64  
 forelock 72 2  
 foremast 218 42; 219 2-4; 220 21; 221 2  
 foremast, lower ~ 219 2  
 forepart 218 49  
 forepaw 70 6  
 forepeak 227 18  
 fore royal 219 60  
 fore royal yard 219 37  
 foresail 218 41; 219 55  
 foresail, square ~ 220 13  
 foresheet 284 23  
 fore ship 286 33, 36, 40  
 foresight 255 3, 23, 37; 305 42  
 foresight block 255 23; 37  
 foreskin 20 70  
 forest 84 1-34  
 forestage 316 25  
 forestay 284 15  
 forest Indian 352 19  
 forest labourer 84 18  
 forest pests 82  
 forestry 84; 85  
 forestry office 15 3  
 forest track 84 3  
 foretop 219 50  
 fore topgallant mast 219 4  
 fore topgallant rigging 219 18  
 fore topgallant sail 218 52  
 fore topmast 219 3  
 fore topmast crossrees 219 51  
 fore topmast rigging 219 17  
 fore topmast staysail 219 20  
 forewing 358 36  
 foreyard 219 32  
 forge 137 1-8, 1, 34  
 forget-me-not 378 26  
 forging and sizing press 139 18  
 forging press, hydraulic ~ 139 35  
 fork *Tablew. etc.* 45 7, 58  
 fork *Agr. Impl.* 66 3, 7, 22  
 fork *Horse* 71 29  
 fork *Optic. Instr.* 113 12  
 fork *Quarry* 158 33  
 fork *Circus* 307 54  
 fork, rear ~ 188 14; 189 7  
 fork, swinging-arm ~ 188 14; 189 7  
 fork blade 187 12  
 fork column 187 14  
 fork end 187 12  
 forklift 93 23; 206 16; 225 44; 226 8  
 forklift truck 93 23; 206 16; 225 44; 226 8  
 fork mount 113 24  
 fork mounting 113 12, 24  
 forks, front ~ 187 10-12  
 forks, telescopic ~ 188 8  
 fork spanner 134 2  
 fork truck 93 23; 206 16; 225 44; 226 8  
 fork wrench 134 2  
 form *see* forme  
 form *Office* 245 24



formaldehyde atom 242 64  
 format selection 249 34  
 forme 174 10  
 forme, locked up ~ 181 36  
 forme bed 180 78; 181 17  
 forme-inking roller 181 18, 27, 61  
 former *Opticn.* 111 25, 26  
 former *Plumb. etc.* 126 83  
 former *Letterpress* 181 53  
 former *Aircraft* 230 55  
 former *Air Force* 257 28  
 forme roller 181 7, 18, 27  
 forms 36 42-86  
 Formula One racing car 290 34  
 Formula Two racing car 290 36  
 formwork 119 54-76  
 forsythia 373 1  
 forte 321 38  
 forte fortissimo 321 40  
 forte pedal 325 8  
 forte piano 321 41  
 fortissimo 321 39  
 fortress 15 74  
 fortune teller 308 36  
 forward *Swim.* 282 50  
 forward *Ball Games* 293 75  
 forward, reverse and still projection switch 117 88  
 forward horizontal stand 295 30  
 forwarding agent 206 28  
 forwarding office 206 26  
 forwarding roll 180 4  
 forward kip 296 58  
 forward pace 295 43  
 forward roll 297 19, 20  
 forward somersault 297 18  
 forward split 295 15  
 forward straddle 295 4  
 forward walkover 297 26  
 forward wind button 249 73  
 Fosbury flop 298 9  
 fosse 329 37  
 fossette 16 16  
 foul 291 50; 299 34  
 foul line 292 48  
 foundation *Bees* 77 43  
 foundation *Floor etc. Constr.* 123 2  
 foundation base 123 3  
 foundation pile 5 28  
 foundation trench 118 75  
 founder 148 8  
 fountain 272 8, 21, 22, 62; 334 68  
 fountain pen 260 14  
 fountain roller 181 64; 249 52  
 Fourcault glass-drawing machine 162 8  
 Fourcault process 162 1  
 four-channel balance control 241 42  
 four-channel demodulator 241 45  
 four-channel level control 241 42  
 four-eight time 320 31  
 four-four time 320 32

four-masters 220 28-31  
 four-to-pica 175 20  
 four-two time 320 33  
 four-wheel drive 194 1  
 fowl, domestic ~ 73 19-36  
 Fowler flap 229 52  
 Fowler flap, double-slotted ~ 229 40  
 fowl run 74 11  
 foxglove 379 2  
 fox hunt 289 41-49  
 fox terrier, wire-haired ~ 70 15  
 foyer 5 25; 267 1-26, 44-46; 315 12-13  
 fraction 344 10, 19  
 fraction, complex ~ 344 17  
 fraction, compound ~ 344 17  
 fraction, improper ~ 344 16, 18  
 fraction, proper ~ 344 15  
 fractionating column 145 37  
 fractions, vulgar 344 15-16  
 fractocumulus 8 12  
 fractostratus 8 11  
 Fraktur 342 3  
 frame *Agr. Mach.* 65 8, 90  
 frame *Bees* 77 40  
 frame *Mills* 91 3  
 frame *Opticn.* 111 5  
 frame *Basketm.* 136 22  
 frame *Forging* 139 16  
 frame *Iron Foundry etc.* 148 57  
 frame *Mach. Tools* 149 65  
 frame *Knitting* 167 33  
 frame *Railw.* 207 3; 208 5  
 frame *Shipbuild.* 222 58  
 frame *Aircraft* 230 55  
 frame *Rowing* 283 49, 67  
 frame *Sailing* 285 51  
 frame *Gymn.* 297 12  
 frame *Sports* 305 14, 88  
 frame, aluminium ~ 50 19  
 frame, annular ~ 235 47  
 frame, bone ~ 353 13  
 frame, C-shaped ~ 26 19; 27 17  
 frame, ferroconcrete ~ 119 2  
 frame, heated ~ 55 16  
 frame, iron ~ 325 2  
 frame, lower ~ 148 20  
 frame, metal ~ *Opticn.* 111 7  
 frame, metal ~ *Music. Instr.* 324 76  
 frame, plate glass ~ 179 15  
 frame, reinforced concrete ~ 119 2  
 frame, sectional ~ 65 56  
 frame, shell ~ 111 8  
 frame, tortoiseshell ~ 111 8  
 frame, tubular ~ 188 9, 49  
 frame, upper ~ 148 19  
 frame, wire ~ 339 35  
 frame, wooden ~ 353 13  
 frame bar 64 51  
 frame-clamping machine 133 42  
 frame-coding device 242 8-10  
 frame counter 115 17; 313 28

frame-cramping machine 133 42  
 frame drum 353 26  
 frame end plate 164 26  
 frame hive 77 45-50  
 frame-mounting device 133 48  
 frame number 187 51  
 frame sample 124 2  
 frame-sanding pad 133 34  
 frame saw, vertical ~ 157 2  
 frame section, aft ~ 234 49  
 frame section, forward ~ 234 45  
 frame slipway 222 19-21  
 frame stand 133 43  
 frame tent 278 36  
 frame timber 119 64  
 frame timber, bolted ~ 119 74  
 frame vent 55 17  
 frame wood 124 3  
 frame wood sample 124 2  
 framework 339 22  
 framework support 214 77  
 framing 336 11  
 framing chisel 132 11  
 framing control 312 29  
 framing table 132 62  
 franc 252 15, 16, 17, 18  
 Frankfurter 96 8  
 Frankfurter garland cake 97 42  
 Frankfurter sausage 96 8  
 franking machine 22 24; 236 7, 27, 47  
 freak show 308 19  
 free backward circle 297 29  
 free combination knob 326 40  
 free combination stud 326 40  
 free exercise 295  
 free-fall positions 288 60-62  
 free flight model, remote-controlled ~ 288 86  
 free kick 291 43  
 free leg *Athletics* 298 27  
 free leg *Winter Sp.* 302 3  
 free leg, vertical ~ 298 25  
 free port 225 2  
 freestyle relay race 282 24-32  
 freestyle wrestling 299 10-12  
 free-throw line 292 38  
 free walkover forward 297 25  
 freeway *Map* 15 16  
 freeway *Docks* 225 54  
 free-wheel hub 187 63  
 freezer 22 63; 96 21; 97 65; 98 74  
 freezer, upright ~ 39 7  
 free zone enclosure 225 3  
 free zone frontier 225 3  
 freight agent 206 28  
 freight barge 216 25  
 freight car 206 6  
 freight car, flat ~ 206 21  
 freight car, open ~ 213 8, 33  
 freight car, special ~ 213 33  
 freight depot *Map* 15 91  
 freight depot *Station* 206  
 freighter 221 57  
 freight house 206 7, 26-39  
 freight house door 206 37

freight office 206 26  
 freight truck 206 15  
 French chalk 271 39  
 French horn 323 41  
 French lady 355 51  
 French toast 97 54  
 French window 37 21  
 frequency band 309 22  
 fresco 338 40  
 fresh-air inlet 356 16  
 fresh-air inlet and control 191 85  
 fresh-air regulator 191 86  
 fresh meat counter 99 51  
 fresh milk filling and packing plant 76 20  
 fresh milk tank 76 15  
 fresh oil tank 65 46  
 freshwater eel 364 17  
 freshwater pearl mussel 357 33  
 fresh water tank 221 70; 223 79  
 Fresnel lens 115 64  
 fret *Roulette* 275 30  
 fret *Music. Instr.* 324 9  
 fretsaw 135 12; 260 53  
 fretsaw blade 135 13; 260 54  
 friction drive 116 33; 312 37  
 friction pad 192 49  
 friction tape 127 34  
 friction wheel 322 26  
 fridge *Kitch.* 39 2  
 fridge *Flat* 46 33  
 fridge *Disco* 317 10  
 frieze 335 9  
 frieze, Babylonian ~ 333 19  
 frieze decoration 334 16  
 frigate 258 53  
 frill 31 34; 32 44  
 frill collar 31 46  
 frill front 32 44  
 fringe 34 36  
 fringe, decorative ~ 353 25  
 fringe region 7 34  
 frit 162 2  
 frit feeder 162 13  
 frit funnel 162 13  
 frock coat 355 76  
 frog *Agr. Mach.* 65 8  
 frog *Road Constr.* 200 26  
 frog *Railw.* 202 24  
 frog *Music. Instr.* 323 13  
 frog position 288 61  
 frog's bit 378 29  
 frond 378 49  
 front 305 1  
 front, cold ~ 8 13; 9 27  
 front, extended ~ 200 10  
 front, hinged ~ 213 10  
 front, occluded ~ 9 25  
 front, warm ~ 8 5; 9 26  
 frontalis 19 4  
 front axle pivot pin 65 48  
 front axle suspension 65 49  
 front band 71 9  
 front element mount 115 6  
 front fan-jet 232 33  
 front-line player 293 63  
 front panel, sliding ~ 349 27

front roller underclearer 164 44  
 fronts 9 25-29  
 fronts, cold ~ 8 13-17  
 fronts, warm ~ 8 5-12  
 front seat headrest 193 7  
 front seat head restraint 193 7  
 front sight block 255 23, 37  
 front support *Free Exerc.* 295 21, 23  
 front support *Gymn.* 296 28  
 front wheel drive 191 52  
 front wheel drum brake 188 36  
 froth 266 4  
 frozen food compartment 39 5  
 fruit *Weeds* 61 11, 20, 23  
 fruit *Restaurant* 266 57  
 fruit *Decid. Trees* 371 4, 19, 28, 45, 69  
 fruit *Conifers* 372 53, 64  
 fruit *Shrubs etc.* 373 12, 18, 19, 25, 29, 31, 34  
 fruit *Flowers etc.* 375 4, 7, 10, 13, 17, 24, 35, 37, 47; 376 3, 6, 14  
 fruit *Alp. Plants etc.* 378 11, 38, 42  
 fruit *Trop. Plants* 382 3, 5, 10, 15, 17, 24, 39  
 fruit *Industr. Plants* 383 14, 18, 21, 28, 32, 40, 43, 52, 56, 59  
 fruit *South. Fruits* 384 19, 26, 39, 45  
 fruit, aggregate ~ *Soft Fruit* 58 28  
 fruit, aggregate ~ *Bot.* 370 100, 101  
 fruit, canned ~ 98 16  
 fruit, compound ~ *Soft Fruit* 58 28  
 fruit, compound ~ *Bot.* 370 100, 101  
 fruit, dehiscent ~ 375 27  
 fruit, immature ~ 378 31  
 fruit, indehiscent ~ 375 43  
 fruit, mature ~ *Decid. Trees* 371 61  
 fruit, mature ~ *Trop. Plants* 382 33  
 fruit, ripe ~ *Decid. Trees* 371 61  
 fruit, ripe ~ *Trop. Plants* 382 33  
 fruit, soft ~ 58 1-30  
 fruit, stewed ~ 45 30  
 fruit, unripe ~ 378 31  
 fruit, young ~ *Decid. Trees* 371 59  
 fruit, young ~ *South. Fruits* 384 31  
 fruit and vegetable counter 99 80  
 fruit and vegetable garden 52 1-32  
 fruit bowl 45 29, 40  
 fruit capsule, mature ~ 382 44  
 fruit capsule, ripe ~ 382 44

fruit cone 372 2, 29, 30, 36, 41, 57  
 fruit dish 45 28  
 fruit flan 97 22; 99 20  
 fruit garden 52  
 fruiting body 381 2  
 fruiting branch *Decid. Trees* 371 3, 11, 18, 31, 36, 41, 47, 50, 56, 64  
 fruiting branch *Conifers* 372 40, 51, 59, 63, 66, 70  
 fruiting branch *Trop. Plants* 382 2, 37  
 fruiting branch *Industr. Plants* 383 34, 46  
 fruiting branch *South. Fruits* 384 38  
 fruiting palm 384 2  
 fruit juice 98 18; 266 58  
 fruit juice, bottled ~ 99 74  
 fruit juice, canned ~ 99 75  
 fruit knife 45 71  
 fruit pests 80 1-19  
 fruit picker 56 22  
 fruit pip 58 37, 60  
 fruit preserver 40 23  
 fruits 370 91-102  
 fruits, dehiscent ~ 370 91-96  
 fruits, indehiscent ~ 370 97-102  
 fruits, Mediterranean ~ 384  
 fruits, southern ~ 384  
 fruits, subtropical ~ 384  
 fruits, tropical ~ 384  
 fruit scale 372 67  
 fruit spoon 45 66  
 fruit stall 308 53  
 fruit storage shed 225 52  
 fruit tree, standard ~ 52 30  
 fruit trees, dwarf ~ 52 1, 2, 16, 17, 29  
 fruit warehouse 225 52  
 frustum of a cone 347 45  
 frying pan 40 4  
 fry pond 89 6  
 F sharp major 320 61  
 F sharp minor 320 58  
 fuchsia 53 3  
 fuel cell 234 62  
 fuel gas 145 52  
 fuel gauge 191 38, 65  
 fuel-handling hoist 154 27  
 fuel hand pump 190 64  
 fuel-injection engine 190 1  
 fuel injector 190 32  
 fuel inlet 192 13  
 fuel leak line 190 53  
 fuel level sensor 234 27  
 fuel line 190 31  
 fuel line duct 234 40  
 fuel oil 38 50  
 fuel oil, heavy ~ 145 59  
 fuel oil, light ~ 145 58  
 fuel oil tank 212 75  
 fuel pin 154 4  
 fuel pipe 286 25  
 fuel pressure gauge 230 19  
 fuel pressure line 190 52  
 fuel pressure pipe 190 52  
 fuel pressure regulator 190 17  
 fuel rod 154 4



fuel storage 154 28  
 fuel supply pipe 190 31  
 fuel tank *Moon L.* 6 7, 29, 37  
 fuel tank *Agr. Mach.* 65 42  
 fuel tank *Motorcycles etc.* 188 10, 28  
 fuel tank *Motorcycle* 189 2  
 fuel tank *Railw.* 209 20; 212 56  
 fuel tank *Ship* 221 71; 223 80  
 fuel tank *Aircraft* 230 48  
 fuel tank *Space* 234 58  
 fuel tank, forward ~ 235 21  
 fuel tank, jettisonable ~ 235 46  
 fuel tank, main ~ 212 4  
 fuel tanker 258 97  
 fuel tender 210 67  
 fuel warning light 191 71  
 full circle 308 43  
 full-colour print 340 28  
 full-cone indicator 165 7  
 fuller's earth 199 38  
 fulling machine, rotary ~ 168 1  
 fulling roller, bottom ~ 168 6  
 fulling roller, top ~ 168 3  
 full point 342 16  
 full spread position 288 60  
 full-step 320 51, 53  
 full stop 342 16  
 full title 185 46  
 fulmar 359 12  
 fume extraction equipment 142 13  
 fume extractor 255 59, 89  
 fumigation chamber, mobile ~ 83 15  
 fumigation plant, vacuum ~ 83 11  
 fumigator, vacuum ~ 83 11  
 function, trigonometrical ~ 346 32  
 function key 247 17  
 funeral 331 33-41  
 fungi, edible ~ 381  
 fungi, esculent ~ 381  
 fungi, poisonous ~ 379 10-13  
 funicular 214 12  
 funicular railway car 214 13  
 funnel *Photog.* 116 12  
 funnel *Ship* 221 8, 40, 75, 84; 223 1  
 funnel *Warships* 258 58; 259 32  
 funnel *Chem.* 350 16  
 funnel, aft ~ 258 20  
 funnel, forward ~ 258 19  
 Funnel-Beaker culture 328 12  
 funnel marking 223 2  
 fur marker 131 22  
 furnace 199 29  
 furnace, continuous ~ 139 1  
 furnace, electric ~ 147 51-54  
 furnace, gas ~ 139 47  
 furnace, gas-fired ~ 139 47; 140 11  
 furnace, low-shaft ~ 147 51-54  
 furnace, stationary ~ 147 23

furnace bed 38 66  
 furnace incline 147 2  
 furnace lift 147 2  
 furnace thermometer 38 64  
 furniture 174 8; 181 40  
 furniture lorry 268 47  
 furniture truck 268 47  
 furrier 131 1  
 furrow *Agr.* 63 8  
 furrow *Mills* 91 17  
 furrow, gluteal ~ 16 42  
 furrow wheel 65 16  
 fur seal 367 18  
 fur-sewing machine 131 9  
 fur side 131 12, 17  
 furskin 131 5  
 furskin, cut ~ 131 14  
 furskin, uncut ~ 131 6  
 furskins 131 11-21  
 fur trapper 306 8  
 fur worker 131 8, 23  
 fuse *Electr.* 127 19, 36  
 fuse *Quarry* 158 28  
 fuse box *Hall* 41 19  
 fuse box *Weaving* 166 23  
 fuse carrier 127 68  
 fuse cartridge 127 36  
 fuse holder 127 35  
 fuselage 230 54; 288 26  
 fuselage attachment 235 4  
 fuselage tank 257 31  
 fuse wire 127 68

## G

gable 37 15; 121 5; 122 25  
 gable, curved ~ 336 5  
 gable, round ~ 335 50  
 gable end 37 15; 122 25  
 gable roof 37 5; 121 1  
 gable slate 122 80  
 gaffer 310 37  
 gaffsail 220 1  
 gaff topsail 219 31  
 gag *Horse* 71 53  
 gag *Fish Farm.* 89 42  
 gag bit 71 53  
 gage *see* gauge  
 gaillardia 60 19  
 gait 289 7  
 gaiter, leather ~ 191 92  
 gaits of the horse 72 39-44  
 Galaxy 3 35  
 gale 373 33  
 galena 351 14  
 galingale 53 17  
 gall *Gdn. Pests* 80 33  
 gall *Forest Pests* 82 34  
 gallant soldier 61 31  
 gall bladder 20 11, 36  
 galleries under bark 82 23-24  
 gallery *Forest Pests* 82 24  
 gallery *Coal* 144 29  
 gallery *Theatre* 315 16  
 gallery *Church* 330 25  
 gallery, drilled ~ 192 21  
 gallery grave 328 16  
 galley *Composing Rm.* 174 12, 44  
 galley *Ship* 218 44-50; 223 42

galley *Aircraft* 231 20  
 galley loader 233 22  
 galley slave 218 48  
 gall gnat 80 40  
 gall midge 80 40  
 gallop, full ~ 72 43-44, 43, 44  
 gallows 221 87  
 gall wasp 82 33  
 galvanometer 11 44  
 gamba 322 23  
 gambling casino 275 1  
 gambling game 275 1-33  
 gambling table 275 8  
 gambrel 94 21  
 gambrel roof 121 18  
 gambrel stick 94 21  
 game 86 28; 88  
 game, furred ~ 86 35  
 game, positional ~ 276 1-16  
 game, winged ~ 86 41  
 game of chance 275 1-33  
 game path 86 16  
 game preserve 86 1-8  
 gaming room 275 1  
 gaming table 275 8  
 gamma radiation 1 33, 40  
 gammon steak 95 54  
 gander 73 34  
 gang mill 157 2  
 gang stitcher 184 15  
 gangway 38 3  
 gangway, central ~ *Railw.* 208 23  
 gangway, central ~ *Ship* 218 46  
 gannet 359 9  
 gantry *Photomech. Reprod.* 177 13  
 gantry *Shipbuild.* 222 26  
 gantry *Docks* 225 40  
 gantry crane 157 27; 206 55; 222 20, 25  
 gantry support 214 24  
 garage *Dwellings* 37 32, 79  
 garage *Garage* 195  
 garage, agent's ~ 195 1-55  
 garage, distributor's ~ 195 1-55  
 garage driveway 37 52  
 garbage 199 17  
 garbage can 199 3  
 garbage can dumping device 199 2  
 garbage container 199 4  
 garbage disposition 199  
 garbage incineration unit 199 28  
 garbage truck 199 1  
 garden 37 57  
 garden, Baroque ~ 272 1-40  
 garden, formal ~ 272 1-40  
 garden, front ~ 37 58  
 garden chair 37 49  
 gardener 55 20  
 garden fence 52 10  
 garden flowers 60  
 garden gate 272 31  
 garden hedge 51 9  
 garden hoe 66 1  
 garden hose 37 42; 56 27  
 garden house 52 14

garden ladder 52 8  
 garden light 37 38  
 garden mould 55 15  
 garden pansy 60 2  
 garden parasol 37 48  
 garden path 51 14; 52 23  
 garden pests 80  
 garden pond 51 16  
 garden rake 51 4  
 garden rose 60 15  
 garden seat 272 42  
 garden shed 52 3  
 garden shovel 55 14  
 garden sieve 55 13  
 garden spider 358 45  
 garden strawberry 58 16  
 garden table 37 50  
 garden tiger 365 7  
 garden tools 56  
 garden wall 37 37  
 gargoyle 335 30  
 garland 306 17; 335 54  
 garnet 351 7  
 Garratt locomotive 210 64  
 garter 318 28  
 gas, liquid ~ 145 53  
 gas, natural ~ 12 30  
 gas appliances 126 12-25  
 gas bottle 278 53  
 gas cap 12 30  
 gas circulation unit 83 16  
 gas-collecting main 156 17  
 gas compressor 156 26  
 gas connection 141 31  
 gas control 141 32  
 gas cooler *Offshore Drill.* 146 27  
 gas cooler *Coking* 156 19  
 gas cooling 156 29  
 gas cutting installation 148 67  
 gas cylinder 138 35  
 gas cylinder manifold 141 1  
 gas drying 156 30  
 gas extractor 156 21  
 gas fitter 126 1  
 gas fitter's tools 126 58-86  
 gas flue 152 12  
 gas generator 350 59  
 gas holder 156 25  
 gas hose 141 9  
 gas inlet 350 2  
 gas inlet pipe 350 2  
 gaskin 72 36  
 gas lighter 107 30  
 gas main 198 21  
 gas main, high-pressure ~ 156 45  
 gas main, low-pressure ~ 156 44  
 gas meter *Plumb. etc.* 126 5  
 gas meter *Coking* 156 31  
 gas oil component 145 42  
 gasoline can 196 25  
 gasoline canister 84 36  
 gasoline inlet 192 13  
 gasoline pump 196 1  
 gasoline pump, self-service ~ 196 8  
 gasoline pump hose 196 2  
 gasoline station 196 1-29

gasoline tank 188 10, 28; 189 2; 305 87  
 gasometer 144 12  
 gas outlet *Oil, Petr.* 145 29  
 gas outlet *Chem.* 350 63  
 gas pipe *Pest Contr.* 83 14  
 gas pipe *Forging* 139 54  
 gas pipe *Metalwkr.* 140 12  
 gas pipe *Oil, Petr.* 145 29  
 gas pipe *Iron & Steel* 147 18, 27  
 gas pliers *Plumb. etc.* 126 58  
 gas pliers *Metalwkr.* 140 68  
 gas pressure vessel 234 32  
 gas regenerator chamber 147 28  
 gas regulator 255 34; 350 6  
 gas-separating plant 145 69  
 gas separator 145 28  
 gas station 196 1-29  
 gas supply 27 41  
 gas tap 261 24  
 gastrocnemius 18 62  
 gas tube 83 35  
 gas turbine 209 9  
 gas turbine, auxiliary ~ 231 33  
 gas turbine, twin-shaft ~ 209 23  
 gas turbine controller 209 16  
 gas turbine driving unit 209 8  
 gas turbine fuel tank 209 17  
 gas turbine trainset 209 1  
 gas-washing bottle 350 58  
 gas water 156 39  
 gas welder 141  
 gas welding torch 130 14  
 gate 202 40; 289 8; 337 24  
 gate, removable ~ 118 46  
 gate, sliding ~ 217 18, 55  
 gate, vertical ~ 217 31, 38  
 gate, wrought iron ~ 272 31  
 gate and rails 289 8  
 gateau 99 15; 265 4  
 gateaux 97 22-24  
 gatehouse 329 22  
 gateman 202 42  
 gate pole 301 30  
 gateway 336 15; 337 11  
 gateway, monumental ~ 333 9  
 gatherer and wire stitcher 184 15  
 gathering and wire-stitching machine 184 15  
 gathering machine 249 59  
 gathering station 249 60  
 gaucho 306 31  
 gauge 76 6  
 gauntlet 329 50  
 gauze 183 33; 185 20  
 gauze, sterile ~ 22 58  
 gauze, wire ~ 350 18, 19  
 gauze roll holder 185 19  
 G-clef 320 8  
 gear *Gdn. Tools* 56 20  
 gear *Iron Foundry etc.* 148 63  
 gear *Road Constr.* 201 11  
 gear *Hydr. Eng.* 217 48  
 gear, epicyclic ~ 143 94  
 gear, planetary ~ 143 94  
 gearbox *Agr. Mach.* 65 79  
 gearbox *Turner* 135 4

gearbox *Cotton Spin.* 164 2, 33, 39  
 gearbox, five-speed ~ 189 6  
 gear-change *Agr. Mach.* 65 35  
 gear-change *Motorcycles etc.* 188 31  
 gear-change, floor-type ~ 191 91  
 gear-change, two-speed ~ 188 12  
 gear-change lever 189 28  
 gear-change pattern 192 47  
 gear control 149 2  
 gearing *Agr. Mach.* 64 50, 65  
 gearing *Overh. Irrign.* 67 21  
 gearing *Road Constr.* 201 11  
 gearing, helical ~ 143 89  
 gearing, multi-speed ~ 190 72  
 gearing, multi-step ~ 190 72  
 gear lever 191 91; 192 46  
 gear meter 76 4  
 gears *Agr. Mach.* 64 50, 65  
 gears *Overh. Irrign.* 67 21  
 gear shaft 232 58  
 gear shaft, intermediate ~ 190 57  
 gearshift 65 23, 35; 188 31  
 gearshift, two-speed ~ 188 12  
 gearshift lever *Motorcycle* 189 28  
 gearshift lever *Car* 191 91; 192 46  
 gearshift pattern 192 47  
 gearshift rod 192 41  
 gearshift switch 134 46  
 gear wheel, helical ~ 192 34, 36, 39, 43  
 gear wheel, herringbone ~ 143 87  
 gear wheel, stepped ~ 143 82  
 gear wheels 143 82-96  
 gecko 364 36  
 Geiger counter 2 19  
 Geiger-Müller counter 2 19  
 geisha 353 39  
 gelatine 316 49  
 gelding 73 2  
 Gemini 3 28; 4 55  
 general cargo ship 225 14; 226 13  
 general cargo transit shed 225 9  
 general practice 22 1-74  
 general practitioner 23 2  
 general service lamp 127 56  
 generator *Nucl. Energy* 154 15, 47, 53  
 generator *Energy Sources* 155 46  
 generator *Intern. Combust. Eng.* 190 76  
 generator *Railw.* 211 46  
 generator *Ship* 223 74  
 generator exhaust 146 2  
 generator unit 231 33  
 Geneva movement 312 38  
 Genoa jib 284 16  
 genouillère 329 53  
 gentleman *Café* 265 22



gentleman *Hist. Cost.* 355 54, 61, 73  
 'gentlemen' 233 47  
 'gentlemen's toilet' 233 47  
 geodesy 14 46-62  
 geography, physical ~ 11; 12; 13  
 geology 12 1-33  
 geometrical shape 260 79  
 geometrid 80 16; 82 28  
 geometry 346; 347  
 geometry, elementary ~ 346 1-58  
 geometry, Euclidian ~ 346 1-58  
 geranium 53 1  
 gerbera 51 26  
 germ 370 86  
 German hand 342 11  
 German pointer 70 40  
 German sheepdog 70 25  
 German shepherd 70 25  
 geyser *Phys. Geog.* 11 21  
 geyser *Plumb. etc.* 126 12-13  
 G flat major 320 68  
 gherkin, pickled ~ 98 29  
 giant 306 63; 308 20; 327 37  
 gib *Plumb.* 125 3  
 gib *Mach. Parts etc.* 143 74  
 gig 186 34  
 gig, four-oared ~ 283 26-33  
 Gigantocypris agassizi 369 1  
 gilder 183 2  
 gilding *Painter* 129 40  
 gilding *Bookbind.* 183 1  
 gilding and embossing press 183 26  
 gill *Dom. Anim.* 73 24  
 gill *Edib. Fungi* 381 4, 6  
 gill, tufted ~ 364 19  
 gill cleft 364 3  
 gill cover 364 5  
 gill slit 364 3  
 gillyflower 60 7  
 gimbal ring 224 50  
 gimbal suspension 241 23  
 gimlet 120 65  
 gimping 102 28  
 gimping needle 102 29  
 gingerbread 97 51  
 gipsy girl 306 36  
 gipsy moth 80 1  
 giraffe 367 4  
 giraffe house 356 10  
 girder, steel ~ 143 3-7  
 girdle 32 5  
 girdle clasp 328 24  
 girl, exotic ~ 306 30  
 girt 120 50  
 girth 71 18, 36; 289 11  
 girth, emergency ~ 71 23  
 girth, second ~ 71 23  
 glacier *Phys. Geog.* 12 49  
 glacier *Mountain.* 300 22  
 glacier snout 12 51  
 glacier table 12 56  
 gladiolus 51 28; 60 11  
 gland, bulbourethral ~ 20 75  
 gland, parotid ~ 19 9  
 gland, pituitary ~ 17 43  
 gland, prostate ~ 20 76

gland, submandibular ~ 19 11  
 gland, submaxillary ~ 19 11  
 gland, suprarenal ~ 20 29  
 gland, thyroid ~ 20 1  
 glans penis 20 69  
 glass 54 9  
 glass, armoured ~ 109 29  
 glass, bullet-proof ~ 250 3  
 glass, coloured ~ 260 68  
 glass, crystal ~ 45 86  
 glass, frosted ~ 124 5  
 glass, laminated ~ 124 5  
 glass, lined ~ 124 6  
 glass, molten ~ 162 23, 31, 50  
 glass, ornamental ~ 124 6  
 glass, patterned ~ 124 5  
 glass, pulverized ~ 340 48  
 glass, raw ~ 124 6  
 glass, shatterproof ~ 124 5  
 glass, stained ~ 124 6; 330 15  
 glass, tapered ~ 45 85  
 glass, thick ~ 124 5  
 glass, wired ~ 124 6  
 glassblower 162 38  
 glassblowing 162 38-47  
 glass case 356 15  
 glass cloth 130 29  
 glass cutter, diamond ~ 124 25  
 glass cutter, steel ~ 124 26  
 glass cutters 124 25-26  
 glass-drawing machine 162 8  
 glasses 111 9  
 glass fibre, production of ~ 162 48-55  
 glass fibre products 162 56-58  
 glass filament 162 52  
 glass forming 162 38-47  
 glass furnace 162 1, 49  
 glass holder 124 9  
 glasshouse pot, covered ~ 162 46  
 glassmaker 162 38  
 glassmaking 162 38-47  
 glass mosaic picture 260 69  
 glass paper 135 25  
 glass pliers 124 19  
 glass ribbon 162 10  
 glass sponge 369 7  
 glass wool 162 58  
 glassworker 124 8  
 glazier 124; 124 8  
 glazing sheet 116 58  
 glazing sprig 124 24  
 glede 362 11  
 glider 287 3  
 glider, high-performance ~ 287 9  
 glider, motorized ~ 287 8  
 glider, powered ~ 287 8  
 glider field 287 13  
 gliding 287  
 globe 42 13  
 globe, frosted glass ~ 267 4  
 globe, solar ~ 4 36  
 globe, terrestrial ~ 4 8  
 globe artichoke 57 41  
 globe lamp 267 4  
 globe thistle 53 14  
 glove 33 67; 292 12; 298 47; 318 31  
 glove, catcher's ~ 292 60

glove, fielder's ~ 292 59  
 glove, goalkeeper's ~ 291 19  
 glove box lock 191 89  
 glove compartment lock 191 89  
 glove stand 271 20  
 glow plug 190 66  
 gloxinia 53 7  
 glue 48 4; 260 50-52, 51  
 glue, joiner's ~ 132 13  
 glue-enamel plate 179 32  
 glue pot 132 12, 13; 183 15; 236 5; 260 57  
 glue roller 185 33  
 glue size 128 4  
 glue tank 184 9; 185 32  
 glue well 132 13  
 gluing 183 14  
 gluing machine 185 31  
 gluing mechanism 184 4  
 glume 68 11  
 gluteus maximus 18 60  
 G major 320 56  
 G minor 320 64  
 gnat 358 16  
 goaf 144 37  
 goal *Playground* 273 11  
 goal *Swim.* 282 46  
 goal *Ball Games* 291 35; 292 7  
 goal *Winter Sp.* 302 37  
 goal area 291 5  
 goalkeeper *Playground* 273 14  
 goalkeeper *Swim.* 282 47  
 goalkeeper *Ball Games* 291 10; 292 8  
 goalkeeper *Winter Sp.* 302 36  
 goal kick 291 38  
 goal line 291 7  
 goalpost 273 11; 291 37  
 goal scorer 273 13  
 Goat *Astron.* 3 36; 4 62  
 goat *Dom. Anim.* 73 14  
 goat beard 34 10  
 goat's beard *Forest Plants etc.* 377 5  
 goatsbeard *Forest Plants etc.* 377 5  
 goat's beard *Edib. Fungi* 381 32  
 goatsbeard *Edib. Fungi* 381 32  
 goat willow 371 24  
 gob *Coal* 144 37  
 gob *Glass Prod.* 162 40  
 gobbler 73 28  
 goblet, hand-blown ~ 162 41  
 gobo 310 51  
 gob of molten glass 162 23, 31  
 go-cart 273 33  
 god, Indian ~ 337 19  
 godet 30 52  
 Godet wheel 169 16  
 godparent 332 13  
 God's acre 331 21-41  
 'GO' gauging member 149 57  
 goggles 140 21; 303 15  
 going about 285 27  
 go-kart 305 83  
 go-karting 305 82  
 gold *Heraldry* 254 24  
 gold *Crystalx* 351 6  
 gold and silver balance 108 35

goldcrest 361 10  
 goldcup 375 8  
 gold cushion 183 6  
 golden chain 374 32  
 golden crested wren 361 10  
 golden maidenhair 377 17  
 golden oriole 360 7  
 golden rain 374 32  
 goldfinch 360 1  
 gold finisher 183 2  
 gold knife 183 7  
 gold leaf 129 45, 52; 183 5  
 gold size 129 44  
 goldsmith 108 17  
 golf 293 79-93  
 golf ball *Office* 249 15  
 golf ball *Ball Games* 293 89  
 golf ball cap 249 30  
 golf ball typewriter 249 1  
 golf course 293 79-82  
 golfer 293 83  
 golf trolley 293 85  
 gondola *Supermkt.* 99 23, 43, 62  
 gondola *Railw.* 214 20  
 gondola *Airsports* 288 64  
 gondola cableway 214 19  
 gonfalon 253 12  
 gong 299 46  
 goods 271 10  
 goods, bulky ~ 206 18  
 goods, general ~ 206 4  
 goods depot 15 91  
 goods lorry 206 15  
 goods office 206 26  
 goods shed 206 7, 26-39  
 goods shed door 206 37  
 goods shelf 47 36; 98 14  
 goods station 206  
 goods van 206 6; 213 22  
 goods van, covered ~ 213 14  
 goods wagon, covered ~ 213 14  
 goods wagon, open ~ 213 8  
 goosander 359 15  
 goose 73 34; 272 52  
 gooseberry 58 9  
 gooseberry bush 52 19; 58 1  
 gooseberry cane, flowering ~ 58 2  
 gooseberry flan 97 22  
 gooseberry flower 58 6  
 goosefoot 61 25  
 gooseneck 284 37  
 gorge 13 52  
 gorgerin 334 22  
 gorget 329 43  
 gorilla 368 16  
 goshawk 362 10  
 'GO' side 149 60  
 gosling 73 34  
 gouache 338 17  
 gouge 132 9; 135 15; 339 17  
 gouge, U-shaped ~ 340 6  
 gouge, V-shaped ~ 339 20; 340 9  
 gourd 354 27  
 governor 224 56  
 gown 105 34; 106 4; 355 25, 36, 66  
 gown, linen ~ 355 5

gown, open ~ 355 50  
 gown, sleeveless ~ 355 50  
 graben 12 11  
 grace notes 321 14-22  
 graces 321 14-22  
 grade crossing, protected ~ 202 39  
 grade crossing, unprotected ~ 202 49  
 grade crossings 202 39-50  
 grader 200 19  
 grader levelling blade 200 21  
 grader ploughshare 200 21  
 gradient 347 12  
 grading 74 44  
 grading, automatic ~ 74 52  
 graduated measuring rod 14 47  
 graduation house *Map* 15 32  
 graduation house *Spa* 274 1  
 graftage 54 30-39  
 grafting 54 30-39  
 grain *Arable Crops* 68 1-37, 4, 37  
 grain *Brew.* 92 50  
 grain *Graphic Art* 340 47  
 grain, farinaceous ~ 68 13  
 grain auger 64 20  
 grain harvest 63 31-41  
 grain leaf 68 8, 19  
 grain lifter 64 2  
 grain pest 81 27  
 grain tank 64 23  
 grain tank auger 64 24  
 grain tank unloader 64 25  
 grain unloader spout 64 26  
 grain weevil 81 16  
 grammar school 261 1-45  
 gramophone 309 31  
 gramophone box 309 35  
 gramophone needle 309 33  
 gramophone record 309 32  
 granary weevil 81 16  
 grand 325 40  
 grandee 306 26  
 grandfather clock 110 24; 309 56  
 grand piano 325 40  
 grand piano pedal 325 41  
 grandstand, glass-covered ~ 289 34  
 granite 302 42  
 gran turismo car 193 32  
 granular texture 340 47  
 grape 80 21; 99 89  
 grape-berry moth 80 22, 23, 24  
 grape crusher 78 17  
 grapefruit 384 23  
 grape gatherer 78 11  
 grape phylloxera 80 26  
 grapevine *Wine Grow.* 78 2-9  
 grapevine *Sports* 299 10  
 grape worm 80 23, 24  
 graphic art 340  
 graphic art studio 340 27-64  
 graphite 1 54  
 grapnel 218 11  
 grapple 218 11  
 grappling iron 218 11  
 grasp, kinds of ~ 296 40-46

grasping arm 2 47  
 grass 136 26  
 grass, paniculate ~ 69 27  
 grassbox 56 29  
 grasshopper, artificial ~ 89 68  
 grassland 15 18  
 grassland, marshy ~ 15 19  
 grassland, rough ~ 15 5  
 grass ledge 300 4  
 grass shears 56 48  
 grass snake 364 38  
 grasstrack racing 290 24-28  
 grass verge 200 56  
 grate 199 33  
 graticule *Map* 14 1-7  
 graticule *Hunt.* 87 31-32  
 graticule *Photomech. Reprod.* 177 4  
 graticule adjuster screw 87 30  
 graticule system 87 31  
 grating 141 14  
 grating spectrograph 5 5  
 graupel 9 35  
 grave *Church* 331 23, 34  
 grave *Script* 342 31  
 grave, child's ~ 331 29  
 grave, soldier's ~ 331 32  
 grave digger 331 22  
 gravel 118 36; 119 26  
 gravel filter layer 199 23  
 grave mound 331 24  
 graver 175 33; 340 5  
 graver, round-headed ~ 340 20  
 gravestone 331 26  
 graveyard 331 21-41  
 graveyard chapel 331 28  
 graveyard gate 331 19  
 graveyard wall 331 18  
 gravity fault 12 7  
 gravity fuelling point 257 32  
 gravity hammer, air-lift ~ 139 24  
 gravity mixer 118 33  
 gravure cylinder 182 10  
 gravure cylinder, etched ~ 182 22  
 gravure cylinder, printed ~ 182 17  
 gravure etcher 182 18  
 gravure printing 182  
 gravy boat 45 17  
 gravy ladle 45 18  
 gray see grey  
 grayhound 70 24  
 grease gun 195 30  
 grease nipple 143 81  
 greasepaint stick 315 46  
 greasy chalk 340 26  
 great apes 368 14-16  
 Great Bear 3 29  
 great brain 17 42; 18 22  
 Great Dane 70 14  
 Great Dog 3 14  
 Greater Bear 3 29  
 greater burnet saxifrage 69 28  
 Greater Dog 3 14  
 greater water newt 364 20  
 great hall 329 30  
 great horned owl 362 15  
 great mullein 376 9



great primer 175 30  
 great tit 361 9  
 great titmouse 361 9  
 greave 329 54  
 Greek 355 3  
 Greek woman 355 1  
 green *Ball Games* 293 82  
 green *Colour* 343 8  
 green bowls 305 21  
 green cloth 277 15  
 green cormorant 359 10  
 greenfly 358 13  
 greengage 59 24  
 green grasshopper 358 8  
 greenhouse, heated ~ 55 32  
 greenhouse, polythene ~ 55 40  
 greenhouse, unheated ~ 55 33  
 green liquor, unclarified ~ 172 41  
 green liquor preheater 172 43  
 green locust 358 8  
 green oak roller moth 82 43  
 green oak tortrix 82 43  
 green plover 359 21  
 Greenwich meridian 14 5  
 grenzanthidrite 154 67  
 Gretchen style 34 31  
 greyhound 70 24  
 grey scale 343 15  
 grey sea eagle 362 5  
 grid *Cotton Spin.* 163 26  
 grid *Water* 269 11  
 grid *Theatre* 316 4  
 grid hearth 139 1  
 gridiron 316 4  
 griffin 327 11  
 grill *Painter* 129 12  
 grill *Station* 204 38  
 grill *Fair* 308 33  
 grinder *Painter* 129 29  
 grinder *Metalwkr.* 140 18  
 grinder, continuous ~ 172 53, 66  
 grinder, pneumatic ~ 148 44  
 grinder chuck 157 46  
 grinding, hollow ~ 302 22  
 grinding cylinder 161 1  
 grinding disc 340 46  
 grinding machine 140 18  
 grinding machine, universal ~ 150 1  
 grinding machine bed 150 6  
 grinding machine table 150 7  
 grinding-roller bearing 163 41  
 grinding stone *Papern.* 172 71  
 grinding stone *Ethnol.* 354 24  
 grinding wheel *Dent.* 24 36  
 grinding wheel *D.I.Y.* 134 23  
 grinding wheel *Blacksm.* 137 19; 138 8  
 grinding wheel *Metalwkr.* 140 19  
 grinding wheel *Mach. Tools* 150 4  
 grinding wheel *Sawmill* 157 43  
 grindstone 172 71  
 grip *Photog.* 114 37

grip *Cine Film* 117 61  
 grip *Bicycle* 187 3  
 grip *Navig.* 224 9  
 grip *Rowing* 283 35  
 grip *Athletics* 298 45  
 grip *Winter Sp.* 301 6  
 grip *Sports* 305 57  
 grip *Films* 313 21  
 gripper 180 65  
 gripper bar 180 56  
 gripping jaw 149 36  
 grip sole 101 19  
 grist 92 42  
 grit guard 148 40  
 gritter, self-propelled ~ 200 41  
 grocer 98 41  
 grocer's shop 98 1-87  
 groceryman 98 41  
 grocery store 98 1-87  
 groin *Man* 16 38  
 groin *see* groyne  
 groin vault 335 31-32; 336 42  
 groom *Carriages* 186 27  
 groom *Church* 332 16  
 groove *Iron Foundry etc.* 148 59  
 groove *Sawmill* 157 6  
 groove *Ball Games* 291 29  
 groove *Winter Sp.* 301 39  
 groove *Music. Instr.* 326 13  
 groove *Art* 334 27  
 groove, anal ~ 16 41  
 grooving 157 6  
 groschen 252 13  
 Grottesque 342 7  
 grotto 272 1  
 ground 123 9  
 ground, fallow ~ 63 1  
 ground, icy ~ 304 19  
 ground avalanche 304 1  
 ground control 6 44  
 ground floor 37 2; 118 7  
 ground-floor landing 123 23  
 ground game 86 35  
 ground ivy 375 18  
 ground layer 7 7  
 ground nut 383 41  
 ground-nut oil 98 24  
 ground power unit 233 22  
 groundsheet ring 278 26  
 ground signals 288 52-54  
 ground state level 1 18  
 ground tackle 223 49-51  
 groundwater 12 21  
 groundwater level 269 1, 42, 63  
 groundwater stream 269 3  
 groundwood 172 68  
 groundwood mill 172 53-65  
 groundwood pulp 172 77, 78  
 group 260 3; 268 60  
 group instruction 242 1  
 group selector switch 238 42  
 grove 354 5  
 grower 55 20  
 grower, commercial ~ 55 20  
 growing stock 74 1  
 growler 186 26  
 growth, annual ~ 372 25  
 groyne *Phys. Geog.* 13 37

groyne *Rivers* 216 19  
 groyne head *Phys. Geog.* 13 38  
 groyne head *Rivers* 216 20  
 grub 58 64; 77 29; 81 20; 358 9; 80 6, 19, 36, 41, 46, 53, 54; 82 25, 36  
 grubber 55 21; 65 55  
 grub screw 143 48  
 Grus 3 42  
 G sharp minor 320 60  
 GT car 193 32  
 guanaco 366 30  
 guard *Blacksm.* 138 9  
 guard *Metalwkr.* 140 20  
 guard *Fencing* 294 35, 38, 43  
 guard, king's ~ 306 68  
 guard, protective ~ 168 45  
 guard board 118 29  
 guard cam 167 57  
 guard for V-belt drive 180 58  
 guard iron 210 34  
 guard netting 118 90  
 guard rail *Roof & Boilerr.* 38 28  
 guard rail *Agr. Mach.* 64 55  
 guard rail *Forestry* 84 8  
 guard rail *Floor etc. Constr.* 123 53  
 guard rail *Weaving* 165 31  
 guard rail *Railw.* 202 23  
 guard rail *Ship* 221 121  
 guard rail *Shipbuild.* 222 66  
 gudgeon pin 192 26  
 guelder rose 373 10  
 guest rope 227 14  
 gugelhupf 97 33  
 guide 23 21  
 guide, stationary ~ 243 21  
 guide bar *Cotton Spin.* 164 17  
 guide bar *Weaving* 165 38  
 guide bearing 113 14  
 guide block 174 48; 176 18  
 guide chain 65 13  
 guide-chain crossbar 65 12  
 guide dog 70 25  
 guide groove 217 75  
 guide notch 117 36  
 guide pin 243 21  
 guide post 15 110  
 guide rail *Weaving* 165 3  
 guide rail *Railw.* 214 56  
 guide rail *Store* 271 54  
 guide rod 200 27  
 guide roller *Sawmill* 157 5  
 guide roller *Cotton Spin.* 164 18  
 guide roller *Films* 312 29  
 guide step 117 36  
 guide tractor 141 19  
 guiding blade 322 40  
 guiding roller 312 29  
 guiding slot *Weaving* 165 11  
 guiding slot *Music. Instr.* 322 41  
 guild 252 19  
 guillemet 342 27  
 guillemot 359 13  
 guillotine *Plumb.* 125 26  
 guillotine *Bookbind.* 183 16; 185 1

guillotine cutter, automatic ~ 185 1  
 guinea fowl 73 27  
 guinea pig 366 12  
 guiro 324 60  
 guitar 318 8; 324 12, 73  
 guitarist 318 9  
 guitar player 318 9  
 gulden 252 19  
 gules 254 27  
 Gulf Stream 14 30  
 gull 359 14  
 gullet *Man* 17 49; 20 23, 40  
 gullet *Bees* 77 19  
 gullet *Forestry* 84 28  
 gull wing, inverted ~ 229 14  
 gully 12 44  
 gum 19 15  
 gun 218 50  
 gun, pneumatic ~ 94 3  
 gun, self-cocking ~ 87 23  
 gun, self-propelled ~ 255 57  
 gun barrel, rifled ~ 87 34  
 gun carriage 255 43  
 gun carriage, self-propelled ~ 255 49-74  
 gun dog 86 7  
 gunnel 283 30  
 gunport 218 59  
 gunport shutter 218 60  
 gun slit 86 52  
 gun turret 258 29  
 gunwale 283 30  
 gutta-percha tree 383 37  
 gutter *Dwellings* 37 6, 11  
 gutter *Roof & Boilerr.* 38 9  
 gutter *Roof* 122 28, 92  
 gutter *Bookbind.* 185 55  
 gutter *Street Sect.* 198 10  
 gutter, parallel ~ 122 83  
 gutter bracket 122 32  
 guy *Wine Grow.* 78 8  
 guy *Camping* 278 23  
 guy line 278 23  
 guy pole 152 31  
 guy wire *Wine Grow.* 78 8  
 guy wire *Energy Sources* 155 44  
 gybe 285 28  
 gybing 285 26  
 gymkhana 290 32  
 gymnastic ball 297 34  
 gymnastic club 297 38  
 gymnastic hoop 297 46  
 gymnastic ribbon 297 49  
 gymnastics 297 33-50  
 gymnastics, men's ~ 296 1-11  
 gymnastics, Olympic ~ 296 1-11; 297 1-6  
 gymnastics, women's ~ 297 1-11; 297 1-6  
 gymnastics apparatus 296 51-52  
 gym shoe 296 63; 297 52  
 gym trousers 296 62  
 gypsum *Sculpt. Studio* 339 29  
 gypsum *Crystals* 351 24, 25  
 gypsum crusher 160 14  
 gypsum powder 339 29  
 gypsum store 160 13

gyro compass 224 31, 51-53  
 gyro compass unit 224 51-53  
 gyrodyne 232 29  
 gyro horizon 230 3  
 gyro repeater 224 52

## H

habergeon 329 51  
 habit, monk's ~ 331 55  
 hack 186 26  
 hacking knife 128 37  
 hackney carriage 186 26  
 hackney coach 186 26  
 hacksaw 134 3, 17; 136 40; 138 23; 140 9; 150 14  
 hacksaw frame 126 71  
 haematite 108 48  
 haft 137 30  
 hail 9 36  
 hail, soft ~ 9 35  
 hair 16 3  
 hair, bobbed ~ 34 34  
 hair, closely-cropped ~ 34 11  
 hair, curled ~ 34 33  
 hair, curly ~ 34 18  
 hair, long ~ 34 1  
 hair, pinned-up ~ 34 28  
 hair, shingled ~ 34 34  
 hair, swept-back ~ 34 28  
 hair, swept-up ~ 34 28  
 hairbell 375 14  
 hairbrush 28 7; 105 10  
 haircap moss 377 17  
 hair clip 105 11  
 hair curler 106 31  
 haircut 106 3  
 haircuts 34 1-25  
 haircutting scissors 105 7; 106 34  
 hair decoration 355 82  
 hairdress 354 9  
 hairdresser 105 35; 106 1  
 'hairdresser' *Airport* 233 53  
 hairdresser, ladies' ~ 105  
 hairdresser, men's ~ 106  
 hairdresser's tools 105 1-16  
 hairdressing salon, ladies' ~ 105 1-39  
 hairdressing salon, men's ~ 106 1-42  
 hair drier, hand-held ~ 105 33; 106 22  
 hair element 10 9  
 hair-fixing spray 105 24  
 hair moss 377 17  
 hairpin *Needlewk.* 102 29  
 hairpin *Winter Sp.* 301 69  
 hairpin work 102 28  
 hair sieve 260 66  
 hair spray 105 24  
 hairstyle 106 3  
 hairstyles 34 1-25  
 hairstyles, girls' ~ 34 27-38  
 hairstyles, ladies' ~ 34 27-38  
 hairstylist 310 36; 315 48  
 hair tonic 106 10  
 hair trigger 87 12  
 hairworm 80 51  
 hake 65 19

hake chain 65 17  
 half-barrier crossing 202 45  
 half chicken 266 56  
 half mask 306 13  
 half-moon 4 4, 6  
 half nonpareil 175 20  
 half note 320 14  
 half nut 149 19  
 half rest 320 22  
 half-step 320 50, 52  
 half-title 185 43, 44  
 halftone dot 178 39  
 half-way line 291 3  
 hall 41 1-29  
 hall, main ~ 236 1-30; 250 1-11  
 halliard 253 2  
 hall manager 275 7  
 hall mirror 41 6  
 hall of mirrors 308 55  
 Hallstatt period 328 21-40  
 hallux 19 52  
 halma 276 26-28  
 halma board 276 26  
 halma man 276 28  
 halma piece 276 28  
 halogen lamp 177 31  
 halothane container 26 26  
 halt 15 27  
 halter 71 7-11  
 halter top 31 64  
 halved joint 121 86  
 halving joint 121 86  
 halyard 253 2  
 ham 95 51  
 hame 71 14  
 hammer 85 5; 126 78; 134 7; 137 26; 139 26  
 hammer *Army* 255 4  
 hammer *Athletics* 298 42  
 hammer *Music. Instr.* 322 35; 325 3  
 hammer *Graphic Art* 340 14  
 hammer, anvil and stirrup 17 61  
 hammer, bricklayer's ~ 118 53  
 hammer, brickmason's ~ 118 53  
 hammer, carpenter's ~ 120 74  
 hammer, flat-face ~ 137 35  
 hammer, glazier's ~ 124 18  
 hammer, iron-headed ~ 339 16  
 hammer, machinist's ~ *D.I.Y.* 134 40  
 hammer, machinist's ~ *Metalwkr.* 140 23  
 hammer, shoemaker's ~ 100 37  
 hammer, stonemason's ~ 158 35  
 Hammer and Sickle 253 21  
 hammer axe 300 37  
 hammer blow 293 78  
 hammer crusher *Quarry* 158 20  
 hammer crusher *Cement Wks.* 160 2  
 hammer cylinder 139 30  
 hammer drill 158 11



hammer drill, electric ~ 134 43  
 hammer forging 139  
 hammer guide 139 29  
 hammer head *Airsports* 288 4  
 hammer head *Athletics* 298 43  
 hammer head, felt-covered ~ 325 24  
 hammer jack 325 30  
 hammer lever 325 30  
 hammer mill 160 2  
 hammer rail 325 15, 26  
 hammer shank 325 25  
 hammer throw 298 42-47  
 hammock 278 4  
 ham on the bone 96 1; 99 52  
 hamper 306 11  
 hamster 366 16  
 hand 16 47, 48; 17 15-17; 19 64-83  
 hand apparatus 297 33-50  
 hand axe 328 1  
 handball 292 1  
 handball player 292 2  
 hand bindery 183 1-38  
 handbook 262 17  
 hand bookbinding 183 1-38  
 hand brace 140 13  
 hand brake 187 5; 191 72; 212 33  
 hand brake lever 188 33; 191 93  
 hand brake wheel 212 64, 80  
 hand camera, large-format ~ 114 36  
 handcart 120 6  
 handcart, wooden ~ 309 86  
 hand circle 297 47  
 hand circling 297 37  
 handclap 117 69  
 hand-composing room 174 1  
 hand compositor 174 5  
 hand control 195 8  
 hand cream 99 27  
 hand cultivator 55 21  
 hand die 126 85  
 hand die, electric ~ 125 12  
 hand drill 140 13  
 hand flat knitting machine 167 35  
 hand gallop 72 42  
 hand glass *Hairdresser* 105 23; 106 7  
 hand glass *Optics* 111 16  
 handgrip *Photog.* 114 37  
 handgrip *Cine Film* 117 5, 61  
 handgrip *Bicycle* 187 3  
 handgrip *Navig.* 224 9  
 handgrip *Films* 313 21, 24, 38  
 hand guard 94 10  
 hand hair drier 105 33; 106 22  
 hand hammer, blacksmith's 137 23  
 hand harpoon 280 40  
 handcraft 48 3  
 hand-ironing pad 104 30  
 hand-iron press 103 18  
 handkerchief 33 10  
 hand ladle 148 23  
 hand lamp 270 42  
 hand lance 83 46  
 handle *Atom* 2 39  
 handle *Hosp.* 26 12  
 handle *Infant Care etc.* 28 50  
 handle *Tablew. etc.* 45 51, 59, 62  
 handle *Household* 50 9, 63  
 handle *Market Gdn.* 55 27  
 handle *Agr. Mach.* 65 2  
 handle *Agr. Impl.* 66 17  
 handle *Pest Contr.* 83 19  
 handle *Forestry* 85 3  
 handle *Hairdresser* 106 37  
 handle *Joiner* 132 10, 18  
 handle *D.I.Y.* 134 47  
 handle *Metalwkr.* 140 5  
 handle *Carriages* 186 12  
 handle *School* 260 8  
 handle *Motorboats etc.* 286 48  
 handle *Fencing* 294 41  
 handle *Athletics* 298 44  
 handle *Sports* 305 57, 80  
 handle, bound ~ 89 55  
 handle, cork ~ 89 50  
 handle, double ~ 148 15  
 handle, fixed ~ 129 7  
 handle, insulated ~ 127 54  
 handle, tubular ~ 50 64  
 hand lead 224 58  
 handlebar 187 2; 188 45  
 handlebar, adjustable ~ 188 3  
 handlebar, semi-rise ~ 188 11  
 handlebar fittings 188 30-35  
 handlebar grip 187 3  
 handlebar moustache 34 8  
 handlebars 34 8  
 handlebar stem 187 10  
 handler 264 5  
 hand lever *Joiner* 132 55  
 hand lever *Bookbind.* 183 31  
 hand-lever press 183 26  
 hand luggage 194 19  
 hand mirror *Hairdresser* 105 23; 106 7  
 hand mirror *Optics* 111 16  
 hand net 89 2  
 handpiece 24 6  
 hand press 340 29  
 hand pump 83 26; 269 66  
 hand puppet 260 74  
 handrail *Roof & Boilerr.* 38 28  
 handrail *Hall* 41 23  
 handrail *Floor etc. Constr.* 123 53, 79  
 handrail *Ship* 221 122  
 handrailing 215 70  
 hand rammer 148 32  
 hand-removing tool 109 10  
 handrest 112 58  
 hand sail 302 28  
 hand saw 120 60; 126 72; 134 27  
 handscrew 132 14  
 handset 237 7; 245 15  
 handset cord 237 14  
 handset cradle 237 13  
 hand-setting room 174 1  
 hand shank 148 14  
 hand shears *Tailor* 104 11  
 hand shears *Bldg. Site* 119 87

hand signal 268 33  
 handsledge 304 29  
 hand spray *Pest Contr.* 83 24  
 hand spray *Hairdresser* 105 30; 106 13  
 hand spray *Painter* 129 35  
 hand spray *Offset Platem.* 179 7  
 handspring 297 22  
 handstamp 236 45  
 handstand 295 27; 296 52  
 handstand dive 282 45  
 hand steel shears 119 22  
 handstrap, leather ~ 296 47  
 hand-to-hand throw 297 33  
 hand towel 28 9; 49 23; 106 24  
 hand vice 140 24  
 hand weapons 255 1-39  
 handwheel *Shoem.* 100 24  
 handwheel *Cooper* 130 19  
 handwheel *Cotton Spin.* 163 18  
 handwheel *Knitting* 167 7, 30  
 handwheel *Paperm.* 172 74  
 handwheel *Bookbind.* 183 23  
 handwheel *Road Constr.* 201 9  
 handwriting, English ~ 342 10  
 handwriting, German ~ 342 11  
 hang 296 33, 35; 298 41  
 hangar 287 14  
 hanger 215 41  
 hang glider 287 44  
 hang glider pilot 287 45  
 hang gliding 287 43  
 Hansa cog 218 18-26  
 Hansa ship 218 18-26  
 hansom 186 29  
 hansom cab 186 29  
 harbour 216 14; 225; 226  
 harbour ferry 225 11  
 harbour tunnel 225 55  
 hardboard 338 22  
 hardcore 123 12  
 hardener 130 33  
 hardie 137 32  
 hard-rock drill 158 11  
 hard-top 193 26  
 hardwood cutting 54 25  
 hardy 137 32  
 hare 86 35; 88 59  
 hare-and-hounds 289 41-49  
 harebell 375 14  
 hare call 87 44  
 hare hunting 86 34-39  
 harlequin 306 35  
 harmonica 324 35  
 harmonium 325 43  
 harmonium case 325 47  
 harmonium keyboard 325 48  
 harness *Horse* 71 7-25  
 harness *Airsports* 288 43  
 harness horse racing 289 23-40  
 harness of diving apparatus 279 12  
 harness racing 289 23-40  
 harness racing track 289 23  
 harp 323 60

harpoon 353 10  
 harpoon, bone ~ 328 3  
 harpoon thrower 328 5  
 harpsichord 322 45  
 harpsichord mechanism 322 48  
 harpy 254 35; 327 55  
 harrow, disc ~ 65 82  
 harrow, rotary ~ 65 89  
 harrow, spike-tooth ~ 65 88, 89  
 harrow, three-section ~ 65 88, 89  
 hasp 71 14  
 hat 35 9  
 hat, Alpine ~ 35 23  
 hat, felt ~ 35 15, 24; 355 55  
 hat, fox ~ 35 19  
 hat, hard ~ 289 18  
 hat, huntsman's ~ 86 5  
 hat, iron ~ 329 59  
 hat, knitted ~ 35 10  
 hat, ladies' ~ 41 11  
 hat, lightweight ~ 35 37  
 hat, loden ~ 35 23  
 hat, men's ~ 35 13  
 hat, mink ~ 35 18  
 hat, mohair ~ 35 6, 11  
 hat, paper ~ 306 45  
 hat, picador's ~ 319 20  
 hat, sailor's ~ 309 63  
 hat, Thessalonian ~ 355 4  
 hat, three-cornered ~ 355 62  
 hat, trilby-style ~ 35 14  
 hat, Tyrolean ~ 35 24  
 hat, wide-brimmed ~ 35 38; 355 55  
 hat, woollen ~ 29 57; 35 10, 26  
 hat and light luggage rack 208 28  
 hat box 205 11  
 hatch *Roof & Boilerr.* 38 14  
 hatch *Roof* 122 24  
 hatch *Post* 236 30  
 hatchback 193 18  
 hatchboard 222 65  
 hatch coaming 222 64  
 hatch cover 222 65  
 hatcher 74 30  
 hatchery 89 11-19  
 hatchet 270 43  
 hatchet iron 125 5  
 hatching compartment 74 30  
 hatching jar 89 17  
 hatching tray 74 31, 32  
 hatchment 254 1-6  
 hatch platform 6 34  
 hatchway 222 64-65  
 hatchway, main ~ 259 86  
 H atom 1 26  
 hat peg 266 13  
 hats, ladies' ~ 35 1-21  
 hats, men's ~ 35 22-40  
 hat shop 268 38  
 hatter's shop 268 38  
 haubergeon 329 51  
 haulage *Forestry* 85 42  
 haulage *Rivers* 216 27  
 haulage cable *Railw.* 214 14, 26, 37, 42, 45

haulage cable *Winter Sp.* 301 63  
 haulage cable driving pulley 214 62  
 haulage cable guide wheel 214 61  
 haulage cable roller 214 32, 49, 60  
 haulage cable sleeve 214 73  
 hauling 216 27  
 hauling capstan 217 22  
 haulm conveyor 64 76  
 haulm conveyor agitator 64 77  
 haulm conveyor drive 64 78  
 haulm elevator 64 90  
 haulm stripper 64 73  
 haulm stripper, flexible ~ 64 76  
 haulyard 253 2  
 haunch *Horse* 72 35  
 haunch *Game* 88 21, 37  
 haunch jump 282 14  
 Hauptwerk 326 1, 43  
 hautboy 323 38  
 haute école 71 1-6  
 Havana cigar 107 2  
 Hawaii girl 306 16  
 hawk, male ~ 86 46  
 hawkbells 276 45  
 hawk 308 12, 51  
 hawking 86 42-46  
 hawkmoth 82 27; 358 55; 365 9  
 hawkbill turtle 364 28  
 hawse 222 75  
 hawse hole 227 11  
 hawse pipe 222 76; 258 54  
 hawthorn 374 30  
 hay 75 13  
 hay, tedded ~ 63 25  
 hay fork, three-pronged ~ 66 3  
 hay harvest 63 19-30  
 haymaking 63 19-30  
 hay rack, double ~ 75 12  
 hayrake 66 23  
 hay tripod 63 30  
 hazard flasher 191 76  
 hazard flasher switch 191 68  
 hazel 59 49  
 hazel branch, flowering ~ 59 44  
 hazel bush 59 44-51  
 hazel grouse 88 69  
 hazel hen 88 69  
 hazel leaf 59 51  
 hazelnut 59 49  
 hazel tree 59 44-51  
 H-beam 143 6  
 head *Man* 16 1-18; 17 42-55  
 head *Arable Crops* 68 2  
 head *Horse* 72 1-11  
 head *House Insects etc.* 81 33, 36  
 head *Forest Pests* 82 2  
 head *Game* 88 12  
 head *Brew.* 93 31  
 head *Tobacc. etc.* 107 23  
 head *Carp.* 120 58  
 head *Roof* 122 87

head *Mach. Parts etc.* 143 14, 52  
 head *Weaves* 171 31  
 head *Composing Rm.* 175 39  
 head *Hydr. Eng.* 217 25  
 head *Restaurant* 266 4  
 head *Music. Instr.* 323 52; 324 10  
 head *Prehist.* 328 4  
 head *Articulates* 358 28  
 head, bald ~ 34 22  
 head, binocular ~ 112 12  
 head, cock's ~ 327 35  
 head, combined ~ 241 59  
 head, composite ~ 370 74  
 head, countersunk ~ 143 46  
 head, eagle's ~ 327 12  
 head, goat's ~ 327 18  
 head, human ~ 327 21  
 head, lion's ~ 327 17  
 head, partly bald ~ 34 20  
 head, pig's ~ 95 43  
 head, rotating ~ 64 52  
 head, shrunken ~ 352 30  
 head, woman's ~ 327 56  
 head and neck 19 1-13  
 head badge 187 15  
 headband 183 35  
 headband, padded ~ 241 67; 261 41  
 head bandage 21 3  
 head beam 183 21  
 headboard *Bedrm.* 43 6  
 headboard *Sailing* 284 47  
 headbox 173 11  
 head cellarman 79 17  
 headcheese 96 9  
 headdress 354 9; 355 65  
 headdress, feather ~ 352 12  
 headdress, ornamental ~ 352 12  
 head drum 243 19, 27  
 header *Carp.* 120 41  
 header *Roof* 121 71  
 header *Ball Games* 291 46  
 header joist 120 41  
 header tank 212 78  
 head frame 144 3  
 headgear 35; 144 1; 302 34  
 headguard 299 30  
 heading 130 10  
 heading bond 118 60  
 heading course 118 64  
 head interlocking point 171 34  
 headlamp 187 7; 189 10; 191 20  
 headlight 189 10; 191 20  
 head line *Man* 19 73  
 headline *Sea Fish.* 90 7  
 headline *Script* 342 44  
 head margin 185 56  
 head of department 271 60  
 head of railcar 197 3  
 headphone cable 241 71  
 headphone cable plug 241 70  
 headphone cord 241 71  
 headphones 241 66; 249 63; 261 38; 309 24  
 headphone socket 117 10; 249 68



headpiece 71 7-11  
 head piece 183 21  
 headpiece, padded ~ 241 67;  
 261 41  
 head post 123 54  
 headrace 91 41  
 head rail 120 58  
 headrest *First Aid* 21 13  
 headrest *Railw.* 207 67  
 headrest, adjustable ~ 191 33;  
 207 47  
 headrest, integral ~ 193 31  
 headrest cushion, down-  
 filled ~ 207 68  
 head restraint, adjustable ~  
 191 33  
 head restraint, integral ~ 193  
 31  
 headset 241 66; 249 63; 261  
 38; 309 24  
 headset socket 249 68  
 headspring 297 27  
 headstall 71 7-11  
 headstand 295 28  
 headstock 150 2  
 headstock, geared ~ 149 2  
 headstock, movable ~ 150 26  
 headstone 331 26  
 head support assembly 311 25  
 heald, wire ~ 166 27  
 heald eyelet 166 28  
 heald frame 166 4  
 heald frame guide 166 3  
 heald shaft 166 4  
 heald shaft guide 166 3  
 heald shaft guiding wheel 166  
 36  
 health insurance certificate  
 22 9  
 heap cloud 8 1, 2, 17; 287 22  
 heart 18 14; 20 8, 24-25,  
 45-57  
 heart cherry 59 5  
 hearth *Blacksm.* 137 1-8, 1;  
 138 34  
 hearth *Iron & Steel* 147 24  
 heart line 19 74  
 heart plank 120 93  
 heart rhythm 25 1  
 hearts 276 40, 44  
 heartsease pansy 60 2  
 heart-shield 254 17  
 heartwood *Carp.* 120 84  
 heartwood *Bot.* 370 13  
 heartwood plank 120 93  
 heat 1 55  
 heat colour 343 16  
 heater 172 32  
 heater, electric ~ 174 45; 179  
 3  
 heater, gas ~ 126 25  
 heater, water-controlled ~  
 192 60-64  
 heater box 192 61  
 heater plug 190 55  
 heat exchanger *Nucl. Energy*  
 154 6, 44  
 heat exchanger *Coking* 156  
 27  
 heat exchanger *Cement Wks.*  
 160 4, 6

heat exchanger *Paperm.* 172  
 19  
 heat exchanger *Car* 192 61  
 heat exchanger *Railw.* 207 6;  
 209 15; 212 36, 55  
 heat exchanger *Warships* 259  
 66  
 heat exchanger, auxiliary ~  
 212 43  
 heat exchanger exhaust 160 7  
 heat extractor 182 5  
 heath 15 5  
 heath and moor 15 5  
 heather 377 19  
 heating, underfloor ~ 356 18  
 heating box 183 27  
 heating coupling hose 208 20  
 heating element 172 32  
 heating engineer 126  
 heating oil 38 50  
 heating oil tank 212 75  
 heating pipe 55 8  
 heating regulator 207 54  
 heating system 207 6  
 heating system, hot-water ~  
 38 38-81  
 heating unit, electric ~ 174 45  
 heat pump 155 22  
 heat pump system 155 1  
 heat reservoir 155 20  
 heat-sealing machine 76 27;  
 226 12  
 heat shield *Motorcycles etc.*  
 188 16  
 heat shield *Space* 234 5, 20;  
 235 8, 40  
 heat space 259 93  
 heat transfer fluid 155 31  
 heaume 254 7  
 Heaviside-Kennelly Layer 7  
 27  
 heavy-duty boot 101 39  
 heavy liquor pump 172 34  
 heavy vehicle elevator 221 56  
 heavy vehicle lift 221 56  
 heckelphone 323 38  
 heckler 263 15  
 heddle, wire ~ 166 27  
 heddle eyelet 166 28  
 hedge *Map* 15 98  
 hedge *Dwellings* 37 59  
 hedge *Fruit & Veg. Gdn.* 52 32  
 hedge, trimmed ~ 272 37  
 hedgehog 366 5  
 hedgehog fungus 381 31  
 hedge mustard 61 16  
 hedge shears 56 49  
 hedge trimmer 134 55  
 hedge trimmer, battery-  
 operated ~ 56 17  
 hedge-trimming attachment  
 134 55  
 heel *Man* 19 63  
 heel *Agr. Impl.* 66 15  
 heel *Bakery* 97 5  
 heel *Shoem.* 100 67  
 heel, high ~ 101 28  
 heel, raised ~ 101 33  
 heelbone 17 27  
 heel flap 286 58  
 heel trimmer 100 4

heel unit, automatic ~ 301 54  
 height adjuster 106 17  
 height-adjuster bar 106 17  
 height adjustment *Hosp.* 27 3  
 height adjustment *Photog.*  
 116 34  
 height adjustment *Sawmill*  
 157 49  
 height adjustment crank 64  
 57  
 height adjustment wheel 132  
 60  
 height and angle adjustment  
 177 21  
 height gauge 22 69  
 height of shank 175 45  
 height of shoulder 175 45  
 height scale *Sawmill* 157 60  
 height scale *Athletics* 298 20  
 height to paper 175 44  
 helicon 323 44  
 helicopter deck 146 7  
 helicopter hangar 221 52; 259  
 38  
 helicopter landing deck 228  
 15  
 helicopter landing platform  
 259 39, 53  
 helicopter platform 221 19  
 helicopters 232 11-25  
 heliostat 5 29  
 heliozoan 357 7  
 heliport 146 7  
 heliport deck 146 7  
 helium atom (model) 1 5  
 helium-neon laser 243 57  
 helium nucleus 1 30-31  
 helium pressure bottle 234 14  
 helium pressure vessel 234  
 43, 50  
 heller 252 27  
 hellhound 327 29  
 helm 218 13  
 helmet *Police* 264 35  
 helmet *Equest.* 289 18  
 helmet *Ball Games* 292 24  
 helmet *Chivalry* 329 39-42  
 helmet, barred ~ 254 8  
 helmet, fireman's ~ 270 38  
 helmet, grilled ~ 254 8  
 helmet, protective ~ *Police*  
 264 21  
 helmet, protective ~  
*Mountain.* 300 53  
 helmet, protective ~ *Winter*  
*Sp.* 302 34  
 helmet affronty 254 9  
 helmet flower 379 1  
 helmet lamp 300 54  
 helmets 254 4, 7-9  
 helms 254 4, 7-9  
 helmsman 224 16  
 helper 21 19  
 helve 85 3  
 hemidemisemi-quaver 320 19  
 hemidemisemi-quaver rest  
 320 27  
 hemihedron 351 24  
 hemipyramid 351 24  
 hemisphere, northern ~ 3  
 1-35

hemline marker 271 40  
 hemlock 379 4  
 hemp 383 9  
 hem stitch work 102 14  
 hen 62 36; 73 19  
 hen, fattened ~ 98 7  
 henbane 379 6  
 hen pheasant 88 77  
 herald 329 75  
 heraldic beasts 254 15-16  
 heraldry 254 1-36  
 herb, primulaceous ~ 53 5  
 herb, solanaceous ~ 53 6; 379  
 7  
 Hercules 3 21  
 herd 86 15  
 Herdsman 3 30  
 Herero woman 354 25  
 herm 334 35  
 herma 334 35  
 hermes 334 35  
 heron 86 46; 359 18  
 herring 364 14  
 herringbone 301 26  
 herringbone stitch 102 9  
 herring drift net 90 2-10  
 herring lugger 90 1  
 Hessian fly 80 40  
 Heterocera 365 7-11  
 hexagon 351 15  
 hexagonal crystal system 351  
 20-22  
 hexahedron 351 2  
 hexakis-octahedron 351 13  
 hexoctahedron 351 13  
 H-girder 143 6  
 hibernation cocoon 80 31  
 hide 88 56  
 hide, raised ~ 86 14-17, 14  
 hide beetle 81 22  
 hieroglyphics, ancient  
 Egyptian ~ 341 1  
 Hi-Fi component 241 13-48  
 high 9 6  
 high-altitude anorak 300 6  
 highball 317 33  
 highball glass 267 56  
 high bar *Playground* 273 32  
 high bar *Gymn.* 296 7  
 highboard diver 282 5  
 highboard diving 282 40-45  
 high chair, baby's ~ 28 33  
 high-draft draw frame 164 14  
 high-draft speed frame 164  
 19  
 high-draft system 164 14  
 high frequency 7 26  
 high-hat cymbals 324 50  
 high house 305 75  
 high jump 298 9-27  
 high jump apparatus 298 32  
 high jump equipment 298 32  
 high jumper 298 10  
 highland Indian 352 23  
 high-moor bog 13 19  
 high-mountain region 12  
 39-47  
 high performance sailplane  
 287 9  
 high-pile lining 101 3  
 high-pressure area 9 6

high-pressure belt 9 47  
 high-pressure manometer  
 141 4  
 high-pressure xenon arc  
 lamp 312 39  
 high-rise handlebar 188 57  
 high-riser 188 56  
 high school 261  
 high school riding 71 1-6  
 high seat 86 14  
 high-speed plate, automatic ~  
 39 15  
 high-tension voltage  
 indicator 211 29  
 high tide 280 7  
 high toss 297 35  
 high-water line 13 35  
 high-water mark 13 35  
 highway construction 201  
 1-24  
 hiking boot 101 18  
 hiking stick 284 31  
 hiking strap 284 30  
 hill *Phys. Geog.* 13 66  
 hill *Ball Games* 293 79-82, 87  
 hole, elongated ~ 240 17  
 hole, square ~ 140 43  
 hollowing tool 135 17  
 hollow of the throat 16 20  
 hollow-shaft boring bit 133  
 7  
 holly 374 9  
 holohedron 351 2  
 holster 264 24  
 Holy Bible 330 11  
 Holy Communion 332 26  
 Holy Scripture 330 11  
 holy table 330 4  
 holy water basin 332 47  
 home and overseas news  
 section 342 62  
 home base 292 53  
 home plate 292 53  
 home port 286 8  
 homogenizer 76 12  
 homopteran 358 3  
 honey 77 33  
 honey, strained ~ 77 62-63  
 honey bag 77 18  
 honey-bee 77 1-25  
 honey cell 77 33  
 honeycomb 77 31-43, 45  
 honeycomb, artificial ~ 77 42  
 honeycomb, natural ~ 77 60  
 honeycomb weave 171 29  
 honeydew melon 266 50  
 honey extractor 77 61  
 honey fungus 381 28  
 honey gland 59 18  
 honey in the comb 77 64  
 honey jar 77 63  
 honey pail 77 62  
 honey sac 77 18  
 honey separator 77 61  
 honeysuckle 374 13  
 honey super 77 45  
 honey wrack 378 48  
 hood *Infant Care etc.* 28 26  
 hood *Child. Clothes* 29 2  
 hood *Ladies' Wear* 30 69  
 hood *Headgear* 35 2  
 hood *Blacksm.* 137 7  
 hogpen 62 8; 75 35

hoist *Oil, Petr.* 145 11  
 hoist *Flags* 253 22-34  
 hoist, builder's ~ 118 31  
 hoist, inclined ~ 158 16; 159  
 5  
 hoisting gear 206 56; 217 74  
 hoisting gear bridge 217 73  
 hoisting gear cabin 217 71  
 hoisting rope 120 37  
 hold 223 55, 75  
 hold, insulated ~ 223 56  
 hold, underfloor ~ 231 21  
 hold-down, automatic ~ 157  
 65  
 holdfast *Carp.* 120 66  
 holdfast *Alp. Plants etc.* 378  
 50  
 holding device 157 47  
 holding forceps 23 12  
 holding press 183 4  
 holding squad 270 17  
 hold pillar 222 61  
 hole *Phys. Geog.* 13 34  
 hole *Ball Games* 293 79-82, 87  
 hole, elongated ~ 240 17  
 hole, square ~ 140 43  
 hollowing tool 135 17  
 hollow of the throat 16 20  
 hollow-shaft boring bit 133  
 7  
 holly 374 9  
 holohedron 351 2  
 holster 264 24  
 Holy Bible 330 11  
 Holy Communion 332 26  
 Holy Scripture 330 11  
 holy table 330 4  
 holy water basin 332 47  
 home and overseas news  
 section 342 62  
 home base 292 53  
 home plate 292 53  
 home port 286 8  
 homogenizer 76 12  
 homopteran 358 3  
 honey 77 33  
 honey, strained ~ 77 62-63  
 honey bag 77 18  
 honey-bee 77 1-25  
 honey cell 77 33  
 honeycomb 77 31-43, 45  
 honeycomb, artificial ~ 77 42  
 honeycomb, natural ~ 77 60  
 honeycomb weave 171 29  
 honeydew melon 266 50  
 honey extractor 77 61  
 honey fungus 381 28  
 honey gland 59 18  
 honey in the comb 77 64  
 honey jar 77 63  
 honey pail 77 62  
 honey sac 77 18  
 honey separator 77 61  
 honeysuckle 374 13  
 honey super 77 45  
 honey wrack 378 48  
 hood *Infant Care etc.* 28 26  
 hood *Child. Clothes* 29 2  
 hood *Ladies' Wear* 30 69  
 hood *Headgear* 35 2  
 hood *Blacksm.* 137 7



hood *Carriages* 186 42  
 hood *Car* 191 8  
 hood *Garage* 195 36  
 hood *Aircraft* 230 39  
 hood *Mountain* 300 19  
 hood *Church* 331 56  
 hood, collapsible ~ 186 52;  
 193 10  
 hood, convertible ~ 193 10  
 hood, detachable ~ 31 21  
 hood, falcon's ~ 86 44  
 hood, folding ~ 28 35  
 hood, protective ~ 157 65  
 hood drawstring 29 64  
 hood support 195 37  
 hoof *Horse* 72 26  
 hoof *Game* 88 24  
 hoof, horse's ~ 327 42  
 hoofprints 86 8  
 hook *Roof & Boilerr.* 38 22  
 hook *Horse* 71 14  
 hook *Shoem.* 100 62  
 hook *Oil, Petr.* 145 9  
 hook *Sports* 299 33  
 hook *Winter Sp.* 301 61  
 hook *Sports* 305 18, 46  
 hook *Music. Not.* 320 5  
 hook, blunt ~ 26 50  
 hook, butcher's ~ 96 55  
 hook, closed ~ 89 85  
 hook, concealed ~ 89 75  
 hook, double ~ 89 83  
 hook, open ~ 89 83  
 hook, treble ~ 89 85  
 hookah 107 42  
 hook-and-ride band 140 50  
 hook ball 305 18  
 hook belt 270 44  
 hook disgorging 89 40  
 hook ladder 270 16  
 hooks 89 79-87  
 hoop *Airsports* 288 67  
 hoop *Ball Games* 292 78  
 hoop *Circus* 307 58  
 hoopoe 359 25  
 hoop of barrel 130 8  
 hooter *Motorcycles etc.* 188 53  
 hooter *Fire Brig.* 270 7  
 hop boiler 92 52  
 hop garden 15 114  
 hop growing 83 27  
 hopper *Agr. Mach.* 64 59  
 hopper *Wine Grow.* 78 18  
 hopper *Mills* 91 13  
 hopper *Cotton Spin.* 163 31  
 hopper *Music. Instr.* 325 30  
 hopper, endless-floor ~ 64  
 84  
 hopper barge 226 46  
 hopper delivery roller,  
 wooden ~ 163 32  
 hopper feeder 163 33  
 hopsack weave 171 11  
 horizon 13 21  
 horizon, artificial ~ 230 3  
 horizon glass 224 7  
 horizon light 316 15  
 horizon mirror 224 7  
 horizontal bar 296 7  
 horizontal boring and milling  
 machine 150 25

horizontal deflection module  
 240 10  
 horizontal eight 288 2  
 horizontal linearity control  
 module 240 9  
 horizontally-opposed twin  
 engine 189 47  
 horizontal milling spindle  
 150 39  
 horizontal piano 325 40  
 horizontal slow roll 288 8  
 horizontal synchronizing  
 module 240 7  
 horn *Horse* 71 38  
 horn *Motorcycles etc.* 188 53  
 horn *Car* 191 60  
 horn *Railw.* 212 70  
 horn *Fire Brig.* 270 7  
 horn *Flea Market* 309 34  
 horn *Music. Instr.* 323 41  
 horn *Invertebr.* 357 31  
 horn *Birds* 362 16  
 horn, spirally twisted ~ 327 8  
 hornbeam 371 63  
 horned owl 362 14  
 horns 88 29-31  
 horse *Horse* 71; 72  
 horse *Dom. Anim.* 73 2  
 horse *Carp.* 120 18  
 horse *Gymn.* 296 1; 297 1  
 horse, armoured ~ 319 18  
 horse, piebald ~ 289 29  
 horse, toy ~ 47 15  
 horse, wild ~ 328 7  
 horse, winged ~ 327 26  
 horse armour 329 83-88  
 horse bean 69 15  
 horse box 75 2  
 horse brush 71 55  
 horse chestnut 371 60  
 horse chestnut tree 371 58  
 horsefish 364 18  
 horsehair 323 15  
 horsehair brush 100 12  
 horse latitudes 9 47  
 horsemanship 289  
 horse racing 289 50  
 horse-radish 57 20  
 horse's head 72 1-11  
 horseshoe *Game* 88 71  
 horseshoe *School* 260 1  
 horseshoe arch 336 30  
 horseshoe grip 298 53  
 horseshoe marking 88 71  
 horseshoe mount 113 25  
 horseshoe mounting *Astron.*  
 59  
 horseshoe mounting *Optic.*  
*Instr.* 113 25  
 horse sleigh 304 25  
 horse stall 75 2  
 horsetail 376 18  
 horst 12 10  
 hose *Household* 50 75  
 hose *Bldg. Site* 118 38  
 hose *Serv. Stat.* 196 2; 196 23  
 hose *Fire Brig.* 270 54  
 hose *Hist. Cost.* 355 47  
 hose, rotary ~ 145 13  
 hose carriage 270 28  
 hose cart 270 28

hose connection 83 30  
 hose connector 56 45  
 hose coupling 270 29  
 hose layer 270 53  
 hosepipe 118 38; 196 23  
 hose reel 56 26; 270 28  
 hose truck 270 28  
 hose wagon 270 28  
 hosiery 271 56  
 hosiery department 271 17  
 hosiery mill 167 1-66  
 hosiery shelf 99 25  
 hospital 25; 26; 27  
 hospital bed 25 10  
 hospital unit 228 21  
 Host 331 48; 332 28, 35  
 hostess 318 33  
 hot-air duct 139 52  
 hot-air gun 130 25  
 hot-air sterilizer 22 71  
 hotbed 55 16  
 hotbed vent 55 17  
 hot-blast pipe 147 19  
 hot-blast stove 147 15  
 hot dog 308 34  
 hot-dog stand 308 32  
 hotel 267  
 hotel bar 267 51  
 hotel bill 267 11  
 hotel guest 267 14  
 hotel lobby 267 18-26  
 hotel manager 267 19  
 hotel porter 204 17  
 hotel register 267 8  
 hotel restaurant 267 20  
 hotel room 267 27-38  
 hotel sticker 205 9  
 hothouse 55 4; 272 65  
 hot-metal receiver, tilting-  
 type ~ 148 5  
 hot-pipe space 259 93  
 hotplate 39 15; 207 30  
 hotplate, electric ~ 45 45  
 hot reservoir 155 20  
 hot-shoe contact 114 72  
 hot-shoe flash contact 115 21  
 hot tap 126 28  
 hot water supply 155 26  
 hot water tank 38 68  
 hot water tank *Brew.* 92 10  
 hot water tank *Paperm.* 172  
 18  
 hound *Hunt.* 86 33  
 hound *Sailing* 284 14  
 hour and minute button 110 3  
 hour axis 5 8  
 hour axis drive 5 7  
 hourglass 110 31  
 hour hand 110 13  
 house *Dwellings* 37 54  
 house *Farm Bldgs.* 62 1  
 house *Bldg. Site* 118 1-49  
 house, detached ~ 37 1-53  
 house, dikereeve's ~ 216 45  
 house, duplex ~ 37 64-68  
 house, ferryman's ~ 216 45  
 house, semi-detached ~ 37  
 69-71  
 house, solar ~ 155 17  
 house, solar-heated ~ 155 17  
 house, terraced ~ 37 58-63

house, timber ~ 37 84-86  
 houseboat 353 31  
 house cat 62 3  
 housecoat *Underwear etc.* 32  
 20  
 housecoat *Hist. Cost.* 355 66  
 house cricket 81 7  
 house detective 275 16  
 house dress 31 36  
 housefly 81 1, 2  
 house frock 31 36  
 household appliances 50  
 household utensils 50  
 house insects 81 1-14  
 houseleek 51 7  
 house light dimmer 312 17  
 houseplant 42 36; 248 14  
 houseplants 53  
 house sparrow 361 5  
 house spider 81 9  
 house telephone 127 3  
 house wall 120 29  
 housewife 39 1  
 housing *Meteorol. Instr.* 10 18  
 housing *Iron Foundry etc.* 148  
 57  
 housing *Films* 312 48  
 housing, protective ~ 10 39  
 housing, soundproof ~ 310  
 48; 313 16-18, 27  
 housing development 37  
 54-57  
 housing estate 37 54-57  
 housing lock 313 33  
 hover 74 3  
 hovercraft 286 63  
 hub 187 26  
 hub, centre ~ 187 59  
 hub, front ~ 187 52  
 hub assembly, front ~ 187 52  
 hub barrel 187 69  
 hub body 187 69  
 hub shell 187 69  
 huckleberry 377 23  
 hula-hula girl 306 16  
 hula skirt 306 18  
 hull *Aircraft* 232 2, 9  
 hull *Warships* 258 2; 259 22,  
 42  
 hull bottom 286 32, 35, 39  
 hull frame 222 29  
 human flea 81 42  
 Humanist 342 4  
 human louse 81 40, 41  
 humblebee 358 23  
 humerus 17 12  
 humidifier 79 22  
 hummock 13 42  
 hump 206 46  
 hundreds 344 3  
 hunt 289 41-49  
 Hunter *Astron.* 3 13  
 hunter 86 1  
 hunting 86 1-52, 9-12, 14-17  
 hunting cap 289 14  
 hunting cap, hard ~ 289 18  
 hunting clothes 86 2  
 hunting dog 86 33  
 hunting equipment 87 41-48  
 hunting horn 87 60; 289 44  
 hunting knife 87 42

hunting knife, double-edged  
 ~ 87 41  
 hunting leopard 368 7  
 hunting pink 289 13, 42  
 hunting rifle 86 4  
 hunting rifles 87 1-40  
 hunting screen 86 9  
 hunting weapons 87  
 huntsman 86 1  
 hurdle *Free Exerc.* 295 12  
 hurdle *Athletics* 298 8  
 hurdle position 295 12  
 hurdle racing 298 7-8  
 hurdles 298 7-8  
 hurdy-gurdy 322 25  
 hurst 91 20  
 husk 59 50; 68 33  
 husk corn 68 31  
 husky 70 22; 353 2  
 hut 300 1  
 hut, beehive-shaped ~ 354 28  
 hut, Indian ~ 273 59  
 Hydra 3 16  
 Hydra, Lernaean ~ 327 32  
 Hydrallmania 369 9  
 hydrangea 51 11  
 hydrant key 270 27  
 hydraulic engineering 217  
 hydraulic lift pad 195 27  
 hydraulic plant 92 13  
 hydraulic plant room 316 50  
 hydraulic system *Agr. Mach.*  
 64 65  
 hydraulic system *Paperm.* 173  
 37  
 hydraulic system *Army* 255 53  
 hydraulic system *Air Force*  
 257 16  
 hydrocyanic acid 83 15  
 hydro-extraction 169 23  
 hydro-extractor, pendulum-  
 type ~ 168 14  
 hydro-extractor lid 168 18  
 hydroformer 145 47  
 hydrogenation 170 16  
 hydrogen atom 1 15; 242 62  
 hydrogen atom (model) 1 1  
 hydrogen balloon 10 56  
 hydrogen bomb explosion 7  
 12  
 hydrogen cooler 153 27  
 hydrogen inlet *Synth. Fibres*  
 170 15  
 hydrogen inlet *Chem.* 350  
 12  
 hydrogen sulphide scrubber  
 156 22  
 hydrogen sulphide wet  
 collector 156 22  
 hydrogen tank 6 6  
 hydropathic 274 8  
 hydrophone 224 64  
 hydroplane 286 22  
 hydroplane, stepped ~ 286  
 38-41  
 hydroplane, three-point ~  
 286 42  
 hydrosphere 11 2  
 hydroxylamine inlet 170 21  
 hyena 368 1  
 hygrograph 10 8, 50

hygrometer *Drawing Off.* 151  
 39  
 hygrometer *Offset Platem.*  
 179 28  
 hygrometer *Swim.* 281 23  
 hygrometer element 10 9  
 hymenium 381 17  
 Hymenoptera 358 21-23  
 hymn board 330 24  
 hymn book 330 30  
 hymn number 330 24  
 hyoid 20 2  
 hyperbola 347 26  
 hyperbolic position line 224  
 43, 44  
 hyphae 381 2  
 hyphen 342 28  
 hypocentre 11 32  
 hypocotyl 370 89  
 hypophysis cerebri 17 43  
 hypotenuse 346 32  
 hypotrachelium 334 22  
 hyrax 366 24  
 hyssop 374 5

## I

ibex 367 7  
 ice 266 44  
 ice, glacial ~ 12 48-56  
 ice accident 21 28-33  
 ice axe 300 16, 31  
 ice axe, short-shafted ~ 300  
 36  
 iceboat 302 44  
 iceboating 302 44-46  
 icebox 39 2; 46 33; 317 10  
 ice breaker 221 50  
 ice bucket 267 67  
 ice-cream cornet 308 31  
 ice-cream man 308 30  
 ice-cream sundae 266 76  
 ice-cream vendor 308 30  
 ice-crystal cloud 8 6  
 ice-crystal cloud veil 8 7  
 ice cube 266 44  
 ice hockey 302 29-37  
 ice hockey player 302 29  
 ice hockey set 302 23  
 ice hockey skate 302 23  
 ice hockey stick 302 30  
 ice ledge 300 4  
 ice pellets 9 35  
 ice piton 300 40, 41  
 ice racing 290 24-28  
 ice ridge 300 21  
 ice sailing 302 44-46  
 ice skater 302 1  
 ice skates 302 20-25  
 ice skating 302 1-26  
 ice skating boot 302 24  
 ice slope 300 14  
 ice speedway 290 24-28  
 ice step 300 17  
 ice stick 302 39  
 ice-stick shooter 302 38  
 ice-stick shooting 302 38-40  
 ice yacht 302 44  
 ice yachting 302 44-46  
 icicle 304 21



icing, chocolate ~ 97 34  
 icing sugar 98 54  
 icosahedron 351 11  
 icositetrahedron 351 12  
 identification mark 163 6  
 identification number 85 33  
 identification tally 74 55  
 idle air bleed 192 2  
 idle mixture adjustment screw 192 11  
 idling adjustment 190 51  
 idling air jet 192 2  
 idling jet 192 1  
 idol 328 20  
 igloo 353 4  
 igloo tent, inflatable ~ 278 58  
 ignition distributor 190 9, 27  
 iguana 364 32  
 ileum 20 16  
 ilium 17 18  
 illumination, incident ~ 112 59, 63  
 illumination, vertical ~ 112 59, 63  
 illumination beam path 112 6  
 illumination optics 112 7  
 illumination path 112 6  
 image beam 115 35  
 image converter 26 15, 18; 27 19  
 imago 358 10  
 imbrication 335 15  
 imitation motorcycle fork 188 58  
 immersion heater 40 17  
 immersion roller 165 45  
 immersion vibrator 119 88  
 impact crusher 158 20  
 impact wrench 195 44  
 impair 275 23  
 impeller wheel 217 52  
 Imperial Crown 254 38  
 impost 336 21  
 impounding reservoir 217 57  
 impregnating spray 50 40  
 impression-adjusting wheel 180 81  
 impression control 249 10  
 impression cylinder 180 35, 64, 181 2, 44, 59  
 impression-setting wheel 180 81  
 impression tray 24 56  
 imprint, publisher's ~ 185 48  
 impulse generator, programmed ~ 25 33  
 impulse meter, automatic ~ 25 42  
 incense boat 332 42  
 incense spoon 332 43  
 incident light measurement 114 60  
 incident neutron 1 42  
 incisor 19 16, 34  
 inclined cable anchorage 215 48  
 inclined cable system 215 51  
 incubation tank, long ~ 89 18  
 incubator 261 30  
 incubator, Californian ~ 89 15

incus and stapes 17 61  
 indention 175 16  
 index 345 1, 2  
 index arm 224 3  
 index bar 224 3  
 index cards 22 7  
 index finger 19 65  
 indexing mark 249 74  
 indexing table, rotary ~ 150 42  
 index mirror 224 6  
 index plate 151 51  
 Indian 352 25  
 Indian chief 352 11  
 Indian corn 68 31  
 Indian cress 53 4  
 Indian meal moth 81 28  
 Indian Ocean 14 23  
 indicator *Hosp.* 26 28  
 indicator *Motorcycle* 189 37, 45  
 indicator *Tram* 197 22  
 indicator, rear ~ 189 42  
 indicator and dimming switch 191 59  
 indicator board *Station* 204 32  
 indicator board *Hotel* 267 5  
 indicator for rough and fine adjustment 148 65  
 indicator lamp *Sawmill* 157 62  
 indicator lamp *Cotton Spin.* 164 8  
 indicator lamp *Office* 249 71  
 indicator light *Hosp.* 25 6  
 indicator light *Motorcycle* 189 37, 45  
 indicator light *Serv. Stat.* 196 7  
 indicator light *Tram* 197 22  
 indicator light *Railw.* 203 14  
 indicator light *Audio* 241 55  
 indicator light *Office* 249 71  
 indicator light *Hotel* 267 6  
 indicator light *Fencing* 294 30  
 indicator light, front ~ 191 19  
 indicator light, rear ~ 189 42  
 indicator needle *Photog.* 114 58  
 indicator needle *Inf. Tech.* 242 76  
 indicator plate 203 12  
 indicator scale 114 58; 313 28  
 indigo dyeing and sizing machine 165 40  
 Indio 352 23  
 individual-section machine 162 21  
 indoor target rifle 305 35  
 indorsee 250 26  
 indorsement 250 25  
 indorser 250 27  
 induced-draught fan 152 14  
 induction coil 11 44  
 industrial plant 225 71  
 inert-gas atmosphere 162 16  
 inert-gas supply 142 34  
 inert-gas torch 142 33  
 inert-gas welding 142 33

inert-gas welding equipment 138 29  
 inertial measurement unit 6 43  
 inescutcheon 254 17  
 infant care 28  
 infants' wear 29 13-30  
 in-feed scale 157 61  
 infighting 299 31  
 infiltration drain 216 37  
 infinity 345 15  
 inflating bulb 25 17  
 inflator 22 37  
 inflections 320 50-54  
 inflight antenna 6 46  
 inflight refuelling probe 256 7  
 inflorescence 371 43, 48; 378 7, 53, 55; 382 38; 383 49; 384 31  
 inflorescence, female ~ 59 46; 68 32; 383 11; 384 50  
 inflorescence, male ~ 59 39; 68 35; 371 8; 372 17, 24; 383 13  
 inflorescences 370 67-77  
 'information' 233 31  
 information bureau 204 29  
 information clerk 204 49  
 information counter 250 9  
 information office 204 29  
 information plate 356 20  
 information position 237 34  
 information technology 242  
 infrared drier 173 32  
 infrared laser rangefinder 255 82  
 infrared sound headphones 242 30  
 infrared sound transmitter 242 29  
 infrared transmission 242 27  
 infraspinus 18 53  
 infringement 291 50  
 infructescence 61 15; 371 22, 44, 69, 72; 373 8; 374 18; 383 56; 384 32  
 infusion apparatus 25 11  
 infusion bottle 25 12  
 infusion device 25 14  
 ingot 148 48  
 ingot mould 147 32  
 ingot tipper 148 49  
 ingress/egress hatch 6 38  
 ingress/egress platform 6 34  
 inhalation 274 7  
 inhalational therapy 274 6-7  
 inhalator 23 24  
 inhalatorium 274 6  
 inhaler 26 2, 29  
 inhaling apparatus 23 24  
 inhaling tube 26 2, 29  
 initial 175 1  
 initial position *Fish Farm.* 89 33  
 initial position *Fencing* 294 18  
 injection condenser 172 16  
 injection nozzle 190 32, 54  
 injection pump *Intern.* *Combust. Eng.* 190 65  
 injection pump *Railw.* 211 48

injection pump drive 190 57  
 injection timer unit 190 58  
 ink 260 83  
 ink ball 340 22  
 ink duct 180 22; 181 65  
 inker 180 21, 50, 60, 77  
 inker unit 180 6-13, 40, 51, 60, 71, 76; 181 7, 8, 19, 28, 50, 57; 249 51-52  
 ink fountain 180 22; 181 65  
 ink fountain roller 181 64  
 inking ball 340 22  
 inking roller 180 21, 50, 60, 77; 249 52  
 inking unit 180 6-13, 40, 51, 60, 71, 76; 181 7, 8, 19, 28, 50, 57; 249 51-52  
 ink pad 22 30  
 ink plate 181 8  
 ink roller 180 21, 50, 60, 77; 249 52  
 ink slab 181 8  
 ink unit, tubular ~ 151 68  
 inkwell 309 78  
 inlay 323 26  
 inlet *Paperm.* 172 77  
 inlet *Chem.* 349 21  
 inlet filter 146 26  
 inlet manifold 190 18; 192 13  
 inlet valve 242 52  
 inlet vent 191 47  
 inner tube 187 30  
 input 117 27  
 input keyboard 238 13  
 input/output device 237 59  
 input selector 241 44  
 input selector switch 238 49  
 input unit 176 30  
 inscription 252 11  
 insect, homopterous ~ 358 3  
 insect, orthopterous ~ 358 8  
 insectivores 366 4-7  
 insects 358 3-23  
 insects, dipterous ~ 358 16-20  
 insert, wood ~ 85 4  
 insertion ring 349 17  
 inshore fishing 90 24-29  
 inside defender 291 12  
 inside forward 291 15  
 insulation 155 18  
 insole 291 27  
 inspection apparatus 79 20  
 inspection window 38 62  
 inspector 205 44  
 instep 19 61  
 instruction, programmed ~ 242 16  
 instruction key 247 21  
 instruction laser 242 81  
 instrument, keyed ~ 325 1  
 instrument, plucked ~ 322 21  
 instrument basin 27 5  
 instrument cabinet 24 16  
 instrument housing *Atom* 2 5, 22  
 instrument housing *Meteorol. Instr.* 10 59  
 instrument panel *Offset Print.* 180 74  
 instrument panel *Railw.* 212 31

instrument panel *Aircraft* 230 1  
 instrument panel *Airsports* 288 11  
 instruments, dental ~ 24 4  
 instruments, orchestral ~ 323 1-62  
 instruments, retractable ~ 258 68; 259 74, 88-91  
 instruments for gynecological and proctological examinations 23 3-21  
 instruments for minor surgery 22 48-50  
 instrument table 22 45  
 instrument table, mobile ~ 26 37  
 instrument tray 24 5; 26 39  
 instrument unit 234 53  
 insufflator 23 18  
 insulating board 122 44  
 insulating casing 10 26  
 insulating tape 127 34  
 insulation *Slaughterho.* 94 10  
 insulation *Energy Sources* 155 36  
 insurance company office 268 40  
 intaglio printing 182  
 intaglio process 340 14-24  
 intake muffler 191 54  
 intake pipe 189 5  
 intake silencer 190 16; 191 54  
 integer 344 10  
 integral 345 14  
 integral sign 345 14  
 integration 345 14  
 intensive care unit 25 1-30  
 interceptor 256 1  
 Intercity train 205 34  
 intercom *Doc.* 22 34  
 intercom *Garage* 195 55  
 intercom *Computer* 244 5  
 intercom *Office* 245 20; 246 10  
 intercommunication telephone 239 13  
 intercom system *Railw.* 202 48; 203 69  
 intercom system *Computer* 244 5  
 interest 345 7  
 interior equipment 239 6  
 interlacing point 171 28  
 interleaving device 181 11  
 intermediate frequency amplifier module 240 4  
 intermediate image screen 113 37  
 internal combustion engine, single-cylinder ~ 190 6  
 internal combustion engine, two-stroke ~ 190 6  
 internal combustion engines 190  
 internal facing tool 149 51  
 International Signals Code 253 29  
 interrogation mark 342 20  
 interrogation point 342 20  
 interrupter 153 55

intersection 347 12  
 intersection of sets 348 4  
 interspacing 175 13  
 inter-stage connector 234 31, 36  
 inter-stage section 234 31, 36  
 inter-tank connector 234 16  
 inter-tank section 234 16  
 intervals 321 6-13  
 intestine 77 15  
 intestine, large ~ 20 17-22  
 intestine, small ~ 20 14-16  
 intestines 20 14-22  
 intestinum crassum 20 17-22  
 intestinum tenue 20 14-16  
 intrusion 11 30  
 inundation area 216 41  
 Inverness 186 32  
 invertebrates 357  
 inverted comma 342 26  
 inverted flight 288 9  
 involucre 59 50  
 ion chamber 2 2, 17  
 ionization chamber 2 2, 17  
 ionizing particle 1 58  
 ionosphere *Atmos.* 7 23  
 ionosphere *Post* 237 55  
 iris *Man* 19 42  
 iris *Flower Gdn.* 51 27  
 iris *Gdn. Flowers* 60 8  
 iron *Shoem.* 100 9  
 iron *Tailor* 104 29  
 iron *Ball Games* 293 92  
 iron, electric ~ 50 6  
 iron, lightweight ~ 50 6  
 iron, molten ~ 148 11  
 iron, slater's ~ 122 84  
 iron, square ~ 143 9  
 Iron Age 328 21-40  
 iron and steel works 147  
 ironer 103 19  
 iron foundry 148 1-45  
 iron handle 50 9  
 ironing board 50 16  
 ironing-board cover 50 17  
 ironing head 50 4  
 ironing machine, electric ~ 50 1  
 ironing surface *Household* 50 16  
 ironing surface *Dressm.* 103 23  
 ironing table 50 15  
 iron ladle 147 12, 21, 42  
 iron pyrites 351 8  
 iron runoff 147 11  
 irons 50 1-20  
 iron well 50 18  
 irradiation table 2 36  
 irrigation, overhead ~ 67  
 irrigation system, portable ~ 67 3  
 irrigation unit, long-range ~ 67 18  
 ischium 17 19  
 island *Phys. Geog.* 13 6  
 island *Warships* 259 3  
 island *Park* 272 55  
 isobar 9 1  
 isocheim 9 42  
 isohel 9 44



isohyet 9 45  
isometric crystal system 351  
1-17  
isosceles triangle 346 27  
isoseismal 11 37  
isotherm 9 43  
isotherm 9 40  
issue desk 262 20  
Italian ryegrass 69 26  
italics 175 7  
ITOS satellite 10 64  
ivory carver 135

## J

jack *Ship* 223 54  
jack *Army* 255 68  
jack *Fire Brig.* 270 12  
jack *Sports* 305 23  
jack *Music. Instr.* 322 50  
jack, hydraulic ~ 85 45  
jackal 367 11  
jack boot 355 58  
jack chain, endless ~ 157 17  
jacket 29 51; 31 2; 33 2  
jacket, baby's ~ 28 25; 29 9  
jacket, casual ~ 33 39  
jacket, cork ~ 282 19  
jacket, denim ~ 33 21  
jacket, leather ~ 33 43  
jacket, metallic ~ 294 15  
jacket, mink ~ 30 1  
jacket, oilskin ~ 228 6  
jacket, padded ~ 300 6  
jacket, pile ~ 29 44  
jacket, poplin ~ 31 37  
jacket, short-sleeved ~ 33 26  
jacket, suede ~ 30 58  
jacket button 33 55  
jacket crown 24 28  
jacket flap 185 38  
jack-in-the-box 306 56  
jack panel 311 16  
jack plane 132 16  
jack rafter 121 61, 63  
jack spur, screwed ~ 71 50  
jack spur, strapped ~ 71 51  
jackstaff 223 53; 258 4  
jackstay 221 118  
jacob's ladder 221 91  
jai alai 305 67  
jam 98 52  
jam, whole-fruit ~ 98 51  
jamb 118 11; 120 32, 51  
jambeau 329 54  
jam cleat 284 22  
Jamestown weed 379 8  
Japan Current 14 31  
Japanese quince 373 17  
japonica 373 17  
jardin anglais 272 41-72  
javelin 319 17  
javelin throw 298 51-53  
jaw *Man* 16 17  
jaw *Hosp.* 26 46  
jaw *Joiner* 132 33  
jaw *Metalwkr.* 140 3  
jaw, lower ~ *Man* 17 35  
jaw, lower ~ *Horse* 72 11  
jaw, upper ~ 17 36; 19 27

jawbone, lower ~ 17 35  
jawbone, upper ~ 17 36  
jaws, inside ~ 149 71  
jaws, outside ~ 149 70  
jaw trap 87 48  
jay 361 1  
jazz band instruments 324  
47-78  
jazz guitar 324 73  
jazz trumpet 324 65  
jeans 31 60; 33 22  
jejunum 20 15  
jellyfish 357 14  
jelly roll 97 19  
J-2 engine 234 19, 34  
jenny 222 14, 28  
jerboa 366 15  
jerkin 355 45  
jerkin head roof 121 16  
jerk with split 299 4  
jersey 291 56  
jersey, padded ~ 292 26  
jess 86 45  
jester 306 38  
jet 83 19  
jet, main ~ 192 12  
jet aeroplanes 231 7-33  
jet airplanes 231 7-33  
jet blower 281 34  
jet condenser 172 16  
jet engine 231 26  
jet engines 232 33-50  
jet fuel tank 146 18  
jet nozzle 153 29  
jet planes 231 7-33  
jet pump 216 62  
jets 231 7-33  
jet stream level 7 5  
jet trainer 257 1-41  
jet turbine 231 26  
jet turbine engine 231 26  
jet turbine engines 232 33-50  
jet turbines 232 33-50  
jetty *Map* 15 59  
jetty *Docks* 225 30, 66  
jetty *Park* 272 46  
jetty *Camping* 278 13  
jetty *Rowing* 283 19  
jewel 110 33; 355 17  
jewel box 36 31  
jewel case 36 31  
jewellery 36; 36 1  
jewellery department 271 62  
jewelry *see* jewellery  
jib *Bldg. Site* 119 36  
jib *Ship* 220 2  
jib *Docks* 226 24, 49  
jib *Army* 255 95  
jib *Sailing* 284 16; 285 3  
jib, flying ~ 219 23  
jib, inner ~ 219 21  
jib, outer ~ 219 22  
jib boom 218 51; 219 1  
jib crane 222 34  
jib downhaul 284 17  
jibe 285 28  
jibing 285 26  
jib sheet 284 23  
jib stay 219 14  
jig 134 42  
jiggering 161 14

jig saw 108 12  
jigsaw puzzle 48 9  
jigsaw puzzle piece 48 10  
jimson weed 379 8  
jimson weed 379 8  
job advertisement 342 70  
jockey 22 68  
jockey cap 35 8  
jockey roller 181 45  
jockey wheel 278 54  
jogger 249 56  
join 122 94  
joiner 132 38; 133  
joiner's tools 132 1-28  
joining of modules 242 70  
joint *Phys. Geog.* 13 50  
joint *Plumb. etc.* 126 38  
joint *Railw.* 202 11  
joint *Industr. Plants* 383 63  
joint, pre-packed ~ 96 22  
joint, universal ~ 284 6  
joint and side pasting  
attachment 185 28  
joint cutter 201 16  
joint-cutting blade 201 17  
jointed charlock 61 21  
jointer 133 37  
joint vice 108 34  
joist 121 54  
joist shuttering 119 12  
jollying 161 14  
Jordan 172 27, 60, 73, 83  
Jordan refiner 172 27, 60, 73,  
83  
journal 143 63  
joust 329 71  
jousting helmet *Heraldry* 254  
4  
jousting helmet *Chivalry* 329  
77  
judge *Cyc. Racing* 290 5  
judge *Sports* 299 43  
judo 299 13-17  
judoist 299 14  
judoka 299 14  
judo throw 299 17  
jug 39 30  
jug, clay ~ 260 78  
juice extractor 40 19  
ju-jitsu 299 13-17  
jumbo derrick boom 221 25,  
62  
jumbo jet 231 14  
jump 289 21  
jumper *Child. Clothes* 29 43  
jumper *Equest.* 289 9  
jumper, child's ~ 29 47  
jumper, cowl neck ~ 30 2  
jumper, polo neck ~ 30 7  
jumper, short-sleeved ~ 31 67  
jumping 298 9-41  
jumping hoop 307 58  
jumping jack 306 52  
jumping rope 273 15, 16  
jumping saddle 289 10  
jumping sheet 270 18  
jump rope 273 16  
jump-sit-spin 302 8  
jump ski 286 62  
jumpsuit 31 53  
jump throw 292 3

junior hacksaw 127 52  
juniper berry 372 52  
juniper tree 372 47  
junk 353 32  
junk stall 308 60  
Jupiter 4 48  
just 329 71  
justifying scale 174 35  
jute 383 25

## K

kail 57 34  
kale 57 34  
kangaroo 366 3  
kapok tree 383 20  
karabiner 300 46  
karabiner hole 300 35  
karate 299 18-19  
karateka 299 18  
karst formation 13 71-83  
karst spring 13 74  
kart 305 83  
karting 305 82  
kayak 283 4; 353 12  
kayak, folding ~ 283 61, 62, 67  
kayak, one-man ~ 283 54  
kayak, two-seater ~ 283 61  
kayaks 283 68-70  
Keel *Astron.* 3 46  
keel *Shipbuild.* 222 22  
keel *Space* 235 7  
keel *Rowing* 283 32  
keel *Sailing* 285 32  
keel, lead ~ 285 36  
keel, vertical ~ 222 53  
keel arch 336 36  
keel block 222 39  
keel-centreboard yawl 285  
37-41  
keel plate 222 49  
keelson 222 53; 283 50  
keep 329 4  
keep net 89 28  
kegellade chest 326 12-14  
kelly 145 14  
kelson 222 53; 283 50  
kerb 198 6; 272 25  
kerbstone 198 7  
kerbstone broker 251 5  
kerbstoner 251 5  
kerf 84 28  
kernel 68 13; 383 44  
kerosene 145 60  
kerosene tank 234 9  
kerria 373 28  
ketchup 45 43  
kettle, brass ~ 42 14  
kettle, whistling ~ 39 16; 40  
10  
kettledrum 323 57  
Keuper 154 57  
key *Map* 14 27-29  
key *Metalwkr.* 140 33-35  
key *Town* 268 4  
key *Music. Instr.* 322 28, 38,  
49; 323 32, 35; 324 40; 326  
8  
key, black ~ 325 5  
key, ebony ~ 325 5

key, flat ~ 140 48  
key, gib-headed ~ 143 74  
key, iron ~ 328 32  
key, ivory ~ 325 4  
key, sunk ~ 143 73  
key, white ~ 325 4  
key action 325 22-39  
keyboard *Composing Rm.* 174  
32, 37; 176 2  
keyboard *Post* 236 44; 237 70  
keyboard *Office* 245 27; 249  
2-6  
keyboard *Music. Instr.* 322  
28; 324 40; 325 4-5  
keyboard, lower ~ 322 47  
keyboard, upper ~ 322 46  
keyboard console 176 1  
keyboard instrument 325 1  
keyboard operator 176 4  
keyboard send-receive  
teleprinter 176 31  
keyboard side 324 39  
keyboard unit 176 1  
keyhole 140 40  
keyhole saw 120 63; 126 70;  
132 3  
key lever 322 38, 49; 326 8  
key mechanism 325 22-39  
key rack 267 3  
keys *Mach. Parts etc.* 143  
73-74  
keys *Music. Not.* 320 55-68  
key seat 143 85  
key signatures 320 50-54  
key slot 143 85  
keystone 336 23  
keyway 143 66, 85  
kick-back guard 132 47; 157  
59  
kicker 292 10  
kicking strap 284 21  
kick stand 187 34  
kickstarter 188 39, 43; 189 38  
kidney, left ~ 20 30-31  
kidney, right ~ 20 28  
kidney dish 23 45  
kidney vetch 69 6  
kieselguhr 93 3  
kieselguhr filter 93 4  
kill *Hunt.* 86 38  
kill *Bullfight, etc.* 319 30  
killer 94 1  
kiln 92 19  
kiln, circular ~ 159 19  
kiln, rotary ~ 160 8  
kilning floors 92 16-18  
kilns 161  
kilometer *see* kilometre  
kilometre sign 216 44  
kimono 353 40  
kindergarten 48  
king 276 8  
King Carnival 306 58  
king cup 375 8  
kingfisher 360 8  
king penguin 359 4  
king pin roof structure 121 42  
king post 223 35  
king post, ventilator-type ~  
221 58  
king's fern 377 16

Kipp generator 350 59  
Kipp's apparatus 350 59  
Kirghiz 353 22  
Kirschner beater 163 25  
kit 322 20  
kitchen 39, 207 29, 80  
kitchen, ship's ~ 223 42  
kitchen appliances 40  
kitchen cabinet 207 35  
kitchen chair 39 43  
kitchen clock 39 20; 109 34  
kitchen cupboard 39 8  
kitchen lamp 39 39  
kitchen roll 40 1  
kitchen scales 309 84  
kitchen table 39 44  
kitchen unit 46 29  
kitchen utensils 40  
kite *Playground* 273 41, 42  
kite *Maths.* 346 38  
kite *Birds* 362 11  
kite, paper ~ 260 71  
kite string 273 44  
knapsack 86 3  
knapsack sprayer, plunger-  
type ~ 83 43  
knapweed 376 12  
kneading machine 97 55  
knee *Man* 16 50  
knee *Horse* 72 22  
knee-breeches 33 40  
kneecap *Man* 17 23  
knee cap *Chivalry* 329 53  
kneeler 332 25  
knee lever 325 45  
kneeling front support 295 20  
kneeling position *Free Exerc.*  
295 8  
kneeling position *Sports* 305  
28  
knee mounting 113 21  
knee pad *Ball Games* 292 9  
knee pad *Winter Sp.* 303 17  
knee piece 329 53  
knee roll 71 48  
knee strap 33 41  
knee swell 325 45  
knife *Tablew, etc.* 45 7, 50  
knife *Forestry* 85 11  
knife *Paperhanger* 128 38  
knife *Paperm.* 172 74  
knife *Swim.* 279 8  
knife, bookbinder's ~ 183 13  
knife, bronze ~ 328 31  
knife, butcher's ~  
*Slaughterho.* 94 15  
knife, butcher's ~ *Butch.* 96  
37  
knife, cobbler's ~ 100 50  
knife, electrician's ~ 127 63  
knife, gardener's ~ 56 9  
knife, gilder's ~ 129 51  
knife, hafted ~ 328 31  
knife, shoemaker's ~ 100 50  
knife, surgical ~ 26 43  
knife blade 96 32  
knife case 94 12  
knife coulter 65 10  
knife handle 96 34  
knife rest 45 11  
knife thrower 307 37



knight *Games* 276 11  
 knight *Chivalry* 329 67  
 knighting 329 66  
 Knight Templar 329 73  
 knit 101 43  
 knits 171  
 knits, basic ~ 171 30-48  
 knit stitch 101 43  
 knitting 167  
 knitting head 167 21  
 knitting machine, circular ~ 167 1  
 knitting machine, flat ~ 167 18  
 knives, butcher's ~ 96 31-37  
 knob 359 17  
 knob, adjustable ~ 151 3  
 knobkerrie 354 33  
 knobkerry 354 33  
 knob-leaf capital 333 14  
 knockout 299 40  
 knock-over bit 167 52  
 knot *Meteorol. etc.* 9 12  
 knot *Ladies' Wear* 31 47  
 knot *Underwear etc.* 32 42  
 knot *Roof* 122 68  
 knot, French ~ 102 13  
 knot hole cutter 132 53  
 knot hole moulding machine 132 52  
 knot stitch, twisted ~ 102 13  
 knotted work 102 21  
 knotter 172 54; 173 13  
 knotting machine 85 18  
 knuckle *Man* 19 82  
 knuckle *Mear* 95 38, 42, 49  
 knuckle, fore ~ 95 5, 8  
 knuckle, hind ~ 95 1, 10  
 knuckle of pork 96 17  
 Kocher's forceps 22 49  
 kohlrabi 57 26  
 Korean 341 27  
 Kort vent 227 21  
 koruna 252 27  
 kraft pulp mill 172 1-52  
 KR-class 284 63  
 kris 353 44  
 krona 252 25  
 krone 252 24, 26  
 Krüger flap 229 55  
 krummhorn 322 6  
 Kuroshio 14 31  
 Kuro Siwo 14 31  
 kursaal 274 8  
 kymation 334 19

## L

label 54 4  
 laboratory 23 41-59  
 laboratory, multi-purpose ~ 235 66  
 laboratory and research microscope 112 1  
 laboratory apparatus *Doc.* 23 57  
 laboratory apparatus *Paperm.* 173 2-10  
 laboratory apparatus *Chem.* 349 1-38; 350 1-63

laboratory equipment *Doc.* 23 57  
 laboratory equipment *Paperm.* 173 2-10  
 laboratory equipment *Chem.* 349 1-38; 350 1-63  
 laboratory microscope 112 1  
 laboratory technician 23 41  
 laboratory timer 116 18  
 laborer *see* labourer  
 labourer, bricklayer's ~ 118 19  
 labourer, builder's ~ 118 19  
 Labrador Current 14 40  
 labret 354 23  
 laburnum 374 32  
 labyrinth 17 62  
 lace 100 64; 291 32  
 lace, cotton ~ 31 32  
 lace, Venetian ~ 102 30  
 lace fastening 101 21  
 lackey 186 20  
 lackey moth 80 13  
 lacolith 11 30  
 lacquered work, incised ~ 337 6  
 lacquey 186 20  
 lactam oil 170 37  
 ladder *Moon L.* 6 35  
 ladder *Roof & Boilerr.* 38 15  
 ladder *Child. Rm.* 47 5  
 ladder *Fruit & Veg. Gdn.* 52 8  
 ladder *Bldg. Site* 118 42  
 ladder *Railw.* 211 43  
 ladder *Hydr. Eng.* 217 8  
 ladder *Space* 235 28  
 ladder, aluminium ~ 50 35  
 ladder, arched ~ 5 20  
 ladder, extending ~ 270 10  
 ladder, standard ~ 118 86  
 ladder, steel ~ 270 10  
 ladder dredge, multi-bucket ~ 216 56  
 ladder hook 122 15, 69  
 ladder mechanism 270 11  
 ladder operator 270 13  
 ladder scaffold 118 86-89  
 'ladies' 233 48  
 'ladies' toilet' 233 48  
 ladies' wear 30; 31  
 ladies' wear department 271 28  
 ladle 130 32  
 ladle, crane-operated ~ 147 60  
 ladle, drum-type ~ 148 6  
 ladle, mobile ~ 148 6  
 lady *Café* 265 23  
 lady *Hist. Cost.* 355 59, 64, 68, 70, 79  
 ladybird 358 37  
 ladybug 358 37  
 lady-finger 69 6  
 lady's finger 69 6  
 ladysmock 375 11  
 lady's slipper 376 27  
 lady's smock 375 11  
 lager 93 26  
 lager cellar 93 12  
 lagging 38 72  
 lagoon 13 33

lake 13 3  
 lake, coastal ~ 13 44  
 lake, ox-bow ~ 15 75  
 lake dwelling 328 15  
 lamantin 366 23  
 lamb 73 13; 75 11  
 lamb's lettuce 57 38  
 lamellicorn 82 1  
 lamellicorn beetle 358 24, 39  
 lamina 68 20; 370 28, 85  
 laminate 301 48  
 lamp *Dent.* 24 19  
 lamp *Dining Rm.* 44 12  
 lamp *Watchm.* 109 12  
 lamp *Carriages* 186 9  
 lamp *Street Sect.* 198 18  
 lamp *Nightclub* 318 26  
 lamp, directional ~ 22 44  
 lamp, fluorescent ~ 49 32; 271 23  
 lamp, front ~ 188 29  
 lamp, individual ~ 26 11  
 lamp, pendant ~ 44 12  
 lamp, rear ~ 187 46  
 lamp, side ~ 191 20  
 lamp bracket *Photomech. Reprod.* 177 16  
 lamp bracket *Bicycle* 187 6  
 lamp compartment 177 41  
 lampholder 127 60  
 lamphouse 112 28, 59; 116 29; 309 44; 312 39-44  
 lamphouse connector 112 60  
 lamp housing 116 29  
 lamp post 198 18  
 lam rod 166 54  
 lance *Gdn. Tools* 56 25  
 lance *Bullfight. etc.* 319 17  
 lance *Chivalry* 329 81  
 lance *Ethnol.* 353 9  
 lanceolate 370 32  
 lancer 319 16  
 lance rest 329 80  
 lancet arch 336 31  
 lancet window 335 39-41  
 land 87 39  
 landau 186 36  
 landaulette 186 36  
 land drill 282 20  
 landfill, sanitary ~ 199 10  
 landing *Floor etc. Constr.* 123 34-41  
 landing *Athletics* 298 19  
 landing, intermediate ~ 123 52-62  
 landing area 298 36, 39  
 landing beam 123 34, 55  
 landing beam, main ~ 123 66  
 landing craft 258 89; 259 46  
 landing flap 229 42; 230 53; 257 38; 288 29  
 landing gear, hydraulically operated ~ 235 31  
 landing gear, main ~ 235 31  
 landing gear, retractable ~ 232 10  
 landing gear housing 256 15  
 landing gear hydraulic cylinder 257 41  
 landing gear unit, forward-retracting ~ 257 40

landing gear unit, main ~ 230 41; 231 28; 257 40; 288 33  
 landing gear unit, retractable ~ 231 28  
 landing light 230 49; 257 37; 288 32  
 landing mat 296 13; 297 7  
 landing net 89 2  
 landing pad *Moon L.* 6 33  
 landing pad *Athletics* 298 36  
 landing pontoon 225 63  
 landing skid 232 15; 256 21  
 landing stage 225 63; 278 13; 283 19  
 landing unit, main ~ 256 26  
 landlord 305 7, 13  
 landside 65 5, 67  
 landslide 11 46  
 landslip 11 46  
 land surveying 14 46-62  
 land wheel 65 15  
 lane *Map* 15 112  
 lane *Forestry* 84 1  
 lane arrow 268 73, 74  
 lane timekeeper 282 24  
 language laboratory 261 35  
 languid 326 28  
 lansquenet 355 32  
 lantern *Carriages* 186 9  
 lantern *Ship* 218 44; 221 48  
 lantern *Navig.* 224 105  
 lantern *Art* 335 45  
 lantern, Chinese ~ 353 36  
 lantern, combined ~ 286 13  
 lantern, paper ~ 52 15; 306 4  
 lantern mast 224 82  
 lantern tower 224 82  
 lanyard 284 19  
 lap *Dom. Anim.* 73 23  
 lap *Roof* 122 100  
 lap *Cotton Spin.* 163 58, 64  
 lap, carded ~ 163 47  
 lapboard 136 7  
 lap cradle 163 15  
 lapel 31 23; 33 5  
 lapel, silk ~ 33 8  
 lapping plate 125 4  
 lap riveting 143 56  
 lap scorer 290 6  
 lap-turner, movable ~ 163 19  
 lapwing 359 21  
 larch 372 32  
 larch cone 372 36  
 lard 96 5  
 large cabbage white butterfly 80 47  
 larks 361 18-19  
 larkspur 60 13  
 larmier 88 14  
 larry 144 8; 156 6  
 larry car 144 8; 156 6  
 larva 58 64; 77 29; 80 6, 19, 36, 38, 41, 46; 81 20; 358 9, 19; 82 12, 25, 36  
 larva, first-generation ~ 80 23  
 larva, mature ~ 80 53  
 larva, second-generation ~ 80 24  
 larva, young ~ 77 28; 80 54  
 larynx 20 2-3  
 laser 242 81

laser beam 243 53  
 lashing *Bldg. Site* 118 30  
 lashing *Ship* 218 32; 221 119  
 lasso 319 40; 352 5  
 last 100 34  
 last, iron ~ 100 54  
 last, wooden ~ 100 32  
 latch bolt 140 37  
 latch needle 167 12, 56, 61  
 lateen sail 218 29; 220 3  
 lateen spanker 218 29  
 lateen yard 218 30  
 La Tène period 328 21-40  
 lateral 144 30  
 lath 123 70  
 lath, double ~ 122 43  
 lath, tilting ~ 122 43  
 lath, toothed ~ 122 26  
 lath axe 122 21  
 lathe 135 1  
 lathe, watchmaker's ~ 109 20  
 lathe bed 135 2; 149 31  
 lathe carrier 149 54  
 lathe foot 149 12  
 lathe spindle 149 20  
 lathe tool 149 48, 52  
 lathe tools 149 45-53  
 lathing 123 71  
 latissimus dorsi 18 59  
 latitude 14 6  
 latrine 118 49  
 lattice casing 221 84  
 lattice girder 235 12  
 lattice mast 258 18  
 lattice structures 1 9-14  
 lattice swing bridge 215 63  
 launch 225 25  
 launcher 258 49  
 launching container 258 32  
 launching housing 259 26  
 launching ramp 255 66  
 launch phase escape tower 234 66  
 lauter battery 92 51  
 lauter tun 92 50  
 lava plateau 11 14  
 lava stream 11 18  
 lavatories 317 31  
 lavatory 49 12; 146 29; 207 16, 42, 72; 211 59; 231 31; 278 5  
 lavatory, public ~ 268 62  
 lavender 380 7  
 lawn 37 46; 51 33; 272 36; 274 12  
 lawn aerator 56 15  
 lawn mower, electric ~ 56 31  
 lawn mower, motor ~ 56 28  
 lawn rake 51 3; 56 3  
 lawn sprinkler 37 43; 56 43  
 lay-by 217 27  
 layer 54 11, 12  
 layer, bast ~ 54 35  
 layer, bituminous ~ 200 58  
 layer, level ~ 123 39  
 layer, raffia ~ 54 35  
 layer, top ~ 123 41  
 layer cloud 8 3, 4, 8, 9, 10  
 layering 54 10  
 layette 28  
 layette box 28 18

lay figure 338 31  
 laying battery 74 19  
 laying hen 74 57  
 laying-on trowel 118 56  
 laying up 216 14  
 lay shaft 192 37  
 L-D converter 147 45-50  
 lead *Kitch.* 39 25  
 lead *Dog* 70 30  
 lead *Slaughterho.* 94 9  
 lead *Arc Weld.* 142 25  
 lead *Navig.* 224 59  
 lead, electric ~ *Household* 50 77  
 lead, electric ~ *Gdn. Tools* 56 32  
 lead, oval ~ 89 88  
 lead, pear-shaped ~ 89 90  
 lead, spare ~ 151 46  
 lead came 124 13  
 leader *Dwellings* 37 13  
 leader *Roof & Boilerr.* 38 10  
 leader *Fish Farm.* 89 78  
 leader *Photog.* 114 9  
 leader *Carriages* 186 46  
 leader *Mountain.* 300 25  
 leader *Script* 342 48  
 lead hammer 124 11  
 leading article 342 48  
 leading edge *Sailing* 284 42  
 leading edge *Gliding* 287 34  
 leading edge, carbon fibre reinforced ~ 235 32  
 leading-edge flap, profiled ~ 229 54  
 leading lady 310 27  
 leading light, higher ~ 224 102  
 leading light, lower ~ 224 101  
 leading lights 224 101-102  
 leading man 310 28  
 leading soloist 314 28  
 lead-in tube 153 40  
 lead knife 124 12  
 leadline 224 60  
 leads 89 88-92; 224 58-67  
 leadscrew 149 19, 32  
 leadscrew handwheel 149 13  
 leadscrew reverse-gear lever 149 6  
 lead shot 89 89  
 lead sinker 224 59  
 leaf 58 3, 53; 59 17; 68 8; 333 24; 370 19, 26; 371 21, 23, 27, 29, 68; 372 23; 373 3, 16, 25; 374 28; 375 2; 378 15, 18, 19, 41, 45; 384 55, 62  
 leaf, alternate pinnate ~ 59 40  
 leaf, basal ~ 375 9, 12, 15, 30; 383 2  
 leaf, pinnate ~ 57 3  
 leaf, sprouting ~ 59 29  
 leaf, ternate ~ 58 19  
 leaf, trifoliate ~ 58 19  
 leaf, young ~ 59 29  
 leaf axil 370 25; 375 38  
 leaf blade 68 20; 370 28, 85  
 leaf bud 59 47; 370 90  
 leaf cluster, rooted ~ 54 17  
 leaf drop 80 20  
 leaf fat 95 45



leaflet 263 9  
 leaf margin shapes 370 43-50  
 leaf ornament 334 40  
 leaf roller 82 43  
 leaf shapes 370 31-38  
 leaf sheath 68 9, 21; 370 83; 384 30  
 leaf stalk 370 27; 371 73  
 leaf tendril 57 4  
 leaf vegetables 57 28-34  
 leakage steam path 153 28  
 lean forward 301 36  
 lean-to roof 37 78; 121 7  
 leaping hind leg 358 11  
 learner-swimmer 282 17  
 learning programme, audio-visual ~ 242 7  
 lease rod 166 38  
 leash 70 30  
 leather beetle 81 22  
 leathers 290 26  
 leather side 131 13, 18  
 leaves 276 43  
 leaves, compound ~ 370 39-42  
 lebkuchen 97 51  
 lectern 262 4; 330 2, 37  
 lecture 262 1  
 lecture notes 262 5  
 lecturer 262 3  
 lecture room 262 2  
 lecture theatre 262 2  
 lederhosen 29 32  
 ledge *Photograv.* 182 23  
 ledge *Mountain* 300 4  
 ledge, cushioned ~ 277 16  
 ledger 118 26  
 ledger tube 119 48  
 leeboard 220 7; 283 63  
 leech *Sailing* 284 45  
 leech *Invertebr.* 357 20  
 leech pocket 284 43  
 leek 57 21  
 lee waves 287 17  
 left 254 19, 21, 23  
 left corner pin 305 6  
 left front second pin 305 2  
 left luggage locker 204 21  
 left luggage office 204 27  
 left tank fuel gauge 230 16  
 leg *Man* 16 49-54; 17 22-25  
 leg *Game* 88 21, 37, 81  
 leg *Meat* 95 1, 38  
 leg *Mach. Parts etc.* 143 2  
 leg *Maths.* 346 27  
 leg, back ~ 82 8  
 leg, broken ~ 21 11  
 leg, downwind ~ 285 23  
 leg, first ~ 285 19  
 leg, fractured ~ 21 11  
 leg, front ~ 82 6  
 leg, hind ~ *Dog* 70 7  
 leg, hind ~ *Horse* 72 33-37  
 leg, hind ~ *Bees* 77 3, 6-9  
 leg, hind ~ *Game* 88 22, 63  
 leg, middle ~ 82 7  
 leg, second ~ 285 20  
 leg, third ~ 285 21  
 leg, tubular ~ 114 44  
 leg, vertical ~ 143 4  
 leg, windward ~ 285 22

leg armour 319 19  
 legato 321 33  
 leg boot, high ~ 101 7, 13  
 leg boot, men's ~ 101 7, 13  
 legend 252 11  
 leg feather 362 3  
 leggings 28 24; 29 45; 352 17  
 leg holder 23 11  
 leg of mutton piece 95 22, 29  
 leg ring 74 54  
 legs 82 6-8  
 leg space ventilation 191 81  
 leg support 23 10, 11  
 legume 57 6; 370 92  
 legume, immature ~ 374 22  
 legume, unripe ~ 374 22  
 Leguminosae 57 1-11  
 leg vice 140 10  
 Leine rock salt 154 64  
 leisure centre 281  
 lemon 384 23  
 lemonade 265 15  
 lemonade glass 265 16  
 lemon peel, candied ~ 98 10  
 lemon squeezer 40 9  
 lending library 262 18  
 length adjustment 100 20  
 lengthening arm 151 57  
 lengths of material 104 2  
 length stop 157 68  
 lens *Man* 19 48  
 lens *Photog.* 115 32, 84; 116 32  
 lens *Composing Rm.* 176 23  
 lens *Audiovis.* 243 2, 52  
 lens *Films* 313 2  
 lens *Crystals* 351 33  
 lens, bifocal ~ 111 15  
 lens, concave and convex ~ 111 41  
 lens, convex and concave ~ 111 42  
 lens, fisheye ~ 115 44  
 lens, flat ~ 111 38  
 lens, flush ~ 114 5  
 lens, interchangeable ~ 112 62; 115 43  
 lens, long focal length ~ 115 48  
 lens, long-focus ~ 115 49  
 lens, medium focal length ~ 115 47  
 lens, negative ~ 111 37  
 lens, normal ~ 115 3-8, 46; 117 49  
 lens, plano-concave ~ 111 39, 40  
 lens, positive ~ 111 37  
 lens, short focal length ~ 115 45  
 lens, special ~ 111 38  
 lens, standard ~ 115 3-8, 46; 117 49  
 lens, telephoto ~ 115 48  
 lens, variable focus ~ 117 2  
 lens, varifocal ~ 117 2  
 lens, wide-angle ~ 115 45; 117 48  
 lens barrel 115 3  
 lens carrier 177 27  
 lens case 115 104

lens head 117 46-49  
 lens hood 313 3, 10  
 lens hood barrel 313 5  
 lens hood bellows 313 39  
 lens panel 112 18  
 lens pouch, soft-leather ~ 115 105  
 lens standard 114 52  
 lens surface 111 37  
 lens system 242 83  
 lens turret 117 46; 313 32  
 lenticular 287 19  
 Lent lily 60 3, 12  
 Leo 3 17; 4 57  
 Leonberger 73 16  
 leopard 368 6  
 leotard 297 51  
 Lepidoptera 358 48-56; 365 10  
 lepton 252 39  
 lesene 335 11  
 Lesser Bear 3 34  
 lesser celandine 375 36  
 Lesser Dog 3 15  
 lesser housefly 81 1  
 less-than-carload freight 206 4  
 let-off motion 166 59  
 let-off weight lever 166 62  
 let-out section 131 7  
 let-out strip 131 7  
 letter 174 44  
 letter, capital ~ 175 11  
 letter, double ~ 175 6  
 letter, initial ~ 175 1  
 letter, lower case ~ 175 12  
 letter, small ~ 175 12  
 letter, upper case ~ 175 11  
 letter carrier 236 53  
 letter container 236 32  
 letter feed 236 31  
 letter flags 253 22-28  
 letter-folding machine 249 44  
 lettering 129 40  
 lettering brush 129 41  
 lettering stencil 151 69  
 letter matrix 174 47; 176 16  
 letterpress machine, rotary ~ 181 41  
 letterpress machine, web-fed ~ 181 41  
 letterpress press, rotary ~ 181 41  
 letterpress printing 181  
 letterpress printing machines 181 1-65  
 letterpress printing method 340 1-13  
 letter rack 267 2  
 letter-rate item 236 55  
 letters, illuminated ~ 268 45  
 letter scales 236 24  
 letter-sorting installation 236 31-44  
 letter spacing 175 13  
 letter tray 245 30; 248 41  
 lettuce 57 36  
 lettuce leaf 57 37  
 leucite 351 12  
 levade *Horse* 71 4  
 levade *Circus* 307 30  
 levee 13 9; 216 49

level 14 48  
 level, lower ~ 217 17  
 level, motor-driven ~ 112 69  
 level, upper ~ 217 25  
 level crossing 15 26  
 level crossing, protected ~ 202 39  
 level crossing, unprotected ~ 202 49  
 level crossings 202 39-50  
 level indicator 316 57  
 leveling see levelling  
 levelling 14 46  
 levelling and support shovel 255 94  
 levelling beam 201 3, 4  
 levelling blade 200 18  
 levelling staff 14 47  
 lever *Plumb. etc.* 126 19  
 lever *Sawmill* 157 46  
 lever *Cotton Spin.* 164 42  
 lever *Office* 249 50  
 lever *Graphic Art* 340 61  
 lever for normal and coarse threads 149 4  
 lever hang 296 56  
 lever mechanism 203 54  
 liberty horses 307 30-31  
 Libra 3 19; 4 59  
 librarian 262 14, 19  
 library, ship's ~ 223 25  
 library ticket 262 25  
 library user 262 24  
 license plate 189 8  
 lichgate 331 19  
 licker-in 163 53  
 licker-in roller 163 53  
 licker-in undercasing 163 54  
 lid *Kitch. Utensils* 40 13  
 lid *Electrotyp. etc.* 178 37  
 lid *Chem.* 350 52  
 lid, glass ~ 269 56  
 lid, hinged ~ 127 24  
 lid, sliding ~ 179 2  
 lid clip 50 83  
 lido deck 223 22  
 Lieberkühn reflector 115 97  
 liege lord 329 67  
 lifebelt 221 124; 222 24; 280 3; 281 6  
 lifebelt light 221 125  
 lifeboat *Offshore Drill.* 146 19  
 lifeboat 221 78, 107; 223 19  
 lifeboat launching gear 221 101-106  
 lifebuoy *Ship* 221 124  
 lifebuoy *Shipbulld.* 222 24  
 lifebuoy *Bathing* 280 3  
 lifebuoy light 221 125  
 lifeguard 280 1  
 lifeguard station 280 46  
 life jacket 286 20  
 life jacket, cork ~ 228 9  
 life jacket, inflatable ~ 228 8  
 life line 19 72  
 lifeline 221 103; 228 12; 280 2  
 life preserver, cork ~ 228 9  
 life raft 228 19; 258 11; 286 19  
 life rocket 228 2  
 lifesaver 21 36; 280 1

life saving 228  
 life support pack 6 20  
 life support system 6 20  
 lift *Ship* 219 47  
 lift *Store* 271 45  
 lift *Theatre* 316 33  
 lift, hydraulic ~ 195 25, 26  
 lift, vertical ~ 170 36  
 liftback 193 29  
 lift bridge 225 70  
 lift cage 271 46  
 lift car 271 46  
 lift chair 214 16  
 lift chair, double ~ 214 17  
 lift controls 271 48  
 lift device 103 24  
 lift dump 229 42  
 lifter *Agr. Mach.* 64 59  
 lifter *Sawmill* 157 46  
 lifter rail 164 30  
 lifter roller 181 63  
 lifting arm 255 76  
 lifting bolt 164 37  
 lifting crane 270 48  
 lifting device 255 76  
 lifting gear 206 56  
 lifting hook 85 6  
 lifting motor 150 22  
 lifting platform 232 19  
 lifting rod 65 29  
 lifting rod adjustment 65 25  
 lifting spindle 217 36  
 lifting undercarriage 232 18  
 lift-off hinge 140 49  
 lift operator 271 47  
 lift platform 173 40  
 lift shaft 271 51  
 ligament, falciform ~ 20 34  
 ligature *First Aid* 21 14-17  
 ligature *Composing Rm.* 175 6  
 ligature-holding forceps 26 44  
 light 106 8; 210 46; 224 69  
 light, flashing ~ 270 6  
 light, fluorescent ~ 271 23  
 light, leaded ~ 124 14  
 light, polar ~ 7 30  
 light, rear ~ 187 46; 189 9  
 light, supplementary ~ 203 17  
 light ale 93 26  
 light and bell buoy 224 74  
 light and whistle buoy 224 68  
 light beer 93 26  
 light box 179 25  
 light bulb 127 69; 318 26  
 light-emitting diode readout 110 2  
 lighter 216 25; 225 8, 25  
 lighter, disposable ~ 107 30  
 lighter, tug-pushed ~ 221 94  
 lighterman 216 26  
 light face 175 8  
 lighthouse *Map* 15 8  
 lighthouse *Navig.* 224 103  
 lighting, external ~ 197 32  
 lighting, indirect ~ 317 12  
 lighting, internal ~ 197 32  
 lighting aperture 334 75  
 lighting bridge, travelling ~ 316 19

lighting console 316 2  
 lighting control console 316 2  
 lighting effects 316 2  
 lighting electrician 310 37  
 lighting gallery, travelling ~ 316 19  
 lighting man 310 37; 316 20  
 lighting operator 316 20  
 lighting plot 316 3  
 lighting station 226 27  
 lighting technician 307 4  
 lightning 9 39  
 lightning arrester 152 35  
 lightning conductor 38 30  
 lightning rod 38 30  
 light plot 316 3  
 light railway diesel locomotive 200 24  
 light rays 1 62  
 light readout 195 9  
 lights, set of ~ 268 54  
 light section tube 112 38  
 light-sensitive section 77 22  
 lightship *Map* 15 13  
 lightship *Ship* 221 47  
 lightship *Navig.* 224 81  
 light source *Atom* 1 59  
 light source *Optic. Instr.* 112 52  
 light source, photometric ~ 112 50  
 light stop 5 22  
 light vessel 221 47; 224 81  
 ligula 68 22; 370 84  
 ligule 68 22; 370 84  
 lily 60 12  
 lily of the valley 377 2  
 limb 370 5  
 limb, fractured ~ 21 10  
 limb, moon's ~ 4 41  
 limbing machine 85 18  
 limbs 16 43-54  
 lime 147 56  
 lime, reconverted ~ 172 52  
 lime bunker 147 62  
 lime kiln 15 86  
 limerick 89 84  
 lime slaker 172 51  
 limestone 160 1  
 lime tree 371 46  
 limiter display 238 44  
 limit switch 241 60  
 limousine 193 1  
 linden plant 53 9  
 linden tree 371 46  
 line *Horse* 71 33  
 line *Composing Rm.* 175 4  
 line *Carriages* 186 31  
 line *Railw.* 202 1-38  
 line *Theatre* 316 8  
 line *Maths.* 346 1-23  
 line, curved ~ 346 21  
 line, equinoctial ~ 3 3  
 line, horizontal ~ 344 15  
 line, local ~ 15 25  
 line, straight ~ 346 2-3, 5, 16  
 linear 370 31  
 line block 178 42  
 line-casting machine 174 19  
 line cut 178 42  
 line engraving 178 42



line etching 178 42  
 line glass 124 6  
 line guide 89 60  
 linen 206 11  
 linen, dirty ~ 50 22  
 linen bin 50 21  
 linen compartment 267 31  
 linen drawer 44 22; 47 22  
 linen goods 271 57  
 linen shelf 43 2  
 linen tester 177 23  
 line-of-battle ship 218 51-60  
 line of fencing 294 9  
 line of latitude 14 2  
 line of life 19 72  
 line of longitude 14 4  
 line of the head 19 73  
 line of the heart 19 74  
 line of the staff 320 43  
 line plate 178 42  
 liner 221 82; 225 32  
 lines *Horse* 71 25  
 lines *Rowing* 283 52  
 line shooting 89 20  
 linesman *Railw.* 202 44  
 linesman *Ball Games* 291 59;  
 293 69  
 lines of the hand 19 72-74  
 line space adjuster 249 23  
 line space and carrier return  
 key 249 4  
 line steam injector 210 41  
 line-throwing gun 228 1  
 lingerie 32 1-15  
 lining *Bldg. Site* 119 54  
 lining *Hist. Cost.* 355 57  
 lining, fireproof ~ 147 48  
 lining, knitwear ~ 101 17  
 lining, leather ~ 291 22  
 lining, refractory ~ 147 48  
 lining, tricot ~ 101 17  
 lining board *Bldg. Site* 118  
 41; 119 18  
 lining board *Floor etc. Constr.*  
 123 56  
 lining paper 128 5  
 lining paper, shredded ~ 128  
 8  
 link 36 39  
 link, lower ~ 65 28  
 link, top ~ 65 27  
 linkage, three-point ~ 64 45;  
 65 72  
 linking of modules 242 70  
 link-up of modules 242 70  
 Linotype line-composing  
 machine 174 19  
 Linotype matrix 174 29  
 lint 383 19  
 lintel 37 25; 118 9  
 lintel, reinforced concrete ~  
 118 13  
 Linz-Donawitz converter 147  
 45-50  
 Lion *Astron.* 3 17; 4 57  
 lion 307 56; 356 5; 368 2  
 lip, lower ~ *Man* 19 26  
 lip, lower ~ *Horse* 72 10  
 lip, lower ~ *Music. Instr.* 326  
 26  
 lip, upper ~ *Man* 19 14

lip, upper ~ *Horse* 72 8  
 lip, upper ~ *Music. Instr.* 326  
 27  
 lip of the pudendum 20 87  
 lip of the vulva 20 87  
 lip plug 354 23  
 liquefied-gas tanker 221 35  
 liqueur 98 58  
 liqueur decanter 45 48  
 liqueur glass 45 89; 317 7  
 liquid-column barometer 10  
 1  
 liquid crystal readout 110 2  
 liquid feed pipe 74 26  
 liquid hydrogen and liquid  
 oxygen tank, jettisonable ~  
 235 46  
 liquid hydrogen line 234 51;  
 235 50  
 liquid hydrogen pump, high-  
 pressure ~ 235 41  
 liquid hydrogen suction line  
 234 23  
 liquid hydrogen supply, main  
 ~ 235 35  
 liquid hydrogen tank 234 26,  
 41  
 liquid level indicator 316 57  
 liquid manure channel 75 44  
 liquid manure silo 62 13  
 liquid oxygen line 234 52; 235  
 51, 56  
 liquid oxygen pump, high-  
 pressure ~ 235 42  
 liquid oxygen supply line 234  
 10  
 liquid oxygen tank 234 12, 24,  
 39  
 liquid stage 148 27  
 liquor 168 14  
 liquor, weak ~ 172 45  
 liquor preheater 172 8  
 liquor pump 172 33  
 liquor supply pipe 92 48  
 lira 252 20, 21  
 literature 330 57  
 literature stand 330 56  
 litho artist 340 45  
 Lithodes 369 16  
 lithographer 340 45  
 lithographic crayon 340 26  
 lithographic press 340 60  
 lithographic stone 340 25, 57  
 lithography 340 25-26  
 lithosphere 11 1  
 litter *Poultry Farm* 74 8  
 litter *Livestock* 75 6  
 litter *Town* 268 22  
 litter basket 37 63; 205 55;  
 272 43; 273 25  
 litter bin 37 63; 205 55; 268 5;  
 272 43; 273 25  
 litter receptacle 196 12; 207  
 55  
 Little Bear 3 34  
 little brain 17 45; 18 23  
 little cluster fungus 381 33  
 Little Dipper 3 34  
 Little Dog 3 15  
 little owl 362 19  
 livelong 377 9

live power take-off 65 31  
 live power take-off shaft 65  
 31  
 liver 20 10, 34-35  
 livery 186 21  
 live sound 117 100  
 livestock, small 213 28  
 livestock ramp 206 1  
 living quarters 224 108; 227  
 19; 259 84  
 living room 42  
 lizards 364 27, 30-37  
 llama 366 28  
 load 73 5  
 load, driven ~ 226 19  
 load, foil-wrapped ~ 226 9  
 load, unitized ~ 226 9, 21  
 load hook 270 49  
 loading bridge 221 90; 226 2  
 loading chamber 116 6  
 loading crane 85 28, 44  
 loading deck 221 34  
 loading dock 206 9  
 loading door 207 23  
 loading foreman 205 30; 206  
 29  
 loading gauge 206 22  
 loading platform *Lorries etc.*  
 194 3  
 loading platform *Ship* 221 90  
 loading siding 206 17  
 loading strip 206 8  
 loading supervisor 206 36  
 loaf, French ~ 97 12  
 loaf, long ~ 97 8  
 loaf, round ~ 97 6, 7; 99 14  
 loaf, small ~ 97 7  
 loaf, white ~ 97 9  
 loaf of bread 97 2  
 loam 120 44; 159 2  
 loan, personal ~ 250 4  
 lobby 267 18-26; 315 12-13  
 lobe 229 30  
 lobe, pulmonary ~ 20 7  
 lobe, upper ~ 20 7  
 lobe of the liver 20 35  
 lobster fork 45 79  
 local-battery telephone 224  
 27; 238 9, 40  
 lock *Map* 15 58  
 lock *Hunt.* 87 9  
 lock *Hydr. Eng.* 217 20  
 lock approach 217 26  
 lock chamber 217 20  
 lock gate 217 18, 32  
 lock indicator panel 203 63  
 locking bolt 117 62  
 locking lever *Atom* 2 40  
 locking lever *Motorcycles etc.*  
 188 2  
 locking lever *Office* 247 42  
 locking mechanism 246 23  
 locking nut 143 30; 187 54  
 lock lever 203 55  
 locknut 143 30; 187 54  
 locksmith 140 1  
 lock washer 202 8  
 locomotive, articulated ~ 210  
 64  
 locomotive, electric ~ 205 35;  
 211 1

locomotive, elevation of ~  
 212 51-67  
 locomotive, fireless ~ 210 68  
 locomotive, mainline ~ 212 1  
 locomotive boiler 210 2-37  
 locust tree 371 70  
 loft 37 4; 38 18  
 log *Forestry* 84 20, 31  
 log *Maths.* 345 6  
 log, mechanical ~ 224 54  
 log, sawn ~ 157 33  
 log, ship's ~ 224 22  
 logarithm 345 6  
 logarithm sign 345 6  
 log capacity scale 157 10  
 log chain, endless ~ 157 17  
 log clock 224 57  
 log dump 85 32; 157 31  
 log grips 85 29; 157 13, 39  
 log grips, pivoted ~ 157 29  
 logic element 242 68  
 logic module 242 68  
 log-kicker arm 157 19  
 log ladder 273 22  
 loin *Game* 88 18, 35  
 loin *Meat* 95 3  
 loin *Butch.* 96 4  
 loin, pork ~ 95 46  
 loincloth 352 38; 354 31  
 loins *Man* 16 24  
 loins *Horse* 72 30  
 loin strap 71 32  
 long-conductor antenna 230  
 66  
 long-distance racing 290  
 11-15  
 long-distance runner 298 5  
 long drink 317 32  
 long-eared bat 366 9  
 long-eared owl 362 14  
 long-fly 296 48; 297 20  
 long haul airliner 231 13, 14  
 long horse 296 1  
 longicorn 358 38  
 longicorn beetle 358 38  
 longitude 14 7  
 long johns 32 29  
 long jump 298 37-41  
 long line 90 28  
 long-line fishing 90 28-29  
 long-lining 90 28-29  
 long measure 294 10  
 long primer 175 27  
 long rifle cartridge 305 38  
 longship 218 13-17  
 long sitting 295 10  
 longwall face, cut ~ 144 34  
 longwall face, ploughed ~ 144  
 33  
 longwall faces 144 33-37  
 long-wire antenna 230 66  
 lookout platform 273 23  
 loom, automatic ~ 166 1, 35  
 loom framing 166 24  
 loop *Knitting* 167 62, 66  
 loop *Weaves* 171 39  
 loop *Airsports* 288 1  
 loop *Winter Sp.* 301 7; 302 15  
 loop, closed ~ 171 36  
 loop, open ~ 171 30  
 loop, platinum ~ 23 15

loop, primary ~ 154 2, 42  
 loop, secondary ~ 154 7, 45  
 loop antenna 223 5  
 loop paper 49 11  
 loop fastening 30 41  
 loop formation 167 65  
 loop former 312 30  
 loose-leaf file 260 15  
 Lophocalyx philippensis 369  
 7  
 lopping 85 11  
 lords-and-ladies 379 9  
 Lord's table 330 4  
 lorries 194  
 lorry 226 19  
 lorry, heavy ~ 194 20; 200 7  
 lorry, light ~ 194 1, 5  
 lorry, toy ~ 47 38; 273 62  
 lorry tyre 273 19  
 lorry wheel 138 21  
 lorry with trailer 213 34  
 loser 299 40  
 lot 310 1  
 lottery booth 308 44  
 lottery ticket seller 266 20  
 lotus column 333 13  
 loud hailer 264 12  
 loud pedal 325 8  
 loudspeaker 42 10; 241 14;  
 264 12; 311 46; 317 15; 318  
 12  
 loudspeaker, built-in ~ 249  
 70  
 loudspeaker aperture 309 19  
 louis-d'or 252 5  
 Louis Seize table 336 14  
 lounge *Living Rm.* 42  
 lounge *Ship* 223 26  
 lounge *Airport* 233 18  
 'lounge' *Airport* 233 28  
 louver 321 29  
 louvre shutter 304 12  
 love-lies-bleeding 60 21  
 low 9 5  
 low box 172 26  
 lower cable sleeve 214 74  
 lower fore topgallant sail 219  
 58  
 lower fore topgallant yard 219  
 35  
 lower fore topsail 219 56  
 lower fore topsail yard 219 33  
 Lower Keuper 154 57  
 lower main topgallant sail  
 219 64  
 lower main topgallant yard  
 219 41  
 lower main topsail 219 62  
 lower main topsail yard 219  
 39  
 Lower Muschelkalk 154 60  
 lower station platform 214  
 51  
 low house 305 76  
 low-moor bog 13 14  
 low-pressure area 9 5  
 low-pressure manometer 141  
 6  
 low-pressure regulator 190 59  
 low relief 339 33  
 low-speed aileron 229 41

low-temperature surface  
 insulation 235 15  
 low tide 280 7  
 low-voltage bushing 152 44  
 low-voltage terminal 152 44  
 lozenge 346 35  
 L-seat 295 10  
 L-support 295 16  
 lubber's line 224 48  
 lubber's mark 224 48  
 lubber's point 224 48  
 lubricant pump, automatic ~  
 210 42  
 lubricating nipple 143 81  
 lubricating oil 145 62  
 lubricating oil refinery 145 67  
 lubricating system, pressure-  
 feed ~ 192 16-27  
 lubrication hole 187 62  
 lubrication system 65 45  
 lubricator 187 62, 65  
 lubricator, automatic ~ 210 42  
 lucerne 69 9  
 ludo 47 19  
 luff 284 42  
 luffing 285 9  
 luffing jib crane 222 23  
 luge 303 13  
 luge, junior ~ 303 3  
 luge toboggan 303 13  
 luge toboggan, junior ~ 303 3  
 luge tobogganer 303 12  
 luggage 205 7-12  
 luggage carrier 187 44  
 luggage clerk 204 9  
 luggage compartment *Car*  
 193 17, 23  
 luggage compartment *Railw.*  
*etc.* 194 13  
 luggage compartment *Railw.*  
 207 71; 208 15  
 luggage counter 204 4  
 luggage label 205 8  
 luggage locker 194 18  
 'luggage lockers' 233 39  
 luggage rack 207 51; 208 27  
 luggage receipt 204 8  
 luggage rest 204 43  
 luggage sticker 204 7  
 lugger 90 1  
 lugsail 220 4  
 lug strap 166 22  
 lumbar region 72 30  
 lumber 120 2  
 lumber, rough ~ 120 83  
 lumberer 84 18  
 lumbering 84 15-37  
 lumberjack 84 18  
 lumber-jacket 30 38  
 lumberman 84 18  
 lumber room door 38 20  
 luminescent 369 14  
 luminescent material 240 18  
 lump coal 156 14  
 lunar module 234 55  
 lunar module hangar 234 54  
 lunation 4 2-7  
 lung 18 13; 20 6-7  
 lung, right ~ 20 6  
 lunge 295 42  
 lunging 294 5



lunging position 294 5  
 lungwort 377 7  
 lunula *Man* 19 81  
 lunula *Prehist.* 328 25  
 lunula *Church* 332 36  
 lunule 19 81  
 lupin 51 23  
 lur 322 1  
 lute 324 1  
 lute pin 324 11  
 lycaenid butterfly 365 6  
 lychgate 331 19  
 Lyman series 1 20  
 lymph gland, submandibular ~ 19 10  
 lynx 368 8  
 lynx fur 131 20  
 lynx skin 131 15  
 lynx skin, let-out ~ 131 16  
 Lyoner sausage 96 10  
 Lyra 3 22  
 Lyre *Astron.* 3 22  
 lyre *Music. Instr.* 322 15  
 lyre flower 60 5

## M

maar 11 25  
 macadam spreader 200 31  
 macaroni 98 33  
 macaroon, coconut ~ 97 37  
 mace 382 34  
 machicolation 329 23  
 machicolis 329 23  
 machine, four-cylinder ~ 189 49  
 machine, heavy ~ 189 43  
 machine, heavy-weight ~ 189 43  
 machine, high-performance ~ 189 43  
 machine, multi-magazine ~ 174 19  
 machine base 168 15  
 machine bed 177 57  
 machine chest 172 86; 173 1, 13  
 machine control lever 167 44  
 machine drum 323 57  
 machine gun 255 32  
 machine hood 173 27  
 machine housing 200 2  
 machine part 111 30  
 machine parts 143  
 machine processor 116 60  
 machinery and observation deck 224 107  
 machinery and observation platform 224 107  
 machinery shed 62 15  
 machine tap 150 44  
 machine tools 149; 150  
 machine wire 173 14  
 machining centre 150 41  
 mackerel sky 8 14  
 MacPherson strut unit 192 72-84  
 macramé 102 21  
 macro equipment 115 81-98  
 macro frame 117 56  
 macro lens attachment 117 55

macronucleus 357 11  
 Macropharynx longicaudatus 369 2  
 macrophoto stand 115 94  
 macro zoom lens 117 53  
 madeira glass 45 84  
 Madonna 330 51  
 Madonna lily 60 12  
 magazine *Doc.* 22 4  
 magazine *Flat* 46 20  
 magazine *Hunt.* 87 17  
 magazine *Cine Film* 117 45  
 magazine *Office* 249 33  
 magazine *Army* 255 15, 21  
 magazine *Police* 264 25  
 magazine *Chivalry* 329 13  
 magazine, rotary ~ 114 77  
 magazine, spring-loaded ~ 247 6  
 magazine back 115 80  
 magazine holder 255 7  
 magazine housing 313 9  
 magazine repeater 87 2  
 magazine rifle 87 2  
 magazine spring 87 18  
 magenta filter adjustment 116 43  
 maggot *Gdn. Pests* 80 19  
 maggot *Articulates* 358 19  
 'magic eye' 309 18  
 magmatism, plutonic ~ 11 29-31  
 magnesium plate 179 9  
 magnet 1 63; 2 51; 108 32; 212 38  
 magnetic disc store 244 1  
 magnetic film 311 21  
 magnetic film spool 311 2  
 magnetic head, four-track ~ 312 51  
 magnetic head cluster 312 28  
 magnetic head support assembly 311 3  
 magnetic sound amplifier 311 28  
 magnetic sound deck 311 20  
 magnetic sound head 312 50  
 magnetic sound recorder 310 58; 311 1  
 magnetic sound recording and playback deck 238 4  
 magnetic sound recording and playback amplifier 311 5  
 magnetic sound recording equipment 310 58; 311 1  
 magnetic sound unit, attachable ~ 312 50  
 magnetic sound unit, four-track ~ 312 50  
 magnetic tape 237 63; 238 4, 5; 244 2  
 magnetic tape dictating machine 249 62  
 magnetic tape loop 245 28  
 magnetic tape recording and playback equipment 238 55  
 magnetic tape reel 244 10  
 magnetic tape station 242 32  
 magnetic tape unit 244 9

magnifier 175 34  
 magnifying glass 175 34; 177 23  
 magnitude 3 14  
 magpie 361 3  
 magpie moth larva 58 5  
 maharaja 306 28  
 mahlstick 129 47  
 mail 329 62, 63  
 mail and cargo terminal 233 9  
 mailbag 236 54  
 mailbox 236 50  
 mail carrier 236 53  
 mailcoach 186 39, 53  
 mailcoach driver 186 40  
 mailman 236 53  
 mail van 236 52  
 main air pressure gauge 212 6  
 main air reservoir pressure gauge 212 8  
 main beam warning light 191 69  
 main course 218 33; 219 61  
 main drive unit 113 15  
 main engine revolution indicator 224 21  
 main engine room 223 72  
 main exchange line 237 18, 24  
 main line 203 45  
 mainmast 218 40; 219 5-7; 220 22  
 mainmast, lower ~ 219 5  
 main royal sail 219 66  
 main royal staysail 219 26  
 main royal yard 219 43  
 mainsail 218 33; 219 61; 220 11; 284 46; 285 2  
 mains button 195 11  
 mainsheet 284 28  
 mains power unit 311 11  
 maintained lift 299 5  
 maintenance technician 237 28  
 main title 185 46  
 maintop 219 52  
 main topgallant mast 219 7  
 main topgallant rigging 219 18  
 main topgallant sail 218 53  
 main topgallant staysail 219 25  
 main topmast 219 6  
 main topmast crossrees 219 53  
 main topmast rigging 219 17  
 main topmast staysail 219 24  
 main topsail 218 38  
 main topsail yard 218 39  
 main yard 218 37; 219 38  
 maize 68 1, 31  
 maize billbug 81 26  
 maize cob 68 36  
 maize kernel 68 37  
 majorette 306 67  
 major keys 320 55-68  
 major second 321 7  
 major seventh 321 12  
 major sixth 321 11  
 major third 321 8  
 major triad 321 1  
 majuscule 175 11

maker-up 174 5  
 make-up artist 310 36; 315 48  
 make-up artist, chief ~ 315 47  
 make-up gown 315 44  
 make-up man, chief ~ 315 47  
 make-up table *Offset Platem.* 179 23  
 make-up table *Theatre* 315 45  
 Malacosteus indicus 369 10  
 malaria mosquito 81 44  
 malleolus, external ~ 19 59  
 malleolus, inner ~ 19 60  
 malleolus, internal ~ 19 60  
 malleolus, lateral ~ 19 59  
 malleolus, medial ~ 19 60  
 malleolus, outer ~ 19 59  
 malleolus fibulae 19 59  
 malleolus medialis 19 60  
 malleolus tibiae 19 60  
 mallet 118 54; 120 67; 125 18; 132 5; 158 36; 278 25; 339 21  
 malleus 17 61  
 malt 92 1-41  
 malt, green ~ 92 23  
 malt beer 93 26  
 malt elevator 92 35  
 maltese cross mechanism 312 38  
 maltese cross movement 312 38  
 malting 92 1-41  
 maltings 92 1  
 malting tower 92 1  
 malt silo 92 37  
 mamma 16 28-29  
 mammal, flying ~ 366 9  
 mammal, oviparous ~ 366 1  
 mammal, scaly ~ 366 10  
 mammals 366; 367; 368  
 mammals, insect-eating ~ 366 4-7  
 mammals, marsupial ~ 366 2-3  
 mammoth tree 372 69  
 Man 16; 17; 18; 19; 20  
 manager 299 45  
 manatee 366 23  
 manati 366 23  
 mandarin *Carnival* 306 29  
 mandarin *South. Fruits* 384 23  
 mandible *Man* 17 35  
 mandible *Articulates* 358 25  
 mandible, lower ~ 359 8  
 mandolin 324 16  
 mandrel 125 19  
 mane 72 13  
 mane, lion's ~ 368 3  
 man-eater 364 1  
 maneuver *see* manoeuvre  
 maneuvering *see* manoeuvring  
 mangelwurzel 69 21  
 manger board 258 7, 76  
 mangle 165 46  
 mangold 69 21  
 mangoldwurzel 69 21  
 manhole *Roof & Boilerr.* 38 45

manhole *Brew.* 93 13  
 manhole *Cooper* 130 18  
 manhole *Space* 234 30; 235 52  
 manhole *Water* 269 26, 51  
 manhole cover *Roof & Boilerr.* 38 46  
 manhole cover *Cooper* 130 19  
 manhole cover *Street Sect.* 198 17  
 manikin 338 31  
 manipulator 2 38  
 manipulator, mechanical ~ 139 32  
 manipulators 2 47  
 man-made fibres 169; 170  
 mannequin 338 31  
 manoeuvres, principal, of aircraft 230 67-72  
 manoeuvring keel 227 30  
 manoeuvring rocket assembly 234 63  
 manoeuvring rockets 6 5, 39  
 manometer 25 22; 67 10; 83 42; 178 8; 196 20; 349 19  
 manostat 269 47  
 manque 275 22  
 mansard dormer window 121 19  
 mansard roof 121 18  
 mantelpiece 267 24  
 mantelshelf 267 24  
 mantissa 345 6  
 mantle *Phys. Geog.* 11 3  
 mantle *Iron & Steel* 147 46  
 mantle *Heraldry* 254 3  
 mantle clock 42 16  
 mantling 254 3, 14  
 manual 325 48; 326 42, 43, 44, 45  
 manual, lower ~ 322 47  
 manual, upper ~ 322 46  
 manual feed station 184 2  
 manure 63 15  
 manure distributor 62 21  
 manure fork, four-pronged ~ 66 7  
 manure gutter 75 20  
 manure hoe 66 8  
 manure removal 74 23-27; 75 21  
 manure spreader 62 21; 63 39  
 manway 154 32  
 map *Map* 14; 15  
 map 204 15; 260 44; 268 2  
 maple seed 371 57  
 maple tree 371 53  
 map light 230 23  
 map of the world 14 10-45  
 mapping 348 9, 10  
 mapping, one-to-one ~ 348 11  
 mappings 348 9-11  
 map projections 14 8-9  
 map signs 15 1-114  
 map symbols 14 27-29; 15 1-114  
 maraca 324 59  
 marcando 321 27  
 marcato 321 27  
 mare 73 2

margarine 98 21; 99 48  
 margin 185 55-58  
 margin, back ~ 185 55  
 margin, inside ~ 185 55  
 margin, outside ~ 185 57  
 margin, upper ~ 185 56  
 margin control 180 5, 20  
 margin release key 249 6  
 margin scale 249 12  
 margin stop, left ~ 249 13  
 margin stop, right ~ 249 14  
 marguerite 51 24; 376 4  
 marimba, steel ~ 324 61  
 marimbaphone 324 61  
 marine sequence 310 11  
 mark 285 17  
 mark, port hand ~ 224 95  
 mark, starboard hand ~ 224 96  
 marker 85 12  
 marker, port ~ 224 100  
 marker, starboard ~ 224 99  
 market for securities 251 2  
 market garden 55 1-51, 3  
 market place 15 52  
 market square 15 52  
 market woman 308 65  
 markiert 321 27  
 marking, axillary ~ 88 74  
 marking hammer 85 12  
 marking iron 85 12  
 marking out 104 21  
 markings, graduated ~ 115 65  
 mark of omission 342 29  
 marks, diacritical ~ 342 30-35  
 marl 160 1  
 marmot 366 18  
 maroon 306 53  
 marquise 36 55  
 marriage ceremony 332 14  
 Mars 4 46  
 marsh *Phys. Geog.* 13 14-24  
 marsh *Map* 15 20  
 marshal 329 75  
 marshaling *see* marshalling  
 marshalling yard 206 42  
 marshalling yard signal box 206 44  
 marsh harrier 362 13  
 marshmallow *Bakery* 97 36  
 marshmallow *Med. Plants* 380 12  
 marsh plants 378 14-57  
 marsh tea 377 21  
 marsupials 366 2-3  
 marten 86 22  
 martens 367 14-17  
 martinet 218 36  
 marzipan 98 82  
 Masai warrior 354 8  
 mash 93 10  
 mash copper 92 44  
 masher 92 49  
 mashhouse 92 42-53  
 mashing process 92 42-53  
 mash kettle 92 44  
 mash thermometer 93 9  
 mash tub 92 43  
 mash tun 92 43, 44  
 mask *Hosp.* 27 48  
 mask *Swim.* 279 10



mask *Carnival* 306 7  
 mask *Films* 310 51; 313 4  
 mask *Sculpt. Studio* 339 37  
 mask, clay ~ 260 75  
 mask, pressure-equalizing ~ 279 10  
 mask, wooden ~ 354 16  
 mask drum 177 48  
 masked ball 306 1-48  
 masking frame 116 35  
 masking tape 128 16  
 mask-scanning head 177 47  
 masonry bonds 118 58-68  
 masonry dam 217 58  
 masquerade 306 1-48, 6-48  
 mass 11 43  
 mass, continental ~ 11 7  
 massage bath 281 33  
 mass book 330 38  
 masseter 19 7  
 massif 12 39  
 mast 219 1-9; 221 77; 284 4, 11  
 mast, full-rigged ~ 220 16  
 mast, half-rigged ~ 220 15  
 Master 289 45  
 master arm 2 42  
 master brewer 92 49  
 master butcher 96 38  
 master clock 245 18  
 master compass 224 51  
 master control panel 242 3  
 master furrow 91 18  
 master gyro compass 224 51  
 Master of foxhounds 289 45  
 master selector 195 8  
 master/slave manipulator 2 47  
 master station 224 40  
 master switch 153 2  
 master turner 135 20  
 master volume control 261 44  
 masterwort 376 7  
 mat 299 12  
 matador 319 25, 31  
 match 107 22  
 matchbox 107 21  
 matchbox holder 266 24  
 match head 107 23  
 mate 276 15  
 maté 382 11  
 material *School* 260 81  
 material *Store* 271 59  
 material, basic ~ 169 1  
 material, radioactive ~ 1 28  
 materials store 146 6  
 maté shrub 382 11  
 mathematics 344; 345; 346; 347; 348  
 mathematics, higher ~ 345 11-14  
 matinée coat 29 3  
 matrix *Man* 20 79  
 matrix *Composing Rm.* 174 21, 31  
 matrix, punched ~ 175 37  
 matrix, stamped ~ 175 37  
 matrix-boring machine 175 49  
 matrix case 174 42, 46; 176 17  
 matrix clamp 175 59

matrix disc 176 20  
 matrix drum 176 27  
 matrix-engraving machine 175 49  
 matrix for hand-setting 174 28  
 matrix holder 24 55  
 matrix mimic board 153 8  
 mat sail 353 33  
 matte 313 4  
 matte box 313 3  
 matter 174 15; 181 37  
 matter, front ~ 185 43-47  
 matter, machine-set ~ 174 27  
 matter, preliminary ~ 185 43-47  
 matting, reed ~ 55 6  
 matting, straw ~ 55 6  
 mattress 47 3; 296 18  
 mattress, foam ~ 43 10  
 matt weave 171 11  
 maturing 169 7  
 mauerkrone 254 46  
 mausoleum 337 16  
 mavis 361 16  
 maw worm 81 31  
 maxilla 17 36; 19 27  
 maximum 347 19  
 maximum thermometer 10 53  
 may 374 30  
 Maya temple 352 20  
 May bug 82 1  
 mayfly 358 6  
 maypole swing 273 8  
 maze 272 5  
 M-cardan 67 29  
 meadow 13 13; 62 44; 63 22  
 meadow buttercup 375 8  
 meadow fescue grass 69 24  
 meadow flowers 375; 376  
 meadow foxtail 69 27  
 meadow grass 375 39  
 meadow grasshopper 358 8  
 meadow mushroom 381 1  
 meadow saffron 379 3  
 meal, complete ~ 266 17  
 meal, deep-freeze ~ 96 23  
 meal, deep-frozen ~ 96 23  
 meal, hot ~ 266 67  
 meal, ready-to-eat ~ 96 23  
 meal beetle 81 18  
 meal of the day 266 27  
 meal worm beetle 81 18  
 meander *Phys. Geog.* 13 11  
 meander *Art* 334 43  
 meander core 13 12  
 mean low water 15 9  
 mean sea level 146 39  
 measure *Hotel* 267 60  
 measure *Music. Not.* 320 28-42  
 measure line 320 42  
 measurement chamber 112 43  
 measurement dial 242 75  
 measurement range selector *Atom* 2 4, 23  
 measurement range selector *Optic. Instr.* 112 46

measurement range selector *Inf. Tech.* 242 74  
 measurement scale 242 75  
 measuring and control unit 178 3  
 measuring arm 142 38  
 measuring beaker 267 60  
 measuring cylinder *Doc.* 23 43  
 measuring cylinder *Photog.* 116 11  
 measuring cylinder *Paperm.* 173 4  
 measuring cylinder *School* 261 26  
 measuring cylinder *Chem.* 350 26  
 measuring device 112 51  
 measuring flask 350 27  
 measuring glass 10 47; 350 26  
 measuring instrument 153 30  
 measuring instrument platform 235 69  
 measuring instruments 149 56-72  
 measuring machine, universal-type ~ 112 67  
 measuring probe 234 42  
 measuring rod *Map* 14 47  
 measuring rod *Cine Film* 117 59  
 measuring rod *Quarry* 158 26  
 measuring scale 149 63  
 measuring tank 130 22  
 measuring tape 103 2; 271 38  
 measuring vessel 93 3; 130 33  
 meat 96 1-4, 59; 99 53  
 meat, canned ~ 98 20  
 meat, cold ~ 96 14  
 meat, minced ~ 96 16  
 meat, roast ~ 45 27  
 meat, smoked ~ 96 3  
 meat axe 94 18  
 meat chopper 40 39  
 meat counter 99 51  
 meat dish 266 55  
 meat grinder 96 53  
 meathook 96 55  
 meat inspector 94 24  
 meat joints 95  
 meat mincer 96 53  
 meat-mixing trough 96 40  
 meat plate 45 26  
 meat platter 45 26  
 meat product 99 53  
 meat salad 96 13  
 meat saw 94 20  
 mechanic 140 1  
 mechanical finger car 159 18  
 mechanical pulp mill 172 53-65  
 mechanism casing 255 10  
 medallion 339 36  
 Mediaeval 342 4  
 medical card 22 8  
 medical laboratory technician 23 41  
 medical record 22 8  
 medicament, water-soluble ~ 25 14  
 medicine 22 23

medicine cabinet 49 49  
 medicine case 24 7  
 medicine cupboard 22 35  
 medicine sample 22 41  
 Mediterranean 14 25  
 medium 308 9  
 medium haul airliner 231 12  
 medium measure 294 10  
 medulla oblongata 17 47; 18 24  
 medusa 357 14  
 meeting 263 8  
 meeting, public ~ 263 1-15  
 'meeting point' 233 29  
 meganucleus 357 11  
 megaphone 283 21  
 megaphone exhaust pipe 189 51  
 meibar 9 3  
 Melanocetes 369 6  
 melodium 325 43  
 melody key 324 39  
 melody pipe 322 10  
 melody side 324 39  
 melody string 322 30; 324 24  
 melon 57 23  
 melter 148 7  
 melting bath 162 3, 14  
 melting furnace *Iron Foundry etc.* 148 1  
 melting furnace *Electrotyp. etc.* 178 19  
 melting plant 148 1-12  
 melting pot *Goldsm. etc.* 108 8  
 melting pot *Synth. Fibres* 170 30  
 member, diagonal ~ 215 35  
 member, upright ~ 119 59  
 member, vertical ~ 215 36  
 member of set 348 2  
 membership card 275 14  
 membrane 241 68  
 membrane, parchment ~ 324 31  
 membrane, periodontal ~ 19 28  
 membrane, tympanic ~ 17 59  
 membrane, vitelline ~ 74 64  
 membranophones 323 51-59  
 memorial chapel 331 12  
 memorial plate 331 14  
 memorial tablet 331 14  
 memory, main ~ 244 6; 245 28  
 memory key 247 22  
 memory typewriter 245 26  
 memory unit 176 11; 242 9  
 memo sheet 247 34  
 menagerie 307 63  
 menhir 328 18  
 menhir group 328 11  
 men's wear 33  
 men's wear department 271 12  
 menu 266 21  
 menu card 266 21  
 Mercator projection 14 9  
 Mercury 4 43  
 mercury barometer 10 1  
 mercury battery 25 32

mercury column 10 2  
 mercury manometer 25 18  
 meridian 14 4  
 meridian circle 113 26  
 meridian of Greenwich 14 5  
 meridian of longitude 14 4  
 meridians 14 1-7  
 meridian telescope 113 29  
 meringue 97 26; 265 5  
 merlin 362 1  
 merlon 329 7  
 mermaid 327 23  
 merman 327 23, 40  
 merry-go-round 308 2  
 mesa 13 59  
 mesh 171 37  
 mesh connection 153 21  
 mesh gauge 102 25  
 mesh pin 102 25  
 mesh ventilator 278 40  
 Mesolithic period 328 1-9  
 messroom 228 25  
 metacarpal 17 16  
 metal, noble ~ 237 42  
 metal-blocking device 111 34  
 metal feeder 174 26  
 metal feeder, automatic ~ 174 40  
 metal runner 147 35  
 metals 254 24-25  
 metal shears 108 23; 125 1  
 metalworker 140 1  
 metalwork shop 140 1-22  
 metatarsus 17 28  
 metazoans 357 13-39  
 meteor 7 18  
 meteorite crater 6 16  
 meteorological instruments 10  
 meteorological office 225 33  
 meteorological watch office 9 7  
 meteorology 8; 9  
 meter *Atom* 2 6  
 meter *Photog.* 114 62  
 meter *Blacksm.* 138 19  
 meter *Serv. Stat.* 196 14  
 meter *Music. Not.* 320 28-42  
 meter, customer's ~ 237 16  
 meter, multiple ~ 242 73  
 meter, private ~ 237 16  
 meter, rotary ~ 269 53  
 meter, subscriber's ~ 237 16  
 meter cell 114 3, 24; 115 37  
 metering pump 169 13  
 metope 334 16  
 metre tape measure 103 2  
 metronome 325 19  
 mezzanine 315 18  
 mezzo staccato 321 29  
 mezzotint 340 14-24  
 micro attachment 115 89  
 micro cassette recorder 246 32  
 microfilm card 237 38  
 microfilm file 237 37  
 microfilming system 242 31  
 microfilm reader 237 36  
 micrometer 142 37; 149 62; 173 10; 224 4  
 micrometer eyepiece 14 53

milk, homogenized  
 micrometer head 14 52  
 micronucleus 357 12  
 microphone 22 15; 117 8, 24, 74; 197 26; 209 31; 224 30; 230 29; 237 9; 241 49; 261 39; 263 7; 310 30; 317 20  
 microphone, built-in ~ 241 5; 243 3  
 microphone, umpire's ~ 293 21  
 microphone base 241 51  
 microphone boom 310 25  
 microphone boom, telescopic ~ 117 23  
 microphone cable 239 14; 310 32; 311 41  
 microphone connecting cord 117 25  
 microphone connecting lead 117 25  
 microphone cradle 249 65  
 microphone screen 241 50  
 microphone socket 249 69  
 microphone socket panel 238 36  
 microphone stand 241 51  
 microprism collar 115 54  
 microprism spot 115 58, 59, 62, 63  
 micropyle 383 57  
 microscope 111 19; 112 1  
 microscope, metallurgical ~ 112 23  
 microscope, surgical ~ 112 31  
 microscope, universal ~ 112 54  
 microscope, wide-field ~ 112 23, 54  
 microscope body 113 31-39  
 microscope camera, fully automatic ~ 112 64  
 microscope for reflected light 112 23  
 microscope stage 112 9  
 microscope tube 113 31-39  
 microwave treatment unit 23 36; 24 23  
 mid-channel 224 98  
 middle-distance runner 298 5  
 middle ground 224 91  
 middle ground to port 224 88  
 middle mast 220 33  
 Middle Muschelkalk 154 59  
 middle of the fairway 224 98  
 middle section 259 55-74  
 middling 91 2  
 midfield player 291 14  
 midge 358 16  
 midget 308 22  
 midi bus 194 34  
 midinette 306 21  
 mid-range speaker 241 16  
 midrib 370 30  
 mihrab 337 14  
 milch-cow 62 34; 75 17  
 mild 93 26  
 mildew 80 20  
 milestone 15 109  
 milk 99 45; 266 60  
 milk, canned ~ 98 15  
 milk, homogenized ~ 99 44



milk, long-life ~ 99 44  
 milk, pasteurized ~ 99 44  
 milk, sterilized ~ 76 16  
 milk carton 76 22  
 milk churn 309 89  
 milker 62 34; 75 17, 25  
 milk glass 124 5  
 milk heater 76 13  
 milking parlour 75 23  
 milk jug 44 31  
 milkman 75 25  
 milk pipe 75 27  
 milk pot 40 15  
 milk processing area 76 12-48  
 milk reception 76 1  
 milk tanker 76 2  
 milk tub filler 76 21  
 milkwort 377 3  
 Milky Way 3 35  
 mill 276 24  
 miller 91 15  
 millet 68 28  
 millibar scale 10 3  
 millimeter graduation 247 36  
 millimetre scale 10 3  
 milliner 35 1  
 milliner's shop 268 38  
 milling machine, rotary ~ 168 1  
 milling machine, universal ~ 150 32  
 milling machine table 150 33  
 milling roller, bottom ~ 168 4, 6  
 milling roller, top ~ 168 3  
 millrace 91 44  
 mills 91  
 mill spindle 91 12  
 millstone 91 16, 21  
 millstone, upper ~ 91 22  
 millstone casing 91 20  
 millstone ruff 355 52  
 millstream 91 44  
 mill weir 91 42  
 mill wheel, breast ~ 91 37  
 mill wheel, middleshot ~ 91 37  
 mill wheel, overshot ~ 91 35  
 mill wheel, undershot ~ 91 39  
 milometer 187 33  
 mimbar 337 15  
 minaret 337 13  
 minbar 337 15  
 mince 96 16  
 mincemeat 96 16  
 mincer 40 39; 96 53  
 mincing machine 96 52, 53  
 mine 15 34  
 mine, disused ~ 15 35  
 mine car 144 45  
 mine fan 144 16  
 minehead buildings 154 70  
 mine hunter 258 80  
 minelayer 258 94  
 mineral bath, outdoor ~ 281 9  
 mineral spring 274 11  
 mineral water 266 61  
 minesweeper 258 84  
 mine-sweeping gear 258 87  
 miniature film cassette 112 35  
 minibus 194 9; 195 47

minigolf course 272 68  
 minigolf hole 272 70  
 minigolf player 272 69  
 minim 320 14  
 minim rest 320 22  
 minimum 347 20  
 minimum thermometer 10 54  
 mining, underground ~ 144 21-51  
 minion 175 24  
 minionette 175 23  
 mink 30 60  
 mink skin 131 11  
 mink skin, let-out ~ 131 19  
 minnesinger 329 70  
 minor keys 320 55-68  
 minor planets 4 47  
 minor triad 321 2  
 minstrel 329 70  
 mintage 252 10, 40-44  
 minting dies 252 40-41  
 minting press 252 44  
 mint mark 252 10  
 minuend 344 24  
 minus blue filter adjustment 116 44  
 minuscule 175 12  
 minuscule, Carolingian ~ 341 18  
 minus green filter adjustment 116 43  
 minus red filter adjustment 116 45  
 minus sign 344 8, 24  
 minute hand 110 12  
 Mira 3 11  
 mirabelle 59 25  
 mire crow 359 14  
 mirror 43 29; 49 33; 105 20; 106 6; 111 4; 177 38; 188 35; 189 30; 207 49  
 mirror, angled ~ 177 28  
 mirror, auxiliary ~ 115 38  
 mirror, concave ~ 5 32; 308 56; 312 39  
 mirror, convex ~ 308 57  
 mirror, flat ~ 5 3  
 mirror, illuminating ~ 14 59  
 mirror, main ~ 5 1; 113 10  
 mirror, primary ~ 5 1; 113 10  
 mirror, right-angle ~ 261 10  
 mirror, rotating ~ 243 54  
 mirror, secondary ~ 5 2; 113 11  
 mirror, semi-reflecting ~ 243 55  
 mirror, triple ~ 104 1  
 mirror arc lamp 312 39  
 mirror assembly 176 21  
 mirror carp 364 4  
 mirror lens 115 50  
 mirror manometer 349 20  
 mirror reflex system 115 31  
 mirror spot 316 48  
 mirror spotlight 316 48  
 mirror system 176 24  
 missal 330 38  
 missile 258 49  
 missile, short-range ~ 259 26  
 missile, wooden ~ 352 39; 353 8

missile cruiser 259 21, 41  
 missile launcher, underwater ~ 259 37, 51  
 missile-launching housing 258 71  
 miter *see* mitre  
 miter angle 120 82  
 mitre 124 4  
 mitre block 124 30  
 mitre board 124 31  
 mitre box *Glaz.* 124 30  
 mitre box *Joiner* 132 43  
 mitre gate 217 19  
 mitre joint 124 4  
 mitre shoot 124 31  
 mitre square 120 82  
 mitring machine 124 7  
 mitt, catcher's ~ 292 60  
 mitt, fielder's ~ 292 59  
 mitten crab 358 1  
 mixed asphalt outlet 200 54  
 mixer *Dent.* 24 51  
 mixer *Kitch. Utensils* 40 45  
 mixer *Cine Film* 117 26  
 mixer *Synth. Fibres* 170 53  
 mixer *Aircraft* 232 48  
 mixer *Broadcast.* 238 25  
 mixer *Films* 311 21  
 mixer *Disco* 317 26  
 mixer, double shaft ~ 159 10  
 mixer, hand ~ 39 22  
 mixer, high-speed ~ 79 5  
 mixer, propeller-type ~ 79 5  
 mixer drum 200 15  
 mixer operator 118 32  
 mixer tap 39 36; 49 2; 106 14; 126 27  
 mixing 169 2  
 mixing chamber 83 62  
 mixing chest 173 1  
 mixing console *Cine Film* 117 26  
 mixing console *Broadcast.* 238 25  
 mixing console *Films* 310 56; 311 35  
 mixing console *Disco* 317 26  
 mixing desk *Cine Film* 117 26  
 mixing desk *Broadcast.* 238 25  
 mixing desk *Films* 310 56; 311 35  
 mixing desk *Disco* 317 26  
 mixing drum 118 34; 200 15  
 mixing faucet 39 36; 49 2; 106 14; 126 27  
 mixing machine 200 15  
 mixing plant, central ~ 201 19  
 mixing plant, stationary ~ 201 19  
 mixing room 311 34  
 mixing screw 83 59  
 mixing spoon 40 3  
 mixing tank 172 35  
 mixture, additive ~ 343 10  
 mixture, subtractive ~ 343 12  
 mixture control 230 31; 288 16  
 Mizar 3 29  
 mizen *see* mizzen  
 mizzen 218 29; 219 30

mizzen, lower ~ 219 8  
 mizzen mast 218 31; 219 8-9; 220 23, 24, 30, 34  
 mizzen staysail 219 27  
 mizzen top 219 54  
 mizzen topgallant sail 218 54  
 mizzen topgallant staysail 219 29  
 mizzen topmast 219 9  
 mizzen topmast rigging 219 17  
 mizzen topmast staysail 219 28  
 moat 329 33, 37; 356 3  
 mobile 260 70  
 moccasin 101 30; 352 18  
 moccasin flower 376 27  
 mock orange 373 9  
 model, clay ~ 260 67  
 model, dressmaker's ~ 103 6  
 model, nude ~ 338 32  
 model, plaster ~ 339 4  
 model, wax ~ 339 26  
 model aeroplane 273 37, 38  
 model aeroplanes 288 85-91  
 model coat 103 7  
 model dress 103 5  
 model flight, radio-controlled ~ 288 85  
 model hat 35 7  
 modeling *see* modelling  
 modeller 339 6  
 modelling board 48 14; 339 34  
 modelling clay 48 12; 339 31  
 modelling stand 339 9  
 modelling substance 339 8  
 modelling tool 161 20  
 modelling tool, wire ~ 339 11  
 modelling tool, wooden ~ 339 10  
 model of set 315 42  
 models of molecules 242 61-67  
 model stage 315 41  
 moderator 1 54  
 modular elements 242 68-72  
 module, electronic ~ 242 69  
 module, lunar ~ 6 12  
 module, magnetic ~ 242 72  
 moistener 247 31  
 moisturising cream 99 27  
 molar 19 18, 35  
 mold *see* mould  
 molder 97 57  
 mole *Map* 15 48  
 mole *Hydr. Eng.* 217 15  
 mole *Docks* 225 65  
 mole *Mammals* 366 4  
 molecular rearrangement 170 23  
 molluscs 357 27-36  
 monastery *Map* 15 63  
 monastery *Church* 331 52-58  
 monastery garden 331 53  
 money 252; 265 3  
 money, hard ~ 252 1-28  
 money, metal ~ 252 1-28  
 money, paper ~ 252 29-39  
 money compartment 271 6  
 money order 236 27

moneywort 375 26  
 monitor 23 27; 26 15, 16, 33; 27 23  
 monitor *Cine Film* 117 97  
 monitor *Broadcast.* 238 33  
 monitor *Audiovis.* 243 6  
 monitor *Fire Brig.* 270 66  
 monitor *Theatre* 316 18  
 monitor *Fish etc.* 364 31  
 monitor, six-channel ~ 27 31  
 monitoring and control panel 238 1, 7  
 monitoring controls 153 5  
 monitoring instrument 311 15  
 monitoring loudspeaker 239 9; 311 13  
 monitoring speaker 238 15  
 monitoring unit, mobile ~ 25 24  
 monitor lizard 364 31  
 monitor support, swivel-mounted ~ 27 24  
 monitor unit 25 44  
 monk 89 9  
 monk, Benedictine ~ 331 54  
 monkey bridge 223 4-11; 227 24  
 monkey house 356 10  
 monkey nut 383 41  
 monkeys 368 12-13  
 monkshood 379 1  
 monochlorobenzene 170 9  
 monoclinic crystal system 351 24-25  
 monogram 36 41  
 mono-line control system 288 90  
 monolith 328 18  
 monoplane, high-wing ~ 229 1; 231 2  
 monoplane, low-wing ~ 229 5, 14; 231 1  
 monoplane, midwing ~ 229 4  
 monoplane, shoulder-wing ~ 229 3  
 mono posto 290 34  
 monorail car 144 43, 44  
 monoski 286 56  
 mono sound 311 35  
 monotreme *Mammals* 366 1  
 monotype caster 174 39  
 monotype casting machine 174 39  
 monotype composing and casting machine 174 32-45  
 monotype composing machine 174 32  
 monsoon 9 52  
 monster 327 16  
 monster, winged ~ 327 55  
 monstera 331 48; 332 34  
 monter 319 29  
 monument *Map* 15 92  
 monument *Park* 272 10  
 moon 4 1-9, 31, 45  
 moon, full ~ 4 5  
 moon, new ~ 4 2  
 moon, waning ~ 4 7  
 moon, waxing ~ 4 3  
 moon landing 6

moor buzzard 362 13  
 moor harrier 362 13  
 moor hawk 362 13  
 mooring 283 19  
 mooring bitt, cross-shaped ~ 217 13, 14  
 mooring bitt, double ~ 217 14  
 mooring chain 224 72  
 mooring line 288 66  
 mooring sinker 224 73  
 moose 367 1  
 mop, gilder's ~ 129 54  
 mopboard 123 21, 63  
 moped 188 24  
 moped, battery-powered ~ 188 20  
 moped headlamp 188 29  
 mopeds 188  
 Mopsea 369 8  
 moraine, lateral ~ 12 53  
 moraine, medial ~ 12 54  
 morainic filter layer 199 24  
 Morchella conica 381 27  
 Morchella esculenta 381 26  
 mordant 178 24; 182 16  
 mordent, inverted ~ 321 19  
 mordent, lower ~ 321 20  
 mordent, upper ~ 321 19  
 morel 381 26, 27  
 morello 59 5  
 morello cherry 59 5  
 morion 329 60  
 morse 367 20  
 morse lamp 223 7  
 mortadella 96 7  
 mortar *Army* 255 40  
 mortar *Chem.* 349 9  
 mortar bed 123 27  
 mortar pan 118 39  
 mortar trough 118 20, 39, 84  
 mortar tub 118 39  
 mortice *see* mortise  
 mortise, forked ~ 121 85  
 mortise and tenon joint 121 84, 85  
 mortise axe 120 72  
 mortise chisel 132 8  
 mortise lock 140 36-43  
 mortiser 120 17  
 mortising chain, endless ~ 132 50  
 mortuary 331 21  
 mosaic 338 37  
 mosaic figure 338 38  
 mosque 337 12  
 mosquito 358 16  
 moss 377 17  
 moss phlox 60 14  
 moss pink 60 14  
 moth 58 64; 81 13; 82 15, 18, 45, 48  
 moth, female ~ 82 30  
 moth, male ~ 82 29  
 moth, night-flying ~ 82 14  
 moth, nocturnal ~ 82 14  
 mother 28 6; 272 71  
 mother-of-pearl 357 34  
 mother sheep 75 10  
 moths 358 48-56; 365 7-11  
 motif *Child. Clothes* 29 20  
 motif *Art. Studio* 338 27



motion, longitudinal ~ 149 17  
 motion picture camera, lightweight ~ 313 20  
 motion picture camera, narrow-gauge ~ 313 31  
 motion picture camera, professional ~ 313 20, 31  
 motion picture camera, soundproof ~ 310 47; 313 15  
 motion picture camera, standard-gauge ~ 313 1  
 motion picture cameras 313 1-39  
 motion picture laboratory 310 2; 311 30  
 motion picture library 310 5  
 motion picture projection 312 1-23  
 motion pictures 310; 311; 312; 313  
 motion picture storage vault 310 5  
 motions, rotary ~ 4 22-28  
 moto cross 290 24-28  
 motor *Forestry* 84 34  
 motor *Watchm.* 109 13  
 motor *Iron Foundry etc.* 148 64  
 motor *Weaving* 165 12, 34  
 motor *Electrotyp. etc.* 178 14  
 motor *Tram* 197 5, 7  
 motor *Water* 269 45  
 motor, auxiliary ~ 211 17  
 motor, built-in ~ 164 2  
 motor, built-on ~ 164 33  
 motor, electric ~ *Roof & Boilers.* 38 59  
 motor, electric ~ *Pest Contr.* 83 53  
 motor, electric ~ *Blacksm.* 138 2  
 motor, electric ~ *Weaving* 166 18  
 motor, electric ~ *Railw.* 212 34  
 motor, electric ~ *Ship* 223 69  
 motor, synchronous ~ 176 19  
 motor, three-phase ~ 164 35  
 motor, two-stroke ~ 56 30  
 motor base plate 164 36  
 motor bedplate 164 36  
 motorboat 283 2  
 motorboat landing stage 216 7  
 motorboats 286 1-5  
 motor car 191 1-56; 192; 193; 195 34  
 motor car mechanic 195 53  
 motor coach 194 17  
 motor cruiser 286 4  
 motor cultivator 56 18  
 motorcycle 189; 268 35  
 motorcycle, heavyweight ~ 189 31  
 motorcycle, light ~ 188 39; 189 1, 16  
 motorcycle, lightweight ~ 189 1  
 motorcycle, pacer's ~ 290 12  
 motorcycle chain 189 22  
 motorcycle racing 290 24-28

motorcycles 188  
 motorcycles, heavy ~ 189 31-58  
 motorcycles, heavyweight ~ 189 31-58  
 motorcycles, large-capacity ~ 189 31-58  
 motorcycle stand 189 21  
 motorcycle tyre 189 26  
 motorcyclist 268 34; 290 11  
 motor drive 115 76  
 motor drive, attachable ~ 115 78  
 motor drive gear 167 31  
 motor ferry 216 6  
 motor grader 200 19  
 motor pump 270 8  
 motor safety switch 269 46  
 motor saw 84 22, 27; 85 13  
 motor scooter 188 47  
 motor ship 223  
 motorsports 290 24-38  
 motor truck, heavy ~ 194 20  
 motor turntable ladder 270 9  
 motor unselector 237 42  
 motor unit 50 82  
 motor vehicle mechanic 195 53  
 motorway *Map* 15 16  
 motorway *Docks* 225 54  
 motor winch 287 6  
 moufflon 367 6  
 mouflon 367 6  
 mould *Bldg. Site* 119 84  
 mould *Iron & Steel* 147 37  
 mould *Glass Prod.* 162 47  
 mould *Paperm.* 173 48  
 mould, fixed ~ 178 22  
 mouldboard 65 4, 64  
 moulder *Bakery* 97 57  
 moulder *Iron Foundry etc.* 148 30  
 moulding, concave ~ 334 29  
 moulding, hollow ~ 336 10  
 moulding, ornamental ~ 336 12  
 moulding box, closed ~ 148 18  
 moulding box, open ~ 148 33  
 moulding department 148 30-37  
 moulding press, hydraulic ~ 178 7  
 moulding sand 148 35  
 moulding shop 148 30-37  
 mould loft 222 3  
 mould wall 148 29  
 mound *Equest.* 289 8  
 mound *Prehist.* 328 16  
 mound *Art* 337 21  
 mountain ash 371 42  
 mountain climber 300 5  
 mountain climbing 300 1-57  
 mountaineer 300 5  
 mountaineering 300 1-57  
 mountaineering boot 300 42  
 mountaineering equipment 300 31-57  
 mountain hut 300 1  
 mountain racing 290 24-28  
 mountain railroads 214 1-14

mountain railways 214 1-14  
 mountain range 12 39  
 mountain ridge 12 36  
 mountains, folded ~ 12 12-20  
 mountain slope 12 37  
 mountain top 12 35  
 mounting, German type ~ 113 16  
 mounting, mobile ~ 27 22  
 mounting, underfloor ~ 127 22  
 mount of the frame 111 10  
 mourner 331 33  
 mourning cloak butterfly 365 5  
 mourning veil 331 39  
 mousetrap 83 36  
 moustache, English-style ~ 34 19  
 moustache, military ~ 34 19  
 moustache, waxed ~ 34 13  
 mouth *Man* 16 13; 19 14-37  
 mouth *Horse* 72 9  
 mouth *Forestry* 84 28  
 mouth *Game* 88 13, 45  
 mouth *Joiner* 132 21  
 mouth *Airsports* 288 70, 81  
 mouth *Music. Instr.* 326 25  
 mouth, fork-tongued ~ 327 5  
 mouth band 322 5  
 mouth gag 22 48  
 mouth lamp 24 42  
 mouth mirror 24 41  
 mouth organ 324 35  
 mouthpiece *Hosp.* 27 38  
 mouthpiece *Tobacc. etc.* 107 40  
 mouth piece *Electrotyp. etc.* 178 17  
 mouthpiece *Post* 237 9  
 mouthpiece *Music. Instr.* 323 36; 324 33, 72  
 mouthwash 49 36  
 movable-comb hive 77 45-50  
 movable-frame hive 77 45-50  
 movable half 215 66  
 move 276 14  
 movie audience 312 5  
 moviegoer 312 5  
 movie house 312 1  
 movie projector 312 24  
 movie script 310 45  
 movie set 310 7  
 movie studios 310 1-13  
 movie theater 312 1  
 movie theater box office 312 2  
 movie theater ticket 312 3  
 moving iron 137 39  
 mower, electric ~ 56 31  
 mower, hand ~ 56 34  
 mower, motor ~ 56 28  
 mower, riding ~ 56 37  
 mower, rotary ~ 63 19  
 mud drum 210 28  
 mudguard, front ~ 187 13  
 mudguard, rear ~ 187 43  
 mud pump 145 16  
 muffle furnace 140 11  
 muffler *Car* 191 29

muffler *Railw.* 209 12, 22, 24; 211 49  
 muffler *Sports* 305 93  
 mulberry-feeding moth 358 48  
 mule *Dom. Anim.* 73 8  
 mule *Shoes* 101 25  
 mule, open-toe ~ 101 22  
 mule cop 165 15  
 muleta 319 33  
 mull 183 33; 185 20  
 mullion *Dwellings* 37 35  
 mullion *Art* 335 41  
 mull roll holder 185 19  
 multiple cable system 215 51  
 multiple drying machine 169 31  
 multiple-frame viewfinder 114 41  
 multiple meter 127 41  
 multiple-unit train 211 60  
 multiplicand 344 25  
 multiplication 344 25  
 multiplication sign 344 25  
 multiplier 344 25  
 multiplier phototube 112 51  
 multiplier reel 89 59  
 multiplying 344 25  
 multirole combat aircraft 256 8  
 multirole helicopter, light ~ 232 11  
 multi-tier transport 74 35  
 mummy 352 21  
 Munich beer 93 26  
 mural 338 40  
 Muschelkalk 154 58, 59, 60  
 muscle, contractile ~ 77 17  
 muscle, deltoid ~ 18 35  
 muscle, pectoralis ~ 18 36  
 muscle, sternocleidomastoid ~ 18 34; 19 1  
 muscle, sternomastoid ~ 18 34; 19 1  
 muscle, temporal ~ 19 3  
 muscle, thenar ~ 18 41  
 muscles, ocular ~ 19 44  
 muscles of facial expression 19 6  
 muscles of the neck 19 12  
 muscular system 18 34-64  
 musculature 18 34-64  
 musette 322 8  
 mushroom 381 2, 3  
 mushrooms, poisonous ~ 379 10-13  
 musical instruments 322; 323; 324; 325; 326  
 musical instruments, popular ~ 324 1-46  
 musical notation 320; 321  
 music recording studio 310 14  
 music recording theatre 310 14  
 music rest 326 36  
 music stand 326 36  
 music systems 241  
 musk ox 367 10  
 mussel shell 357 36  
 mustard 352 4  
 mustard *Weeds* 61 16

mustard *Grocer* 98 28  
 mute 323 10; 324 68  
 mute swan 359 16  
 mutton spanker 218 29  
 mutule 334 13  
 muzzle *Dog* 70 3, 31  
 muzzle *Game* 88 45  
 muzzle *Army* 255 58  
 muzzle *Sports* 305 71  
 mycelium 68 4; 381 2  
 myrtle 53 11  
 Myrtus 53 11

**N**

Na atom 1 8  
 nacre 357 34  
 nadir 4 13  
 naiad 327 23  
 nail 19 80  
 nail, clenched ~ 285 52  
 nail, galvanized ~ 122 74  
 nail, riveted ~ 285 52  
 nail, wire ~ 121 95; 122 74; 143 51  
 nail, wooden ~ 121 92  
 nail bag 122 72  
 nail claw 120 75  
 nail grip 100 56  
 nail polish 99 32  
 nail puller 100 47  
 nail punch 134 32  
 nail varnish 99 32  
 naked boys 379 3  
 naked lady 379 3  
 name plate 118 47; 285 46  
 Nansen sledge 303 18  
 nape of the neck 16 21  
 napkin 45 9; 266 47; 267 48  
 napkin ring 45 10  
 nappy, disposable ~ 28 22  
 narcissus 53 8; 60 3  
 narghile 107 42  
 narghileh 107 42  
 narrow-gauge diesel locomotive 200 24  
 narrow-gauge track system 159 4  
 nasicorn 366 25  
 nasturtium 53 4  
 natural 320 45, 46, 54  
 natural-gas engine 155 5  
 naturalist 281 16  
 naum keag 100 7  
 nave 334 62; 335 1  
 navel 16 34  
 navette 36 55  
 navigating bridge 223 14; 228 22, 23, 24  
 navigating officer 224 37  
 navigation 224  
 navigational marks, floating ~ 224 68-108  
 navigational television receiver mast 221 37  
 navigation equipment 288 13  
 navigation light *Air Force* 257 36  
 navigation light *Warships* 258 56

navigation light *Airsports* 288 31  
 navigation light, left ~ 230 50  
 navigation light, right ~ 230 44  
 navigation light, side ~ 258 15  
 navigation light indicator panel 224 29  
 navigation lights 286 10-14  
 navy 118 76  
 navy 258  
 navy plug 107 25  
 navy yard 222 1-43  
 Neanderthal man 261 19  
 neck *Man* 16 19-21  
 neck *Horse* 72 12, 15  
 neck *Game* 88 3  
 neck *Meat* 95 6, 20  
 neck *Mach. Parts etc.* 143 64  
 neck *Weaves* 171 33  
 neck *Rowing* 283 37  
 neck *Airsports* 288 70  
 neck *Music. Instr.* 324 7, 18  
 neck, cylindrical ~ 328 40  
 neck, ground glass ~ 350 37  
 neckband 36 16  
 neck brush 106 27  
 neckerchief 31 57  
 neck flap *Fencing* 294 14  
 neck guard *Fencing* 294 14  
 neck guard *Chivalry* 329 83  
 neck interlocking point 171 35  
 necklace 36 2; 328 25; 352 14  
 necklace, coral ~ 36 34  
 necklace, cultured pearl ~ 36 12  
 necklace, ivory ~ 36 28  
 necklace, pearl ~ 36 32  
 neckline *Ladies' Wear* 30 34  
 neck line *Airsports* 288 71  
 neck of violin 323 2  
 neck piece 329 83  
 neck ring, gold ~ 328 26  
 neck strap 71 30  
 necktie 319 38  
 nectary 59 18  
 needle *Mach. Parts etc.* 143 76  
 needle *Drawing Off.* 151 56  
 needle *Conifers* 372 11  
 needle, hypodermic ~ 22 65; 24 54  
 needle, right-angle ~ 151 67  
 needle, surgical ~ 22 57  
 needle, tapered ~ 190 51  
 needle bar 167 28  
 needle bed 167 51, 55  
 needle butt 167 60  
 needle cage 143 75  
 needle cam 167 14  
 needle cylinder *Knitting* 167 8, 11  
 needle cylinder *Bookbind.* 185 21  
 needed part of the cylinder 163 70  
 needle file 108 22  
 needle head 309 33  
 needle holder 22 59



needle holder, cylindrical ~ 167 8, 11  
 needle hook 167 64  
 needle-matching system 114 29  
 needlepoint 102 30  
 needle point attachment 151 54  
 needlepoint lace 102 30  
 needle-raising cam 167 59  
 needle roller bearing 143 75-76  
 needles in parallel rows 167 53  
 needle trick 167 15  
 needlework 102  
 negative carrier 116 30  
 negative flight 288 9  
 negligée 355 66  
 negress 354 22  
 negro 354 13  
 negro hut 354 21  
 nematode 80 51  
 Neolithic period 328 10-20  
 neon sign 268 16  
 Neptune 4 51  
 Nereid 327 23  
 nerve 370 30  
 nerve, auditory ~ 17 64  
 nerve, femoral ~ 18 31  
 nerve, optic ~ *Man* 19 51  
 nerve, optic ~ *Bees* 77 23, 24  
 nerve, peroneal ~ 18 33  
 nerve, radial ~ 18 28  
 nerve, sciatic ~ 18 30  
 nerve, thoracic ~ 18 26  
 nerve, tibial ~ 18 32  
 nerve, ulnar ~ 18 29  
 nerves 19 33  
 nervous system 18 22-33  
 nervure *Articulat* 358 34  
 nervure *Bot.* 370 29  
 nest 359 28  
 nesting cavity 359 29  
 Net *Astron.* 3 48  
 net *Hunt.* 86 27  
 net *Sea Fish.* 90 8  
 net *Airsports* 288 74  
 net *Ball Games* 293 13  
 net background 102 16  
 net-cord judge 293 23  
 net curtain 42 35; 44 14  
 net fabric 167 29  
 net post 293 15  
 net sonar cable 90 14  
 net sonar device 90 17  
 net stocking 306 10  
 net strap 293 14  
 netting 102 22  
 netting, wire ~ 339 35  
 netting loop 102 23  
 netting needle 102 26  
 netting thread 102 24  
 nettle 61 33  
 net vault 336 45  
 network 288 74  
 neume 320 1  
 neuropteran 358 12  
 neutral conductor 127 13  
 neutral corner 299 38  
 neutral point 153 22

neutron 1 30, 39, 45, 52, 53  
 neutron bombardment 1 36, 50  
 nevè 12 48  
 new-born baby 28 5  
 newel 123 43  
 newel, open ~ 123 76  
 newel, solid ~ 123 77, 78  
 newel post 123 43  
 Newfoundland dog 70 34  
 new penny 252 37  
 news, miscellaneous ~ 342 63  
 newscaster 238 21  
 news dealer 205 17; 268 75  
 news in brief 342 63  
 news item 342 50  
 newspaper 182 31; 205 51; 265 25; 342 37-70  
 newspaper, folded ~ 181 56  
 newspaper delivery unit 182 29  
 newspaper heading 342 39  
 newspaper holder 265 26  
 newspaper page 342 37  
 newspaper rack 265 8  
 newspaper shelf 262 16; 265 8  
 newspaper typesetting 176 29  
 newsreader 238 21  
 newsreel camera 313 26  
 New Stone Age 328 10-20  
 news trolley 205 16  
 news vendor 205 17; 268 75  
 New World opossum 366 2  
 nib 122 51  
 nib size 151 40  
 niche 331 60  
 nick 175 47  
 nigger 310 51  
 night-care cream 99 27  
 nightclub 318 1-33  
 nightdress 32 16  
 nightgown 32 16  
 nightie 32 16  
 nightingale 361 14  
 nightshirt 32 37  
 night spot 318 1-33  
 nightwear 32  
 nightwear, ladies' ~ 32 16-21  
 nightwear, men's ~ 32 35-37  
 Nile crocodile 356 13  
 nimbostratus 8 10  
 nine-eight time 320 39  
 nine-four time 320 40  
 nine men's morris 276 18, 23-25  
 nine men's morris board 276 23  
 nipper, bottom ~ 163 65  
 nipper, top ~ 163 66  
 nippers 100 40, 41  
 nipping press 183 20  
 nipple 16 28  
 nipple key 126 63  
 nitrogen tetroxide tank 234 59  
 nitrous oxide 26 3  
 nix 327 23  
 nixie 327 23  
 nobleman 355 44  
 nock 305 63  
 node 68 7

node, lymph ~ 19 10  
 nodosity 80 27  
 nogging piece 120 55  
 noir 275 21  
 nominal par 251 12  
 non-belayer 300 27  
 nonpareil 175 23  
 non-printing area 340 56  
 noodle 98 34; 99 65  
 Norfolk Island pine 53 16  
 North America 14 12  
 North Atlantic Drift 14 30  
 North Equatorial Current 14 32  
 Northern Cross 3 23  
 Northern Crown 3 31  
 northern gannet 359 9  
 northern pike 364 16  
 north light 121 21  
 north point 4 16  
 North Pole 14 3  
 North Sea 14 26  
 North Star 3 1, 34  
 Norton tumbler gear 149 8  
 nose *Man* 16 10  
 nose *Dog* 70 4  
 nose *Horse* 72 6  
 nose *Fish etc.* 364 2  
 nose, false ~ 306 46  
 noseband 71 7  
 nose cone, carbon fibre reinforced ~ 235 20  
 nose gear flap 231 24  
 nose landing gear unit, retractable ~ 231 23  
 nose piece, revolving ~ 112 11, 30  
 nose rib 287 36  
 nose undercarriage flap 231 24  
 nose undercarriage unit, retractable ~ 231 23  
 nose wheel 288 34  
 nose wheel, forward-retracting ~ 257 3  
 nose wheel, hydraulically steerable ~ 235 30  
 nose wheel, steerable ~ 230 40  
 nosing 123 20  
 nostril 72 7  
 notation, mensural ~ 320 2  
 notation, square ~ 320 1  
 notch *Phys. Geog.* 13 30  
 notch *Forestry* 84 28  
 notch *Hunt.* 87 66, 70  
 notch *Army* 255 22  
 notch, wedge-shaped ~ 54 38  
 note, marginal ~ 185 68  
 note, musical ~ 320 3-7  
 notebook 47 24; 260 18  
 note head 320 3  
 notepaper 245 12  
 notes 252 29-39  
 notes, medieval ~ 320 1-2  
 note stem 320 4  
 note tail 320 4  
 note values 320 12-19  
 'NOT GO' gauging member 149 58  
 'NOT GO' side 149 61  
 notice 356 7

notice board 204 12  
 nougat 98 81  
 novillero 319 2  
 nozzle *Moon L.* 6 3  
 nozzle *Household* 50 67  
 nozzle *Overh. Irrign.* 67 33  
 nozzle *Pest Contr.* 83 46  
 nozzle *Serv. Stat.* 196 3  
 nozzle *Aircraft* 232 39, 45, 49, 55  
 nozzle *Space* 234 35; 235 37  
 nozzle, pistol-type ~ 83 28  
 nozzle, revolving ~ 56 44  
 nozzle, swivelling ~ 235 64  
 nozzle fuel tank 235 45  
 nuclear energy 154  
 nuclear power plant 154 19  
 nuclear reactor casing 259 67  
 nuclear research ship 221 9  
 nucleus 1 43  
 nucleus, atomic ~ 1 2, 16, 29, 35, 49, 51  
 nude 338 32  
 nudist 281 16  
 nudist sunbathing area 281 15  
 null hyperbola 224 42  
 number *Equest.* 289 33, 36  
 number *Cyc. Racing* 290 28  
 number *Winter Sp.* 301 37  
 number *Sports* 305 84  
 number, abstract ~ 344 3  
 number, cardinal ~ 344 5  
 number, complex ~ 344 14  
 number, concrete ~ 344 4  
 number, even ~ 344 11  
 number, four-figure ~ 344 3  
 number, mixed ~ 344 10  
 number, negative ~ 344 8  
 number, odd ~ 344 12  
 number, ordinal ~ 344 6  
 number, positive ~ 344 7  
 number, prime ~ 344 13  
 number, whole ~ 344 10, 18  
 number disc 189 18  
 number key *Office* 247 18  
 number key *Store* 271 3  
 number key *Flea Market* 309 76  
 'number one' 283 13  
 number plate 189 8; 290 28; 305 84  
 numbers 344 1-22  
 number sign 197 21  
 number tab 267 10  
 number tag 267 10  
 numeral, Arabic ~ 344 2  
 numeral, Roman ~ 344 1  
 numeral pendants 253 33-34  
 numeral pennants 253 33-34  
 numerator 344 15  
 nun 331 50  
 nun moth 82 17  
 nursery 47  
 nursery child 48 2  
 nursery education 48 1-20  
 nursery gardener 55 20  
 nursery hand 55 45, 46  
 nursery sapling 83 15  
 nursery teacher 48 1  
 nut *Bldg. Site* 119 75  
 nut *Musical Instr.* 323 13, 20

nut *Bot.* 370 98  
 nut *Industr. Plants* 383 44  
 nut *South. Fruits* 384 52, 58, 60  
 nut, castellated ~ 143 24, 77  
 nut, castle ~ 143 24  
 nut, hexagonal ~ 143 18  
 nut, round ~ 143 35  
 nutation 4 24  
 nutcracker 361 1  
 nutcrackers 45 49  
 nuthatch 361 11  
 nutmeg 382 34, 35  
 nutmeg tree 382 30  
 nuts 59 59, 37-51  
 Nydam boat 218 1-6  
 nylon 101 4  
 nylon 6 fibres 170 1-62  
 nylons 99 26  
 nylon-thread cop 133 4  
 nymph, artificial ~ 89 66

O

oak 51 12  
 oak apple 82 34  
 oak gall 82 34  
 oak-gall wasp 82 33  
 oak tree 51 12; 371 1  
 oar 218 5; 278 19; 283 14, 26, 35-38  
 oarlock 278 18; 283 29, 41  
 oarsman 218 3; 283 12  
 oasis 354 4  
 oat-grass 69 22  
 oat panicle 68 27  
 oats 68 1  
 oats, rolled ~ 98 37  
 obelisk 333 10  
 Oberwerk 326 2, 44  
 obi 353 41  
 object ball, red ~ 277 12  
 objective, interchangeable ~ 112 62  
 objective aperture 113 35  
 objective lens 113 36  
 objective turret 112 11, 30  
 object lens 114 26; 313 2  
 object stage 112 9  
 oblique, external ~ 18 43  
 obliquus externus abdominis 18 43  
 oboe 323 38  
 O'Brien technique 298 50  
 observation opening 5 13  
 observation port *Agr. Mach.* 64 27  
 observation port *Films* 312 15  
 observation room 5 33  
 observation shaft 5 30  
 observation telescope 351 31  
 observation window 25 8  
 observation window, forward ~ 235 25  
 observation window, upward ~ 235 24  
 observatory 5 1-16; 9 7  
 observatory, solar ~ 5 29-33  
 observatory dome 5 12  
 obstacle, almost-fixed ~ 289 8

obstacle, fixed ~ 289 20  
 obstruction 291 51  
 obverse 252 8  
 ocarina 324 32  
 occipitalis 18 50; 19 2  
 occipito frontalis 19 4  
 occiput 16 2  
 occlusion 9 25  
 ocean *Phys. Geog.* 13 26  
 ocean *Map* 14 19-26  
 ocean current, cold ~ 14 27  
 ocean current, warm ~ 14 28  
 ocean currents 14 30-45  
 ocean drifts 14 30-45  
 Oceanid 327 23  
 ocean liner 221 82; 225 32  
 ocean nymph 327 23  
 ocean station vessel 9 7  
 ocellus *Dom. Anim.* 73 32  
 ocellus *Bees* 77 2  
 octagon 351 17  
 octahedron 351 6, 14, 16  
 Octans 3 43  
 Octant 3 43  
 octave, five-line ~ 321 50  
 octave, four-line ~ 321 49  
 octave, great ~ 321 44  
 octave, one-line ~ 321 46  
 octave, small ~ 321 45  
 octave, three-line ~ 321 48  
 octave, two-line ~ 321 47  
 octave engagement 294 50  
 odalisque 306 41  
 odd-pinnate 370 42  
 odds 289 37  
 odds-and-ends box 195 31  
 Oertz rudder 222 69-70  
 oesophagus *Man* 17 49; 20 23, 40  
 oesophagus *Bees* 77 19  
 offcut 120 96  
 off-end framing 165 14  
 offering 330 60  
 offertory bag 330 59  
 offertory box 330 55  
 office *Coal* 144 18  
 office *Railw.* 207 41  
 office *Office* 245; 246; 247; 248; 249  
 office *Camping* 278 1  
 office *Chivalry* 329 27  
 office, executive's ~ 246 1-36  
 office, manager's ~ 271 24  
 office, open plan ~ 248 1-48  
 office, physician's ~ 22 1-74  
 office, purser's ~ 223 45  
 office, receptionist's ~ 245 1-33  
 office, secretary's ~ 245 1-33  
 office building *Coal* 144 18  
 office building *Offshore Drill* 146 14  
 office building *Docks* 225 53  
 office building *Films* 310 4  
 office calculator 245 31  
 office chair 248 25  
 office cupboard 248 12  
 office equipment 247 1-44  
 office furniture 248 39  
 office intercom 245 20; 246 10  
 office machinery 249



office materials 247 1-44  
 officer in charge 270 36  
 officer of the watch 221 126  
 offices 205 13; 217 24; 310 4  
 offices, administrative ~ 222 1  
 office supplies 247 1-44  
 offset machine, four-colour ~ 180 30  
 offset machine, rotary ~ 180 1, 18  
 offset machine, sheet-fed ~ 180 30  
 offset machine, single-colour ~ 180 46, 59  
 offset plate 179 1  
 offset plate, coated ~ 179 16  
 offset platemaking 179  
 offset press *Paperm.* 173 21  
 offset press *Office* 249 48  
 offset press, four-colour ~ 180 1, 18, 30  
 offset press, rotary ~ 180 1, 18  
 offset press, sheet-fed ~ 180 30, 70  
 offset press, single-colour ~ 180 46, 59  
 offset printing 180  
 offshoot 370 21  
 offshore drilling 146  
 offshore drilling rig supply vessel 221 32  
 offside 291 42  
 off switch 10 15  
 ogee arch 336 36  
 ogee wing 229 22  
 oil 98 24  
 oil, crude ~ *Phys. Geog.* 12 31  
 oil, crude ~ *Oil, Petr.* 145 28-35, 36-64  
 oil, mineral ~ 145  
 oil, viscous ~ 84 35  
 oil and vinegar bottle 45 42  
 oil bag 228 11  
 oil bath air cleaner *Agr. Mach.* 65 54  
 oil bath air cleaner *Railw.* 212 79  
 oil bath air filter *Agr. Mach.* 65 54  
 oil bath air filter *Railw.* 212 79  
 oil bleeder screw 190 24  
 oil burner 38 58-60  
 oil can 196 16  
 oil-circulating pump *Power Plant* 152 45  
 oil-circulating pump *Railw.* 211 12  
 oil conservator 152 42; 153 9  
 oil cooler *Power Plant* 152 46  
 oil cooler *Car* 192 19  
 oil cooler *Railw.* 211 11  
 oil drain plug 190 24  
 oil drilling 145 1-21  
 oiler 109 4  
 oil filler neck 190 28  
 oil filter 190 43; 192 20  
 oil-firing system 199 30, 35  
 oil furnace 145 36  
 oil gallery, main ~ 192 21

oil gauge *Roof & Boilerr.* 38 54  
 oil gauge *Power Plant* 153 11  
 oil heating furnace 38 57  
 oil level pipe 38 53  
 oil paint 338 11  
 oil palm 383 54  
 oil pipe 190 13  
 oil pipeline 145 65  
 oil pressure gauge *Sawmill* 157 7  
 oil pressure gauge *Aircraft* 230 20  
 oil pressure limiting valve 190 67  
 oil pressure warning light 191 73  
 oil production 145 22-27  
 oil products 145 52-64  
 oil pump 190 42; 192 16  
 oil pump drive 190 25  
 oil refinery 145 65-74  
 oil reservoir 64 29, 93  
 oil rig 146 1-39  
 oil scraper ring 190 37  
 oilskins 228 4  
 oil stand 109 5  
 oilstone 340 21  
 oil sump *Agr. Mach.* 65 45  
 oil sump *Intern. Combust. Eng.* 190 41  
 oil sump *Car* 192 17  
 oil tank *Roof & Boilerr.* 38 44  
 oil tank *Agr. Mach.* 64 93  
 oil tank *Oil, Petr.* 145 34  
 oil tank *Motorcycle* 189 36  
 oil temperature gauge *Car* 191 38  
 oil temperature gauge *Aircraft* 230 21  
 oil temperature sensor 195 16, 40  
 oil-to-air cooling unit 209 18  
 ointment, tube of ~ 22 47  
 O-Joller 284 50  
 Old Stone Age 328 1-9  
 old woman's tooth 132 26  
 oleander 373 13  
 olive oil 98 24  
 olive tree 383 29  
 omnibus, horse-drawn ~ 186 37  
 on-board equipment 239 6  
 on-board telephone 239 13  
 one-design keelboat 284 62  
 one-half twist isander 282 41  
 Oneirophanta 369 18  
 one-second theodolite 112 73  
 one-two 291 49  
 one-way tap 350 42  
 on full point 314 19  
 on guard line 294 3  
 on guard position 294 18, 33  
 onion 57 24  
 onion skin 57 25  
 on-line disc storage unit 176 32  
 on-load tap changer 153 13  
 on/off switch *Railw.* 211 30  
 on/off switch *Audio* 241 63

on/off switch *Audiovis.* 243 16  
 on/off switch *Office* 247 16; 249 9, 37, 64  
 on/off valve 279 22  
 on-ramp 15 16  
 on-the-ground wrestling 299 8  
 open gate 301 65  
 open-hearth furnace 147 21-30  
 opening 122 24  
 opening, pharyngeal ~ 19 24  
 opening control 313 8  
 open-newel staircase 123 76  
 open-reel tape 241 58  
 open vertical gate 301 67  
 open work 102 27  
 opera glass 315 9  
 opera hat 35 36  
 operating cabin 228 21  
 operating handle 309 81  
 operating indicator 244 11  
 operating instructions 244 15  
 operating key 243 13, 41, 48; 246 19; 261 45  
 operating lamp 27 25  
 operating lamp, shadow-free ~ 26 10  
 operating lamp, swivel-mounted ~ 26 10  
 operating lever *Pest Contr.* 83 21  
 operating lever *Cine Film* 117 63  
 operating lever *Road Constr.* 201 12  
 operating mechanism housing 153 60  
 operating table 26 8, 36  
 operating table, pedestal ~ 26 5  
 operating theatre 26 1-33  
 operating valve 153 52  
 operation indicator 244 7  
 operations, arithmetical ~ 344 23-26; 345 1-10  
 operator *Post* 237 35  
 operator *Computer* 244 14  
 operator *Theatre* 316 59  
 operator, chief ~ 244 3  
 operator's position 237 34  
 operator's set 237 23  
 operculum 364 5  
 ophthalmic test stand 111 43  
 ophthalmometer 111 44  
 ophthalmoscope 22 62  
 opium poppy 380 15  
 opponent 293 18  
 optical bench 114 50; 242 79  
 optical instruments 112; 113 60; 311 6  
 optical sound recorder 310 60; 311 6  
 optical sound recording 311 9  
 optical sound recording equipment 311 6  
 optical sound unit 312 45  
 optical system 242 41; 243 50  
 optician 111 1  
 optic plate, right-hand ~ 195 18

optometer 111 44  
 or 254 24  
 orange *Colour* 343 7  
 orange *South. Fruits* 384 23, 27  
 orange flower 384 25  
 orange peel, candied ~ 98 11  
 orangery 272 3  
 orange tip butterfly 365 3  
 orange tree 55 49  
 orang-utan 368 15  
 orang-utan 368 15  
 orbicular 370 33  
 orbicularis oculi 19 5  
 orbicularis oris 19 8  
 orbiculate 370 33  
 orbit, moon's ~ 4 1  
 orbital manoeuvring main engine 235 44  
 orb spinner 358 45  
 orchard 15 108  
 orchard sprayer, mobile ~ 83 38  
 orchestra *Theatre* 315 25  
 orchestra *Art* 334 47  
 orchestra pit 315 24  
 orchestrion 308 38; 309 14  
 orchid 376 28  
 orchis 376 28  
 ordinal 344 6  
 ordinate 347 10  
 ore 147 2  
 ore 252 24, 25, 26  
 ore deposit 11 31  
 organ 326 1-5, 1-52  
 organ, automatic ~ 308 38  
 organ, portable ~ 322 56  
 organ, portable ~ 322 56  
 organ, positive ~ 322 56  
 organ, suctorial ~ 81 36  
 organ case 326 1-5  
 organ console 326 36-52  
 organelle 357 5  
 organistrum 322 25  
 organ of equilibrium and hearing 17 56-65  
 organ pipes 326 17-35  
 organs, internal ~ 20 1-57  
 orifice, cardiac ~ 20 41  
 original 177 18  
 origin of ordinates 347 4  
 Orion 3 13  
 ornament, Rococo ~ 336 13  
 ornamental 53 16  
 ornamentation, Greek ~ 334 38-43  
 ornamentation, Romanesque ~ 335 14-16  
 ornaments 321 14-22  
 orogeny 12 4-20  
 orogeny 12 4-20  
 orographic lift 287 28  
 orpine 377 9  
 orthopinacid 351 25  
 orthopteron 358 8  
 ortolan 361 7  
 ortolan bunting 361 7  
 Orton cone 161 6  
 oscillation counter 110 17  
 osier branch 371 29  
 osier rod 136 15

osier stake 136 14  
 ossicles, auditory ~ 17 61  
 Ostiak 353 17  
 ostrich 359 2  
 ostrich egg 359 3  
 ostrich feather 254 30  
 Ostyak 353 17  
 os uteri externum 20 85  
 otter 367 17  
 otter boards 90 13  
 Otto-cycle engine 190 1  
 Otto-cycle internal combustion engine 190 2  
 outboard 278 15; 283 6, 7  
 outboard inflatable 286 1  
 outboard motor 278 15; 283 7; 286 1, 21  
 outboard motorboat 283 6  
 outboard speedboat 283 6  
 outdrive motorboat 286 2  
 outer case 187 30  
 outfall 216 36  
 outfielder 292 41  
 outflow condenser 92 4  
 outhouse 62 14  
 outlet *Electr.* 127 5  
 outlet *Paperm.* 172 78  
 outlet *Water* 269 21  
 outlet, double ~ 127 6  
 outlet cock 178 34  
 outlet control valve 269 30  
 outlet duct 92 19  
 outlet structure 217 44  
 outlet to brake line 192 53  
 outlet tunnel 217 62  
 outlet valve 269 31  
 outline drawing 129 46  
 output 117 28  
 output gear box 212 53  
 outrigger *Rowing* 283 42  
 outrigger *Ethnol.* 352 36  
 outrigger canoe 352 35  
 outside broadcast vehicle 239 1-15  
 outside defender 291 13  
 outside forward 291 16  
 outside grip 296 45  
 outsider 289 53  
 ovary *Man* 20 83  
 ovary *Soft Fruit* 58 40  
 ovary *Bot.* 370 54, 60  
 ovary *Shrubs etc.* 373 2, 5  
 ovary *Flowers etc.* 375 34  
 ovary, epigynous ~ 58 7  
 ovary, perigynous ~ 59 14  
 ovary cavity 370 62  
 ovary wall 370 61  
 ovate 370 36  
 oven 39 13; 97 66, 71  
 oven, electric ~ 207 30  
 oven window 39 14  
 overall 33 56  
 overalls, hairdresser's ~ 106 2  
 overalls, leather ~ 290 26  
 over-and-under shotgun 305 70  
 overblouse 31 61  
 overblouse, girl's ~ 29 48  
 overburden 158 2  
 overburden excavator 159 3  
 overdress 31 17

overfall 91 43  
 overfeed, initial ~ 168 26  
 overflow *Roof & Boilerr.* 38 69  
 overflow *Bathrm. etc.* 49 25, 45  
 overflow *Fish Farm.* 89 5  
 overflow *Water* 269 33  
 overflow basin 272 23  
 overflow container 350 60  
 overflow pipe 38 69; 269 20, 33  
 overflow spillway 217 60  
 overfold 12 14  
 overgown 355 36, 50  
 overgrasp 296 40  
 overhead bicycle kick 291 45  
 overhead camshaft 189 3; 190 14  
 overhead contact wire 197 41; 205 58  
 overhead line support 152 36  
 overhead projector 261 8  
 overhead spray washing plant 169 29  
 overhead wire maintenance vehicle 211 41  
 overhead wire voltage indicator 211 28  
 overlap angle 128 51  
 overlay flooring 123 62  
 overload indicator 224 33  
 oversite concrete 123 13  
 overskirt, panniered ~ 355 83  
 over tile 122 58  
 overtop 29 48  
 overtop, knitted ~ 30 4, 31 65  
 oviduct 20 81  
 ovule 58 39; 59 14; 370 63  
 ovum 20 84  
 owl 252 2  
 owl-glass 306 38  
 owls 362 14-19  
 ox *Dom. Anim.* 73 1  
 ox *Slaughterho.* 94 2  
 ox *Meat* 95 14-37  
 oxer 289 8  
 ox eye 361 9  
 oxeye daisy 376 4  
 oxeye daisy, white ~ 51 24  
 Oxford 101 31  
 Oxford shoe 101 31  
 ox hide, painted ~ 354 11  
 oxidation 170 19  
 oxidation, controlled ~ 169 7  
 oxide ceramic 149 46  
 oxteam 63 16  
 oxygen apparatus *Moon L.* 6 18  
 oxygen apparatus *Fire Brig.* 270 20  
 oxygen atom 1 13  
 oxygen-blowing converter 147 45-50  
 oxygen connection 141 30  
 oxygen control 141 29  
 oxygen cylinder *Hosp.* 27 45  
 oxygen cylinder *Gas Weld.* 141 3, 21  
 oxygen cylinder *Road Constr.* 200 40



oxygen flow meter 26 4  
 oxygen hose 141 10  
 oxygen inlet 350 11  
 oxygen jet 350 13  
 oxygen lance 147 49  
 oxygen molecule 242 65  
 oxygen supply 25 22  
 oxygen tank *Moon L.* 6 6  
 oxygen tank *Space* 234 61  
 oxygen tank *Air Force* 257 2  
 oxygen treatment 25 23  
 oxymeter 27 13  
 oxysphere 11 1  
 oyster 357 32  
 oyster fork 45 80  
 oyster round 95 11  
 ozone layer 7 13, 19

## P

pace 72 40  
 pacemaker 25 36  
 pacemaker, cardiac ~ 25 31, 37  
 pacemaker, internal ~ 25 37  
 pacemaker, short-term ~ 25 25  
 pacemaker battery 25 51  
 pacemaker control unit 25 40  
 pacemaker impulse 25 44  
 pacemaker unit 25 30  
 pacer 290 11  
 Pacific Ocean 14 19  
 pack *Dom. Anim.* 73 5  
 pack *Hunt* 86 33  
 pack *Airsports* 288 44  
 pack, disposable ~ 93 28  
 package, unitized ~ 226 21  
 package cargo transit shed 225 9  
 package freight 206 4, 27  
 pack animal 354 3  
 packing, sterile ~ 26 31  
 packing box 210 33  
 packing box dispenser 74 53  
 packing machine 76 36  
 pack of hounds 86 33; 289 46  
 pack saddle 73 4  
 pad *Horse* 71 49  
 pad *Game* 88 46  
 pad *Shoem.* 100 16  
 pad *Ball Games* 292 9  
 pad *Graphic Art* 340 13  
 pad, bakelite ~ 166 64  
 pad, leather ~ *Goldsm. etc.* 108 29  
 pad, leather ~ *Weaving* 166 64  
 pad, suctorial ~ 77 9  
 pad, unsterile ~ 26 23  
 pad bridge 111 12  
 padding, foam rubber ~ 291 20  
 paddle *Brew.* 92 46  
 paddle *Electrotyp. etc.* 178 25, 33  
 paddle *Ship* 218 8  
 paddle *Ethnol.* 353 14  
 paddle, double-bladed ~ 283 39

paddle, double-ended ~ 283 39  
 paddle, single-bladed ~ 283 34  
 paddle boat 280 12  
 paddling pool 37 44; 273 28  
 paddock 319 15  
 padlock 38 21  
 page *Bookbind.* 185 53  
 page *Hotel* 267 18  
 page, double-column ~ 185 64  
 page, front ~ 342 38  
 pageboy 267 18  
 pageboy style 34 35  
 page cord 174 16  
 page heading 342 52  
 page number 185 63; 251 14  
 page printer 237 66  
 pagoda, Indian ~ 337 21  
 pagoda, multi-storey ~ 337 1  
 pail 50 54  
 pailoo 337 3  
 pailou 337 3  
 paint 129 6, 7-8, 9; 338 10  
 paintbox 48 6; 338 10  
 paintbrush 48 7; 129 3; 260 84  
 paint bucket 129 10  
 paint container 315 34  
 Painter *Astron.* 3 47  
 painter *Painter* 129 2  
 painter *Art. Studio* 338 2  
 painting 129 1; 260 27  
 painting, watercolour ~ 48 5  
 painting materials 338 6-19  
 painting surface 338 22  
 painting table 338 25  
 paint kettle 129 8  
 paint roller 129 11  
 paint room 315 28-42  
 paint scraper 129 22  
 paint trolley 315 36  
 pair 275 20  
 pairing season 86 9-12  
 pair skater 302 4  
 pajamas 32 17, 36  
 palace, Baroque ~ 272 7  
 palace, Renaissance ~ 335 47  
 palace buildings 333 29  
 palace gardens 272 1-40  
 Palaeolithic period 328 1-9  
 Palaeopneustes niasicus 369 19  
 palate, hard ~ 19 20  
 palate, soft ~ 19 21  
 pale ale 93 26  
 palette 338 28  
 palette dipper 338 29  
 palette knife 338 14  
 paling 52 10  
 palisade *Equest.* 289 8  
 palisade *Chivalry* 329 36  
 palisading 329 36  
 palla 355 10  
 pallbearer 331 40  
 pallet *Porcelain Manuf.* 161 20  
 pallet *Station* 206 32  
 pallet *Docks* 225 43; 226 7  
 pallet *Music. Instr.* 326 10

pallet, flat ~ 226 10  
 pallet, standard ~ 226 10  
 palette 329 45  
 palm 88 41  
 Palma Christi 380 14  
 palma manus 19 71  
 palmate 370 39  
 palmation 73 36; 359 7  
 palm capital 333 25  
 palm column 333 17  
 palmette 334 41  
 palm frond 384 3  
 palm of the hand 19 71  
 palm rest 255 13, 19; 305 45  
 palm tree 354 5  
 palpebra, lower ~ 19 40  
 palpebra, upper ~ 19 39  
 pampas grass 51 8  
 pamphlet 330 57  
 pan *Household* 50 52  
 pan *Carp.* 120 59  
 pan *School* 260 60  
 panache 329 78  
 Panama hat 35 16  
 pan and tilt head 114 48; 313 12  
 pancreas 20 44  
 Pandean pipes 322 2  
 pandora 322 21  
 pane 66 10; 137 27  
 panel 120 59  
 panel, front ~ 32 24  
 panel, mirrored ~ 267 66  
 panelboard 157 67  
 panelling, metal ~ 208 6  
 panelling, wood ~ 281 19, 266 37  
 panel pin 124 29  
 pane of glass 124 16  
 pangolin 366 10  
 pan grinding mill 159 8  
 Panhard rod 192 70  
 panicle 68 27; 370 69; 378 46; 382 54  
 pan loaf 97 10  
 pannier 78 15  
 panpipes 322 2  
 pan set 40 12-16  
 pansy 60 2  
 pantaleon 325 1  
 pantaloons 306 42  
 pantie briefs 32 8  
 pantie-corsette 32 3  
 pantie-girdle 32 2  
 pantie-hose 32 12  
 panties, long-legged ~ 32 10  
 pantile 122 54  
 pantograph *Map* 14 65  
 pantograph *Composing Rm.* 175 58  
 pantograph *Tram* 197 23  
 pantograph carriage 175 53  
 pantry, ship's ~ 223 43  
 pants, long ~ 32 11  
 paper *Photog.* 116 50  
 paper *Drawing Off.* 151 14  
 paper *Paperm.* 173 2-10  
 paper *Offset Print.* 180 47  
 paper *Letterpress* 181 46  
 paper *Office* 249 57  
 paper, asphalted ~ 153 48

paper, blank ~ 180 2, 69; 181 23, 30  
 paper, coated ~ 173 35  
 paper, cork ~ 128 18  
 paper, metallic ~ *Paperhanger* 128 18  
 paper, metallic ~ *Power Plant* 153 44  
 paper, metallized ~ 153 44  
 paper, natural ~ 128 18  
 paper, printed ~ 180 57; 181 9, 25  
 paper, raw ~ 173 29  
 paper, unprinted ~ 180 2, 69; 181 23, 30  
 paper, wood ~ 128 18  
 paper bag, cone-shaped ~ 98 49  
 paper bail 249 17  
 paper chase 289 41-49  
 paper clip 247 1, 2  
 paper edge, butted ~ 128 20  
 paper feed 245 11; 249 45, 49  
 paper feed and delivery 181 14  
 paper feeding and delivery unit 181 14  
 paperhanger 128  
 paper hanging 128 18-53  
 paperhanging brush 128 40  
 paperhanging kit 128 33  
 paper hunt 289 41-49  
 paper machine 173 11, 13-28  
 papermaking 172; 173  
 papermaking by hand 173 46-51  
 paper punch 22 28  
 paper recorder 25 56, 57  
 paper recorder unit 27 33  
 paper reed 383 64  
 paper release lever 249 20  
 paper ribbon 174 34  
 paper roll 249 33; 309 75  
 paper roller 128 47  
 paper rush 383 64  
 paper size selection 249 34  
 paper speed scale 116 54  
 paper stand 151 13  
 paper tape 237 32  
 paper towel 196 11  
 paper-towel dispenser 196 10  
 paper tower 174 33, 43  
 pappus 375 34  
 pappus bristle 375 33  
 pappus tuft 378 11  
 paprika 57 42  
 papyrus column 333 15  
 papyrus plant 383 64  
 par 251 12  
 para 252 28  
 parabola 347 14  
 parachute *Meteorol. Instr.* 10 57  
 parachute *Airsports* 288 37  
 parachuting 288 37-62  
 paraffin 145 60  
 paraffin lamp 278 29  
 paraffin oil 145 60  
 paragon 175 31  
 Paraguay tea 382 11  
 parallel 346 4

parallel bars 296 2  
 parallelepiped 347 36  
 parallel of latitude 14 2  
 parallelograms 346 33-36  
 parallels 14 1-7  
 Paramecium 357 9  
 parapet *Dwellings* 37 19  
 parapet *Bridges* 215 70  
 parapet *Chivalry* 329 21  
 parapet, battlemented ~ 329 20  
 parasites 81  
 parasites of man 81 31-42  
 parasol mushroom 381 30  
 paravane 258 87  
 parcel *Station* 204 2  
 parcel *Post* 236 3, 6  
 parcel registration card 236 7  
 parcel registration slip 236 4  
 parcels counter 236 1  
 parcels office 204 1  
 parcels scales 236 2  
 parent 54 15  
 parentheses 342 24  
 parent plant 54 15  
 paring knife 100 51  
 parison 162 47  
 parison mould 162 26  
 park *Map* 15 97  
 park *Park* 272  
 park *Ball Games* 291 1; 292 40-58  
 park, landscaped ~ 272 41-72  
 parka 29 66  
 parka coat 29 66  
 park bench 272 16, 42  
 park by-law 272 29  
 park chair 272 48  
 park entrance 272 32  
 park gardener 272 66  
 parking meter 268 1  
 park keeper 272 30  
 park path 272 38  
 park railing 272 33  
 parlour, herringbone ~ 75 23  
 parquet floor 123 74  
 parquet strip 123 62  
 parrot 363 1  
 parrying 294 6  
 parry of the fifth 294 24  
 parry of the quinte 294 24  
 parry of the tierce 294 8  
 parsley 57 19  
 parsonage 331 20  
 part, imaginary ~ 344 14  
 part, real ~ 344 14  
 parterre 272 39  
 Parthenon 334 1  
 partial-hip end 121 17  
 parting, centre ~ 34 9  
 parting, side ~ 34 14  
 parting kiss 205 52  
 parting-off tool 149 53  
 parting tool *Turner* 135 24  
 parting tool *Mach. Tools* 149 53  
 partition 75 38  
 partition, framed ~ 120 48  
 partition, glass ~ 25 8  
 partition, sound-absorbing ~ 248 20

partition, wooden ~ 38 19  
 partition screen 248 1  
 partition wall *Bldg. Site* 119 25  
 partition wall *Office* 248 1  
 part load 206 4  
 part-load goods 206 27  
 partridge 88 70  
 partridge call 87 47  
 party 263 20  
 party, private ~ 267 40-43  
 party blouse 30 55  
 party games 276  
 party skirt 30 56  
 par value 251 12  
 Paschen series 1 22  
 pas de (rois) 314 27-28  
 Pasiphaea 369 12  
 pass *Phys. Geog.* 12 47  
 pass *Ball Games* 291 47  
 pass, short ~ 291 49  
 passage 71 3  
 passage, barred ~ 307 51  
 passage grave 328 16  
 passe 275 19  
 passenger 204 24; 205 6; 208 30; 221 97, 109  
 passenger aircraft 231 2  
 passenger cabin 231 22  
 passenger car 208 3  
 passenger coach 207 1-21; 208 3  
 passenger compartment 207 13  
 passenger door, centre ~ 231 25  
 passenger door, rear ~ 231 30  
 passenger ferry 216 1  
 passenger liner 221 82; 225 32  
 passenger loading bridge 233 14  
 passenger seat *Car* 191 36  
 passenger seat *Lorries etc.* 194 14  
 passenger seat *Aircraft* 230 38; 231 22  
 passenger sledge 353 18  
 passenger terminal 225 31  
 passenger vehicle 191 1-56; 195 34  
 passerines 361  
 Passiflora 53 2  
 passion flower 53 2  
 passport 267 13  
 'passport check' 233 42  
 pastas 98 32-34  
 paste 128 26  
 paste, heavy-duty ~ 128 24  
 pasteboard 128 31  
 paste brush 128 27  
 pastel crayon 338 19  
 pastern 72 25  
 pasting machine 128 25  
 pastor *Church* 330 22  
 pastor *Birds* 361 4  
 pastry whirl 97 38  
 pasture, rough ~ 15 5  
 patch pocket 29 68; 30 22; 31 56; 33 38; 35 37  
 pâté 96 15



patella 17 23  
 paten 330 9; 332 51  
 patent 246 26  
 patent anchor 222 78; 258 5;  
 286 17  
 patent key 187 50  
 patent log 224 54  
 patent valve 187 31  
 paternoster 332 31  
 path, central ~ 55 42  
 path, gravel ~ 272 18  
 path, unfenced ~ 15 102  
 patient 22 2, 3; 24 2; 274 7, 18  
 patients file 22 6  
 patin 330 9; 332 51  
 patine 330 9; 332 51  
 patrician lady 355 48  
 patrol car 264 10  
 patrolman 264 13  
 patrol submarine 259 75  
 patten 355 43  
 pattern *Iron Foundry etc.* 148  
 34  
 pattern *Composing Rm.* 175  
 55  
 pattern, chequered ~ 335 14  
 pattern control chain 167 19  
 pattern repeat 171 12  
 pattern stencil 168 62  
 pattern table 175 56  
 pauldron 329 45  
 Pauli exclusion principle 1 7  
 Pauli principle 1 7  
 pause 321 25  
 pause sign 321 25  
 pavais 329 56  
 pavement 37 60; 198 8, 9  
 paving 198 8  
 paving, brick ~ 123 7  
 paving, flagstone ~ 123 26  
 paving brick 159 27  
 pavis 329 56  
 Pavo 3 41  
 paw 88 46, 50; 368 4  
 paw, hind ~ 70 8  
 pawn 276 13  
 payee 250 19  
 payer 250 20  
 paying agent 250 22  
 paying-in counter 236 25  
 paying-in slip 236 27  
 payload bay 235 26  
 payload bay door 235 14  
 payload bay insulation 235 13  
 payload manipulator arm 235  
 29  
 pay phone 236 9; 237 3  
 pea 57 1, 7  
 peach 59 31  
 peach blossom 59 27  
 peach flan 97 22  
 peach flower 59 27  
 peach leaf 59 32  
 peach tree 59 26-32  
 Peacock *Astron.* 3 41  
 peacock *Dom. Anim.* 73 30  
 peacock butterfly 365 2  
 pea flower 57 2  
 pea jacket 221 127  
 peak 11 6; 12 40  
 peanut 45 41; 383 41

pear 58 33  
 pear blossom 58 38  
 pearl *Jewell.* 36 8  
 pearl *Game* 88 30  
 pearl *Composing Rm.* 175 22  
 pearl *Invertebr.* 357 35  
 pearl barley 98 35  
 pear pip 58 37  
 pears 99 87  
 pear-shape, faceted ~ 36 84  
 pear-shape, plain ~ 36 83  
 pear-shape, standard ~ 36 54  
 pear-shapes 36 82-86  
 pear stalk 58 34  
 pear tree 58 31, 32  
 peasecod 355 30  
 peat 55 31; 206 10  
 pea tendril 57 4  
 peavy 85 9  
 peba 366 8  
 pebble, painted ~ 328 6  
 pectoralis, greater ~ 18 36  
 pectoralis major 18 36  
 pedal *Joiner* 132 72  
 pedal *Bicycle* 187 40, 78  
 pedal *Sports* 305 85  
 pedal *Music. Instr.* 323 62;  
 325 41, 46  
 pedal, adjustable ~ 298 2  
 pedal, left ~ 325 9  
 pedal, right ~ 325 8  
 pedal bracket 325 42  
 pedal car 273 55  
 pedal crank 188 25  
 pedal cylinder 163 27  
 pedal drive 188 25  
 pedal frame 187 83  
 pedal harp 323 60  
 pedal key 326 51, 52  
 pedal lever 163 28  
 pedal mechanism 324 54  
 pedal pipe 326 3  
 pedal roller 163 27, 28  
 pedal tower 326 4  
 peddle boat 280 12  
 pedestal *Optic. Instr.* 113 2  
 pedestal *Office* 248 37  
 pedestal *Park* 272 11  
 pedestal *Circus* 307 55  
 pedestal crane 146 3  
 pedestal grinding machine  
 138 7  
 pedestal mat 49 18  
 pedestrian 268 18  
 pedestrian crossing 198 11;  
 268 24, 51  
 'pedestrian crossing' sign 268  
 29  
 pedestrian lights 268 55  
 pedestrian precinct 268 58  
 pedicel 59 4; 383 7  
 pediculate 369 6  
 pediment *Phys. Geog.* 13 65  
 pediment *Art* 334 3; 335 36  
 peduncle 59 4; 383 7  
 peeler 133 1  
 peeling machine 133 1  
 peen 66 10; 137 27  
 peewit 359 21  
 peg *Floor etc. Constr.* 123 11  
 peg *Camping* 278 24

peg *Music. Instr.* 323 18; 324  
 11  
 Pegasus *Astron.* 3 10  
 Pegasus *Fabul. Creat.* 327 26  
 pegbox 323 19  
 pegbox, bent-back ~ 324 10  
 pegbox, swan-head ~ 324 10  
 pegdisc 324 19  
 pein 137 27  
 Pekinese dog 70 19  
 Peking man 261 18  
 pelargonium 53 1  
 pelican 359 5  
 pelican eel 369 2  
 pellitone 323 44  
 pelorus 224 53  
 pelota 305 67  
 pelota player 305 68  
 pelvis 17 18-21  
 pelvis, renal ~ 20 31  
 pen *Livestock* 75 36  
 pen *Office* 245 21  
 pen *School* 260 14  
 pen, ballpoint ~ 47 26  
 pen, felt tip ~ 47 26; 48 18  
 pen, metal ~ 341 25  
 penalty 291 40  
 penalty area 291 4  
 penalty kick 291 40  
 penalty line 292 5  
 penalty spot 291 6  
 pen and pencil case 260 12  
 pen and pencil tray 245 22;  
 260 24  
 pencil 47 26; 129 41; 260 5  
 pencil, carpenter's ~ 120 77  
 pencil, clutch-type ~ 151 45  
 pencil, coloured ~ 48 11  
 pencil, lead ~ 118 51  
 pencil attachment 151 62  
 pencil box 309 73  
 pencil holder 22 31  
 pencil lead 151 46  
 pencil of rays 346 19  
 pencil point attachment 151  
 55  
 pencil sharpener 247 25  
 pencil silhouette 31 14  
 pen clip 2 18  
 pendant 335 32  
 pendant, gemstone ~ 36 14  
 pendant, oblong ~ 253 28  
 pendants 253 30-32  
 pendeloque 36 54  
 pendentive 334 74  
 pendulum *Atom* 2 35  
 pendulum 110 27; 309 58  
 pendulum device 2 35  
 pendulum spray 83 27  
 penguin 359 4  
 peninsula 13 5  
 penis 20 66  
 penlight pocket 6 24  
 pen meter 2 15  
 pennant, oblong ~ 253 28  
 pennants 253 30-32  
 pennon 278 9; 280 11  
 pennon staff 280 10  
 pensions counter 236 25  
 Pentacrinus 369 3  
 pentagon 351 9

pentaprism 115 41, 70  
 pentaprism viewfinder,  
 interchangeable ~ 115 69  
 penthouse 37 83  
 penthouse head 312 50  
 penthouse roof 37 55  
 pent roof 37 55, 78; 121 7  
 penumbra 4 34  
 peplos 355 2  
 pepper 382 39  
 peppercorn 382 39  
 peppermint 380 3  
 pepper plant 382 36  
 pepper pot 266 77  
 percentage focusing chart 177  
 7  
 percentage key 247 23  
 percentage sign 345 7  
 percent key 247 23  
 perch 86 49  
 percolation of a river 13 73  
 percussion cap *Hunt.* 87 59  
 percussion cap *Carnival* 306  
 49  
 percussion drill, electric ~ 134  
 43  
 percussion instruments 323  
 49-59; 324 47-58  
 percussion screwdriver 138 6  
 percussor 22 73  
 peregrine falcon 362 2  
 perennial 52 22  
 perennial, flowering ~ 52 9  
 perfect binder 184 1; 249 61  
 perfect fifth 321 10  
 perfect fourth 321 9  
 perfecting unit 181 49  
 perfecting unit for black 180  
 12-13  
 perfecting unit for cyan 180  
 8-9  
 perfecting unit for magenta  
 180 10-11  
 perfecting unit for yellow 180  
 6-7  
 perfect octave 321 13  
 perforated brick 159 21  
 perforation 236 62  
 perforator *Paperhanger* 128  
 12  
 perforator *Composing Rm.*  
 176 5  
 perfume bottle 43 27; 105 36  
 perfume spray 43 26; 106 21  
 pergola 37 80; 51 1; 272 17  
 pericarp 57 6  
 pericementum 19 28  
 perineum 20 64  
 period 342 16  
 periodical 262 15  
 periodicals rack 262 15  
 periodontium 19 28  
 periphery 346 44  
 peristomion 322 5  
 peristyle 334 2  
 peritoneum 20 58  
 perlon fibres 170 1-62  
 Permian 154 62  
 peroneus longus 18 64  
 perpendicular 346 6, 27, 28  
 perpetual frost climate 9 58

Persian cat 73 17  
 Persian lamb 30 60  
 personnel carrier, armoured  
 ~ 255 91  
 Peru Current 14 42  
 pesade 71 4; 307 30  
 peseta 252 22  
 pest control 83  
 pestle 349 10  
 petal 58 43; 59 11; 370 59  
 petasus 355 4  
 pet foods 99 36-37  
 petiole 370 27  
 petri dish 173 7; 261 25  
 petrol can 196 25  
 petrol canister 84 36  
 petroleum *Phys. Geog.* 12 31  
 petroleum *Oil, Petr.* 145 41  
 petroleum gas, liquefied ~  
 145 53  
 petroleum reservoir 12 27  
 petrol lighter 107 27  
 petrol motor 83 41  
 petrol pump 196 1  
 petrol pump, self-service ~  
 196 8  
 petrol pump hose 196 2  
 petrol station 196 1-29  
 petrol tank 188 10, 28; 189 2;  
 305 87  
 petticoat 355 37  
 petty cash 246 27  
 petty morel 379 5  
 petunia 53 6  
 pew 330 28  
 pewit 359 21  
 Pfund series 1 24  
 phaeton 86 18; 186 38  
 phalange 17 17, 29; 19 77  
 phalanx 17 17; 19 77  
 pharmacopoeia 22 23  
 pharynx 19 24  
 phases, lunar ~ 4 2-7  
 pheasant 88 77  
 pheasant cock 88 77  
 pheasant hen 88 77  
 pheasant's eye 60 4  
 phenol 170 3, 14, 16  
 phenol extraction 156 39  
 philomel 361 14  
 philomela 361 14  
 philtrum 16 12  
 phloem 370 9  
 phlox 60 14  
 Phoenix 327 9  
 phonetics 342 14  
 phonetic transcription 342 14  
 phorbeia 322 5  
 phoropter 111 44  
 phosphorescent material 240  
 18  
 photocell *Garage* 195 21, 22  
 photocell *Films* 312 49  
 photocomposition 176  
 photocomposition system 176  
 29  
 photodiode 114 70; 243 56  
 photoengraving, halftone ~  
 178 38  
 photogrammetry 14 63-66;  
 112 67

photographic plate 309 49, 50  
 photographic unit 176 14  
 photography 114; 115; 116  
 photography, underwater ~  
 279 23  
 photogravure 182  
 photomechanical  
 reproduction 177  
 photometer 23 54  
 photometer, microscopic ~  
 112 49  
 photometry 23 52, 53  
 photomicrographic camera  
 attachment 112 36  
 photomicro mount adapter  
 112 64  
 photomicroscope 112 34  
 photomicroscope adapter 115  
 89  
 photomultiplier 112 51  
 photosetting 176  
 photosetting system 176 29  
 phototheodolite 112 67  
 phototopography 14 63-66  
 phototypesetting 176 1  
 photo-unit 176 14  
 piaffe 71 1  
 pianino 325 1  
 pianissimo 321 36  
 pianissimo piano 321 37  
 piano *Music. Not.* 321 35  
 piano *Music. Instr.* 325 1, 40  
 piano accordion 324 36  
 piano action 325 2-18  
 piano case 325 6  
 pianoforte 325 1  
 piano keys 325 4-5  
 piano mechanism 325 2-18  
 piano pedal 325 9  
 piano pedals 325 8-9  
 piano string 325 7  
 pica 175 28  
 picador 319 16  
 piccolo 323 30  
 Piciformes 363 6  
 pick 158 31; 300 33  
 pick counter 166 2  
 picker 166 64  
 picker head 184 11  
 picking bowl 166 67  
 picking cam 166 66  
 picking knife 136 38  
 picking stick 166 17, 22  
 picking stick buffer 166 65  
 picking stick return spring  
 166 68  
 pickpocket 308 16  
 pick stick 166 17  
 pickup attachment 62 41; 63  
 27  
 pickup reel 64 4  
 pickup sucker 184 8  
 pickup truck 194 1, 5  
 pickup unit 240 36  
 pictographs 233 24-53  
 Pictor 3 47  
 picture 43 20; 246 28  
 picture, panoramic ~ 24 21  
 picture frame 43 21  
 picture gate 312 34  
 picture house 312 1



picture monitor 238 65; 239 12  
 picture rail 128 29  
 picture tube 240 3  
 picture tube geometry 242 39  
 pier *Bridges* 215 21, 54  
 pier *Docks* 225 66  
 pier *Airport* 233 12  
 pier *Art* 336 25  
 pier, clustered ~ 335 34  
 pier, compound ~ 335 34  
 pier, reinforced concrete ~ 215 61  
 piercing saw 108 12  
 piercing saw blade 108 13  
 pierrette 306 12  
 pierhead 233 13  
 pierrot 306 19  
 pies 97 22-24  
 pig *Farm Bldgs.* 62 10  
 pig *Dom. Anim.* 73 9  
 pig *Livestock* 75 39  
 pig *Slaughterho.* 94 11  
 pig *Meat* 95 38-54  
 pig *Iron & Steel* 147 40  
 pig, solidifying ~ 148 25  
 pig-casting machine 147 34-44  
 pigeon 73 33; 359 23  
 pigeon hole 267 2  
 pig iron, molten ~ 147 55  
 pig iron ladle 147 12, 21, 42  
 pig iron runout 147 11  
 piglet 73 9; 75 42  
 pigment paper 182 1, 8, 10  
 pigmy 354 41  
 pigpen 62 8; 75 35  
 pigskin 292 27  
 pigsty 62 8; 75 35  
 pigtail *Hairst. etc.* 34 6  
 pigtail *Tobacc. etc.* 107 18  
 pigtail wig 34 5; 355 77  
 pig trap 146 31  
 pike *Fish Farm.* 89 17  
 pike *Free Exerc.* 295 38  
 pike *Fish etc.* 364 16  
 pike, spawning ~ 89 11  
 piked reverse hang 296 36  
 pike pole 319 17  
 pi-key 247 24  
 pilaster 335 46  
 pilaster strip 335 11  
 pile 226 40  
 pile, steel ~ 217 4  
 pile delivery unit 180 55  
 pile driver, floating ~ 226 36  
 pile driver frame 226 37  
 pile dwelling 328 15; 352 33  
 pile feeder 180 73  
 pile feeder, automatic ~ 180 48  
 pile foundation 216 8  
 pile hammer 226 38  
 pile of arrow 305 61  
 pile shoe 269 61  
 pileus 381 4  
 piling 157 25  
 pillar *Mach. Tools* 150 21  
 pillar *Shipbuild.* 222 61  
 pillar *Art* 335 20  
 pillar, engaged ~ 335 35, 46

pillar guide 139 42  
 pillar stand *Atom* 2 29  
 pillar stand *Optic. Instr.* 112 32  
 pillar tap 126 31  
 pillion footrest 188 44  
 pillion passenger 268 36  
 pillion rider 268 36  
 pillow 27 27; 43 12-13; 47 4  
 pillowcase 43 12  
 pillow lace 102 18  
 pillowslip 43 12  
 pilot *Railw.* 210 34  
 pilot *Music. Instr.* 325 33  
 pilot, automatic ~ 224 18  
 pilot boat 221 95  
 pilot chute 288 39  
 pilot flag 253 23  
 pilot light 50 10  
 pilot light, covered ~ 38 60  
 'pilot on board' 253 24  
 pilot tone cable 313 29  
 pilot tone generator 313 30  
 pilot tone socket 117 7  
 pilot wire 325 34  
 Pilsener beer 93 26  
 pimehinketone 170 20  
 pin *Roof* 121 93  
 pin *Turner* 135 9  
 pin *Metalwkr.* 140 47  
 pin *Mach. Parts etc.* 143 31  
 pin *Sports* 305 12  
 pin, bronze ~ 328 29  
 pin, cylindrical ~ 143 40  
 pin, diamond ~ 36 18  
 pin, front ~ 305 1  
 pin, grooved ~ 143 40  
 pin, split ~ 143 19, 25, 78  
 pin, tapered ~ 143 37  
 pinacoid, triclinic ~ 351 26  
 pinafore, bib top ~ 29 41  
 pinafore dress 29 13; 30 8; 31 8  
 pin block 324 22; 325 18  
 pincers *Shoem.* 100 40, 41  
 pincers *Plumb. etc.* 126 65  
 pincers *D.I.Y.* 134 13  
 pincers *Basketm.* 136 37  
 pincers *Metalwkr.* 140 69  
 pincers, caudal ~ 81 12  
 pinch bar 158 32  
 pinchcock 350 30  
 pinch roller 243 25  
 pinch roller, rubber ~ 117 35  
 pincushion 104 20  
 pine 372 20  
 pineapple 99 85  
 pineapple flower 384 64  
 pineapple gall 82 40  
 pineapple plant 384 61  
 pine beauty 82 46  
 pine cone 372 26  
 pine hawkmoth 82 27  
 pine moth 82 28  
 pine weevil 82 41  
 pin groove 143 49  
 pin holder 109 16  
 pinion *Game* 88 76  
 pinion *Mach. Parts etc.* 143 92  
 pink *Equest.* 289 13  
 pink *Colour* 343 4

pinnacle 335 29  
 pinnate 370 41  
 pinnatifid 370 40  
 pinnipeds 367 18-22  
 pin slit 143 49  
 pin slot 143 49  
 pin vice 109 16  
 pin wire 124 28  
 pip 276 32  
 pipe *Living Rm.* 42 12  
 pipe *Ship* 221 3  
 pipe *Music. Instr.* 322 57; 326 16, 29  
 pipe, briar ~ 107 39  
 pipe, cast-iron ~ 37 14  
 pipe, cement ~ 200 62  
 pipe, clay ~ 107 34  
 pipe, Dutch ~ 107 34  
 pipe, earthenware ~ 269 35  
 pipe, long ~ 107 35  
 pipe, magic ~ 354 42  
 pipe, perforated ~ 200 62  
 pipe, polyester ~ 67 26  
 pipe, short ~ 107 33  
 pipe, vertical ~ *Dwellings* 37 14  
 pipe, vertical ~ *Fire Brig.* 270 26  
 pipe bender 125 28  
 pipe-bending machine *Plumb.* 125 28  
 pipe-bending machine *Plumb. etc.* 126 82  
 pipe bowl 107 36  
 pipe cleaner 107 46, 48  
 pipe clip *Roof* 122 31  
 pipe clip *Plumb. etc.* 126 56  
 pipe connection, quick-fitting ~ 67 28  
 pipe cutter 126 84  
 pipe-cutting machine 126 10  
 pipeline 145 65  
 pipe of peace 352 6  
 pipe rack *Living Rm.* 42 11  
 piperack *Offshore Drill.* 146 4  
 pipe repair stand 126 11  
 pipes 326 17-35  
 pipe scraper 107 45  
 pipe stem 107 38  
 pipe still 145 36  
 pipe support 67 7, 25  
 pipe supports 126 53-57  
 pipette 22 72; 350 25  
 pipette, automatic ~ 23 44  
 pipette, graduated ~ 350 24  
 pipette stand 23 52  
 pipetting device, automatic ~ 23 47  
 pipe union 350 5  
 pipe vice 126 81  
 pipe wrench 126 61; 127 47; 134 11  
 piping 30 13; 31 7  
 pirate *Sailing* 284 52  
 pirate *Carnival* 306 43  
 pirn 166 30  
 pirn, empty ~ 166 21  
 pirn holder, spring-clip ~ 166 33  
 pirouette 314 24  
 Pisces 4 64

pisciculture 89 1-19  
 pistachio 382 51  
 pistachio nut 382 51  
 pistachio tree 382 49  
 piste 294 2  
 pistil 59 13  
 pistol 255 1  
 pistol, captive-bolt ~ 94 3  
 pistol grip *Hunt.* 87 6  
 pistol grip *D.I.Y.* 134 44  
 pistol grip *Army* 255 6, 38  
 pistol grip *Police* 264 23  
 piston *Drawing Off.* 151 60  
 piston *Intern. Combust. Eng.* 190 37  
 piston *Inf. Tech.* 242 46  
 piston, hydraulic ~ 139 41  
 piston pin 192 26  
 piston pump lever 83 45  
 piston ring 190 37  
 piston rod *Intern. Combust. Eng.* 190 21  
 piston rod *Car* 192 75  
 piston rod *Railw.* 210 33  
 pit *Blacksm.* 138 17  
 pit *Coal* 144 1-51  
 pitcher *Ball Games* 292 50, 68  
 pitcher *Prehist.* 328 35  
 pitcher's mound 292 49, 69  
 pitching 230 67  
 pitching, stone ~ 216 55  
 pitch number 278 42  
 pitch of rivets 143 60  
 pith 370 14  
 pithead building 144 4  
 pithead frame 144 3  
 pithead gear 144 1  
 Pithecanthropus erectus 261 16  
 pith ray 370 11  
 pit hydrant 270 25  
 piton 300 38  
 piton, ringed ~ 300 39  
 pitot-static tube 256 11; 257 1  
 pitot tube 256 11; 257 1  
 pivot *Hairdresser* 106 36  
 pivot *Bridges* 215 69  
 pivot *Winter Sp.* 302 6  
 pivot bearing 91 10  
 pivoting half 215 66  
 pivoting section 215 66  
 pivoting span 215 66  
 pivot pier 215 65  
 pix 330 8; 332 53  
 placard 263 13; 271 65; 308 50  
 place 44 5; 45 3-12  
 place card 45 13  
 place mat 44 4  
 place of issue 250 13  
 place of payment 250 15  
 place of publication 324 43  
 place setting 44 5; 45 3-12  
 placing judge 282 25  
 plaid strap 303 2  
 plain, alluvial ~ 13 10  
 plainclothes policeman 264 33  
 plain part of the cylinder 163 69

plains Indian 352 3  
 plainsong notation 320 1  
 plain-tile roofing 122 2  
 plait 97 41  
 plait, coiled ~ 34 38  
 plaiter 168 30, 35  
 plaiting-down platform 168 37  
 plaits 34 30  
 plaits, coiled ~ 34 32  
 plan *Drawing Off.* 151 19  
 plan *Railw.* 207 10-21, 26-32, 38-42, 61-72, 76  
 planchet 252 43  
 plane *Carp.* 120 64  
 plane *Aircraft* 230 67-72  
 plane *Maths.* 347 31  
 plane, abyssal ~ 11 10  
 plane, circular ~ 347 39  
 plane, high-wing ~ 229 1; 231 2  
 plane, horizontal ~ 4 12  
 plane, low-wing ~ 229 5, 14; 231 1  
 plane, midwing ~ 229 4  
 plane, propeller-driven ~ 231 1-6  
 plane, shoulder-wing ~ 229 3  
 plane, two-seater ~ 288 18  
 plane, types of ~ 231 1-33  
 plane geometry 346 1-58  
 plane iron 132 20  
 plane of symmetry 351 5  
 planer, two-column ~ 150 8  
 planer table 150 11  
 planes 132 15-28  
 planetarium 5 17-28  
 plane tree 371 67  
 plane triangles 346 26-32  
 planets 4 42-52  
 planing boats 286 38-44  
 planing machine, two-column ~ 150 8  
 plank 55 22; 118 87; 120 1, 91; 157 34, 35  
 plank, unsquared ~ 120 94  
 plank, wooden ~ 340 2  
 plank cut 340 4  
 planking 119 52  
 planking, inner ~ 285 57  
 plank platform 118 28  
 plank roadway 118 79  
 plan of locomotive 211 10-18  
 planographic printing method 340 25-26  
 plant 370 15; 382 53  
 plant, anagraceous ~ 53 3  
 plant, asclepiadaceous ~ 53 15  
 plant, climbing ~ 51 5; 52 5; 57 8  
 plant, cyperaceous ~ 53 17  
 plant, ericaceous ~ 53 12  
 plant, female ~ 383 10  
 plant, flowering ~ 58 17  
 plant, fruit-bearing ~ 58 17  
 plant, gesneriaceous ~ 53 7  
 plant, indoor ~ 42 36; 248 14  
 plant, insectivorous ~ 377 13  
 plant, liliaceous ~ 53 13  
 plant, pistillate ~ 383 10  
 plant, pneumatic ~ 92 12

plant, potted ~ 55 25  
 plant, ranunculaceous ~ 60 13  
 plant, tiliaceous ~ 53 9  
 plant, tuberous ~ 68 38  
 plantation, young ~ 84 11, 12  
 plant body 378 49  
 planter 248 13  
 plant in bloom 382 53  
 plant in flower 378 36  
 plant louse 358 13  
 plants, alpine ~ 378 1-13  
 plants, aquatic ~ 378 14-57  
 plants, drupaceous ~ 59 1-36  
 plants, farinaceous ~ 68 1-37  
 plants, indoor ~ 53  
 plants, leguminous ~ 57 1-11  
 plants, medicinal ~ 380  
 plants, poisonous ~ 379  
 plants, pomiferous ~ 58 31-61  
 plants, propagation of ~ 54  
 plants, tropical ~ 382  
 plants of forest, marsh, and heathland 377  
 plant stand 248 13  
 plants used in industry 383  
 plaque *Roulette* 275 12  
 plaque *Sculpt. Studio* 339 38  
 plaster *Hosp.* 26 54  
 plaster *Paperhanger* 128 2  
 plaster *Art. Studio* 338 42  
 plaster, adhesive ~ 21 7; 22 55  
 plaster cast 339 4  
 plaster cup 134 18  
 plasterer 118 83  
 plastering 118 83-91  
 plaster mould 161 15  
 plaster of Paris 128 2; 260 85  
 plasticine 48 12  
 plate 266 11  
 plate, baby's ~ 28 28  
 plate, bottom ~ 45 3  
 plate, curved ~ 178 21  
 plate, deep ~ 44 6; 45 5  
 plate, front ~ 85 35  
 plate, halftone ~ 178 38  
 plate, presensitized ~ 179 31  
 plate, rear ~ 85 40  
 plate, sliding ~ 183 28  
 plate, steel ~ 96 54  
 plate armour 329 65  
 plateau 13 46  
 plate clamp *Electrotyp. etc.* 178 27  
 plate clamp *Offset Platem.* 179 8  
 plate-coating machine 179 1  
 plate cylinder *Offset Print.* 180 25, 38, 53, 62  
 plate cylinder *Letterpress* 181 51, 60  
 plate cylinder *Office* 249 50  
 plate-drying cabinet, vertical ~ 179 27  
 plate girder bridge 215 52  
 plate magazine 113 40  
 plate mount 178 41  
 plate mounting 178 41  
 platen *Letterpress* 181 13, 15, 29  
 platen *Bookbind.* 183 24  
 platen *Office* 249 18



platen *Graphic Art* 340 31  
 platen knob 249 22  
 platen machine 181 13, 29  
 platen press 181 13, 29; 340 29  
 platen variable 249 25  
 plate rack 178 35  
 plate rod 178 6  
 plate whirler 179 1  
 platform *Wine Grow.* 78 20  
 platform *Shoes* 101 8  
 platform *Bldg. Site* 118 87;  
 119 52  
 platform *Station* 205 1, 14  
 platform *Swim.* 282 7, 8  
 platform *Art. Studio* 338 30  
 platform, continental ~ 11 8  
 platform, covered ~ 218 49  
 platform, intermediate ~ 145  
 5  
 platform, operator's ~ 168 23  
 platform, wave-cut ~ 13 31  
 platform clock 205 46  
 platformer 145 47  
 platform lighting 205 48  
 platform loudspeaker 205 27  
 platform mailbox 205 56  
 platform number 205 4  
 platform post box 205 56  
 platform railing 118 24  
 platform roofing 205 5  
 platform scale 204 5  
 platform seat 205 54  
 platform sole 101 8  
 platform telephone 205 57  
 platform truck 194 6  
 platypus 366 1  
 play area 272 44  
 playback deck 238 4  
 playback deck, single ~ 238 56  
 playback head 311 25  
 player 48 20  
 player's name 293 36  
 playgoer 315 8  
 playground, children's ~ 273  
 playing card 276 36, 37  
 play pen 28 39  
 playsuit 29 11, 19, 22  
 plaza de toros 319 5  
 pleasure boat 283 1  
 pleasure steamer 221  
 101-128; 225 29  
 pleasure vehicle 186 33  
 pleat, front ~ 31 25  
 plectrum 322 19; 324 20  
 Pleiades 3 26  
 Pleiads 3 26  
 pleiobar 9 2  
 plexus, brachial ~ 18 27  
 pliers, flat-nose ~ 126 62; 140  
 66  
 pliers, multiple ~ 134 12  
 pliers, round-nose ~ 126 64;  
 127 50  
 pliers, shoemaker's ~ 100 38  
 plinth *Dwellings* 37 17  
 plinth *Carp.* 120 28  
 plinth *Art* 334 31  
 plinth, natural stone ~ 37 85  
 Plough *Astron.* 3 29  
 plough *Agr.* 63 6  
 plough *Brew.* 92 24

plough, four-furrow ~ 63 40  
 plough, mounted ~ 65 62  
 plough, reversible ~ 65 62  
 plough, single-bottom ~ 65 1  
 plough anchor 286 16  
 plough beam 65 9, 71  
 plough bottom 65 4-8, 64-67  
 plough frame 65 70  
 plough handle 65 3  
 ploughshare 65 7, 65; 328 33  
 plough stilt 65 3  
 plovers 359 19-21  
 plow 63 6  
 plow *see* plough  
 plowshare 328 33  
 plucking device 322 19  
 Pluderhose 355 34  
 plug *Tobacc. etc.* 107 19  
 plug *Plumb. etc.* 126 55  
 plug *Metalwkr.* 140 45  
 plug, double-jointed ~ 89 70  
 plug, earthed ~ 127 9  
 plug, multi-pin ~ 241 70  
 plug, single-jointed ~ 89 69  
 plug, three-pin ~ 127 67  
 plugboard 242 69  
 plug gauge 149 56  
 plugging 123 69  
 plugging sand bucket 158 29  
 plug point 127 5  
 plug point, double ~ 127 6  
 plug socket 50 78  
 plum 59 25  
 plum, black-skinned ~ 59 20  
 plum, oval ~ 59 20  
 plumb bob 118 50, 71  
 plumber 125; 125 17; 126;  
 126 1  
 plumber's tools 126 58-86  
 plumbing fixtures 126 26-37  
 plume *Heraldry* 254 36  
 plume *Chivalry* 329 78  
 plumicorn 88 78; 362 16  
 plum leaf 59 21  
 plummet *Fish Farm.* 89 91  
 plummet *Bldg. Site* 118 50, 71  
 plum slice 97 43  
 plum stone 59 23  
 plum tree 59 19-23  
 plumule 370 90  
 plunger *Oil, Petr.* 145 23  
 plunger *Glass Prod.* 162 32  
 plunger *Car* 192 7  
 plus sign 344 7, 23  
 Pluto 4 52  
 pneumatic pick longwall face  
 144 35  
 pneumatophore 370 82  
 pneume 320 1  
 poacher 86 29  
 pochette 322 20  
 pocket, front ~ 30 23; 33 46;  
 260 10  
 pocket, inset ~ 29 63; 31 4  
 pocket billiards 277 7  
 pocket book 264 36  
 pocket calculator 246 12  
 pocket calculator, electronic  
 ~ 247 14  
 pocket camera 114 16  
 pocket chamber 2 15

pocket flap 33 18  
 pocket meter 2 15  
 pocket timetable 204 42; 205  
 45  
 pocket torch 127 26  
 pocket train schedule 204 42;  
 205 45  
 pod 57 6; 61 20, 23; 69 8, 16;  
 370 92, 93; 378 33; 384 46  
 pod, immature ~ 374 22  
 pod, mature ~ 383 4  
 pod, pouch-shaped ~ 61 11  
 pod, ripe ~ 383 4  
 pod, unripe ~ 374 22  
 pod corn 68 31  
 poet's daffodil 60 4  
 poet's narcissus 60 4  
 point *Game* 88 10, 31  
 point *Mach. Parts etc.* 143 23,  
 54  
 point *Sculpt. Studio* 339 15  
 point *Maths.* 346 1-23  
 point, angular ~ 346 1  
 point, diamond ~ 24 40  
 point, equinoctial ~ 3 6, 7  
 point, front ~ 300 49  
 point, typographic ~ 175 18  
 pointer *Hosp.* 26 28  
 pointer *Dog* 70 40, 43  
 pointer *Photog.* 114 58  
 pointer *Inf. Tech.* 242 76  
 pointer *Chem.* 349 34  
 point guard 300 50  
 pointing 122 55  
 pointing sill 121 47  
 point lace 102 30  
 point light exposure lamp 179  
 21  
 point lock 202 28  
 point-of-aim mark 305 56  
 point of Aries 3 6  
 point of arrow 305 61  
 point of contact 346 49  
 point of hook 89 80  
 point of inflexion 347 21  
 point of intersection 346 1  
 point of release 89 34  
 point paper design 171 4, 27  
 points, equinoctial ~ 3 6-7  
 points, manually-operated ~  
 202 16  
 points, remote-controlled ~  
 202 27  
 points, single ~ 203 45-48  
 points change indicator 197  
 39  
 point shoe 314 30  
 point size 175 46  
 points knob 203 62  
 points lever 203 55  
 points mechanism, electric ~  
 197 43  
 points mechanism,  
 electrohydraulic ~ 197 43  
 points mechanism,  
 electromechanical ~ 197  
 43  
 points motor 202 35  
 points of sailing 285 1-13  
 points of the horse 72 1-38  
 point source lamp 182 4

points signal 197 38; 202 19  
 points signal, electrically  
 illuminated ~ 202 33  
 points signal lamp 202 19  
 points signals 203 45-52  
 point wire 202 30  
 poison gland 77 14  
 poison sac 77 13  
 poitrel 329 85  
 poke bonnet 306 23; 355 71  
 poker 38 41; 137 5  
 polar bear 368 11  
 Polaris 3 1, 34  
 polarizer 112 14  
 polarizing filter 112 19  
 polar sledge 303 18  
 polar wind zone 9 51  
 pole *Fruit & Veg. Gdn.* 52 28  
 pole *Horse* 71 21  
 pole *Fish Farm.* 89 30  
 pole *Mills* 91 32  
 pole *Carriages* 186 19, 30  
 pole *Rivers* 216 16  
 pole *Athletics* 298 28  
 pole, bamboo ~ 307 46  
 pole, celestial ~ 3 1; 4 24, 26  
 pole, geographical ~ 14 3  
 pole, hooked ~ 77 55  
 pole, terrestrial ~ 14 3  
 pole chain 71 20  
 pole horse 186 47  
 pole mast 258 42; 259 6  
 Pole Star 3 1, 34  
 pole vault 298 28-36  
 pole vaulter 298 29  
 poleyn 329 53  
 polihode 4 28  
 police 264  
 police badge 264 27  
 police dog 70 25; 264 5, 6  
 police duties 264 1-33  
 police helicopter 264 1  
 police identification disc 264  
 26  
 police launch 221 100  
 policeman 264 18, 34  
 police officer 264 18  
 police patrolman 264 13  
 police signalling disc 264 14  
 police van 264 38  
 policewoman 264 37  
 polishing 109 17  
 polishing and burnishing  
 machine 108 42  
 polishing bonnet, lamb's wool  
 ~ 134 21  
 polishing brush 100 11  
 polishing iron 108 51  
 polishing machine  
 attachment 109 15  
 polishing wheel 108 44  
 polish rod 145 27  
 political section 342 51  
 Politzer bag 22 37  
 polje 13 72  
 pollen 77 3, 35; 370 65  
 pollen basket 77 6  
 pollen comb 77 7  
 pollen sac 372 45, 50  
 pollen tube 370 66  
 pollex 19 64

polling booth 263 23  
 polling card 263 19  
 polling number 263 19  
 polling place 263 16  
 polling station 263 16  
 polo jumper, striped ~ 30 20  
 polo neck jumper 30 7  
 polo outsole 101 24  
 polo saddle, high-back ~ 188  
 13  
 polyamide 170 34, 35, 37, 41  
 polyamide chip, dry ~ 170 39  
 polyamide cone 170 51, 52  
 polyamide fibres 170 1-62  
 polyamide filament 170 43  
 polyamide staple 170 61, 62  
 polyamide thread 170 46  
 polyanthus narcissus 60 4  
 Polychaetes 369 15  
 polyester resin 130 17  
 polygon 346 40  
 polygon, eight-sided ~ 351 17  
 polygon, five-sided ~ 351 9  
 polygon, regular ~ 346 41  
 polygon, six-sided ~ 351 15  
 polyhedron 260 73  
 polyhedron, eight-faced ~  
 351 6  
 polyhedron, forty-eight-  
 faced ~ 351 13  
 polyhedron, four-faced ~ 351  
 1  
 polyhedron, regular ~ 351  
 11  
 polyhedron, six-faced ~ 351 2  
 polyhedron, twenty-faced ~  
 351 11  
 polyhedron, twenty-four-  
 faced ~ 351 12  
 polymerization 170 33, 54  
 polyp, hydroid ~ 369 9  
 polypod 377 16  
 polypody 377 16  
 pome 370 102  
 pomegranate 384 16  
 Pomeranian 70 20  
 pomes 58  
 pommel 296 6  
 pommel horn 71 38  
 pommel horse 296 5  
 pommer 322 14  
 pompier 270 43  
 pompier ladder 270 16  
 pompon 29 4  
 pompon dahlia 60 23  
 poncho 352 24  
 pond *Map* 15 79  
 pond *Park* 272 50  
 pons 17 46  
 pons cerebelli 17 46  
 pons cerebri 17 46  
 pontic, porcelain ~ 24 29  
 pontoon 226 57  
 pontoon, bottom ~ 222 38  
 pontoon bridge 15 46  
 pontoon dock 222 34-43; 225  
 16  
 pony 75 4  
 ponytail 34 27  
 poodle 70 36  
 pool, indoor ~ 281 1-9

pool, non-swimmers' ~ 282  
 21  
 pool, swimmers' ~ 282 23  
 pool attendant 281 4; 282 15  
 pool billiards 277 7  
 poolroom 277 7-19  
 poop 223 33; 258 22  
 poor man's weatherglass 61  
 27  
 popcorn 68 31  
 poplar 371 15  
 poppy 51 30; 61 2  
 poppy flower 61 4  
 poppy seed 61 5  
 porcelain manufacture 161  
 porcelain painter 161 17  
 porcupine 366 13  
 porifer 357 13  
 pork 95 38-54  
 pork, collared ~ 96 9  
 porridge oats 98 37  
 port *Ship* 220 27  
 port *Docks* 225; 226  
 port administration offices  
 225 36  
 portal 331 16  
 portal, main ~ 333 34  
 portal, recessed ~ 335 24  
 portal figure 333 36  
 portal frame 215 38  
 portal relief 333 35  
 portal spotlight 316 21  
 potato 321 29  
 portcullis 329 24  
 port custom house 225 6  
 port de bras à côté 314 7  
 port de bras en avant 314 9  
 port de bras en bas 314 8  
 port de bras en haut 314 10  
 porter *Brew.* 93 26  
 porter *Station* 205 31; 206 33  
 porter *Hotel* 267 17  
 porthole 117 64  
 porthole, ornamental ~ 218  
 57  
 port hospital 225 26  
 portico 334 50, 56  
 port liner 190 73  
 port of registry 286 8  
 ports de bras 314 7-10  
 posaune stop 326 17-22  
 position 224 45  
 position indicator 246 18  
 position light 257 36; 288 31  
 position light, left ~ 230 50  
 position light, right ~ 230 44  
 positions 314 1-6  
 positions, arm ~ 314 7-10  
 positive 322 56  
 post *Dent.* 24 34  
 post *Wine Grow.* 78 7  
 post *Forestry* 84 17; 85 30, 47  
 post *Mills* 91 34  
 post *Carp.* 120 25  
 post *Roof* 121 40, 81  
 post *Paperm.* 173 50  
 post *Ball Games* 291 37  
 post, broker's ~ 251 3  
 post, principal ~ 120 53  
 postage meter 22 24; 236 7  
 postage stamp 236 61



postal code 236 43  
 postal collection 236 50-55  
 postal delivery 236 50-55  
 postbox 236 50  
 post code 236 43  
 post crown 24 31  
 poster 98 2; 204 10; 268 71; 271 25  
 posthorn 186 41  
 post horse 186 43  
 postman 236 53  
 postmark, special ~ 236 59  
 postmark advertisement 236 56  
 postmarks 236 56-60  
 post office 236; 237; 268 68  
 post office box 236 13, 14  
 post office savings counter 236 25  
 post office van 236 52  
 post-synchronization 311 37-41  
 post-syncing 311 37-41  
 post-sync sound 117 101  
 post windmill 91 31  
 pot *Kitch.* 39 29  
 pot *Kitch. Utensils* 40 12  
 pot *Plant Propagn.* 54 8  
 pot, baby's ~ 28 47  
 pot, centrifugal ~ 169 17  
 potash salt bed 154 65  
 potash salt seam 154 65  
 potato 68 38, 40  
 potato, flat-oval ~ 68 38  
 potato, Irish ~ 68 38  
 potato, kidney-shaped ~ 68 38  
 potato, long ~ 68 38  
 potato, pear-shaped ~ 68 38  
 potato, purple ~ 68 38  
 potato, red ~ 68 38  
 potato, round ~ 68 38  
 potato, round-oval ~ 68 38  
 potato, white ~ 68 38  
 potato, yellow ~ 68 38  
 potato apple 68 43  
 potato basket 66 25  
 potato beetle 80 52  
 potato berry 68 43  
 potato chipper 40 43  
 potato crisp 45 41  
 potato dish 45 31  
 potato fork 66 5  
 potato harvester 64 59-84  
 potato haulm 68 41  
 potato hoe 66 24  
 potato hook 66 6  
 potato plant 68 38  
 potato planter 66 21  
 potato rake 66 20  
 potato server 45 75  
 potato top 68 41  
 potato tuber 68 40  
 potential transformer 153 59  
 pot-helm 254 7  
 pot-helmet 254 7  
 pot holder 39 18  
 pot holder rack 39 19  
 pot plant 39 37; 44 25; 55 25  
 potsherd 161 21  
 potter's wheel 161 11  
 pottery 308 66  
 pottery, chip-carved ~ 328 35  
 pottery stand 308 64-66  
 potting bench 55 12  
 potting table 55 12  
 potty 28 47  
 pouch, gular ~ 359 8  
 poulaine 355 42  
 poulard 98 7; 99 58  
 poultry 73 19-36  
 poultry farming 74 1-27  
 poultry keeping 74  
 poultry management, intensive ~ 74 1-27  
 pounce bag 129 49  
 pouncing 129 48  
 pound, lower ~ 217 29  
 pound, upper ~ 217 37  
 pound lock gate 217 31  
 pound sterling 252 37  
 pouring end 147 34  
 pouring floor, sinking ~ 148 24  
 pouring ladle lip 147 43  
 powder, black ~ 87 53  
 powder, smokeless ~ 87 53  
 powder box 43 28; 49 35  
 powder charge 87 57  
 powder flag 253 38  
 power 345 1  
 powerboat racing 286 21-44  
 powerboats 286 1-5  
 power control 100 22  
 power hacksaw 138 23  
 power hammer 137 9  
 power house *Hydr. Eng.* 217 21  
 power house *Shipbuild.* 222 33  
 power house *Films* 310 8  
 power lift 65 24-29  
 power line 127 23  
 powerpack unit 114 66  
 power plant *Coal* 144 13  
 power plant *Power Plant* 152; 153  
 power plant *Glass Prod.* 162  
 power regulator 100 22  
 power saw *Forestry* 84 22, 27; 85 13  
 power saw *Blacksm.* 138 23  
 power screwdriver 195 23  
 power shovel 200 1  
 power source 110 7  
 power station *Coal* 144 13  
 power station *Offshore Drill.* 146 1  
 power station *Power Plant* 152; 153  
 power station *Glass Prod.* 162  
 power station *Hydr. Eng.* 217 64  
 power supply *Arc Weld.* 142 25  
 power supply *Energy Sources* 155 21  
 power supply, external 115 79  
 power take-off 63 21; 64 49  
 power take-off clutch 65 40  
 power take-off gear 65 38

power take-off gear-change 65 23, 40  
 power take-off shaft 63 21; 64 49  
 power transformer 152 30, 39  
 power unit 84 34  
 power zooming arrangement 117 19  
 prairie horse 352 4  
 pralltriller 321 19  
 pram *Infant Care etc.* 28 34  
 pram *Docks* 226 57  
 pram *Park* 272 71  
 pram *Playground* 273 31  
 pram, wicker ~ 28 30; 48 24  
 pram jacket 29 3  
 pram suit 29 1  
 prayer book 330 62  
 prayer tower 337 13  
 prayer wheel 353 29  
 preacher 330 22  
 precession 4 24  
 precipitation 8 18  
 precipitation, scattered ~ 8 19  
 precipitation, types of ~ 8 18-19  
 precipitation area 9 30  
 precipitation gauge 10 44  
 precipitator, electrostatic ~ *Power Plant* 152 13  
 precipitator, electrostatic ~ *Coking* 156 20  
 precipitator, electrostatic ~ *Cement Wks.* 160 7  
 precipitator, electrostatic ~ *Papern.* 172 39  
 precision balance 108 35  
 precision bench lathe 109 20  
 precision file 140 8  
 precision lathe 138 20  
 predator, small ~ 86 19, 20, 22  
 pre-distributor channel 236 36  
 pre-drying 165 50  
 preheater 212 41  
 preheater, high-pressure ~ 152 26  
 preheater, low-pressure ~ 152 25  
 preheater pressure gauge 210 43  
 preheater unit 185 30  
 prehistory 328  
 prelims 185 43-47  
 pre-listening button 238 46  
 pre-listening speaker 238 50  
 premasher 92 42  
 premixer 97 58  
 pre-mixing room 238 54-59  
 premolar 19 18  
 préparation 314 23  
 preparation and sterilization room 26 34-54  
 preparation level 64 16  
 preparation of surfaces 128 1-17  
 preparation room 26 34-54  
 prepuce 20 70  
 presbytery 330 32  
 prescription 22 3, 20  
 present-day man 261 21

preserve 98 51  
 preserving jar 40 25  
 preset control 316 2  
 presorter 172 21  
 presorting 64 82  
 press *Joiner* 133 51  
 press *Ball Games* 293 32  
 press, first ~ 173 19  
 press, rotary ~ *Text. Finish.* 168 38  
 press, rotary ~ *Letterpress* 181 57  
 press, second ~ 173 20  
 press, web-fed ~ 181 57  
 press-and-blow process 162 30  
 press attachment 100 15  
 press bar 100 17  
 press bed 180 78; 181 17  
 press bowl, heated ~ 168 41  
 press camera 114 36  
 presser 103 19  
 'press facilities' 233 43  
 press finishing 168 38  
 pressing *Glass Prod.* 162 33  
 pressing *Papern.* 173 50  
 pressing cloth 104 32  
 pressing cushion 104 28  
 pressing mechanism 184 13  
 pressing pad 104 28  
 pressman 340 35  
 press mould 162 34  
 press photo 342 58  
 press photographer 299 49  
 press roll 173 37  
 press roller 64 64  
 pressure, atmospheric ~ 9 4  
 pressure, barometric ~ 9 4  
 pressure adjustment 249 53  
 pressure adjustment, calibrated ~ 185 5  
 pressure bulkhead 231 32  
 pressure bulkhead, forward ~ 235 19  
 pressure chamber 83 44  
 pressure cloth 116 59  
 pressure cooker *Kitch. Utensils* 40 21  
 pressure cooker *Camping* 278 35  
 pressure cylinder 133 46  
 pressure foot 133 47  
 pressure fuelling point 257 33  
 pressure gas 156 28  
 pressure gauge *Hosp.* 25 53; 26 29  
 pressure gauge *Overh. Irrign.* 67 10  
 pressure gauge *Pest Contr.* 83 42  
 pressure gauge *Blacksm.* 138 15  
 pressure gauge *Electrotyp. etc.* 178 8  
 pressure gauge *Offset Print.* 180 74  
 pressure gauge *Garage* 195 29  
 pressure gauge *Serv. Stat.* 196 20  
 pressure gauge *Railw.* 211 24  
 pressure gauge *Theatre* 316 56

pressure graph 27 31  
 pressure hull 258 66; 259 55, 76  
 pressure indicator 25 55  
 pressure line 235 54, 57  
 pressure pipe *Market Gdn.* 55 8  
 pressure pipe *Hydr. Eng.* 217 50  
 pressure pipe *Theatre* 316 54  
 pressure pipeline 217 41  
 pressure piston 133 52  
 pressure plate 115 24  
 pressure point 21 14  
 pressure pot 129 31  
 pressure pump, hydraulic ~ 178 11  
 pressure-reducing valve 141 5  
 pressure regulator *Gas Weld.* 141 5  
 pressure regulator *Graphic Art* 340 38  
 pressure release valve 155 7  
 pressure tank 316 55  
 pressure trace 25 57  
 pressure transducer 27 32  
 pressure valve 40 22  
 pressure weight 168 2  
 pressurized gas delivery system 234 60  
 pressurized-water reactor 154 19  
 pressurized-water system 154 40  
 presto 321 28  
 pretzel *Bakery* 97 44  
 pretzel *Supermkt.* 99 16  
 preventer 270 15  
 preview monitor 238 60  
 price *Equest.* 289 37  
 price *Script.* 342 41  
 price card 271 19  
 price display 196 6  
 price label 96 6  
 price list *Butch.* 96 19  
 price list *Grocer* 98 73  
 price list *Bank* 250 8  
 price offered 289 37  
 pricket 330 52  
 pricking off 54 5  
 pricking out 54 5  
 priest 330 39; 331 47  
 prima ballerina 314 27  
 primary 153 15  
 primary school 260 1-85  
 primary voltage bushing 152 43  
 primary voltage terminal 152 43  
 primates 368 12-16  
 prime focus cage 5 2  
 Prime meridian 14 5  
 primer 128 6  
 prime steam line 154 31  
 priming brush 338 9  
 primitive man 261 19  
 princess, German ~ 355 20  
 principal 345 7  
 principal diapason 326 31-33  
 print delivery 249 43

print drier, heated ~ 116 57  
 print drier, rapid ~ 116 57  
 printer *Garage* 195 6  
 printer *Office* 245 32  
 printer, rotating ~ 111 27  
 printery 340 27-64  
 printing, rotary ~ 178 21  
 printing cylinder 177 67  
 printing-down frame 179 13  
 printing element 178 39  
 printing image carrier 340 59  
 printing office 340 27-64  
 printing paper 180 47  
 printing paper, photographic ~ 116 51  
 printing plate 178 38  
 printing speed adjustment 249 55  
 printing surface 340 59  
 printing unit 180 41, 80  
 printing unit, first ~ 181 48  
 printing unit, lower ~ 180 7, 9, 11, 13  
 printing unit, reversible ~ 182 26  
 printing unit, second ~ 181 52  
 printing unit, upper ~ 180 6, 8, 10, 12  
 print-out machine 195 6  
 print quantity selection 249 35  
 print tongs 116 47  
 prism, hexagonal ~ 351 21  
 prism, monoclinic ~ 351 24  
 prism, quadratic ~ 347 34  
 prism, triangular ~ 347 37  
 private detective 275 16  
 privet 373 6  
 privet hawkmoth 358 55  
 prize 306 11; 308 48  
 probe *Dent.* 24 46  
 probe *Photog.* 114 63; 116 55  
 probe, bulb-headed ~ 22 53; 26 40  
 probe, hollow ~ 26 41  
 probe, olive-pointed ~ 22 53; 26 40  
 probe exposure meter 114 61  
 probe lead 116 38  
 proboscidean 366 20  
 proboscidian 366 20  
 proboscis *Articulatus* 358 17, 56  
 proboscis *Mammals* 366 21  
 procaviid 366 24  
 process and reproduction camera, universal ~ 177 24  
 process camera, overhead ~ 177 1  
 process camera, vertical ~ 177 32  
 process control computer 236 37  
 processing drum 116 48  
 processing laboratory 310 2; 311 30  
 processing machine 179 31  
 processing plant 144 5  
 processing unit, central ~ 176 29



procession, religious ~ 331 42-50  
 processional moth 82 14  
 processor, automatic ~ 116 60  
 processor, central ~ 244 6  
 proclamation 263 14  
 proctoscope 23 17, 19, 21  
 proctoscopy 23 18  
 Procyon 3 15  
 produce, agricultural ~ 68 1-47  
 producer 316 40  
 product 344 25  
 production control room 238 17  
 production line 173 13-28  
 production manager 310 26  
 production oil and gas separator 146 9  
 product register 309 82  
 profile 118 69  
 profile, basic ~ 229 45  
 profiling tool 161 14  
 profit 345 7  
 program *see* programme  
 program card 195 5, 10  
 program input 177 71  
 programme 315 13  
 programme, computer-controlled ~ 238 2  
 programme, educational ~ 261 7  
 programme dial 243 40  
 programmed individual presentation system 242 15  
 programmer 248 15  
 programme recorder 261 42  
 programme scale 243 40  
 programme selector 243 39  
 program selector control 50 26  
 program selector switch 25 50  
 progress counter 242 5  
 projectile 255 26  
 projection *Films* 311 45  
 projection *Art* 335 43  
 projection, conical ~ 14 8  
 projection, cylindrical ~ 14 9  
 projection booth 5 27; 312 12  
 projection dome 5 21  
 projectionist 312 20  
 projection lamp 312 18  
 projection lens 261 10; 312 35  
 projection room 312 12  
 projection room window 312 15  
 projection screen *Optic. Instr.* 112 24  
 projection screen *Broadcast.* 238 32  
 projection screen *School* 260 36  
 projection screen *Films* 310 16; 312 11  
 projection table 261 13  
 projection window 312 15  
 projector 5 23; 316 17  
 projector, lefthand ~ 312 13  
 projector, overhead ~ 242 6  
 projector, righthand ~ 312 14

projector attachment 112 55  
 projector gate 312 34  
 projector lens 312 35  
 projector mechanism 312 25-38  
 projector switch 195 20  
 projector top 261 9  
 promenade 223 27  
 promenade deck 223 22-27  
 prominence, laryngeal ~ 19 13  
 prominence, solar ~ 4 40  
 prompt book 316 41  
 prompt box 316 27  
 prompter 316 28  
 prompt script 316 41  
 prone position *Free Exerc.* 295 45  
 prone position *Sports* 305 29  
 prong *Tablew. etc.* 45 60  
 prong *Agr. Impl.* 66 4  
 proof 340 43  
 proofing press 180 75  
 proof press 180 75  
 prop *Household* 50 37  
 prop *Circus* 307 13  
 prop *Theatre* 315 50  
 prop, front ~ 303 8  
 prop, rear ~ 303 9  
 propagation 54 10, 14, 27  
 propagation of plants 54  
 propane gas 278 33  
 propane gas bottle 278 34  
 propeller *Brew.* 92 46  
 propeller *Energy Sources* 155 45  
 propeller *Life-Sav.* 228 26  
 propeller *Aircraft* 230 32  
 propeller *Motorboats etc.* 286 64  
 propeller *Airsports* 288 36  
 propeller, feathering ~ 224 19  
 propeller, reversible ~ 224 19  
 propeller, ship's ~ 221 44; 222 72; 223 62  
 propeller, three-blade ~ 223 62  
 propeller, variable-pitch ~ 224 19  
 propeller bracket 223 61  
 propeller guard 258 40  
 propeller guard boss 258 63  
 propeller guard moulding 258 74  
 propeller mixer 79 6  
 propeller pitch indicator 224 20  
 propeller post 222 71  
 propeller pump 217 47-52  
 propeller shaft *Car* 192 30, 65  
 propeller shaft *Ship* 223 65  
 propeller shaft *Aircraft* 232 60  
 propeller shaft *Warships* 259 59  
 propeller strut 223 61  
 propeller-turbine engine 256 16  
 propeller-turbine plane 231 4  
 propelling nozzle 232 39, 45, 49, 55

property 315 50  
 proportion, simple ~ 345 8-10  
 proportional dividers 339 2  
 proprietor 248 29; 266 71  
 prop stand 187 34; 188 51  
 propulsion nozzle 232 39, 45, 49, 55  
 propylaea 334 7  
 proscenium 315 15; 334 46  
 proscenium, adjustable ~ 316 22  
 prostate 20 76  
 protection device 255 81, 90  
 prothorax 82 4; 358 29  
 proton 1 2, 16, 31  
 protoplasm 357 3  
 protoprism 351 19, 20  
 protopyramid 351 19, 20  
 prototype 290 38  
 protozoans 357 1-12  
 protractor 260 38  
 protrusion, massive ~ 11 29  
 protuberance, frontal ~ 16 4  
 pruner 56 11  
 pruning knife 56 9  
 pruning saw 56 16  
 pruning shears 56 50  
 prussic acid 83 15  
 pseudocarp 58 21; 384 12, 62  
 pseudopod 357 4  
 psychrometer 10 52  
 pubis 17 20  
 public conveniences 268 62  
 publicity calendar 22 10  
 puck 302 35  
 pudding fender 227 17  
 pudenda 16 39  
 puffball 381 19  
 puff paste 97 18  
 puff pastry 97 18  
 pug 70 9; 123 69  
 pug dog 70 9  
 pull 340 43  
 pull-down table 207 53  
 pullet 74 9  
 pullet fold unit 74 5  
 pulley *Cotton Spin.* 164 48  
 pulley *Bicycle* 187 9  
 pulley, glass ~ 169 16  
 pulley cradle 214 36, 53  
 pulley cradle, main ~ 214 67  
 pullover, heavy ~ 33 52  
 pullover, men's ~ 33 51  
 pullover, short-sleeved ~ 33 32  
 pull rod *Mach. Parts etc.* 143 101  
 pull rod *Railw.* 202 20  
 pull-switch 127 16  
 pull-through 87 64  
 pull-up phase 298 29  
 pulmonary function test 27 36  
 pulp 58 24, 35, 58; 59 6  
 pulp, chemical ~ 172 77, 78  
 pulp, dental ~ 19 32  
 pulp, mechanical ~ 172 77, 78  
 pulp-drying machine 172 61  
 pulper 172 80  
 pulpit 330 19; 337 15  
 pulpit balustrade 330 23  
 pulpit steps 330 18

pulp machine 172 61  
 pulpstone 172 71  
 pulp water pump 172 55, 63  
 pulsator 75 32  
 pulse cable 117 72  
 pulse-generating camera 117 71  
 pulse generator 313 30  
 pulse generator socket 117 7  
 pulse rate 23 27  
 pulse shape 23 37  
 pump *Agr. Mach.* 65 45  
 pump *Shoes* 101 29  
 pump *Oil, Petr.* 145 22  
 pump *Synth. Fibres* 170 31  
 pump, centrifugal ~ *Wine Cell.* 79 7  
 pump, centrifugal ~ *Rivers* 216 60  
 pump, centrifugal ~ *Water* 269 44  
 pump, centrifugal ~ *Fire Brig.* 270 8  
 pump, direct-connected ~ 83 41  
 pump, hydraulic ~ *Agr. Mach.* 64 29, 91  
 pump, hydraulic ~ *Theatre* 316 53  
 pump, main ~ 269 15  
 pump, motor-driven ~ 83 41  
 pump, portable ~ 270 52  
 pump, power take-off-driven ~ 67 14, 15  
 pump compass 151 59  
 pump compression spring 174 41  
 pump connection 67 8  
 pumpernickel 97 49  
 pumping plant 217 39-46  
 pumping rod 145 25  
 pumping station *Offshore Drill.* 146 22  
 pumping station *Hydr. Eng.* 217 43  
 pumping station *Shipbuild.* 222 33  
 pumping station *Spa* 274 4  
 pumping unit 145 22  
 pumpkin 57 23  
 pump pressure spring 174 41  
 pump room *Brew.* 92 11  
 pump room *Spa* 274 8, 15  
 pumps 2 52  
 pump shaft 199 19  
 pump strainer 269 6, 14, 43  
 punch *Shoem.* 100 45, 46  
 punch *Goldsm. etc.* 108 19, 30, 31  
 punch *Office* 247 3  
 punch *Sculpt. Studio* 339 15  
 punch, foul ~ 299 34  
 punch, hollow ~ 125 13  
 punch, illegal ~ 299 34  
 punch, revolving ~ 100 44  
 punch, rotary ~ 100 44  
 punch, round ~ 137 36; 140 65  
 punch, steel ~ 175 36  
 punch, straight ~ 299 28  
 punch bag 299 21

punch ball 299 24  
 punch ball, spring-supported ~ 299 20  
 punch ball, suspended ~ 299 23  
 punch blank 175 35  
 punch card 237 64  
 punch card reader 244 12  
 punch cutter 175 32  
 punched card 237 64  
 punched card reader 244 12  
 punched tape 176 6, 8, 12; 237 62, 68  
 punched tape input 176 30  
 punched tape reader 176 13, 15  
 punching bag 299 21  
 punch tape 176 6, 8, 12; 237 62, 68  
 punch tape input 176 30  
 punch tape reader 176 13, 15  
 punctuation marks 342 16-29  
 punt 216 15; 283 1  
 punt pole 89 30; 216 16  
 pup 73 16  
 pupa 77 30, 32; 80 4, 25, 43; 81 21, 24; 82 13, 21, 32; 358 20; 365 11  
 pupa, coarctate ~ 81 3  
 pupil *Man* 19 43  
 pupil *School* 260 3, 20  
 puppy 73 16  
 pure culture plant 93 6  
 purfling 323 26  
 purge valve 6 25  
 purified water tank 269 13  
 purlin 119 55; 121 39, 51, 76  
 purlin, concrete ~ 119 4  
 purlin, inferior ~ 119 3; 121 44; 122 40  
 purlin roof 121 46  
 purlin roof structure 121 52, 60  
 purple clover 69 1  
 purple medick 69 9  
 purse wig 34 4  
 push button 203 67; 237 18, 19; 241 3  
 push-button keyboard 237 10; 245 14; 246 14  
 push-button telephone 237 20  
 pushchair 28 37  
 pushchair, doll's ~ 48 31  
 pusher ram 156 7  
 pushing frame 200 30  
 push sledge 304 29  
 push tow 225 60  
 push tug 221 93  
 putlock 118 27  
 putlog 118 27  
 putter 293 93  
 putting green 293 82  
 putty 124 17  
 putty knife 124 27; 129 24  
 puzzle 48 9  
 pyelogram 27 6  
 pyelogram cassettes 27 14  
 pyelography 27 4  
 pygmy poodle 70 36

pyjamas 32 17, 36  
 pyjama top 32 18  
 pyjama trousers 32 19  
 pylon *Railw.* 214 31, 77  
 pylon *Art* 333 9  
 pylon, tubular steel ~ 214 78  
 pylorus 20 42  
 pyramid *Fruit & Veg. Gdn.* 52 16  
 pyramid *Circus* 307 28  
 pyramid *Art* 333 1  
 pyramid, glass ~ 5 19  
 pyramid, orthorhombic ~ 351 23  
 pyramid, quadrilateral ~ 347 46  
 pyramid, stepped ~ 333 22; 352 20  
 pyramid site 333 6  
 pyramid tree 52 16; 272 19  
 pyrheliometer 10 23  
 pyrite 351 8  
 pyrometer 178 16  
 pyx 330 8; 332 53  
 pyxidium 370 95

**Q**

quack grass 61 30  
 quadrant 347 5  
 quadraphonic system 241 13-48  
 quadra/stereo converter 241 46  
 quadrilateral, irregular ~ 346 39  
 quadrilaterals 346 33-39  
 quadruplet 321 23  
 quail 359 22  
 quail call 87 45  
 quake, tectonic ~ 11 32-38  
 quake, volcanic ~ 11 32-38  
 quantity, unknown ~ 345 4, 8  
 quant pole 89 30; 216 16  
 quantum jump 1 15  
 quantum jumps 1 20-25  
 quantum transitions 1 20-25  
 quarantine wing 225 27  
 quarrier 158 5  
 quarry *Map* 15 87  
 quarry *Quarry* 158 1  
 quarryman 158 5  
 quarry worker 158 5  
 quarte engagement 294 47  
 quarter *Shoem.* 100 61  
 quarter *Carp.* 120 25  
 quarter, first ~ 4 4  
 quarter, last ~ 4 6  
 quarter, third ~ 4 6  
 quarter baulk 120 90  
 quarter gallery 218 57  
 quarterings 254 18-23  
 quartering wind 285 13  
 quarter light 191 23  
 quarter note 320 15  
 quarter of beef 94 22  
 quarter piece 329 88  
 quarter rest 320 23  
 quarters, firemen's ~ 270 2  
 quarter vent 191 23



quarter wind 285 13  
 quartz 110 15  
 quartz-halogen lamp 179 21;  
 182 3  
 quartz watch, electronic ~ 110  
 14  
 quatrefoil 335 39  
 quaver 320 16  
 quaver rest 320 24  
 quay 222 5; 225 64  
 quayside crane 225 24  
 quayside railway 225 21  
 quayside road 225 38  
 quayside roadway 225 38  
 quayside steps 283 22  
 quay wall 217 1-14  
 queen *Bees* 77 4, 38  
 queen *Games* 276 9  
 queen bee 77 4  
 Queen Carnival 306 61  
 queen cell 77 37  
 queen-excluder 77 47  
 queen post 121 46, 52, 68  
 queen truss 121 65  
 Queen Victoria water lily 378  
 17  
 quenching car 156 10  
 quenching tower 156 11  
 quenching trough 137 8  
 question mark 342 20  
 queue 34 6; 319 26  
 quickbeam 371 42  
 quick grass 61 30  
 quick hitch 65 86  
 quicksand 227 3  
 quid 107 19  
 quill 341 26  
 quillions 294 42  
 quill pen 341 26  
 quill plectrum 322 53  
 quilting 29 39; 30 17  
 quilt stitching 29 39; 30 17  
 quince, apple-shaped ~ 58 49  
 quince, pear-shaped ~ 58 50  
 quince leaf 58 47  
 quince tree 58 46  
 quinquefoliate 370 39  
 quintuplet 321 23  
 quipa 352 22  
 quitch grass 61 30  
 quiver 352 27  
 quoin 181 39  
 quoit 280 32; 308 47  
 quoits 280 31  
 quotation 250 8  
 quotation board 251 8  
 quotation mark, double ~ 342  
 26  
 quotation mark, French ~ 342  
 27  
 quotient 344 26

## R

rabbit plane 132 25  
 rabbit 73 18; 86 23; 88 65  
 rabbit burrow 86 26  
 rabbit fence 84 7  
 rabbit hole 86 26  
 rabbit net 86 27

raccoon 368 9  
 race, inner ~ 143 72  
 race, outer ~ 143 71  
 race board 166 42  
 racehorse 289 51  
 raceme 58 15; 374 33  
 raceme, simple ~ 370 68  
 raceway 91 44  
 racing 289 50  
 racing, motor-paced ~ 290  
 11-15  
 racing and passenger aircraft  
 230 1-31, 32-66; 231 1  
 racing bicycle 290 16  
 racing boats 283 9-16  
 racing car 290 38  
 racing cars 290 34-38  
 racing cycle 290 15, 16  
 racing cyclist 290 8  
 racing dive 282 29  
 racing flag 284 48  
 racing handlebar 290 18  
 racing jersey 290 9  
 racing keelboat 285 35  
 racing motorcycle 290 27  
 racing motorcycle,  
 streamlined ~ 290 31  
 racing motorcyclist 290 25  
 racing outboard motor 286 23  
 racing saddle 290 17  
 racing sculler 283 16  
 racing shell, eight-oared ~  
 283 10  
 racing suit 301 31  
 racing toe clip 290 21  
 racing tyre 290 19  
 rack *Kitch. Utensils* 40 31  
 rack *Composing Rm.* 174 8  
 rack *Garage* 195 10  
 rack *Railw.* 214 9, 11  
 rack, removable ~ 40 24  
 rack and pinion 112 39  
 rack-and-pinion railway 214  
 4-5  
 rack-and-pinion railways  
 214 7-11  
 racket 293 29  
 racket handle 293 30, 46  
 racket press 293 32  
 rack for glasses 274 16  
 rack head 163 16, 18  
 racking back 118 61  
 rack mountain railway 214  
 4-5  
 rack railroad 214 4-5  
 rack railroad car 214 5  
 rack railroad locomotive,  
 electric ~ 214 4  
 rack railway coach 214 5  
 rack railway locomotive,  
 electric ~ 214 4  
 rack railways 214 7-11  
 rack railway trailer 214 5  
 rack track 217 69  
 racoon 368 9  
 racquet *see* racket  
 radar antenna 223 8; 224 104;  
 258 36; 259 8, 29, 48, 91  
 radar apparatus 224 10-13  
 radar display unit 224 12  
 radar dome *Aircraft* 231 18

radar dome *Air Force* 256 10  
 radar dome *Warships* 258 52,  
 77; 259 49  
 radar equipment 224 10-13  
 radar image 224 13  
 radar nose 231 18; 256 10  
 radar pedestal 224 10  
 radar picture 224 13  
 radar reflector 10 58  
 radar reflector, revolving ~  
 224 11  
 radar scanner 223 8; 224 104;  
 258 36; 259 8, 29, 48, 91  
 radar screen 224 12  
 radial side of the hand 19 69  
 radiant energy 10 23  
 radiation, solar ~ 155 18  
 radiation detectors 2 1-23  
 radiation meters 2 1-23  
 radiation monitor 2 1  
 radiation shield 2 31, 46  
 radiation shielding 2 31  
 radiation unit 24 23  
 radiator *Doc.* 23 23  
 radiator *Roof & Boilerr.* 38  
 76  
 radiator *Agr. Mach.* 65 51  
 radiator *Plumb. etc.* 126 20  
 radiator *Energy Sources* 155  
 15  
 radiator *Car* 191 9  
 radiator *Railw.* 212 54  
 radiator bonnet 304 11  
 radiator brush 129 21  
 radiator grill 191 11  
 radiator heating 155 27  
 radiator hood 304 11  
 radiator rib 38 77; 126 21  
 radiators 6 8  
 radiator shutter 304 12  
 radical 345 2  
 radicle 370 88  
 radio 238; 239  
 radioactive waste storage 154  
 56  
 radio antenna 197 34  
 radio cassette recorder 241 1  
 radio communication set 197  
 28  
 radio compass 230 5  
 radio direction finder  
 antenna 223 5; 224 106  
 radio direction finder frame  
 258 17  
 radio equipment 197 28; 230  
 22; 288 13, 17  
 radiographer 27 11  
 radiolarian 357 8  
 radio link, intercontinental ~  
 237 54-55  
 radiometer 10 71  
 radio navigation equipment  
 230 22  
 radio OB van 239 1-15  
 radiophone 22 14  
 radio room 223 12  
 radioscope box 74 47  
 radioscope table 74 48  
 radiosonde 10 59  
 radiosonde assembly 10 55  
 radio station 238 1-6

radio switching centre  
 control room 238 7-15  
 radio system 6 26  
 radio telephone 212 23  
 radish 57 15  
 radish, white ~ 57 16  
 radius *Man* 17 13  
 radius *Mills* 91 2  
 radius *Maths.* 346 47  
 radius of curvature 346 22  
 radome *Aircraft* 231 18  
 radome *Air Force* 256 10  
 radome *Warships* 258 52, 77;  
 259 49  
 raffia 136 29  
 raffle 306 11  
 raft 283 60  
 rafter 121 28, 36; 122 19  
 rafter, common ~ 121 56  
 rafter, principal ~ 121 55  
 rafter end 121 45; 122 41  
 rafter head 121 45; 122 41  
 rafter roof 121 27  
 rag bolt 143 43  
 rag felt 122 62  
 ragged robin 376 21  
 rail *Atom* 2 37  
 rail *Livestock* 75 16  
 rail *Joiner* 133 41  
 rail *Mach. Tools* 150 12  
 rail *Railw.* 202 1  
 rail *Station* 205 59; 206 38  
 rail *Railw.* 214 10  
 rail *Restaurant* 266 72  
 rail *Equest.* 289 2  
 rail *Birds* 359 20  
 rail, triangular ~ 242 80  
 rail bottom 202 4  
 rail brake 206 48  
 railcar 205 25  
 railcar, articulated ~ 197 1,  
 13  
 railcar, front ~ 211 61  
 railcar, light ~ 208 13  
 railcar, short-distance ~ 208  
 13  
 railcar, six-axle ~ 197 13  
 railcar, twelve-axle ~ 197 1  
 rail clip 202 9  
 rail foot 202 4  
 rail guard 210 34  
 rail head 202 2  
 railing *Bldg. Site* 118 89  
 railing *Park* 272 34  
 rail joint 202 11  
 railroad *see* railway  
 railroad map 204 33  
 railroad policeman 205 20  
 railroad station 15 41  
 railroad ticket 204 36  
 railroad track 202; 203  
 rail service, interurban ~ 197  
 1  
 rail service, urban ~ 197 13  
 railway, funicular ~ 214 12  
 railway, light ~ 200 23  
 railway, main line ~ 15 21  
 railway, narrow-gauge ~ *Map*  
 15 90  
 railway, narrow-gauge ~  
*Road Constr.* 200 23

railway guide, official ~ 204  
 50  
 railway information clerk 204  
 49  
 railway line 202; 203  
 railway map 204 33  
 railway policeman 205 20  
 railway siding 225 62  
 railway station 15 41  
 railway ticket 204 36  
 railway vehicles 207; 208;  
 209; 210; 211; 212; 213  
 rail web 202 3  
 rain 8 18; 9 32  
 rainbow 7 4  
 rainbow, colours of the ~ 343  
 14  
 rainbow dressing 221 85  
 rain cape 41 4; 196 26  
 rain cloud 8 10  
 raincoat 29 31  
 rain cover 10 41  
 rain gauge 10 38, 44  
 rainwater pipe 37 13; 38 10;  
 122 29  
 rain zone, temperate ~ 9 55  
 rain zone, tropical ~ 9 53  
 raisin 98 8  
 raising of livestock 75  
 raising to a power 345 1  
 rake *Roof & Boilerr.* 38 42  
 rake *Gdn. Tools* 56 4  
 rake *Blacksm.* 137 4  
 rake *Roulette* 275 5  
 rake *Winter Sp.* 303 24  
 rake, wire-tooth ~ 51 3; 56 3  
 rake, wooden ~ 66 23  
 raking back 118 61  
 Ram *Astron.* 4 53  
 ram *Dom. Anim.* 73 13  
 ram *Blacksm.* 137 10  
 ram *Forging* 139 12  
 ram *Ship* 218 9  
 ram *Theatre* 316 60  
 ram, lower ~ 139 7  
 ram, upper ~ 139 6  
 rambler 52 5  
 ram guide 139 8  
 ram longwall face 144 36  
 rammer 200 26  
 rammer, pneumatic ~ 148 31  
 ramp *Bldg. Site* 119 41  
 ramp *Floor etc. Constr.* 123 30  
 ramp *Station* 206 1  
 ramp *Ship* 221 55  
 ram piston 65 24  
 ramson 377 6  
 randing 136 1, 4  
 randing, oblique ~ 136 3  
 rangefinder 255 82  
 rangefinder, optical ~ 258 37  
 rangefinder window 114 40  
 range light, higher ~ 224 102  
 range light, lower ~ 224 101  
 range lights 224 101-102  
 range selector 114 59  
 range switch 114 59  
 rape 383 1  
 rapelling 300 28-30  
 rapid adjustment compass  
 151 64

rapid feeding system 74 23  
 rapid-filter plant 269 9  
 rapid heat-up cathode 240 25  
 rapid-loading system 115 25  
 rapid scale 98 12  
 rapid-veneer press 133 49  
 rapping iron 136 36  
 raptorial leg 358 5  
 Raschel fabric 167 29  
 rasp 260 55  
 rasp, shoemaker's ~ 100 49  
 raspberry 58 28; 370 101  
 raspberry bush 58 25  
 raspberry flower 58 26  
 ratan chair cane 136 32  
 rate-of-climb indicator 230  
 14  
 rate of interest 345 7  
 rattan chair cane 136 32  
 rattle *Infant Care etc.* 28 44  
 rattle *Carnival* 306 40, 47  
 rattle, baby's ~ 28 44  
 rat trap binding 301 15  
 Rautek grip 21 18  
 ravine 13 52  
 raw coal bunker 144 41  
 raw material *Cement Wks.*  
 160 1, 4  
 raw material *Synth. Fibres*  
 169 1-12  
 raw material store 160 3  
 raw meal silo 160 5  
 raw milk pump 76 3  
 raw milk storage tank 76 5  
 raw mill 160 4, 7  
 ray *Church* 332 37  
 ray *Maths.* 346 20  
 ray, medullary ~ 370 11  
 ray, vascular ~ 370 11  
 rays, sun's ~ 4 9  
 razor, open ~ 106 38  
 razor, straight ~ 106 38  
 razor handle 106 39  
 R-class 284 59  
 reach, lower ~ 217 29  
 reach, upper ~ 217 37  
 reaching leg 285 24  
 reactor 154 3, 41, 50  
 reactor, nuclear ~ 1 48; 154  
 19  
 reactor building 154 20  
 reactor core 259 68  
 reactor pressure vessel 154 22  
 reader 260 16  
 reading adjustment 10 10  
 reading lamp 43 15  
 reading microscope 113 28  
 reading room 262 13  
 reading room staff 262 14  
 readout, digital ~ 110 2; 112  
 47  
 readout, fast ~ 195 12  
 ready position 305 72  
 reamer 109 8; 140 31  
 reamer, angled ~ 125 9  
 rear brace 329 47  
 rearing of livestock 75  
 rear of the railcar 197 4  
 rear seat headrest 193 8  
 rear seat head restraint 193 8  
 rearsight 255 22, 36



rear vault 297 32  
 rear-view mirror 188 35; 189 30  
 rear-view mirror, inside ~ 191 39  
 rearward horizontal stand 295 31  
 rearward swing 296 57  
 rear window heating switch 191 82  
 rebate plane 132 25  
 receipt 98 44; 271 7  
 receipt stamp 236 29  
 receiver *Meteorol. Instr.* 10 63  
 receiver *Hunt.* 87 16  
 receiver *Docks* 226 33  
 receiver *Audio* 241 40  
 receiver *Office* 246 16  
 receiver *Ball Games* 293 50  
 receiver *Nightclub* 318 18  
 receiver cord 237 14  
 receiver surface, blackened ~ 155 29  
 receiving hopper 147 5  
 receiving table 249 54  
 receiving tray 249 47  
 receiving truck 226 15  
 receptacle 370 53  
 reception *Doc.* 22 5  
 reception *Camping* 278 1  
 reception hall 267 1-26  
 receptionist, chief ~ 267 7  
 recess 217 70  
 reciprocal 344 16  
 recirculation pump 154 43, 54  
 record 46 15; 309 32; 317 24  
 record changer, automatic ~ 241 52  
 recorder *Meteorol. Instr.* 10 61  
 recorder *Hosp.* 25 3  
 recorder *Music. Instr.* 322 7  
 recorder, eight-channel ~ 27 28  
 recorder, open-reel-type ~ 241 56  
 recorder, potentiometric ~ 23 55  
 recording, photographic ~ 27 33  
 recording amplifier 311 11  
 recording and playback deck, single ~ 238 58  
 recording and playback equipment 311 23  
 recording arm 10 7, 12, 15, 21  
 recording channel, central ~ 238 1-6  
 recording drum 10 5, 16, 20  
 recording engineer 310 23, 55; 311 36  
 recording head *Cine Film* 117 33  
 recording head *Audio* 241 59  
 recording head *Films* 311 25  
 recording instrument 10 61  
 recording level control 117 16  
 recording level display 243 15  
 recording level indicator 243 12; 311 14  
 recording level meter 241 35, 36, 61; 242 14  
 recording level meters 241 35-36  
 recording loudspeaker 238 37  
 recording mechanism 10 42  
 recording meter 138 19  
 recording paper 25 4; 27 29, 34, 40  
 recording pen 10 13  
 recording rain gauge 10 38  
 recording room 238 16; 310 54  
 recording room mixing console 238 25  
 recording sensitivity selector 117 16  
 recording space 177 49  
 recording speaker 238 37  
 recording tape 241 58  
 record keeper 299 48  
 record of posting book 236 18  
 record player 241 18; 317 19  
 record player base 241 19  
 record player housing 241 19  
 record rack 309 36  
 record storage compartment 241 48  
 record storage slot 241 48  
 record turntable 238 24  
 recovery parachute 235 60  
 recovery vehicle, armoured ~ 255 93  
 rectangle 346 34  
 rectifier *Blacksm.* 138 30  
 rectifier *Electrotyp. etc.* 178 2  
 rectifier *Films* 312 18  
 rector 330 22  
 rectory 331 20  
 rectoscope 23 16, 17  
 rectoscopy 23 18  
 rectum 20 22, 61  
 rectus abdominis 18 44  
 red 343 1  
 red admiral 365 1  
 red-billed toucan 363 6  
 redbreast 361 15  
 redcap 205 31  
 red card 291 63  
 red clover 69 1  
 red deer 88 1, 1-27  
 red flyer 366 3  
 red fox 88 42; 367 12  
 red kangaroo 366 3  
 red magnolia 373 15  
 redstart 360 3  
 red swing filter 116 46  
 reducing coupler 126 39, 41  
 reducing elbow 126 49  
 reducing socket 126 39, 41  
 reducing valve 141 5  
 reduction drive lever 149 3  
 reduction gear *Paperm.* 172 69  
 reduction gear *Aircraft* 232 59  
 reduction gear *Warships* 259 61  
 reduction gearing, multi-step ~ 64 71  
 red underwing 365 8  
 red whortleberry 377 23

red wine glass 45 83  
 reed *Basketm.* 136 28  
 reed *Weaving* 166 10  
 reed *Music. Instr.* 326 41  
 reed, double ~ 323 29  
 reed mace 136 27  
 reed mace bulrush 378 21  
 reed organ 325 43  
 reed pen 341 22  
 reed pipe, metal ~ 326 17-22  
 reed stop 326 17-22  
 reed-threading draft 171 6  
 reef 219 72  
 reefer 221 127  
 reel, fixed-spool ~ 89 32, 61  
 reel, multiplying ~ 89 59  
 reel, spring-tine ~ 64 4  
 reel, stationary-drum ~ 89 61  
 reel arm, foldaway ~ 117 92  
 reel drum 312 16  
 reel drum, fireproof ~ 312 25  
 reel gearing 64 5  
 reeling machine 173 41  
 reel of film 312 33  
 reel oven 97 71  
 reels 89 59-64  
 reel stand 180 3, 19  
 referee 291 62; 293 67; 299 16, 41  
 referee's position 299 8  
 reference book 262 17  
 reference library 262 17  
 refill 151 46  
 refill lead 151 46  
 refiner 172 84  
 refiner, conical ~ 172 27, 60, 73, 83  
 refining bath 162 4  
 reflected-light microscope 112 23  
 reflecting goniometer 351 28  
 reflector *Atom* 1 65  
 reflector *Optic. Instr.* 113 1  
 reflector *Bicycle* 187 45  
 reflector, glass ~ 187 86  
 reflector, swivel-mounted ~ 114 69  
 reflector pedal 187 78  
 reflex angle 346 10, 11-12  
 reflex camera, twin-lens ~ 114 22  
 reflex finder 117 44  
 reflex mirror 115 33  
 reflex system 115 31  
 reformer 145 47  
 reformer, catalytic ~ 145 71  
 refractometer 111 44  
 refractometer, dipping ~ 112 48  
 refractor 113 16  
 refreshment kiosk 205 49  
 refreshment stall 308 3  
 refrigeration system 93 11  
 refrigerator 39 2; 46 33; 317 10  
 refrigerator car 213 39  
 refrigerator shelf 39 3  
 refrigerator van 213 39  
 refrigerator wagon 213 39  
 refuse 199 17  
 refuse, compacted and decomposed ~ 199 22  
 refuse collection vehicle 199 1  
 refuse container 199 4  
 refuse disposal 199  
 refuse incineration unit 199 28  
 regatta 283 1-18  
 regatta course 285 14-24, 16  
 register *School* 260 23  
 register *Hotel* 267 8  
 register *Music. Instr.* 322 51  
 register device 177 12  
 register mark 340 58  
 registration form 267 12  
 registration number *Election* 263 19  
 registration number *Motorboats etc.* 286 7  
 reglet 334 57  
 regula 334 17  
 regular crystal system 351 1-17  
 regular customer 266 40  
 regular grade gasoline 145 54  
 regular grade petrol 145 54  
 regulating handle 133 14  
 regulating valve 38 75  
 regulator 109 32  
 regulator main valve 210 13  
 regulator valve 210 13  
 Regulidae 361 10  
 rehearsal 315 21-27  
 reheating 162 27, 35  
 reichstaler 252 6  
 rein 71 33; 186 31; 289 27; 303 4  
 reindeer 353 16  
 reindeer harness 353 15  
 reinforced concrete construction 119 1-89  
 reinforcement 119 54-76, 68  
 reinforcement, projecting ~ 119 10, 71  
 reinforcement, steel-bar ~ 123 37  
 reinforcement beading 125 8  
 reinforcement binding 119 66  
 reinforcement rod 119 23  
 reinforcing member, longitudinal ~ 230 47, 57  
 reinforcing rib *Road Constr.* 200 9  
 reinforcing rib *Hydr. Eng.* 217 78  
 reinforcing steel 119 23  
 reinforcing strut 315 31  
 reins 71 25, 33  
 rejects chest 172 59  
 relay 186 43  
 relay horse 186 43  
 release *First Aid* 21 34  
 release *Weaving* 165 35  
 release, delayed-action ~ 309 51  
 release binding 301 2  
 release grip 21 34  
 release lever *Slaughterho.* 94 6  
 release lever *Office* 247 42  
 release/lock lever 247 42

release phase 75 33  
 release valve 210 58  
 relief image carrier 340 2  
 relief printing method 340 1-13  
 relief tile, glazed ~ 333 20  
 remainder 344 24  
 remains 15 72  
 Remington cartridge 305 39  
 remittance 250 19  
 remnant 103 16  
 remote control jack 117 9  
 remote control panel 157 14  
 remote control radio 288 87  
 remote control socket 117 9  
 rendering, exterior ~ 122 38  
 rendering coat 123 6  
 'rendezvous point' 233 29  
 rendezvous radar antenna 6 42  
 reniform 370 38  
 rennet vat 76 48  
 repair bay 196 22  
 repairer 161 19  
 repair quay 222 10  
 repair shop 196 22  
 repeater 87 2  
 repeaters 253 30-32  
 repeating rifle 87 2  
 repeat mark 321 26  
 replenishing ship 258 97  
 report 342 54  
 reproducing head 241 59  
 reptile enclosure 356 12  
 reptiles 364 27-41  
 requin 364 1  
 re-recording 311 1-46  
 re-reeler 173 41  
 re-reeling machine 173 41  
 rescue 21 18-23, 28-33, 34-38  
 rescue cruiser 221 18; 228 14  
 rescue helicopter 221 20; 228 16  
 rescuer 21 29, 34  
 research laboratory 310 9  
 research microscope 112 1, 66  
 research microscope, binocular ~ 23 51  
 research rocket 7 24  
 reserve fuel tank 212 60  
 reserve tank 232 20  
 reservoir *Hydr. Eng.* 217 39-46  
 reservoir *Air Force* 257 16  
 reservoir, impounded ~ 217 57  
 reservoir rock 12 29  
 reset button *Cine Film* 117 86  
 reset button *Car* 191 77  
 resetting button 127 20  
 resetting spring 237 49  
 residential area 15 28  
 residue 145 43  
 resin 323 11  
 resin, synthetic ~ 130 26  
 resistor 153 56  
 resonating body 322 29; 323 3; 324 2, 15, 26  
 resonating chamber 322 18; 324 15, 63  
 resonating sound box 324 26  
 resonator 322 18, 29; 324 2, 15  
 resonator, tubular metal ~ 324 78  
 resonator wall 322 33  
 respiration, artificial ~ 21 24-27  
 respirator 21 27; 26 25  
 respiratory apparatus 21 27; 26 24  
 respiratory functions 23 31  
 respiratory machine 26 1  
 respiratory rate 23 27  
 respond 335 35  
 'restaurant' *Airport* 233 50  
 restaurant 266 1-29  
 restaurant car 207 22-32  
 restaurant car, self-service ~ 207 73  
 rest cure 274 12-14  
 resting rail 322 42  
 restoring spring 237 49  
 restricted area 292 37  
 rests 320 20-27  
 result register 309 82  
 results of sets 293 35  
 resuscitation 21 24-27  
 resuscitation, mouth-to-mouth ~ 21 26  
 resuscitation, mouth-to-nose ~ 21 26  
 resuscitation apparatus 21 27  
 resuscitation equipment 270 20  
 resuscitator 21 27; 270 20  
 retailer 98 41  
 retail shop 98 1-87  
 retail store 98 1-87  
 retaining plate 167 56  
 retarder 206 48  
 reticella lace 102 30  
 reticule 115 61  
 Reticulum 3 48  
 retina 19 49  
 retort 349 13  
 retort ring 350 15  
 retoucher 182 14  
 retouching and stripping desk 177 19  
 retrieving 86 36  
 retrofocus position 115 84  
 return 38 79  
 return pipe 38 56, 79, 80; 126 24  
 return spring *Knitting* 167 37  
 return spring *Car* 192 55  
 return tap 350 49  
 Reuther board 296 12; 297 8  
 rev counter 189 41; 191 38; 212 22; 230 8  
 rev counter, electric ~ 191 70  
 rev counter, electronic ~ 188 40  
 reveal 37 26; 118 10; 120 31  
 revenue stamp 107 26  
 revers collar 30 9  
 reverse 252 9  
 reverse dive 282 41  
 reverse gear 192 44  
 reverse hang 296 34  
 reverse shaft 149 34  
 reversing catch 87 24



reversing clutch 115 27  
 reversing gear 210 18; 211 53; 212 74  
 reversing gears 65 41  
 reversing ring 115 83  
 reversing wheel 210 56  
 revertive signal panel 153 7  
 revetment 216 51-55  
 revolution counter 189 41; 191 38; 212 22; 230 8  
 revolution counter, electric ~ 191 70  
 revolution counter, electronic ~ 188 40  
 revolving die hammer 85 12  
 reward 86 43  
 rewind 114 6; 115 12  
 rewind bench 238 59; 312 21  
 rewind button 249 73  
 rewind cam 115 29  
 rewind crank 114 6; 115 12  
 rewinder *Cine Film* 117 93  
 rewinder *Paperm.* 173 41  
 rewind handle *Photog.* 114 6; 115 12  
 rewind handle *Cine Film* 117 93  
 rewinding 170 50  
 rewind release button 115 27  
 rewind station 173 41  
 rhesus macaque 368 12  
 rhesus monkey 368 12  
 rhinoceros 366 25  
 Rhipitoglossa 364 33  
 rhizome 58 18  
 rhizopod 357 1  
 rhomb 346 35  
 rhombic crystal system 351 23  
 rhombohedron 351 22  
 rhomboid 346 36  
 rhombus 346 35  
 rhubarb flan 97 22  
 rhyngophore 358 4  
 rib *Meat* 95 3  
 rib *Floor etc. Constr.* 123 36  
 rib *Basketm.* 136 24  
 rib *Shipbuild.* 222 58  
 rib *Aircraft* 230 46  
 rib *Rowing* 283 49  
 rib *Sailing* 285 51  
 rib *Music. Instr.* 322 33; 323 4, 25  
 rib *Art* 335 31  
 rib *Bot.* 370 29  
 rib, annular ~ 235 47  
 rib, false ~ 287 36  
 rib, flat ~ 95 21  
 rib, fore ~ 95 18  
 rib, main ~ *Space* 235 10  
 rib, main ~ *Gliding* 287 35  
 rib, middle ~ 95 19  
 rib, prime ~ 95 18  
 rib, top ~ 95 31  
 ribbon 34 7; 355 78  
 ribbon, corded ~ 35 13  
 ribbon, fancy ~ 35 14  
 ribbon cassette 249 16  
 ribbon of glass 162 10  
 ribbon selector 249 11  
 ribbon window 37 86  
 Ribes 58 1-15

ribgrass 380 11  
 rib randing 136 2  
 ribs, false ~ 17 10  
 ribs, true ~ 17 9  
 rib vault 336 43  
 rib weave, combined ~ 171 19  
 ribwort 380 11  
 ribwort plantain 380 11  
 rice *Arable Crops* 68 1; 68 29  
 rice *Grocer* 98 38  
 rice grain 68 30  
 rickshaw 353 34  
 rickshaw coolie 353 35  
 rickstand 63 28, 29  
 riddle 55 13  
 ride *Map* 15 112  
 ride *Forestry* 84 1  
 rider *Cyc. Racing* 290 25  
 rider *Chem.* 349 33  
 rider bar 349 31  
 rider holder 349 32  
 ridge *Phys. Geog.* 12 36; 13 60  
 ridge *Dwellings* 37 7  
 ridge *Roof* 121 2; 122 93  
 ridge *Mountain.* 300 21  
 ridge, concave ~ 302 22  
 ridge, hollow ~ 302 22  
 ridge beam 121 48  
 ridge board 121 48  
 ridge capping piece 122 99  
 ridge course 122 47, 79  
 ridge course tile 122 4  
 ridge cross 331 10  
 ridge hook 122 65  
 ridge joint 122 79  
 ridge purlin 121 43  
 ridge rope 221 118  
 ridge tent 278 21; 280 45  
 ridge tile 122 3, 8, 52  
 ridge turret 121 14  
 ridge vent 55 11  
 ridging hoe 56 5  
 riding animal 354 2  
 riding cap 289 14  
 riding seat 296 32  
 riding switch 289 22  
 riffer 172 2; 173 13  
 rifle, self-loading ~ 255 16  
 rifle, short ~ 86 30  
 rifle, single-loading ~ 87 1  
 rifle, triple-barrelled ~ 87 23  
 rifle barrel 87 26  
 rifle butt 255 24  
 rifle cleaning kit 87 61-64  
 rifle grip *Photog.* 115 100  
 rifle grip *Films* 313 37  
 riflescope 87 29; 305 49  
 rifle shooting 305 26  
 rifling 87 36  
 rifling calibre 87 37  
 rig 219 1-72  
 Rigel 3 13  
 rigging 219 1-72  
 rigging, running ~ 219 67-71  
 rigging, standing ~ 219 10-19  
 right 254 18, 20, 22  
 right angle 346 9, 32  
 right corner pin 305 8  
 right front second pin 305 4  
 right hook 299 33  
 right tank fuel gauge 230 17

rim *Bicycle* 187 28  
 rim *Motorcycle* 189 25  
 rim *Car* 191 16; 192 77  
 rim brake 187 5  
 rimfire cartridge 305 35  
 rind 120 86; 370 8  
 ring *Jewell.* 36 4  
 ring *Forestry* 85 4  
 ring *Fish Farm.* 89 56  
 ring *Cotton Spin.* 164 51, 54  
 ring *Sports* 299 35  
 ring *Circus* 307 21  
 ring *Bullfight. etc.* 319 9  
 ring *Church* 332 17  
 ring *Maths.* 346 57  
 ring *Chem.* 350 15  
 ring, all-round ~ 89 58  
 ring, annual ~ 84 24  
 ring, asymmetrical ~ 36 27  
 ring, diamond ~ 36 23, 24  
 ring, front ~ 113 7  
 ring, gemstone ~ 36 15  
 ring, man's ~ 36 20  
 ring, rubber ~ *Kitch. Utensils* 40 26  
 ring, rubber ~ *Bathing* 280 32  
 ring, spring-steel ~ 89 51  
 ring and bead sight, optical ~ 305 51  
 ring attendant 307 27  
 ring cake 97 33; 99 22  
 ringed snake 364 38  
 ring entrance 307 11  
 ring fence 307 22  
 ring file 260 15  
 ring finger 19 67  
 ring frame 164 34  
 ring gauge 108 25, 27  
 ring gemstones 36 72-77  
 ringmaster 307 31  
 ring net 90 25  
 ring plectrum 324 27  
 ring rail 164 42, 54  
 ring-rounding tool 108 26  
 rings 296 4  
 ring sight, optical ~ 305 50  
 ring snake 364 38  
 ring spindle, standard ~ 164 45  
 ring spinning frame 164 34  
 ring tube *Cotton Spin.* 164 52  
 ring tube *Weaving* 165 15  
 riot duty 264 15  
 riot gear 264 18  
 riot shield 264 20  
 rip panel 288 75, 83  
 rip panel, emergency ~ 288 72  
 ripper 200 20  
 ripping line 288 76  
 ripping line, emergency ~ 288 73  
 ripple marks 13 41  
 riprap 216 51  
 rise adjustment 133 21  
 rise adjustment wheel 133 22  
 rise and fall adjustment wheel 132 60  
 riser *Floor etc. Constr.* 123 33, 48  
 riser *Iron Foundry etc.* 148 22  
 riser *Water* 269 19

riser *Fire Brig.* 270 26  
 riser *Airsports* 288 42  
 riser *Sports* 305 55  
 riser gate 148 22  
 riser pipe 269 19  
 rise to straddle 296 49  
 rising 283 31  
 Rising Sun 253 20  
 ritual cart, miniature ~ 328 36  
 ritual chariot, miniature ~ 328 36  
 river *Phys. Geog.* 13 61  
 river *Map* 15 76  
 river *Rivers* 216 31  
 river, navigable ~ 15 45  
 river, subterranean ~ 13 83  
 river arm 13 2; 216 3  
 river arm, blind ~ 216 18  
 riverbank 216 5  
 riverbed 13 68  
 river bend 13 11  
 river branch 13 2; 216 3  
 river branch, blind ~ 216 18  
 river engineering 216  
 river ferry 216 10  
 river island 216 4  
 river islet 216 4  
 river mouth 13 1  
 river nymph 272 2; 327 23  
 river police 217 24  
 rivers 216  
 river terrace 13 49, 63  
 river tug 216 23  
 river valley 13 57-70  
 rivet 143 57-60  
 rivet head 143 57  
 riveting 143 56  
 riveting machine 138 27  
 rivet shank 143 58  
 riving hammer 85 5  
 rivulet *Phys. Geog.* 13 8  
 rivulet *Map* 15 80  
 road 37 61  
 road, bituminous ~ 200 55  
 road, good ~ 15 30  
 road, main ~ 15 83  
 road, metalled ~ 15 30  
 road, poor ~ 15 99  
 road, secondary ~ 15 36  
 road, unmetalled ~ 15 99  
 road bridge 15 55  
 road building 200; 201  
 road-building machinery 200 1-54  
 road coach 186 39  
 road construction 200; 201  
 road form 201 15  
 road layers 198 1-5  
 road making 200; 201  
 road-metal spreading machine 200 31  
 road over railway 15 22  
 road race 290 8-10  
 road race bicycle 290 16  
 road racer 290 8  
 road racing 290 16, 24-28  
 road ripper 200 20  
 road roller 200 36  
 roadster *Bicycle* 187 1  
 roadster *Car* 193 26  
 road surface 215 8; 217 1

road sweeper 199 5; 268 20  
 road-sweeping lorry 199 41  
 roadway, orthotropic ~ 215 2  
 road wheel 255 86  
 roast 45 27  
 roasting chicken 98 6  
 roasting drum 98 71  
 roasting round 95 11  
 robe de chambre 355 66  
 robes 330 22; 332 4  
 robin 361 15  
 robin redbreast 361 15  
 robot 273 36  
 rocaille 336 13  
 rock 13 25; 327 38; 356 2  
 rock, blasted ~ 158 4  
 rock, coal-bearing ~ 144 49  
 rock, impermeable ~ 12 23; 13 78  
 rock, impervious ~ 12 23; 13 78  
 rock, loose ~ 158 4  
 rock, piece of ~ 6 15  
 rock, sedimentary ~ 12 1; 13 48  
 rock, stratified ~ 13 48  
 rock bit 145 21  
 rock climbing 300 2-13  
 rocker *Child. Rm.* 47 16  
 rocker *Winter Sp.* 302 19  
 rocker *Music. Instr.* 326 39  
 rocker *Graphic Art* 340 19  
 rocker arm 190 33  
 rocker arm mounting 190 34  
 rocker switch 127 4  
 rockery 37 40; 51 6  
 rocket *Life-Sav.* 228 2  
 rocket *Army* 255 26, 65  
 rocket *Carnival* 306 54  
 rocket, short-range ~ 259 26  
 rocket apparatus 228 1  
 rocket cruiser 259 21, 41  
 rocket engine 6 3  
 rocket engine, liquid-fuelled ~ 235 36  
 rocket engine, main ~ 235 36  
 rocket gun 228 1  
 rocket launcher 255 64, 70  
 rocket launcher, underwater ~ 259 37, 51  
 rocket line 228 3  
 rocket stage, first ~ 234 3  
 rocket stage, second ~ 234 18  
 rocket stage, third ~ 234 33  
 rocket tube 255 71  
 rock face *Phys. Geog.* 12 43; 13 28  
 rock face *Quarry* 158 15  
 rock face *Mountain.* 300 2  
 rock garden 37 40; 51 6  
 rock goat 367 7  
 rocking chair 309 61  
 rocking tool 340 19  
 rock island 13 12  
 rock ledge 300 4  
 rock painting 328 9  
 rock plant 51 7  
 rock rose 377 20  
 rock salt 351 2  
 rockslide 11 46  
 rock slip 11 46

rock spike 300 9  
 rock terrace 13 47  
 rock tomb 333 38  
 rock wall 300 2  
 rod, carbon-fibre ~ 89 57  
 rod, glass ~ 89 49, 57  
 rod, iron ~ 130 3  
 rod, metal ~ 339 24  
 rod, polished ~ 145 27  
 rod, telescopic ~ 89 53  
 rodents 366 12-19  
 rodeo 319 34  
 rodeo rider 319 39  
 rod rest 89 23  
 rods 89 49-58  
 rod section 89 54  
 rod tip 89 35  
 roe *Game* 88 28-39  
 roe *Fish Farm.* 89 12  
 roe, female ~ 88 34  
 roebuck 86 17; 88 28  
 roe call 87 43  
 roe deer 88 28-39  
 roll *Kitch. Utensils* 40 31  
 roll *Tablew. etc.* 45 21  
 roll *Horse* 71 48  
 roll *Supermkt.* 99 12  
 roll *Athletics* 298 17  
 roll, brown ~ 97 13  
 roll, filled ~ 266 54  
 roll, lower ~ 148 55  
 roll, upper ~ 148 54  
 roll, white ~ 97 14  
 roll bar *Agr. Mach.* 65 21  
 roll bar *Motorcycles etc.* 188 18  
 roll bar *Car* 193 13  
 roll bearing 148 60  
 roll cutter 173 42  
 roller *Hairdresser* 105 12  
 roller *Cooper* 130 26  
 roller *Glass Prod.* 162 11  
 roller *Weaving* 165 57  
 roller *Road Constr.* 200 37  
 roller *Station* 206 39  
 roller *Hydr. Eng.* 217 65  
 roller *Office* 249 17  
 roller *Cyc. Racing* 290 13  
 roller *Graphic Art* 340 12  
 roller *Birds* 359 25; 360 6  
 roller, bottom ~ 164 10  
 roller, fluted ~ 164 10  
 roller, grooved ~ 130 30  
 roller, lambskin ~ 130 31  
 roller, leather ~ 340 23  
 roller, lower ~ *Iron Foundry etc.* 148 55  
 roller, lower ~ *Cotton Spin.* 164 10  
 roller, rubber ~ 182 8  
 roller, rubber-disc ~ 64 82  
 roller, steel ~ 164 10  
 roller, submersible ~ 217 68  
 roller, three-wheeled ~ 200 36  
 roller, top ~ 164 11  
 roller, upper ~ *Iron Foundry etc.* 148 54  
 roller, upper ~ *Cotton Spin.* 164 11  
 roller, wire-covered ~ 168 34



roller bearing 164 47  
 roller bit 145 21  
 roller chain *Bicycle* 187 36  
 roller chain *Intern. Combust. Eng.* 190 25  
 roller chain, double ~ 190 10  
 roller covering 50 3  
 roller guide 201 4  
 roller path 148 50  
 roller postmark 236 60  
 roller printing machine, ten-colour ~ 168 53  
 rollers 148 54-55  
 roller stamp 236 46  
 roller table 157 23  
 roller top 217 66  
 roller trestle 157 26  
 rollfilm 114 19  
 rollfilm spool 114 20  
 roll holder 40 1  
 rolling 230 71  
 rolling circle 288 3  
 rolling dam 217 65-72  
 rolling mill 148 46-75  
 rolling plant 159 9  
 rolling road 138 16  
 rolling shutter frame 37 29  
 rolling stock 207; 208; 209; 210; 211; 212; 213  
 roll-on roll-off operation 225 39  
 roll-on roll-off ship 226 17  
 roll-on roll-off system 225 39  
 roll-on roll-off trailer ferry 221 54  
 rollover device 139 43  
 rolls *Bakery* 97 13-16  
 rolls *Iron Foundry etc.* 148 54-55  
 roll stand 148 56-60  
 roll unit 97 61  
 roll-up door 245 5  
 Roman 355 11  
 Roman woman 355 7  
 romper 29 21  
 romper suit 29 22  
 roof 37 5; 38; 121; 122; 337 2  
 roof, cement ~ 122 97  
 roof, flat ~ 37 77  
 roof, glass ~ 55 5  
 roof, hipped ~ 37 64; 121 (1), 60  
 roof, imperial ~ 121 25  
 roof, mission-tiled ~ 122 56  
 roof, pantiled ~ 122 53  
 roof, paper ~ 122 90  
 roof, pitched ~ 38 12  
 roof, plain-tiled ~ 122 50  
 roof, sliding ~ 193 24; 194 10; 213 22  
 roof, snow-covered ~ 304 20  
 roof, Spanish-tiled ~ 122 56  
 roof, split-tiled ~ 122 45  
 roof, swivelling ~ 213 26, 27  
 roof, tiled ~ 122 1  
 roof beam 121 29  
 roof board 122 61  
 roof boarding 122 61  
 roof cable 211 5  
 roof cladding 38 1  
 roof course 122 78  
 roof covering 38 1  
 roofer 122  
 roof guard 38 8  
 roof hook 38 6  
 roofing, cement ~ 122 90-103  
 roofing, paper ~ 122 90-103  
 roofing felt 122 62  
 roofing nail 143 55  
 roofing paper 122 62  
 roof ladder 38 4; 122 63  
 roof lashing 278 51  
 roof opening 213 23  
 roof rack 278 50  
 roofs, styles and parts of ~ 121 1-26  
 roof sheathing 122 61  
 roof structures of timber 121 27-83  
 roof trestle 122 66  
 roof truss 120 7; 121 78  
 roof valley 121 15; 122 11, 82  
 roof ventilator 278 56  
 rook *Games* 276 12  
 rook *Birds* 361 2  
 room, double ~ 267 27-38  
 room, heated ~ 169 24  
 room divider 42 19  
 room key 267 9  
 room number 267 10  
 room telephone 267 34  
 room thermostat 38 78  
 room trader 251 6  
 room waiter 267 33  
 rooster 62 37; 73 21  
 root *Man* 19 36  
 root *Plant Propagn.* 54 21  
 root *Arable Crops* 68 17, 45  
 root *Horse* 72 34  
 root *Maths.* 347 12  
 root *Bot.* 370 16-18  
 root *Industr. Plants* 383 43  
 root, adventitious ~ 370 78, 80  
 root, aerial ~ 370 80  
 root, primary ~ 370 16  
 root, secondary ~ 370 17  
 root, tuberous ~ 370 79  
 root crops 68 38-45  
 rooster 200 20  
 root gall 80 27  
 root hair 68 18; 370 18  
 root louse 80 26  
 roots 54 12; 370 78-82  
 rootstock 54 33  
 root thorn 370 81  
 rope *First Aid* 21 30  
 rope *Weaving* 166 61  
 rope *Swim.* 282 32  
 rope *Gymn.* 296 19; 297 43  
 rope *Mountain.* 300 12, 22-27  
 roped party 300 22-27  
 rope ladder 221 91; 273 49; 307 8  
 rope-pulley hoist 118 91  
 ropes 299 36  
 rope sling 300 11  
 ropeway, aerial ~ 15 67  
 ropeway, double-cable ~ 214 25, 30  
 ropeway gondola 214 52  
 ropeways 214 15-38

ropeways, endless ~ 214 15-24  
 ropeways, single-cable ~ 214 15-24  
 ropeway support 214 76  
 roping down 300 28-30  
 ro-ro depot 226 20  
 ro-ro-ship 226 17  
 ro-ro system 225 39  
 ro-ro trailer ferry 221 54  
 rosary 332 30  
 rose *Market Gdn.* 55 28  
 rose *Game* 88 5, 29  
 rose *Music, Instr.* 324 5  
 rose, bush ~ 52 13  
 rose, climbing ~ 52 12  
 rose, double ~ 60 17  
 rose, ivory ~ 36 29  
 rose, rambling ~ 52 12  
 rose, standard ~ 51 25; 52 21  
 rosebay 373 13  
 rosebud 60 16  
 rose cut 36 45  
 rose-ear 70 2  
 rose hip 370 100  
 rose laurel 373 13  
 rose thorn 60 18  
 rose tree, standard ~ 52 13, 21  
 rosette 306 34  
 rostrum 263 6; 316 34  
 rotary engine, two-rotor ~ 190 5  
 rotary-table machine 150 41  
 rotary-table shot-blasting machine 148 39  
 rotary turbine pump 259 57  
 rotated grasp 296 44, 46  
 rotation 298 18  
 rotation axis 351 4  
 rotator 224 55  
 rotisserie 40 32  
 rotogravure press, multicolour ~ *Photograv.* 182 24  
 rotor *Clocks* 110 32  
 rotor *Intern. Combust. Eng.* 190 68  
 rotor *Aircraft* 232 22  
 rotor *Gliding* 287 18  
 rotor, main ~ 232 12-13; 256 19; 264 3  
 rotor, tail ~ 256 20  
 rotor, tilting ~ 232 32  
 rotor blade *Energy Sources* 155 45  
 rotor blade *Aircraft* 232 12  
 rotor head 232 13  
 rotor pylon 232 23  
 rouge 275 24  
 rough 293 80  
 rough focusing indicator 224 35  
 roughing file 134 9  
 roughing-out hammer 195 46  
 roughing wheel 111 36  
 roulette *Roulette* 275 1-33, 28  
 roulette *Graphic Art* 340 18  
 roulette ball 275 33  
 roulette bowl 275 29

roulette layout 275 9, 17  
 roulette player 275 15  
 roulette table 275 8  
 roulette wheel 275 10, 28  
 round 95 14  
 round, caseless ~ 305 37  
 roundabout 308 2  
 round bar reinforcement 119 80  
 round-bilge boat 286 32-34  
 round end 95 52  
 rounding machine *Bakery* 97 63  
 rounding machine *Plumb.* 125 30  
 roundwood 120 35; 157 30  
 round worm 81 31  
 route 203 68  
 route indicator 203 20, 21  
 route lever 203 58  
 route of the paper 180 26  
 route of the sheets 180 33  
 route of the web 180 26  
 router plane 132 26  
 route sign 197 21  
 route straight ahead 203 45, 49, 50  
 roving 164 29  
 roving bobbin 164 23  
 row 312 9  
 rowan 371 42  
 rowboats 283 9-15  
 rowing 283  
 rowing boat 89 27  
 rowing boat, Germanic ~ 218 1-6  
 rowing boats 283 9-15  
 rowing coach 283 20  
 rowlock 278 18; 283 29, 41  
 row of needles 167 27  
 row of needles, back ~ 167 46  
 row of needles, front ~ 167 47  
 row of seats, tiered ~ 261 1  
 royal 88 8  
 Royal Crown, English ~ 254 42  
 royal fern 377 16  
 royal osmund 377 16  
 royal stay 219 13  
 royal water lily 378 17  
 rubber, synthetic ~ 164 11  
 rubber belt, studded ~ 64 79  
 rubber plant 383 33  
 rubber solution 340 49  
 rubber tree 383 33  
 rubber tyre cable car 273 53  
 rubber tyre swing 273 18  
 rubbing strake, reinforced ~ 258 81  
 rubbish 268 22  
 rubble 11 47  
 rubble, rough ~ 269 37  
 ruby 175 22  
 ruby, synthetic ~ 110 33  
 Rückpositiv 326 5, 42  
 rucksack 283 65  
 rudder *Ship* 218 6, 24; 221 43  
 rudder *Shipbuild.* 222 69  
 rudder *Ship* 223 63  
 rudder *Life-Sav.* 228 26  
 rudder *Aircraft* 229 25; 230 60

rudder *Air Force* 257 23  
 rudder *Rowing* 283 51-53, 53  
 rudder *Sailing* 284 9, 34; 285 34  
 rudder *Motorboats etc.* 286 65  
 rudder *Airsports* 288 22  
 rudder, retractable ~ 285 37  
 rudder, vertical ~ 259 95, 96  
 rudder angle indicator 224 17  
 rudder blade 221 43; 222 69; 223 63; 283 53; 284 34  
 rudderhead 284 33  
 rudder pedal 230 27; 257 10  
 rudder pedal, co-pilot's ~ 230 28  
 rudder post 222 70  
 rudder stock 222 68; 284 33  
 ruff *Carnival* 306 20  
 ruff *Hist. Cost.* 355 52  
 rugby 292 19  
 rugby ball 292 21  
 rugby football 292 19  
 rule 151 33  
 rule, folding ~ 120 76; 134 33  
 rule, glazier's ~ 124 21  
 rule of three sum 345 8-10  
 rule pocket 33 49  
 ruler 151 33; 247 35  
 ruling pen 151 49  
 ruling pen attachment 151 58, 61  
 rum 98 57  
 ruminant 73 1  
 ruminants 366 28-30; 367 1-10  
 rummer 45 87  
 rump *Horse* 72 31  
 rump *Game* 88 20, 36  
 rump *Meat* 95 14, 35  
 rump piece 329 88  
 runch 61 18  
 rune 341 19  
 rung 38 17; 50 38  
 runner *Plant Propagn.* 54 14, 16  
 runner *Soft Fruit* 58 20  
 runner *Mills* 91 22  
 runner *Iron Foundry etc.* 148 21  
 runner *Rowing* 283 45  
 runner *Ball Games* 292 45, 66  
 runner *Athletics* 298 5  
 runner, movable ~ 303 10  
 runner, outrigger ~ 302 46  
 runner bean 52 28; 57 8  
 runner gate 148 21  
 running 298 1-8  
 running axle 210 35  
 running-boar target 305 33  
 running dog 334 39  
 running gear, front ~ 191 52  
 running head 185 66  
 running light 258 56  
 running light, side ~ 258 15  
 running light indicator panel 224 29  
 running posture 295 2  
 running side 277 5  
 running step 295 41  
 running step indicator 211 36

running take-off twist dive 282 43  
 running three 305 3, 5  
 running title 185 66  
 running track 298 6  
 running wheel 64 41, 56; 214 7, 70  
 runout 147 54  
 runway *Hunt.* 86 16  
 runway *Airport* 233 1  
 runway *Gliding* 287 15  
 rush *Phys. Geog.* 13 17  
 rush *Basketm.* 136 27  
 rusk 97 54  
 Russula vesca 381 23  
 rustication 335 51  
 rustic work 335 51  
 rutting mane 88 27  
 rutting season 86 9-12  
 rye 68 1, 2  
 rye bread 97 10, 49  
 rye-bread roll 97 16  
 rye flour 97 52  
 ryegrass, perennial ~ 69 26

## S

sabaton 329 55  
 saber *see* sabre  
 sable *Ladies' Wear* 30 60  
 sable *Heraldry* 254 26  
 sable *Mammals* 367 15  
 sabot 101 47  
 sabre, light ~ 294 20, 34  
 sabre fencer 294 19  
 sabre fencing 294 19-24  
 sabre gauntlet 294 21  
 sabre glove 294 21  
 sabre mask 294 22  
 sabreur 294 19  
 sack 38 34  
 sacker 92 39  
 Sacramento 331 48  
 sacarium 330 32  
 sacristan 330 26, 58  
 sacristy 331 13  
 sacristy door 330 17  
 sacrum 17 21; 20 59  
 saddle *Phys. Geog.* 12 16, 42  
 saddle *Mach. Tools* 149 13  
 saddle, adjustable ~ 188 4  
 saddle, English ~ 71 45-49  
 saddle, reciprocating ~ 185 24  
 saddle, unsprung ~ 290 17  
 saddle, western ~ 71 37-44  
 saddle apron 149 16  
 saddleback roof 37 5; 121 1  
 saddle bag 187 25  
 saddle clip 126 53  
 saddle-pad 71 17, 31  
 saddle roof 37 5; 121 1  
 saddles 71 37-49  
 saddle seat 71 37  
 saddle spring 187 23  
 saddle stitching 31 45  
 saddle tree 374 1  
 safe 246 22  
 safelight 116 21  
 safety bar 301 58  
 safety binding 301 2



safety bonnet 85 36  
 safety brake 85 15  
 safety catch *Atom* 2 40  
 safety catch *Household* 50 25  
 safety catch *Hunt* 87 8, 24  
 safety catch *Army* 255 14  
 safety catch, sliding ~ 87 25  
 safety chain 126 3  
 safety current 127 2  
 safety curtain 316 24  
 safety device 290 13  
 safety equipment 316 18  
 safety glass 124 5  
 safety glasses 140 21  
 safety helmet 84 23; 120 13;  
 140 22; 158 10; 300 53  
 safety helmet, shock-resisting ~ 127 48  
 safety hood 85 36  
 safety jet 301 53  
 safety key 140 48  
 safety latch 50 25  
 safety lighting 312 6  
 safety lock 140 44  
 safety net *Warships* 259 18  
 safety net *Circus* 307 14  
 safety nut 187 64  
 safety pin 328 27  
 safety rail 119 43  
 safety valve *Roof & Boilerr.*  
 38 70  
 safety valve *Railw.* 210 3  
 safety wall 122 35  
 saffron milk cap 381 29  
 sagger 161 2  
 sagger 161 2  
 Sagittarius 3 37; 4 61  
 sagittate 370 37  
 sago 98 39  
 sago palm 383 58  
 sail 219 1-72; 283 62; 284 2;  
 285 8  
 sail, ballooning ~ 285 4  
 sail, brailed-up ~ 218 21  
 sail, fore-and-aft ~ 220 15  
 sail, furled ~ 218 21  
 sail, square ~ 218 21, 33; 219  
 55-66; 220 16  
 sail axle 91 5  
 sailboat *Playground* 273 29  
 sailboat *Camping* 278 12  
 sailboat *Sailing* 284 10-48  
 sailboat, single-masted ~ 220  
 6-8  
 sailboats, mizzen-masted ~  
 220 9-10  
 sailboats, two-masted ~ 220  
 11-17  
 sailing 284; 285  
 sailing barge, ketch-rigged ~  
 220 9  
 sailing boat *Playground* 273  
 29  
 sailing boat *Camping* 278 12  
 sailing boat *Sailing* 284 10-48  
 sailing boat, single-masted ~  
 220 6-8  
 sailing boats, mizzen-masted  
 ~ 220 9-10  
 sailing boats, two-masted ~  
 220 11-17

sailing close-hauled 285 10  
 sailing downwind 285 1  
 sailing ship 219; 220  
 sailing ships, development of  
 ~ 220 35-37  
 sailing ships, four-masted ~  
 220 28-31  
 sailing vessels, three-masted  
 ~ 220 18-27  
 sailing with free wind 285 12  
 sailing with wind abeam 285  
 11  
 sailor suit 309 62  
 sailplane 287 3  
 sailplane, high-performance  
 ~ 287 9  
 sails, fore-and-aft ~ 219  
 20-31  
 sail shapes 220 1-5  
 sail top 91 6  
 sainfoin 69 10  
 saint, Buddhist ~ 337 10  
 Saint Andrew's cross bond  
 118 65  
 salad 266 51  
 salad bowl 45 23  
 salad chicory 57 40  
 salad cream 96 29  
 salad drawer 39 4  
 salad fork 45 68  
 salad oil 98 24; 99 66  
 salad plants 57 36-40  
 salad servers 45 24  
 salad spoon 45 67  
 salamander 364 22  
 salamanders 364 20-22  
 sal-ammoniac block 125 6  
 sales area 99 4  
 sales check 98 44; 271 7  
 salesclerk 98 13  
 sales counter 271 42, 61  
 salesgirl 97 1; 98 31; 99 17;  
 271 18, 63  
 saleslady 97 1; 98 31; 99 17;  
 271 18, 63  
 salesman 309 29  
 sales premises 111 1-19  
 sales shelf 99 23  
 sales statistics 248 46  
 salicional 326 23-30  
 salientians 364 23-26  
 salina *Map* 15 32  
 salina *Spa* 274 1-7  
 sallow 371 24  
 salon, men's ~ 106 1-42  
 salon mirror 105 20; 106 6  
 saloon, lower ~ 194 37  
 saloon, upper ~ 194 38  
 saloon car 193 4, 25  
 salt 98 40  
 salt, common ~ 1 9  
 salta 276 20  
 salta piece 276 21  
 salt cake storage tank 172 36  
 salt cellar 266 77  
 salt mine 154 57-68, 72  
 saltstick 97 31  
 salt water outlet 145 33  
 salt water pipe 145 33  
 salt water tank 146 17  
 salt works *Map* 15 32

salt works *Spa* 274 1-7  
 salt works attendant 274 5  
 saltzstange 97 31  
 salvage 227  
 salvage tug 227 5, 16  
 salvaging 227 1  
 Salvator beer 93 26  
 salving 227 1  
 sampan 353 31  
 sample beam 115 36  
 sample sagger 161 2  
 sample scoop 98 72  
 samson post 223 35  
 samson post, ventilator-type  
 ~ 221 58  
 samurai 353 37  
 sanctuary 330 32  
 sanctuary lamp 330 49  
 sanctus bell 330 46  
 sand *Map* 15 6  
 sand *Bldg. Site* 118 36; 119 26  
 sandal 101 51  
 sandal, ladies' ~ 101 49  
 sandal court shoe 101 27  
 sandbag 216 50; 288 65  
 sandbank 227 3  
 sand bed 123 8  
 sand belt, endless ~ 133 15  
 sand box *Railw.* 212 59, 76  
 sandbox *Playground* 273 64  
 sandcastle 280 35  
 sand delivery pipe 148 38  
 sand deposit 216 52  
 sand dome 210 14  
 sander 129 30  
 sander, orbital ~ 134 53  
 sander, single-belt ~ 133 30  
 sander control 211 32  
 sander switch 211 32  
 sandhill 273 66  
 sand hills 15 6  
 sanding 129 28  
 sanding attachment, orbital ~  
 134 53  
 sanding belt, endless ~ 133 15  
 sanding belt regulator 133 14  
 sanding disc 134 25  
 sanding dust extractor 133 28  
 sanding machine, single-belt  
 ~ 133 30  
 sanding table 133 35  
 sanding valve 210 55  
 sanding wheel 133 27  
 sand lizard 364 27  
 sandpaper 128 14; 129 25;  
 135 25  
 sandpaper block 128 13; 129  
 26  
 sand pipe 210 15, 19  
 sandpit 273 64  
 sand star 369 11  
 sand table 173 13  
 sand track racing 290 24-28  
 sand trap *Paperm.* 173 13  
 sand trap *Ball Games* 293 81  
 sand tube 210 15  
 sandwich 45 39  
 sandwich, open ~ 45 37; 266  
 75  
 sandwich board 308 50  
 sandwich man 308 49

sanitary articles 99 35  
 San-José scale 80 35  
 Sanserif 342 7  
 Sanserif type 342 7  
 Sanskrit 341 9  
 sap 120 85; 370 12  
 sappho 363 4  
 sapwood 120 85; 370 12  
 sarcophagus 335 53  
 sardine server 45 78  
 sardines in oil 98 19  
 Sargon's Palace 333 29  
 sartorius 18 45  
 Satan's mushroom 379 12  
 satchel 260 9  
 sate 137 34  
 satellite 4 45  
 satellite radio link 237 51-52  
 satellite sounding 7 33  
 satin stitch 102 10  
 Saturn 4 49  
 Saturn V 234 1, 2  
 sauceboat 45 17  
 sauce ladle 45 18  
 saucepan 40 16  
 saucer 44 30  
 sauna, mixed ~ 281 18  
 sauna stove 281 21  
 sausage 98 4; 99 54  
 sausage, beef ~ 96 11  
 sausage, pork ~ 96 11; 99 55  
 sausage, scalded ~ 96 8  
 sausage filler 96 49  
 sausage fork 96 44  
 sausage meat 96 41, 52  
 sausages 96 6-11  
 sausages, manufacture of ~  
 96 31-59  
 sausage stuffer 96 49  
 sausage tongs 308 35  
 savings account 250 4  
 savoy 57 33  
 savoy cabbage 57 33  
 saw, butcher's ~ 94 19  
 saw, circular ~ 119 19; 125  
 24; 134 50  
 saw, free-cutting ~ 84 32  
 saw, two-handed ~ 120 68  
 saw, vertical frame ~ 157 2  
 sawbill 359 15  
 saw blade 120 62; 150 16; 157  
 3, 47; 260 54  
 saw carriage 132 71; 133 38  
 saw chain 84 35; 85 14; 85 15;  
 120 16  
 saw frame 138 25; 150 17;  
 157 8  
 saw guide 85 16  
 saw handle 132 4  
 sawing shed 120 3  
 sawmill 144 6; 157 1  
 saw rasp 134 6  
 saw set 132 42  
 saw-sharpening machine 157  
 42  
 saw tooth 96 33  
 sawtooth roof 121 20  
 saxboard 283 43  
 saxifrage, rotundifoliate ~  
 375 1  
 saxophone 324 69

scaffold 118 25; 122 34; 222  
 18  
 scaffold, steel ~ 5 18  
 scaffold, supporting ~ 14 50  
 scaffold, tubular steel ~ 119  
 46  
 scaffold board 122 70  
 scaffolding 215 62  
 scaffolding, tubular steel ~  
 119 46  
 scaffolding joint 118 30  
 scaffold pole 118 23  
 scaffold standard 118 23  
 scalding colander 96 45  
 scale *Map* 14 29  
 scale *Chem.* 349 35  
 scale *Fish etc.* 364 11  
 scale *Decid. Trees* 371 12  
 scale *Conifers* 372 34, 42, 45,  
 50  
 scale, triangular ~ 151 34  
 scale, wax ~ 77 25  
 scale adjustment 116 34  
 scale armour 329 64  
 scaled prickly fungus 381 24  
 scale insect 80 35  
 scale louse 80 35  
 scale pan *Kitch. Utensils* 40 37  
 scale pan *Chem.* 349 36  
 Scales *Astron.* 3 19; 4 59  
 scales *Doc.* 22 66  
 scales *Kitch. Utensils* 40 35  
 scales *Child. Rm.* 47 33  
 scales *Supermkt.* 99 88  
 scales *Photog.* 114 58  
 scales *Music. Not.* 320 45-49  
 scaling hammer 137 38  
 scallop shell 309 46  
 scalp 352 15  
 scalpel 26 43  
 scalper 340 7  
 scaly ant-eater 366 10  
 scanner 177 39  
 scanner film 177 72  
 scanning drum 177 45  
 scanning head 177 46, 63  
 scanning zone 243 47  
 scantling 120 10  
 scape 370 52  
 scapula 16 23; 17 7  
 scar 11 48  
 scarecrow 52 27  
 scarf *Ladies' Wear* 31 57  
 scarf *Men's Wear* 33 65  
 scarf *Headgear* 35 16  
 scarf *Bullfight. etc.* 319 38  
 scarf joint, oblique ~ 121 88  
 scarf joint, simple ~ 121 87  
 scarifier 200 20  
 scarlet pimpernel 61 27  
 scarlet runner 52 28; 57 8  
 scarlet runner bean 57 8  
 scarp 13 57  
 scatter cushion 42 27; 46 17  
 scauper 340 7  
 scaur 11 48  
 scaw 11 48  
 scene *Theatre* 316 36  
 scene *Art* 334 45  
 scene number 310 35  
 scene painter 315 35

scene-repeat key 243 42  
 scenery 316 35  
 scenery projector 316 17  
 scene shifter 315 28; 316 46  
 scenic artist 315 35  
 scenic railway 308 39  
 scent, artificial ~ 289 49  
 sceptre, fool's ~ 306 59  
 schalmeyes 322 14  
 schedule 204 16  
 schedule, engineer's ~ 210 52  
 Scheidt globe 349 1  
 schilling 252 13  
 schizocarp 370 94  
 schnauzer 70 35  
 schnorkel *Warships* 259 72,  
 90  
 schnorkel *Swim.* 279 11  
 schnorkel *Bathing* 280 39  
 school 260; 261  
 school bag 260 7  
 school book 47 25  
 school children's wear 29  
 31-47  
 school figure 289 7  
 school horse 289 3  
 school satchel 260 9  
 schooner, four-masted ~ 220  
 28  
 schooner, three-masted ~ 220  
 18  
 schooner, topsail ~ 220 11-13  
 Schottel propeller 227 20  
 Schwellwerk 326 45  
 scion bud 54 37  
 scion bud 54 23, 34  
 scissor-blade 106 35  
 scissor jump 295 39; 298 22  
 scissors *Shoem.* 100 43  
 scissors *School* 260 49  
 scissors *Gymn.* 296 51  
 scissors *Athletics* 298 22  
 scissors, angled ~ 22 51  
 scissors, bull-nosed ~ 128 34  
 scissors, curved ~ 26 42  
 scissors movement 296 51  
 scoop *Doc.* 22 50  
 scoop *Hosp.* 26 52  
 scoop *Graphic Art* 340 8  
 scoop thermometer 92 53  
 scooter 188 47  
 scooters 188  
 scoreboard 293 34, 70  
 scorer 293 71  
 scoring equipment, electrical  
 ~ 294 25-33  
 scoring equipment, electronic  
 ~ 294 32  
 scoring light 294 28  
 scorper 340 7  
 Scorpio 3 38; 4 60  
 Scorpion *Astron.* 3 38; 4 60  
 scorpion *Articulat.* 358 40  
 scorzonera 57 35  
 Scots pine 372 20  
 Scottish terrier 70 17  
 scouring machine, open-  
 width ~ 168 8  
 scouring nozzle 216 62  
 scouring tunnel 217 62  
 scouring wheel 100 6



scout 278 11  
 scout camp 278 8-11  
 scrag 95 6  
 scrag end 95 6  
 scramble racing 290 24-28  
 scrambling motorcycle 189 16  
 scrap box 141 15  
 scraper *Butch.* 96 42  
 scraper *Paperhanger* 128 10  
 scraper *Painter* 129 23  
 scraper *Graphic Art* 340 63  
 scraper, pointed ~ 140 63  
 scraper, triangle ~ 140 63  
 scraper adjustment 340 62  
 scraper and burnisher 340 17  
 scraper blade 200 17  
 scraper floor, movable ~ 62 24  
 scrap iron charging box 147 26  
 scrap iron feed 147 65  
 scray entry, curved ~ 168 47  
 scree 11 47; 12 45; 13 29  
 screech owl 362 17  
 screed 123 41  
 screeding beam 201 14  
 screeding board 201 14  
 scree ledge 300 4  
 screen *Hunt.* 86 9  
 screen *Fish Farm.* 89 10  
 screen *Bldg. Site* 118 85  
 screen *Paperm.* 172 57  
 screen *Refuse Coll.* 199 11  
 screen *Post* 236 40  
 screen *Inf. Tech.* 242 84  
 screen *Swim.* 281 17  
 screen *Films* 310 16, 51; 312 11  
 screen, all-matt ~ 115 58, 59, 60, 65  
 screen, centrifugal ~ 172 22, 56  
 screen, crystal glass ~ 179 24  
 screen, fluorescent ~ 74 40  
 screen, ground glass ~ 112 24; 115 58, 59, 60, 61, 65, 66; 177 2, 34  
 screen, illuminated ~ 177 20; 264 30  
 screen, inner ~ 240 20  
 screen, lead ~ 259 70  
 screen, magnetic ~ 240 20  
 screen, matt ~ *Optic. Instr.* 112 24  
 screen, matt ~ *Photog.* 115 61, 66  
 screen, protective ~ 154 74  
 screen, rotary ~ 172 2  
 screen, secondary ~ 172 58  
 screen, vibrating ~ 158 21  
 screen curtain 312 10  
 screen frame, mobile ~ 168 60  
 screen holder, hinged ~ 177 3  
 screening 156 14  
 screening, inner ~ 240 20  
 screening, magnetic ~ 240 20  
 screenings 158 22  
 screen magazine 177 9  
 screen printing 168 59  
 screen printing operator 168 65

screen table 168 63  
 screen work 136 4  
 screw *First Aid* 21 16  
 screw *Metalwkr.* 140 4  
 screw *Weaving* 165 36  
 screw *Life-Sav.* 228 26  
 screw, cheese-head ~ 143 36  
 screw, cross-head ~ 143 26  
 screw, feathering ~ 224 19  
 screw, hexagonal socket head ~ 143 27  
 screw, main ~ 148 62  
 screw, self-tapping ~ 143 26  
 screw, ship's ~ 221 44; 222 72; 223 62  
 screw, slotted ~ 143 36  
 screw, three-blade ~ 223 62  
 screw-back 277 4  
 screw base 127 59  
 screw block 136 8  
 screw clamp 120 66  
 screw conveyor 92 26  
 screw-cutting machine 125 27; 126 86  
 screw die 140 61  
 screw dive 282 44  
 screwdriver 109 6; 126 69; 127 46; 134 4; 140 62  
 screwdriver, cross-point ~ 134 5  
 screwgate 300 47  
 screw groove 143 38  
 screw joint 126 42  
 screw log 224 54  
 screw post 222 71  
 screws 143 13-50  
 screw slit 143 38  
 screw slot 143 38  
 screw tap 140 60  
 screw thread 50 50  
 screw wrench 126 67  
 scrim 183 33; 185 20  
 scrim roll holder 185 19  
 script *Films* 310 45  
 script *Script* 341; 342  
 script, cuneiform ~ 341 8  
 script, director's ~ 316 44  
 script, Latin ~ 342 12  
 script, producer's ~ 316 44  
 script, Sinaitic ~ 341 13  
 script, uncial ~ 341 17  
 script girl 310 39  
 scripts 341 1-20  
 Scriptures 330 11  
 scroll *Music. Instr.* 323 17  
 scroll *Art* 333 26; 334 23  
 scroll, Vitruvian ~ 334 39  
 scroll-opening roller 168 13  
 scrollwork 336 8  
 scrotum 20 71  
 scrubber 156 22, 23, 24  
 scrubbing agent 156 37  
 scrubbing brush 50 56  
 scrubbing oil tank 156 43  
 scrub board 123 21, 63  
 scrum 292 20  
 scrummage 292 20  
 scuba 279 19  
 scull 283 17, 35-38  
 sculptor 339 1  
 sculpture 339 32

sculpture, modern ~ 272 64  
 scut 88 19, 62  
 scutcher, double ~ 163 14  
 scutcher lap 163 47  
 scutcher lap holder 163 48  
 scutch grass 61 30  
 scutellum 82 5; 358 30  
 scythe 66 12  
 scythe blade 66 13  
 scythe sheath 66 18  
 scythestone 66 19  
 sea 13 26; 14 19-26  
 sea, epeiric ~ 14 26  
 sea, epicontinental ~ 14 26  
 sea, marginal ~ 14 26  
 sea, open ~ 227 4  
 sea anemone 369 20  
 sea bear 367 18  
 seabirds 359 11-14  
 sea calf 367 19  
 sea couch grass 61 30  
 sea cucumber 369 18  
 sea deity 327 23  
 sea divinity 327 23  
 sea dog 367 19  
 sea fan 369 8  
 sea feather 369 14  
 sea fishing 90  
 Sea Goat 3 36; 4 62  
 sea goddess 327 23  
 sea grass 378 54  
 sea hedgehog 357 39; 369 19  
 sea horse 364 18  
 seakale beet 57 28  
 seal 190 69  
 seal, clay ~ 269 39  
 seal, loam ~ 269 39  
 sea ladder 221 91  
 sea lead 89 92  
 sea level 11 11  
 sea lily 369 3  
 sealing tape 126 75  
 seals 367 18-22  
 seam 144 29  
 sea maid 327 23  
 sea maiden 327 23  
 seaman 327 23  
 sea marks 224 68-108  
 seam binding 103 14; 104 19  
 seamless engraving adjustment 177 53  
 sea monster 327 47  
 seam roller 128 36  
 sea nymph 327 23  
 sea otter 367 17  
 sea ox 327 47  
 sea pen 369 14  
 seaplane 232 1, 5  
 seaquake 11 53  
 search 264 31  
 searchlight 258 28  
 Sea Serpent 3 16  
 seaside pleasure boat 221 15  
 sea star 357 38; 369 17  
 sea strait 14 24  
 seat *Man* 16 40  
 seat 24 24; 41 10; 44 11; 65 22; 71 45; 212 63; 271 35; 273 58; 283 28; 303 6; 307 15; 312 9; 315 20  
 seat *Mach. Parts etc.* 143 65

seat, back ~ 193 22  
 seat, captain's ~ 235 17  
 seat, child's ~ 187 21  
 seat, circular ~ 281 38  
 seat, coachman's ~ 186 8  
 seat, commander's ~ 235 17  
 seat, conical ~ 143 67  
 seat, co-pilot's ~ 230 37; 235 18  
 seat, cox's ~ 283 27  
 seat, double ~ 197 19; 207 63  
 seat, driver's ~ 186 8; 191 34; 210 59  
 seat, engineer's ~ 210 59  
 seat, fireman's ~ 210 39  
 seat, folding ~ 193 22; 207 12  
 seat, instructor's ~ 257 7  
 seat, observer's ~ 257 7  
 seat, pilot's ~ 230 36; 235 18; 257 6  
 seat, rear ~ 191 31  
 seat, reclining ~ 191 34; 207 44, 64  
 seat, single ~ 197 17; 207 62  
 seat, sliding ~ 283 41-50, 44  
 seat, student pilot's ~ 257 6  
 seat, upholstered ~ 207 44; 208 25; 265 10  
 seat cushion 42 23  
 seated position 296 31  
 seating 330 28  
 seating group 42 21-26  
 seat pillar 187 24  
 seat stay 187 19  
 seat stick 86 10  
 seat tube 187 18  
 seat upholstery 207 65  
 sea urchin 357 39; 369 19  
 seawater desalination plant 146 25  
 sea wave, seismic ~ 11 53  
 sea wing 232 3  
 secant 346 50  
 secateurs 56 50; 78 12  
 second 299 44  
 secondary 153 16  
 secondary school 261  
 second base 292 43  
 second-class seating arrangement 211 58  
 second-class section 207 10; 208 22  
 seconde engagement 294 50  
 second-hand stall 308 60  
 second indicator 110 21  
 second man 300 26  
 second-stage separation retro-rocket 234 37  
 seconds timer 129 39  
 secretary 209 27  
 secretary, proprietor's ~ 248 31  
 section *Forestry* 84 2  
 section *Drawing Off.* 151 28  
 section *Bookbind.* 183 12  
 section *Railw.* 203 29  
 section, hollow ~ 215 5  
 section, middle ~ 215 68  
 section, tubular ~ 215 5  
 section line *Map* 15 112  
 section line *Forestry* 84 1

section line *Drawing Off.* 151 27  
 section mark 342 36  
 section of warp rib fabric 171 14  
 sections 143  
 sections, conic ~ 347 11-29  
 sector 346 54  
 securities 251 11-19  
 security 251 1-10  
 security, fixed-income ~ 251 11-19  
 security, unlisted ~ 251 5  
 security drawer 236 22  
 sedan 193 4, 25  
 sedge *Phys. Geog.* 13 17  
 sedge *Indoor Plants* 53 17  
 sedilia 330 41  
 sediment *Phys. Geog.* 13 69  
 sediment *Doc.* 23 50  
 sediment filter, stainless steel ~ 79 8  
 seed *Plant Propagn.* 54 3  
 seed *Soft Fruit* 58 23  
 seed *Drupe & Nuts* 59 8  
 seed *Agr.* 63 12  
 seed *Arable Crops* 68 13, 15, 25  
 seed *Bot.* 370 86  
 seed *Decid. Trees* 371 20, 65  
 seed *Conifers* 372 9, 10, 15, 28, 37, 54, 57, 60, 71  
 seed *Flowers etc.* 375 25, 28  
 seed *Alp. Plants etc.* 378 33, 34  
 seed *Trop. Plants* 382 20, 34, 35, 39, 45  
 seed *Industr. Plants* 383 15, 23, 24, 57  
 seed *South. Fruits* 384 10, 20, 21, 47, 52, 58  
 seed, foraminifera ~ 383 57  
 seed, oleiferous ~ 383 5  
 seedbed preparation 63 31-41  
 seed capsule 61 5  
 seed corn 63 12  
 seed-dressing machine 83 52  
 seed dusting 83 52  
 seed fish 89 13  
 seed-harrow, combination ~ *Agr.* 63 41  
 seed-harrow, combination ~ *Agr. Mach.* 65 87  
 seed hopper 65 75  
 seed leaf 370 87  
 seedling *Plant Propagn.* 54 6  
 seedling *Market Gdn.* 55 23  
 seedling *Forestry* 84 7, 9  
 seedling box 55 51  
 seedling nursery 84 6  
 seedling plant 54 6  
 seedlip 63 11  
 seed lobe 370 87  
 seed pan 54 2  
 seed pike 89 11  
 seed potato 68 39  
 seed sowing 54 1  
 seed tuber 68 39  
 seed vessel 57 6; 378 5; 383 8  
 seed vessel, circumscissile ~ 370 95  
 seesaw 273 35; 307 59

Seeger cone 161 6  
 seggar 161 2  
 segment *Maths.* 346 52  
 segment *Invertebr.* 357 25  
 segment disc shutter 313 8  
 seismograph, horizontal ~ 11 39  
 seismology 11 32-38  
 seismometer 11 39  
 seizing 90 5  
 selector 237 42  
 selector, electronic ~ 237 42  
 selector fork 192 42, 45  
 selector head 192 44  
 selector motor 237 48  
 self-discharge freight car 213 24  
 self-discharge wagon 213 24  
 self-feeder 74 13  
 self-heal 376 16  
 self-rescue 21 33  
 self-service restaurant 266 45-78  
 self-service station 196 1-29  
 self-threading guide 165 18  
 self-time lever 115 15  
 self-timer 115 15  
 selvedge 166 11; 171 20, 24  
 selvedge shaft 171 22  
 selvedge thread draft 171 20  
 semaphore arm 203 2  
 semaphore arm, supplementary ~ 203 8  
 semaphore signal 203 1, 7, 12  
 semibold 175 3  
 semibreve 320 13  
 semibreve rest 320 21  
 semicircle 346 46  
 semicolon 342 19  
 semidome 334 73  
 semiquaver 320 17  
 semiquaver rest 320 25  
 semitone 320 50, 52  
 semi-trailer *Lorries etc.* 194 30-33  
 semi-trailer *Station* 206 59  
 semolina 98 36  
 sending-off 291 61  
 senna 380 16  
 senna leaf 380 16  
 sensing element 10 22  
 sepal 58 8, 44; 59 12; 370 58  
 separating funnel 349 3  
 separating layer 7 10  
 separating rail 164 30  
 separation plant 199 31  
 separation rocket motor, aft ~ 235 62  
 separation rocket motor, forward ~ 235 60  
 separator *Bldg. Site* 119 81  
 separator *Offshore Drill.* 146 28  
 separator *Cotton Spin.* 164 43  
 separator *Paperm.* 172 31  
 separator *Roulette* 275 30  
 separator, centralized ~ 172 15  
 septimole 321 23  
 septolet 321 23  
 septum 77 43



septum, interventricular ~ 20  
52  
septum, ventricular ~ 20 52  
septuplet 321 23  
sequester forceps 26 45  
sequoia 372 69  
seraglio, Sultan's ~ 306 41  
serial number *Stock Exch.*  
251 13  
serial number *Money* 252 36  
series, arithmetical ~ 345 11  
series, geometrical ~ 345 12  
series, inner ~ 375 32  
series, outer ~ 375 31  
series of moulds 147 36  
Serpens 3 20  
Serpent *Astron.* 3 20  
serpent *Gymn.* 297 48  
serpent *Music. Instr.* 322 13  
serpent, nine-headed ~ 327  
33  
serpent, paper ~ 308 14  
serrate 370 44  
serratus anterior 18 42  
serrulate 370 44  
server *Ball Games* 293 51, 62  
server *Church* 330 40  
service 293 42  
service area 293 61  
service bell panel 267 28  
service bridge 217 72  
service building 154 36  
service bunker 156 3  
service counter 250 4  
service court 293 12  
service girder, adjustable ~  
119 78  
service line 293 6-7  
service line judge 293 27  
service module 6 2  
service module main engine  
234 57  
service pistol 264 22  
service riser 126 7  
service room 329 27  
service station 196 1-29  
service tray 105 31  
service vehicle 233 22  
servicing craft 258 93  
serviette 45 9; 266 47  
serviette ring 45 10  
serving, jute ~ 153 49  
serving area 207 79  
serving cutlery 45 69-70  
serving fork 45 70  
serving hatch 266 66  
serving spoon 45 74, 75  
serving trolley 45 32  
servo-actuating mechanism  
257 22, 23  
servo cylinder 192 50  
servo unit 192 50  
sesame plant 383 45  
sesquiplane 229 13  
set *Plant Propagn.* 54 20  
set *Blacksm.* 137 34  
set *Composing Rm.* 175 48  
set *Ball Games* 293 37  
set *Maths.* 348 1, 3  
set collar 143 33  
set designer 310 43; 315 37

set hammer 137 33  
set head 143 57  
set of rolls 148 54-55  
set piece 315 30; 316 47  
sets 348  
set screw 127 21  
set square 151 7  
set square, adjustable ~ 151 4  
set square, steel ~ 108 28  
sett 137 34  
settee 42 24  
setting 54 18  
setting and hatching machine  
74 28  
setting lever 115 15  
setting lotion 106 23  
setting rule 174 14  
setting stick 174 13  
set trigger 87 12  
set trigger, second ~ 87 11  
Seven Sisters 3 26  
seventh chord 321 5  
sewer, combined ~ 198 27  
sewing 183 8, 34  
sewing cord 183 10  
sewing frame 183 9  
sewing machine *Dressm.* 103  
8  
sewing machine *Tailor* 104 12  
sewing machine *Bookbind.*  
185 16  
sewing machine cotton 103 12  
sewing machine drawer 104  
18  
sewing machine table 104 17  
sewing machine thread 103  
12  
sewing mechanism 133 5  
sewing needle 185 21  
sewing silk 104 10  
sewing thread 183 11  
sex organs, female ~ 20 79-88  
sex organs, male ~ 20 66-77  
sextant 224 1  
sextolet 321 23  
sexton 330 26, 58  
sextuplet 321 23  
sgraffito 338 41  
shading panel 55 9  
shadow 34 17  
shadow mask 240 17  
shadow mask mount,  
temperature-compensated  
~ 240 22  
shadow roll 289 30  
shaft *Farm Bldgs.* 62 20  
shaft *Agr. Mach.* 64 59  
shaft *Mach. Parts etc.* 143 61  
shaft *Nucl. Energy* 154 69  
shaft *Cotton Spin.* 164 42  
shaft *Weaving* 166 4  
shaft *Carriages* 186 19, 30  
shaft *Aircraft* 232 56  
shaft *Rowing* 283 37  
shaft *Ball Games* 291 26  
shaft *Sports* 305 64  
shaft *Art* 333 27  
shaft, intermediate ~ 232 57  
shaft, main ~ *Coal* 144 24  
shaft, main ~ *Car* 192 40  
shaft alley 223 66

shaft bossing 223 59  
shaft chain 71 20  
shaft furnace 147 1  
shaft guide 166 3  
shaft strut 223 61  
shaft tunnel 223 66  
shag *Tobacc. etc.* 107 25  
shag *Birds* 359 10  
shake 321 17, 18  
shaker 324 59  
shallot 326 18  
shallows 224 87, 97  
shaman 353 24  
shampoo 106 20  
shampoo basin 105 29; 106 12  
shampoo bottle 105 32  
shampooing head 50 79  
shampoo spray 105 30; 106 13  
shampoo unit 105 28; 106 11  
shank *Man* 16 52  
shank *Meat* 95 14, 33  
shank *Shoem.* 100 68  
shank *Metalwkr.* 140 33  
shank *Mach. Parts etc.* 143 15,  
53  
shaper 150 45  
shapes game 48 19  
shaping, final ~ 162 28, 36  
shaping hammer 108 40  
shaping machine *Dairy.* 76 35  
shaping machine *Mach. Tools*  
150 45  
shaping pad 104 23  
shard 161 21  
share *Agr. Mach.* 65 7, 58, 65  
share *Stock Exch.* 251 11-19  
share, chisel-shaped ~ 65 58  
share, diamond-shaped ~ 65  
58  
share, pointed ~ 65 65  
share, three-bladed ~ 64 67  
share certificate 251 11  
share register 251 14  
share warrant 251 11  
shark 364 1  
sharp 320 50  
sharpie 284 53  
shave 136 39  
shave, clean ~ 34 25  
shaver, electric ~ 49 37  
shaving 120 80  
shaving cream 99 33  
shavings 132 40; 135 26  
shawl 31 71  
shawm 322 14  
shawm, double ~ 322 3  
shearing train 148 74, 75  
shears 128 34  
shears, tinner's ~ 125 1  
sheatfish 364 12  
sheath *Arable Crops* 68 9  
sheath *Forestry* 84 30  
sheath, lead ~ 153 39, 47  
sheath, leather ~ 283 ps  
sheathfish 364 12  
sheathing paper 122 62  
shed 166 40  
shedding tappet 166 57  
shed roof 37 78; 121 7  
sheep 73 13  
sheepdog 70 25

sheep pen 75 9  
sheer 259 23  
sheer stroke 222 44  
sheet *Household* 50 5  
sheet *Offset Print.* 180 17, 47  
sheet *Ship* 219 68  
sheet *Office* 249 57  
sheet *Fire Brig.* 270 18  
sheet *Gymn.* 297 11  
sheet, blank ~ 180 69; 181 23,  
30  
sheet, corrugated ~ 122 98  
sheet, linen ~ 43 9  
sheet, plastic ~ 76 28  
sheet, printed ~ 180 55, 57;  
181 25  
sheet, single ~ 340 27  
sheet, unprinted ~ 180 69;  
181 23, 30  
sheet cloud 8 3, 4, 8, 9, 10  
sheet counter 181 54  
sheet delivery 249 54  
sheet feeder 180 31, 48, 68,  
74; 181 24; 184 16; 185 25  
sheet feeder, automatic ~ 181  
5  
sheet-feeding station 184 16  
sheet glass 124 5  
sheet glass production 162  
1-20  
sheeting support 119 86  
sheet metal 128 17  
sheet-metal screw 143 26  
sheet of glass 162 10  
sheet of stamps 236 21  
sheet pile 119 17  
sheet pile bulkhead 217 5  
sheet pile wall 119 17; 217 5  
sheet piling 119 17; 217 5  
sheet shears 125 26  
sheet zinc 122 14  
shelf 44 19; 98 14; 100 36; 195  
14; 271 27  
shelf, continental ~ 11 8  
shelf, revolving ~ 39 28  
shelf, steel ~ 262 12  
shelf, wall-mounted ~ 248 40  
shelf for bottles 266 10; 267  
64; 317 4  
shelf for glasses 266 9; 267  
65; 317 5  
shelf unit 46 1  
shell *Cooper* 130 23  
shell *Shipbuild.* 222 44-49  
shell *Rowing* 283 33, 48  
shell *Ball Games* 293 33  
shell *Invertebr.* 357 29  
shell *Fish etc.* 364 29  
shell, soft ~ 59 42  
shell, steel ~ 154 21  
shell bit 135 16  
shell bossing 223 59  
shell membrane 74 60  
shell plating 222 44-49  
shells 283 9-15  
shelter 223 17  
shelving 248 28  
shepherd bird 361 4  
shepherd's club 376 9  
shepherd's purse 61 9  
shepherd's weatherglass 61 27

sherd 161 21  
sherry glass 45 84  
shield *Game* 88 55  
shield *Plumb. etc.* 126 33  
shield *Ship* 218 17  
shield *Heraldry* 254 5  
shield *Ethnol.* 354 10  
shield, concrete ~ 154 20  
shield, concrete and lead ~ 1  
57  
shield, protective ~ 2 46  
shield, round ~ 329 57  
shield, sliding ~ 2 32  
shield budding 54 30  
shielding, protective ~ 2 46  
shielding-gas supply 142 34  
shielding wall, lead ~ 2 46  
shield volcano 11 13  
shifting spanner 126 68  
shift key 249 3  
shift lock 249 5  
shift pattern 192 47  
shikara 337 26  
shin 95 22, 28  
shinbone 17 25  
shingle 34 34  
shin guard 142 12; 291 34  
shin pad 292 9; 302 33  
ship, five-masted ~ 220 35  
ship, four-masted ~ 220 31  
ship, full-rigged ~ 220 24-27,  
31, 35  
ship, stranded ~ 228 10  
shipbuilding 222  
shipbuilding sheds 222 3-4  
shipbuilding yard 222 1-43  
'ship cleared through  
customs' 253 36  
ship-drawing office 222 2  
ship fix 224 45  
ship of the line 218 51-60  
shipper 206 28  
shipping traffic radio  
telephone 224 28  
ship run aground 227 2  
ship under construction 222  
30  
shipyard 222 1-43  
shirt 30 26; 291 56  
shirt, casual ~ 32 38; 33 37  
shirt, check ~ 33 50  
shirt, knitted ~ 33 36  
shirt, short-sleeved ~ 33 33  
shirt-blouse 30 40  
shirt button 33 34  
shirts, men's ~ 32 38-47  
shirt top 30 45  
shirtwaist 319 23  
shirt-waister dress 30 10  
Shiva 337 19  
shoals 224 87, 97  
shoat 75 42  
shock absorber *Moon L.* 6 32  
shock absorber *Car* 191 26;  
192 69  
shock absorber *Railw.* 207 4  
shock absorber, telescopic ~  
188 41; 189 23  
shock treatment 25 26  
shock wave 11 35

shoe *Mills* 91 14  
shoe *Bldg. Site* 119 50  
shoe, bast ~ 122 75  
shoe, copped ~ 355 42  
shoe, finished ~ 100 1  
shoe, hemp ~ 122 75  
shoe, high-heeled ~ 101 33  
shoe, laced ~ 101 31  
shoe, peaked ~ 355 42  
shoe, piked ~ 355 42  
shoe, repaired ~ 100 1  
shoe, slater's ~ 122 75  
shoe brake 143 97  
shoe brush 50 41  
shoe buckle 101 52  
shoe care utensils 50 39-43  
shoelace 100 64  
shoemaker 100  
shoe polish 50 39, 43  
shoes 41 16; 101  
shoe sieve 64 19  
shoe spray 50 40  
shoot 54 37; 370 19-25  
shoot, female ~ 372 46, 48  
shoot, long ~ 78 3  
shoot, male ~ 372 44, 49, 56  
shoot, short ~ 372 23, 31  
shooting *Hunt.* 86 47-52  
shooting *Films* 310 14-60,  
26-60  
shooting, exterior ~ 310 18  
shooting, outdoor ~ 310 18  
shooting box 305 78  
shooting brake 193 15  
shooting gallery 308 58  
shooting positions 305 27-29  
shooting range 305 74  
shooting script 310 45  
shooting seat 86 10  
shooting star 7 25  
shooting station 305 78  
shooting stick 86 10  
shop 195  
shop, goldsmith's ~ 215 33  
shop assistant 97 1; 98 13, 31;  
99 17; 271 18  
shop front 268 42  
shopkeeper 98 41  
shopper 50 87  
shopping bag 98 45; 99 3; 268  
19  
shopping trolley 50 87; 99 1  
shop shelf 47 36  
shop sign 268 39  
shop walker 271 33  
shop window 268 10  
shop window decoration 268  
12  
shop window display 268 11  
shorthand 342 13  
shorthand pad 245 29; 248 32  
shorthand writing 342 13  
short measure 294 10  
short/medium haul airliner  
231 4; 231 11  
short run 184 1; 249 59  
shorts 33 25; 291 57  
shorts, children's ~ 29 25  
shorts, ladies' ~ 31 39  
shorts, leather ~ 29 32  
short standing 75 22



short stop 292 42  
 short wave 7 26  
 short-wave station 237 54  
 short-wave therapy  
 apparatus 23 22, 39  
 shot *Athletics* 298 49  
 shot *Sports* 305 52  
 shote 75 42  
 shot firer 158 25  
 shotgun, over-and-under ~  
 87 33  
 shot number 310 35  
 shot put 298 48  
 shoulder *Phys. Geog.* 12 41  
 shoulder *Man* 16 22  
 shoulder *Horse* 72 18  
 shoulder *Game* 88 17, 38  
 shoulder *Meat* 95 5, 9  
 shoulder *Composing Rm.* 175  
 40  
 shoulder balance 295 29  
 shoulderblade 16 23; 17 7  
 shoulder button 31 15  
 shoulder cape 355 39  
 shoulder girdle 17 6-7  
 shoulder guard 142 5  
 shoulder iron 38 33  
 shoulder landing 298 12  
 shoulder rest 255 9, 31, 39  
 shoulder stand 295 29  
 shoulder strap 260 11  
 shoulder strap, frilled ~ 29 14  
 shovel 55 14; 137 2; 200 1;  
 255 77  
 shovel, mechanical ~ 118 81  
 shovel, wooden ~ 91 24  
 shovel bucket 118 82  
 show booth 308 6  
 showcase 271 13  
 shower *Meteorol.* 8 19  
 shower *Meteorol. etc.* 9 37  
 shower *Life-Sav.* 228 30  
 shower *Swim.* 282 2  
 shower, lukewarm ~ 281 29  
 shower adjustment rail 49 43  
 shower attachment,  
 extendible ~ 126 30  
 shower base 49 44  
 shower bath 282 2  
 shower cubicle 49 39  
 shower curtain 49 40  
 shower head, adjustable ~ 49  
 41  
 shower nozzle 49 42  
 'showers' 233 46  
 show jumping 289 8-14  
 showman 308 10  
 show people, travelling ~ 308  
 25-28  
 shredding 169 6  
 shrew 366 7  
 shrew mouse 366 7  
 shrimp 369 12  
 shrine 337 21  
 shrine, Buddhist ~ 337 21  
 shrink foil 76 25  
 shrink ring 130 24  
 shrink-sealing machine 76 24  
 shroud 219 16; 284 18  
 shrub, anemophilous ~ 59  
 44-51

shrub, ornamental ~ 272 14  
 shrub, wind-pollinating ~ 59  
 44-51  
 shrub bed 55 37  
 shrubs, ornamental ~ 373;  
 374  
 shuck 68 33  
 shunter 206 43  
 shunting engine 206 43  
 shunting locomotive 206 43  
 shutter *Market Gdn.* 55 9  
 shutter *Mills* 91 4  
 shutter, folding ~ 37 30  
 shutter, louvred ~ 212 84  
 shutter, rolling ~ 37 28  
 shutter, side ~ 119 55  
 shutter board 118 41; 119 18,  
 76  
 shutter catch 37 31  
 shuttering 119 54-76; 123 10  
 shuttering, bottom ~ 119 54  
 shuttering board 119 76  
 shuttering strut 119 13  
 shutter opening 304 12  
 shutter release 114 12, 31;  
 115 18; 117 6; 313 24, 38  
 shutter release button 114 12;  
 115 18  
 shutter speed control 114 35;  
 115 19  
 shutter speed setting knob  
 115 19  
 shutter weir 217 65-72  
 shuttle *Needlewk.* 102 20  
 shuttle *Weaving* 166 9, 26  
 shuttle *Ball Games* 293 44  
 shuttle box 166 9  
 shuttlecock 273 7; 293 44  
 shuttlecock game 273 6  
 shuttle eye 166 29  
 shuttle tip, metal ~ 166 25  
 sickle 56 8  
 side *Man* 16 32  
 side *Optic.* 111 13  
 side *Joiner* 132 23  
 side *Weaves* 171 32  
 side *Billiards* 277 5  
 side *Art* 336 40  
 side *Maths.* 346 26, 27  
 side, subordinate ~ 252 9  
 side, woven ~ 136 18  
 side batten 222 62  
 side blackboard 260 35  
 sideboard *Dining Rm.* 44 20  
 sideboard *Tablew. etc.* 45 44  
 side board *Farm Bldgs.* 62 25  
 sideboards 34 24  
 sideburns 34 24  
 sidecar 290 30  
 sidecar body 189 54  
 sidecar combination 290 29  
 sidecar crash bar 189 55  
 sidecar machine 189 53  
 sidecar wheel 189 57  
 sidecar windscreen 189 58  
 sidecar windshield 189 58  
 side cast, two-handed ~ 89 32  
 side ceiling 222 62  
 side comb 105 6  
 side control 180 5, 20  
 side drum 323 51

side elevation 207 1, 22-25,  
 37, 60, 74  
 side flat 310 33  
 side frame 165 12; 167 20  
 side girder, longitudinal ~ 222  
 52  
 side grafting 54 36  
 side grip 134 45  
 side horse 296 5  
 side joint 111 14  
 side lay control 180 5, 20  
 sidelight 189 56; 191 20; 223  
 15  
 sidelight, green ~ 286 11  
 sidelight, headlight, and  
 parking light switch 191 62  
 sidelight, port ~ 286 12  
 sidelight, red ~ 286 12  
 sidelight, starboard ~ 286 11  
 sideline 292 17; 293 2 bis 3, 4  
 bis 5; 293 55  
 side margin control 180 5, 20  
 sidemarker lamp 189 56; 191  
 20  
 side note 185 68  
 side of pork 94 23  
 side panel, removable ~ 188  
 48  
 side parting 315 1  
 side planking 62 25  
 side pocket 33 12  
 siderostat 5 16  
 side rudder 218 6  
 side shoot 370 21  
 sideshow 308 24  
 side slit 30 49  
 side split 295 14  
 side stake 206 24  
 side stay 284 18  
 sidestep 301 27  
 sidestepping 299 29  
 side stop 200 34, 44  
 side straddle 295 3  
 side strake 222 45  
 side stringer 222 50  
 side stroke 282 36  
 side support *Shipbuild.* 222 40  
 side support *Free Exerc.* 295  
 25  
 side thrust kick 299 19  
 side trappings 71 16  
 side view 207 1, 22-25, 37, 60,  
 74  
 sidewalk 37 60; 198 9  
 sidewall *Electrotyp. etc.* 178  
 45  
 sidewall *Railw.* 213 29  
 side wall *Music. Instr.* 323 4,  
 25  
 side-whiskers 34 24  
 side window blower 191 61  
 siding 206 50  
 Siemens-Martin open-  
 hearth furnace 147 21-30  
 sieve *Market Gdn.* 55 13  
 sieve *Graphic Art* 340 24  
 sieve, louvred-type ~ 64 17  
 sieve, reciprocating ~ 64 19  
 sieve, upright ~ 55 13  
 sieve extension 64 18  
 sifter 91 26

sight 87 65; 255 45  
 sight, front ~ 87 71; 255 3, 23,  
 37; 305 42  
 sight, optical ~ 305 41  
 sight, telescopic ~ 87 29; 255  
 28; 305 49  
 sight graticule 87 31-32  
 sighting mechanism 255 45  
 sighting notch *Hunt.* 87 66  
 sighting notch *Army* 255 22  
 sight scale division 87 68  
 sign, chequered ~ 203 30  
 sign, illuminated ~ 203 38  
 signal 205 42  
 signal, distant ~ 203 7-24  
 signal, main ~ 203 1, 1-6  
 signal, visual ~ 238 30  
 signal and radar mast 221 7  
 signal arm 203 2  
 signal box 15 24  
 signal box, electrically-  
 operated ~ 203 61  
 signal box, manually-  
 operated ~ 203 53  
 signal element 243 60  
 signal flags 253 22-34  
 signal generator 313 30  
 signalling *see* signalling  
 signal knob 203 62  
 signal lever 203 56  
 signal light *Power Plant* 153 3  
 signal light *Cotton Spin.* 164 8  
 signal light *Railw.* 212 15  
 signal light *Ship* 221 125  
 signalling equipment 203  
 signalling lamp 223 7  
 signalling mast 225 34  
 signal mast *Map* 14 51  
 signal mast *Docks* 225 34  
 signal position 203 4, 5, 10, 11  
 signals, supplementary ~ 203  
 25-44  
 signal stay 223 11  
 signal tower 14 51  
 signal tower, electrically-  
 operated ~ 203 61  
 signal tower, manually-  
 operated ~ 203 53  
 signal track 243 59  
 signature *Bookbind.* 183 12;  
 185 69  
 signature *Stock Exch.* 251 15,  
 16  
 signature, cross-folded ~ 185  
 15  
 signature, parallel-folded ~  
 185 13  
 signature code 185 69  
 signboard 118 45  
 signet ring 36 40  
 sign for day running 203 36  
 sign for night running 203 38  
 sign of parallelism 345 21  
 sign of similarity 345 22  
 signs, conventional ~ 15  
 1-114  
 signs, zodiacal ~ 4 53-64  
 signs of the zodiac 4 53-64  
 signwriting brush 129 41  
 sikar 337 26  
 sikhara 337 26

silencer 191 29; 209 12; 22, 24;  
 211 49; 305 93  
 silhouette 25 39  
 silicon atom 1 14  
 siliqua *Weeds* 61 20, 23  
 siliqua *Bot.* 370 93  
 siliqua *Alp. Plants etc.* 378 33  
 siliqua *South. Fruits* 384 46  
 siliqua, mature ~ 383 4  
 siliqua, ripe ~ 383 4  
 silk-cotton tree 383 20  
 silk moth 358 48  
 silk taffeta 35 36  
 silkworm 358 50  
 sill *Phys. Geog.* 11 31  
 sill *Car* 193 21  
 sill rail 120 56  
 silo 225 68  
 silo, above-ground ~ 62 11  
 silo, polythene ~ 62 43  
 silo cylinder 225 69  
 silo pipe 62 12  
 silver 254 25  
 silver-disc pyrheliometer 10  
 23  
 silver fir 372 1  
 silverfish 81 14  
 silverleaf 371 23  
 silver owl 362 17  
 silver poplar 371 23  
 silverside 95 34  
 silversmith 108  
 sima 11 4  
 simple interest formula 345 7  
 simsim 383 45  
*Sinanthropus* 261 18  
 sine 346 32  
 singer 315 22, 23  
 single, clinker-built ~ 283 18  
 single-hand control 185 7  
 single-loader 87 1  
 singles 293 4-5  
 single sculler 283 16  
 single-shot rifle 305 35  
 singles match 293 4-5  
 singles sideline 293 4-5  
 single-system recording 117 8  
 singlet 296 61  
 single-trip bottle 93 29  
 sinister 254 19, 21, 23  
 sink *Phys. Geog.* 11 49; 13 71  
 sink *Kitch.* 39 35  
 sink *Forestry* 84 28  
 sink *Bakery* 97 68  
 sink *Coal* 144 47  
 sink *Energy Sources* 155 16  
 sink *School* 261 6, 34  
 sink *Camping* 278 6  
 sinker *Sea Fish.* 90 10  
 sinker *Knitting* 167 58  
 sinker *Navig.* 224 73  
 sinker, oval ~ 89 88  
 sinkhole 11 49; 13 71  
 sink unit 39 33-36  
*Sinningia* 53 7  
 sinter terraces 11 23  
 sinuate 370 48  
 sinus, frontal ~ 17 55  
 sinus, sphenoidal ~ 17 54  
 siphon barometer 10 1  
 siphon tube 10 43

siren *Ship* 223 3  
 siren *Fabul. Creat.* 327 58  
 siren, ship's ~ 224 32  
 sirenian 366 23  
 Sirius 3 14  
 sirloin 95 17; 96 4  
 sisal 35 13  
 siskin 361 8  
 site fence 118 44  
 site hut 118 48; 119 44  
 site of battle 15 93  
 site office 118 48  
 sit harness 300 57  
 situla, sheet-bronze ~ 328 34  
 Siva 337 19  
 six-day race 290 2-7  
 six-day racer 290 2  
 six-eight time 320 34  
 six-four time 320 35  
 sixte engagement 294 48  
 sixteenth note 320 17  
 sixteenth rest 320 25  
 six-to-pica 175 19  
 sixty-fourth note 320 19  
 sixty-fourth rest 320 27  
 size 128 4  
 size press 173 24  
 sizing 162 53  
 sizing and edging machine  
 132 57  
 sizing machine 165 52  
 skateboard 273 51  
 skate guard 302 25  
 skate sailing 302 27-28  
 skate sailor 302 27  
 skeet 305 70-78  
 skeet choke 305 71  
 skeet shooting 305 70-78  
 skag 279 3; 286 61  
 skeletal 194 30-33  
 skeleton *Man* 17 1-29  
 skeleton *School* 261 14  
 skeleton *Winter Sp.* 303 22  
 skeleton, siliceous ~ 357 8  
 skeleton construction 119 1  
 skeleton rider 303 23  
 skeleton toboggan 303 22  
 skeleton tobogganing 303  
 22-24  
 skip 77 52  
 sketch for costume 315 40  
 sketch pad 338 35  
 skew notch 120 54  
 skew notch, double ~ 121 91  
 skew notch, single ~ 121 90  
 ski, compact ~ 301 1  
 ski, modern ~ 301 46  
 ski bag 301 28  
 ski bob 304 16  
 ski cap 35 39; 301 10  
 skid chain 304 10  
 skidder 85 34  
 skidder, short-haul ~ 85 27  
 skife knife 100 51  
 skiff 283 16  
 skiing 301 1-72  
 skiing boot, cemented sole ~  
 301 12  
 skiing cap 35 39; 301 10  
 skiing goggles 301 11  
 ski jumping 301 35



ski jumping boot 301 41  
 ski jumping ski 301 38  
 ski lift 301 57-63, 59  
 skim couler 65 11  
 skimmer 96 43  
 skimmer, stepped ~ 286 38-41  
 skimmer rod 148 17  
 skimmers 286 38-44  
 skim milk tank 76 17  
 skin *Shipbuild.* 222 44-49  
 skin *School* 261 9  
 skin *Gliding* 287 40  
 skin, light alloy ~ 235 11  
 skin, outer ~ *Rowing* 283 33, 48  
 skin, outer ~ *Ball Games* 293 33  
 skin diver 279 7  
 skin diving 279 7-27  
 skip *Road Constr.* 200 25  
 skip *Railw.* 213 38; 214 34  
 skip *Gymn.* 297 42, 45  
 skip hoist *Iron & Steel* 147 3  
 skip hoist *Road Constr.* 200 14  
 ski pole 301 5  
 skipping 273 15  
 skipping rope 273 16; 297 43  
 skip rope 273 16  
 skip-winding system 144 25  
 skirt *Child. Clothes* 29 52  
 skirt *Ladies' Wear* 31 3, 24  
 skirt *Army* 255 85  
 skirt *Motorboats etc.* 286 66  
 skirt *Airports* 288 48  
 skirt, aft ~ 235 63  
 skirt, girl's ~ 29 46  
 skirt, grass ~ 306 18  
 skirt, inverted pleat ~ 30 51  
 skirt, loden ~ 30 67  
 skirt, long ~ 30 45  
 skirt, pleated ~ 30 32  
 skirt, wrap-around ~ 31 13  
 skirt, wrapover ~ 31 13  
 skirting 123 21  
 skirting board 123 21, 63  
 skirt suit 31 1  
 skirt suit, girl's ~ 29 50  
 ski stick 301 5  
 ski stop 301 56  
 ski suit, ladies' ~ 301 9  
 ski suit, one-piece ~ 301 9  
 skittle frame 305 1-11  
 skittles 305 1-13  
 skiving knife 100 51  
 ski wax 301 21  
 ski-waxing equipment 301 21-24  
 skull *Man* 17 1, 30-41  
 skull *School* 261 15, 17, 19, 21  
 skull *Rowing* 283 35-38  
 skull *Chivalry* 329 39  
 skull, Australopithecine ~ 261 20  
 sky 3 1-8  
 sky, northern ~ 3 1-35  
 sky, southern ~ 3 36-48  
 sky blue 343 6  
 skylight 38 2; 121 8; 122 12  
 skysail 220 32  
 slab 120 96

slab, reinforced concrete ~ 123 28  
 slab, stone ~ 51 17; 331 61  
 slab, wooden ~ 324 62  
 slab cake 97 34; 99 21  
 slacks 29 49  
 slacks, lightweight ~ 31 52  
 slack suit 30 57  
 slade 65 6, 66  
 slag escape 147 9  
 slag ladle 147 10  
 slag spout 148 12  
 slalom 301 29, 64  
 slalom canoe 283 4  
 slalom ski 286 60  
 slant track 243 31  
 slapstick 306 48  
 slat 229 53  
 slat, extensible ~ 229 38  
 slate *Roof* 122 85  
 slate 309 72  
 slate hammer 122 73  
 slater *House Insects etc.* 81 6  
 slater *Roof* 122 71  
 slate roof 122 61-89  
 slath 136 21  
 slating batten 122 17  
 slaughterer 94 1  
 slaughterhouse *Slaughterho.* 94  
 slaughterhouse *Bullfight, etc.* 319 13  
 slaughterman 94 1  
 slave, female ~ 306 41  
 slave driver 218 47  
 slave galley 218 44-50  
 slave station 224 41  
 sled 303 1, 2  
 sled dog 353 2  
 sledge 303 1, 2  
 sledge dog 353 2  
 sledge hammer 137 22; 158 6  
 sleeper *Bldg. Site* 119 39  
 sleeper *Station* 205 60  
 sleeper *Railw.* 207 36  
 sleeper, concrete ~ 202 37  
 sleeper, coupled ~ 202 14, 38  
 sleeper, steel ~ *Railw.* 202 36  
 sleeper, steel ~ *Hvdr. Eng.* 217 3  
 sleeper and strampler 29 23  
 sleeping bag *Infant Care etc.* 28 17  
 sleeping bag *Camping* 278 30  
 sleeping car 207 36  
 sleeping doll 47 11  
 sleeve 30 15  
 sleeve, batwing ~ 31 16  
 sleeve, braided ~ 186 24  
 sleeve, daged ~ 355 46  
 sleeve, full ~ 355 60  
 sleeve, gallooned ~ 186 24  
 sleeve, kimono ~ 30 36  
 sleeve, petal-scalloped ~ 355 46  
 sleeve, protective ~ 142 6  
 sleeve, puffed ~ 31 27; 355 49, 60  
 sleeve, sliding ~ 192 32, 35  
 sleeve, turned-up ~ 31 62  
 sleeve, turnover ~ 30 6

sleeve, turn-up ~ 30 6  
 sleeve board 50 20  
 sleeve protector 324 17  
 sleigh, horse-drawn ~ 304 25  
 sleigh bell 304 26  
 slender funnel fungus 381 25  
 slewing crab 222 21  
 slew turntable 200 22  
 sley 166 41, 53  
 sley cap 166 6  
 slice *Bakery* 97 43  
 slice *Blacksm.* 137 2  
 slice, sugared ~ 97 43  
 slicer 96 31  
 slicker 81 14  
 slide *Inf. Tech.* 242 42  
 slide *Playground* 273 24  
 slide *Winter Countr.* 304 17  
 slide *Music. Not.* 321 16  
 slide *Music. Instr.* 322 51; 323 47; 326 7, 33  
 slide, bed ~ 177 59  
 slide bar 313 10  
 slide calliper 85 10  
 slide chair 202 22  
 slide control 238 47; 241 8  
 slide-copying adapter 115 88  
 slide-copying attachment 115 87  
 slide holder 309 43  
 slide projector 114 76; 309 42; 312 23  
 slider 326 7  
 slide rail 206 38  
 sliding door 271 50  
 sliding scale 349 23  
 sliding weight 22 68; 40 36  
 sliding-weight scales 22 66; 40 35  
 sling *First Aid* 21 2  
 sling *Mountain.* 300 11  
 sling pump 101 53  
 sling ring 87 5  
 sling seat 300 29  
 slip *Underwear etc.* 32 13  
 slip *Plant Propagn.* 54 20  
 slip *Roof* 122 48  
 slip casting 161 15  
 slip fault 12 7  
 slip-off slope 13 58  
 slipper *Shoes* 101 41  
 slipper *Station* 206 49  
 slipper animalcule 357 9  
 slipper brake 206 49  
 slip road 15 16  
 slips 222 11-26  
 slip sock, woollen ~ 101 42  
 slipway 222 11-18  
 slipway crane 222 23  
 slipway floor 222 17  
 slipway frame 222 19  
 slipway portal 222 11  
 slipways 222 11-26  
 slit, side ~ 30 49  
 slit gong 354 18  
 slitter 181 42  
 sliver 164 15, 21  
 sliver, carded ~ 163 38  
 sliver, carded and combed ~ 163 72  
 sliver, coiled ~ 163 35

sliver, doubled ~ 164 12  
 sliver, thin ~ 164 13  
 sliver can 164 3, 20  
 sloe 374 27  
 slope 347 12  
 slope, continental ~ 11 9  
 slope soaring 287 27  
 slopes 355 34  
 slosh baffle system 235 53  
 slot *Glass Prod.* 162 9  
 slot *Weaving* 166 32  
 slot *Garage* 195 5  
 slot *Election* 263 30  
 slot *Airports* 288 45  
 slotted board 2 45  
 slouch hat 35 21  
 slow motion control 243 49  
 slow-running jet 192 1  
 slowworm 364 37  
 slubbing frame 164 19  
 slug 174 27  
 slug-casting machine 174 19  
 slug-composing machine 174 19  
 slug of clay 161 10  
 sluice dam 217 73-80  
 sluice gate 217 53-56, 77  
 sluice valve 217 53-56  
 slump fault 12 7  
 slush 304 30  
 slush pump 145 16  
 smack 221 49  
 small-arm 87 2  
 small beer 93 26  
 smallbore free rifle 305 44  
 smallbore rifle 305 48  
 smallbore standard rifle 305 43  
 small cabbage white butterfly 80 48  
 small ermine moth 80 5  
 small of the back 16 25  
 small of the butt 87 7  
 small scabious 375 29  
 small-shot cartridge 87 49  
 small-shot charge 87 51  
 smash 293 17  
 smear 23 15, 50  
 smelting section 147 8  
 smith 137; 138  
 smith forging 139  
 smock overall 31 35  
 smock windmill 91 29  
 smokebox door 210 26  
 smoke canister 255 83  
 smoke dispenser 255 83  
 smoke extract 38 81  
 smoke flap 352 9  
 smoke house 96 48  
 smoke outlet 38 81; 210 22; 353 21  
 smoker's companion 107 44  
 smokestack *Power Plant* 152 15  
 smokestack *Railw.* 210 22  
 smoke tube 210 8  
 smoking requisites 107  
 smoother 128 11  
 smoothing blade 200 18  
 smoothing plane 132 15; 134 1

snaffle 289 12  
 snail 357 27  
 snail, edible ~ 357 27  
 snail shell 357 29  
 snake, poisonous ~ 364 40  
 snake, venomous ~ 364 40  
 snake charmer 353 45  
 snakes 364 38-41  
 snakeweed 376 10  
 snapdragon 51 32  
 snap gauge 149 59  
 snap lid 127 24  
 snapping beetle 80 37  
 snapping bug 80 37  
 snare drum 323 51  
 snath 66 16  
 snathe 66 16  
 snead 66 16  
 sneath 66 16  
 snedding machine 85 18  
 snipe 88 83  
 snorkel *Warships* 259 72, 90  
 snorkel *Swim.* 279 11  
 snorkel *Bathing* 280 39  
 snout 73 10; 88 53; 364 2  
 snow 8 18; 9 34; 304 24; 353 5  
 snow and ice climber 300 15  
 snow and ice climbing 300 14-21  
 snow and ice climbing equipment 300 31-57  
 snow avalanche 304 1  
 snowball *Winter Countr.* 304 15  
 snowball *Shrubs etc.* 373 10  
 snowball bush 373 10  
 snowball fight 304 14  
 snow blower 213 17  
 snow bridge 300 24  
 snow chain 304 10  
 snow cornice 300 20  
 snowdrift 304 5  
 snowdrop 60 1  
 snowfall 10 48; 304 4  
 snow fence 304 6  
 snow forest climate 9 56  
 snow gaiter 300 55  
 snow goggles 300 18  
 snow guard 38 8  
 snow guard bracket 122 16  
 snow hut 353 4  
 snow ledge 300 4  
 snowman 304 13  
 snow plough, rotary ~ 213 17  
 snow plough attachment 304 9  
 snow plough signs 203 34-35  
 snow push 304 23  
 snowshirt 300 6  
 snow shovel 304 23  
 snowslide 304 1  
 snow suit 29 38  
 snuff 107 20  
 snuff box 107 20  
 soaking pit 148 46  
 soaking pit crane 148 47  
 soaking tub 136 13  
 soap 49 22  
 soap box 273 33  
 soap dish 49 21  
 soap dispenser 50 27

soaring 287  
 soccer 273 10; 291  
 sock 291 58  
 sock, knee-length ~ 29 53; 32 32; 33 42  
 sock, long ~ 32 34  
 sock, surgical ~ 101 50  
 socket *Hairdresser* 106 15  
 socket *Plumb.* 125 20  
 socket *Plumb. etc.* 126 43  
 socket *Electr.* 127 7  
 socket, double ~ 127 6  
 socket, earthed ~ 127 5, 6, 13  
 socket, four-way ~ 127 8  
 socket, multi-outlet ~ 195 39  
 socket, surface-mounted ~ 127 13  
 socket, switched ~ 127 7  
 socket, three-pin ~ 127 66  
 socket, three-pole ~ 127 13  
 socket, tinner's ~ 125 20  
 socket, underfloor ~ 127 22  
 socket outlet box 127 25  
 socks, men's ~ 32 32-34  
 soda bottle 42 32  
 soda-lime absorber 27 39  
 soda water 98 87  
 soda water bottle 42 32  
 sodium atom 1 8  
 sodium chloride 1 9; 170 13  
 sodium ion 1 11  
 sodium pump, primary ~ 154 5  
 sodium pump, secondary ~ 154 8  
 sodium sulphate storage tank 172 36  
 sodium system, primary ~ 154 2  
 sodium system, secondary ~ 154 7  
 sofa 336 17  
 sofa, two-seater ~ 246 36  
 soffit 122 27  
 soft corn 68 31  
 soft pedal 325 9  
 soil covering 200 64  
 soil injector 83 33  
 solan goose 359 9  
 solar cell 155 34  
 solar collector 155 28, 32  
 solarium 281 10  
 solar panel 10 66  
 solar radiation shielding 10 36  
 solar sensor 10 69  
 solar spectrum 343 14  
 solar system 4 42-52  
 soldanella 378 3  
 solder 108 38  
 solder, tin-lead ~ 126 76  
 soldering apparatus 125 5-7  
 soldering borax 108 39  
 soldering fluid 125 7  
 soldering flux 108 36  
 soldering gun *Goldsm. etc.* 108 14  
 soldering gun *D.I.Y.* 134 56  
 soldering iron *Plumb.* 125 5  
 soldering iron *Plumb. etc.* 126 73



soldering iron *D.I.Y.* 134 19, 57  
 soldering iron, electric ~ 127 45  
 soldering iron, high-speed ~ 134 58  
 soldering stone 125 6  
 solder wire, tin-lead ~ 134 20  
 soldier, lead ~ 309 52  
 soldier, tin ~ 309 52  
 sole *Agr. Mach.* 65 6, 66  
 sole *Shoem.* 100 66  
 sole *Joiner* 132 22  
 sole, cemented ~ 101 11  
 sole, corrugated ~ 300 43  
 sole, inner ~ 291 31  
 sole, natural-colour ~ 101 15, 38  
 sole, nylon ~ 291 30  
 sole, plastic ~ 101 2  
 sole, PVC ~ 101 2  
 sole, rubber ~ 101 38  
 sole, wooden ~ 101 45  
 sole bar reinforcement 213 12  
 sole leather 100 31  
 sole-leather shears 100 39  
 solenoid valve 139 23  
 sole of the foot 19 62  
 sole-plate *Household* 50 7  
 sole-plate *Road Constr.* 200 33  
 sole-plate *Railw.* 202 5  
 sole press, automatic ~ 100 14  
 sole stitcher 100 26  
 sole-stitching machine 100 26  
 sole trimmer 100 5  
 solid-fuel rocket, recoverable ~ 235 58  
 solidification 170 35, 43  
 solid-newel staircase 123 77  
 solid rocket booster 235 58  
 solids 347 30-46  
 solid stage 148 26  
 solid-web girder 121 72  
 solid-web girder bridge 215 7  
 solifluction lobe 11 51  
 solifluction tongue 11 51  
 soling 284 56  
 sollarer 329 55  
 solo machine 290 27  
 solo seat 189 19  
 solo skater 302 1  
 solstice 3 8  
 solution 345 10  
 solution, viscous ~ 169 15  
 solvent fumes 182 25  
 Somali Current 14 36  
 sombrero 35 5  
 songbirds 360 1,3,4,5,7,9,10; 361 1-20  
 song thrush 361 16  
 soot 38 34  
 sordino 323 10; 324 68  
 Soricidae 366 7  
 sort 174 7, 28  
 sorter 172 57  
 sorter, rotary ~ 172 23  
 sorter, secondary ~ 172 58  
 sorting machine 74 38  
 sorting siding 206 47  
 sorting table 64 81

sound assistant 117 68; 310 57  
 soundboard *Music. Instr.* 323 24; 324 3  
 soundboard *Church* 330 21  
 sound box 322 18, 29; 323 3; 324 15, 63  
 sound camera 117 22; 313 26  
 sound camera, Super-8 ~ 117 1  
 sound coding equipment 242 11-14  
 sound connecting cord 117 8  
 sound control console 238 20, 41, 54; 239 8  
 sound control desk 238 20, 41, 54; 239 8  
 sound control engineer 238 19  
 sound control room 238 27; 239 7  
 sound dubbing 311 34-36  
 sound echo 224 63  
 sound editor 117 96  
 sound effect 310 30  
 sound effects box 238 35  
 sound engineer 238 19  
 sound film 117 82  
 sound film cartridge, Super-8 ~ 117 29  
 sound head *Cine Film* 117 33  
 sound head *Audiovis.* 243 35  
 sound head *Films* 312 47  
 sound head housing 241 59  
 sound hole 322 22; 323 6; 324 5  
 sound impulse 224 62  
 sounding balloon 7 17  
 sounding board 330 21  
 sound mixer 238 26  
 sound mixing 311 34-36  
 sound module 240 14  
 sound OB van 239 1-15  
 sound optics 312 46  
 sound production control room 238 27; 239 7  
 sound projector 117 81; 312 24  
 sound recorder, portable ~ 310 24  
 sound recording 311 1-46  
 sound recording camera 310 60; 311 6  
 sound recording equipment 117 7  
 sound recording level control 243 11  
 sound recording selector switch 117 13  
 sound recordist *Broadcast.* 238 26  
 sound recordist *Films* 310 23, 55; 311 36  
 sound source 117 27  
 sound source, external ~ 117 8  
 sound technician 238 26  
 sound track *Cine Film* 117 82  
 sound track *Audiovis.* 243 32  
 sound track system 117 21  
 sound transmitter 224 61

sound turntable, first ~ 117 100  
 sound turntable, second ~ 117 101  
 sound wave 224 62  
 sound wave propagation 7 14  
 soup ladle 45 14  
 soup plate 44 6; 45 5  
 soup seasoning 98 30  
 soup tureen 44 8; 45 15  
 soup vegetable 68 25  
 source water inlet 155 2  
 sour cherry 59 5  
 souring chamber 159 6  
 sour milk vat 76 42  
 South America 14 13  
 South Equatorial Current 14 34  
 Southern Cross 3 44  
 Southern Ocean 14 22  
 Southern Triangle 3 40  
 south point 4 17  
 South Pole 14 3  
 southwester 35 30; 228 5  
 souvenir plate 309 48  
 sou'wester 35 30; 228 5  
 sow *Dom. Anim.* 73 9  
 sow *Livestock* 75 41  
 sow *Hunt.* 86 32  
 sow *Game* 88 48, 51  
 sow bug 81 6  
 sower 63 10  
 sowing 54 1; 63 10-12  
 sow pig 75 42  
 spa 274  
 space *Composing Rm.* 175 5, 17  
 space *Music. Not.* 320 44  
 space, popliteal ~ 16 51  
 spaceband 174 24  
 space bar 249 2  
 space capsule 6 9, 10; 234 65  
 spacecraft 6 1  
 space flight 234; 235  
 spaceflight module 235 70  
 Spacelab 235 65  
 space laboratory 235 65  
 spacer 119 81  
 Space Shuttle-Orbiter 235 1-45  
 space station 235 65  
 space suit 6 18-27  
 space suit helmet 6 22  
 spacing bracket 126 54  
 spacing clip 126 57  
 spacing lines 10 58  
 spacing material 174 8  
 spade 56 2; 331 36  
 spade *Fish Farm.* 89 82  
 spade *Army* 255 55  
 spade, semi-automatic ~ 56 12  
 spade piston 255 56  
 spades 276 39  
 spadix 370 71; 378 22  
 spadix, female ~ 384 6  
 spadix, male ~ 383 55; 384 4  
 spa gardens 274 1-21  
 spaghetti 98 32  
 spale 136 12  
 snale basket 136 11

span *Bridges* 215 14  
 span *Aircraft* 229 2  
 span, clear ~ 215 13  
 span, wire rope ~ 221 102  
 Spandau 255 32  
 Spanish chestnut 384 48  
 Spanish paprika 57 42  
 spanker 219 30  
 spanker boom 218 28; 219 44  
 spanker boom topping lift 219 48  
 spanker gaff 219 45  
 spanker peak halyard 219 49  
 spanker sheet 219 69  
 spanker vang 219 70  
 span of oxen 63 16  
 spa orchestra 274 20  
 spa promenade 274 10  
 spar 230 45  
 spar, diagonal ~ 287 33  
 spar, integral ~ 257 28  
 spar, main ~ 287 30  
 spar buoy 224 79  
 spar ceiling 222 62  
 spare man 291 11  
 spare part *Watchm.* 109 22  
 spare part *Garage* 195 32  
 spare rib 95 47  
 spare tyre *Lorries etc.* 194 4  
 spare tyre *Cyc. Racing* 290 23  
 spare wheel 191 25; 194 33  
 spar-hawk 362 12  
 spark arrester 210 24  
 spark gap 153 62  
 spark-ignition engine 190 1, 2  
 sparking plug 190 35; 242 48  
 spark plug 190 35; 242 48  
 spark-plug cap 188 27  
 Sparmannia 53 9  
 sparring partner 299 27  
 sparrow hawk 362 12  
 sparrow owl 362 19  
 spars 219 32-45  
 spatula *Dent.* 24 50  
 spatula *Hosp.* 25 7  
 spatula *Art. Studio* 338 15  
 spatula, plastic ~ 128 44  
 spawn 89 12  
 spawner 89 13  
 speaker *Living Rm.* 42 10  
 speaker *Election* 263 5  
 speaker *Hotel* 267 40  
 speaker *Disco* 317 15  
 speaker *Nightclub* 318 12  
 speaker, three-way ~ 241 14  
 speaking key 242 24  
 spear, long-bladed ~ 354 12  
 spear head, bronze ~ 328 21  
 spear thrower 352 40  
 special effects equipment 310 59  
 special offer 96 20; 271 65  
 specialty shop 195 1-55  
 specie 252 1-28  
 speciestaler 252 6  
 specimen insertion air lock 113 33  
 specimen stage adjustment 113 34  
 spectacle fitting 111 1-4

spectacle frame *Optics.* 111 5, 10-14  
 spectacle frame *Ship* 223 61  
 spectacle lens 111 15  
 spectacles 111 5, 9  
 spectator 308 29  
 spectator barrier 292 40  
 spectators' terrace *Airport* 233 20  
 'spectators' terrace' *Airport* 233 30  
 spectrograph 5 33  
 speculum, aural ~ 22 74  
 speculum, rectal ~ 23 19  
 speculum, vaginal ~ 23 13  
 speed ball 299 22  
 speed change lever 149 5  
 speed changer 241 29  
 speed code number 203 37  
 speed control 179 29  
 speed indicator 203 18  
 speed indicator, distant ~ 203 19  
 speedo 188 19, 34; 191 38, 74  
 speedometer *Motorcycles etc.* 188 19, 34, 40  
 speedometer *Motorcycle* 189 40  
 speedometer *Car* 191 38, 74  
 speedometer *Tram* 197 31  
 speedometer *Railw.* 211 35; 212 9  
 speedometer *Navig.* 224 54  
 speedometer, ship's ~ 224 22  
 speedometer drive 192 38, 39  
 speed recorder 210 54  
 speed restriction, permanent ~ 203 41, 42  
 speed restriction, temporary ~ 203 39, 40  
 speed restriction sign 203 36-38, 41, 44  
 speed restriction signs 203 36-44  
 speed restriction warning sign 203 43  
 speed selector 241 29  
 speed skate 302 20  
 speed skater 302 26  
 speed skating set 302 20  
 speedway 290 24-28  
 speedwell 375 22  
 speleothems 13 80-81  
 spelling book 260 17  
 spelt 68 24  
 spelt, green ~ 68 25  
 spencer 220 1  
 sperm whale 367 25  
 sphagnum mosses 13 20, 22  
 sphenoid 17 38  
 sphere 347 41  
 sphere, celestial ~ 4 23  
 sphere, plain ~ 36 82  
 sphere, solar ~ 4 36  
 spheres 36 82-86  
 sphere unit 2 38  
 spherical typing element 249 15  
 sphincter, anal ~ 20 63  
 sphinx *Fabul. Creat.* 327 20  
 sphinx *Articulates* 358 55

sphinx *Lepidopt.* 365 9  
 sphinx, Egyptian ~ 333 11  
 sphygmograph 26 32  
 sphygmomanometer 25 15  
 Spica 3 18  
 spice 99 67  
 spice jar 39 32  
 spice rack 39 31; 47 29  
 spices 382  
 spider legs 115 91  
 spiders 358 44-46  
 spider's web *Playground* 273 46  
 spider's web *Articulates* 358 47  
 spike *Arable Crops* 68 2  
 spike *Mountain.* 300 9  
 spike *Music. Instr.* 323 22  
 spike *Industr. Plants* 383 62, 66  
 spike, fleshy ~ 370 71  
 spike, racemose ~ 370 67  
 spikelet 68 3, 10; 69 23; 375 41, 42  
 spill light 310 51  
 spillway 217 60  
 spin *Roulette* 275 32  
 spin *Airsports* 288 7  
 spinach 57 29  
 spinal cord 17 48; 18 25  
 spindle *Watchm.* 109 17  
 spindle *Mach. Tools* 149 66; 150 27  
 spindle *Cotton Spin.* 164 43  
 spindle *Bookbind.* 183 22  
 spindle *Bicycle* 187 60, 80  
 spindle, horizontal ~ 150 40  
 spindle, main ~ 149 11  
 spindle, screwed ~ 149 66  
 spindle catch 164 49  
 spindle drive 164 31  
 spindle oil 145 61  
 spindle rail 164 50  
 spindle rotation speed 150 35  
 spindle shaft 164 46  
 spindle speed 164 38, 40  
 spindle top 126 32  
 spine *Man* 17 2-5  
 spine *Bookbind.* 183 14; 185 41  
 spine *Mammals* 366 6  
 spine label 247 38  
 spine of the book 183 1  
 spinet 322 45  
 spine tag 247 38  
 spinet piano 325 1  
 spinner *Fish Farm.* 89 74, 75  
 spinner *Aircraft* 230 33  
 spinner, long ~ 89 76  
 spinneret *Synth. Fibres* 169 14; 170 41  
 spinneret *Articulates* 358 46  
 spinneret hole 170 41, 42  
 spinning 170 57  
 spinning bath 169 15  
 spinning jet 169 14; 170 41, 42  
 spiraea 374 23  
 spiral *Photog.* 116 2  
 spiral *Airsports* 288 51  
 spiral *Gymn.* 297 50  
 spiral design pottery 328 13



spire 331 6  
 spirit glass 45 90  
 spirit lamp 24 57  
 spirit level *Map* 14 61  
 spirit level *Bldg. Site* 118 55  
 spirit level *Plumb. etc.* 126 79  
 spirit level *D.I.Y.* 134 29  
 spirits 98 56-59; 318 19  
 spirograph 27 36  
 Spirographis 357 22  
 spirometer 23 31  
 spirometry 27 36-50  
 spit *Phys. Geog.* 13 5  
 spit *Kitch. Utensils* 40 33  
 spitz 70 20  
 splashboard 186 6  
 spleen 20 12, 27  
 splenius of the neck 18 51  
 splice, wet ~ 117 89  
 splice graft 54 39  
 splice grafting 54 39  
 splicer 117 89  
 splicing cement 312 22  
 splicing head 133 29  
 splint *First Aid* 21 12  
 splint *Sawmill* 157 16  
 splint, emergency ~ 21 10  
 splint bone 17 24  
 splinter 157 16  
 split-image rangefinder 115 55, 59, 64  
 splits 314 20  
 splitter 94 17  
 splitting hammer 85 5  
 spoil 226 47  
 spoiler 229 39; 287 38  
 spoiler, front ~ 193 36  
 spoiler, inner ~ 229 42  
 spoiler, rear ~ 193 34; 290 35  
 spoiler rim 193 30  
 spoil heap 144 19  
 spoke *Mach. Parts etc.* 143 88  
 spoke *Bicycle* 187 27  
 spoke *Motorcycle* 189 24  
 spoke end 187 29  
 spoke flange 187 29  
 spoke nipple 187 29  
 spokeshave 132 27  
 spoke wheel 289 25  
 sponge *Bathrm. etc.* 49 6  
 sponge *School* 260 42  
 sponge *Graphic Art* 340 25  
 sponge *Invertebr.* 357 13  
 sponge holder 23 12  
 sponge tray 260 41  
 spool 162 55  
 spool box 312 16  
 spool box, fireproof ~ 312 25  
 spool holder 185 17  
 spool knob 114 27  
 spoon *Tablew. etc.* 45 61  
 spoon *Fish Farm.* 89 73  
 spoon, wooden ~ 40 2  
 spoon bait 89 73  
 spoon bit 135 16  
 spoon bow 285 30  
 spoon chisel 339 18  
 spore 381 8, 13  
 sporting coupé 193 28  
 sporting gun 86 4  
 sporting guns 87 1-40

sporting rifle 86 4  
 sporting rifles 87 1-40; 305 40-49  
 sport parachute 288 45  
 sports, various ~ 305  
 sportsboat, inflatable ~ 286 1  
 sportsboats *Rowing* 283 9-16  
 sportsboats *Motorboats etc.* 286 1-5, 10-14  
 sports news item 342 61  
 sports report 342 60  
 sports reporter 299 50  
 sports section 342 57  
 spot 276 32  
 spot, central ~ 115 65  
 spot, clear ~ 115 66  
 spot ball, white ~ 277 13  
 spotlight 307 3; 318 24  
 spotlight catwalk 310 53  
 spotted bruchus 81 19  
 spotted woodpecker 359 27  
 spotting position 297 16  
 spot welder, foot-operated ~ 142 29  
 spot welding 142 22  
 spot welding electrode holder 142 23  
 spout 91 14  
 spout, swivel-mounted ~ 64 37  
 spout hole 367 26  
 spray *Doc.* 22 60  
 spray *Pest Contr.* 83 8  
 spray boom 83 3  
 spray can 106 23  
 spray canister 83 44  
 spraydeck 283 56  
 sprayer *Gdn. Tools* 56 24  
 sprayer *Letterpress* 181 10, 34  
 sprayer, semi-mounted ~ 83 47  
 sprayer, tractor-mounted ~ 83 2  
 spray fluid tank 83 5, 50  
 spray gun *Pest Contr.* 83 18  
 spray gun *Painter* 129 32  
 spray gun *Letterpress* 181 34  
 spray gun, airless ~ 129 37  
 spraying 129 28  
 spraying tube 83 29  
 spray line, oscillating ~ 67 1  
 spray nozzle *Household* 50 13  
 spray nozzle *Intern. Combust. Eng.* 190 54  
 spray pipe 172 72  
 spray tank 83 39  
 spray tube 83 22  
 spray unit *Pest Contr.* 83 58  
 spray unit *Offset Platem.* 179 5, 6  
 spray unit, airless ~ 129 36  
 spreader *Paperhanger* 128 46  
 spreader *Ship* 223 37  
 spreader *Sailing* 284 13  
 spreader cylinder 62 23  
 spreader unit 62 22  
 spreading flap 200 42  
 spring *Map* 15 82  
 spring *Metalwkr.* 140 46  
 spring *Knitting* 167 38  
 spring *Carriages* 186 15

spring, artesian ~ 12 26  
 spring, rubber ~ 297 13  
 spring attachment 11 42  
 spring barrel 110 38  
 springboard *Swim.* 282 9, 10  
 springboard *Gymn.* 296 12; 297 8  
 springboard *Circus* 307 36  
 springboard acrobat 307 35  
 springboard artist 307 35  
 springboard trampoline 297 14  
 spring bolt 140 37  
 spring bow compass 151 64  
 spring buffer 214 50  
 spring bumper 214 50  
 spring chest 326 12-14  
 springer 336 22  
 spring extension 309 28  
 spring fly 358 12  
 spring form 40 27  
 spring pin tool 109 9  
 spring ring hinge 151 65  
 spring snowflake 60 1  
 spring suspension 83 7  
 spring tine 65 57  
 spring line, double ~ 64 42, 54  
 spring vice 140 10  
 spring washer 143 34; 202 8  
 sprinkler 55 19  
 sprinkler, oscillating ~ 56 46  
 sprinkler, revolving ~ 56 43; 62 29; 67 4, 32  
 sprinkler cart 62 27  
 sprinkler hose 62 30  
 sprinkler nozzle 67 27  
 sprinkler stand 62 28  
 sprinkler system 316 6  
 sprinkling can 51 21; 55 26  
 sprinkling device 55 19  
 sprinter 298 5  
 spritsail 218 43; 220 5  
 sprocket 143 90; 187 38, 74  
 sprocket piece 121 30  
 sprocket wheel 187 38  
 sprout *Veg.* 57 30  
 sprout *Bot.* 370 19-25  
 spruce 372 12  
 spruce cellulose 169 1  
 spruce cone 372 13  
 spruce fir 372 12  
 spruce-gall aphid 82 38  
 spruce needle 372 19  
 spur *Dom. Anim.* 73 26  
 spur *Game* 88 82  
 spur *Mountain.* 300 13  
 spurrey 69 12  
 spurs 71 50-51  
 spur vein 72 28  
 spur wheel, helical ~ 143 89  
 sputum 23 25  
 spyhole *Hall* 41 29  
 spyhole *Iron Foundry etc.* 148 4  
 squadron marking 256 2  
 square *Metalwkr.* 140 57  
 square *Maths.* 346 33; 347 31  
 square, black ~ 276 3  
 square, glazier's ~ 124 20  
 square, iron ~ 120 78  
 square, white ~ 276 2

squared timber store 157 32  
 square piano 325 40  
 square root 345 3  
 squash 57 23  
 squat 295 9  
 squat-style snatch 299 1  
 squat vault 296 53  
 squaw 352 10  
 squaw corn 68 31  
 squeegee *Photog.* 116 49  
 squeegee *Text. Finish.* 168 61  
 squeeze phase 75 34  
 squeeze roller 165 46  
 squirrel 366 19  
 squirrel's bread 381 16  
 stabilizer *Photog.* 116 10  
 stabilizer *Motorcycles etc.* 188 5  
 stabilizer *Railw.* 214 55  
 stabilizer *Navig.* 224 26  
 stabilizer *Air Force* 256 22  
 stabilizer *Winter Sp.* 301 49  
 stabilizer *Sports* 305 58  
 stabilizer, horizontal ~ 229 26; 230 62; 256 31; 288 23  
 stabilizer, vertical ~ 229 24; 230 59; 231 6; 232 7; 256 32; 288 21  
 stabilizer and rudder, vertical ~ 229 24-25; 230 58  
 stabilizer bar 192 71  
 stabilizing fin *Air Force* 256 22  
 stabilizing fin *Swim.* 279 3  
 stabilizing fin, aerodynamic ~ 234 7  
 stabilizing layer 301 49  
 stabilizing panel 288 49  
 stabilizing surface 256 22  
 stabilizing wing 117 60  
 stable 62 2; 75 1  
 stable fly 81 4  
 stableman 186 27  
 staccato 321 34  
 stack *Forestry* 84 15  
 stack *Univ.* 262 11  
 stack bearer 157 37  
 stacker, intermediate ~ 236 34  
 stacker truck 159 18  
 stacking machine 162 20  
 stack of logs 84 16  
 stalk 320 43-44  
 staff compartment 207 81  
 staff lavatory 207 82  
 staff toilet 207 82  
 staff washroom 207 26  
 staff WC 207 82  
 stag, rutting ~ 86 12; 88 4  
 stag beetle 358 24  
 stag call 87 46  
 stage *Films* 312 8  
 stage *Theatre* 315 14-27, 14  
 stage *Nightclub* 318 22  
 stage, mechanical ~ 112 10, 29; 115 98  
 stage, microscopic ~ 112 9  
 stage, revolving ~ 316 31  
 stage, universal ~ 112 17  
 stage base 112 15  
 stage carpenter 316 45  
 stagecoach 186 39

stagecoach, English ~ 186 53  
 stage curtain 312 10  
 stage designer 315 37  
 stage director 316 30  
 stagehand 315 28; 316 46  
 stagehouse 316 1-60  
 stage light 316 14  
 stage lighting 318 23  
 stage lighting unit 316 14  
 stage manager 316 30  
 stage plate 115 95  
 stage rehearsal 315 21-27  
 stage separation retro-rocket 234 8  
 staghorn 377 12  
 stag horn moss 377 12  
 staghound 289 47  
 staging *Photograv.* 182 12  
 staging *Shipbuild.* 222 18  
 stag jump 295 40; 302 7  
 stag leap 295 40; 302 7  
 stag's horn 377 12  
 stag's horn moss 377 12  
 staining dish 23 50  
 staining vat 130 15  
 staircase 37 72; 118 22  
 staircase, dog-legged ~ 123 42-44  
 staircase, outside ~ 333 33  
 staircase, quarter-newelled ~ 123 75  
 staircase, spiral ~ 123 76, 77  
 staircase, winding ~ 123 76, 77  
 staircase bolt 123 46  
 staircase construction 123  
 staircase of locks 217 17-25  
 staircase window 37 81; 123 65  
 stair light 41 22  
 stairs, concrete ~ 123 16  
 stair well 120 46  
 stake *Wine Grow.* 78 7  
 stake *Forestry* 84 17  
 stake *Plumb.* 125 23  
 stake *Basketm.* 136 6  
 stake *Roulette* 275 13  
 stake net 89 94  
 stalactite 13 80, 82  
 stalactite vault 337 17  
 stalagmite 13 81, 82  
 stalk 58 13, 34, 61; 68 6; 370-20; 378 31  
 stalk, herbaceous ~ 384 30  
 stalking 86 1-8  
 stall 75 2  
 stallion 73 2  
 stalls, front ~ 315 19  
 stall turn 288 4  
 stamen 58 45; 59 10, 39; 370 57, 60; 372 7, 18; 373 2, 5; 374 3  
 stamp *Doc.* 22 29  
 stamp *Slaughterho.* 94 24  
 stamp *Post* 236 21, 61  
 stamp *Bank* 250 24  
 stamp, impressed ~ 252 35  
 stamp book 236 20  
 stamp counter 236 15  
 stanchion 221 117  
 stanchion, hinged ~ 213 6

stanchion, steel ~ 213 6  
 stand *Hosp.* 25 11; 26 9, 29  
 stand *Overh. Irrign.* 67 2  
 stand *Shoem.* 100 54  
 stand *Optic.* 111 5  
 stand *Optic. Instr.* 112 2  
 stand *Basketm.* 136 10  
 stand *Composing Rm.* 175 50  
 stand *Photomech. Reprod.* 177 29  
 stand *Motorcycles etc.* 188 51  
 stand *Circus* 307 57  
 stand *Bullfight, etc.* 319 8  
 stand, hydraulic ~ 310 50  
 stand, raised ~ 86 14, 14-17  
 standard *Bldg. Site* 119 47, 59  
 standard *Forging* 139 19  
 standard *Photomech. Reprod.* 177 11  
 standard adjustment 114 51  
 standard lamp 46 37  
 Standard meridian 14 5  
 standard of the German Federal President 253 14  
 standby drive 214 64  
 standing-in position 297 16  
 standing matter 174 11  
 standing matter rack 174 9  
 standing position 305 27  
 standing press 183 20  
 standing room portion 197 18  
 standing stone 328 18  
 standing take-off pike dive 282 40  
 standing type 174 11  
 standing type rack 174 9  
 standing wrestling 299 6  
 standpipe *Farm Bldgs.* 62 12  
 standpipe *Oil, Petr.* 145 13  
 standpipe *Paperm.* 173 12  
 standpipe *Space* 234 25  
 standpipe *Fire Brig.* 270 26  
 standpipe coupler 67 5  
 stapelia 53 15  
 staple fibre 169 1-34  
 staple fibre lap 169 31  
 staple fibre, viscose rayon ~ 169 28-34  
 staple fibre layer 169 31  
 staple length 170 60  
 stapler 22 25; 247 4  
 staple shaft 144 27  
 stapling machine 247 4  
 star *Sailing* 284 55  
 star *Films* 310 27, 28  
 star, binary ~ 3 29  
 star, circumpolar ~ 3 5  
 star, double ~ 3 29  
 star, principal ~ 3 9  
 star, variable ~ 3 11  
 star connection 153 20  
 star finch 360 3  
 starfish 357 38; 369 17  
 starling 361 4  
 star map 3 1-35  
 star network 153 20  
 stars, fixed ~ 3 9-48  
 Stars and Stripes 253 18  
 Star-Spangled Banner 253 18  
 start *Motorboats etc.* 286 28, 29



start *Athletics* 298 1-6, 3  
 starter 282 30  
 starter, electric ~ 56 39  
 starter and steering lock 191 75  
 starter battery 212 46  
 starter button, electric ~ 189 52  
 starter motor *Intern.*  
   *Combust. Eng.* 190 44  
 starter motor *Railw.* 212 30  
 starter pedal 188 25  
 starter's flag 273 34  
 starter switch 241 30  
 starting and braking device, automatic ~ 168 20  
 starting and finishing buoy, 285 14  
 starting and stopping handle 166 8  
 starting and stopping lever 165 17; 180 80; 181 32  
 starting block *Swim.* 282 27  
 starting block *Athletics* 298 1  
 starting dive 282 29  
 starting gear ring 192 31  
 starting handle 163 17  
 starting lever 178 20  
 starting line 286 30  
 starting motor 190 44  
 starting place 282 27  
 starting position 295 1  
 starting price 289 37  
 starting resistance 135 3  
 starting resistor 135 3  
 starting rod 167 22  
 starting signal 205 47  
 start print button 249 38  
 start-stop lever 163 40  
 star wheel *Mach. Tools* 149 43  
 star wheel *Graphic Art* 340 39  
 Stassfurt salt 154 66  
 Stassfurt seam 154 65  
 stately home 15 96  
 statement of account 247 44  
 state of play 293 38  
 static air tank 196 19  
 station, coastal ~ 237 53  
 station, lower ~ 214 39  
 station, top ~ 214 57  
 station, upper ~ 214 57  
 stationary rings 296 4  
 station bookstall 204 26  
 station bookstand 204 26  
 station clock 204 30  
 station foreman 205 41  
 station hall 204  
 station mailbox 204 11  
 station of the Cross 330 54  
 station platform 205  
 station post box 204 11  
 station preset button 241 4; 243 17; 309 20  
 station restaurant 204 13  
 station selector button 241 4; 243 17; 309 20  
 station sign 205 28  
 station wagon 193 15  
 statistics chart 248 36  
 statue 215 22; 272 10; 334 5; 339 32

statue, stone ~ 272 2  
 statuette, ivory ~ 328 8  
 stave *Cooper* 130 2  
 stave *Music. Not.* 320 43-44  
 stay 219 10  
 stay, triatic ~ 223 11  
 stayer 290 14  
 stay pole 152 31  
 stay rope 299 37  
 stay-warm plate 28 28  
 stay wire 296 10; 297 5; 299 37  
 St. Bernard dog 70 37  
 steady, fixed ~ 150 30  
 steam 50 11  
 steam and recirculation water flow path 154 51  
 steam boiler 152 5  
 steam chest 210 31  
 steam collector 210 21  
 steam coupling hose 208 20  
 steam dome 210 12  
 steam extraction 103 26  
 steam extractor 103 25  
 steam-generating station 152 1-28  
 steam generator 154 9, 26, 44  
 steam heater 172 38  
 steam hole 50 14  
 steaming light 223 40; 258 55  
 steaming light mast 221 51  
 steam iron 103 20; 131 3  
 steam line 154 11  
 steam locomotives 210 1-69  
 steam pipe 172 64  
 steam pipe, high-pressure ~ 259 63  
 steam press 104 26  
 steam pressing unit 104 26  
 'steam radio' 309 16  
 steam reversing gear 210 18  
 steam slit 50 14  
 steam spray gun 131 2  
 steam sterilizer 22 39  
 steam storage locomotive 210 68  
 steam trawler 221 46  
 steam tube 210 17  
 steam turbine 152 23; 153 23-30; 154 14, 46, 52  
 steam turbine generator 259 58  
 steel 94 16  
 steel, finished ~ 148 68  
 steel bender 119 21  
 steel-casting ladle 147 31  
 steel grit delivery pipe 148 38  
 steel ingot 147 33  
 steel lattice bridge 215 34  
 steel-leg vice 126 80  
 steel-wheel glass cutter 124 26  
 steelworks 147 21-69  
 steep face 12 43  
 steeping 169 4  
 steeping floor 92 8, 28  
 steeping tank 92 8  
 steeple 331 2  
 steeplechase *Equest.* 289 20-22  
 steeplechase *Athletics* 298 7-8

steep liquor 92 6  
 steering, hydraulic power ~ 65 41  
 steering alignment 195 17, 22  
 steering alignment, visual ~ 195 41  
 steering and control position 224 14  
 steering arm 192 79  
 steering axle 64 32  
 steering column 192 56  
 steering column, controlled-collapse ~ 191 57  
 steering drop arm 192 58  
 steering gear 192 56-59  
 steering head 187 11  
 steering line *Rowing* 283 52  
 steering line *Airports* 288 41  
 steering oar 218 6  
 steering rudder 283 51-53  
 steering runner 302 45  
 steering system, rear-wheel ~ 64 39  
 steering tube 187 14  
 steering wheel 191 37; 305 89  
 steering wheel spoke 191 58  
 steersman *Ship* 218 2  
 steersman *Winter Sp.* 303 20  
 stein 309 53  
 steinbock 367 7  
 Steinheim man 261 17  
 stela 330 43; 334 33  
 stela 330 43; 334 33  
 stem *Forestry* 84 19  
 stem *Tobacc. etc.* 107 38  
 stem *Metalwkr.* 140 33  
 stem *Ship* 218 4; 221 14, 83, 108; 258 3  
 stem *Chem.* 350 7  
 stem *Bot.* 370 2  
 stem *Edib. Fungi* 381 18  
 stem, bulbous ~ 222 74  
 stem, prostrate ~ 58 20  
 stem, straight ~ 285 40  
 stem, wire ~ 325 29  
 stem cutting 54 25  
 stemless alpine gentian 378 13  
 stemming sand bucket 158 29  
 stem post 218 4  
 stem rudder 218 24  
 stem stitch 102 4  
 stencil ejection 245 9  
 stencil knife 129 43  
 stencil lettering guide 151 69  
 stencil magazine, vertical ~ 245 8  
 stencil storage drawer 245 10  
 stenography 342 13  
 steno pad 245 29; 248 32  
 stenter 165 54; 168 21  
 stenter clip 168 24  
 stenter pin 168 24  
 step *Roof & Boilerr.* 38 27  
 step *Hall* 41 24  
 step *Carriages* 186 13  
 step *Tram* 197 15  
 step *Aircraft* 230 42  
 step *Swim.* 281 32, 37  
 step *Mountain.* 300 17  
 step, bottom ~ 123 18, 42

step, top ~ 123 19  
 step, wedge-shaped ~ 123 31  
 step bearing 91 10  
 step-cut, hexagonal ~ 36 62  
 step-cut, octagonal ~ 36 52  
 step-cut, rectangular ~ 36 50  
 step-cut, rhombus ~ 36 59  
 step-cut, round hexagonal ~ 36 64  
 step-cut, square ~ 36 51  
 step-cut, trapezium ~ 36 57  
 step-cut, triangular ~ 36 60-61  
 step fault 12 8  
 step irons 269 28  
 stepladder 50 35; 126 2; 129 5  
 steppe zone 9 54  
 stepping stones 37 45  
 steps *Dwellings* 37 39  
 steps *Household* 50 35  
 steps *Station* 204 25; 205 2  
 steps *Circus* 307 20  
 steps, front ~ 37 66  
 steps, wooden ~ 38 25  
 stereobate 334 4  
 stereo cassette deck 241 33  
 stereo component system, three-in-one ~ 241 52  
 stereo effect 310 30  
 stereo equipment 42 9; 317 22-23  
 stereo microphone jack 241 65  
 stereo microphone socket 241 65  
 stereomicroscope, wide-field ~ 112 61  
 stereoplanigraph 14 66  
 stereo receiver 241 52  
 stereoscope 14 64  
 stereo sound 311 35  
 stereo speakers 241 13-14  
 stereo system 42 9; 241 13-48; 317 22-23  
 sterilization room 26 34-54  
 sterilizer 76 12  
 sterilizer, small ~ 26 35  
 stern 222 66-72; 258 26; 285 29  
 stern, elliptical ~ 218 25  
 stern, gilded ~ 218 55-57  
 stern, lower ~ 218 58  
 stern, round ~ 218 25  
 stern, square ~ 285 43  
 stern, upper ~ 218 55  
 sterncastle 218 23  
 stern fender 227 29  
 stern frame 222 70-71  
 stern gallery 218 56  
 stern light 258 62  
 stern light, white ~ 286 14  
 stern loading door 221 31  
 stern opening 221 55; 226 18  
 stern port 221 55; 226 18  
 stern post 218 1  
 stern ramp 221 88; 258 91  
 stern towing point 221 53  
 sternum 17 8  
 stethoscope 23 35  
 stetson hat 319 37  
 steward *Ship* 221 110

steward *Election* 263 10  
 steward *Cyc. Racing* 290 4  
 stick 322 35; 323 14, 56  
 stick, forked ~ 54 13  
 stick, French ~ 97 12  
 stick blade 302 32  
 sticker *Slaughterho.* 94 14  
 sticker *Music. Instr.* 325 30; 326 9  
 stick handle 302 31  
 sticking knife 94 14  
 sticking paper 260 50-52  
 sticking plaster 21 7; 22 55  
 stiffener 215 53  
 stiffening 101 37  
 stifle 72 33  
 stifle joint 72 33  
 stigma *Soft Fruit* 58 41  
 stigma *Drupes & Nuts* 59 16  
 stigma *Articulates* 358 32  
 stigma *Bot.* 370 56  
 stile *Roof & Boilerr.* 38 16  
 stile *Household* 50 36  
 stile *Carp.* 120 25  
 stile *Roof* 121 40  
 stiletto 102 12  
 stiletto beard 34 13  
 stiletto heel 101 28  
 stillhunting 86 1-8  
 stilling basin 217 61  
 stilling box 217 61  
 stilling pool 217 61  
 still life group 338 27  
 stilt 359 19  
 stilt bird 359 19  
 stilt plover 359 19  
 stilts 308 49  
 stimulants 382  
 sting 77 11  
 stinging nettle 61 33  
 stinging organs 77 10-14  
 sting sheath 77 12  
 stinkweed 379 8  
 stipe 381 18  
 stipple paint 129 53  
 stippler 129 18  
 stippling roller 129 13  
 stipule 57 5; 58 48; 371 73  
 stirrer *Dairy.* 76 43  
 stirrer *Paperm.* 172 47  
 stirrer *Chem.* 349 18  
 stirrup *Horse* 71 43  
 stirrup *Bldg. Site* 119 70  
 stirrup iron 71 43  
 stirrup leather 71 42  
 stitch, flat ~ 102 10  
 stitch, knotted ~ 102 13  
 stitch, ornamental ~ 102 3  
 stitch, overcast ~ 102 8  
 stitch, Russian ~ 102 9  
 stitching 183 8, 34  
 stitching, decorative ~ 31 5  
 stitching machine 100 21  
 stitching wire feed mechanism 184 18  
 stock *Plant Propagn.* 54 33  
 stock *Hunt.* 87 3, 4, 6, 13  
 stock *Mills* 91 2  
 stock *Joiner* 132 24  
 stock *Paperm.* 173 1, 2-10  
 stock *Stock Exch.* 251 1-10

stock *Stock Exch.* 251 11-19  
 stock, round ~ 139 1  
 stock, square ~ 143 9  
 stockbroker, sworn ~ 251 4  
 stock certificate 251 11  
 stock chest 172 85; 173 1  
 stock cube 98 26  
 stock exchange 251 1-10  
 stock exchange agent 251 7  
 stock exchange attendant 251 9  
 stocking 99 26; 318 32  
 stocking, knee-high ~ 32 9  
 stockjobber 251 6  
 stock ledger 251 14  
 stock list 250 8  
 stock preparation plant 172 79-86  
 stocks 222 11-26  
 stock saddle 71 37-44  
 stogy 101 39  
 stoker, travelling-grate ~ 152 3  
 stola 355 9  
 stole, fur ~ 318 30  
 stollen 97 11  
 stomach *Man* 16 35-37; 20 13, 41-42  
 stomach *Bees* 77 16  
 stomatid 369 10, 13  
 stone *Agr.* 63 9  
 stone *Mills* 91 21  
 stone *Clocks* 110 33  
 stone *Quarry* 158 8  
 stone *Swim.* 281 22  
 stone *Sculpt. Studio* 339 5  
 stone *Shrubs etc.* 374 12  
 stone, crushed ~ 158 24  
 stone, dressed ~ 158 30  
 stone, lower ~ 91 23  
 Stone Age idol 328 8  
 stone block 339 5  
 stone catcher 64 9  
 stone chippings 158 23  
 stonecrop 51 7; 61 17; 375 21  
 stone-crushing plant 158 18  
 stone-dressing device 172 70  
 stone fruit 59 41, 43, 49; 370 99  
 stone lithography 340 25-26  
 stone marten 367 14  
 stonemason 158 34  
 stonemason's tools 158 35-38  
 stone pine 372 55  
 stones, faceted ~ 36 42-71  
 stone spreader 200 31  
 stone trap 64 9  
 stool 24 14; 27 50; 260 58  
 stop *Bookbind.* 185 11  
 stop *Railw.* 214 35  
 stop *Music. Instr.* 325 44; 326 6  
 stop *Chem.* 349 37  
 stop and start lever 163 31  
 stop and tail light 189 9  
 stop and tail light unit 188 38  
 stop bar 133 11  
 stop bath 116 10  
 stop board 203 25, 33  
 stop boards 203 31-32  
 stop button *Clocks* 110 22



stop button *Office* 249 73  
 stopclock 238 62  
 stopclock, electronic ~ 238 31  
 stopclock *Plumb. etc.* 126 4  
 stopclock *Gas Weld.* 141 7  
 stopclock *Water* 269 48  
 stopcock, flange-type ~ 130 21  
 stop-cylinder machine 181 20  
 stop-cylinder press 181 20  
 stop fillet 119 62  
 stop key 243 43  
 stop knob *Music. Instr.* 325 44; 326 6  
 stop knob *Chem.* 349 38  
 stop lever 324 42  
 stop line 268 50  
 stop motion 166 43  
 stop-motion device 168 19  
 stopper *Overh. Irrign.* 67 36  
 stopper *Iron & Steel* 147 31  
 stopper *Music. Instr.* 326 35  
 stopper *Chem.* 350 44  
 stopper, ground glass ~ 349 4  
 stopper, octagonal ~ 349 4  
 stopping device 168 19  
 stopping handle 164 6, 32  
 stopping point 203 25, 31-32  
 stop plate 157 18  
 stop rod blade 166 43  
 stops 342 16-29  
 stop signal 203 1  
 stop signal, electric ~ 203 3  
 stop signals 203 1-6  
 stop tab 326 39  
 storage area 246 5  
 storage bin 200 35  
 storage box *Child. Rm.* 47 2  
 storage box *D.I.Y.* 134 34, 39  
 storage cell 77 35  
 storage chamber 154 71, 76  
 storage container 130 17  
 storage cupboard 207 27  
 storage door 39 6  
 storage reservoir 217 57  
 storage shelf 174 10  
 storage siding 206 50  
 storage tank *Brew.* 93 13  
 storage tank *Oil, Petr.* 145 72  
 storage tank *Papern.* 172 17, 41, 45, 46  
 storage tank *Docks* 225 72  
 storage tank gauge 76 10  
 storage unit *Dent.* 24 8  
 storage unit *Composting Rm.* 176 11  
 storage unit *Inf. Tech.* 242 9  
 storage vessel 10 46  
 store area 5 17  
 storehouse 329 13  
 storekeeper 98 41  
 store room 223 57  
 storey roof 337 2  
 storm front 287 24  
 storm-front soaring 287 23  
 storm lantern 278 29  
 storm signal 225 35; 280 4  
 stout 93 26  
 stove, cylindrical ~ 309 4  
 stove, tiled ~ 266 34  
 stove bench 266 36

stove door 309 7  
 stovepipe 309 5  
 stovepipe elbow 309 6  
 stove screen 309 8  
 stove tile 266 35  
 stowage 227 26; 228 27  
 straddle 298 23  
 straddle jump 298 23  
 straddle position 296 30  
 straddle seat 295 18  
 straight ball 305 17  
 straightedge *Paperhanger* 128 39  
 straightedge *Metalwkr.* 140 56  
 straightedge rule 179 26  
 straight hang 296 38  
 straight header 282 12  
 straight inverted hang 296 37  
 straight thrust 294 7  
 strainer *Papern.* 172 54  
 strainer *Water* 269 32  
 strainer, basket ~ 67 12  
 strainer, rotary ~ 172 23  
 strain insulator 152 38  
 strait 14 24  
 Strait of Gibraltar 14 24  
 straits bridge 215 57  
 strake, outside ~ 285 50  
 stramonium 379 8  
 stramony 379 8  
 strampler 29 23  
 strand 162 54  
 strand of fruit 384 8  
 strand of moulds 147 36  
 strap *Clocks* 110 5  
 strap *Bldg. Site* 119 60, 65  
 strap *School* 260 11  
 strap *Cyc. Racing* 290 22  
 strap *Winter Sp.* 301 3  
 strap hinge 140 51  
 strap support 286 59  
 stratification 12 1  
 stratocumulus 8 3  
 stratosphere 7 8  
 stratosphere aircraft 7 15  
 stratovolcano 11 15  
 stratum, impermeable ~ *Phys. Geog.* 12 28  
 stratum, impermeable ~ *Water* 269 36  
 stratum, impervious ~ *Phys. Geog.* 12 28  
 stratum, impervious ~ *Water* 269 36  
 stratum, porous ~ 12 29  
 stratum, water-bearing ~ *Phys. Geog.* 12 22  
 stratum, water-bearing ~ *Water* 269 2, 38  
 stratus 8 4  
 straw *Agr.* 63 34, 36  
 straw *Livestock* 75 7  
 straw *Baskem.* 136 30  
 straw *Station* 206 23  
 straw *Restaurant* 266 46  
 straw baler 63 35  
 strawberry 58 21  
 strawberry flan 97 22  
 strawberry plant 58 16  
 straw fiddle 324 61  
 straw hive 77 52

straw press 63 35  
 straw shaker 64 14  
 strawwalker 64 14  
 straw yard system 74 1-17  
 stream *Phys. Geog.* 13 8  
 stream *Map* 15 80  
 stream *Park* 272 45  
 stream, subglacial ~ 12 52  
 stream, underground ~ 269 3  
 streamer 253 9  
 streamer, paper ~ 306 66  
 streamlining, integrated ~ 189 44  
 street 37 61; 198 13  
 street, cross-section of a ~ 198  
 street café 268 59  
 streetcar 197; 268 46  
 streetcar schedule 268 27  
 streetcar service 197 13  
 streetcar stop 268 25  
 streetcar stop sign 197 36; 268 26  
 streetcar track 268 23  
 street cleaner 199 41; 304 8  
 street cleaning 199  
 street-cleaning lorry 199 41; 304 8  
 street corner 198 12  
 street lamp 37 62; 268 6  
 street lamp, suspended ~ 268 49  
 street light 37 62; 268 6  
 street map 204 15; 268 2  
 street sign 268 7  
 street sweeper 199 5; 268 20  
 stretcher *Fire Brig.* 270 23  
 stretcher *Rowing* 283 47  
 stretcher, emergency ~ 21 23  
 stretcher, wedged ~ 338 20  
 stretcher bar 202 29  
 stretch girdle 32 5  
 stretching 170 46, 55  
 stretching, final ~ 170 47  
 stretching, preliminary ~ 170 45  
 stretching bond 118 59  
 stretching course 118 63  
 stretching machine 100 18  
 streusel cake 97 35  
 streusel slice 97 43  
 stridulating apparatus 81 8  
 stridulating mechanism 81 8  
 strike *Phys. Geog.* 12 2  
 strike *Composing Rm.* 175 37  
 striker *Hunt.* 87 21  
 striker *Ball Games* 291 15  
 striker pad 255 47  
 striking circle 292 16  
 striking force control 249 10  
 striking mechanism 325 3  
 striking of coins 252 40-44  
 striking surface *Tobacc. etc.* 107 24  
 striking surface *Ball Games* 293 31  
 striking weight 110 28; 309 60  
 string *Roof & Boilerr.* 38 26  
 string *Sports* 305 59  
 string *Music. Instr.* 322 44, 55; 323 9, 61; 325 7

string, catgut ~ 324 6, 14  
 string, chalked ~ 128 45  
 string, fretted ~ 324 24  
 string, gut ~ 324 6, 14  
 string, nylon ~ 324 14  
 string, open ~ 324 25  
 string, outer ~ 123 44  
 string, stopped ~ 324 24  
 string, unfretted ~ 324 25  
 string, wreathed ~ 123 49  
 string briefs 32 23  
 string course 335 52  
 stringed instruments 323 1-27; 324 1-31  
 stringer *Roof & Boilerr.* 38 26  
 stringer *Shipbuild.* 222 50  
 stringer *Aircraft* 230 47, 57  
 stringer *Sailing* 285 55  
 stringer, outer ~ 123 44  
 string fastener 324 4  
 string holder 324 4, 13  
 strings 293 31  
 string vest 32 22  
 strip 148 66-75  
 stripe, magnetic ~ 117 82  
 striped hyena 368 1  
 strip flooring 123 62  
 stripper *Paperhanger* 128 1, 9  
 stripper *Nightclub* 318 27  
 stripping 89 11  
 stripping knife 128 15; 134 37  
 stripping table 179 23  
 strip steel 143 11  
 striptease act 318 27-32  
 striptease artist 318 27  
 striptease number 318 27-32  
 strip window 37 86  
 strobile 376 19  
 stroke *Rowing* 283 12  
 stroke *Music. Not.* 320 6  
 stroke, plain ~ 277 2  
 strokes 136 1-4  
 stroller 28 37  
 strong beer 93 26  
 strong man 308 27  
 strong room 250 11  
 structural parts of ship 222 44-61  
 structural system, Gothic ~ 335 27-35  
 structure, geological ~ 154 57-68  
 structure, longitudinal ~ 222 44-56  
 structures, molecular ~ 1 9-14  
 strut *Bldg. Site* 119 63, 67  
 strut *Carp.* 120 27, 54  
 strut *Roof* 121 58, 69, 82  
 strut *Ship* 223 61  
 strut *Aircraft* 229 11  
 strut *Rowing* 283 46  
 strut *Winter Sp.* 303 5  
 strut, diagonal ~ *Bldg. Site* 118 88  
 strut, diagonal ~ *Bridges* 215 4  
 stub 84 14  
 stub axle 192 78  
 stubble beard 34 23  
 stubble field 63 33  
 stub wing 232 3  
 stud *Carp.* 120 25

stud *Roof* 121 40  
 stud *Mach. Parts etc.* 143 22  
 stud, ornamental ~ 253 8  
 stud, rubber ~ 187 84  
 stud, screw-in ~ 291 28  
 student 262 9, 10  
 student input device 242 4  
 student response device 242 4  
 studio *Broadcast.* 238 18  
 studio *Art. Studio* 338 1-43  
 studio, artist's ~ 338  
 studio, sculptor's ~ 339  
 studio apartment 37 74  
 studio complex 310 1-13  
 studio easel 338 3  
 studio electrician 310 37  
 studio flat 37 74  
 studio lot 310 1  
 studio microphone *Broadcast.* 238 34  
 studio microphone *Films* 310 31  
 studio skylight 338 1  
 studio table 238 29  
 studio window 238 38  
 study in oils 338 36  
 study step counter 242 5  
 stuff 173 1, 2-10  
 stuff box 173 11  
 stuff chest 172 85, 86; 173 1, 13  
 stuffing box *Oil, Petr.* 145 26  
 stuffing box *Railw.* 210 33  
 stuffing box *Ship* 223 64  
 stuff preparation plant 172 79-86  
 stump 84 14  
 stump of tooth 24 27  
 stunner, electric ~ 94 7  
 stunning device 94 3  
 stupa 337 21, 28  
 Stuttgart Planetarium 5 17-28  
 sty 62 8  
 style 58 42; 59 15; 68 34; 370 55; 373 5; 378 5  
 style jump 288 50-51  
 styling scissors 106 34  
 stylobate 334 32  
 stylus 341 25  
 stylus, conical ~ 241 26  
 stylus, elliptical ~ 241 26  
 stylus, steel ~ 341 21  
 stylus force control 241 24  
 stylus pressure control 241 24  
 sub-base course, bituminous ~ 198 2  
 sub-base course, gravel ~ 200 60  
 sub-base course, hardcore ~ 200 60  
 subcontra octave 321 42  
 sub-drainage 200 61  
 subfloor 123 38, 73  
 subgrade grader 201 1  
 sub-machine gun 255 8  
 submarine 258 64  
 substation, outdoor ~ 152 29-35  
 substitute 291 54; 292 39  
 substitute flags 253 30-32  
 substitute signal 203 6  
 substructure *Oil, Petr.* 145 2

substructure *Offshore Drill.* 146 38  
 subtitle 185 47  
 subtracting 344 24  
 subtraction 344 24  
 subtrahend 344 24  
 succory 57 40; 376 25  
 sucker *House Insects etc.* 81 37  
 sucker *Optich.* 111 23  
 sucker *Invertebr.* 357 21  
 sucker rod 145 25  
 sucking organ 358 17  
 suction 162 25, 28, 36  
 suction apparatus *Dent.* 24 11  
 suction apparatus *Poultry Farm* 74 41  
 suction box *Poultry Farm* 74 41  
 suction box *Cotton Spin.* 164 44  
 suction box *Papern.* 173 15  
 suction control 50 72  
 suction control, fingertip ~ 50 74  
 suction control, sliding ~ 50 74  
 suction dredger 216 59  
 suction electrode 23 29  
 suction feeder 180 72  
 suction head 217 51  
 suction hose *Household* 50 75  
 suction hose *Fire Brig.* 270 67  
 suction hose, soft ~ 270 30  
 suction pipe *Roof & Boilerr.* 38 55  
 suction pipe *Docks* 226 32  
 suction pipe *Water* 269 5, 14, 41  
 suction pipe *Theatre* 316 52  
 suction pipe, trailing ~ 216 59  
 suction port 199 43  
 suction pump 216 62  
 suction roll 173 16  
 suction slot 168 43  
 suction tube 10 37  
 sugar 98 53-55  
 sugar, confectioner's ~ 98 54  
 sugar, refined ~ 98 55  
 sugar beet 68 44  
 sugar beet eelworm 80 51  
 sugar bowl 44 32; 265 20  
 sugar cane 382 52  
 sugar loaf 99 64  
 suit, asbestos ~ 270 46  
 suit, casual ~ 33 17  
 suit, denim ~ 31 58; 33 20  
 suit, extra-vehicular ~ 6 18-27  
 suit, jersey ~ 29 17  
 suit, men's ~ 33 1  
 suit, one-piece ~ 29 17  
 suit, quilted ~ 29 38  
 suit, single-breasted ~ 33 1  
 suit, two-piece ~ 29 12  
 suitcase 194 19; 204 6; 205 7  
 suitcase, light ~ 267 15  
 suitcase, lightweight ~ 267 15  
 suite, upholstered ~ 42 21-26  
 suiting 104 3  
 suits 276 38-45



suits, German ~ 276 42-45  
 suit trousers 33 3  
 sulfate *see* sulphate  
 sulfide *see* sulphide  
 sulfur *see* sulphur  
 sulfuric *see* sulphuric  
 sulky 289 24  
 sulphate pulp mill 172 1-52  
 sulphur 351 23  
 sulphur-crested cockatoo 363 1  
 sulphuric acid 170 23, 24  
 sulphuric acid, production of ~ 156 34  
 sulphuric acid supply 156 33  
 sultana 98 8  
 sum 344 23  
 Sumatra cigar 107 2  
 summer 121 67  
 summer beam 121 67  
 summer blouse 31 22  
 summer coat 31 20  
 summer dike 216 48  
 summer dress 31 9  
 summerhouse 52 14  
 summer quarters, animals' ~ 356 11  
 summer slacks 31 52  
 summer solstice 3 8  
 summer wear 31  
 summit 12 40  
 sump *Coal* 144 47  
 sump *Intern. Combust. Eng.* 190 41  
 sump filter 192 18  
 sun 4 10-21, 29, 36-41, 42  
 sun bather 281 12  
 sunbathing area *Dwellings* 37 46  
 sunbathing area *Spa* 274 12  
 sunbathing area *Swim.* 281 11; 282 4  
 sun bed 281 5  
 sun blind 37 71  
 sun canopy 274 14  
 sun deck 223 22  
 sundew 377 14  
 sundial 110 30  
 sun disc, winged ~ 333 12  
 sundress, child's ~ 29 13  
 sun filter 6 22  
 sunflower 51 35; 52 7; 69 20  
 sunflower oil 98 24  
 sunglasses 6 19; 111 6; 301 19  
 sunglass pocket 6 19  
 sun hat 29 16; 35 37  
 sunlight 155 18  
 sun lounge 37 70  
 sun parlor 37 70  
 sun ray lamp 281 13  
 sun roof 37 75  
 sunroof, steel ~ 193 24  
 sun rose 377 20  
 sun sensor 10 69  
 sunshade *Dwellings* 37 48, 71  
 sunshade *Town* 268 61  
 sunshade *Park* 272 58  
 sunshade *Films* 313 3  
 sun spectacles 111 6  
 sunspot 4 37, 38  
 sun terrace 37 75

supatap 126 35  
 super *Bees* 77 45  
 super *Theatre* 316 39  
 Super-calender 173 36  
 supercilium 19 38  
 super grade gasoline 145 55  
 super grade petrol 145 55  
 superheater 152 9  
 supermarket 99 1-96  
 supernumerary 316 39  
 superstructure *Weaving* 165 6  
 superstructure *Ship* 221 10, 69  
 superstructure, aft ~ 258 22  
 superstructure, compact ~ 221 33  
 superstructure, forward ~ 259 45  
 superstructure deck 258 10  
 superstructures 258 10-28  
 Super-Vee racing car 290 37  
 supplementary angle 346 14  
 supply pipe *Butch.* 96 50  
 supply pipe *Plumb. etc.* 126 9  
 supply sprocket 312 26  
 supply table 74 51  
 supply vessel 221 32  
 support *Plant Propagn.* 54 33  
 support *Roof* 121 83  
 support *Knitting* 167 38  
 support *Offset Platem.* 179 20  
 support *Shipbuild.* 222 27  
 support *Circus* 307 29, 45  
 support, adjustable ~ 67 22  
 support, intermediate ~ 214 29, 76  
 support, single-pylon ~ 214 23  
 support, three-point ~ 349 28  
 support, tubular steel ~ 214 78  
 support cable 2 30  
 supporters 254 15-16  
 support guide rail 214 79  
 supporting cable 214 27, 38, 41, 44  
 supporting cable anchorage 214 59  
 supporting cable brake 214 71  
 supporting cable guide 214 58  
 supporting cable guide rail 214 79  
 supporting insulator 153 54  
 supporting pulley 163 46  
 supporting structure 337 9  
 supporting wall 121 77  
 support insulator 153 54  
 support roll 270 50  
 support truss 214 80  
 suppressor 190 35  
 surcoat 355 25  
 surf 13 27  
 surface, asphalt ~ 200 58  
 surface, bituminous ~ 198 5  
 surface, curved ~ 347 40  
 surface, flat ~ 111 39  
 surface, hatched ~ 151 29  
 surface, icy ~ 304 19  
 surface, lunar ~ 6 13  
 surface, nap ~ 168 31  
 surface, plane ~ 347 31  
 surface, raised ~ 168 31

surface, special ~ 111 40, 41, 42  
 surface boundary layer 7 7  
 surface chart 9 1-39  
 surface condenser 152 24  
 surface finisher 200 43  
 surface-finish microscope 112 37  
 surface hydrant 270 35  
 surface not to be machined 151 20  
 surfaces, plane ~ 346 24-58  
 surface skimmers 286 38-44  
 surface synoptic chart 9 1-39  
 surface-to-air missile launcher 259 50  
 surface-to-air rocket launcher 259 50  
 surface to be machined 151 21  
 surface to be superfinished 151 22  
 surface wave 11 36  
 surfacing 111 36  
 surfboard 279 1, 2; 280 15; 284 5  
 surfboarder 279 5; 280 14  
 surfer 279 5; 280 14  
 surfing 279 1-6; 280 13  
 surf riding 279 1-6; 280 13  
 surge baffle system 235 53  
 surge diverter 152 35  
 surgery 22 32-74  
 surge tank 217 40  
 surgical instruments 26 40-53  
 surgical unit 26 1-54  
 sur le cou-de-pied 314 14  
 surroyal 88 9  
 survey illumination 112 52  
 surveying 14 46-62  
 surveying, geodetic ~ 14 46-62  
 surveying level 14 48  
 surveyor's level 14 48  
 suspect 264 32  
 suspender *Underwear etc.* 32 6  
 suspender *Bridges* 215 41  
 suspender *Nightclub* 318 28  
 suspenders 29 26, 34; 32 30; 33 45  
 suspension 168 16  
 suspension, steel and rubber ~ 207 4  
 suspension and haulage cable 214 21  
 suspension arm, lower ~ 192 84  
 suspension bridge 215 39  
 suspension bridge, primitive ~ 215 15  
 suspension cable *Railw.* 214 27, 38, 41, 44  
 suspension cable *Bridges* 215 40  
 suspension cable anchorage *Railw.* 214 59  
 suspension cable anchorage *Bridges* 215 43  
 suspension cable bearing 214 33  
 suspension cable brake 214 71

suspension cable guide 214 58  
 suspension cable guide rail 214 79  
 suspension damper 192 76  
 suspension file 248 3  
 suspension file system 248 2  
 suspension gear 214 54  
 suspension gear bolt 214 72  
 suspension line 288 40  
 suspension line, double-cable ~ 214 25, 30  
 suspension line gondola 214 52  
 suspension lines, single-cable ~ 214 15-24  
 suspension line support 214 76  
 suspension rope 215 17  
 suspension spring 192 74  
 sustaining pedal 325 8  
 suture material 22 56; 26 21  
 swab 137 3  
 swab dispenser 22 36  
 swage block *Goldsm. etc.* 108 18  
 swage block *Blacksm.* 137 17  
 swage block *Metalwkr.* 140 14  
 swage head 143 57  
 swallow 361 20  
 swallowhole 11 49; 13 71  
 swallowtail 358 52  
 swallow-tail twin crystal 351 25  
 swamp 13 24  
 Swan *Astron.* 3 23  
 swan 272 54; 359 16  
 swan *Birds* 359 16  
 swan-neck 37 12; 122 30  
 swan's neck 37 12; 122 30  
 swarf 149 44  
 swarm cluster of bees 77 53  
 swarming net 77 54  
 swarm of bees 77 53  
 swath 63 23, 36  
 swathe 63 23, 36  
 swather 63 19  
 swather, rotary ~ 63 26; 64 40-45  
 swath rake 64 44  
 swath reaper 63 19  
 sweater 29 43; 31 51  
 sweater, short-sleeved ~ 33 32  
 sweepback, positive ~ 229 21  
 sweepback, semi-positive ~ 229 20  
 sweeper, mechanical ~ 199 39  
 sweet 98 75, 80  
 sweet bread 97 40  
 sweet calamus 377 22  
 sweet cherry 59 5  
 sweet chestnut 384 48  
 sweet corn 68 31  
 sweet flag 377 22  
 sweet gale 373 33  
 sweet pepper 57 42  
 sweets 47 31, 32  
 sweet sedge 377 22  
 sweet syringa 373 9  
 sweet william 60 6  
 swell 325 45  
 swell pedal, balanced ~ 326 50

swift 359 24  
 swimming 282  
 swimming bath 281  
 swimming bath attendant 281 4; 282 15  
 swimming belt 282 19  
 swimming cap 280 29, 44  
 swimming instruction 282 16-20  
 swimming instructor 282 16  
 swimming lane 282 31  
 swimming pool 223 23; 281 1-9  
 swimming pool, open-air ~ 282 1-32  
 swimming pool attendant 281 4; 282 15  
 swimming strokes 282 33-39  
 swimming teacher 282 16  
 swimming trunks 280 43  
 swimsuit 280 42  
 swing *Gymn.* 297 39  
 swing *Athletics* 298 30  
 swing, double ~ 273 39  
 swing boat 308 41, 42  
 swing bridge, flat ~ 215 67  
 swing door 207 18  
 swing-grippers 180 33  
 swing pipe 172 10  
 swing seat 273 40  
 swing wing 256 9  
 Swiss chard 57 28  
 Swiss cheese 99 41  
 Swiss roll 97 19  
 Swiss stone pine 372 29  
 switch *Electr.* 127 7  
 switch *Garage* 195 4, 12  
 switch *Aircraft* 230 26  
 switch, main ~ *Joiner* 132 58  
 switch, main ~ *Railw.* 211 3, 31  
 switch, main ~ *Office* 249 37  
 switch, manually-operated ~ 202 16  
 switch, remote-controlled ~ 202 27  
 switch, rotary ~ *Electr.* 127 18  
 switch, rotary ~ *Office* 245 28  
 switchback 308 39  
 switch blade 202 21  
 switchboard *Post* 237 17, 22-26  
 switchboard *Office* 245 13  
 switch engine 206 43  
 switcher 206 43  
 switches, single ~ 203 45-48  
 switching box 237 25  
 switching centre 237 25, 41  
 switching device 269 47  
 switching system 153 5  
 switching system, automatic ~ 237 25  
 switch knob 203 62  
 switch lever *Mach. Tools* 149 11; 150 35  
 switch lever *Railw.* 203 55  
 switch lock 202 28  
 switch signal 197 38; 202 19  
 switch signal, electrically illuminated ~ 202 33  
 switch signal lamp 202 19

switch signals 203 45-52  
 switch stand 202 17  
 switch tongue 202 21  
 switch tower 15 24  
 switch tower, electrically-operated ~ 203 61  
 switch tower, manually-operated ~ 203 53  
 switch yard 206 42  
 swivel *Fish Farm.* 89 77  
 swivel *Oil, Petr.* 145 10  
 swivel arm 26 13; 104 27; 105 26  
 swivel chair 246 1; 248 25  
 swivel coupling 50 69  
 swivel head 50 60  
 swivel mechanism 65 73  
 swivel motor 132 69  
 swivel nozzle 235 64  
 swivel saddle 188 21  
 swivel tap 126 36  
 swop platform 194 23  
 sword 319 32  
 sword antenna 256 28  
 sword lily 60 11  
 swordsman 319 25  
 sword swallower 308 26  
 S-wrench, adjustable ~ 126 66  
 symbol, algebraic ~ 344 9; 345 5  
 symbols, geometrical ~ 345 21-24  
 symbols, mathematical ~ 345 15-24  
 symphysis, pubic ~ 20 65  
 symphonia 322 25  
 syncarp 384 63  
 sync head 243 34  
 synchro 153 32  
 synchromesh gearbox, four-speed ~ 192 28-47  
 synchronization 311 37-41  
 synchronization start 117 65  
 synchronization unit 117 77  
 synchronizing cone 192 33  
 synchronizing filter 311 27  
 syncing 311 37-41  
 syncline 12 18  
 sync pulse cable 313 29  
 sync start 117 65, 69  
 sync track 243 33  
 synthetic fibres 169; 170  
 syringe 22 54, 65  
 syringe, hypodermic ~ 24 53  
 syringe, multi-purpose ~ 24 10  
 syrxin 322 2  
 system, ancillary ~ 211 34  
 system, planetary ~ 4 42-52  
 system camera 115 1-105  
 system-monitoring device 234 17  
 system of accessories 115 43-105  
 system of coordinates 347 8, 11  
 system of flaps 229 37



## T

tabard 30 50  
 tabby weave 171 1  
 tabernacle 330 42  
 table *Forging* 139 20  
 table *Restaurant* 266 74  
 table *Playground* 273 2  
 table *Music. Instr.* 324 3  
 table *Art* 336 14, 16  
 table, auxiliary ~ *Blacksm.* 137 14  
 table, auxiliary ~ *Mach. Tools* 150 28  
 table, director's ~ 316 42  
 table, flat ~ 36 46, 72, 73, 74  
 table, producer's ~ 316 42  
 table, revolving ~ 148 41  
 table, rotary ~ 145 15  
 tableau curtain 315 2  
 table bed 277 15  
 tablecloth 45 2  
 table decoration 45 19; 266 78  
 table en cabochon 36 47  
 table en cabochon, antique ~ 36 76  
 table en cabochon, rectangular ~ 36 77  
 table feed drive 150 34  
 table lamp 46 24; 246 35  
 tableland 13 46  
 table leg 44 2  
 table linen 271 57  
 table napkin 45 9  
 table pedestal 26 6  
 table piano 325 40  
 table rise adjustment 133 23  
 table runner 46 35  
 table telephone, standard ~ 237 6  
 table tennis 273 1; 293 45-55  
 table tennis ball 273 5; 293 48  
 table tennis bat 273 4; 293 45  
 table tennis net 273 3; 293 53  
 table tennis player 293 49  
 table tennis racket 273 4; 293 45  
 table tennis table 293 52  
 table top *Dining Rm.* 44 3  
 table top *Arc Weld.* 142 14  
 table-top tripod 115 99  
 table tripod 115 99  
 tableware 45  
 tabulator clear key 249 8  
 tabulator key 249 7  
 tachograph 210 54  
 tachometer *Weaving* 166 2  
 tachometer *Knitting* 167 43  
 tachometer *Letterpress* 181 54  
 tachometer *Car* 191 38  
 tachometer *Railw.* 212 22  
 tachometer *Aircraft* 230 8  
 tack 285 25  
 tacking 285 25-28  
 tackle 219 1-72; 221 27, 104  
 taffrail log 224 54  
 tagetes 60 20  
 tail *Horse* 72 38

tail *Game* 88 19, 47, 49, 58, 62, 67, 75, 80  
 tail *Roof* 122 89  
 tail *Bookbind.* 185 58  
 tail *Birds* 362 8  
 tail *Mammals* 367 29  
 tail, cruciform ~ 229 28  
 tail, curly ~ 73 12  
 tail, docked ~ 70 12  
 tail, dolphin's ~ 327 25  
 tail, falcate ~ 73 25  
 tail, fish's ~ 327 25, 43, 46, 49  
 tail, horizontal ~ 229 26-27, 35; 230 61; 257 21  
 tail, normal ~ 229 23  
 tail, prehensile ~ 364 35  
 tail, raised ~ 229 35  
 tail, serpent's ~ 327 31  
 tail, tufted ~ 73 6  
 tail, vertical ~ 229 24-25; 230 58  
 tailband 185 42  
 tail bracing wire 232 4  
 tailcoat 33 13  
 tail end shaft 223 60  
 tail fin *Aircraft* 229 24; 230 59; 231 6; 232 7  
 tail fin *Air Force* 256 32  
 tail fin *Airsports* 288 21  
 tail fin *Fish etc.* 364 10  
 tail fluke 367 29  
 tailgate 193 16, 20; 195 50  
 tailings auger 64 21  
 tailings outlet 64 22  
 tail line 122 81  
 tail loading gate 232 25  
 tail margin 185 58  
 tail of kite 273 43  
 tailor 104 22; 271 37  
 tailor's chalk 271 39  
 tailor seat 295 11  
 tailpiece 323 7  
 tailpin 323 22  
 tailplane 229 26; 230 62; 256 31; 288 23  
 tailpole 91 32  
 tail propeller 232 28  
 tail rotor 232 14; 264 4  
 tails 33 13  
 tail shaft 223 60  
 tail shapes 229 23-36  
 tail skid 256 23  
 tail slide 288 5  
 tail sting 358 43  
 tailstock *Turner* 135 7  
 tailstock *Mach. Tools* 149 29; 150 5  
 tailstock *Photomech. Reprod.* 177 62  
 tailstock barrel 149 27  
 tailstock barrel adjusting handwheel 149 30  
 tailstock barrel clamp lever 149 28  
 tailstock centre 149 26  
 tail unit, cruciform ~ 229 28  
 tail unit, double ~ 229 32, 34  
 tail unit, normal ~ 229 23  
 tail unit, triple ~ 229 36  
 tail unit shapes 229 23-36  
 tail vice 132 37

tail wheel 256 27  
 take-down weight 167 32  
 lake number 310 35  
 take-off 298 26, 37  
 take-off, balloon ~ 288 84  
 take-off board 298 38  
 take-off shaft 65 31  
 take-off stand 165 41  
 taker-in 163 53  
 take-up reel 117 80  
 take-up spindle 312 37  
 take-up spool *Photog.* 115 25  
 take-up spool *Cine Film* 117 32, 80  
 take-up sprocket 312 27  
 taking lens 313 2  
 talcum powder 99 29  
 talkback equipment 238 64  
 talkback microphone 238 10, 53  
 talkback microphone, producer's ~ 238 39  
 talkback speaker 238 8, 52  
 talkback system 238 64  
 talk button 242 24  
 talk key 242 24  
 talon *Stock Exch.* 251 19  
 talon *Birds* 362 7  
 talus 11 47; 12 45  
 tambour door 245 5  
 tambourine *Disco* 317 27  
 tambourine *Music. Instr.* 324 45  
 tamer 307 52  
 tamper 200 26; 201 13  
 tamping beam 200 32; 201 2  
 tandem 186 50  
 tandem kayak 283 5  
 tang 45 52, 60  
 tangent *Music. Instr.* 322 43  
 tangent *Maths.* 346 32, 48  
 tangent screw 14 56  
 tangerine 384 23  
 tank *Cooper* 130 1  
 tank *Lorries etc.* 194 30  
 tank *Army* 255 80  
 tank, bottom ~ 222 38  
 tank, concrete ~ 310 11  
 tank, side ~ 222 37  
 tank, spherical ~ 145 73; 221 36  
 tank bottom valve 38 49  
 tank car 213 31  
 tank construction engineer 130  
 tanker *Docks* 225 73  
 tanker *Airport* 233 22  
 tanker terminal 145 74  
 tank farm 225 61  
 tank for sterilized milk 76 16  
 tank furnace 162 1  
 tank inlet 38 47  
 tank locomotive 210 65  
 tank margin plate 222 51  
 tank reel 116 2  
 tank spiral, multi-unit ~ 116 4  
 tank top 222 54  
 tank top plating 222 54  
 tank vent 234 44  
 tank wagon 213 31

tansy 380 9  
 tap *Doc.* 23 49  
 tap *Metalwkr.* 140 60  
 tap *Power Plant* 153 18  
 tap *Spa* 274 17  
 tap *Disco* 317 8  
 tap *Chem.* 349 5, 22; 350 44, 53  
 tap, outside ~ 37 41  
 tap bar 148 9  
 tap changer 211 10  
 tapchanger driving mechanism 211 13  
 tape *Ball Games* 293 73  
 tape *Music. Instr.* 325 36  
 tape, adhesive ~ 98 47; 134 38; 247 29  
 tape, magnetic ~ 25 46  
 tape, varnished-cambric ~ 153 46  
 tape cassette 117 76  
 tape counter 241 64; 243 9  
 tape deflector roller 241 60  
 tape feed 243 29  
 tape guide 243 22  
 tape measure 103 2; 271 38  
 tape punch 176 5  
 taper, wax ~ 77 65  
 tape recorder 117 70; 317 21; 318 17  
 tape recorder, four-track ~ 242 13  
 tape recorder, portable ~ 309 37  
 tape recorder, two-track ~ 242 12  
 tape reel, open ~ 241 57  
 taper thread, female ~ 126 47  
 tape speed selector 241 62  
 tapestry wallpaper 128 18  
 tape threading indicator light 243 14  
 tape wire 325 35  
 tapeworm 81 35  
 tap hole 147 50  
 tapir 366 26  
 tappet 166 57  
 tappet shaft 166 56  
 tapping 153 18  
 tapping a spring 269 24-39  
 tapping bar 148 9  
 tapping hole 147 50  
 tapping spout 148 3  
 taproot, swollen ~ 370 79  
 tap wrench 140 30  
 tar 170 4  
 tar and bitumen heater 200 46  
 target *Inf. Tech.* 242 84  
 target *Sports* 305 30, 32, 66, 77  
 target, bobbing ~ 305 33, 48  
 target, turning ~ 305 33, 48  
 target archery 305 52-66  
 target areas 294 51-53  
 target cross 288 56  
 target jack 305 23  
 target rectangle 292 34  
 targets 305 30-33  
 tar-spraying machine 200 46  
 tar storage tank 200 47  
 tarsus *Man* 17 26  
 tarsus *Birds* 362 4

tartlet 97 20  
 tasse 329 49  
 tassel *Headgear* 35 24  
 tassel *Arable Crops* 68 35  
 tassel *Hist. Cost.* 355 23  
 tasset 329 49  
 tating 102 19  
 tating shuttle 102 20  
 tattoo 306 44  
 tau cross 332 59  
 Taurus 3 25; 4 54  
 taxi 268 64  
 taxicab 268 64  
 taxi rank 268 63, 66  
 'taxis' 233 32  
 taxi sign 268 65  
 taxi stand 268 63, 66  
 taxi telephone 268 67  
 taxiway 233 2  
 T-cut 54 32  
 tea *Grocer* 98 65-68  
 tea *Supermkt.* 99 68-70, 69  
 tea *Trop. Plants* 382 9  
 tea bag 98 68  
 teacher 260 21  
 teaching equipment 242; 242 45-84  
 teaching laser 242 81  
 teaching machine 242 1  
 teaching material 261 27  
 tea dance 267 44-46  
 tea leaf 382 9  
 team of oxen 63 16  
 tea plant 382 7  
 tea plate 39 34  
 tear bag 88 14  
 tear-off edge 247 30  
 tea room 265 1-26  
 teat *Infant Care etc.* 28 20  
 teat *Livestock* 75 19  
 teat cup 75 30  
 teat cup cluster 75 26  
 tea tree 382 7  
 technical drawing 151 16  
 technical laboratory 310 9  
 Teclu burner 350 4  
 tectogenesis 12 4-20  
 tedder, rotary ~ 63 24; 64 46-58  
 teddy bear 28 46; 273 26; 309 12  
 teddy bear, rocking ~ 48 30  
 tee 126 44, 47  
 tee *Ball Games* 293 90  
 teeing ground 293 79  
 tee-iron 143 3  
 teepee 352 7  
 tee-square 151 9  
 teeth 19 16-18  
 teeth, false ~ 24 25  
 teeth grinder 157 43, 45  
 teething ring 28 12  
 teeth of knock-over bit 167 52  
 telecobalt unit 2 28  
 telegraphy 237 30  
 telemetry antenna 10 70  
 telephone 22 18; 41 7; 238 23; 246 13; 248 9  
 telephone, public ~ 236 9; 237 1, 3

telephone, toy ~ 47 35  
 telephone adapter socket 249 67  
 telephone answering and recording set 22 13  
 telephone answering device 22 13  
 telephone book 236 12; 237 5  
 telephone booth 204 46; 236 8; 237 1; 251 10; 268 56  
 telephone box 204 46; 236 8; 237 1; 251 10; 268 56  
 telephone cable 198 15  
 telephone cable pipeline 198 16  
 telephone casing 237 15  
 telephone connection 242 20  
 telephone cover 237 15  
 telephone customer 237 2  
 telephone directory 236 12; 237 5  
 telephone directory rack 236 10  
 'telephone - emergency calls only' 233 40  
 telephone exchange 237 27-41  
 telephone exchange, internal ~ 245 13  
 telephone index 22 21  
 telephone instruments 237 6-26  
 telephone kiosk 204 46; 236 8; 237 1; 251 10; 268 56  
 telephone line, customers' ~ 198 20  
 telephone line, subscribers' ~ 198 20  
 telephone list, internal ~ 245 17  
 telephone number 237 38  
 telephone receiver 237 7; 246 16  
 telephones 237 6-26  
 telephone service 237 41  
 telephone subscriber 237 2  
 telephone switchboard panel 238 14  
 telephone user 237 2  
 telephoto lens 117 47  
 teleprinter 176 31; 237 31, 61, 66; 238 12  
 telescope 14 60; 42 15; 224 8  
 telescope, gimbal-mounted ~ 235 68  
 telescope, monocular ~ 111 18  
 telescope, reflecting ~ 113 1  
 telescope, refracting ~ 113 16  
 telescope, surveyor's ~ 14 48  
 telescope magnifier 113 38  
 telescope mountings 113 16-25  
 telescope mounts 113 16-25  
 telescope sight 87 29; 255 28; 305 49  
 Teletype 176 31  
 teletypewriter 237 31  
 television 238; 239  
 television cabinet 240 2  
 television camera 10 67; 112 36; 154 78; 240 26



television disc system 243  
37-45  
television engineering 240  
television mast 15 33  
television OB van 239 1-15  
television post-sync studio  
238 27-53  
television programmes 342 64  
television receiver 242 28  
television receiver, domestic  
~ 243 6  
television receiving aerial 239  
4, 5  
television reception aerial  
239 4, 5  
television set 42 8; 46 14; 242  
28  
television sound 242 27  
television tube 240 3  
telex link 237 65  
telex message 237 69  
telex service 237 41  
telex tape 237 68  
Telford base 260 60  
teller 250 2  
tempera 338 17  
temperature 9 8  
temperature gauge 179 4  
temperature gauge, distant-  
reading ~ 210 48  
temperature graph 7 37  
temperature regulation flap  
10 65  
temperature regulator 191 84  
temperature scale 7 36  
temperature selector 50 8  
tempest 284 54  
template 126 83  
template, circular ~ 141 35  
temple *Man* 16 6  
temple *Weaving* 166 13  
temple *Art* 337 7  
temple, Doric ~ 334 1  
temple, Etruscan ~ 334 49  
temple, funerary ~ 333 7  
temple buildings 337 25  
temple tower 333 32; 337 1, 26  
temple wall 334 6  
temporalis 19 3  
tender *Railw.* 210 38  
tender *Warships* 258 92  
tender platform 210 2  
tendo calcaneus 18 48  
tendril 57 4  
tendril, thorny ~ 58 30  
tennis 293 1-42  
tennis ball 293 28  
tennis court 293 1  
tennis net 293 13  
tennis player 293 16  
tennis racket 41 13; 293 29  
tennis shoe 101 36  
tenon saw 132 44  
tenor clef 320 11  
tenor horn 323 39  
tenor trombone 323 46  
tenor viol 322 23  
tenpin bowling 305 14-20  
tens 344 3  
tension and slub-catching  
device 165 13

tension bar 167 49  
tension cable, inclined ~ 215  
47  
tension cable pulley 214 43  
tension compensator 165 51  
tension equalizer 165 51  
tension hoop 324 56  
tensioning device *Agr. Mach.*  
64 94  
tensioning device *Railw.* 208  
18  
tensioning lever 208 18  
tensioning screw 323 53  
tension roller *Joiner* 133 13  
tension roller *Letterpress* 181  
45  
tension weight *Knitting* 167  
50  
tension weight *Railw.* 214 41,  
42  
tension weight shaft 214 40  
tent 80 7  
tent, four-pole ~ 307 1  
tentacle 357 16, 31  
tenter 165 54; 168 21  
tenter clip 168 24  
tenter pin 168 24  
tent peg 278 24  
tent pole 278 38; 307 2; 352 8  
tent prop 307 13  
tenuto 321 30  
tepee 352 7  
teres major 18 55  
teres minor 18 54  
tergites 358 31  
term 344 23  
terminal *Docks* 226 16  
terminal *Airport* 233 15  
terminal box 211 16  
termination of speed  
restriction 203 40  
tern 359 11  
terrace 37 36  
terracette 13 64  
terrarium 356 14  
terrestrial meridian 14 4  
terrier 70 15, 16, 17, 18, 27,  
39  
terry towel 49 9  
tessellation 338 37  
tessera 338 39  
tesseral crystal system 351  
1-17  
test equipment 195 17  
testicle, right ~ 20 72  
testing and control station  
237 40  
testing board 237 29  
testing desk 237 29  
testing device for waterproof  
watches 109 26  
testing kit 138 14  
testis 20 72  
test meter, universal ~ 127 41  
test oil and gas separator 146  
10  
test separator 146 10  
test tube 350 34  
test tube rack 173 8; 261 31;  
350 35  
lether 75 15-16

tetradrachm 252 1  
tetragonal crystal system 351  
18-19  
tetrahedrite 351 1  
tetrahedron 351 1  
text 237 68  
textbook 261 28  
thalamus 370 53  
thallus 378 49  
Thaumatolampas diadema  
369 4  
T-head bolt 202 10  
theater *see* theatre  
theatre *Astron.* 5 26  
theatre *Theatre* 315; 316  
theatre, Greek ~ 334 44  
theatre, open-air ~ 272 6  
theatre projector 312 24  
theatre seat 315 20  
theatre ticket 315 11  
thé dansant 267 44-46  
theodolite 14 52-62  
theorbo 324 1  
thermal 287 21  
thermal protection shield 234  
5, 20  
thermal soaring 287 20  
thermograph 10 19, 51  
thermometer *Meteorol. Instr.*  
10 25  
thermometer *Infant Care etc.*  
28 29  
thermometer *Text. Finish.*  
168 27  
thermometer *Swim.* 281 24  
thermometer, ladle-type ~ 92  
53  
thermometers 10 53-54  
thermometer screen 10 49  
thermometer shelter 10 49  
thermometric scale 7 36  
thermoplastic 130 15  
Thermos jug 40 5  
thermo time switch 190 63  
thickener 172 24, 42, 44, 48,  
62  
thickener 132 45  
thickening machine 132  
45  
thickening table 132 46  
thief 308 16  
thigh 16 49; 17 22  
thigh bone 17 22  
thill 186 19, 30  
thiller 186 28  
thill horse 186 28  
thimble, graduated ~ 149 64  
thinner *Painter* 129 16  
thinner *Art. Studio* 338 13  
thinning 84 37  
thinning razor 105 9; 106 41  
thinnings, small-sized ~ 84  
37  
thinning scissors 105 8; 106  
33  
thinning shears 105 8; 106 33  
third base 292 47  
third man 300 27  
thirty-second note 320 18  
thirty-second rest 320 26  
thistle 61 32

Thomas converter 147 55-69  
thoracic shield 82 4; 358 29  
thorax *Man* 16 28-30; 17 8-11  
thorax *Articulates* 358 29-30  
thorn *Gdn. Flowers* 60 18  
thorn *Spa* 274 2  
thorn *Shrubs etc.* 374 30  
thorn apple 379 8  
thorn house *Map* 15 32  
thorn house *Spa* 274 1  
thousands 344 3  
thread *Overh. Irrign.* 67 38  
thread *Mach. Parts etc.* 143  
16, 68  
thread *Glass Prod.* 162 54  
thread *Cotton Spin.* 164 53  
thread *Weaving* 165 21  
thread *Knitting* 167 17, 36  
thread *Bookbind.* 183 11  
thread, coarse ~ 149 4  
thread, female ~ 126 41, 45  
thread, glass ~ 162 56, 57  
thread, male ~ 126 38, 51  
thread, metal ~ 102 30  
thread, mycelial ~ 381 2  
thread, normal ~ 149 4  
thread, sleeved ~ 162 57  
thread chaser 135 14  
thread clearer 165 20  
thread container 22 61  
thread cop 185 18  
thread-cutting machine 125  
27; 126 86  
thread guide *Shoem.* 100 30  
thread guide *Knitting* 167 3,  
54, 64  
thread head 187 75  
threading draft 171 5  
threading key 127 30  
thread interlacing 171 26  
thread pitch 149 9  
thread spool 185 18  
thread tapper 108 15  
threadworm 80 51  
three 302 13  
three-day event 289 16-19  
three-decker 218 51-60  
three-eight time 320 36  
three-four time 320 37  
three-masters 220 18-27  
three-phase generator 153 26  
three-phase plug 127 14  
three-two time 320 38  
threshing drum 64 12  
throat *Man* 16 19; 19 14-37,  
24  
throat *Horse* 72 16  
throat *Forestry* 84 28  
throatlash 71 11; 72 16  
throatlatch 71 11; 72 16  
throat piece 329 42  
throstle 361 16  
throttle control 230 30; 288  
15  
throttle lever 230 30; 288 15  
throttle twist grip 188 30; 189  
29  
throttle valve *Hosp.* 27 43  
throttle valve *Car* 192 9  
through-the-lens reflex  
finder 117 44

thrower 161 9  
throw-in 291 53  
throwing act 307 43  
throwing knife 354 15  
throwing ring 308 47  
throwing spear 328 2  
throwing stick 352 40  
thrush 360 3  
thrushes 361 13-17  
thrush nightingale 361 17  
thrust bearing 221 29  
thrust block 223 67; 259 60  
thrust lever 257 9  
thrust mount, lower ~ 235 6  
thrust mount, upper ~ 235 5  
thrust nozzle 234 35; 235 37  
thrust nozzle fuel tank 235 45  
thrust structure 234 21  
thrust vector control system  
235 43  
thrust washer 190 56  
thrust weapon 294 11, 36, 37  
thuja 372 39  
thumb 19 64  
thumb hold 323 45  
thumb hole 305 47  
thumb nut 119 75  
thumb piston 326 46  
thundercloud 7 2  
thunderstorm 9 38  
thurable 332 38  
thurable bowl 332 41  
thurable chain 332 39  
thurable cover 332 40  
thwart 278 17; 283 28  
thyme 334 48  
tiara, papal ~ 254 37  
Tibetan 353 27  
tibia 17 25  
tibialis anterior 18 47  
tick *Bedrm.* 43 13  
tick *Articulates* 358 44  
tick, drill ~ 43 10  
tick bean 69 15  
ticket 204 36  
ticket agent 204 39  
ticket-cancelling machine  
197 16  
ticket clerk 204 39  
ticket counter 197 33; 204 35  
ticket machine 268 28  
ticket office 204 34  
ticket printer, hand-operated  
~ 204 41  
ticket-printing machine 204  
40  
ticket-stamping machine 204  
40  
tidal power plant 155 37  
tide level indicator 225 37  
tidemark 13 35  
tide table 280 7  
tie *Ladies' Wear* 30 46  
tie *Underwear etc.* 32 41  
tie *Bldg. Site* 119 39  
tie *Roof* 121 59  
tie *Station* 205 60  
tie *Music. Not.* 321 24  
tie, concrete ~ 202 37  
tie, coupled ~ 202 14, 38  
tie, diagonal ~ 121 30

tie, double ~ 121 50  
tie, simple ~ 121 49  
tie, steel ~ 202 36  
tie beam 121 53  
tie belt 29 55; 31 19  
tie fastening 101 21  
tiepin 36 22  
tier, lower ~ 228 24  
tier, upper ~ 228 23  
tierce engagement 294 48  
tiercel 86 46  
tie rod 65 47  
tier of oars 218 12  
tie shoe 101 31  
tie tube 119 49  
tie-up 171 22, 23  
tie-up of shafts 171 9  
tiger 307 56; 368 5  
tightening screw 293 33  
tightrope 307 41  
tightrope dancer 307 40  
tights 29 42; 32 12  
tilbury 186 44  
tilde 342 35  
tile *Bathrm. etc.* 49 19  
tile *Games* 276 34  
tile, flat interlocking ~ 122 60  
tile, interlocking ~ 122 59  
tile, plain ~ 122 6, 46  
tile beard 34 16  
tile cutter 122 33  
tile hammer 122 20  
tile roofings 122 45-60  
tiles 122 45-60  
tiling batten 122 17  
till 207 86; 271 5  
till, electric ~ 271 2  
tillage 69 1-28  
tiller 218 13; 284 32; 286 24  
tiller extension 284 31  
tillering 68 5  
tilt 329 71  
tilt block 12 9  
tilting armour 329 76  
tilting device 147 44, 59  
tilting helmet 254 4; 329 77  
tilting lance 329 81  
tilting shield 329 79  
tilting table 133 17  
tilting target 329 79  
tilt wing 232 27  
timbale 324 57  
timber 85 42  
timber, end-grained ~ 120 92  
timber, halved ~ 120 88  
timber, long ~ 120 2  
timber, round ~ 120 35; 157  
30  
timber, sawn ~ 157 22  
timber, small ~ 84 37  
timber, squared ~ 120 10; 157  
36  
timber, stacked ~ 84 15  
timber, standing ~ 84 4  
timber, undressed ~ 120 83  
timber, yarded ~ 84 15  
timber cutting 84 15-37  
timber dog 121 97  
timberjack 84 18  
timber joints 121 84-98  
timber planking 285 50-57



time *Music. Not.* 320 28-42  
 time *Maths.* 345 7  
 time ball 280 5  
 time indicator 289 40  
 timekeeper 282 24; 299 47  
 timer *Doc.* 23 40  
 timer *Hosp.* 27 35  
 timer *Kitch.* 39 21  
 timer *Watchm.* 109 35  
 timer *Photog.* 116 18  
 timer *Photograv.* 182 20  
 timer *Billiards* 277 17  
 timer, synchronous ~ 24 52  
 timer switch, built-in ~ 243 18  
 time scale *Meteorol. Instr.* 10 17  
 time scale *Office* 249 74  
 time scale stop 249 75  
 time schedule 151 12  
 time signatures 320 28-42  
 timetable 204 16, 18  
 timetable, driver's ~ 210 52  
 timetable, official ~ 204 50  
 time weight 110 29; 309 59  
 timing machine, electronic ~ 109 27  
 timpano 323 57  
 tin 129 7  
 tin, molten ~ 162 17  
 tinctures 254 24-29  
 tine *Tablew. etc.* 45 60  
 tine *Agr. Impl.* 66 4  
 tine *Game* 88 10, 31  
 tine bar 64 53  
 tinner's snips 125 1  
 tip, adjustable ~ 149 47  
 tip, controlled ~ 199 10  
 tip, cork ~ 107 13  
 tip, gold ~ 107 13  
 tip, oxide ceramic ~ 149 47  
 tip, pointed ~ 253 10  
 tip-cart, three-way ~ 62 18  
 tip heap 144 19  
 tipper 200 7  
 tipper, three-way ~ 194 24  
 tipper wagon 213 37  
 tipping body *Lorries etc.* 194 25  
 tipping body *Road Constr.* 200 8  
 tipping bucket 214 34  
 tipping car 147 64  
 tipping cylinder 62 19  
 tipping device 147 44, 59  
 tipping truck 119 28  
 tipping wagon 119 28  
 tippler, three-way ~ 92 34  
 tip tank 231 9; 256 30  
 tip-up seat 207 12  
 tire *seetyre*  
 tired swimmer grip 21 38  
 T-iron 143 3  
 tissue, erectile ~ 20 67  
 tit 360 4; 361 9  
 titan 327 37  
 title block 151 31  
 title bout 299 35-50  
 title fight 299 35-50  
 title page 185 45  
 title panel 151 31

titmouse 360 4; 361 9  
 tjalk 220 6  
 T-joint 126 44, 47  
 T-junction joint 126 44, 47  
 toad 364 23  
 toadstools 379 10-13  
 toast 45 34  
 toaster 40 30  
 toat 132 18  
 tobacco *Tobacc. etc.* 107 25  
 tobacco *Trop. Plants* 382 43  
 tobacco, raw ~ 83 13  
 tobacco beetle 81 25  
 tobacco factory 83 11  
 tobacco leaf 382 43  
 tobacco plant 382 40  
 tobacco pouch 107 43  
 tobacco presser 107 47  
 toboggan 303 1, 2, 13  
 toboggan, junior ~ 303 3  
 toboggan cap 35 39  
 toboggan slide 308 40  
 toe, big ~ 19 52  
 toe, first ~ 19 52  
 toe, fourth ~ 19 55  
 toe, great ~ 19 52  
 toe, little ~ 19 56  
 toe, second ~ 19 53  
 toe, third ~ 19 54  
 toecap 100 58; 101 16, 40  
 toecap remover 100 52  
 toe clip 290 21  
 toenail 19 57  
 toe piston 326 48  
 toe post sandal 101 48  
 toe stand 295 5  
 toestrap 284 30  
 toe unit 301 55  
 toffee 98 77  
 toga 355 13  
 toggle 340 30  
 toggle action *Letterpress* 181 16  
 toggle action *Bookbind.* 183 30  
 toggle fastening 30 66  
 toggle-joint action 181 16; 183 30  
 toggle-joint press 183 26  
 toggle-lever press 183 26  
 toilet 49 12; 146 29; 207 16, 42, 72; 211 59; 231 31; 278 5  
 toilet bowl 49 13  
 toilet cistern 126 14  
 toilet-cleaning vehicle 233 22  
 toilet lid 49 14  
 toilet pan 49 13  
 toilet paper 49 11  
 toiletries 99 27-35  
 toilet roll holder 49 10  
 toilets 317 31  
 toilet seat 49 15  
 toilet water 105 37; 106 9  
 tomahawk 352 16  
 tomato 57 12; 99 82  
 tomato plant 55 44  
 tomb 331 23; 337 16  
 tomb, giant's ~ 328 16  
 tomb, megalithic ~ 328 16  
 tomb, royal ~ 333 1

tombola 306 11  
 tombola booth 308 44  
 tomb recess 331 60  
 tombstone 331 26  
 tom cat 73 17  
 tom-tom 324 48, 49  
 tondo 339 36  
 tone 320 51, 53  
 tone arm 241 21  
 tone arm balance 241 53  
 tone arm lift 241 28  
 tone arm lock 241 27  
 tone generator 238 51  
 toner roll 249 41  
 tongs *Atom* 2 44  
 tongs *Glass Prod.* 162 44  
 tongs *Graphic Art* 340 50  
 tongs, concreter's ~ 119 85  
 tongs, flat ~ 137 24  
 tongs, round ~ 137 25  
 tongue *Man* 17 52; 19 25  
 tongue *Tablew. etc.* 45 52  
 tongue *Game* 88 2  
 tongue *Shoem.* 100 65  
 tongue *Shoes* 101 32  
 tongue *Music. Instr.* 322 52; 326 19  
 tongue, foam rubber ~ 291 24  
 tongue, forked ~ 327 6  
 tonsil 19 23  
 tonsil, palatine ~ 19 23  
 tonsure 331 57  
 tool 195 43  
 tool, stone ~ 328 1  
 tool bag 187 25  
 tool bit holder 149 45  
 tool box *D.I.Y.* 134 35  
 tool box *Mach. Tools* 150 13  
 tool box *Railw.* 212 45  
 tool cabinet 134 1-34  
 tool case 127 49  
 tool cupboard 134 1-34  
 tool grinder 137 18  
 tool-grinding machine 137 18  
 tool post 149 21  
 tool rest 135 5; 149 22  
 tools 119 77-89  
 tool shank 149 49  
 tool shed 37 32; 52 3; 55 1  
 tool slide 149 22  
 tool trolley 195 42  
 tooth *Man* 19 28-37  
 tooth *Mach. Parts etc.* 143 83  
 tooth *Composing Rm.* 174 30  
 tooth *Office* 249 31  
 tooth, bicuspid ~ 19 18  
 tooth, canine ~ 19 17  
 tooth, molar ~ 19 18, 35  
 tooth, porcelain ~ 24 29  
 tooth, premolar ~ 19 18  
 toothbrush, electric ~ 49 29  
 tooth chisel 339 13  
 toothed 370 45  
 tooth glass 49 28  
 toothing, external ~ 143 96  
 toothing, internal ~ 143 95  
 toothing, spiral ~ 143 92-93  
 toothing plane 132 17  
 tooth mug 49 28  
 toothpaste 99 31  
 toothpick holder 266 23

tooth pulp 19 32  
 tooth-root elevator 24 48  
 tooth scaler 24 45  
 top 12 40; 193 10; 323 24  
 top, collapsible ~ *Carriages* 186 52  
 top, collapsible ~ *Car* 193 10  
 top, convertible ~ 193 10  
 top, elasticated ~ 32 33  
 top, fireclay ~ 108 9  
 top, fixed ~ 186 14  
 top, folding ~ 194 10  
 top, hard ~ 193 27  
 top, humming ~ 309 71  
 top, leather ~ 35 19  
 top, marble ~ 265 12  
 top, shirred ~ 29 15  
 top clearer 164 22  
 topgallant stay 219 12  
 top gases 145 38  
 top hat 35 36; 186 25; 289 6  
 top light, white ~ 286 10  
 top lighting, incident ~ 112 63  
 topmark 224 78, 90  
 topmark buoy 224 80  
 topmast 223 39  
 topmast stay 219 11  
 topography, fluvial ~ 13 1-13  
 topper 64 85  
 topping 266 54  
 topping knife 64 87  
 top rail 221 122  
 top ring 89 52  
 top roller, light ~ 164 18  
 tops 145 38  
 topsail schooner, three-masted ~ 220 19  
 top side *Meat* 95 37  
 top side *Paperm.* 173 31  
 top slide 149 22, 42  
 top stroke 277 3  
 top tube 187 16  
 torch 127 26  
 torch lighter 141 27  
 torero 319 21, 25  
 torii 337 11  
 torpedo boat 258 69, 75  
 torpedo housing, underwater ~ 259 36  
 torpedo tube 258 78; 259 79  
 torque converter 190 70  
 torque converter bearing 211 54  
 torque converter lever 65 34  
 torque wrench 195 45  
 torril door 319 11  
 torsional clamp 287 39  
 torso 339 7  
 Torsteel 119 82  
 torten 97 22-24  
 tortrix moth 80 9  
 torus *Art* 334 28, 30  
 torus *Bot.* 370 53  
 totalizer 289 35  
 totalizer window 289 34  
 tote 289 35  
 totem 352 2  
 totem pole 352 1  
 tote window 289 34  
 toucan 363 6  
 touch line 291 9

touch-me-not 377 11  
 touch-tone button 242 25  
 touch-tone pad 242 25  
 toupee wig 355 8  
 toupet 34 2  
 touring bicycle 187 1  
 touring boat 283 26-33  
 touring cycle 187 1  
 touring cycle handlebar 187 2  
 touring kayak 283 61, 70  
 touring moped 188 24  
 tourist 272 28  
 tourist guide 272 27  
 tournament 329 71  
 tournament pennon 254 33  
 tournament saddle 329 87  
 tourneur 275 3  
 tourney 329 71  
 tourniquet, emergency ~ 21 15  
 tourniquet, surgeon's ~ 26 48  
 tow 170 57, 58, 59, 60  
 towage 227  
 towel 106 25; 281 25  
 towel, paper ~ 40 1; 106 5  
 towel rail 49 8  
 tower *Bldg. Site* 119 34  
 tower *Bridges* 215 42  
 tower *Airport* 233 17  
 tower *Gliding* 287 12  
 tower, central ~ 335 6  
 tower, lattice steel ~ 152 36  
 tower, stepped ~ 333 32  
 tower, terraced ~ 333 32  
 tower clock 331 7  
 tower crane 47 39; 119 31  
 tower platform 329 8  
 tower roof, pyramidal ~ 335 7  
 tower slewing crane 119 31  
 tower spotlight 316 21  
 tower tomb 333 21  
 tow hook 227 27  
 towing 216 27  
 towing engine *Rivers* 216 29  
 towing engine *Salvage* 227 7  
 towing engine *Warships* 258 86  
 towing gear 227 6, 6-15, 13  
 towing hawser 216 24; 227 8, 15  
 towing line 286 47  
 towing log 224 54  
 towing machine 227 7; 258 86  
 towing mast 216 28  
 towing path 216 30  
 towing plane 287 2  
 towing track 216 30  
 towing vehicle 194 21, 29  
 towing winch 227 7; 258 86  
 tow line 216 24; 227 8, 15; 286 47  
 town 15 51; 268  
 town banner 218 22  
 town centre 268  
 tow path 216 30  
 tow rope *Rivers* 216 24  
 tow rope *Salvage* 227 8, 15  
 tow rope *Gliding* 287 4  
 tow rope guide 227 9  
 toy, soft ~ 46 13; 47 6, 7, 41  
 toy, wooden ~ 260 80

toy duck 28 10  
 toys 48 21-32  
 toy shop 47 27  
 T position 288 62  
 trace 71 22, 24, 35  
 trace monitor 25 54  
 tracer 153 45  
 tracer element 153 45  
 tracery 335 39-40  
 tracery window 335 39-41  
 trachea 17 50; 20 4  
 tracing head 141 37  
 tracing leg 302 2  
 tracing wheel 129 42  
 track *Atom* 2 37  
 track *Hunt.* 86 8  
 track *Cine Film* 117 82  
 track *Railw.* 202 1-38  
 track *Station* 205 59-61  
 track *Army* 255 87  
 track *Equest.* 289 23  
 track *Cyc. Racing* 290 2  
 track *Winter Sp.* 301 60  
 track, cinder ~ 298 6  
 track, indoor ~ 290 1  
 track, sand ~ 290 24  
 track, synthetic ~ 298 6  
 track, unfenced ~ 15 102  
 track and field events 298  
 track and signal indicator 203 64  
 track-clearing vehicle 213 17  
 track diagram control layout 203 65  
 track diagram control panel 203 66  
 tracker action 326 6-16  
 track format 243 28  
 trackhound 70 42, 43  
 track indicator 65 81  
 track inspection railcar 213 32  
 track racer 290 2  
 track rider 290 2  
 track rider, motor-paced ~ 290 14  
 track rod 65 47  
 track-rod ball-joint 192 80  
 tracksuit 33 27  
 tracksuit bottoms 33 29  
 tracksuit top 33 28  
 trackwalker 202 44  
 tract 330 57  
 traction motor 211 6  
 traction motor blower 211 15  
 tractive effort indicator 211 26  
 tractive unit 194 21, 29  
 tractor 62 38; 64 46; 65 20; 67 17; 85 43; 194 21, 29; 273 55  
 tractor, narrow-track ~ 78 21  
 tractor driver 62 39  
 tractor unit 85 43  
 trader, itinerant ~ 308 51  
 trades 9 48, 49  
 tradesman 98 41  
 trade winds 9 48, 49  
 traffic control 264 9  
 traffic control cuff 268 31  
 traffic helicopter 264 1



traffic light post 268 53  
 traffic lights 268 52  
 traffic patrol 264 9  
 traffic policeman 268 30  
 traffic sign 268 66  
 trail 86 8  
 trail, scented ~ 289 49  
 trailer *Farm Bldgs.* 62 40  
 trailer *Agr.* 63 27, 38  
 trailer *Blacksm.* 138 10  
 trailer *Lorries etc.* 194 22  
 trailer *Station* 206 3, 35  
 trailer *Camping* 278 52  
 trailer, collapsible ~ 278 3  
 trailer, folding ~ 278 3  
 trailer, tip-up ~ 56 42  
 trailer frame 138 28  
 trailering 278  
 trailer wagon 200 25  
 trailing arm 191 27; 192 66  
 trailing cable hanger 133 39  
 trailing cable support 133 39  
 trailing edge *Sailing* 284 45  
 trailing edge *Gliding* 287 37  
 trailing link arm 192 81  
 trail rope 288 69  
 train 355 80  
 train, electric ~ 197  
 train, interurban ~ 197  
 train, local ~ 208 1-12  
 train, short-distance ~ 208 1-12  
 train, suburban ~ 205 25  
 train control system, inductive ~ 211 7, 38; 212 14, 38  
 train deck 221 80  
 trainee pastry cook 265 6  
 trainer 101 35  
 train ferry *Map* 15 12  
 train ferry *Ship* 221 74  
 train heating generator 212 39  
 train heating system 212 17, 18  
 train heating system transformer 212 40  
 train heating voltage indicator 211 27  
 training apparatus 299 20-24  
 training equipment 299 20-24  
 training ship 258 95  
 training shoe 101 35  
 train plate, bottom ~ 110 37  
 'trains' 233 34  
 train schedule 204 50  
 train service, local ~ 208 1-30  
 trainset 209 1  
 trainset, experimental ~ 209 23  
 train set, wooden ~ 47 37; 48 29; 273 27  
 trajectory 89 36  
 tram 197; 268 46  
 tramline 268 23  
 trammel 125 11  
 trampoline 297 10  
 tram service 197 13  
 tram stop 197 35; 268 25  
 tram stop sign 197 36; 268 26  
 tram timetable 268 27

transept 335 3  
 Trans-Europe Express 209 1-22  
 Trans-Europe Express, electric ~ 205 34  
 transfer blanket 249 40  
 transfer cylinder 180 36  
 transfer drum 180 36  
 transfer entry 250 25  
 transfer port 242 57  
 transformer *Clocks* 110 8  
 transformer *Power Plant* 153 9-18  
 transformer *Railw.* 211 10  
 transformer, high-tension ~ 211 4  
 transformer, mobile ~ 152 30, 39  
 transformer, transportable ~ 152 30, 39  
 transformer connection 153 19  
 transformer station *Brew.* 92 21  
 transformer station *Hydr. Eng.* 217 46  
 transformer tank 152 40  
 transforming section 23 56  
 transillumination 112 60  
 transistor, actuating ~ 195 19  
 Transitional 342 5  
 'transit passengers' 233 27  
 transit shed 225 9  
 transmission 209 18  
 transmission, multi-speed ~ 65 36  
 transmission cable 326 53  
 transmission line 154 16  
 transmission line, high-voltage ~ 152 32  
 transmission oil 209 15; 212 36, 43  
 transmission oil temperature gauge 212 20  
 transmissometer 10 60  
 transmitted-light microscope 112 14  
 transmitter 10 59, 62  
 transmitting antenna 288 88  
 transom *Dwellings* 37 35  
 transom *Ship* 221 42  
 transom *Sailing* 284 35; 285 49  
 transom *Motorboats etc.* 286 26  
 transom stern 221 42; 258 26; 259 11; 285 48  
 transparency 242 42  
 transparency arm 177 44  
 transparent gage 59 25  
 transplanting *Plant Propagn.* 54 5  
 transplanting *Forestry* 84 10  
 transport aircraft, medium-range ~ 256 14  
 transport and communications aircraft 256 24  
 transport and rescue helicopter 256 18  
 transporter, suction ~ 74 49

transporter container-loading bridge 225 46; 226 2  
 transporter loading bridge 225 20  
 transport helicopter 232 21  
 transport lug 152 48  
 transport roller *Cine Film* 117 34  
 transport roller *Joiner* 132 72  
 transport sprocket 115 26  
 transport vehicle 62 18  
 transtainer 226 2  
 transtainer crane 226 2  
 transversal chicane 301 68  
 transverse motion 149 17  
 trap *Bathrm. etc.* 49 27  
 trap *Hunt.* 86 20  
 trap *Plumb. etc.* 126 26  
 trapdoor 38 13  
 trapeze *Sailing* 284 12  
 trapeze *Circus* 307 6  
 trapeze artist 307 7  
 trapeze platform 307 5  
 trapezium 346 37  
 trapezius 18 52  
 trap opening 316 32  
 trapper 306 8  
 trapping 86 19-27, 19  
 trappings *Horse* 71 16  
 trappings *Chivalry* 329 74  
 trash bin *Doc.* 22 70  
 trash bin *Butch.* 96 46  
 trash can 199 3  
 trash conveyor 64 80  
 travel agency 271 24  
 travel centre 204 28  
 traveler *see* traveller  
 travelling *see* travelling  
 traveller *Cotton Spin.* 164 51, 55  
 traveller *Sailing* 284 27  
 Travellers' Aid 204 45  
 travelling bag 205 10  
 travelling box 77 44  
 travelling salesman 209 29  
 traverse 152 37  
 traversing handle 255 48  
 trawler 90 11; 221 86  
 trawl fishing 90 11-23  
 trawling 90 11-23  
 trawl warp 90 12  
 tray *Living Rm.* 42 30  
 tray *Pest Contr.* 83 17  
 tray *Game* 88 8  
 tray *Café* 265 3, 14  
 tray *Restaurant* 266 19, 45, 63  
 tray *Fair* 308 52  
 tray, revolving ~ 204 37  
 tray, round ~ 44 24  
 tray counter 266 64  
 tray for purchases 271 15  
 tray thermometer 116 13  
 tread 50 38; 123 32, 47  
 tread, rubber ~ 187 85  
 treading water 282 39  
 treadle *Poultry Farm* 74 63  
 treadle *Dressm.* 103 11  
 treadle *Tailor* 104 13  
 treadle control 168 48  
 treadle lever 166 58

treadle sewing machine 309 1  
 treading diagram 171 10  
 tread sledge 304 29  
 treasury notes 252 29-39  
 treble belly bridge 325 11  
 treble bridge 325 11  
 treble clef 320 8  
 treble control 241 31  
 treble coupler 324 41  
 treble plume 254 30  
 treble register 324 41  
 treble stop 324 41  
 treble string 325 10  
 treble tuning 241 43  
 treble viol 322 23  
 tree 272 59, 61; 370 1  
 tree, conical ~ 272 13  
 tree, globe-shaped ~ 272 12  
 tree, pyramidal ~ 52 16; 272 19  
 tree brush 56 23  
 tree cake 97 46  
 tree calliper, steel ~ 84 21  
 tree felling 84 15-37  
 tree frog 364 24  
 tree guard 118 80  
 tree nursery *Map* 15 111  
 tree nursery *Market Gdn.* 55 3  
 tree nursery *Forestry* 84 6, 10  
 tree of life 372 39  
 tree pruner 56 11  
 trees, coniferous ~ *Map* 15 1  
 trees, coniferous ~ *Conifers* 372 1-71  
 trees, deciduous ~ 371 1-73  
 trees, mixed ~ 15 14  
 trees, non-coniferous ~ 15 4  
 trees, ornamental ~ 373; 374  
 trees, young ~ 84 10-11  
 tree scraper 56 14  
 tree stake 52 31  
 tree stump 84 14  
 tree toad 364 24  
 treetop 272 60; 370 4  
 tree trunk 84 19; 370 2, 7  
 tree trunk, hollowed-out ~ 218 7  
 trefoil arch 336 32  
 trellis 89 5  
 trellis, wire ~ 78 9  
 trembling poplar 371 21  
 trenchcoat 33 57  
 trestle *Overh. Irrign.* 67 7  
 trestle *Carp.* 120 18, 19  
 trestle *Shipbuild.* 222 27  
 trestle, paperhanger's ~ 128 52  
 trestle rope 122 67  
 triad 321 1-4  
 triakis-octahedron 351 10  
 trial 290 24-28  
 trial frame 111 3  
 trial lens case 111 45  
 triangle *Fish Farm.* 89 85  
 triangle *Drawing Off.* 151 7, 8  
 triangle *Railw.* 203 13  
 triangle *School* 260 37  
 triangle *Music. Instr.* 323 49  
 triangle, acute-angled ~ 346 28  
 triangle, equilateral ~ 346 26

triangle, obtuse-angled ~ 346 30  
 triangle, pipe clay ~ 350 17  
 triangle, right-angled ~ 346 32  
 triangle cut 36 67  
 triangles, plane ~ 346 26-32  
 triangle sign 203 13  
 triangle symbol 345 24  
 triangulation point 14 49; 15 71  
 triangulation station 14 49; 15 71  
 Triangulum Australe 3 40  
 triceps brachii 18 38  
 trick button 117 84  
 trick ski 286 56  
 trichine crystal system 351 26  
 Tricolour 253 16  
 triforium 335 33  
 trigger *Slaughterho.* 94 6  
 trigger *Army* 255 5  
 trigger guard 87 10  
 trigger mechanism 255 20  
 trigger valve 270 62  
 triglyph 334 15  
 trilby hat 35 22  
 trill 321 17, 18  
 trim 46 5  
 trimaran 278 16  
 trimmer *Carp.* 120 41  
 trimmer *Roof* 121 71  
 trimmer *Paperhanger* 128 43  
 trimmer joist 120 41  
 trimming, fur ~ 30 59  
 trimming, lace ~ 31 32  
 trimming, leather ~ 30 18  
 trimming blade 85 22  
 trimming knife 128 38  
 trimming machine 85 18  
 trimmings 266 55  
 trimming tab 288 25, 30  
 trimming table 132 64  
 trimming tool 162 43  
 trim tab 288 25, 30  
 triplane 229 6  
 triple-spar tail construction 257 20  
 triplet 321 23  
 trip mileage recorder 191 74, 77  
 tripod *Photog.* 114 42; 115 99  
 tripod *Paperm.* 173 6  
 tripod *Chem.* 349 15; 350 14  
 tripod, wooden ~ 313 13  
 tripod bush 115 30  
 tripod crane 222 6  
 tripod lattice mast 258 41  
 tripod leg 114 43  
 tripod socket 115 30  
 tripod spotlight 310 52  
 trireme 218 9-12  
 triton 327 40  
 trochilus 334 29  
 troika 186 45  
 trolley *Blacksm.* 138 35  
 trolley *Lorries etc.* 194 42  
 trolley *Tram* 197  
 trolley *Station* 206 14  
 trolley *Town* 268 46  
 trolley, electric ~ 205 29

trolley, metal ~ 74 31  
 trolley bus 194 40  
 trolley bus trailer 194 44  
 trolley service 197 13  
 trolley shoe 194 42  
 trolley shoe, aluminium alloy ~ 197 24  
 trolley shoe, carbon ~ 197 24  
 trolley stop 197 35; 268 25  
 trolley stop sign 197 36; 268 26  
 trolley wire 197 41; 205 58  
 trolley wire contact point 197 40  
 trombone 323 46  
 trombone slide 323 47  
 tropaeolum 53 4  
 trophus 358 26  
 trophy 352 15, 30  
 tropic of Cancer 3 4  
 tropics 14 10  
 tropopause 7 9  
 troposphere 7 1  
 trot 72 41  
 trotter *Meat* 95 38, 42, 48  
 trotter *Equest.* 289 28  
 trotting silks 289 26  
 troubadour 329 70  
 trough *Phys. Geog.* 12 18  
 trough *Mills* 91 14  
 trough *Railw.* 202 34  
 trough *Art* 336 48  
 trough, equatorial ~ 9 46  
 trough, outdoor ~ 62 9  
 trough gutter 122 83  
 trough mixer, double shaft ~ 159 10  
 trough plane 12 19  
 trough surface 12 19  
 trough valley 13 55  
 trough vault 336 47  
 trouser leg 33 6  
 trouser pocket 33 47  
 trousers, boy's ~ 29 60  
 trouser suit 30 57  
 trouser turn-up 31 40  
 trout 364 15  
 trout breeding 89 14  
 trout fry 89 16  
 trout pond 89 6  
 trout rearing 89 14  
 trowel *Gdn. Tools* 56 6  
 trowel *Bldg. Site* 118 52  
 trub 93 2  
 trub removal 93 1-5  
 truck *Bldg. Site* 119 32  
 truck *Power Plant* 152 41  
 truck *Sawmill* 157 16  
 truck *Refuse Coll.* 199 38  
 truck *Railw.* 207 4; 208 4; 212 2; 213 13  
 truck *Docks* 226 4, 19  
 truck *Flags* 253 1  
 truck, electric ~ 205 29; 206 2, 34  
 truck, heavy ~ 194 20; 200 7  
 truck, large-capacity ~ 158 14  
 truck, light ~ 194 1, 5  
 truck, toy ~ 47 38; 273 62  
 truck farm 55 1-51, 3  
 truck garden 55; 55 1-51, 3



trucks 194  
 truck tire 273 19  
 truck-to-truck handling 226 7  
 truck-to-truck operation 225 41  
 truck-to-truck system 225 41  
 truck with trailer 213 34  
 trudgen 282 37  
 trudgen stroke 282 37  
 truffle *Grocer* 98 86  
 truffle *Edib. Fungi* 381 9, 10, 11  
 trumpet 318 6; 323 43  
 trumpet, bronze ~ 322 1  
 trumpet daffodil 60 3  
 trumpeter 318 7  
 trumpet narcissus 60 3  
 truncheon *Heraldry* 254 31  
 truncheon *Police* 264 19  
 trunk *Man* 16 22-41  
 trunk *Forestry* 84 19  
 trunk *Car* 191 24; 193 23  
 trunk *Mammals* 366 21  
 trunk *Bot.* 370 2  
 trunk, horse's ~ 327 45  
 trunk, main ~ 88 11  
 trunk, woman's ~ 327 24  
 trunk-bending forwards 295 33  
 trunk-bending sideways 295 32  
 trunk call 237 3  
 trunk-hose, panned ~ 355 34  
 trunk-hose, stuffed ~ 355 31  
 trunk lid 191 7  
 trunk line 15 21  
 trunk pipeline 145 35  
 trunk road 15 17  
 trunks 32 27  
 truss 215 3  
 trussed arch bridge 215 23  
 trussed-rafter roof 121 34  
 truss element 215 24  
 trusser 130 12  
 truss joint 215 37  
 truss post 121 68  
 truss tower 155 43  
 trying plane 132 39  
 trysail 220 1  
 try square 120 69; 132 6; 134 26  
 try-your-strength machine 308 11  
 tsetse fly 81 43  
 T-shirt 31 38  
 T-shirt, children's ~ 29 27  
 T-square 151 9  
 tsunami 11 53  
 T-tail 229 29; 256 31-32; 287 10  
 T-tail unit 229 29; 256 31-32; 287 10  
 tub *Market Gdn.* 55 48  
 tub *Wine Grow.* 78 10  
 tub, wooden ~ 91 27  
 tuba 323 44  
 tubaphone 324 61  
 tube *Hosp.* 25 13; 26 17  
 tube *Pest Contr.* 83 31  
 tube *Optic. Instr.* 111 18  
 tube *Optic. Instr.* 113 8  
 tube *Bicycle* 187 30  
 tube *Music. Instr.* 323 29; 326 22  
 tube *Invertebr.* 357 23  
 tube *Edib. Fungi* 381 17  
 tube, diaphragmed ~ 10 27  
 tube, eustachian ~ 17 65  
 tube, fallopian ~ 20 81  
 tube, steel ~ 155 30  
 tube, telescopic ~ 65 77  
 tube, uterine ~ 20 81  
 tube bin 255 72  
 tube cap 260 52  
 tube centre section 113 9  
 tube clamp 40 20; 350 30  
 tube clip 40 20; 350 30  
 tube connection 6 26  
 tube holder 22 46  
 tuber *Arable Crops* 68 40  
 tuber *Bot.* 370 79  
 tuberosity 60 9  
 tuberosity 80 27  
 tube support 27 47  
 tube valve 187 31  
 tube well 269 60  
 tubing 145 20, 24  
 tub plant 55 47  
 tuck and miss stitch 171 44, 47  
 tuck jump 282 14; 295 36; 297 40  
 tuck stitch, pulled-up ~ 171 45, 48  
 tuck stitch, staggered ~ 171 46  
 tue iron 137 6  
 tuff 11 19  
 tuff deposit 11 26  
 tuft 73 7  
 tufted lark 361 19  
 tuft of grass 375 44  
 tug *Shipbuild.* 222 42  
 tug *Docks* 225 15  
 tug *Salvage* 227 5, 16  
 tug *Gliding* 287 2  
 tulip poplar 374 1  
 tulip tree 374 1  
 tulle background 102 16  
 tulle lace 102 15  
 tulle work 102 15  
 tumble drier 50 28  
 tumbler 140 38  
 tumbler, seaward ~ 226 23  
 tumbler, shore-side ~ 226 28  
 tumbler lever 149 10  
 tumbler reverse lever 149 14  
 tumbler spring 140 42  
 tumbling separator, mechanical ~ 64 75  
 tumulus 328 16  
 tun 92 45  
 tun, wooden ~ 91 27  
 tundra climate 9 57  
 tuner 241 9, 37; 317 22  
 tuner, automatic ~ 23 38  
 tunic *Ladies' Wear* 30 29  
 tunic *Ship* 221 115  
 tunic *Hist. Cost.* 355 12, 25  
 tunic, long ~ 355 19  
 tunics 355 12  
 tunic dress 30 29

tunic top 30 29  
 tuning control 241 9  
 tuning crook 326 21  
 tuning device 326 30  
 tuning dial 241 7  
 tuning flap 326 30  
 tuning fork element 110 9  
 tuning fork principle 110 6  
 tuning fork watch 110 6  
 tuning hammer 325 20  
 tuning hole 326 33  
 tuning key 325 20  
 tuning knob 241 9; 309 21  
 tuning meter 241 39, 54  
 tuning peg 323 18; 324 11; 325 17  
 tuning pin 324 23; 325 17  
 tuning screw 323 59  
 tuning slot 326 33  
 tuning tongue 326 30  
 tuning wedge 325 21  
 tuning wire 326 21  
 tunnel *Map* 15 70  
 tunnel *Soft Fruit* 58 63  
 tunnel *Station* 204 23  
 tunnel *Railw.* 214 6  
 tunnel, plastic ~ 55 40  
 tunnel, underground ~ 198 29  
 tunnel entrance 233 6  
 tunnel kiln 161 5  
 tunnelling machine 144 32  
 tunnel vault 335 19; 336 38  
 tup *Blacksm.* 137 10  
 tup *Forging* 139 12, 26  
 turban 353 46  
 turbine 67 20; 209 18; 232 40, 47  
 turbine, high and low pressure ~ 259 62  
 turbine, high-pressure ~ 232 53  
 turbine, low-pressure ~ 232 54  
 turbine, reversible ~ 155 39  
 turbine, supercharged ~ 212 51  
 turbine engine 232 17, 24; 257 15  
 turbine exhaust 146 5  
 turbine house 152 22; 217 43  
 turbine inlet 155 40, 41  
 turbine monitoring panel 153 30  
 turbine transmission 209 10  
 turbine unit 209 24  
 turbogenerator 154 34  
 turbogenerator set 154 33  
 turbogenerator unit 153 23-30  
 turbojet engine 231 26  
 turbojet engines 232 33-50  
 turbopropeller engine 231 5; 232 30, 51  
 turbopropeller plane 231 4  
 turboprop engine 231 5; 232 30, 51; 256 16  
 turboprop plane 231 4  
 tureen 45 15  
 turkey 73 28  
 turkey cock 73 28  
 turkey hen 73 28

turkey leg 99 59  
 Turkish delight 98 84; 308 18  
 turk's cap 377 4  
 turk's cap lily 377 4  
 turn *Athletics* 298 24  
 turn *Music. Not.* 321 21  
 turnbuckle 130 4; 202 31  
 turner *Brew.* 92 24  
 turner *Turner* 135 20  
 turnery 135 1-26  
 turn indicator *Car* 191 76  
 turn indicator *Aircraft* 230 12  
 turn indicator light 189 37, 45  
 turn indicator light, front ~ 191 19  
 turning head, multiple ~ 149 41  
 turning judge 282 26  
 turning tools 135 14, 15, 24  
 turnip moth 80 42  
 turnout 203 51, 52  
 turn slot 288 46  
 turntable *Porcelain Manuf.* 161 11  
 turntable *Electrotyp. etc.* 178 26  
 turntable *Lorries etc.* 194 31  
 turntable *Bridges* 215 64  
 turntable *Docks* 226 56  
 turntable *Audio* 241 20  
 turntable *Army* 255 73  
 turntable, small ~ 142 41  
 turntable glazing machine 161 16  
 turn-up 30 35; 31 54; 33 35  
 turpentine separator 172 14  
 turret *Mach. Tools* 149 40  
 turret *Warships* 258 47, 67, 70; 259 31, 52, 71  
 turret *Chivalry* 329 28, 35  
 turret, aft ~ 259 44  
 turret, armoured ~ 255 84  
 turret, forward ~ 259 43  
 turret head 117 46; 313 32  
 turret lathe 149 38  
 turtle dove 359 23  
 tusk 88 54; 366 22; 367 22  
 tutu 314 29  
 tuyère 147 20  
 TV set 42 8; 46 14  
 twee deck 223 76  
 tweeter 241 15  
 tweezers 109 14; 174 18  
 twig 370 6  
 twilight area 4 21  
 twin anti-aircraft gun 258 31  
 twin anti-aircraft gun turret 259 30  
 twin anti-aircraft missile launcher 259 25, 33  
 twin anti-aircraft rocket launcher 259 25, 33  
 twin columns 336 6  
 twin edger 157 57  
 twin engine, horizontally-opposed ~ 189 47  
 twin etching machine 178 30  
 twin hull 284 65  
 twin launching catapult 259 14  
 Twins 3 28; 4 55

twin seat 188 42  
 twin seat, racing-style ~ 189 14  
 twin set 31 49  
 twin-spar wing construction 257 27  
 twin tail unit 229 32, 34  
 twist bit 134 49; 140 59  
 twist drill 134 49; 140 59  
 twist grip *Pest Contr.* 83 19  
 twist grip *Motorcycles etc.* 188 31  
 twist grip throttle control 188 30; 189 29  
 twist of tobacco 107 18  
 twitch grass 61 30  
 two-eight time 320 28  
 two-four time 320 29  
 two-high mill 148 53  
 two-line brevier 175 30  
 two-line primer 175 31  
 two-pipe system 126 22  
 two-seater 193 28  
 two-stroke blending pump 196 13  
 two-toed sloth 366 11  
 two-two time 320 30  
 two-way tap 350 49  
 tympan 340 37  
 tympanum 335 26  
 type *Composing Rm.* 174 7, 15, 44; 175 1-17, 38  
 type *Letterpress* 181 37  
 type *Office* 249 15, 29  
 type *Money* 252 12  
 type, black-letter ~ 342 1, 2, 3  
 type, bold ~ 175 2  
 type, bold condensed ~ 175 10  
 type, boldfaced ~ 175 2  
 type, extra bold ~ 175 9  
 type, Gothic ~ 342 1  
 type, heavy ~ 175 2  
 type, italic ~ 175 7  
 type, light face ~ 175 8  
 type, Schwabacher ~ 342 2  
 type, semibold ~ 175 3  
 type area 185 59  
 type bed 180 78; 181 17  
 typecase 174 3  
 type casting 175 32-37  
 type character 174 7; 175 38  
 type cleaner 247 8  
 type-cleaning brush 247 7  
 type-cleaning kit 247 8  
 type disc 176 20  
 type face 174 31; 175 42  
 type faces 342 1-15  
 type forme 340 32  
 typefounding 175 32-37  
 type height 175 44  
 type line 175 43  
 type magazine 174 21  
 type matrix 174 47; 176 16  
 type matter 174 15; 175 1-17; 181 37  
 types 342 1-15  
 typescript *Composing Rm.* 174 6  
 typescript *Script* 342 9  
 typesetter 174 5

typesetting, computer-controlled ~ 176 14  
 typesetting computer 176 10  
 type size 175 18, 46  
 types of ship 221  
 typewriter 209 28; 248 22; 309 79  
 typewriter, electric ~ 249 1  
 typewriter rubber 247 26  
 typewriting 342 9  
 typhoon wheel 308 46  
 typing compartment 209 26  
 typing desk 245 25; 248 26  
 typing opening 249 19  
 typing window 249 19  
 typist 248 21  
 typographer beetle 82 22  
 tyre 191 15  
 tyre, high-pressure ~ 187 30  
 tyre, pneumatic ~ 187 30; 305 86  
 tyre, rubber ~ 273 54  
 tyre, tubular ~ 290 19, 23  
 tyre chain 304 10  
 tyre pressure gauge 196 17  
 tyre tread 189 27

## U

udder 75 18  
 ulna 17 14  
 ulnar side of the hand 19 70  
 ultra large crude carrier 221 1  
 umbel 383 65  
 umbel, simple ~ 370 72  
 Umbellula encrinus 369 14  
 umbo 329 58  
 umbra 4 35  
 umbrella *Hall* 41 15  
 umbrella *Station* 205 12  
 umbrella *Art* 337 22  
 umbrella *Invertebr.* 357 15  
 umbrella, telescopic ~ 41 12  
 umbrella stand 41 14  
 umpire 292 55, 65; 293 19, 68  
 unau 366 11  
 uncial 341 17  
 underbrush 84 5  
 undercarriage 194 32  
 undercarriage, retractable ~ 232 10  
 undercarriage housing 256 15  
 undercarriage hydraulic cylinder 257 41  
 undercarriage unit, forward-retracting ~ 257 40  
 undercarriage unit, main ~ 230 41; 231 28; 256 26; 257 40; 288 33  
 undercarriage unit, retractable ~ 231 28  
 underclothes, ladies' ~ 32 1-15  
 underclothes, men's ~ 32 22-29  
 undercut *Forestry* 84 28  
 undercut *Meat* 95 13  
 undercut swing saw 157 24, 64  
 underframe 207 3; 208 5  
 undergown 355 37



undergrasp 296 41  
 undergrowth 84 5  
 underlip 72 10  
 under-ridge tile 122 5  
 undershirt 296 61  
 underside 173 34  
 underskirt 309 85  
 understructure 191 2  
 under tile 122 57  
 underwater case 117 57  
 underwater housing 117 57  
 underwater massage bath 281 31  
 underwater salvo missile launcher 259 24  
 underwater salvo rocket launcher 259 24  
 underwater swimmer 279 7; 280 37  
 underwater swimming 279 7-27; 282 38  
 underwater swimming set 279 8-22  
 underwear 32  
 underwear, ladies' ~ 32 1-15  
 underwear, men's ~ 32 22-29  
 underwing tank 256 4  
 underwood 84 5, 32  
 uneven bars 297 3  
 ungulates 366 25-31; 367 1-10  
 ungulates, even-toed ~ 366 28-31  
 ungulates, odd-toed ~ 366 25-27  
 unicorn 254 16; 327 7  
 uniform 264 7  
 uniform cap 264 8  
 Union Jack 253 15  
 union of sets 348 5-6  
 unison 321 6  
 unison interval 321 6  
 unit, assistant's ~ 24 9  
 unit, slide-in ~ 27 32  
 unit indicator 174 36  
 unit load 225 49; 226 9  
 unit load, foil-wrapped ~ 225 42  
 units 344 3  
 university 262 1-25  
 university lecturer 262 3  
 university library 262 11-25  
 unloading unit 62 42  
 unwind station 173 39  
 up-and-down roundabout 308 5  
 up-and-down slide 273 52  
 upcurrent, frontal ~ 287 vp  
 upholstery 134 59  
 upper, corduroy ~ 101 26  
 upper, rubber ~ 300 45  
 upper, soft-leather ~ 101 46  
 upper, terry ~ 101 23  
 upper arm hang 296 58  
 upper board 326 15  
 upper board groove 326 14  
 uppercut 299 32  
 upper fore topgallant sail 219 59  
 upper fore topgallant yard 219 36

upper fore topsail 219 57  
 upper fore topsail yard 219 34  
 upper hatch 6 45  
 upper-leather shears 100 42  
 upper main topgallant sail 219 65  
 upper main topgallant yard 219 42  
 upper main topsail 219 63  
 upper main topsail yard 219 40  
 Upper Muschelkalk 154 58  
 Upper Permian 154 62  
 upright *Gymn.* 296 9  
 upright *Athletics* 298 13, 33  
 upright *Music. Instr.* 325 1  
 upright kneeling position 295 7  
 upright piano 325 1  
 upright spin 302 9  
 upsett 136 25  
 upsetting block 137 16  
 upstart 297 28  
 upward ventilator 154 81  
 U-rail 214 22  
 Uranus 4 50  
 ureter 20 32  
 urethra 20 68  
 urethroscope 23 20  
 urine sediment chart 23 58  
 urn 328 40; 331 31  
 urn, cinerary ~ 328 38  
 urn, domestic ~ 328 38  
 urn, embossed ~ 328 38  
 urn grave 328 39; 331 30  
 Ursa Major 3 29  
 Ursa Minor 3 34  
 ursine seal 367 18  
 usher 315 12  
 usherette 312 4  
 uterus 20 79  
 utility room door 118 6  
 utility room window 118 5  
 U-tube 349 2  
 U-valley 13 55  
 uvula 19 22

## V

vacancy 342 70  
 vacuum 240 21  
 vacuum back 177 35  
 vacuum box 173 15  
 vacuum chamber 252; 83 12; 159 12  
 vacuum cleaner *Household* 50 80  
 vacuum cleaner *Goldsm. etc.* 108 43  
 vacuum cleaner, cylinder ~ 50 68  
 vacuum cleaner, upright ~ 50 58  
 vacuum equipment 145 51  
 vacuum film holder 177 8  
 vacuum frame 179 13; 182 2  
 vacuum line 74 50; 75 29  
 vacuum printing frame 179 13

vacuum pump *Intern. Combust. Eng.* 190 59, 60  
 vacuum pump *Water* 269 8  
 vacuum pump switch 179 19  
 vacuum ripening tank 169 11  
 vacuum timing control 190 9  
 vagina 20 86  
 Valasian dulcimer 322 34  
 Valenciennes 102 18  
 valerian 380 5  
 valley *Phys. Geog.* 13 52-56  
 valley *Roof* 121 15; 122 11, 82  
 valley, dry ~ 13 75  
 valley, synclinal ~ 13 56  
 valley, U-shaped ~ 13 55  
 valley, V-shaped ~ 13 53, 54  
 valley bottom 13 67; 215 60  
 valley floor 13 67  
 valley glacier 12 49  
 valley rafter 121 64  
 valley station 214 39  
 valley station platform 214 51  
 valley temple 333 8  
 value 250 18  
 value, note's ~ 320 7  
 valve *Roof & Boilerr.* 38 73  
 valve *Bicycle* 187 31  
 valve *Airports* 288 77  
 valve *Ball Games* 291 18  
 valve *Music. Instr.* 323 40; 324 66  
 valve, aortic ~ 20 49  
 valve, atrioventricular ~ 20 46, 47  
 valve, bicuspid ~ 20 47  
 valve, mitral ~ 20 47  
 valve, pulmonary ~ 20 50  
 valve, sliding ~ 217 55  
 valve, tricuspid ~ 20 46  
 valve control house 217 42, 63  
 valve horn 323 41  
 valve house 217 42, 63  
 valve housing 217 54  
 valve line 288 78  
 valve sealing cap 187 32  
 valves of the heart 20 46-47  
 valve tube 187 31  
 vambrace 329 47  
 vamp *Shoem.* 100 60  
 vamp *Carnival* 306 32  
 vamplate 329 82  
 van, medium ~ 194 7  
 Vandyke beard 34 13  
 vane, curved ~ 91 38  
 vane, flat ~ 91 40  
 vang 284 21  
 vanilla 382 48  
 vanilla plant 382 46  
 vanilla pod 382 48  
 vans 194  
 vaquero 306 31  
 variable 345 14  
 variable depth sonar 259 40  
 variable focus lens 313 23  
 variable platen action lever 249 24  
 varifocal lens 313 23  
 variometer 230 14  
 varnish 338 12  
 varnishing 129 14  
 vas deferens 20 74

vase, Greek ~ 334 37  
 vase, hand-painted ~ 161 18  
 vase, porcelain ~ 337 5  
 vase, stone ~ 272 35  
 vastus lateralis 18 46  
 vastus medialis 18 46  
 vat *Fish Farm.* 89 4  
 vat *Paperm.* 172 25; 173 47  
 vat, concrete ~ 79 3  
 vat, stainless steel ~ 79 4  
 vatman 173 46  
 vault 79 1  
 vault, cloistered ~ 336 41  
 vault, groined ~ 336 42  
 vault, ribbed ~ 336 43  
 vault, stalactitic ~ 337 17  
 vault, stellar ~ 336 44  
 vault, types of ~ 336 38-50  
 vaulter *Athletics* 298 29  
 vaulter *Circus* 307 32  
 vaulting 298 9-41  
 vaulting, Romanesque ~ 335 17  
 vaulting horse 296 1; 297 1  
 vaulting pole 298 28  
 V-belt 64 78  
 V-belt drive 180 58  
 V-cardan 67 31  
 VCR cassette 243 5  
 veal 95 1-13  
 vee-belt drive 180 58  
 vee-neck 31 68  
 vee-tail 229 31  
 Vega 3 22  
 vegetable, frozen ~ 99 61  
 vegetable basket 99 81  
 vegetable crate 55 43  
 vegetable dish 45 25  
 vegetable garden 52  
 vegetable oil 98 23  
 vegetable patch 52 26  
 vegetable plants 57  
 vegetable plate 45 33  
 vegetable platter 45 33  
 vegetable plot 52 26; 55 39  
 vegetables 57  
 vegetables, canned ~ 96 27  
 vegetable spoon 45 74  
 vegetarian meal 266 62  
 vehicle 195 47  
 vehicle, articulated ~ 194 28  
 vehicle, electrically-powered ~ 188 20  
 vehicle ferry 15 47  
 vehicle ramp 206 1  
 vehicles 186 1-54  
 vehicles, horse-drawn ~ 186 1-54  
 vehicle tanker 194 28  
 veil 381 5  
 veil, bridal ~ 332 20  
 veil, widow's ~ 331 39  
 vein 370 29  
 vein, frontal ~ 18 6  
 vein, iliac ~ 18 18  
 vein, jugular ~ 18 2  
 vein, portal ~ 20 39  
 vein, pulmonary ~ 18 12; 20 56  
 vein, subclavian ~ 18 8  
 vein, temporal ~ 18 4

velum 381 5  
 velum palati 19 21  
 vena cava, inferior ~ 18 15; 20 57  
 vena cava, superior ~ 18 9; 20 53  
 venation 370 29  
 vendor 308 17  
 veneer 133 2  
 veneer-peeling machine 133 1  
 veneer-splicing machine 133 3  
 V-engine 190 1  
 vent *Phys. Geog.* 11 28  
 vent *Airports* 288 82  
 vent, volcanic ~ 11 17  
 ventilating tile 122 7  
 ventilation control knob 26 27  
 ventilation drum 74 29  
 ventilation drum motor 74 33  
 ventilation flap *Market Gdn.* 55 41  
 ventilation flap *Railw.* 213 16, 29, 30  
 ventilation shaft *Brew.* 92 14  
 ventilation shaft *Coal* 144 21  
 ventilation slit 50 30  
 ventilation switch 191 83  
 ventilation system 6 26  
 ventilation system, automatic ~ 191 30  
 ventilation window 55 10  
 ventilator *Bathrm. etc.* 49 20  
 ventilator *Poultry Farm* 74 10, 17  
 ventilator *Railw.* 207 9  
 ventilator *Ship* 221 41  
 ventilator *Water* 269 27  
 ventilator *Disco* 317 30  
 ventilator *Zoo* 356 17  
 ventilator, hinged ~ 55 10  
 ventilator grill 258 43  
 ventilator lead 223 41  
 ventilator opening 258 43  
 ventilators 55 10-11  
 vent mast 221 38  
 vent pipe 155 11  
 vent prop 55 18  
 ventral part 95 39  
 ventricle 20 51  
 vents 55 10-11  
 venturi 192 8  
 venturi throat 190 15  
 Venus 4 44  
 Venus's flytrap 377 14  
 Venus's slipper 376 27  
 verge 37 8; 121 3  
 verger 330 26, 58  
 Vermes 357 20-26  
 vermou 98 62  
 vernier *Metalwkr.* 140 55  
 vernier *Navig.* 224 5  
 vernier calliper gauge 140 52; 149 67  
 vernier depth gauge 140 54; 149 72  
 vernier scale 149 69  
 vert 254 29  
 vertebra, cervical ~ 17 2

vertebra, coccygeal ~ 17 5; 20 60  
 vertebra, dorsal ~ 17 3  
 vertebra, lumbar ~ 17 4  
 vertebra, thoracic ~ 17 3  
 vertex *Man* 16 1  
 vertex *Maths.* 346 26; 347 16, 28  
 vertex refractionometer 111 33  
 vertical backward somersault 297 17  
 vertical deflection module 240 8  
 vertical drive head 150 38  
 vertical flick spin 288 6  
 vertical milling spindle 150 37  
 vertical piano 325 1  
 vertical/short take-off and landing aircraft 232 26-32  
 vertical speed indicator 230 14  
 vertical tangent screw 14 54  
 vesicle, germinal ~ 74 66  
 vesicle, seminal ~ 20 77  
 vessel, completed ~ 162 29, 37  
 vessel, damaged ~ 227 2; 228 10  
 vessel, funerary ~ 328 34  
 vessels, ecclesiastical ~ 332 34-54  
 vessels, liturgical ~ 332 34-54  
 vessel with spiral pattern 328 13  
 vest *Infant Care etc.* 28 23  
 vest *Underwear etc.* 32 7  
 vest *Men's Wear* 33 4, 15  
 vest *Gymn.* 296 61  
 vest *Hist. Cost.* 355 75  
 vest, envelope-neck ~ 29 7  
 vest, knitted ~ 33 53  
 vest, short-sleeved ~ 32 28  
 vest, sleeveless ~ 29 6; 32 25  
 vest, wrapover ~ 29 8  
 vest and shorts set 32 21  
 vestibule *Railw.* 207 21  
 vestibule *Hotel* 267 1-26  
 vestments 330 22; 332 4  
 vestry 331 13  
 vestry door 330 17  
 VHF and UHF tuner 240 6  
 VHF antenna 257 25  
 VHF station selector button 241 38  
 viaduct 215 59  
 vibrating beam 201 13  
 vibrating cylinder 119 89  
 vibrating head 119 89  
 vibrating poker 119 89  
 vibration, macroseismic ~ 111 38  
 vibration damper 190 26  
 vibrator 201 13  
 vicar 330 22  
 vicarage 331 20  
 vice 109 28; 134 10; 138 24; 260 47, 56  
 vice, front ~ 132 30  
 vice, parallel-jaw ~ 140 2  
 vice bar 260 48



vice handle 132 31  
 vice screw 132 32  
 Victoria regia water lily 378 17  
 video cassette 242 18  
 video cassette recorder 243 7  
 video cassette recorder system 243 5-36  
 video coding station 236 39  
 video controller 239 11  
 video control room 239 10  
 video data terminal 238 2, 11  
 video disc 243 38, 44, 58  
 video disc jacket 243 45  
 video disc player 243 37, 46  
 video head 243 26, 36  
 video head movement, direction of ~ 243 30  
 video long play video disc system 243 46-60  
 video monitor 238 2  
 video recorder, portable ~ 243 4  
 video signal 243 58  
 videotape recorder, portable ~ 243 4  
 video telephone 242 21  
 video telephone screen 242 26  
 video track 243 31  
 vielle à roue 322 25  
 Vienna sausage 96 8  
 view, front ~ 151 17  
 view, lateral ~ 27 3  
 view, side ~ 151 18  
 viewer editor 117 91  
 viewfinder, rectangular ~ 114 14  
 viewfinder, right-angle ~ 115 71  
 viewfinder, universal ~ 114 41  
 viewfinder eyepiece *Photog.* 114 2; 115 22  
 viewfinder eyepiece *Films* 313 6  
 viewfinder hood 114 23; 115 68  
 viewfinder image 115 51  
 viewing lens 114 25  
 viewing screen 117 94  
 view point 15 68  
 Viking ship 218 13-17  
 village 15 105  
 vine *Wine Grow.* 78 2-9  
 vine *Pest Contr.* 83 51  
 vinegar 98 25  
 vine layer 83 15  
 vine leaf 78 4  
 vine pests 80 20-27  
 vine root louse 83 33  
 vine shoot 78 2  
 vine stem 78 6  
 vine tendril 54 22  
 vineyard *Map* 15 65  
 vineyard *Wine Grow.* 78 1, 21  
 vineyard area 78 1-21  
 vineyard tractor 83 48  
 viticulture 78  
 viticulturist 78 13  
 viol 322 23  
 viola 323 27

viola da gamba 322 23  
 viol bow 322 24  
 violet 343 9  
 violin 323 1  
 violin, miniature ~ 322 20  
 violin body 323 3  
 violin bow 323 12  
 violin-bow fibula 328 27  
 violin bridge 323 5  
 violin clef 320 8  
 violinist 267 45  
 violin string 323 9  
 violoncello 323 16  
 violone 322 23; 323 23  
 vipers 364 40-41  
 Virgin 3 18; 4 58  
 virginal 322 45  
 Virginia creeper 51 5; 374 16  
 Virgin Mary 330 51  
 Virgo 3 18; 4 58  
 vis-à-vis 186 51  
 viscose 169 13-27, 15  
 viscose process 169 1-34  
 viscose rayon 169 1-12, 34  
 viscose rayon cake 169 18  
 viscose rayon thread 169 13-27  
 viscose spinning solution 169 10, 28-34  
 viscous drive 190 8  
 vise *see* vice  
 vision controller 239 11  
 vision control room 239 10  
 vision mixer 238 63  
 vision-mixing console 238 63  
 vision-mixing desk 238 63  
 visitor 356 6  
 visor *Forestry* 84 23  
 visor *Heraldry* 254 9  
 visor *Chivalry* 329 40  
 visual display 23 27  
 visual display unit 248 16, 44  
 viticulture 78  
 viticulturist 78 13  
 vitreous body 19 46  
 vixen 88 42  
 VLP video disc 243 51  
 V-neck 31 68  
 vocal pouch 364 25  
 vocal sac 364 25  
 Voith transmission 209 14; 212 74  
 vol-au-vent 97 18  
 volcanism 11 13-28  
 volcano, active ~ 11 15  
 volcano, composite ~ 11 15  
 volcano, extinct ~ 11 25, 28  
 volcano, subterranean ~ 11 20  
 vole and mole trap 83 37  
 volley 293 41  
 volley, forehand ~ 293 41  
 volleyball 293 56-71, 58, 59  
 voltage meter 212 17  
 voltage regulator, automatic ~ 153 31  
 voltage transformer 153 59  
 voltmeter 326 38  
 volume, respiratory ~ 26 28  
 volume control 117 85; 241 41

volume control, pupil's ~ 261 43  
 volume control, student's ~ 261 43  
 volume readout 196 5  
 volumetric flask 350 28  
 volume unit meters 241 35-36  
 volute 333 26; 334 23  
 volute cushion 334 24  
 VOR antenna 257 26  
 VOR radio direction finder 230 15  
 voter 263 22  
 voter, qualified ~ 263 24  
 votive candle 330 53  
 voussoir 336 22  
 V-seat 295 13  
 V-support 295 17  
 V-tail 229 31  
 vulcanicity 11 13-28  
 vulva 16 39  
 V-valley 13 53  
 V-way *Joiner* 132 61  
 V-way *Composing Rm.* 175 54

## W

wad, felt ~ 87 52  
 wafer *Bakery* 97 45  
 wafer *Church* 332 28  
 wafer, sacred ~ 332 48  
 waffle 97 45  
 waffle iron, electric ~ 40 34  
 waggonette 186 2  
 wagon 213 18  
 wagon, flat ~ 206 21, 24; 213 5, 11, 40  
 wagon, large-capacity ~ 213 28  
 wagon, open ~ 213 33  
 wagon, special ~ 213 33  
 Wagoner 3 27  
 wagon load 206 52  
 wagon truck 200 25  
 wagtail 360 9  
 waist *Man* 16 31  
 waist *Shoem.* 100 68  
 waist, corseted ~ 355 53  
 waistband *Ladies' Wear* 31 41  
 waistband *Men's Wear* 33 23  
 waistcoat 33 4, 15  
 waistcoat, denim ~ 31 59  
 waistcoat, embroidered ~ 355 75  
 waistcoat, knitted ~ 33 53  
 waistcoat, quilted ~ 30 16  
 waist longeron 235 9  
 waist slip 32 14; 309 85  
 waiter 267 47  
 waiter, head ~ 266 30  
 waiting room *Doc.* 22 1  
 waiting room *Station* 204 14  
 waiting room *Airport* 233 18  
 'waiting room' *Airport* 233 28  
 waitress 265 13; 266 18  
 wake 223 58  
 wake-robin 379 9  
 waldhorn 323 41  
 walk 71 2; 72 39

walk, gravel ~ 272 18  
 walkie-talkie set 270 41  
 walking stick 41 5  
 walking-stick umbrella 205 12  
 walkway *Dwellings* 37 60  
 walkway *Street Sect.* 198 9  
 walkway *Hydr. Eng.* 217 72  
 wall *Map* 15 95  
 wall *Carp.* 120 29  
 wall *Equest.* 289 8  
 wall *Ball Games* 291 44  
 wall, brick ~ 118 8; 123 29; 260 45  
 wall, concrete ~ 123 1  
 wall, framed ~ 120 48  
 wall, glass ~ 37 16  
 wall, hollow-block ~ 118 15  
 wall, inner ~ 329 19  
 wall, mirrored ~ 317 28  
 wall, outer ~ 121 32, 77; 122 37  
 wall, Rococo ~ 336 9  
 wall, rubble concrete ~ 119 7  
 wall, side ~ 42 2; 46 4; 222 37  
 wall, slatted ~ 213 29  
 wall, stone ~ 337 23  
 wall, timber ~ 119 25; 120 9  
 wall barley 61 28  
 wall bars 296 20  
 wall brush, flat ~ 129 17  
 wall calendar 22 17; 245 3; 248 42  
 wall candelabrum 330 16  
 wall chart 195 32  
 wall clock 109 32; 309 87  
 wall connection 25 23  
 wall cupboard 39 8; 46 30  
 wall desk 267 16  
 wall espalier 52 1  
 wall fountain 272 15  
 wall gecko 364 36  
 wall joist 120 39  
 wall lamp 265 9  
 wall lining, 'acoustic' ~ 310 15  
 wall map 260 44  
 wall memorial 331 14  
 wall mirror 309 3  
 wall-of-death rider 308 54  
 wall outlet 127 5  
 wall outlet, double ~ 127 6  
 wallower 91 11  
 wallpaper 128 18; 19  
 wallpaper, synthetic ~ 128 18  
 wallpaper-cutting board 128 41  
 wallpapering 128 18-53  
 wallpaper paste 128 23  
 wallpaper-stripping liquid 128 1  
 wallpaper-stripping machine 128 9  
 wall pepper 51 7  
 wall plaster 123 60  
 wall plate 120 40, 49  
 wall shelf 104 8  
 wall shelf unit 104 8  
 wall socket 39 26; 127 5  
 wall socket, double ~ 127 6  
 wall stone 331 14  
 wall string 123 45

wall stringer 123 45  
 wall switch 127 16  
 wall unit 42 1; 44 17; 46 1  
 wall ventilator 266 15  
 walnut 59 41, 43  
 walnut tree 59 37-43, 37  
 walrus 367 20  
 wane 120 89  
 waney edge 120 89  
 Wankel engine, two-rotor ~ 190 5  
 wapiti 367 2  
 ward, inner ~ 329 2  
 ward, outer ~ 329 31  
 wardrobe 43 1  
 wardrobe door 46 2  
 wardrobe trunk 267 29  
 warehouse *Station* 206 53  
 warehouse *Docks* 225 23  
 warhead 255 65  
 war horn, ivory ~ 354 39  
 warm-air brush 106 30  
 warm-air comb 105 22; 106 29  
 warm-air curtain 271 43  
 warm-air regulator 191 87  
 warm house 55 4, 32  
 warm-up regulator 190 50  
 warning cross 202 41  
 warning light 191 67, 72, 76, 80; 202 46, 50; 224 69; 230 64; 270 6  
 warning sign 280 6  
 warp *Sea Fish.* 90 12  
 warp *Weaving* 165 43; 166 39  
 warp *Knitting* 167 24  
 warp *Weaves* 171 14  
 warp *Hydr. Eng.* 217 23  
 warp, wire ~ 90 15  
 war paint 352 13  
 warp beam 165 29, 42; 166 48; 167 24  
 warp beam, sized ~ 165 56  
 warping capstan 217 22  
 warping machine 165 22  
 warping machine frame 165 27  
 warp-knitting machine 167 23  
 warp let-off motion 166 61  
 warp rib fabric 171 14  
 warp rib weave 171 13  
 warp thread 166 39; 171 1-29, 2, 17, 18  
 warp thread, lowered ~ 171 8  
 warp thread, raised ~ 171 7  
 warren 86 23  
 warship, Roman ~ 218 9-12  
 warships 258; 259  
 washbasin 24 15; 49 24; 126 27, 31; 278 6  
 washbasin, double ~ 267 32  
 washbasin pedestal 49 27  
 washboard *Floor etc. Constr.* 123 21, 63  
 washboard *Flea Market* 309 70  
 wash-bottle 349 8  
 washer *Photog.* 116 15  
 washer *Mach. Parts etc.* 143 17, 34

washer *Sawmill* 157 21  
 washer *Bicycle* 187 55  
 washer, lead ~ 122 103  
 washing 169 19; 170 48, 56  
 washing and toilet facilities 278 5-6  
 washing basin 309 65  
 washing bottle 261 32  
 washing drum 50 24  
 washing floor 92 3, 27  
 washing line 38 23; 50 33  
 washing machine 157 21  
 washing machine, automatic ~ 50 23  
 washing machines 50 23-34  
 washing set 309 64  
 washing trough 165 49  
 washing unit, compressed-air ~ 92 3  
 washing-up area 207 28  
 washing-up brush 50 51  
 wash liquor, weak ~ 172 44  
 washroom 207 15; 278 5  
 washstand *Railw.* 207 40  
 washstand *Flea Market* 309 67  
 wash tank *Photog.* 116 15  
 wash tank *Oil, Petr.* 145 30  
 washtub 309 69  
 wash water, weak ~ 172 44  
 wasp 82 35  
 wasp waist 355 53  
 waste 144 37  
 waste, medium-activity ~ 154 72  
 waste, nuclear ~ 154 57-68  
 waste, radioactive ~ 154 57-68, 77  
 waste bin 22 70; 96 46  
 waste-gas heat exchanger 155 9  
 wastepaper basket 46 25; 248 45  
 waste pipe *Bathrm. etc.* 49 45  
 waste pipe *Street Sect.* 198 26  
 waste steam exhaust 210 22  
 waste tray, mobile ~ 26 22  
 waste water discharge 156 38  
 waste water outlet 217 62  
 waste water pump *Paperm.* 172 63  
 waste water pump *Refuse Coll.* 199 20  
 watch, automatic ~ 110 32-43  
 watch, waterproof ~ 109 26; 279 16  
 watchdog 62 32; 70 25  
 watches 110  
 watchglass-fitting tool 109 11, 29  
 watchkeeper 221 126  
 watchmaker 109 1  
 watchman 329 9  
 watch strap 110 5  
 watch strap, metal ~ 109 19  
 watch-testing machine 109 24  
 watch-timing machine 109 25  
 watchtower 329 35  
 water 48 8



water, artesian ~ 12 21  
 water, baptismal ~ 332 12  
 water, entrapped ~ 13 16  
 water, raw ~ 269 4  
 water, rising ~ 12 26  
 water, running ~ 89 1  
 water, shallow ~ 224 87, 97  
 water, underlying ~ 12 32  
 water and brine separator 145 32  
 water appliances 126 12-25  
 water ballast 223 78  
 water barrel 52 4  
 water bath 132 12; 349 14  
 water bath, constant temperature ~ 23 48  
 Water Bearer 4 63  
 water bottle 290 10  
 water buffalo 367 8  
 water bug 358 4  
 water butt 52 4  
 water canister 83 57  
 water cannon 270 66; 316 18  
 Water Carrier *Astron.* 4 63  
 water carrier *Camping* 278 32  
 water channel 334 54  
 water circuit, auxiliary ~ 259 63  
 water circuit, primary ~ 259 65  
 water circuit, secondary ~ 259 63  
 water-collecting tank 92 5  
 watercolour 260 27; 338 18  
 water connection 179 5  
 water container 103 22  
 water cooler 189 35  
 water-cooling system *Moon L.* 6 26  
 water-cooling system *Iron Foundry etc.* 148 28  
 watercross 378 30  
 water croet 332 45  
 water elf 327 23  
 water extractor 281 39  
 waterfall 11 45  
 waterfall, artificial ~ 272 9  
 water feed pipe 103 21  
 waterfowl 272 51-54  
 waterfowling 86 40  
 water gauge *Map* 15 29  
 water gauge *Roof & Boilerr.* 38 63  
 water gauge *Railw.* 210 45  
 water gauge *Chem.* 349 16  
 water glass 24 13  
 water heater 145 31  
 water heater, electric ~ 126 13  
 water heater, gas ~ 126 12  
 water heater, instantaneous ~ 126 12-13  
 watering can 51 21; 55 26  
 water inlet *Fish Farm.* 89 7  
 water inlet *Plumb. etc.* 126 18  
 water inlet *Water* 269 54  
 water inlet pipe 168 11  
 water jet pipe 281 40  
 water jet pump 23 49  
 water jug 309 66  
 water jump 289 20  
 water level 13 77

water lily 51 18; 272 56  
 waterline 258 27; 285 31  
 water main 198 22  
 watermark 252 31  
 water meter 269 53  
 water-meter dial 269 58  
 watermill *Map* 15 77  
 watermill *Mills* 91 35-44  
 water molecule 242 67  
 water moth 358 12  
 water newt 364 20  
 water nixie 327 23  
 water nymph *Fabul. Creat.* 327 23  
 water nymph *Articulates* 358 3  
 water outlet *Fish Farm.* 89 8  
 water outlet *Energy Sources* 155 23  
 water outlet *Water* 269 57  
 water outlet pipe 116 17  
 water overfall 91 43  
 water ox 367 8  
 water pipe *Market Gdn.* 55 30  
 water pipe *Poultry Farm* 74 7, 26  
 water pipe *Tobacc. etc.* 107 42  
 water pipe *Power Plant* 152 7  
 water pipe *Paperm.* 172 65  
 water pipe *School* 261 4  
 water plantain 378 44  
 water plants 378 14-57  
 water polo 282 46-50  
 water polo ball 282 48  
 water preheater 152 10  
 waterproofing 123 5  
 water pump 190 61  
 waters, coastal ~ 286 10-14  
 waters, inshore ~ 286 10-14  
 water scorpion 358 4  
 water ski 280 16  
 water ski, types of ~ 286 56-62  
 water skier 286 45  
 water skiing 286 45-62  
 water slater 358 2  
 Water Snake *Astron.* 3 16  
 water snake *Fish etc.* 364 38  
 water supply 27 46; 269  
 water supply, individual ~ 269 40-52  
 water supply pipe *Brew.* 92 48  
 water supply pipe *Photog.* 116 16  
 water table 13 77; 269 1, 42, 63  
 water tank *Market Gdn.* 55 2, 29  
 water tank *Gas Weld.* 141 17  
 water tank *Refuse Coll.* 199 27  
 water tank *Railw.* 210 66  
 water tank *School* 261 33  
 water tank *Theatre* 316 51  
 water tanker 233 22  
 water tap 39 36; 49 26; 126 31  
 water temperature 280 8  
 water temperature gauge 191 38, 66  
 water tender 270 51  
 water tower *Map* 15 81

water tower *Market Gdn.* 55 2  
 water tower *Coal* 144 14  
 water tower *Water* 269 18  
 water trough 137 8  
 water tub 281 26  
 water-tube boiler 152 5  
 water vole 366 17  
 waterway engineering 217  
 water wings 281 7; 282 18  
 Watling Street thistle 61 32  
 wattle 73 24  
 wave 13 36; 287 17  
 wave, seismic ~ 11 36  
 waves, artificial ~ 281 1-9  
 wave soaring 287 16  
 wave system 287 17  
 waxing cork 301 23  
 waxing iron 301 22  
 wax scraper 301 24  
 wax separation 145 50  
 waxworks 308 68  
 waybill 206 30  
 wayside flowers 375; 376  
 WC 49 12; 207 16, 42, 72; 211 59; 231 31; 317 31  
 weaponry 255 1-98  
 weapons, heavy ~ 255 40-95  
 weapon system radar 258 35  
 weasel 367 16  
 weather 8 1-19  
 weather chart 9 1-39; 342 66  
 weather cloth 223 17  
 weathercock 331 3  
 weather map 9 1-39; 342 66  
 weather radar antenna 231 18  
 weather report 342 65  
 weather satellite 10 64  
 weather ship 9 7  
 weather station 9 7; 225 33  
 weather vane 121 26; 331 4  
 weave, plain ~ 171 1, 4, 24  
 weaver 136 5  
 weaves *Basketm.* 136 1-4  
 weaves *Weaves* 171 1-29  
 weaving 165; 166  
 weaving draft 171 29  
 weaving machine 166 1, 35  
 web *Dom. Anim.* 73 36  
 web *House Insects etc.* 81 10  
 web *Paperm.* 173 30, 45  
 web *Letterpress* 181 43, 58  
 web *Railw.* 202 3  
 web *Gymn.* 297 11  
 web *Articulates* 358 47  
 web *Birds* 359 7  
 webfoot 359 6  
 web-offset press 180 1, 18  
 wedding ceremony 332 14  
 wedding ring 36 5; 332 17  
 wedding ring box 36 6  
 wedding ring sizing machine 108 24  
 wedge 119 15; 132 19; 158 7  
 wedge, hardwood ~ 121 96  
 wedge, optical ~ 176 22  
 wedge heel 101 55  
 wedge stone 336 22  
 weed 379 8  
 weeding hoe 51 22  
 weeds 61  
 weekend house 37 84-86

weeping willow 272 63  
 weevil 80 10, 49; 82 42  
 weft feeler 166 31  
 weft feeler, electric ~ 166 14  
 weft pin 166 7  
 weft replenishment 166 5  
 weft thread 171 1-29, 3  
 weft thread, lowered ~ 171 15  
 weft thread, raised ~ 171 16  
 weft yarn 163 2  
 weigela 373 23  
 weigelia 373 23  
 weighbridge 206 41  
 weighbridge office 206 40  
 weighing apparatus 92 32; 170 29  
 weighing bottle 349 24  
 weighing bunker 225 22  
 weighing machine 206 31  
 weighing platform 22 67  
 weigh office 199 12  
 weight *Roof & Boilerr.* 38 32  
 weight *Sea Fish.* 90 10  
 weight *Clocks* 110 32  
 weight *Railw.* 202 18  
 weight *Athletics* 298 49  
 weight, iron ~ 90 21  
 weight belt 279 14  
 weighting disc 165 21  
 weightlifter 299 2  
 weightlifting 299 1-5  
 weights, lead ~ 89 88-92  
 weir *Map* 15 66  
 weir *Hydr. Eng.* 217 65-72  
 weir *Rowing* 283 60  
 weir sill 217 79  
 welder electrode arm 142 30  
 weld gauge 142 36  
 welding bench 141 13; 142 21  
 welding glove, five-fingered ~ 142 32  
 welding glove, three-fingered ~ 142 8  
 welding goggles 141 24  
 welding lead 142 19  
 welding nozzle 141 33  
 welding paste 141 18  
 welding pressure adjustment 142 31  
 welding rod 141 12  
 welding table 142 13  
 welding torch 141 11, 19, 28  
 welding transformer 125 29; 142 1, 27  
 well *Astron.* 5 24  
 well *Map* 15 100  
 well *Carp.* 120 46  
 well *Joiner* 132 35  
 well *Oil, Petr.* 145 17  
 well *Water* 269 40  
 well, artesian ~ 12 25  
 well, driven ~ 269 60  
 well, glass-roofed ~ 271 11  
 well casing 269 64  
 well head 269 65  
 wellington boot 101 14  
 wellingtonia 372 69  
 wels 364 12  
 welt, knitted ~ 29 65; 31 70  
 welt, stretch ~ 31 43  
 welt cutter 100 48

welt pincers 100 38  
 West Australian Current 14 45  
 westerlies 9 50  
 Western roll 298 16  
 west point 4 15  
 West Wind Drift 14 44  
 westwork 335 22  
 wet and dry bulb thermometer 10 52  
 wet bulb thermometer 10 35  
 wet felt, first ~ 173 17  
 wet felt, second ~ 173 18  
 wether 73 13  
 wet oil tank 145 30  
 wetsuit, neoprene ~ 279 9  
 wetting trough 165 44  
 Weymouth pine 372 30  
 Whale 3 11  
 whales 367 23-29  
 wharve 164 48  
 wheat 68 1, 23  
 wheat and rye bread 97 6, 8  
 wheat beer 93 26  
 wheat flour 97 52; 99 63  
 wheatgerm bread 97 48  
 wheatgerm oil 98 24  
 wheel *Overh. Irrign.* 67 24  
 wheel *Clocks* 110 11  
 wheel *Bicycle* 187 1  
 wheel *Aircraft* 230 24  
 wheel, back ~ 186 17  
 wheel, co-pilot's ~ 230 25  
 wheel, front ~ 186 4; 187 26-32  
 wheel, light alloy ~ 189 48  
 wheel, rear ~ 186 17  
 wheel, rubber-tyred ~ 64 32  
 wheel, ship's ~ 224 15  
 wheel, spoked ~ 289 25  
 wheel adjustment 64 58  
 wheel alignment 195 17, 21  
 wheel alignment, visual ~ 195 41  
 wheel and axle drive 212 28  
 wheel and axle set 212 3; 213 3  
 wheelarch doorway 278 39  
 wheelbarrow 56 47; 118 37; 119 42  
 wheelbarrow sprayer 83 38  
 wheel brush, wire ~ 134 24  
 wheel cover 322 27  
 wheel cylinder 192 54  
 wheel disc, plastic ~ 289 25  
 wheeler 186 47  
 wheel flange lubricator 211 52  
 wheel guard *Tram* 197 11  
 wheel guard *Music, Instr.* 322 27  
 wheelhead slide 150 3  
 wheelhorse 186 47  
 wheelhouse 223 18; 224 14-38  
 wheel lock 187 49  
 wheel mirror 195 41  
 wheel nut 187 53  
 wheel of fortune 308 45  
 wheel plough 65 1  
 wheel ratchet 110 10

wheel rim 187 28; 189 25; 191 16; 192 77  
 wheelsman 224 16  
 wheel tapper 205 39  
 wheel-tapping hammer 205 40  
 whelp 73 16  
 whetstone 66 19  
 whetting anvil 66 11  
 whetting hammer 66 9  
 whip *Bldg. Site* 118 30  
 whip *Equest.* 289 43  
 whip *Circus* 307 53  
 whip antenna 258 60  
 whip line 228 3  
 whipper-in 289 43  
 whipping unit 97 70  
 whip stall 288 5  
 whirler 179 1  
 whirligig 308 2  
 whirlpool, hot ~ 281 31, 35  
 whirlpool separator 93 2  
 whisk 39 23  
 whiskers *Hairst. etc.* 34 12  
 whiskers *Mammals* 367 21  
 whisky 42 31; 98 56  
 whisky glass 267 57  
 whistle *Kitch. Utensils* 40 11  
 whistle *Railw.* 211 9; 212 49  
 whistle *Navig.* 224 70  
 whistle lever 211 40  
 whistle valve handle 210 51  
 white *Poultry Farm* 74 62, 67  
 white *Heraldry* 254 25  
 white *Colour* 343 11  
 white bear 368 11  
 white clover 69 2  
 white light, supplementary ~ 203 15  
 white line 268 72  
 white owl 362 17  
 white daisy 376 4  
 white pelican 359 5  
 white pine 372 30  
 white poplar 371 23  
 white-tailed eagle 362 5  
 white-tailed sea eagle 362 5  
 white wagtail 360 9  
 white water lily 378 14  
 white water pump 172 63  
 white wine glass 45 82  
 whitewood 374 1  
 wholemeal bread 97 48  
 whole note 320 13  
 whole rest 320 21  
 whortleberry 377 23  
 wick 107 29  
 wickerwork 136 4, 16  
 wicket 292 70  
 wicket keeper 292 73  
 wide screen camera 310 47  
 width *Roof* 122 91, 95  
 width *Composing Rm.* 175 48  
 width adjustment 100 19  
 width scale 157 58  
 width-setting tree 100 55  
 Wiener 96 8  
 wig 105 38; 315 49  
 wig, full-bottomed ~ 34 2  
 wig, partial ~ 355 8  
 wig block 105 39



wiggler 89 72  
 wigwam 352 7  
 wild animal cage 307 49  
 wild animal tamer 307 52  
 wild arum 379 9  
 wild barley 61 28  
 wild boar 86 32; 88 51  
 wild briar 373 26  
 wild camomile 380 1  
 wild cherry 59 5  
 wild chicory 376 25  
 wild endive 376 25  
 wildfowling 86 40  
 wild morning glory 61 26  
 wild mustard 61 18  
 wild oat 61 29  
 wild orchid 376 28  
 wild pear tree 58 31  
 wild radish 61 21  
 wild sow 86 32; 88 51  
 wild strawberry 58 16  
 wild-water racing kayak 283 69  
 willow rod 136 15  
 willow stake 136 14  
 Wilson chamber 2 24  
 Wilson cloud chamber 2 24  
 winch 270 56  
 winched launch 287 5  
 winch house 226 54  
 wind arrow 9 9  
 wind avalanche 304 1  
 wind box 147 69  
 windbreak 354 35  
 wind chest 326 12; 12-14  
 wind chest box 326 12  
 wind cone 287 11  
 wind cripple 13 43  
 wind direction 9 9-19; 285 6  
 wind-direction indicator 10 31  
 wind directions 285 1-13  
 wind-direction shaft 9 9  
 wind-direction symbols 9 9-19  
 windflower 375 5; 377 1  
 wind gauge 10 28  
 wind generator 55 34; 155 42  
 winding, low-voltage ~ 153 16  
 winding, primary ~ 153 15  
 winding, secondary ~ 153 16  
 winding crown 110 42  
 winding engine house 144 2  
 winding gear 217 74  
 winding handle 117 50  
 winding inset 144 26  
 wind knob 110 23  
 windlass 223 49; 258 6  
 windmill *Map* 15 31  
 windmill *Mills* 91 1-34  
 windmill *Fair* 308 15  
 windmill, Dutch ~ 91 29  
 windmill, German ~ 91 31  
 windmill arm 91 1  
 windmill cap, rotating ~ 91 30  
 windmill sail 91 1  
 windmill vane 91 1  
 window 2 16; 6 40; 25 8; 28 36, 49; 75 31; 77 50; 186 10; 268 14; 284 38

window, circular ~ 335 12  
 window, double casement ~ 37 22  
 window, heated ~ 191 80  
 window, lead glass ~ 154 75  
 window, rear ~ 191 32, 80  
 window, side ~ 231 29  
 window, single casement ~ 37 23  
 window, sliding ~ 207 7  
 window, transparent ~ 278 41; 284 3  
 window box 268 15  
 window breast 37 24  
 window decoration 260 68; 268 12  
 window display 98 1; 268 11  
 window frame 133 44  
 window glass 124 5  
 window head 37 25; 118 9; 120 57  
 window jamb 120 51  
 window ladder 296 21  
 window ledge 118 12; 120 33  
 window lintel 120 57  
 window opening 120 30  
 window painting 260 26  
 window shutter 37 30  
 window sill 37 24; 118 12; 120 33  
 window vent 55 10  
 windpipe 17 50; 20 4  
 wind power plant 155 42  
 wind pump 15 73; 55 34  
 windrow 63 36  
 wind screen 5 15  
 windscreen, panoramic ~ 191 21  
 windscreen wiper 191 41; 197 32  
 wind shaft 91 5  
 windshield 5 31  
 windshield, panoramic ~ 191 21  
 windshield wiper 191 41  
 wind sock 287 11  
 wind speed 9 10  
 wind-speed barb 9 10  
 wind-speed feather 9 10  
 wind-speed indicator 10 29  
 wind-speed meter 10 29  
 windsurfer 284 1  
 windsurfing 284 1-9  
 wind systems 9 46-52  
 wind trunk 326 11  
 wind vane 10 32; 55 36; 331 4  
 wind wheel 55 35  
 wine 99 76; 266 43  
 wine, bottled ~ 98 60-64  
 wine, red ~ 98 64  
 wine, sparkling ~ 98 63  
 wine, white ~ 98 60  
 wine bar 266 30-44  
 wine bottle 79 14  
 wine carafe 266 32  
 wine cask 79 2  
 wine cellar 79 1-22  
 wine cooler 266 42  
 wine cruet 332 46  
 wineglass 44 9; 45 12, 82, 83; 79 19; 266 33; 317 7

wine grower 78 13  
 wine growing 78  
 wine in bottles 98 60-64  
 wine jug 79 15  
 wine list 266 31  
 wine press, horizontal ~ 79 21  
 wine restaurant 266 30-44  
 wine tasting 79 16  
 wine vat 79 3  
 wine vault 79 1-22  
 wine waiter 266 30  
 wing *House Insects etc.* 81 8  
 wing *Game* 88 76, 79  
 wing *Sea Fish* 90 16  
 wing *Aircraft* 230 43  
 wing *Airsports* 288 27  
 wing *Fabul. Creat.* 327 15, 28, 51, 60  
 wing *Decid. Trees* 371 57  
 wing *Conifers* 372 9  
 wing, bat's ~ 327 4  
 wing, central ~ 229 8  
 wing, cranked ~ 229 14  
 wing, elliptical ~ 229 15  
 wing, front ~ 191 3  
 wing, hind ~ 358 33  
 wing, lower ~ 229 9  
 wing, membranous ~ 82 11  
 wing, middle ~ 229 8  
 wing, multispar ~ 287 29  
 wing, ogival ~ 229 22  
 wing, rectangular ~ 229 16  
 wing, rotary ~ 232 12  
 wing, swept-back ~ 229 20, 21  
 wing, tapered ~ 229 17  
 wing, upper ~ 229 7  
 wing case 82 10  
 wing configurations 229 1-14  
 Winged Horse 3 10  
 winger 291 16  
 wing mirror, left-hand ~ 191 40  
 wing mirror, right-hand ~ 191 56  
 wing nut 143 42; 187 39  
 wing of bridge 223 16  
 wing rail 202 25  
 wings 307 12  
 wing shapes 229 15-22  
 wing span 229 2  
 wing suspension, inner ~ 257 34  
 wing suspension, outer ~ 257 35  
 wing tally 74 55  
 wing tank 256 4  
 wing tank, integral ~ 257 29  
 wing tip 287 42  
 wing-tip tank 231 9; 256 30  
 wing wall *Rivers* 216 35  
 wing wall *Hydr. Eng.* 217 80  
 winker 71 26  
 winner 299 39  
 winner's price 289 39  
 winners' table 289 38  
 winning peg 292 77  
 winnowing 64 15  
 winter boot 101 1  
 winter coat 30 61  
 winter dike 216 32  
 winter dress 30 12

winter green 57 34  
 winter moth 80 16  
 winter slacks 30 19  
 winter sports 301; 302; 303  
 winter wear 30  
 wiper *Post* 237 44  
 wiper *Graphic Art* 340 13  
 wiper/washer switch and horn 191 60  
 wire *Papern.* 173 14  
 wire *Fencing* 294 31  
 wire, gold ~ 108 3  
 wire, iron ~ 143 12  
 wire, overhead ~ 194 43  
 wire, silver ~ 108 3  
 wire and sheet roller 108 1  
 wireless mast 15 33  
 wireman 127 1  
 wire side 173 34  
 wire spool, spring-loaded ~ 294 29  
 wire stripper and cutter 134 15  
 wire strippers 127 64  
 wireworm 80 38  
 witch 306 6  
 witchgrass 61 30  
 withers *Dog* 70 11  
 withers *Horse* 72 17  
 witloof 376 25  
 witness 332 23  
 wobbler, double-jointed ~ 89 70  
 wobbler, round ~ 89 71  
 wobbler, single-jointed ~ 89 69  
 wolf 367 13  
 wolfsbane 379 1  
 womb 20 79  
 wood *Forestry* 84 1-34  
 wood *School* 260 82  
 wood *Ball Games* 293 91  
 wood *Sculpt. Studio* 339 27  
 wood, coniferous ~ 15 1  
 wood, deciduous ~ 15 4  
 wood, mixed ~ 15 14  
 wood, open ~ 326 31-33  
 wood, rough ~ 135 21  
 wood anemone 377 1  
 woodbind 374 13  
 woodbine 51 5; 374 13, 16  
 wood carver 339 28  
 wood carving 260 77  
 wood chip paper 128 18  
 wood chisel 339 19  
 wood cut 260 83  
 wood cutting *Forestry* 84 15-37  
 woodcutting *Graphic Art* 340 2  
 wood engraving 340 1, 1-13  
 wood file 132 2  
 wood grouse 88 72  
 wood haulage way 84 3  
 woodland strawberry 58 16  
 woodlark 361 18  
 wood louse 81 6  
 woodpecker 359 27  
 wood pulp, chemical ~ 172 77, 78  
 wood pulp paper 128 18

wood rasp 132 1; 134 8; 260 55  
 wood screw 122 101; 132 41; 143 45  
 wood screw thread 143 47  
 wood sculptor 339 28  
 woodsman 84 18  
 wood tick 358 44  
 wood-turning lathe 134 51; 135 1  
 woodwind instruments 323 28-38  
 woodwinds 323 28-38  
 woodworking adhesive 134 36  
 woofer 241 17  
 woolly apple aphid 80 32, 33  
 woolly apple aphid colony 80 34  
 woolly milk cap 379 13  
 woolpack cloud 8 1; 287 22  
 work 118 17  
 workbench 97 60, 62; 100 33; 104 7; 108 20; 109 2; 111 20; 124 15; 125 10; 137 21; 140 7; 260 46  
 workbench, collapsible ~ 134 41  
 workbench lamp 109 12  
 workboard 136 7  
 work clamp *Joiner* 132 51  
 work clamp *Arc Weld.* 142 35  
 worker *Bees* 77 1, 6-9, 10-19  
 worker *Articulates* 358 22  
 worker bee 77 1  
 worker cell 77 34  
 work folder 261 27  
 working, open-cast ~ 158 1  
 working area 162 5  
 working bath 162 5  
 working deck 221 19, 34  
 working face 158 3  
 working passage 75 24  
 working platform 118 17; 145 5; 211 42; 234 28, 46  
 workings, underground ~ 144 21-51  
 working surface, tiled ~ 261 5  
 working top 39 11  
 workpiece 104 25; 133 44; 139 46; 140 6; 141 20; 142 28; 148 51; 150 20  
 workpiece, blocked ~ 139 28  
 workpiece, preshaped ~ 139 28  
 work platform 118 17; 211 42; 234 28, 46  
 workroom, dressmaker's ~ 103 1-27  
 workroom, furrier's ~ 131 1-25  
 workroom, tailor's ~ 104 1-32; 268 17  
 works 15 37  
 workshop 62 17; 146 30; 310 6; 315 28-42  
 workshop, bootmaker's ~ 100 1-68  
 workshop, carpenter's ~ 120 4  
 workshop, cooper's ~ 130 1-33

workshop, fitter's ~ 140 1-22  
 workshop, glazier's ~ 124 1  
 workshop, joiner's ~ 132 1-73  
 workshop, locksmith's ~ 140 1-22  
 workshop, mechanic's ~ 140 1-22  
 workshop, optician's ~ 111 20-47  
 workshop, orbital ~ 235 66  
 workshop, shoemaker's ~ 100 1-68  
 workshop, tank construction engineer's ~ 130 1-33  
 workshop, turner's ~ 135 1-26  
 workshop area 5 17  
 workshop door 120 5  
 workshop trolley 109 22  
 work top 50 31  
 worm 192 59  
 worm-and-nut steering gear 192 56-59  
 worm gear sector 192 57  
 wormhole 58 65  
 worms 357 20-26  
 wormwood 380 4  
 worshipper 330 29  
 wort 92 50, 51, 52  
 wort boiler 92 52  
 wort cooler 93 5  
 wort cooling 93 1-5  
 wound 21 8  
 wrap, coloured ~ 355 10  
 wrapper *Tobacc. etc.* 107 5  
 wrapper *Bookbind.* 185 37  
 wrapping, jute ~ 163 4  
 wrapping counter 271 14  
 wrapping material 98 46-49  
 wrapping paper 98 46  
 wreath 123 52  
 wreath, bridal ~ 332 19  
 wreath of the colours 254 2  
 wreath piece 123 49  
 wreck 224 84  
 wrecking crane 270 47  
 wreck to port 224 86  
 wreck to starboard 224 85  
 wren 361 12  
 wrench 134 14  
 wrench, open-end ~ 134 2  
 wrest 325 20  
 wrestler 299 7  
 wrestling 299 6-12  
 wrestling, Greco-Roman ~ 299 6-9  
 wrestling mat 299 12  
 wrest pin 324 23; 325 17  
 wrest pin block 324 22; 325 18  
 wrest plank 324 22; 325 18  
 wrist *Man* 19 76  
 wrist *Horse* 72 22  
 wristband 296 64  
 wrist joint 2 41  
 wrist sling 300 32  
 wristwatch, automatic ~ 110 32-43  
 wristwatch, electronic ~ 110 1  
 writing, English ~ 342 10  
 writing, German ~ 342 11  
 writing cane 341 23  
 writing surface 47 23; 246 3



## writing system, pictorial

writing system, pictorial ~  
341 1  
writing unit 46 21  
wrought-iron craftsman 140  
1  
wryneck 359 27

## X

xanthate 169 10  
X-contact 115 14  
xenon lamp 177 17  
xenon lamp housing 177 42  
X-radiation 1 33, 56  
X-ray 25 39  
X-ray apparatus 24 21; 27 6  
X-ray cassette 27 2  
X-ray control unit, central ~  
27 9  
X-ray examination table 27 1  
X-ray generator 24 22  
X-ray head 27 18  
X-ray image intensifier 27 16  
X-ray support, telescopic ~ 27  
8  
X-ray technician 27 11  
X-ray tube 27 17, 18  
X-ray unit 27 1-35  
xylography 340 1-13  
xylophone 324 61

## Y

yacht 273 29; 278 12; 284  
10-48  
yacht classes 284 49-65  
yacht hull, types of ~ 285  
29-41  
yachting 284; 285  
yachting cap 35 29  
yacht stern 285 42  
yacht stern, types of ~ 285  
42-49  
yacht tacking 285 7  
yankee corn 68 31  
yard 276 27  
yardmaster 206 45  
yard radio 212 50; 213 4  
yarn 164 53, 56; 167 17, 36;  
169 17, 25  
yarn, doubled ~ 164 60  
yarn, glass ~ 162 56, 57  
yarn, inlaid ~ 171 43  
yarn, sleeved ~ 162 57

yarn, viscose rayon ~ 169  
1-34, 27  
yarn count 164 40  
yarn-distributing beam 167  
25  
yarn-dividing beam 167 25  
yarn feeder 167 6  
yarn-forming frame,  
intermediate ~ 164 27  
yarn guide *Shoem.* 100 30  
yarn guide *Knitting* 167 3, 54,  
64  
yarn guide support post 167 2  
yarn length recorder 165 28  
yarn package 165 15; 170 48  
yarn package container 165  
16  
yarn-tensioning device 167 5  
yarrow 376 15  
yawing 230 69  
yaw 220 10  
y-axis 347 3  
Y-connection 153 20  
Y-cross 332 61  
yeast 93 6  
yeast, baker's ~ 97 53  
yeast bread 97 11  
yeast propagation 93 6  
yellow *Heraldry* 254 24  
yellow *Colour* 343 2  
yellow bunting 361 6  
yellow card 291 63  
yellow coral fungus 381 32  
yellow filter adjustment 116  
44  
yellow flag 60 8  
yellow-flowered jasmine 373  
4  
yellowhammer 361 6  
yellow iris 60 8  
yellow light 203 16  
yellow lupin 69 17  
yellow meal beetle 81 23  
yellow owl 362 17  
yellow prickle fungus 381 31  
yellow water flag 60 8  
yerba maté 382 11  
yew tree 372 61  
yoghurt maker 40 44  
yoke *Bldg. Site* 119 64  
yoke *Power Plant* 153 14  
yoke *Rowing* 283 51  
yoke, adjustable ~ 65 14  
yoke, bolted ~ 119 74  
yoke, front ~ 33 19  
yoke, kimono ~ 31 18

yoke elm 371 63  
yoke mount, English-type ~  
113 23  
yoke mounting, English-type  
~ 113 23  
yolk 74 68  
yolk sac 74 64  
Y-tube 350 56  
yucca 373 24  
yurt 353 19  
yurta 353 19

## Z

zap flap 229 50  
Z-drive motorboat 286 2  
zebra 366 27  
zebra crossing 198 11; 268 24  
Zechstein, leached ~ 154 62  
Zechstein, lixiviated ~ 154 62  
Zechstein shale 154 68  
zenith *Astron.* 4 11  
zenith *Hunt.* 87 77  
zero 275 18  
zero adjustment 2 7  
zero isotherm 9 41  
zero level 7 6, 20  
ziggurat 333 32  
zimmerstutzen 305 35  
zinc plate 179 9; 180 53; 340  
52  
zinc plate, etched ~ 178 40  
zinc plate, photoprinted ~ 178  
32  
zink 322 12  
zinnia 60 22  
zip 31 55; 33 28; 260 13  
zip, front ~ 29 18  
zip, inside ~ 101 6  
zip code 236 43  
zircon 351 19  
zither 324 21  
zone, arid ~ 9 54  
zone, paved ~ 268 58  
zone, tropical ~ 9 53  
zoo 356  
zoological gardens 356  
zooming lever 117 54; 313 22,  
36  
zoom lens 112 41; 240 34; 313  
23  
zoom lens, interchangeable ~  
117 2  
zoom stereomicroscope 112 40  
Zulu 354 36



OXFORD

## MORE OXFORD PAPERBACKS

Details of a selection of other Oxford Paperbacks follow. A complete list of Oxford Paperbacks, including The World's Classics, Twentieth-Century Classics, OPUS, Past Masters, Oxford Authors, Oxford Shakespeare, and Oxford Paperback Reference, is available in the UK from the General Publicity Department, Oxford University Press (RS), Walton Street, Oxford, OX2 6DP.

In the USA, complete lists are available from the Paperbacks Marketing Manager, Oxford University Press, 200 Madison Avenue, New York, NY 10016.

Oxford Paperbacks are available from all good bookshops. In case of difficulty, customers in the UK can order direct from Oxford University Press Bookshop, 116 High Street, Oxford, Freepost, OX1 4BR, enclosing full payment. Please add 10 per cent of the published price for postage and packing.



## A SPLENDID QUARTET OF SHORT STORIES

### CLASSIC IRISH SHORT STORIES

*Selected and Introduced by Frank O'Connor*

The Irish short story, Frank O'Connor believes, is 'a distinct art form' and the stories he has chosen for this collection show how the form has remained peculiarly itself while being developed in various ways in response to changing social and political conditions. Authors include James Joyce, Liam O'Flaherty, Seán O'Faoláin, George Moore, and Elizabeth Bowen.

### CLASSIC ENGLISH SHORT STORIES

*Selected and Introduced by Derek Hudson*

The years 1930 to 1955 marked a high point in the fortunes of the English short story. Inevitably the Second World War left its mark on many of the tales Derek Hudson has collected here, but, he argues, the dominating impression is that very English characteristic, humour. The authors include Somerset Maugham, Virginia Woolf, Evelyn Waugh, Graham Greene, H. E. Bates, and Rosamond Lehmann.

### CLASSIC SCOTTISH SHORT STORIES

*Selected and Introduced by J. M. Reid*

### CLASSIC AMERICAN SHORT STORIES

*Selected and Introduced by Douglas Grant*

Also in Oxford Paperbacks:

#### CLASSIC ENGLISH SHORT STORIES

The Dragon's Head  
The Killing Bottle  
Charmed Lives  
The Green Man Revisited

## THE WORLD'S CLASSICS

The World's Classics Series makes available the greatest works of world literature at reasonable prices.

'An addition to the library of anyone setting out either to study or begin to read English literature.' *Times Educational Supplement*

### COLONEL JACK

*Daniel Defoe*

*Edited by Samuel Holt Monk*

*With a new Introduction by David Roberts*

'Born a gentleman, put 'Prentice to a Pick-Pocket, was Six and Twenty Years a Thief, and then Kidnapp'd to Virginia. Came back a Merchant, married four Wives, and five of them prov'd Whores . . .'

*Colonel Jack* begins among the alleyways of London and ends in crime, marital disaster, political adventurism, and penitent prosperity. Its elusive hero has been compared to *Oliver Twist*, *Lucky Jim*, and to modern criminals who have made their fortune and escaped the law. Jack the occasional Jacobite succeeds almost in spite of himself in making his world conform to his highly individual ends. The result is a novel which subjects a vast range of eighteenth-century life to the scrutiny of an intriguingly unreliable narrator.

Samuel Holt Monk's Oxford English Novels text, the first to use the rare first edition of 1722, is here re-issued with a new introduction by David Roberts which shows why *Colonel Jack* increasingly commands the attention of modern readers.

Also available in the World's Classics:

*Peregrine Pickle* Tobias Smollett  
*Castle Rackrent* Maria Edgeworth  
*Joseph Andrews and Shamela* Henry Fielding  
*Camilla* Fanny Burney



## OXFORD REFERENCE

Oxford is famous for its superb range of dictionaries and reference books. The Oxford Reference series offers the most up-to-date and comprehensive paperbacks at the most competitive prices, across a broad spectrum of subjects.

### THE CONCISE OXFORD COMPANION TO ENGLISH LITERATURE

*Edited by Margaret Drabble and Jenny Stringer*

Based on the immensely popular fifth edition of the *Oxford Companion to English Literature* this is an indispensable, compact guide to the central matter of English literature.

There are more than 5,000 entries on the lives and works of authors, poets, playwrights, essayists, philosophers, and historians; plot summaries of novels and plays; literary movements; fictional characters; legends; theatres; periodicals; and much more.

The book's sharpened focus on the English literature of the British Isles makes it especially convenient to use, but there is still generous coverage of the literature of other countries and of other disciplines which have influenced or been influenced by English literature.

From reviews of *The Oxford Companion to English Literature Fifth Edition*:

'a book which one turns to with constant pleasure . . . a book with much style and little prejudice' Iain Gilchrist, *TLS*

'it is quite difficult to imagine, in this genre, a more useful publication' Frank Kermode, *London Review of Books*

'incarnates a living sense of tradition . . . sensitive not to fashion merely but to the spirit of the age' Christopher Ricks, *Sunday Times*

Also available in Oxford Reference:

*The Concise Oxford Dictionary of Art and Artists*  
edited by Ian Chilvers

*A Concise Oxford Dictionary of Mathematics*  
Christopher Clapham

*The Oxford Spelling Dictionary* compiled by R. E. Allen  
*A Concise Dictionary of Law* edited by Elizabeth A. Martin



## THE OXFORD-DUDEN PICTORIAL ENGLISH DICTIONARY

**Fully illustrated**

**Over 28,000 objects in science and medicine, the arts  
and leisure activities, industry, and new technology**

Certain kinds of information are conveyed better visually than by written definitions. It is, for instance, easier and clearer to describe the features of a range of fold mountains, a Corinthian column, or the workings of an internal combustion engine with a picture than with a verbal description.

Each double page of this dictionary explains the vocabulary of a particular subject by means of a picture illustrating it. The illustrations are clearly drawn and finely detailed, and an alphabetical index is also provided for quick and easy reference.

**An essential complement to any dictionary of English**

Cover illustration by Mark Burton

**Oxford Paperbacks**  
Oxford University Press

