

Topics in
English
Linguistics

TIEL 60-1

Renaat Declerck

In cooperation with Susan Reed
and Bert Cappelle

The Grammar of the English Verb Phrase

Volume 1: The Grammar
of the English Tense System
A Comprehensive Analysis

Mouton de Gruyter

The Grammar of the English Verb Phrase
Volume 1: The Grammar of the English Tense System

DEMO



Topics in English Linguistics 60-1

Editors

Bernd Kortmann

Elizabeth Closs Traugott

DEMO

Mouton de Gruyter
Berlin · New York

The Grammar of the English Verb Phrase

Volume 1:

The Grammar of the English Tense System

A Comprehensive Analysis

by

Renaat Declerck

in collaboration with Susan Reed and Bert Cappelle

DEMO

Mouton de Gruyter
Berlin · New York

Mouton de Gruyter (formerly Mouton, The Hague)
is a Division of Walter de Gruyter GmbH & Co. KG, Berlin.

© Printed on acid-free paper which falls within the guidelines
of the ANSI to ensure permanence and durability.

Library of Congress Cataloging-in-Publication Data

Declerck, Renaat.
The grammar of the English tense system : a comprehensive
analysis / by Renaat Declerck in cooperation with Susan Reed
and Bert Cappelle.
p. cm. – (The grammar of the English verb phrase ; v. 1)
(Topics in English linguistics ; 60.1)
Includes bibliographical references and index.
ISBN-13: 978-3-11-018589-8 (hardcover : acid-free paper)
ISBN-10: 3-11-018589-X (hardcover : acid-free paper)
1. English language – Tense. 2. English language – Grammar.
I. Reed, Susan, 1959– II. Cappelle, Bert, 1975– III. Title.
PE1301.D36 2006
425'.62–dc22
2006020424

ISBN-13: 978-3-11-018589-8
ISBN-10: 3-11-018589-X
ISSN 1434-3452

Bibliographic information published by Die Deutsche Bibliothek

Die Deutsche Bibliothek lists this publication in the Deutsche Nationalbibliografie;
detailed bibliographic data is available in the Internet at <<http://dnb.ddb.de>>.

© Copyright 2006 by Walter de Gruyter GmbH & Co. KG, 10785 Berlin
All rights reserved, including those of translation into foreign languages. No part of this
book may be reproduced or transmitted in any form or by any means, electronic or
mechanical, including photocopy, recording, or any information storage and retrieval
system, without permission in writing from the publisher.
Cover design: Martin Zech, Bremen.
Typesetting: META Systems GmbH, Wustermark.
Printed in Germany.

Acknowledgements

Susan Reed and Bert Cappelle have offered me substantial assistance in writing this book. I want to thank them specially. I also wish to thank the various people who have contributed to the writing of the book by commenting on an earlier draft of one or more chapters. In alphabetical order they are: Griet Beheydt, Ilse Depraetere, Raphael Salkie, Elizabeth Traugott, Naoaki Wada, and Christopher Williams.

DEMO

DEMO

Table of contents

Acknowledgements	V
Table of contents	VII
Chapter 1. Introduction	1
Chapter 2. Towards a theory of tense and time	91
Chapter 3. The absolute use of the present tense	171
Chapter 4. The absolute past tense	193
Chapter 5. The absolute use of the present perfect	209
Chapter 6. The present perfect <i>vs</i> the preterite in clauses without temporal adverbials	315
Chapter 7. Absolute tense forms referring to the post-present	335
Chapter 8. Temporal domains and relative tenses: theoretical foundations	361
Chapter 9. Temporal subordination in the various time-zones	441
Chapter 10. Two tense systems with post-present reference	529
Chapter 11. Tense choice determined by temporal focus	571
Chapter 12. Preterite <i>vs</i> present perfect in clauses with temporal adverbials	589
Chapter 13. Adverbial <i>when</i> -clauses and the use of tenses	635
Chapter 14. Adverbial <i>before</i> -clauses and <i>after</i> -clauses	685
Glossary	759
References	831
Index	833

DEMO

1. Introduction

I.	General introductory remarks	4
1.1	Aims and scope of the work	4
1.2	Symbols and conventions	5
1.3	The illustrative material	6
1.4	The structure of the book	8
II.	General linguistic terminology	12
1.5	'Situation', 'actualization', 'actualize'	12
1.6	Phrases	12
1.7	Clause, predicate	13
1.8	Sentences	13
1.9	Alternative definitions of 'verb phrase'	15
1.10	Tensed <i>vs</i> nontensed verb forms	15
1.11	'Present' and 'perfect' nonfinite forms	17
1.12	Lexical verbs <i>vs</i> auxiliaries	18
1.13	Transitive <i>vs</i> intransitive lexical verbs	20
III.	Meaning categories expressed by verb forms	22
A.	Tense	22
1.14	Introduction	22
1.15	The formation of the present tense	23
1.16	The formation of the past tense	23
1.17	The formation of the other tenses	24
1.18	The meanings of tenses: expressing temporal relations	25
1.19	Special uses of tenses	27
B.	Aspect	28
1.20	Introduction	28
1.21	Perfective aspect	30
1.22	Imperfective aspect	31
1.23	Habitual aspect	33
1.24	Repetitive <i>vs</i> semelfactive aspect	35
1.25	Aspectual form <i>vs</i> aspectual meaning	37
1.26	Perfect aspect?	37
C.	Mood and modality	38
1.27	Definition of mood and modality	38
IV.	The precise meanings and uses of 'situation' and 'actualization'	40
1.28	Definition of 'situation', 'actualize' and 'actualization'	40
1.29	Situation: meaning (denotation) versus reference	40
1.30	Terminological conventions for speaking about situations	42
1.31	Terminology used to refer to situation types and verb classes	45
1.32	Situation types	47

V.	Abstract situation types: ontological aspect	49
1.33	Introduction	49
1.34	Ontological feature 1: ‘static’ versus ‘dynamic’	51
1.35	Ontological feature 2: ‘agentive’ versus ‘nonagentive’	53
1.36	Ontological feature 3: ‘homogeneous’ versus ‘heterogeneous’	55
1.37	Ontological feature 4: ‘durative’ <i>vs</i> ‘punctual’	57
1.38	Ontological feature 5: [\pm transitional]	59
1.39	Ontological feature 6: ‘telic’ <i>vs</i> ‘atelic’	60
1.40	Ontological feature 7: [\pm evolving]	65
VI.	Classifications of situation types	66
1.41	Introduction	66
1.42	Classification 1: states, actions, events and processes	66
1.43	Classification 2: Vendler’s taxonomy	70
VII.	Actualization aspect: ‘bounded’ <i>vs</i> ‘nonbounded’	72
1.44	Definition of (non)bounded situations/clauses	72
1.45	‘Nonbounded actualization’ = ‘homogeneous actualization’	74
1.46	(Non)boundedness and duration adverbials	75
1.47	(Non)boundedness <i>vs</i> (a)telicity	77
1.48	(Un)bounding clause constituents	79
VIII.	The aspectual interpretation of a clause	81
1.49	Aspectual interpretation	81
IX.	Summary of chapter 1	83
1.50	Parts I and II	83
1.51	Part III	83
1.52	Part IV	84
1.53	Part V	85
1.54	Part VI	87
1.55	Part VII	88
1.56	Part VIII	88

D E M O

Abstract

The aim of this book is to describe the workings of the system of special verb forms used in English to locate situations in time. In this introductory chapter we lay the terminological and conceptual groundwork which is necessary before we embark on our grammatical description of the English tense system. Our concern is to provide precise definitions of the basic linguistic terms that will be used and to explain the conceptual apparatus that will be adopted both in this volume and in subsequent volumes dealing with the English verb phrase. (The definitions of the terms and concepts used in the book are brought together in an extensive glossary at the end of the book.)

Part I (= sections 1.1–1.4) first gives some preliminary notes on this work's aims, contents, notational conventions, and the like.

In part II (= sections 1.5–1.13) we briefly define our basic linguistic terms, such as 'situation', 'verb phrase', 'verb form', etc. Since this study is intended as the first part of a multi-volume grammar, it seems necessary to us to make explicit the way in which we use such terms, despite the fact that readers will already be familiar with most of them, in order to avoid possible misunderstandings.

Part III (= sections 1.14–1.27) is a brief overview of tense and two other areas of meaning that can be expressed by the use of verb forms in English and that interact with tense: the system of grammatical aspect and the system of mood and modality.

In part IV (= sections 1.28–1.32) we take a closer look at the term 'situation'. By this term we mean whatever can be expressed by a sentence (more accurately, by a 'clause'), and for

which the utterer has in mind a particular 'actualization' in the extralinguistic world. If situations are the semantic category expressed by clauses, it is necessary to examine what semantic categories are expressed by smaller linguistic units, like verbs and verb phrases, which are often also said to refer to 'situations' in the linguistic literature.

Part V (= sections 1.33–1.40) addresses the properties by which these latter semantic categories (which we call 'situation-templates') can be classified into different types. This section is concerned with 'ontological aspect' (perhaps better known as 'lexical aspect'), which involves such oppositions as 'static' versus 'dynamic', 'agentive' versus 'nonagentive', 'telic' versus 'atelic', 'homogeneous' versus 'heterogeneous', etc.

In part VI (= sections 1.41–1.43), some of these oppositions are used to distinguish four different types of situation proper: states, actions, events and processes.

Part VII (= sections 1.44–1.48) introduces the notion 'actualization aspect'. This third kind of aspect, apart from grammatical aspect and ontological aspect, pivots on the distinction between 'boundedness' and 'nonboundedness', having to do with whether or not a (telic or atelic) situation is represented or interpreted as reaching a terminal point.

In part VIII (= section 1.49) we describe how the aspectual interpretation of a clause may arise through an interaction of the three different kinds of aspect.

Part IX (= sections 1.50–1.56) gives a summary of this first chapter.

I. General introductory remarks

1.1 Aims and scope of the work

1.1.1 The goal we had in mind when embarking on this work was to write a Grammar of the English tense system which was at the same time a scientific study and a work which could be used as a reference grammar by linguists and students of English with a basic knowledge of descriptive linguistics and a fairly advanced proficiency in English. Difficult as it is to reconcile these two purposes with each other, we have attempted to write a grammar that comes up to this double expectation.

The scientific nature of this work means that this is not just another grammar of English meant to be used as a handbook and basically restricting itself to bringing together a number of relevant data which have been revealed and studied in the linguistic literature on the English tense system. It is meant to be a thorough study of that tense system, based on a wealth of old and new observations, and offering a coherent framework revealing the relations between the observations, accounting for them, and ultimately predicting most of them. The framework is a revised version of the 'descriptive theory' presented in Declerck (1991). Although it is presented without unnecessary formalization, it is a rigid framework which could easily be formalized and used in formal approaches like formal semantics or computational linguistics.

In order to render the work, which deals with a complex subject matter, as accessible as possible, we have made great efforts to set out the principles in a very precise and detailed way. The work abounds in cross-references to other sections and contains an extensive index which should enable the readers who wish to look something up (for example, a term, definition, rule or principle) to find quickly what they are looking for. Needless to say, the cross-references and the index, as well as the extensive glossary, are also meant to realize our second goal, viz. to provide a grammar that can be used as a reference work by scholars and by students with some knowledge of descriptive linguistics and of English grammar.

1.1.2 The kind of English treated is Standard British English (including both written and spoken registers). However, there is a link to American English on the (rare) occasions when the two languages make different choices in connection with a particular principle of the English tense system.

1.1.3 Grammars are typically written without systematic references to the linguistic literature (unless they are added to a quotation or are really unavoidable), and without discussion of conflicting analyses. This also applies to this grammar, even though it aims to be a linguistic study as well as a grammar. As a linguistic study, the book is an exploration of how one framework can

account for tense in English, rather than a comparative study of other analyses or a comparison of our analysis with the analyses of other authors. Because of this, unless a particular analysis or argument is specifically attributable to one author, there are few references to competing analyses, or to the huge number of books and articles dealing with tense in English. However, a selective bibliography listing some of the literature that we consider basic to the study of tense can be found at the end of the book.

1.2 Symbols and conventions

The following symbols will be used in the following ways:

- (a) Braces (= {...}) will be used to indicate alternative possibilities, separated from each other by a slash. (e.g. *If I {was / were} your father, I would be proud of you.*)
- (b) Square brackets will be used to separate the relevant clause in an example from its context, as in the following example:

[Michael thought things over.] Rose had helped him after he {had left / left} his wife. [Perhaps she would help him again now.]

In a case like this we are only interested in the sentence that is not within square brackets. The bracketed sentences are just added to provide the context that is necessary for a correct interpretation of the sentence under discussion.

- (c) An asterisk before a sentence or constituent can indicate not only syntactic ungrammaticality but also semantic-pragmatic unacceptability:

*The man died for the next two hours.

- (d) A superscript question mark will be used similarly to indicate that a sentence or constituent is questionable for a grammatical or semantic-pragmatic reason. A double superscript question mark indicates an even higher degree of questionability.

I have never {worked / [?]been working} on a dissertation.

This time tomorrow I {will / ^{??}am going to} be driving to London.

- (e) The sign # is put before forms that are not ungrammatical or unacceptable but do not express the meaning that is intended in the clause or sentence under discussion. For example, in 1.46.1, the following example is given to illustrate that a nonbounded representation of a situation is incompatible with an inclusive duration adverbial. (The sentence is grammatical on another reading, viz. 'It lasted an hour before John was speaking'.)

John was speaking in an hour.

- (f) Small capitals in an example identify the word receiving the nuclear accent of the clause, or (in most cases) an extra heavy contrastive accent.

[“Bill was the one who wrote this note.” – “No.] PETE wrote it.”

- (g) In the text, technical terms that are introduced for the first time are printed in small capitals (in blue).

An **ABSOLUTE TENSE** is a tense that relates the time of a situation directly to the temporal zero-point.

- (h) Italics will be used for four purposes: (i) for comments added to examples, (ii) in example sentences that are incorporated into the main text, (iii) to emphasize a word in the text, and (iv) to indicate the relevant word(s) in a numbered example.

In *John saw the house before I saw it*, both past tense forms are arguably absolute past tense forms. (*Both situations are interpreted as factual.*)

We claim that there *is* a future tense in English, though many linguists argue otherwise. (*example sentence*) I saw the house before John *had* seen it. (*The past perfect in the before-clause expresses ‘not-yet-factuality’: John had not seen the house yet when I saw it.*)

- (i) Lexical items in a comment (which is italicized) are underlined.

I know that he will do it if you let him. (*Will do* establishes a post-present domain, while *let* expresses simultaneity in it.)

- (j) Real quotations are placed within double quotation marks. Single quotation marks are used to indicate concepts, paraphrases, word strings, etc.

(*example sentence*) “Bill was the one who wrote this note.” – “No. PETE wrote it.”
John stand there for four years is a ‘bounded sentence’, i. e. a sentence which represents the situation referred to as coming to an end at some point.

1.3 The illustrative material

Some of our examples are constructed; the remainder are drawn from computerized corpora, from the World Wide Web (see below) or from personal reading. The latter are followed by an indication of the source. As far as computerized corpora are concerned, the following abbreviations are used:

BNC	British National Corpus of English
BR	Brown University Standard Corpus of Present-day American English
COB-S	Cobuild Corpus of English (UK, spoken)

COB-W	Cobuild Corpus of English (UK, written)
LOB	the Lancaster-Oslo-Bergen Corpus
SEU	the Survey of English Usage Corpus of Written English.
TLS	a corpus of articles that appeared in the <i>Times Literary Supplement</i> in 1997
WSJ	a corpus of articles that appeared in the <i>Wall Street Journal</i> in 1989
www	texts from the Worldwide Web, especially from UK sources

As to the www-examples, we have carefully checked that they are indeed examples occurring in texts produced by native speakers. All the examples have also been judged by one or more speakers whose native language is 'Standard British English'. No examples that sounded odd have been included. As to the system of reference to the examples used, we have decided not to mention the full source but only to mark them as '(www)'. The reasons for this are the following. First, explicit reference to the websites in question would reduce the readability of the text, since such a reference easily takes up a complete line. Secondly, because websites come and go, we could never be sure that the reference would still be valid at the time the reader might want to surf to it. Finally, those who wish to check examples can always google them.

The following abbreviations refer to the following books, articles or plays:

AVON	L. M. Montgomery. <i>Anne of Avonlea</i> . (electronically available through the Gutenberg project)
BAXT	David Baxter. 'Will somebody please say something?' <i>Plays and Players</i> . 1967. 27–64.
BM	David Lodge. <i>The British Museum is falling down</i> . London: Penguin. 1989.
CHUZ	Charles Dickens. <i>Martin Chuzzlewit</i> . Harmondsworth: Penguin. 1969.
CP	David Lodge. <i>Changing places</i> . London: Penguin. 1978.
CRES	N. F. Simpson. <i>The Cresta run</i> . London: Fabers & Fabers. 1966.
DOC	Colin Dexter. <i>The daughters of Cain</i> . London: Macmillan. 1994.
FFFP	Agatha Christie, <i>4.50 from Paddington</i> , London: Fontana. 1970.
FORG	Edgar Wallace. <i>The forger</i> . London: Pan Books. 1960.
GLME	Hendrik Poutsma. <i>A grammar of late modern English. Part I: The sentence. Second Half: The composite sentence</i> . Groningen: Noordhoff. 1929.
GREEM	Kingsley Amis. <i>The green man</i> . St Albans: Panther Books. 1971.
HORN	Norbert Hornstein. 'As time goes by: a small step towards a theory of tense.' <i>Montreal Working Papers in Linguistics</i> 5 (1975): 73–112.
JUMP	Tom Stoppard. <i>Jumpers</i> . London: Faber & Faber. 1972.
LBW	Colin Dexter. <i>Last bus to Woodstock</i> . London: Pan Books. 1977.

- LOD Ruth Rendell. *Lake of darkness*. London: Arrow Books. 1981.
- LSW Colin Dexter. *Last seen wearing*. London: Pan Books. 1977.
- MAR Frank Marcus. ‘Mrs. Mouse are you within?’ *Plays and Players*, July 1968. 29–40.
- NICH Peter Nichols. *A day in the death of Joe Egg*. London: Faber & Faber. 1967.
- NMDT Ruth Rendell. *No more dying then*. London: Arrow Books. 1971.
- OSIN P. D. James. *Original sin*. London: Faber & Faber. 1994.
- PIN David Pinner. *Dickon*. Harmondsworth: Penguin. 1967.
- SCRLT N. Hawthorne. *The scarlet letter*. (electronically available through the Gutenberg project)
- SOA Colin Dexter. *The secret of annexe 3*. London: Pan Books. 1987.
- TCIE Eva Edgren. *Temporal clauses in English*. Uppsala: Almqvist & Wiksell. 1971.
- TOCC Doris Lessing. *This was the old chief’s country*. London: Triad Grafton. 1951.
- TSM Ruth Rendell. *Talking to strange men*. London: Arrow Books. 1987.
- TTR Franz Kafka. *The Trial*. Translated by Willa and Edwin Muir. Harmondsworth: Penguin. 1971.
- WTBS Joe Orton. *What the butler saw*. London: Methuen. 1971.

As far as the spoken corpus examples are concerned, sometimes very minor alterations have been made in the interests of easier intelligibility. These include the insertion of commas, some suppression of hesitation signals such as *er*, and ‘correction’ of small production errors where the intended utterance is obvious, such as the amendment of *you’ll only buy able to buy* to *you’ll only be able to buy*.

1.4 The structure of the book

The book falls roughly into three parts: chapters 1 and 2 provide essential background to the study of tense; chapters 3 to 11 gradually build up a picture of the function of tenses in discourse in English; finally, chapters 12 to 14 provide a more detailed analysis of some of the interactions between tenses and time adverbials in English. Below we give a thumbnail sketch of the contents of each chapter.

In Chapter 1 we define our basic terms and explain those concepts and distinctions that underlie our description of the function of tense in English discourse. We provide definitions of basic linguistic terms such as ‘verb phrase’ or ‘situation’ as we will use them, and give a brief overview of the three main areas of grammaticalized verbal meaning which interact with one another,

namely tense, mood / modality and aspect. We go on to explain our view of what sorts of things can be denoted or referred to by a verb, a verb phrase, a clause or an utterance. Finally we explain the concepts associated with what is traditionally considered to be lexical aspect (for example the contrast between a ‘state verb’ and a ‘dynamic verb’) and introduce the category of ‘actualization aspect’ (which contrasts with both grammatical aspect and lexical aspect and involves a single contrast, viz. that between boundedness and nonboundedness).

Chapter 2 lays the foundation proper of our description of tense in English. There is a brief discussion of what is meant by ‘tense’, with reference to the main issues surrounding the number and nature of tenses in English (for example, the question of whether English has a future tense). We introduce those concepts necessary to describe the way in which tenses are used to locate situations in time relative to speech time and to each other, for example the concept of ‘situation time’, and the concept of ‘orientation time’ (or ‘time of orientation’) – roughly speaking, a ‘known’ time to which a situation time can be related by a tense. The elements of the framework of the tense theory used in this book are outlined here. These include, centrally, the notions of ‘time spheres’, ‘time zones’, and ‘temporal domains’. Time spheres and time zones have to do with the way in which tenses in English divide up time. The concept of temporal domain accounts for the way in which temporal relations between situation times are expressed by tenses, or not, as the case may be. (See chapter 8).

Chapters 3 to 7 deal with the meaning and use of the four ‘absolute’ tenses – roughly speaking, those tenses which relate the time of a situation directly to speech time. Chapters 3 to 5 address, respectively, the present tense, the past tense and the present perfect, and Chapter 6 examines some of the differences between the past tense and the present perfect. In Chapter 7 we take a look at the fourth absolute tense, the future tense, and also at other verb forms that can locate a situation time in the future.

In Chapter 8, we fill in the detail of the theoretical framework on which our description of tense rests. This framework distinguishes between temporal location as it is represented by tenses, temporal location expressed by temporal adverbials and pragmatically implied temporal location. Time as it is represented by tenses is divided into two time-spheres – past and present – and four time zones – past, pre-present, present and post-present. The framework that we propose shows how the four absolute tenses mentioned above establish temporal domains in one of those time zones and how these domains can or cannot (depending on the time zone in question) be ‘expanded’ by the use of ‘relative’ (or in some cases ‘pseudo-absolute’) tenses which relate one situation time to another, rather than to speech time. The final part of Chapter 8 considers some of the interpretive strategies that regulate interpretation of tempo-

ral relations when clauses with absolute tenses follow one another and there is no linguistic indication of the temporal relation between them. Specifically, it considers the way in which the (non)boundedness of the situations concerned guides interpretation of the temporal relationships between them.

Chapter 9 looks in more detail at the different sets of relative tenses used to expand a temporal domain, according to whether the domain is centred in the past time zone, the pre-present time zone, the present time zone, or the post-present time zone.

Chapter 10 takes a closer look at the use of tenses to locate situation times in the future, or, to be more precise, in a temporal domain which is centred in the post-present zone. The set of tenses which can be used to establish post-present temporal domains, but which do not relate situations to one another, make up the 'Absolute Future System'. These include not only the future tense but also certain other forms, such as the future perfect or the simple present when it refers to scheduled future events (e.g. *The train arrives at six*). However, when a temporal domain is centred in the post-present, there is another set of tenses which relate situation times either to the central situation time of the domain or to one another. This set of tenses makes up the 'Pseudo- t_0 -System', so-called because the central time of the domain is treated as a 'pseudo- t_0 ' (roughly, a pseudo-speech-time). Thus, in *He will arrive when you are in London, will arrive* is a tense form from the Absolute Future System (which establishes a post-present temporal domain) whereas *are* is a tense form from the Pseudo- t_0 -System (which expresses simultaneity within the post-present temporal domain in question.) The two systems have different distributions, and the chapter is devoted to a description of the contexts in which each system is either possible, obligatory or excluded.

In Chapter 11, the notion of 'temporal focus' is introduced. This concerns cases in which it is possible to choose between two or more tenses to represent the temporal location of the same situation, depending on whether the temporal focus is on one (represented) time or another. (For example, we may say *We moved to Brighton because it was by the sea* or *We moved to Brighton because it is by the sea*). The choice may be between two (or more) tenses which locate the situation in different time zones or it may be between tenses which locate it within the same time zone. We discuss what difference the choice of temporal focus may make to the interpretation of the discourse.

Chapters 12 to 14, as mentioned above, deal with the interaction of temporal adverbials and the tense of the clause in which the adverbial functions. Chapter 12 explores further the topic which was addressed in chapter 6, viz. the contrast between the past tense and the present perfect when they establish domains in the past zone and the pre-present zone, respectively. The two tenses differ in their co-occurrence with certain types of time adverbial. The relevant categories of time adverbial are described, followed by a discussion of their co-

occurrence with the past tense and the present perfect. Chapters 13 and 14 look at the semantics of the temporal adverbs *when*, *before* and *after* and the consequences of these semantics both for the adverbial clauses they introduce and for the temporal relationship between the adverbial clause situation and the head clause situation.

DEMO

II. General linguistic terminology

1.5 ‘Situation’, ‘actualization’, ‘actualize’

We will use **SITUATION** as a cover term for the various possible types of contents of clauses, i. e. as a cover term for anything that can be expressed in a clause, namely an action, an event, a process or a state (see 1.42). Unless it is necessary to distinguish between these possibilities, we will speak of ‘**the situation referred to**’.¹ The verb **ACTUALIZE** will be similarly used as a cover term for the predicates that are typically associated with one of these situation types. Thus, when it is irrelevant whether a clause refers to the performance of an action, the happening of an event, the development of a process or the existence of a state, we can say that the clause in question refers to the **ACTUALIZATION** of a situation. In this way it is easier for us to make generalizations about clauses and their reference to situations.

It is important to note that *actualize* will be used as an intransitive verb (similar to *happen*). This is a deviation from the normal use of the word, which is mostly used as a transitive verb. Thus, we will say that *John is building a house* expresses that the situation of John building a house ‘is actualizing’ (rather than that the situation ‘is being actualized’). We adopt this convention because we need a verb that functions in a parallel way to ‘happen’ but without the implication that the situation is always an event (rather than a state, action or process). A sentence referring to a state (e. g. *Bill is clever*) also represents a situation as actualizing.

1.6 Phrase

A prototypical **PHRASE** is a group of words forming a unit and consisting of a **HEAD** or ‘nucleus’ together with other words or word groups clustering around it. If the head of the phrase is a noun, we speak of a **NOUN PHRASE** (NP) (e. g. *all those beautiful houses built in the sixties*). If the head is a verb, the phrase is a **VERB PHRASE** (VP). In the following sentence the VP is in italics and the verb head is underlined:

Jill *prepared us a couple of sandwiches.*

A phrase is only potentially complex. In other words, the term is also used to refer to ‘one-word phrases’, i. e. nonprototypical phrases that consist of a head only. Thus the sentence *Jill smokes* is a combination of a noun phrase and a verb phrase.

1. There are several other terms that are similarly used as cover-terms in the linguistic literature: ‘event’, ‘state of affairs’, ‘eventuality’, ‘process’.

1.7 Clause, predicate

Leaving aside nonfinite clauses (i.e. infinitival, participial and gerundival clauses), a prototypical **CLAUSE** is a combination of a ‘subject’ – typically a noun phrase – and a ‘predicate’. The predicate – sometimes called **PREDICATE CONSTITUENT** to distinguish it from ‘verb phrase’ – minimally contains the verb phrase. Thus, in *Jill prepared us a couple of sandwiches*, the VP *prepared us a couple of sandwiches* functions as ‘predicate’, as does *smokes* in *Jill smokes*. The **PREDICATE** of a clause can be roughly defined as ‘what is said (or asked) about the subject’. In other words, the predicate constituent comprises all the constituents of a clause except the subject. A clause, then, is a linguistic unit made up of, minimally, a noun phrase and a verb phrase. In this basic clause, the noun phrase functions as subject (and thus, for example, in English controls the feature of number on the verb) and the verb phrase (VP) functions as predicate. However, the predicate constituent may contain other elements in addition to the VP. These constituents – usually prepositional phrases or adverbial phrases – express optional rather than necessary information (see below). Thus, in *Tim killed three spiders last night*, the adverbial *last night* belongs to the predicate constituent but not to the VP, unless it gives important new information. Out of context, the sentence can be paraphrased ‘Tim killed three spiders. He did so last night.’

1.8 Sentence

1.8.1 A **SENTENCE** is a linguistic unit that can be used as an independent utterance. It is a clause or a combination of clauses that does not function as a constituent of a larger syntactic construction and can therefore be fully analysed syntactically without reference to what precedes or follows. In speech, a sentence is normally delimited by pauses and marked by a falling or rising tone at the end. The following examples illustrate this definition:

Bill hasn't arrived yet. (*pronounced with falling tone*)

[Because it was getting late] she wondered whether her son hadn't missed the train.
(*pronounced with falling tone at the end*)

What did you say you wanted? (*pronounced with rising tone*)

Although the prototypical sentence is made up of one or more clauses, which means it prototypically contains one or more verb phrases, verbless utterances are often treated as ‘verbless sentences’. Since this book is entirely devoted to tense, which is a grammatical category that can only be expressed by verb forms, verbless utterances like *Good evening*, *Much ado about nothing*, *Yes*, *What a shame!*, etc., will be disregarded.

If a sentence consists of two or more clauses, all but the head clause may be introduced by a conjunction, such as *because* and *whether* in the second example above. A conjunction forms part of the overall sentence, but not of the clause which it introduces.

1.8.2 A sentence is **COMPLEX** if it consists of a ‘head clause’ (also known as ‘superordinate clause’) and at least one ‘subclause’ (also known as ‘subordinate clause’, ‘dependent clause’ or ‘embedded clause’). The **HEAD CLAUSE** is the clause on which a given subclause is syntactically and semantically dependent. A head clause may be a clause that does not syntactically depend on any other clause, but it may also be a subclause of another head clause. If it is a syntactically independent clause, it can also be referred to as the **MATRIX**, i.e. the highest clause in the inverted tree structure representing the syntactic structure of a sentence. Thus, in

I know that he was at home when the accident happened.

the clause *that he was at home* is at the same time the head clause of *when the accident happened* and the subclause depending on the head clause *I know*, which is the matrix clause of the entire complex sentence.²

A **SUBCLAUSE** is a clause that is a syntactic constituent of, or depends on, another clause (and can therefore seldom be used on its own). Most subclauses have a function that is typically associated with a noun (phrase), an adjective (phrase) or an adverb (phrase). We speak of **NOMINAL CLAUSES** (or **NOUN CLAUSES**), **ADJECTIVAL CLAUSES** and **ADVERBIAL CLAUSES** accordingly.

The man *who lives next door* is looking at our house. (*adjectival clause*)

I don't know *if I can believe that* [because my sister denies it]. (*nominal clause*)

I'll help you *if I have time*. (*adverbial clause*)

Subordinate clauses (= subclauses) are normally introduced by such connectors as *after*, *although*, *as*, *as if*, *as soon as*, *because*, *before*, *if*, *once*, *provided (that)*, *since*, *that*, *though*, *unless*, *when*, *where*, *in case (that)*, *in order that*, etc. We call them **SUBORDINATING CONJUNCTIONS**. Before a nominal clause, the conjunction *that* is often dropped (e.g. *I said you could trust me*). In that case we speak of a **ZERO-CONJUNCTION**.

2. ‘Head clauses’ are also often referred to as ‘main clauses’. However, in connection with complex sentences consisting of more than two clauses the term ‘main clause’ is potentially ambiguous: does it mean ‘head clause’ or ‘matrix’? The head clause supporting a subclause may itself be a subclause depending on another head clause. It seems odd to use the term ‘main clause’ to refer to a clause which is at the same time head clause and subclause. For that reason we will not use the term ‘main clause’ in this work.

1.9 Alternative definitions of ‘verb phrase’

In 1.7 we have defined the VP as that part of the predicate constituent that does not contain optional adverbials. (In many cases the predicate consists of a VP only.) We will stick to this definition in this work. However, it may be useful to know that some linguistic works use the term in a different sense. Some use it in the sense of our ‘predicate (constituent)’, i. e. to refer to the sum of all those constituents of the clause that do not belong to the subject NP. Others use the term in a much narrower sense, to denote no more than the **MAIN VERB** and any auxiliaries accompanying it. Thus seen, the VP of *He may have been reading a book* is *may have been reading* (rather than *may have been reading a book*). In the present work a string like *may have been reading* or *will read* will be referred to as a ‘verb form’. A **VERB FORM** consists either of a verb (in the form of a participle or infinitive) plus one or more auxiliaries (e. g. *will see*, *would have seen*) or of a (usually inflected) verb only (as in *They take drugs*, *John smokes*).

1.10 Tensed vs nontensed verb forms

1.10.1 As far as English is concerned, only finite verb forms are **TENSED**. The term **FINITE** (which means ‘limited’) refers to a verb form that is marked for tense and potentially also for other grammatical categories like mood, person and number. (These markings limit the possibilities of using the form). For example:

works (marked for tense, mood, person and number: present tense, indicative mood, third person, singular)

drank (marked for tense and mood only: past tense, indicative mood) (unmarked for person and number)

The form *works* is more limited in applicability than *drank*, since it cannot be used, say, with a plural subject. *Drank* can be used in a wider range of grammatical environments, but it cannot be used in a situation in which a present tense form is required. Being marked for tense apparently stands out as a necessary defining feature of finite verb forms in English.

1.10.2 Because of the crucial importance of being marked for tense, finite verb forms are by definition indicative forms. Compare:

They *were* in the kitchen.

John wished he *were* somewhere else.

In the first example, *were* is an indicative form because it is tensed: it is a past tense form locating the time of the state referred to in the past. In the second

example, *were* is a subjunctive form. Though traditionally called ‘**PAST SUBJUNCTIVE**’ (because of the formal contrast with the ‘**PRESENT SUBJUNCTIVE**’ *be* and the fact that it has the same form as the past indicative form *were*), the subjunctive form *were* is not tensed, because it does not express or imply any temporal relation between the time of the situation referred to (= John’s being somewhere else) and the time of speech.

1.10.3 In later chapters we will distinguish between ‘**absolute**’ and ‘**relative**’ **past tense** forms (see especially 8.23–32). The former relate the time of a situation directly to the ‘**TEMPORAL ZERO-POINT**’ t_0 (which is usually the time of speech – see 2.4), whereas the latter relate it to another ‘**ORIENTATION TIME**’. Thus, *John suddenly complained that he felt ill* is analysed as having an absolute tense form *complained*, which locates the complaining in the past (relative to the time of speech), and a relative tense past form *felt*, which represents the situation of John feeling ill as simultaneous with the situation referred to by *complained*. It might seem as if the past subjunctive *were* did the same job in *John wished he were somewhere else*, but this is not true, whereas a relative past tense form can only express simultaneity with a past time of orientation,³ the past subjunctive can express simultaneity with any time of orientation, irrespective of whether it is past, present or future. Compare:

John {said / says / will say} that Bill *was* ill. (*It is only after said that was is interpreted as a relative past tense expressing simultaneity. After says and will say, Bill was ill is interpreted as expressing that Bill’s illness is anterior to the present or future time of saying.*)

John {wished / wishes / will wish} he *were* somewhere else. (*In all three cases the subjunctive form were is interpreted as expressing simultaneity.*)

It is clear from these examples that a relative past tense still has an ‘absolute tense’ component (see 1.18) in its semantics: the time of orientation with which a relation of simultaneity is expressed must form part of a ‘temporal domain’ (see 2.15) which is past with respect to the temporal zero-point.⁴ The past subjunctive does not share that semantic characteristic. This means that in spite of expressing simultaneity, the subjunctive *were* is not a relative *tense* form. Since, obviously, it is not an absolute tense form either (i. e. it does not relate its situation to the temporal zero-point), it can only be treated as an ‘untensed’ form. In this respect it resembles nonfinite verb forms, i. e. infinitives, participles and gerunds.

3. This formulation is a simplification. As we will see in 8.12, the semantics of a relative past is that it expresses simultaneity with a time of orientation in a past temporal domain (or in a ‘pseudo-past subdomain’ – see 9.9.1).

4. As will become clear in 8.15, saying that a temporal domain is past relative to the zero-point means that the ‘central time of orientation’ of the domain is past relative to the zero-point.

1.10.4 ‘Marked for tense’ or ‘tensed’ does not simply mean ‘carrying temporal information’. Nonfinite verb forms may have a ‘perfect’ form, i. e. express anteriority (e. g. *have eaten*, *having eaten*). The point is that the time of orientation to which they relate the time of their situation does not have to be the temporal zero-point. It is criterial of tensed forms that they encode information concerning the relation of the time of a situation to the temporal zero-point t_0 (which is usually the time of speech – see 2.4), whether that relation is direct (as in absolute tenses) or indirect (as in relative tenses). Subjunctive forms and nonfinite forms do not share this characteristic. They are therefore treated as **UN-TENSED (TENSELESS)** forms.

1.11 ‘Present’ and ‘perfect’ nonfinite forms

1.11.1 There are two formal types of infinitives, illustrated by *eat* and *have eaten* and traditionally referred to as **PRESENT INFINITIVE** and **PERFECT INFINITIVE**. These labels should not suggest that infinitives are tensed in the same way as the present tense, the present perfect, the past perfect etc. are tensed: infinitives are tenseless – see 1.10.4. However, it is true that the present and perfect infinitives usually express simultaneity and anteriority respectively: in *He seems to be ill* and *He seems to have been ill*, the being ill is located simultaneous with or anterior to the time of the head clause situation, respectively. We will therefore stick to the traditional labels ‘**present infinitive**’ and ‘**perfect infinitive**’ and consider them based on the form of the infinitive, while keeping in mind (a) that ‘present’ and ‘perfect’ here have nothing to do with tense, and (b) that on their default interpretation the present and perfect infinitives express simultaneity and anteriority (to the time of the head clause situation), respectively.

1.11.2 Similarly, there are two participle forms in English: the so-called **PRESENT PARTICIPLE** and the **PAST PARTICIPLE**. Like ‘present infinitive’ and ‘perfect infinitive’, these labels are not quite felicitous because ‘present’ and ‘past’ suggest a distinction of tense, whereas participles are tenseless (like the other nonfinite forms). This means that present and past participles are not present or past tense forms, and that they do not necessarily refer to present or past time respectively. Consider for example the present participle *causing* in the following sentences:

- Any hotel guests causing a disturbance *tonight* will be asked to leave tomorrow.
- The hotel guests causing a disturbance *at the moment* will be asked to leave immediately.
- The hotel guests causing a disturbance *last night* will be asked to leave today.

In each of these examples, the situation of asking those causing a disturbance to leave is located in the future. The situation of their causing a disturbance, however, is interpreted as lying in the future in the first case, in the present in the second, and in the past in the third.

1.11.3 Like the infinitive and the participle, the gerund has two forms (e.g. *walking* versus *having walked*), which we will label ‘**PRESENT GERUND**’ and ‘**PERFECT GERUND**’, respectively. The perfect gerund always expresses anteriority, whereas, depending on the context, the present gerund can be interpreted in terms of simultaneity, anteriority or posteriority:

I confirm *being* over 18 years of age. (www) (*simultaneity reading*)

Social workers confirmed *being* overwhelmed by child protection work. (www) (*simultaneity reading*)

[He seems to have been unaware of his sisters,] which appears to confirm *being orphaned* at an early age. (www) (*anteriority reading*)

John has admitted {*making* / *having made*} a mistake last week. Now he regrets {*doing so* / *having done so*}. (*anteriority reading*)

Certainly, it would have been hard to find anyone in the early 1960s who would have anticipated him *making* such a blunder. (www) (*posteriority reading*)

1.12 Lexical verbs *vs* auxiliaries

1.12.1 Verbs can be classified in many different ways. The first distinction is between those verbs that have a full set of forms and those that do not. This distinction coincides roughly with the distinction between **LEXICAL VERBS** (or **FULL VERBS**) and **AUXILIARIES** (or **AUXILIARY VERBS**). These two groups show differences on various levels (formal, semantic and syntactic). The following offer some illustrations:

(*lexical verbs*) type, look for, cost, develop, begin, stand

(*auxiliaries*) must, should, can, might, be [V-ing], be [V-en], ought to

1.12.2 **LEXICAL VERBS**, as their name suggests, have a lexical meaning, that is, a meaning that is denotational (extralinguistic) rather than grammatical (intralinguistic). They are verbs like *burst*, *run*, *change* and *contain*, which refer to situations types of different kinds (events, actions, processes or states – see 1.42). Lexical verbs are sometimes called ‘**FULL VERBS**’, a term which is used to indicate that they are syntactically ‘fully-fledged’ verbs (e.g. they can combine with auxiliaries but can also do without them), that they have a full system of verb forms (called ‘**CONJUGATION**’ – e.g. *walk*, *walks*, *walked*, *walking*) and that they are semantically rich in that they evoke a set of concepts of things, persons and circumstances which are needed for a correct understanding of the verb.

Lexical verbs form an ‘open’ (i. e. unlimited, productive) group. For example, as the world around us changes, new verbs are coined to express new ways to interact with it, such as *google* (“to search the Web using the search engine *Google* for information on a person or thing”):

I didn’t know what a cosmopolitan was in the drinks world so I *googled* it and it said something about it being for tarts. (www)

When we *googled* the combination *I googled it* on 19 March 2003, no fewer than 473 links came up, indicating that this verb has found its way into the English language. On 24 September 2003 *I googled it* produced 1,420 links (and *googled* produced 38,100). Other additions are *webcast* and *spam (the web)*. New verbs also appear on the scene to express concepts that could already be expressed by other lexical items. Phrasal verbs (particle verbs), especially, provide a rich source of contributions to the expanding lexical stock of English, as testified by recent creations like *dumb down* (= ‘reduce the intellectual content or capabilities of’), as in *They dumbed him down to make Jess seem smarter* (www), *gross (someone) out* (= ‘revolt’) or *fluff (one’s food) up* (= ‘throw up’).

1.12.3 **AUXILIARIES** have little or no lexical meaning. They are ‘helper’ verbs, in the sense that they help to form complex verb forms. In doing so they express either a grammatical notion (like ‘passive’, ‘progressive’ or ‘tense’) or one or more modal ideas. This is not to say that auxiliaries are devoid of meaning, but their meanings are more schematic (i. e. more ‘skeletal’, more ‘abstract’, less ‘full’) than those of lexical verbs.

Within the auxiliaries we can make a distinction between two classes: **GRAMMATICAL AUXILIARIES** and **MODAL AUXILIARIES**. The former, which are sometimes referred to as ‘primary auxiliaries’, have a purely grammatical function:

- (a) the ‘**TENSE AUXILIARY**’ *have*, which is used in forming perfect tense forms;
- (b) the ‘**ASPECT AUXILIARY**’ *be*, which is used for building progressive verb forms;
- (c) the ‘**VOICE AUXILIARY**’ *be*, which is used in the passive;
- (d) the ‘**PERIPHRASTIC AUXILIARY**’ *do*, which is used as a ‘dummy’ (pro-form) when a VP that does not contain an auxiliary (e. g. *love her*) is used in a construction that requires one (e. g. *I don’t love her*, *Do you love her?*, *I do love her*, etc.)

Next, there are the ‘**MODAL AUXILIARIES**’: *can*, *could*, *may*, *might*, *must*, *shall*, *should*, *ought to*, *will*, and *would*. These auxiliaries express special shades of meaning, such as volition, possibility, permission, necessity, intention, obligation, expectation, inference, ability, determination, etc. The modal auxiliaries differ semantically from the first group in that they add lexical meaning rather than fulfil a grammatical function. However, they still have less concrete, and

hence more widely applicable, meanings than most lexical verbs.⁵ This wider applicability explains why auxiliaries form a relatively small set when compared with lexical verbs.

1.12.4 Because an auxiliary does not have a full lexical meaning, it cannot be used without a main (lexical) verb, except in ‘CODE’, where the auxiliary is used as pro-form for an entire verb phrase (as in *John will not be sleeping, but I will*). In other words, an auxiliary cannot be the only or last verb form in the VP (except in ‘code’). In the following example the main verbs are italicized while the auxiliaries are underlined:

[“What did he do last night?”] – “He {*studied* / *worked* / may have *slept* / *could / *had to / *would}.”

1.12.5 Unlike lexical verbs, auxiliaries have the so-called ‘NICE-PROPERTIES’. ‘NICE’ is an acronym (coined by Huddleston 1976) consisting of the initial letters of the terms *negation, inversion, code* and *emphasis*. The reference is to the four cases in which the English VP requires an auxiliary. If there is no auxiliary, the ‘PERIPHRASTIC AUXILIARY’ *do* has to be added. In that case we say that the lexical verb requires ‘DO-SUPPORT’. In other words, the statement that ‘auxiliaries have the NICE-properties’ means that they do not combine with the periphrastic auxiliary *do* in clauses made negative by the use of *not*, in clauses involving subject-auxiliary inversion, in code (see 1.12.4) and in cases of emphasis. By contrast, clauses without an auxiliary need ‘do-support’ (i.e. the insertion of *do*) in these four cases. Compare:

He went / He didn’t go / Did he go? / Yes he did / He DID go.

He will go / He won’t go / Will he go? / Yes he will / He WILL go.

1.13 Transitive vs intransitive lexical verbs

1.13.1 To be used grammatically in a normal declarative clause, lexical verbs require one or more ‘ARGUMENTS’: a subject, sometimes called the ‘external argument’ (because it does not belong to the predicate constituent), and possibly one or more ‘internal arguments’, usually called **COMPLEMENTS**, such as

5. This is a generalizing statement. Some full (= lexical) verbs also have little lexical meaning (semantic content), e.g. *seem, be, appear* (as a copula), *look* (as a copula), etc. Moreover, some full verbs like *want* are on the way to becoming auxiliaries in that they have a contracted form (*I wanna go to Italy*), which is characteristic of auxiliaries, not of full verbs. The full verbs *be* and *have* also allow contraction, as in *He’s fine* or *He’s nothing to say*. This means that the distinction between auxiliaries and full verbs is not always sharp: they form a scale with prototypical auxiliaries (like *must*) at one end and prototypical lexical verbs (like *walk*) at the other end.

a direct object (e.g. *I hit him*), indirect object (e.g. *I gave him a kite*), subject complement (e.g. *Bill is ill*), object complement (e.g. *We called him a fool*), prepositional object (e.g. *I looked into the question carefully*). Verbs that can only take a subject argument are called ‘**INTRANSITIVE VERBS**’. Verbs that also take one or more nominal complements are called ‘**TRANSITIVE VERBS**’, except if the complement in question is a subject complement (e.g. *Bill is a nurse*), in which case the verb is a ‘copula’ or ‘linking verb’ (see immediately below).

1.13.2 The term ‘transitive verb’ does not cover one-complement verbs like *be*, *seem*, *become*, etc. which are **LINKING VERBS** or **COPULAS** or **COPULAR VERBS**. These verbs are not followed by a direct object but by a **SUBJECT COMPLEMENT**. A subject complement says something about the referent of the subject, i. e. it either ascribes a characteristic to that referent or identifies the person or entity in question.

John is a *plumber*.

He seems a *reliable man*.

The chairman is *that man over there*.

This wine tastes *sour*.

DEMO

III. Meaning categories expressed by verb forms

There are four systems of the verb phrase which grammaticalize meaning, but only three will prove relevant to the discussion of tense, namely tense itself, grammatical aspect, and mood / modality. (The category that is not relevant to tense is voice.) These three areas of grammatical meaning interact with one another and therefore need to be considered together. Apart from them, this chapter also pays attention to ‘lexical aspect’ and ‘actualization aspect’ because these systems of meaning often interact with tense, and are therefore essential to any complete discussion of tense.

A. Tense

1.14 Introduction

1.14.1 We should make a careful distinction between ‘tense’ and ‘time’. **TIME** is an extralinguistic category. That is, it exists independently of language. **TENSE** is a linguistic concept: it denotes the form taken by the verb to locate the situation referred to in time, i. e. to express the temporal relation between the time of the situation in question and an ‘orientation time’ which may be either the ‘temporal zero-point’ (which is usually the time of speech – see 2.4) or another orientation time that is temporally related to the temporal zero-point. For example, in the sentence *John confessed that he had stolen the money* the past tense form *confessed* locates the time of the confession in the past, i. e. in a time-zone which lies completely before the zero-point. The past perfect form *had stolen* expresses that the theft was committed before the confession. The time of the confession is thus the orientation time to which the time of the theft is represented as anterior by the past perfect. In sum, verb forms are tense forms if they relate a situation time directly or indirectly to the zero-point.

1.14.2 The traditional **NAMES** for the tenses in English are:

- (a) ‘Present tense’, e. g. *I live here.*
- (b) ‘Past tense’ or ‘preterite’, e. g. *I made a mistake.*
- (c) ‘Future tense’, e. g. *I will do it.*
- (d) ‘Present perfect’, e. g. *We haven’t met yet.*
- (e) ‘Past perfect’ or ‘pluperfect’, e. g. *I hadn’t expected this.*
- (f) ‘Conditional tense’, e. g. *We would soon find out.*
- (g) ‘Conditional perfect’, e. g. *She would have left by then.*

Three points should be borne in mind here. First, only indicative forms are tensed – see 1.10. Second, all tenses have nonprogressive and progressive

forms: *I live here* and *I'm living here* are both sentences in the present tense. Thirdly, when the verb form is a complex form involving one or more auxiliaries, it is the first auxiliary (the so-called **OPERATOR**) that is marked for tense, not the main verb. For example:

John {is / was / has been / will be} blamed for the accident.

He {doesn't / didn't / won't} know the answer.

In this context, 'marked for tense' is to be interpreted as 'morphologically expressing reference to a past or nonpast 'temporal domain' – see 2.33–35 and 2.41–46.

He promised he *would have left* by tomorrow. (*Would have left* is a 'conditional perfect tense' form. It is the form as a whole that expresses the meaning of the conditional perfect tense. However, the element of 'pastness' in its meaning is expressed exclusively by the operator would, which is the past tense form of will.)

1.15 The formation of the present tense

The forms of the present tense of all verbs except *be* and *have* are homophonous with the **STEM** of the verb (e.g. *underline*), except in the third person singular (e.g. *underlines*). (The stem is that part of the verb that remains constant in the different forms of the verb, e.g. *unravel* in *unravels*, *unravelled*, *unravelling*.) The stem of the verb can also be used as a present infinitive (which is the citation form of the verb used as an entry in dictionaries).

1.16 The formation of the past tense

The regular past tense (indicative form) consists of the stem of the verb and a suffix usually written as *-ed*. The fact that the addition of the suffix is sometimes accompanied by a minor spelling adjustment to the stem is not considered as relevant. Verbs that form their past tense this way are called **WEAK VERBS** or **REGULAR VERBS**.

play – played; love – loved; cry – cried; equip – equipped; picnic – picnicked

However, there are quite a few verbs in English that are **IRREGULAR VERBS** or **STRONG VERBS**. These verbs do not form their past tense by the addition of a suffix (mostly written as *-ed*) to the stem, but by various other means, most of which are illustrated by the following examples:

bend – bent, lend – lent, send – sent, spend – spent

creep – crept, keep – kept, sweep – swept, weep – wept

bleed – bled, breed – bred, feed – fed, speed – sped

blow – blew, grow – grew, know – knew, throw – threw
 bind – bound, find – found, grind – ground, wind – wound
 drink – drank, shrink – shrank, sink – sank, stink – stank
 dig – dug, fling – flung, hang – hung, swing – swung
 bear – bore, swear – swore, tear – tore, wear – wore
 fit – fit, hit – hit, set – set, cut – cut

The list of strong verbs is to be found in most standard grammars and dictionaries.⁶

1.17 The formation of the other tenses

1.17.1 Many people hold that there are only two tenses in English, viz. the present and the past, because this is the only distinction that is expressed morphologically, i. e. by means of verb endings (or substitutive forms in the case of strong verbs). However, there is no a priori reason for assuming that tense can only be expressed morphologically, and not also by the use of auxiliaries – see 2.7. The tense forms other than the present tense and the past tense are all complex tense forms. In a complex tense form the first auxiliary (= the operator) is morphologically in the present or past tense.

1.17.2 In a complex tense form, the tense auxiliary functioning as operator may be either *have* or *will*. Both can appear in their present or past tense form:

I have done it. (*present perfect tense*: ‘[*have* + PRESENT] + *past participle*’)

I had done it. (*past perfect tense*: ‘[*have* + PAST] + *past participle*’)

I will do it. (*future tense*: ‘[*will* + PRESENT] + *present infinitive*’)

[I promised that] I would do it. (*conditional tense*: ‘[*will* + PAST] + *present infinitive*’)

I will have done it by 5 p.m. (*future perfect tense*: ‘[*will* + PRESENT] + *perfect infinitive*’)

[I promised that] I would have done it by 5 p.m. (*conditional perfect tense*: ‘[*will* + PAST] + *perfect infinitive*’)

The four tenses involving a form of *have* can be grouped together as **PERFECT TENSES**.

6. For some linguists, ‘strong verb’ and ‘irregular verb’ do not cover the same concept, nor do the terms ‘weak verb’ and ‘regular verb’. For these linguists, past tense forms like *set*, *spent*, *put*, *sat*, etc. are both strong and irregular. Past tense forms like *slept*, *dreamt*, *burnt*, etc. are considered to be irregular but not strong: they are weak because they are built by the addition of a dental suffix, but they are irregular in that the vowel of the stem is replaced by another vowel.

1.17.3 In the first person, both singular and plural, the auxiliary *shall* is possible as a (rather formal and less usual) alternative to the future tense auxiliary *will*. This distribution also holds for *shall* and *will* in the future perfect and for the nonmodal uses of the conditional tense forms *should* and *would* in the conditional tense and the conditional perfect.

1.18 The meanings of tenses: expressing temporal relations

1.18.1 Four tenses can be used to relate the time of the situation referred to directly to the temporal zero-point (moment of speech):

It is hot outside. (*present tense*)

Alex thought about his future. (*past tense*)

Have you ever been to Vienna? (*present perfect*)

Prudence will retire in a month. (*future tense*)

We will refer to tenses that express a direct temporal relation with the temporal zero-point as **ABSOLUTE** tenses.

1.18.2 Tenses that express a single temporal relation between the time of the situation referred to and an **ORIENTATION TIME** other than the zero-time will be referred to as **RELATIVE TENSES**. They express one of the following temporal relations:

- (a) **ANTERIORITY**: the time of the situation is represented as preceding the orientation time (e.g. *He said he had got up early*).
- (b) **SIMULTANEITY**: the time of the situation is represented as coinciding with the orientation time (e.g. *He said he didn't feel well*). (See 2.17.1 for evidence that simultaneity expressed by a tense form always means coincidence.)
- (c) **POSTERIORITY** (or futurity): the time of the situation is represented as following the orientation time (e.g. *He said he would save us*).

1.18.3 Tenses like the future perfect (e.g. *will have left*) and the conditional perfect tense (*would have left*) express two temporal relations at once: the time of the situation is represented as anterior to an orientation time which is itself represented as posterior to another time. In the case of the future perfect this 'other time' is the temporal zero-point. This means that the future perfect is an **ABSOLUTE-RELATIVE** tense: it relates the time of its situation to a time of orientation – this is the relative component – which is itself related to the zero-point – this is the absolute component in the meaning of the future perfect. In the case of the conditional perfect, by contrast, neither of the orientation times with which a temporal relation is expressed is the temporal zero-

point. This means that the semantics of this tense consists of two relative components. We will therefore call it a **COMPLEX RELATIVE** tense.

Next to absolute-relative tenses and complex relative tenses, there are also a few (nameless) tenses that are even more complex, because they involve three temporal relations:

For four months now John *has been going to have finished* his novel by today, [but it is not finished yet.] (= ‘For four months now John has said that he was going to have finished his novel by today.’)

Tomorrow Bill *will have been going to pay me back* for three weeks [but I still have not seen a penny]. (= ‘Tomorrow it will be three weeks that Bill has been saying that he is going to pay me back.’)

1.18.4 We can conclude that absolute and relative tenses express a single temporal relation, while absolute-relative tenses and complex relative tenses express two relations, and some tenses even express three relations. These various types of tenses have different semantic structures.

1.18.5 Apart from this, it should be noted that tenses that are basically used as absolute tenses can sometimes fulfil the function of relative tenses. In their default use these tense forms are absolute tense forms: they relate the time of the situation referred to directly to the temporal zero-point. However, the same forms can also relate the time of a situation to a post-present (= future) orientation time which is treated *as if it were* the temporal zero-point. In that case the tense forms function like relative tense forms. Because they relate the time of their situation to an orientation time which is a ‘**PSEUDO-ZERO-POINT**’, i. e. a time treated as if it were the zero-point, these tense forms will be called **PSEUDO-ABSOLUTE** tense forms – see 9.17 for a fuller explanation. For example, compare:

- (1) John *was* thirsty last night.
 John *has been* thirsty all morning.
 John *is* thirsty.
 John *will be* thirsty this afternoon [if he eats those crisps].
- (2) [Next time you see him John will again say that] he *was* thirsty the night before.
 [Next time you see him John will again say that] he *has been* thirsty all morning.
 [Next time you see him John will again say that] he *is* thirsty.
 [Next time you see him John will again say that] he *will be* thirsty in the afternoon.

The four verb forms in (1) are absolute tense forms: they relate the time of John’s being thirsty directly to the time of speech. In (2), the same verb forms relate the time of John’s being thirsty to a future orientation time (the time of *will say*), which, as far as the use of tenses is concerned, is treated as if it were the time of speech. The four verb forms are now used like relative tenses.

Because they express a temporal relation with a future ‘pseudo-zero-point’ – this is their semantics – we can refer to them as ‘pseudo-absolute’ tense forms. Such tense forms have the *form* of absolute tenses but the *function* of relative tenses.

1.19 Special uses of tenses

1.19.1 In **modal sentences**, some of the indicative tenses (viz. the past, the past perfect, the conditional tense and the conditional perfect) do not express the usual temporal relations. Compare:

He thinks I *didn't know* his number. (*nonmodal past tense expressing that the subclause situation actualized before the time of speech*)

I wish I *didn't know* his number. (*modal past*) (*The subclause situation is not related to speech time but to the time of the head clause situation; it is represented as simultaneous with the orientation time indicated by I wish. In addition to expressing this temporal relation, the past tense also represents the situation as contrary-to-fact: it implies that I do know his number. This is why it is called a ‘modal’ past.*)

The following are similar, except that the modal past perfect expresses anteriority rather than simultaneity:

I wish you *hadn't told* me the truth.

[What is wrong with him?] He looks as if he *had seen* a ghost!

In conditional sentences like the following, all the tense forms are used for a modal reason, viz. to express unreality. None of them locates its situation in the past.

I *wouldn't be* here if I *didn't love* you.

If you *had come* tomorrow instead of today, you *wouldn't have found* me at home.

In conditionals of the type illustrated by the last example, the pluperfect (= past perfect) is sometimes replaced by a ‘**DOUBLE PLUPERFECT**’, i. e. by ‘*had + perfect infinitive*’.

[I've often said to people probably feeling bitter in my own way sometimes I have sat and thought] I'd have coped better if he *had have been* in a wheelchair. (COB-S)

Had he have lost this frame, it would have been all over for him. (said by a BBC commentator during a televised snooker contest)

This use of the double pluperfect is typical of an informal spoken style and will not be further discussed in this book.

1.19.2 Some tenses have one or more **METAPHORICAL USES**: they are used to represent a particular time *as if* it were another time. The present tense, for

example, can be used to refer not only to the present, but also to the past and to the future. For example, in narration we often find a switch from the past tense to the ‘historic present’:

One day, my youngest was sat in the garden brushing her rabbit when up *comes* Oscar. There *are* a few of us in the garden and we *watch* with some trepidation. [...] (www)

Under certain conditions, the present tense can also locate a situation in the future:

I’m leaving in a few hours.
[Hurry up!] The train leaves at 5.37.

B. Aspect

1.20 Introduction

1.20.1 In linguistics – and now we are not referring to English only – the term **GRAMMATICAL ASPECT** refers to the possibility of using special grammatical forms (more specifically: verb forms) to express various meanings which have to do with how the speaker wants to represent the internal temporal structure of a situation.

Semantically, aspects are different ways of viewing the internal constitution of an actualizing situation. These different ways are expressed by different markers on the verb (i. e. suffixes, auxiliaries or a combination of the two, as in the English progressive form), although not all languages have a marker for every one of the aspectual meanings. In principle, a speaker may use a special verb form to refer to a situation in its entirety (**PERFECTIVE** aspect), or he may use forms which represent it as beginning (**INGRESSIVE** or **INCHOATIVE** aspect), or as ongoing (**PROGRESSIVE** aspect), or as ending (**EGRESSIVE** aspect).⁷ (As we will see, the latter three options represent the possibilities of **IMPERFECTIVE** aspect.) The speaker may also use a form which specifically represents the situation as actualizing once (**SEMELFACTIVE** aspect) or a form which represents the situation as a ‘hypersituation’ consisting of a repetition of the same situation (**ITERATIVE** or **REPETITIVE** aspect). The speaker may in principle also make use of a form which expresses **HABITUAL** aspectual meaning. (A habit is a situation type that is characteristic of the referent of the subject NP over an extended period of time. Sentences like the following receive a habitual inter-

7. Ingressive aspect is also called ‘inceptive’ aspect. Progressive aspect is also referred to as ‘continuous’ aspect. And egressive aspect can also be labelled ‘terminative’ aspect.

pretation: *John smokes a pipe, Bill can be very clever, She {will / would} often go to church, Karen used to like toads* – see also 1.23).

In English, there are only two aspects that are systematically expressed by special verb markers, viz. progressive and nonprogressive aspect:⁸

I'm writing a book. (*progressive aspect: the situation is represented as ongoing, i. e. as being in its 'middle'*)

I go to the office by car. (*nonprogressive aspect: the reference is to a situation (in this case: a habit) as a whole*)

In sum, what we are concerned with when we speak about grammatical aspect in English is the pairing of the progressive form with progressive meaning and the pairing of the nonprogressive form with nonprogressive meaning. Compare:

I wrote an essay last night.

I was writing an essay last night [when Henry came in].

In the first sentence, the use of the nonprogressive form *wrote* indicates that the speaker views the situation of writing an essay as complete. (Furthermore, since this situation lies in the past, we know that the essay was completed – in 1.21.2 we will come back to the subtle distinction between representing a situation as *complete* and representing it as *completed*.) In the second example, the use of the progressive auxiliary *be* (and the suffix *-ing*) indicates that the speaker wants to represent the situation of writing an essay as ongoing (rather than as complete) at the time referred to by the *when*-clause, which functions as 'VANTAGE TIME' – see 1.22.5.

Since grammatical aspect is the grammatical expression of a particular meaning, an aspectual label can be applied both to a particular meaning and to the grammatical form expressing it. Thus, in *John was walking home* the 'PROGRESSIVE FORM' expresses 'PROGRESSIVE MEANING', while in *John walked home* the 'NONPROGRESSIVE FORM' expresses 'NONPROGRESSIVE MEANING'.

1.20.2 In section 1.33.1 we will see that, apart from *grammatical aspect*, there is also so-called **LEXICAL ASPECT**, which we will also refer to as **ONTOLOGICAL ASPECT**. The latter category (also called 'AKTIONART') has to do with the way the lexical material in the verb phrase determines one or more inherent characteristics of a kind of situation, for example, whether this situation is (conceived of and represented as) durative or punctual (compare, for example, *run* with

8. As noted in 1.23.1, there are a couple of auxiliaries that can under certain conditions be used to express habitual meaning, viz. *can, could, will, would* and *used to*, but these can be disregarded here because there are heavy constraints on their use and (especially) because (except for *used to*) their unmarked use is not to express habituality.

arrive). A third sort of aspect, to be distinguished from both grammatical and ontological aspect, is what we will call **ACTUALIZATION ASPECT**, which has to do with whether the actualization of the situation referred to is represented as ‘**BOUNDED**’ (i. e. as reaching an endpoint) or not. For example, [*If this tank starts leaking,*] *twenty litres of petrol will run onto the floor* represents the actualization of the situation referred to as bounded – the situation will come to an end when the twenty litres in the tank have run out of it – whereas [*If this tank starts leaking,*] *petrol will run onto the floor* does not. Note that in these examples it is the (actually bounded or nonbounded) nature of the referent of the subject NP that is responsible for the difference in boundedness of the situations as they are represented by the two clauses. It will be clear from this that actualization aspect is not a question of how a verb phrase describes a kind of situation. Rather, it is a question of how a clause represents the actualization of a situation. (Both ontological aspect and actualization aspect are determined by the choice of lexical material, the former on the level of the verb phrase, the latter on the level of the clause.)

In the following subsections we will give a brief overview of the different aspectual meanings that can be expressed grammatically in naturally language (but most of which are expressed differently in English). This means that in these subsections we will be concerned with grammatical aspect only.

1.21 Perfective aspect

1.21.1 In English, there is **PERFECTIVE ASPECT** when the verb form used reflects the fact that the speaker wants to refer to the actualization of a situation in its entirety, i. e. that he views the situation as if it were a temporally unstructured whole. This means that he does not refer to the situation as having an internal structure (with a beginning, middle and end). For example:

I wrote an essay last night.

I will write an essay tomorrow.

In these sentences, *wrote* and *will write* convey a perfective meaning. However, we prefer not to call them ‘perfective verb forms’ (as some grammars do) because nonprogressive forms do not always express perfective meaning. Thus, *wrote* does not receive a perfective interpretation in [*They decided to write a letter. Jane dictated*] *while Mary wrote*. We will therefore refer to the form *wrote* as a ‘**NONPROGRESSIVE**’ verb form (even if its interpretation is progressive, as in the above example).

1.21.2 Perfective meaning is often defined in terms of reference to a *complete* situation. There is nothing wrong with this as long as one is aware of the fact

that *complete* is a term which applies to ‘telic’ situations only,⁹ and which does not necessarily mean the same thing as *completed* (i. e. finished). The two notions only coincide for telic situations that are completely over at the time of speech and are referred to as a whole (e. g. *He crossed the street*). In sentences like *Here comes the winner!*, *Owen races towards the goal!* or *I will write a novel*, the situations are not yet completed at the time of speech, but they are referred to in their entirety. In *At the time I was writing a novel [which was published a year later]*, it is clear that the novel-writing must have been completed at some time, otherwise the novel could not have been published; however, the situation that the speaker actually refers to with *I was writing a novel* is not a complete situation but a situation in progress – the reference is only to (some part of the) ‘middle’ of the situation (see 1.22.4).

1.22 Imperfective aspect

1.22.1 **IMPERFECTIVE ASPECT** means that the speaker uses a verb form which explicitly refers to part of the internal temporal structure of the situation, i. e. a verb form which does not refer to the complete situation, but only to its beginning, middle or end. For example:

I was writing an essay when Henry came in. (= ‘*I was in the middle of writing an essay ...*’)

There are in principle three kinds of imperfective aspect, depending on whether the speaker focuses on the beginning, the end or the middle of the situation. We speak of ‘ingressive’, ‘egressive’ and ‘progressive’ aspect, respectively. (However, as we will see, in English only progressive aspect qualifies as a grammatical category.)

1.22.2 There is **INGRESSIVE** (‘inceptive’, ‘inchoative’) aspect when the verb adopts a special form (suffix or auxiliary) which restricts the reference to the beginning of a situation, i. e. which represents the situation as just beginning. In English there is no special verb form (suffix or auxiliary) conveying this meaning. Instead, English makes use of an ‘aspectual’ lexical verb (or ‘**ASPECTUALIZER**’) such as *begin*, *start*, *commence*, which is a ‘full verb’ (i. e. a normal verb with a full conjugation rather than an auxiliary) placed before the verb phrase describing the situation (e. g. *She began to cry*). The fact that English needs such a separate aspectual verb means that we cannot speak of ‘ingressive aspect’ in English. As was stressed in section 1.20.1, grammatical aspect is a

9. As we will see in section 1.39, ‘telic’ means that the verb phrase represents a type of situation as tending towards an inherent point of completion (e. g. *run a mile*), whereas ‘atelic’ means that this is not the case (e. g. *run fast*).

pairing of a meaning and a particular form of the verb. In English the second of these two elements is lacking when ingressive meaning is expressed.

1.22.3 The same is true where the expression of ‘egressive’ meaning is concerned. There is **EGRESSIVE** (‘terminative’) aspect when the verb takes on a special form (suffix or auxiliary) which restricts the reference to the end of a situation, i. e. which makes it clear that the speaker is focusing his attention on the terminal part of the situation only. Again, English lacks such a special verb form to convey this meaning. Egressive meaning is expressed by the addition of an aspectualizer (aspectual lexical verb) such as *stop*, *finish*, *break off*, *cease*, etc. to the verb phrase describing the situation (e. g. *He finished painting the wall*).

It should be noted that these egressive aspectual verbs are not quite identical in meaning. For example, although *He finished painting the wall* refers to the actual terminal phase of painting the wall, *He stopped painting the wall* does not – in fact it ‘implicates’ that the situation of painting the wall was aborted before the completion stage was attained.¹⁰ So, terminative lexical verbs refer to the termination (= the coming to an end) of a situation but not necessarily to the completion (= finishing) of a situation. (As we will see in 1.39, a situation can be completed only if it is of the ‘telic’ kind, i. e. if it has a natural point of completion.)

1.22.4 Finally, there is **PROGRESSIVE** (‘durative’, ‘continuous’) aspect when the speaker uses a special verb form, viz. the ‘progressive form’, to express progressive meaning, i. e. to focus on the middle of the situation or on some (punctual or durative) part of the middle of the situation. In English, progressive aspect does exist, since there is a progressive form (built with *be V-ing*). For example:

10. An aspect of meaning (or rather interpretation) is an ‘**IMPLICATURE**’ (or is ‘**IMPLICATED**’) if it does not follow from the semantics of the construction or the lexical items (= words) used but rather from the context, from pragmatic knowledge of the world, or from “principles of conversation” which are conventionally observed by “cooperative” speakers and hearers (Grice 1975). For example, *Clear away the glasses!* is by implicature interpreted (and meant to be interpreted) as an instruction to clear away *all* the glasses that are relevant in a particular context. However, like all implicatures induced by conversational principles, this aspect of meaning (*the* = ‘all the’) can be cancelled. This is the case, for example, in *Clear away the glasses, except those that are not empty*, and also in *The person who cleared away the glasses overlooked those on the window-sill*. The ways in which implicatures arise have been traced by Grice (1975) to four major principles, which he calls “Maxims”. These ‘**GRICEAN MAXIMS**’ are rules of conversation which are conventionally observed by “cooperative” speakers and hearers. Grice’s Maxims have been refined in later publications, for example in Levinson (2000), which has given rise to more complicated pragmatic principles, but we have preferred not to refer to these in this book. Grice’s less refined description of the principles of conversation will do for our purposes.

I was reading a book.

Since then I've been working hard on my dissertation.

This time tomorrow I'll be flying to Morocco.

I'm still studying the case.

As is clear from these examples, it is irrelevant whether the speaker views the situation as past, pre-present (= lying in a period leading up to t_0 – see 2.35), present or future. What matters is that he presents a view of the situation as if from within the situation, that is, from within the interval during which the whole situation takes place. In other words, progressive aspect requires that the speaker assumes a 'VANTAGE TIME' from which he views the situation as in progress ('ongoing'). This vantage time may be either punctual, as in *At 7 p.m. I was still working*, or a durative interval, as in *From 2 to 4 I was reading a book*. According to the kind of tense that is used, it may vary as to its location in time:

I was reading a book. (*The situation was in progress at some past time of orientation, functioning as vantage time.*)

Since then I've been working hard on my dissertation. (*The situation, which started before the temporal zero-point t_0 , is still in progress at t_0 , which functions as vantage point.*)

This time tomorrow I'll be flying to Morocco. (*future vantage time*)

I'm still studying the case. (*t_0 functions as vantage point.*)

Since a progressive representation implies that the speaker disregards the beginning and end of the situation, the relation between the actual beginning and end of the implied full (= complete) situation and the beginning and end of the interval functioning as 'window' (vantage time) on the situation is irrelevant: the two beginnings or endpoints may or may not coincide. Thus, *From two to four I was reading a book* just expresses that the situation referred to in the clause was in progress (though possibly with minor interruptions) throughout the period indicated. My actual reading of the book may have begun at or before two o'clock and may have ceased at four or later, but none of this is relevant to the progressive interpretation of the sentence.

1.22.5 As we have seen, English verbs have no special forms to refer exclusively to the beginning or end of a situation. The only special aspectual form which (at least some) English verbs can adopt is the progressive form (*be + V-ing*). This means that in English, imperfective aspect (as defined in 1.22.1) coincides with progressive aspect, in the sense that progressive meaning is the only kind of imperfective meaning that can be expressed grammatically by a special verb form. Thus in *I was writing an essay [when Henry came in.]*, *was writing* is interpreted as 'was in the middle of writing'. However, in the same

way as a nonprogressive verb form can sometimes be used in a sentence receiving a progressive interpretation (see 1.21.1), a sentence receiving a perfective interpretation (= reference to the entire situation) may sometimes make use of a progressive verb form, as in [*Oh, there you are!*] *What have you been doing?*

1.23 Habitual aspect

1.23.1 There is **HABITUAL** aspect when the verb takes on a special form (suffix or auxiliary) to describe the situation as characteristic of the referent of the subject NP over a certain period of time. English has a special form to express habituality in the past: the semi-auxiliary *used to*. The auxiliary *would* can also express this meaning, but it can express various other meanings besides this. Both *used to* and *would* can create the idea of a past habit involving repeated actualizations of a dynamic situation, but only *used to* can refer to a past habit which does not involve dynamic subsituations:¹¹

He {*would often come / used to come*} and talk to her when he had finished working.

As a child, Edith {*used to be / *would be*} afraid of mice.

Will can be used similarly to refer to a present repetitive habit, constituting ‘characteristic behaviour’:

[This is our precious beagle Fletcher (...)] On the weekends, he *will sleep* until 11 am and he *will* actually *make* little huffing noises at us if we try to wake him up sooner. (www)

It is curious that *used to* and *will / would* (as markers of habituality) are traditionally included in the treatment of ‘modal’ auxiliaries. As far as we can see, the meaning they express is not modal but aspectual.

Can and *could* are two other auxiliaries which can express something like a habitual meaning, but they are mostly used for quite different purposes.

John *can* be very tired when he comes home from work. (= ‘It {*sometimes / often*} happens that John is very tired when he comes home.’)

When I was young, winters *could* be much colder.

1.23.2 The auxiliaries *will*, *would* and *used to* are the only fully grammaticalized expressions of habitual aspect (which is a pairing of form and meaning)

11. (Non)habitual aspect is a form of grammatical aspect because it is expressed by means of the form of the verb (viz. the use of a special auxiliary and / or suffix). Moreover, repetitive habitual aspect is a form of grammatical aspect in that it means that the speaker is concerned with the internal temporal structure of the situation: the situation is represented as consisting of several subsituations of the same kind. Nonrepetitive habitual aspect lacks this second feature.

in English. Otherwise, habitual meaning is normally expressed by a nonprogressive verb form, often in combination with a repetitive adverb like *habitually*, *usually*, *normally*, etc.:

At the time I *wasn't* yet *attracted* by girls. I simply *ignored* them.

I *don't drive* to work. I *take* the bus or *walk*.

John {habitually / mostly / usually} *skips* breakfast because he *gets up* too late.

In the latter two examples, the habit referred to is located at t_0 and is not represented as restricted in time, so that it is interpreted as a **PERMANENT HABIT**. However, a habit including t_0 can also be represented as restricted in time (i. e. as temporary) by the use of the progressive form. In that case the accompanying adverbial, if any, is a durative time adverbial rather than a repetitive one:

We *aren't eating* any beef these days because pork is exceptionally cheap.

She's *sleeping* on the veranda while this hot weather lasts.

The use of a progressive form here leads to a habituality reading of a particular kind: the situation is conceived of as repetitive and as forming a **TEMPORARY HABIT**. (This does not mean, however, that the progressive itself is a marker of habitual aspect. In the above examples, it still expresses imperfective aspect and the 'repetitive habit' interpretation arises largely via common sense reasoning and 'knowledge of the world' – for example, we know that people do not normally eat uninterruptedly for several days.)

1.23.3 A habit is a state (viz. a characteristic) which may or may not involve repetition: *I used to love that kind of music* versus *I used to go to the cinema three times a week*. Because a habit is a state, and states are 'homogeneous' (i. e. they hold at every time in the course of their existence – see 1.36), none of the instantiations of a **REPETITIVE HABIT** need actually be in progress at the time at which the habit as a whole is located. Thus, both *We take a walk after breakfast* and *We're taking a walk after breakfast these days* can be uttered (to express a habit) at any moment of the day: for these sentences to be true it is not necessary that the speaker should actually be walking at speech time. (As we will see in 3.1.1, the present tense locates the habit at the time of speech.)

1.24 Repetitive vs semelfactive aspect

1.24.1 There is **REPETITIVE** (or **ITERATIVE**) grammatical aspect when the verb takes on a special form (suffix or auxiliary) to describe a situation as repeating itself on one or more occasions or as consisting of a number of subsituations of the same kind. In English, which does not have special verb-marking for this meaning, and thus does not have formal iterative aspect, repetitive meaning

is expressed by other means, such as the use of a repetitive adverbial (e.g. *repeatedly*, *over and over*), a frequency adverbial (e.g. *sometimes*, *often*) or a plural or collective subject or complement NP accompanied by a nonprogressive tense form.

The murderer *repeatedly* coshed his victim on the head.

I *sometimes* see her off at the station.

Betty writes {*poems* / *poetry*}.

Over 1,000 people have visited the exhibition so far.

However, when the reference is to a punctual (nondurative) situation, an iterative reading can arise through the use of a progressive verb form. (Again, this does not mean that the progressive itself is a marker of iterative aspect.)

All the time I was speaking John *was nodding* assent. (*repeated movements of the head*)

Someone *was tapping* on the window.

He *was jumping up and down*.

The mechanism used here to represent a punctual situation as repeating itself is to use a form (viz. the progressive) which requires the situation to be durative. The only means of resolving the apparent contrast between punctuality and durativeness is to assume that there is a durative 'HYPERSITUATION' consisting of a number of repeated punctual 'SUBSITUATIONS'.

The same meaning of 'repetition on one occasion' can be expressed by a repetition of an intransitive verb:

He jumped and jumped and jumped.

1.24.2 The opposite of repetitive meaning is **SEMELFACTIVE** or **NONREPETITIVE** meaning. There is a semelfactive meaning when the reference is to a single individual actualization of a situation. This can either be referred to as a whole (e.g. *I had a walk last night*) or (provided it is durative) as 'ongoing' (e.g. *I was having a walk* or *I felt confused [when he said that]*).

1.24.3 The term 'iterative' is sometimes used in a narrower sense than 'repetitive'. 'Iterativeness' is then defined as the description of a situation as repeating itself on a particular occasion, i.e. the representation of a situation as consisting of the successive occurrence of several instances of identical subsituations. The sentence *Bill knocked at the front door* allows this interpretation (as well as a semelfactive one). This sense only represents one type of repetitiveness. There is a repetitive meaning not only if a situation repeats itself on the same occasion – in which case the repetition causes the instances of the situation to be 'subsituations' of a single 'hypersituation' – but also if there is repetition of the same kind of situation on different occasions (e.g. *I've only been in this town three times; I sometimes called on her when I needed help*). In this work we will apply the labels 'repetitive' and 'iterative' to both these

interpretations. It should be borne in mind, however, that it is only on the first interpretation – the situation is represented as a hypersituation consisting of similar subsituations – that the definition of grammatical aspect as the representation of the internal temporal structure of the situation referred to is satisfied.

1.24.4 As pointed out in 1.23, reference to a repetitive situation leads to the idea of ‘**REPETITIVE HABIT**’ if the repeated actualization of the situation is seen as characteristic of the referent of the subject NP over an extended period of time, as in *My sister spends her holidays at the seaside*. This shows that aspectual meanings are not mutually exclusive. This conclusion is also illustrated by *Sharon is paying her bills on time these days*, which represents the situation referred to as progressive, repetitive and forming a temporary habit. That is, the progressive form implies that the durative situation consists of repeated instances of the punctual situation of Sharon paying a bill on time. This durative overall situation is interpreted as forming a habit which is characteristic of Sharon. Due to the meaning of the progressive and the presence of *these days*, this habit is interpreted as a temporary habit.

1.25 Aspectual form vs aspectual meaning

Grammatical aspect has been defined as the use of aspectual verb forms or auxiliaries to express aspectual meanings. We have seen that English is very poor where special aspectual verb forms are concerned. The only possibilities are the progressive form (to express progressive meaning), the auxiliaries *will* and *would* (to express repetition of a situation as forming a present or past habit) and the semi-auxiliary *used to* (referring to a past habit). This does not mean, however, that the other aspectual meanings are irrelevant to English. It is simply that they have to be expressed in ways other than by the use of special suffixes or auxiliaries.

1.26 Perfect aspect?

1.26.1 Apart from the aspects referred to above, some linguistic works also speak of ‘perfect aspect’ in English. This term is introduced to capture the observation that when one of the English perfect tenses is used, the situation referred to is often viewed from a particular *perspective*, namely from the perspective of the time when a result yielded by, or the relevance of, an anterior situation expressed by the perfect form is perceptible. In this terminology, *I have had a walk* expresses perfect aspect, because it can suggest something like ‘I’m feeling rather {tired / hot / cold} now’, ‘That explains my being wet’,

etc. – present results which are not hinted at by *I had a walk*, which is therefore claimed not to express ‘perfect aspect’.

However, the concept ‘**PERFECT ASPECT**’ is suspect, for two reasons. Firstly, the ‘perspective’ referred to above is a temporal viewpoint, i.e. a ‘time of orientation’ (see section 2.14) to which the situation expressed by the verb phrase *have a walk* is anterior. The expression of anteriority to a time of orientation is a question of tense, not of aspect. Secondly, the concept ‘perfect aspect’ does not conform to our definition of aspect, because the selection of a perfect or nonperfect tense is not a question of different ways of representing the internal temporal constitution of a situation. While we admit that the present perfect implies some kind of ‘current relevance’ (see 5.35), we see no reason for treating this as a kind of aspect.

1.26.2 In some linguistic works the term ‘perfective aspect’ is used to indicate the idea of current relevance which is said to be the core meaning of what we call the ‘perfect tenses’. Similarly, nonperfect tenses (such as the preterite) are claimed to express ‘imperfective aspect’. Apart from the fact that we treat the present perfect, past perfect, future perfect and conditional perfect as tenses, not aspects (see 1.26), it should be evident that the perfective / imperfective distinction as we have defined it does not coincide with the distinction between perfect tenses and other tenses. Consider:

John has been painting his house. (The verb form is in the present perfect tense and implies the idea of a present result – John’s house is partly painted now – but it expresses progressive (imperfective) aspect: the telic situation is not referred to in its entirety: it is represented as in progress, and hence as incomplete.)

After her death we found fragments of a novel that she had been writing. (The verb form is in the past perfect tense and implies current relevance at the time of her death: the work had resulted in the existence of a partly finished novel. However, the verb form expresses progressive (imperfective) aspect: the writing of the novel is not represented as complete: she was still in the middle of writing the novel when she died.)

In short, ‘perfect’ is a category pertaining to tense, while ‘perfective’ is a category pertaining to aspect. Since tense and aspect are linguistic categories of a totally different kind, we should be careful not to confuse the terms ‘perfect’ and ‘perfective’.

C. Mood and modality

1.27 Definition of mood and modality

1.27.1 The term **MODALITY** is used to refer to a semantic category that comprises two types of meaning: the representation of the speaker’s assessment of the likelihood that a **PROPOSITION** (i.e. the content of a clause) is true (or that

the situation referred to by a proposition actualizes), and the representation of one of the factors affecting the (non)actualization of the situation referred to, such as (un)willingness, (im)possibility, (in)ability, obligation, necessity, advisability, permission, prohibition, volition, etc. Modality which has to do with the truth of the utterance is called **EPISTEMIC MODALITY**. The other type is referred to as **NONEPISTEMIC** (or **ROOT**) modality. This type comprises both modality which has to do with the speaker's attitude towards the actualization of a situation (e.g. *You must pay me back now!*), and modality which has to do with other factors affecting the (non)actualization of the situation referred to, such as the presence or absence of willingness (e.g. *I won't help you if you don't pay me*), possibility (e.g. *Aerosols can explode*) or ability (e.g. *John can swim*).

1.27.2 Modality, which has to do with meaning, should be distinguished from **MOOD**, which is a grammatical (formal) category. It refers to the systematic use of lexical verb forms not preceded by a modal auxiliary to express particular kinds of modal meaning. English has three moods, viz. the indicative, the imperative and the subjunctive. These moods reflect different ways in which a clause may function in communication.

I {left / am leaving / will leave} early. (*indicative*)

Shut up! (*imperative*)

[An athlete must have a balanced diet], *be* she resting or training. (*subjunctive*)

Apart from these moods, modality in English is especially expressed by the use of modal auxiliaries (*must, would, etc.*) and modal adverbs (*possibly, certainly, etc.*).

DEMO

IV. The precise meanings and uses of ‘situation’ and ‘actualization’

1.28 Definition of ‘situation’, ‘actualize’ and ‘actualization’

As noted in 1.5, we will use **SITUATION** as a cover term for the various possible types of contents of clauses, i. e. as a cover term for anything that can be expressed by a clause, namely an action, an event, a process or a state. Unless it is necessary to distinguish between these possibilities, we will speak of ‘the situation referred to’. The verb **ACTUALIZE** will be similarly used as a cover term for the predicates that are typically associated with one of these situation types. Thus, when it is irrelevant whether a clause refers to the performance of an action, the happening of an event, the existence of a state, etc. we can say that the clause in question refers to the actualization of a situation.

In 1.5 it has been stressed that we will use *actualize* as an intransitive verb (similar to *happen*). Thus, we will say that *John is painting his house* expresses that the situation of John painting his house ‘is actualizing’ (rather than that the situation ‘is being actualized’).

1.29 Situation: meaning (denotation) versus reference

1.29.1 To explain the notions ‘denotation’ and ‘reference’ with respect to the verb and the verb phrase, we will start by drawing an analogy with nouns and noun phrases.

A noun like *boy* has a lexical meaning. The paraphrase ‘young male human being’ is an attempt at describing this. The noun can be used as the head of a noun phrase (e.g. the noun *boy* is the head of the noun phrase *the boy*). Such a noun phrase has both a meaning and (if it is used in an utterance) a referent. The meaning (or **DENOTATION**) of the noun phrase results from a combination of the lexical meaning of *boy* and the grammatical meaning of the definiteness marker *the*. The **REFERENT** (which comes into the picture only when the NP is used in a spoken or written utterance) is a particular boy who the ‘utterer’ (speaker or writer) assumes the addressee (hearer or reader) can identify on ‘receiving’ (hearing or reading) the noun phrase *the boy*.

In a similar way, a verb like *walk* has a denotation (lexical meaning). This denotation can be called a **SIMPLE SITUATION-TEMPLATE** because by combining other constituents (minimally a subject) with the verb we can build a clause denoting a situation, as in *John walked* or *John walked to the church*. A ‘simple situation-template’ (denoted by a verb) can be turned into an **ENRICHED SITUATION-TEMPLATE** by the addition of one or more complements or adverbials to the verb. Multi-word predicate constituents like *walk to the church* or *walk*

to the church at five p.m. yesterday denote a situation-template which contains more information than the simple situation-template denoted by *walk*. The denotation of such a complex predicate constituent is determined in the first instance by the meanings of the verb and of the other components of the predicate constituent (as defined in 1.7) and the semantic relations between them.

If a verb, VP or predicate constituent is uttered, it has a referent, which is an **ABSTRACT SITUATION TYPE**. By 'abstract' we mean that there is no reference to an actualizing situation: an abstract situation type is a mental construct, a type of situation as it is conceptualized by the speaker without reference to any concrete actualization. Thus, *run slowly*, *be tall*, *increase*, etc. refer to different abstract situation types.

1.29.2 A clause is a combination of a subject NP and a predicate constituent which minimally contains a VP (verb phrase).¹² The denotation of a clause is a situation. When the clause is uttered, it is used to refer to something. (A referent of a linguistic expression is something whose existence in the / an extralinguistic world is asserted or questioned.) The referent of the clause is then the actualization of the situation in question.¹³

1.29.3 What has been said so far is summarized in the following chart:

<i>linguistic expression</i>	<i>denotation of the linguistic expression</i>	<i>referent of the linguistic expression when uttered</i>
verb (e. g. <i>walk</i>)	simple situation-template	abstract type of situation
verb phrase (e. g. <i>walk to the church</i>)	enriched situation-template	abstract type of situation
predicate constituent (e. g. <i>walk to the church merrily on Sundays</i>)	further enriched situation-template	abstract type of situation
clause (e. g. <i>On Sundays they walk to the church merrily.</i>)	situation	actualization of the situation

12. As noted in 1.7, we analyse a prototypical clause as consisting of a subject NP and a predicate constituent. The latter consists of the verb phrase (VP) and the optional adverbial(s), if any. The VP consists of the verb form (= verb + auxiliaries, if any) + the complements (= direct object, indirect object, subject complement, object complement, prepositional object (= object of a prepositional verb) + necessary adverbial(s), if any). Thus in *John put the book on the table this morning*, the subject NP is *John*, the VP is *put the book on the table*, and the predicate constituent is *put the book on the table this morning*.

13. Some nonfinite clauses do not have a referent, e. g. the infinitive clause in *For John to do that is unthinkable*. Other nonfinite clauses do have a referent (because they assert actualization), e. g. the participle clause in *Jumping over the fence, I hurt my ankle*. As this is not the place to go into the question under what conditions a nonfinite clause has a referent, we will only consider finite (tensed) clauses in this section. Imperatives too will be disregarded.

1.29.4 In this section the above distinctions are further illustrated. Informally, we can say that the clause *A stranger accosted me yesterday* ‘describes an action’. However, we can also say that the VP *accosted me* ‘describes an action’, and that the verb *accost* ‘describes an action’. In order to speak precisely we need the distinctions made in the previous section:

- (a) The verb *accost* **denotes** a **simple situation-template**. In isolation, the verb **refers to** an abstract (i.e. mentally conceived but not actualizing) situation type.
- (b) The untensed verb phrase *accost me* **denotes** an **enriched situation-template**. This enriched template represents one possibility allowed for by the simple template: accosting me is a semantic subtype of accosting. The untensed predicate constituent *accost me yesterday* denotes an even more enriched situation-template. In isolation, a predicate constituent does not **refer to** actualization: like the verb *accost*, the predicate *accost me yesterday* does not by itself refer to an instance of actualization. The **referent** of a predicate constituent is an abstract situation type.
- (c) The finite (tensed) clause *A stranger accosted me yesterday* **denotes** a **situation**. We can think of this denotation (i.e. the semantic meaning of the clause) as something which is computed from the combination of the denotations of the predicate constituent *accosted me yesterday* and the subject. When the clause is uttered, it has a referent: it **refers to** a particular **actualization** of the situation.

It is worth noting that a clause does not always have a referent in the actual (real) world: it can also refer to (i.e. assert, deny, question or hypothesize) actualization in a nonfactual world, such as a future or counterfactual world. Thus, the conditional clause *If John had written a poem last night ...* makes a supposition about the actualization of a situation (viz. the situation of John writing a poem) in a counterfactual world.

1.30 Terminological conventions for speaking about situations

1.30.1 The above distinctions are important, and we really need to make them if it is to be clear what exactly we are talking about. However, it is virtually impossible to do full justice to them in a linguistic text and maintain readability. This is not unusual in linguistics. The following example should make this clear in connection with another concept. In a discussion about the meaning of the past tense in a sentence like *John wrote a poem last night* the following formulation is perfectly correct, but too cumbersome to be used repeatedly:

The past tense locates the time of actualization of the situation referred to at a specific past time (specified by *last night*.)

This is normally simplified to one of the following:

The past tense locates the time of the situation referred to at a specific past time (specified by *last night*.)

The past tense locates the situation referred to at a specific past time (specified by *last night*.)

In a similar way, some of the terms introduced in this chapter will often be used in a 'sloppy' way in this work. However, this sloppy use is by no means arbitrary. It observes the following conventions:

(a) *Using the term verb phrase (VP)*

Strictly speaking, a verb phrase is a phrase (group of words) with a verb as head. Thus, the clause *John presumably left the house* contains the VP *left the house*. (Together with the adverb *presumably*, the VP forms the 'predicate constituent', i.e. that part of the clause that is not the subject – see section 1.7.) However, in *John presumably left*, the VP contains no lexical material besides the verb *left*. This form does not consist of a group of words (= a phrase), but for simplicity it is normally treated as 'the VP of the sentence'. Similarly, in *John left*, the predicate constituent only consists of *left*. In this case the verb form *left* constitutes not only the VP but also the predicate constituent of the sentence.

When using the term 'verb phrase' we will not normally need to distinguish between one-word VPs and multi-word VPs. So we will generally use the term *verb phrase* to cover both possibilities.

(b) *Using the term situation-template*

In a similar way, there are not many contexts in which it is necessary to distinguish carefully between a 'simple situation-template' (expressed by a verb) and an 'enriched situation-template' (expressed by a VP or a longer predicate constituent). So we will use 'situation-template' to cover the two possibilities.

(c) *Using the terms situation and refer to*

Strictly speaking, a verb phrase denotes a situation-template and (if uttered) refers to an abstract type of situation, whereas a finite clause denotes a situation and (if uttered) refers to the actualization of that situation. However, for convenience we will generally use the terms 'situation' and 'refer to' in a simplified sense. Thus, we will often use 'situation' as an abbreviation of 'actualization of the situation denoted'. In this sense we can speak of 'the situation referred to by a clause'. (As noted in 1.29.2, the referent of a finite clause is

not really a situation but one or more actualizations of a situation. However, it is seldom necessary to make this distinction explicitly.)

In addition, there will be many contexts in which we will use ‘situation’ in the sense of ‘situation-template’. It was argued in 1.29.1 above that verb phrases denote situation-templates rather than situations: whereas *John walked home* refers to (the actualization of) a situation, *walk* denotes a situation-template: it is the simple template underlying more enriched situation-templates like *walk home*, *walk home slowly*, *walk with a limp*, etc. However, in what follows we will sometimes simplify this (as long as no misunderstanding is possible) and speak of the VP (or verb) denoting situations or even referring to situations. This sloppy use of ‘situation’ and ‘referring’ will also be made in connection with nonfinite clauses that do not refer to actualization but denote a kind of situation, such as the subject clauses of *Betraying one’s friends is unforgivable* and *For John to betray his friends is unthinkable*. Strictly speaking, such nonfinite clauses denote an enriched situation-template and refer to a situation type rather than to the concrete actualization of a situation. However, it is handy if we can speak of ‘the situation referred to by *For John to betray his friends*’.

In sum, while the finer distinctions reflected by the more complex terminology are essential, we will use simplified formulations when it is not really necessary to use the more correct but more complex and cumbersome formulations.

1.30.2 In conclusion, verb phrases can only denote rather abstract schemata for situations, which we call ‘situation-templates’, and, if uttered, refer to abstract situation types, whereas clauses denote situations and, when they are finite and used in an utterance, refer to particular actualizations of situations. That is, *walk* and *walk to the church* each denote a schematic sort of situation, which has particular semantic characteristics so that it can be classified, for example, in Vendlerian terms (see 1.43 below) as an ‘activity’ in the first case and an ‘accomplishment’ in the second case. But both lack some information (such as a subject and a tense) necessary to denote a situation proper, and consequently neither can be used to refer to any particular instance of actualization, whereas *John walked to the church*, having a location in time and a subject, denotes a complete situation and can be used to refer to an actualizing situation. However, we will follow common practice in talking of ‘situations’ where ‘situation-templates’ or ‘situation types’ would be more appropriate, and ‘reference’ where ‘denotation’ would be more correct, so that we will talk of both clauses and verb phrases as ‘referring to situations’. For example, we will say that *walk to the church* ‘refers to a telic situation’, even though VPs cannot denote situations, still less refer to actualizations of situations.

1.31 Terminology used to refer to situation types and verb classes

1.31.1 Situations can, for some purposes, be grouped according to the way in which the situation unfolds in time, its internal constitution – does it consist of one unchanging state, for example, or does it consist of various different phases? – and certain other criteria that have to do with beginnings, middles and ends of situations. The point of grouping situations in this way is that this enables us to make interesting linguistic generalizations, as will become clear as this and the following chapters proceed. Two common classifications of sorts of situations (i. e. situation types) will be discussed in detail in 1.42 and 1.43 below. For the moment, we are concerned with the terminology we need to make the distinctions underlying these classifications.

We often find in the literature such terms as 'PUNCTUAL SITUATION' to describe a situation which is perceived as having no duration (i. e. as taking up just a point in time) – for example the situation represented by *Jill jumped* or *Norbert knocked*. Similar terms are 'STATIC SITUATION' (which refers to a situation that is perceived as being a state, such as the situation represented by *Jill was ill*) and 'DURATIVE SITUATION' (which refers to a situation that is perceived as having a certain duration, such as the situation represented by *Jill walked*). Another grouping is that of 'HOMOGENEOUS' situations', like that referred to by *Jill was in Jutland*. This sentence represents a situation which is felt to be completely uniform, so that any moment of Jill's being in Jutland is just like any other moment of her being in Jutland. NONHOMOGENEOUS situations are, naturally enough, referred to as 'HETEROGENEOUS' situations'. An example of such a situation is that represented (≠ referred to) by *Jill planted a juniper bush*, in which we discern various phases rather than an unchanging state. (Roughly speaking, we expect that Jill will be doing different things at different moments of planting the bush.)

As well as applying such labels to situations (and to the clauses denoting them), the literature also applies these labels to the verbs or verb phrases which typically refer to a particular group of situations. We read of 'punctual verbs', 'durative verbs', etc., by which is meant 'verbs that typically refer to punctual situations', 'verbs that typically refer to durative situations' and so on. However, the literature is not completely consistent. Thus, next to the somewhat opaque term 'punctual verb', we find the more accurate and transparent term 'transitional event verb' (sometimes 'change of state verb'), used to refer to verbs which always or typically refer to situations which constitute a transition from one state into another – for example, *die* or *burst*. In what follows, when we wish to refer to a category of verbs that are associated with a particular sort of situation, we will speak of 'punctual situation verbs', 'durative situation verbs' and so on, following the pattern of 'transitional event verb' (which,

however, we shall adapt to ‘transitional situation verb’, since not all situations that constitute a transition from one state to another are events, in our terms).¹⁴ This move is intended to arrive at a more consistent nomenclature, and to provide a pattern on which new terms that we will need to introduce can be modelled in such a way that their meaning is as transparent as possible: the term ‘heterogeneous situation verb’ should, we hope, be transparent in a way that ‘heterogeneous verb’ might not be. Of course, in some cases, the meaning of ‘situation’ is contained inside another term, notably in the case of ‘state’, ‘event’, ‘action’ and ‘process’ (see 1.42 below). This means that next to category names like ‘punctual situation verb’ we will also be using such terms as ‘state verbs’, ‘event verbs’, and so on.

1.31.2 It should also be borne in mind that when people speak about ‘situation’ they often mean ‘representation of a situation (by a clause)’. This may create confusion, because one and the same real-world situation can sometimes be represented in different ways. Thus, *John drank beer* and *John drank a glass of beer* can both be uttered with reference to the same (actualization of the) situation, but *John drank beer* represents the situation as ‘atelic’ and ‘homogeneous’, whereas *John drank a glass of beer* represents it as ‘telic’ and ‘heterogeneous’.¹⁵ This means that it is not the situations themselves that are (a)telic or (non)homogeneous, but the situations as they are denoted by clauses. A similar example is the use of ‘punctual’. Though we normally speak of ‘punctual situations’ (i. e. situations that are perceived as lasting no longer than a moment), it is sometimes the representation rather than the situation itself that is punctual. Thus, the same real-world action can be described using *yank* or *pull*. In the former case, a punctual situation verb is used, and the situation is represented as punctual; in the latter case, a durative situation verb is used, and the situation is represented as taking place over (perhaps a very short) time. Thus, if the VP is made progressive (*The girl behind her was {yanking / pulling} her braids*), we get a repetitive meaning in the case of *yank*: the situation is represented as consisting of several sharp movements; in the case of *pull*, the situation representation is vague between repetitive and continuous, but, because *pull* represents a situation as nonpunctual, it is at least possible to get a representation of one continuous movement, an interpretation which is not possible with *yank*, e. g. *The girl behind her was leaning back as far as*

14. For example, according to the terminology introduced in section 1.42.3 below, the verb *stop* as used in *The man stopped to light a cigarette* does not refer to an ‘event’ but to an ‘action’.

15. As we will see in section 1.39, ‘telic’ means that the situation is represented as tending towards an inherent point of completion, whereas ‘atelic’ means that it is not. ‘Homogeneous’ means that the same linguistic expression can be used to represent the situation as a whole as well as to represent parts of it. ‘Heterogeneous’ means ‘nonhomogeneous’.

she could and {yanking / pulling} her braids in an attempt to drag her out of the quagmire.

However, it would clearly complicate our terminology too much if it systematically reminded the hearer of the fact that we are talking about the representation of a situation rather than about the situation itself. 'Punctual situation' and 'punctual situation verb' are terms that are both transparent and not too complex. Substituting 'punctual situation-representation' and 'punctual situation-representation verb' for them would reduce the readability of the text. (Replacing the simplified term 'punctual situation verb' by the quite correct 'verb denoting a simple template for a punctual situation' would have an even worse effect.) We will therefore neglect the distinction between 'situation' and 'situation-representation' as long as there is no particular reason to pay attention to it.

1.32 Situation types

1.32.1 As noted in 1.29.1, any verb or verb phrase denotes a situation-template. The nature of the template is determined by the lexical contents of the verb (phrase) in question. For example, *know* represents the situation referred to as having the features [+ static], [- agentive], [+ homogeneous], [- transitional], [+ durative], [- telic] and [- evolving] – see sections 1.34–40 below.¹⁶ These various features are inherent in the lexical meaning (lexical semantics) of the verb *know* and form part of a mode of categorization which in the linguistic literature is known as 'Aktionsart', 'lexical aspect', or 'ontological aspect'. This category will be examined in detail in sections 1.33–40. (At this point we are only concerned with the terminological implications of such distinctions.)

Because the above features are inherent in the lexical meaning of the verb *know*, they are present in any predicate constituent using *know* as head of its verb phrase. The features are therefore typical, not only of the simple situation-template of the verb *know* but also of all more enriched situation-templates using this verb (i. e. VPs and more complex predicate constituents). Moreover, features such as [\pm static], [\pm agentive], [\pm homogeneous], [\pm transitional], [\pm durative], [\pm telic], etc.¹⁷ can also be applied to what situation-templates refer to, viz. situation types. In fact, since 'situation' is often used sloppily to

16. There is a certain hierarchy in this list of features. For example, [+ static] automatically entails all the other features mentioned. However, this observation is not important at this point of the discussion.

17. The meaning of the \pm sign is not 'more or less' but 'either + or -', i. e. the feature may or may not be present.

talk about an abstract situation type, people often talk of ‘static situations’ rather than ‘static situation-templates’ or ‘static situation types’.

1.32.2 In the linguistic literature the term ‘situation type’ is often used in a sense different from ‘abstract type of situation’, viz. to refer to types of actualizing situations as they are denoted by clauses. For example, Lyons’ (1977) categorization of situation types into states, actions, processes (= developments) and events – see 1.42 below – is often applied to actualizing situations on the plea that the nature of a category can be determined by any constituent of the clause, including the subject. Thus, depending on the nature of the subject referent, which may be [+ human] or [– human], the actualizing situation referred to by a clause using *break* is said to be either an ‘action’ (i. e. a dynamic situation whose actualization is caused by a consciously acting agent, as in *John broke the window*) or an ‘event’ (i. e. a dynamic situation which simply happens, without there being an identifiable agent, as in *The key broke in the lock*).

In order to avoid any confusion it would be advisable to apply the label ‘type of situation’ to the referent of a verb, verb phrase or predicate constituent only. In other words, it would be ideal if ‘type of situation’ were short for ‘abstract type of situation’. The term ‘type of actualizing situation’ could then be applied to the referent of a full clause. However, this distinction is often ignored in the literature.

1.32.3 In what follows we will examine the features and typology that can be discerned within each of these sets of types.

DEEMO

V. Abstract situation types: ontological aspect

1.33 Introduction

1.33.1 In order to understand the meaning and use of certain tenses and of (non)progressive forms, it is necessary to classify templates for describing situations on the basis of whether or not they represent the situation as having particular ontological features, such as ‘static’, ‘durative’, etc.¹⁸ The set of features that are attributed to a situation by the verb phrase representing it are said to constitute a kind of ‘aspect’, i. e. a particular way of representing a situation in terms of its internal constituency. This kind of aspect is known as **AKTIONSART**, **LEXICAL ASPECT** or **ONTOLOGICAL ASPECT**. It is the expression of inherent characteristics, such as (non)staticness, (non)durativeness, etc., of a kind of situation as it is linguistically represented by a verb phrase that has not yet been marked for progressive or nonprogressive aspect. (By ‘inherent’ we mean that the kind of situation necessarily has the features in question, irrespective of the context in which it is used.) The proviso in connection with (non)progressive aspect is necessary because, as we will see in 1.49, grammatical aspect may sometimes overrule the ontological aspect of the unmarked verb phrase. Thus, while walking is typically conceived of as dynamic, the sentence *John walks to work* is interpreted as referring to a state (more specifically, a habit, i. e. a type of situation that is characteristic of the referent of the subject NP over an extended period of time – see 1.23). This static interpretation is due to the use of the nonprogressive form of the present tense: the corresponding progressive sentence *John is walking to work* denotes a dynamic situation.

1.33.2 Some of the lexical-aspect features of a verb, VP or predicate constituent are purely a question of representation (e. g. the feature ‘slow movement’ in *walk slowly*), whereas others are more closely linked to the ontological status of the situation type in the real world. The latter possibility is illustrated by the verb *drive* (when used as a one-word verb phrase), which can only be the linguistic representation of a situation having the features [– static], [+ agentive], [+ homogeneous], [– transitional], [+ durative], [– telic]. (We will examine each of these features below.) Similarly, the situation type referred to by *hit the target* is inherently dynamic (nonstatic), punctual (nondurative) and noniterative; *write a book* represents a kind of situation as necessarily dynamic, durative, nonhomogeneous (= consisting of phases of a different kind) and telic (= tending towards a necessary point of completion – see 1.39 below); *be a man* refers to a type of situation that is inherently static, durative, homo-

18. An ontology is a philosophical theory of what there is in the world, i. e. of the fundamental nature of reality.

geneous (= unchanging throughout its duration) and atelic (= not telic). However, the features [\pm telic] and [\pm homogeneous] are a mere question of linguistic representation, since the verb phrases *drink*, *drink gin* and *drink a glass of gin* can in principle all be used in sentences describing one and the same real-world actualization of a situation. Thus, if John claims to be a teetotaler but I saw him drink a glass of gin last night, I can report what I saw him do by means of *John drank last night!*, *John drank gin last night!* or *John drank a glass of gin last night!*. (The former two sentences represent the situation as atelic (= not tending towards a necessary point of completion – see 1.39.1) and homogeneous, the third represents it as telic and nonhomogeneous.)

1.33.3 Not all the inherent characteristics of the representation of a type of situation are included in the category of ontological aspect. Swimming is only possible in water (or another liquid), but we will not consider the feature [\pm in liquid] as one of our ontological features. Neither will we distinguish a feature referring to the number of participants in the situation, though that number is essential to some types of situation, such as playing bridge. The inherent characteristics of (the representation of) a kind of situation that we include in our category of ontological aspect are those that are grammatically relevant. For example, the features [\pm dynamic] and [\pm agentive] help to determine the possibility of using the verb phrase in the progressive form. The distinction [\pm telic] is relevant to the use of temporal adverbials – compare *I walked a mile {in / *for} one hour* with *I walked {*in / for} one hour*. But features like [+ in liquid] or [+ four participants] do not have any linguistic relevance (at least in English) and are therefore not included in our set of (grammatically relevant) ontological features. Neither is the feature [\pm iterative], which is a true ontological feature but will be disregarded because it is not grammatically relevant, i. e. it does not determine any grammatical rule or distinction. (An **ITERATIVE VERB** is one which represents a kind of situation as consisting of a rapid repetition of subsituations of the same kind, such as *hammer*, *twinkle*, *stutter*, *rattle*, *stammer*, etc. While *draw* is a noniterative verb, *doodle* is an iterative one.) Note that when we say that the feature [\pm iterative] is not grammatically relevant, because it does not determine any grammatical rule or distinction, we are referring to the ontological feature [\pm iterative], not to iterative grammatical aspect – see 1.24 – nor to the fact that clauses may get an iterative reading as a result of grammatical combinations, such as the combination of punctual Aktionsart with progressive aspect, as in *John was kicking the ball*.

1.33.4 In the next sections we will discuss the various ontological features that determine lexical aspect in English. In doing so we will point out that some of the features can be applied not only to the verb, VP or predicate, but also to clauses and to situations represented by clauses.

1.34 Ontological feature 1: ‘static’ versus ‘dynamic’

1.34.1 A **STATIC SITUATION** (or **STATE**) is a situation which is conceived of (and represented) as existing (rather than as being done, taking place or developing) and as being unchanging and hence homogeneous throughout its duration. A static kind of situation is not agentive (i. e. when there is actualization, it is not performed or instigated by an agent – see section 1.35 below) and is not conceived of as needing an input of energy to continue. Situations that are not static are called **NONSTATIC** or **DYNAMIC** situations. Such a situation may be punctual (momentary) or durative. A durative dynamic situation is conceptualized as consisting of a number of stages (‘slices’), each of which is considered as being slightly different from the previous stage. (Thus, a situation of walking consists of stages which are slightly different because the walker is constantly changing the position of his body and moving forward.) This means that durative dynamic situations involve change and therefore as a rule require a continuous input of fresh energy in order to continue. Punctual dynamic situations too require an input of energy to actualize. For example:

Bill was a rich man. (*static*)

John is walking. (*dynamic and durative*) (*The situation requires a continuous input of energy and is conceived of as made up of a number of temporal stages which are similar to each other.*)

Bill will reach the top in a minute. (*dynamic and punctual*) (*The situation requires an input of energy in order to actualize.*)

1.34.2 The labels ‘static’ and ‘dynamic’ are ontological features. They do not directly refer to actualization and are therefore, strictly speaking, not applicable to situations or clauses. As explained before, they distinguish between two kinds of ‘situation-template’. However, for the sake of convenience, we will extend the use of ‘static’ and ‘dynamic’, so that they apply to the following three cases. Firstly, the labels will be applied to the verb phrases lexicalizing the situation templates in question. Thus, *is a boy* will be said to be a ‘static verb phrase’, while *walk a mile* is a dynamic one. Secondly, ‘static’ and ‘non-static’ will also be applied to the abstract situation type referred to. Thus, Kim’s being a boy is a ‘static situation’, or a ‘state’. Thirdly, the terms will also be applied to the clauses and sentences used to refer to a concrete actualization of a situation type. Thus, *Kim is a boy* can be called a ‘static situation sentence’.

1.34.3 Certain verbs can only be used to refer to a state. We refer to them as **STATIC SITUATION VERBS** or **STATE VERBS**. (Some people speak of **VERBS OF STATE**.) Examples of static situation verbs are: *seem, contain, know, consist of*. The verb *be* can be used both in a static and in a dynamic way, depending on

whether the situation which it helps to describe is agentive or not (see section 1.35 for a definition of ‘agentive’). For example, *be tall* refers to a state, while *be careful* can refer either to a state, as in *You can rely on him, he’s careful*, or to an action (which is by definition agentive and therefore nonstatic), as in *I’m being careful this time*, which is interpreted something like ‘This time I’m taking the necessary precautions’. In this agentive meaning, *be careful* is a **DYNAMIC VERB PHRASE**.

1.34.4 One special type of state is the type that we refer to as ‘habitual’. A **HABIT** is a situation that typically involves repetition and is characteristic of the referent of the subject for an extended period of time. Since a characteristic is by definition a state, habits belong to the ontological class of static situations. We call a habit **TEMPORARY** if the period during which the characteristic exists is explicitly represented as restricted (as in *He has not played well recently*); otherwise we speak of a **PERMANENT HABIT**, even when there are pragmatic restrictions on the duration of the habit, as when we are ascribing the habit to a particular person. (Thus, *John walks to work* expresses a permanent habit, even though this habit is pragmatically restricted to that part of John’s lifetime during which he works. By contrast, *John is walking to work these days* represents the habit as temporary.)

John is difficult to speak to these days. (*temporary habit*)

We are eating in the kitchen [while the living room is being redecorated]. (*temporary habit*)

William is afraid of the dark. (*permanent habit*)

John walks to work, but Bill takes the bus. (*permanent habits*)

There are two things that need stressing here. Firstly, contrary to what is sometimes written in the linguistic literature, a habit is not a characteristic of a period of time; it is a characteristic of the referent of the subject which lasts for a more or less extended period of time. Secondly, the observation that a habit typically involves repetition does not mean that the subsituations referred to or implied have to be dynamic. Sentences like *William is afraid of the dark* and *Andy is our centre forward* do not imply anything dynamic, but what distinguishes them from nonhabitual sentences like *William is tall* or *My mother is dead* is that they have a sense of repetition – in fact, typical behaviour – which the latter do not have. The sense of repetition concerns an unlimited set of occasions: whenever William is confronted with the dark, he is afraid. Similarly, *Andy is our centre forward* implies a set of relevant occasions (games) on which the question of his position in the team is relevant. By contrast, *William is tall* and *My mother is dead* simply refer to a permanent characteristic, without evoking a number of instantiations on relevant occasions. In this case there is no idea of typical behaviour. It is in keeping with this that

William used to be afraid of the dark and *Andy used to be our centre forward* are quite acceptable, whereas *William used to be tall* and *My mother used to be dead* are not – at least not in the world as we know it. (As we saw in 1.23, *used to* is a grammatical marker of past habituality.)

The use of ‘habit’ to refer to an instantiated characteristic without dynamic subsituations (as in *William is afraid of the dark*) runs counter to the everyday use of the word. Phrases like *have the habit of* or *be in the habit of* can only be followed by a complement clause referring to a repetitive situation consisting of a number of dynamic subsituations. Still, the term ‘habitual’ is quite common to express what the four above examples have in common. Since there does not appear to exist a better cover term, it seems best to follow the existing convention, even though it may seem rather counterintuitive when there are no dynamic subsituations involved.

1.35 Ontological feature 2: ‘agentive’ versus ‘nonagentive’

1.35.1 A situation is **AGENTIVE** if any actualization of it is caused (i.e. performed or instigated) by an agent. The **AGENT** is the entity that is responsible for the actualization of the situation, in the sense that it actually does something that induces the situation to actualize. The following examples refer to instances of actualization of an agentive situation:

John hit Bill on the nose.

She’s walking home now.

An agent is typically animate, especially human. However, as speakers, we also routinely attribute agentivity to nonhuman animate beings and sometimes even to inanimate entities:

Our dog bit the postman and *the Post Office* is suing us.

The computer virus destroyed all our files and sent copies of itself to everyone on our mailing list.

1.35.2 As already noted, a state is by definition nonagentive. Thus, *Bill is an old man* does not imply that Bill does something in order to achieve the effect of being an old man. Events (i.e. dynamic situations that simply happen without implying a performer or instigator) and processes (i.e. dynamic situations that are developments) are also nonagentive:

A stone came loose from the slope and fell down. (*events*)

The accident happened around midnight. (*event*)

This species of fungus is in danger of dying out. (*process*)

The door was opening slowly. (*process*)

By contrast, actions are by definition agentive:

Bill was opening the door.

Unwittingly, Jimmy {*killed / was killing*} the goose that laid the golden eggs.

1.35.3 Linguists often include the feature ‘**INTENTIONALITY**’ – i. e. the idea that an action is performed {consciously / volitionally / deliberately / intentionally} – in their definition of agentivity. Thus, the *Routledge Dictionary of Language and Linguistics* (Busmann 1996: 11) defines ‘agent’ as the “semantic role (thematic relation) of the *volitional* initiator or causer of an action” (our emphasis), and Brinton (2000: 279) writes: “These sentences [e. g. *Orlando cooled the water, Orlando made the water cool, Orlando caused the water to become cool*] are **AGENTIVE**, involving a human agent who *intentionally* brings about a change in state in an entity” (our italics).

However, this definition of agentivity as involving intentionality may cause a problem. We have argued that agentivity is the main feature distinguishing actions (which are performed) from states (which just hold), and events (which just happen) and processes (which develop). If intentionality is part of agentivity (and agentivity is criterial to actions), we are not able to talk about unintentional actions. But it would appear that actions can be unintentional: you can do something accidentally, or under the influence of drugs, hypnosis, etc. This distinction between intentional and unintentional actions might seem linguistically irrelevant, but this is not always the case. In combination with adverbs like *always, forever, constantly, continuously*, etc. a repetitive habit can be linguistically represented as consisting of actions that are either deliberate or nonintentional. Compare:

Jim always says something disturbing and spoils the fun.

Jim is always saying something disturbing and spoiling the fun.

For most speakers, at least, *spoils the fun* can only refer to an intentional action, while *is spoiling the fun* can be interpreted as representing the action as unintentional and non-agent-controlled, i. e. as an ‘**INCURABLE HABIT**’. This is a habit – a state seen as characteristic of Jim – which consists of a repetition of a kind of action which Jim perhaps cannot help performing: he does not necessarily intend to spoil the fun but inevitably does so because of the disturbing nature of his utterances (which are determined by his character rather than by his volition).

On the other hand, it is clear that the default case is for an action to be both agentive and intentional. Intentionality is a strong implicature of agentivity: failing an indication to the contrary, agentive situations will be taken to be deliberate. It is therefore unnecessary to add [\pm intentional] as a separate feature to the list of relevant ontological features that help to distinguish between the major situation types. In general, [+ intentional] can be taken to follow from [+ agentive], unless there is an indication to the contrary.

1.36 Ontological feature 3: ‘homogeneous’ versus ‘heterogeneous’

1.36.1 A durative situation is conceived of as **HOMOGENEOUS** if it is conceived of as consisting of parts which are all of the same kind as the situation as a whole. Otherwise it is **NONHOMOGENEOUS** (or **HETEROGENEOUS**). The distinction is not applicable to punctual situations.

1.36.2 There are two types of **HOMOGENEOUS SITUATIONS**. Firstly, any static situation is homogeneous because a state by definition remains unchanged throughout its duration. Secondly, a dynamic situation is homogeneous if it is conceptualized as consisting of a number of stages (‘slices’) which are subsituations of the same kind as the situation as a whole. In this case it is possible that a concrete actualization of the situation type involves one or more intermissions or accidental gaps, but this does not alter our fundamental way of conceptualizing the situation as a homogeneous situation. (Thus the following examples refer to the actualization of a homogeneous situation:

Bill is a reliable worker. (*static, hence homogeneous*)

John roamed the streets last night. (*dynamic, homogeneous*)

Helen practised her stilt-walking in the wood this morning. (*dynamic, homogeneous*)

The latter sentence is not false if Helen occasionally stopped to have a rest or to have a talk with someone she met. Failing an indication to the contrary, practising one’s stilt-walking is conceptualized as a homogeneous situation. Possible intermissions are disregarded because they do not affect the essential nature of the kind of situation.

1.36.3 An example of a **HETEROGENEOUS SITUATION** is drawing a circle. There is no portion (stage, slice) of the situation of drawing a circle that is itself an instance of drawing a circle. (Every portion is an instance of drawing *part of* a circle, which is a different situation type from drawing a complete circle.)

As a further illustration, consider the following:

John drank beer. (*homogeneous*)

John drank five glasses of beer. (*heterogeneous*)

It is characteristic of a homogeneous predicate constituent that it can denote not only the ‘situation-template’ (see 1.29.1) for a situation as a whole but also the template for relevant portions of that situation. (Portions consisting of, or including, intermissions or accidental gaps are not relevant.) Thus, if *John drank beer* is a correct representation of what John did from 2 to 4, it is also a correct representation of what he did from 2 to 3, or from 2.30 to 3.30, etc. However, if *John drank five glasses of beer* is a correct representation of what

John did from 2 to 4, it cannot also be a correct representation of what he did between 2 and 3, or between 2.30 and 3.30, etc. Unlike *drank beer*, the verb phrase *drank five glasses of beer* therefore denotes a heterogeneous situation-template.

1.36.4 In the above paragraphs we have attributed the ontological feature $[\pm \text{homogeneous}]$ to situation-templates denoted by verbs, verb phrases or longer predicate constituents. However, for ease of reference we will also apply the term to situation types and sentences. Thus, *drink beer* will be said to refer to a ‘**HOMOGENEOUS (TYPE OF) SITUATION**’ and *John drank beer*, which refers to an actualization of a homogeneous situation, will be called a ‘**HOMOGENEOUS SENTENCE**’.

In 1.48.1 it will be noted, though, that the (non)homogeneous nature of a situation as denoted by a sentence need not always be due to the $[\pm \text{homogeneous}]$ nature of the situation-template. It may also be due to the quantificational status of the subject NP, to the use of the progressive form (which expresses a kind of ‘grammatical aspect’), or to another ontological-aspectual meaning without formal expression, such as progressive meaning without progressive marker or habitual meaning coming from outside the predicate constituent. In all these cases (non)homogeneity is not a question of the lexical aspect expressed by the verb, VP or more complex predicate constituent. For example, while *Water ran out of the cistern* denotes a situation which is conceived of (and represented) as homogeneous, *Three litres of water ran out of the cistern* denotes a heterogeneous situation: no part of this situation can be described by the same sentence. Similarly, while *John wrote a book* is heterogeneous, *John was writing a book* is homogeneous: the sentence can be used to refer to (the actualization of) a situation as well as to any (relevant) part of that situation. And in *Every evening, I would have a glass of port while Sylvia drank a glass of beer*, the second clause has a habitual, and thus homogeneous reading. In sum, the feature $[\pm \text{homogeneous}]$ is not only an ontological characteristic of particular situation-templates (denoted by verbs, verb phrases or predicate constituents) and of the situation types they refer to. It is also a feature characterizing entire clauses, because the source of the (non)homogeneity can be found in the quantificational status of the subject or in the presence or absence of the progressive form or of a formally unmarked progressive or habitual reading.

While (non)homogeneity induced by the nature of the subject can probably still be treated as a question of lexical aspect, (non)homogeneity induced by the use of a (non)progressive form is definitely a question of ‘grammatical aspect’, not lexical aspect. The use of the progressive form (establishing reference to a ‘middle part’ of the situation only – see 1.22.4) automatically results in a homogeneous representation of the situation. Thus, the progressive verb phrase *will be drinking five glasses of beer* (which can only be felicitously used

if the number of glasses is determined before the situation starts) represents the situation referred to as homogeneous: if *will be drinking five glasses of beer* can be used to refer to a whole situation, it can also refer to parts of that situation. However, in this case [\pm homogeneous] is not an ontological feature because the choice between a progressive and a nonprogressive form is not a choice between different lexical items. This has as a consequence that in section 1.42, where we define various ‘situation types’ on the basis of different ontological (lexical) features, we will not consider *drink* and *be drinking* as denoting templates for different situation types: in both cases the situation type is an ‘action’, i. e. a dynamic situation which is not a change of state and whose actualization is caused by a consciously acting agent.

1.37 Ontological feature 4: ‘durative’ vs ‘punctual’

1.37.1 Situations are conceived of as having a certain duration (= DURATIVE) or as needing no more than a moment to actualize (= PUNCTUAL, NONDURATIVE, MOMENTARY):

They’re printing my book. (*durative situation*)

I knocked at the door. (*punctual situation*)

1.37.2 A durative kind of situation normally requires the use of a DURATIVE SITUATION VERB PHRASE,¹⁹ while a punctual kind of situation always requires the use of a PUNCTUAL SITUATION VERB PHRASE. However, there does not appear to be a perfect correlation between punctual situation verb phrases and punctual actualizations of situations. There are two problematic areas. To begin with, on the level of actualization, duration may be the result of repetition. This renders it possible for a punctual situation verb to be used in a clause that is interpreted as referring to a durative actualizing situation:

Someone was knocking at the door. (*repeated knocks*)

The monkey jumped up and down for several minutes. (*repeated jumps*)

Exactly 14 people stabbed the victim. (*punctual on a simultaneous reading – the 14 people stabbed the victim at the same time – but durative on the consecutive interpretation*)

So far the serial killer has murdered six prostitutes. (*durative on the normal, i. e. consecutive, interpretation*)

19. The word *normally* is necessary here because, as noted immediately below, duration may result from repetition, and the idea of repetition can be due to the plurality of the subject, as in *A lot of people entered the church*. In this case the sentence denoting a durative situation does not contain a durative situation VP.

For ease of reference we will include the situations represented in such sentences in the class of durative situations. (When a more precise label is required, we will speak of a ‘durative hypersituation consisting of (consecutive) punctual subsituations’.)

Since the idea of ‘durative hypersituation consisting of punctual subsituations’ can only be triggered by the progressive form or by a constituent of the sentence which is not the verb itself, it does not play a part in the definition of durative ontological aspect as denoted by a verb denoting a simple situation-template. Thus, in the following sentences, all of which refer to situations that are durative because they are repetitive, the verb used is a ‘punctual situation verb’:

I shot five soldiers in less than a minute. (*The idea of repetition is induced by the combination of the plural object NP and the durational adverbial – compare: *I shot a soldier in less than a minute. In order for the adverbial to make sense, a series is required to make the situation durative.*)

One after the other, the ramblers reached the top of the hill. (*The idea of repetition is induced by the plurality of the subject NP and the duration-implying phrase one after the other.*)

Someone was frantically knocking on the back door. (*Repetition is signalled by the use of the progressive form.*)

The above sentences refer to situations which are durative hypersituations consisting of a series of punctual subsituations. Of course, there is no durative hypersituation if there are a number of punctual situations which all actualize at the same time, as in one interpretation of *The fifty people present nodded*. This sentence refers to (the actualization of) a durative hypersituation if the fifty people present nodded one after the other. On the interpretation that the fifty people present nodded at the same time, there is no durative hypersituation, only one punctual situation involving a multiple-referent subject (similar to the situation referred to in *We reached the top at 5.37*, which is treated as a single punctual situation).

1.37.3 The second reason why there is not a perfect correlation between punctual situation-templates (denoted by verbs, verb phrases or more complex predicates) and punctual actualizations of situations is that (as noted in section 1.38.1) verbs like *die* or *kill* can be used to refer either to a punctual transition or to the durative preparatory phase leading up to the transition in question:

He died versus *He was dying*.

He died instantly versus *He died slowly*.

She killed him versus *She was killing him* or *She killed him slowly*.

Since the durative reading arises only in a suitable context (e. g. in the presence of a durational adverb) or when the progressive form is used, it does not seem

to be warranted to classify *die*, *kill*, etc. as possibly belonging to the class of durative situation verbs. We will therefore include these **TRANSITIONAL SITUATION VERBS** into the class of punctual situation verbs but distinguish between a (punctual) **TRANSITION READING** and a (durative) **PREPARATORY PHASE READING**.

1.37.4 Verb phrases denoting a punctual type of situation cannot co-occur with a duration adverbial, except if repetition is implied or if a duration adverbial can be used to express the duration of the resultant state (i. e. the state resulting from the performance of the action).

*Jill reached the church for three hours. (*This is unacceptable because, in the world as we know it, Jill's reaching the church is a single punctual actualizing situation, which could not last for three hours.*)

The clown jumped up and down for several minutes. (*repeated jumps*)

Mother has just left for two hours. (*Acceptable only on the reading that her absence [i. e. the resultant state] will last for two hours.*)

1.38 Ontological feature 5: [\pm transitional]

1.38.1 A situation may or may not — this is the meaning of the \pm sign — be a transition. A situation is (represented as) a **TRANSITION** if it consists in a single transition, conceived of as punctual, from one state into another. Verbs like *die*, *open*, *kill*, *pick up*, etc. refer to such a transition. For example, in *John died two weeks ago*, the **TRANSITIONAL SITUATION VERB** *die* refers to the punctual transition from the state of being alive to the state of being dead. The sentence *Jim suddenly stopped (to light a cigarette)* expresses a punctual transition from motion to standstill. In *Our lives changed drastically after that*, the situation referred to is not a transition because it is not punctual. No matter how quick the change was (felt to be), the evolution was more continuous (less abrupt) than the transitions referred to by *stop* and *die* in the preceding examples.

Transitional situations are often the culmination of a preparatory phase. This phase may or may not be explicitly referred to in the sentence in which the transitional situation verb phrase is used. Compare:

Last week John suddenly died. (*Suddenly rules out the idea of preparatory phase.*)

Last week John was dying. (*Because of the progressive form, the sentence refers to the preparatory phase only.*)

Last week John died. (*Without an indication to the contrary, the hearer will assume that there probably was a preparatory phase of some length, but this is a question of pragmatic interpretation. The sentence itself asserts the transition only.*)

1.38.2 According to the definition adopted here, a transition is always conceived of as punctual. This rules out what in every-day language could be

referred to as ‘gradual transitions’, like the ones referred to in the following examples:

The situation is deteriorating.

The child is still growing.

The music was fading out.

In our terminology, such sentences refer to a ‘process’, i. e. a durative change of state (see 1.42.5 below).

The definition of ‘transition’ as a punctual change of state reflects the fact that in a progressive sentence the transition itself never forms part of the ‘middle part’ of the situation that is picked out by the progressive form. Thus, *John was dying* refers to the preparatory phase leading up to John’s death but cannot include the transition itself in its reference. If it did, we could not explain why *John was dying* does not actually say that John died. It is only the context that can make it clear whether or not the transition actualized.

When we found him, John was dying. [But he pulled through in hospital.]

John wrote this poem when he was dying. [We keep it in a frame next to his ashes.]

The fact that the transition cannot form part of the ‘middle part’ of the situation referred to by the progressive form is due to the fact that the transition itself is the possible end of the process. The end of a situation never forms part of the ‘middle part’ that is being referred to by a progressive form – see 1.22.4.

1.39 Ontological feature & ‘telic’ vs ‘atelic’

1.39.1 A situation type (referred to by a situation-template) is said to be **TELIC** when the verb phrase describing it represents the situation as tending towards a natural (inherent) point of completion, i. e. a necessary terminal point, without which the situation is not complete and at which it naturally comes to an end. In sentences like *John pushed his mountain bike into the garage*, *Betty ran three miles*, *Mr Harris is writing another book* or *Hyacinth sang a line of the aria*, the verb phrase each time represents a type of situation as telic, because it involves reference to a point of completion beyond which the situation (as described by the verb phrase) cannot continue. Thus, once Hyacinth has sung a line of the aria, the situation as described by the VP *sang a line of the aria* is complete and cannot continue, irrespective of how many more lines of the aria Hyacinth goes on to sing.

A situation-template is **ATELIC** if it does not represent the kind of situation referred to as telic. In other words, ‘atelic’ means ‘nontelic’. Thus, in sentences like *John drove the car* or *Betty ran*, the verb phrase represents its situation as atelic, because it does not refer to a natural (inherent, automatic) point of completion.

1.39.2 It is important to see that there is a difference between conceptualizing an abstract *kind* of situation as *tending towards a natural point of completion* and representing an *actualizing* situation as *reaching a terminal point* (whether this is a natural point of completion or not). The former is a question of ontological aspect, in this case telicity, the latter a question of ‘actualization aspect’, in this case ‘boundedness’ (see section 1.44). Both *John drank vodka on his birthday* and *John drank a bottle of vodka on his birthday* represent the actualization of the situation referred to as bounded (i. e. as having come to and end, as reaching a terminal point), but the latter contains a telic verb phrase (because *drink a bottle of vodka* implies a natural point of completion, viz. when the bottle is empty) whereas the former does not (because *drink vodka* does not indicate a boundary). In both *John wrote a book* and *John was writing a book* the reference is to the actualization of a situation that is of the telic kind, i. e. which involves a development towards a natural point of completion, but only the former sentence represents the actualization of the situation as bounded (in this case: as having come to an end, hence as ‘completed’). In other words, the ontological aspect category [\pm telic] has to be distinguished not only from the grammatical aspect category [\pm progressive] but also from the actualization aspect category [\pm bounded].

1.39.3 Because (a)telicity has nothing to do with actualization, we can apply the terms *telic* and *atelic* to situation-templates (denoted by verbs, verb phrases and other, more complex, predicate constituents) and, in a derived use, to the situation types distinguished on the basis of the (a)telicity of the template used, but strictly speaking not to sentences (which, if we are still ‘strictly speaking’, are used to refer to the actualization of a kind of situation). The following are examples of atelic and telic verbs and verb phrases:

atelic: write, write letters, drink, drink whisky, drink some whisky, drink (some) glasses of whisky

telic: write a letter, write three letters, drink a glass of whisky, drink three glasses of whisky

1.39.4 Although it is situation-templates and situation kinds, not clauses and actualizing situations, that are telic or atelic, it will occasionally be difficult to avoid speaking of **TELIC CLAUSES** or **TELIC SITUATIONS**, because ‘clause with a telic situation-template’ and ‘actualization of a situation referred to by a clause involving a telic situation-template’ are very unwieldy expressions. Thus, for reasons of readability, expressions like ‘sentences representing a situation as durative and agentive, and containing a telic VP’ will be simplified to ‘sentences that are durative, agentive and telic’. Still, one should always keep in mind that only the former formulation is really accurate.

1.39.5 It follows from the definition of (a)telicity that the distinction does not apply to punctual situation verb phrases (e. g. *tap on the window*, *explode*,

hit a man): only a durative situation verb phrase can represent a situation as *tending towards* (i. e. implying a development towards) a natural (inherent) point of completion. A development is by definition durative (otherwise it is a transition – see 1.38.2).

1.39.6 One reliable *test* to distinguish between telic and atelic verb phrases is to try using the gerund form of the verb phrase as direct object of *complete* or *finish*, which refer to the natural point of completion of an action. Only telic verb phrases can be used in this way. (It should be noted, however, that not all telic VPs can depend on both *complete* and *finish*. There are constraints on the use of *complete* which entail that we cannot always substitute *complete* for *finish*. This is not relevant to the reliability of the test, though: if a VP can depend on either *complete* or *finish*, it is a telic VP.)

["What did you do last night?"] – "I finished {repairing the roof / *repairing}."
(*Repair the roof is a telic VP while repair is atelic.*)

It was 11.30 p.m. when I completed {writing the report / *writing}. (*Write the report is a telic VP while write is atelic.*)

He {stopped / *finished / *completed} being their leader in 1988. (*Be their leader is an atelic VP.*)

Unlike *finish* and *complete*, the verb *stop* refers to an arbitrary endpoint. It can therefore be followed by an atelic verb phrase. If it is followed by a telic one, *stop* is by implicature interpreted as referring to a provisional endpoint preceding the natural point of completion:

I stopped reading the book at five. (*implicates that I had not finished reading the book when I stopped reading it*)

This test also reveals that 'pseudo-transitive' verbs (like *eat*, *smoke*, *read*, etc.) are treated as telic even if they have no object NP if the speaker conceives of the action as having a natural point of completion:

It was 11.30 when I finished reading. (*The speaker has a specific book, letter, poem, etc. in mind.*)

[Dinner was served at 8.] We finished eating at 9.30.

1.39.7 Another test is that only telic verb phrases can follow strings of the type *It {took / will take} me an hour to ...* (which measure the duration of the actualizing situation up to its inherent point of completion). Compare:

It took John twenty minutes to run a mile. (*telic verb phrase*)

?It took John an hour to run. (*atelic verb phrase*) (*If judged acceptable, the only possible interpretation is 'It took John an hour to reach the point of beginning to run'. There is no reading in which the duration of the running itself is measured.*)

It will take Bill a long time to read that book. (*telic verb phrase*)

²It will take Bill a long time to read books. (*atelic verb phrase*) (If acceptable, the sentence can only be interpreted as 'It will last a long time before Bill starts reading books'. There is no reading in which the duration of the situation of reading books itself is measured.)

1.39.8 We have already stressed that (a)telicity is not a characteristic of sentences (since the nature of the subject does not play a part in making the distinction)²⁰ but of verbs and verb phrases. In fact, various constituents of the verb phrase can determine the (a)telic nature of the situation-template. For example, *walk* is an atelic verb, but *walk a mile* and *walk for two hours* are telic situation-templates. In the latter examples, the 'TELICIZING' constituents (*a mile, for two hours*) 'measure' the length of the conceptualized type of situation. Measuring the duration of a situation naturally means considering it from beginning to end. A verb phrase involving a measure phrase therefore naturally represents a kind of situation as having a point of completion, i. e. as telic. (At least, this is the case as long as there is no reference to actualization, i. e. as long as the VP is used in isolation, as an infinitival form, and not as the inflected VP of a tensed clause – see below). In *write a book*, the 'TELOS' (point of completion) is implied rather than indicated by a phrase with a definite meaning, but there is measuring in the sense that a book is typically conceived of as having an end and as constituting a unit of writing. In this case the idea of a 'telos' is what Grice (1975) calls a 'conventional' (= noncancellable) pragmatic implicature of the infinitival VP *write a book*.

From a pragmatic point of view, there are only two kinds of verb phrase that can measure a type of situation. One is exemplified by *write a book* or *build a wall*, in which the point of completion is conventionally implicated, but remains indefinite (i. e. writing a book and building a wall take up a specific amount of time, but the precise duration differs according to the length of the book or the size of the wall and is unspecified when the verb phrase *write a book* or *build a wall* is used). The other kind of measuring VP consists of verb phrases which specify the exact location of the point of completion in time or space, as when we use a verb phrase like *walk for two hours* (which involves an adverbial indicating a specific duration), *walk a mile* (which involves an indication of specific distance) or *go into the church* (which involves an adverbial specifying a goal that is reached).

If the speaker uses a telic VP in a clause referring to the present or future, the point of completion is not yet reached at speech time. This means that reference to the precise length (i. e. duration or distance) of the situation, as in

20. Not only in *John walked* but also in *Three people walked* the VP is atelic. It is irrelevant to this whether the three people walked together or one after another. Since *walk* is atelic, the situation of the third person walking has no inherent point of completion, and so the cumulative hypersituation of three people walking cannot have an inherent point of completion either.

She is walking for two hours, is pragmatically only possible if the speaker knows in advance what the length of the situation is going to be. This is a very important point, which is often neglected because the vast majority of examples adduced to illustrate claims in connection with (a)telicity are in the past tense. A sentence in the past tense typically refers to a ‘bounded’ situation, more particularly to a situation whose actualization terminated before the time of speech. This is the case irrespective of whether the VP is telic (e.g. *John went to London on his birthday*) or atelic (e.g. *John was in London on his birthday*). Conclusions drawn from examples in the past tense therefore often concern boundedness rather than telicity. To illustrate the (a)telic nature of a situation-template it is therefore better to use the VP in a present tense sentence in the progressive form. Examples with a telic VP like *John is running two miles*. [*He is nearly half-way now.*] or *John is running for 45 minutes*. [*He is nearly half-way now.*] are then only acceptable if the speaker knows in advance what the length of the complete situation is going to be. Only in that case is it pragmatically possible for him to use a telic VP specifying the precise length (i. e. duration or distance) of the conceptualized kind of situation (whose actualization is represented as still incomplete).

On a higher level than the VP, viz. on the level of the clause (which refers to actualization), the indication of the full length of a situation can also be the result of measuring the situation when the endpoint of the actualization is reached, as in *He had walked for two hours [before he reached the village]*. However, what is measured here is not a kind of situation but a particular instance of actualization. As we will see in section 1.48.2, when an adverbial like *for two hours* is the result of this kind of measuring, it renders the clause (and the actualizing situation referred to) bounded, but it does not affect the atelic nature of the kind of situation denoted by the VP (*walked*). In other words, *for two hours* is then a ‘bounding’ constituent, but not a telicizing one. A measure phrase is telicizing only if it indicates the pre-determined length of a kind of situation. In that case the speaker is able to indicate that length because he knows in advance what it is going to be, as in the following:

John will walk a mile tomorrow.

John was walking a mile when he had a heart attack.

John was walking for two hours when he had a heart attack.

In these examples *a mile* and *for two hours* indicate the natural terminal point of a pre-determined telic situation type: the description of the kind of situation is not *walk* (which is atelic) but *walk a mile* or *walk for two hours*.

1.40 Ontological feature 7: [\pm evolving]

1.40.1 A verb phrase may or may not represent a type of situation as **EVOLVING**, i. e. as gradually developing. Compare:

John drew a circle. (*The situation is represented as dynamic, agentive and telic, but not as evolving.*)

The situation deteriorated. (*dynamic, nonagentive, atelic, and evolving*)

Evolving situations (e. g. growing, getting dark, diminishing) are always (conceived of as) dynamic, durative, nonagentive and consisting in a gradual change. The latter feature means that each stage of an evolving situation is similar to the preceding stage, except that it usually represents a higher or lower value on a scale. Prototypical verbs denoting an evolving situation are *change* and *develop* (in their intransitive use, i. e. when they are nonagentive). They imply movement on an implicit scale.

1.40.2 Punctual situations are by definition not evolving, because any evolution takes time. States are not evolving either, because an evolution involves change, while states are by definition unchanging throughout their duration.

1.40.3 In section 1.33.1 it was noted that grammatical aspect can sometimes overrule ontological aspect. We saw that *John was writing two letters* is homogeneous, although *John wrote two letters* is not. In the same way, the progressive form can sometimes change [$-$ evolving] into [$+$ evolving]. Compare *John died*, which represents a situation that is a punctual transition (and hence not evolving) with *John was dying*, which represents the situation as evolving, i. e. as nonstatic, nonagentive and gradually developing.

VI. Classifications of situation types

1.41 Introduction

On the basis of the ontological features identified in section 1.33–40 various types of situation-templates can be discerned. These ontological features can also be used to distinguish the various abstract situation types referred to by the linguistic expressions (verbs, VPs and predicate constituents) denoting these situation-templates. Moreover, we can also apply the ontological features to concrete actualizations of situations (and to the linguistic expressions – i. e. clauses – referring to them). This is because the actualization of a situation is referred to by a clause, which consists of a subject and a predicate constituent. As we have seen, the subject can help to determine some of the ontological features, e. g. (non)homogeneity – see 1.36.4 – or durativity – see 1.37.2. Otherwise the ontological features necessary to distinguish between the types of situation are determined by elements in the predicate constituent. It is therefore perfectly possible to build a classification of situation types on the basis of the ontological features distinguished in sections 1.33–40 under the heading of ‘ontological aspect’.

Apart from the fact that each ontological distinction (e. g. ‘static’ versus ‘dynamic’) by itself divides all situations into two types, there are two well-known typologies which are based on more than one ontological distinction. One is Lyons’ (1977) classification of situations into ‘states’, ‘actions’, ‘processes’ and ‘events’; the other is Vendler’s (1967) classification of situations into ‘states’, ‘activities’, ‘accomplishments’ and ‘achievements’. In the following subsections we will briefly examine these two classifications.

1.42 Classification 1: states, actions, events and processes

In this section we introduce a categorization of situation kinds which reflects our intuitive distinction between different kinds of actualization (determined by the choice of verb, verb phrase, predicate constituent and subject of the clause). The division in question is that between ‘states’, ‘actions’, ‘processes’ and ‘events’ – a fourfold distinction proposed by Lyons (1977). The conclusion of the discussion will be that this is an extremely useful classification, provided we slightly adapt some of Lyons’s definitions – see 1.42.5.

1.42.1 A **STATE** (**STATIC SITUATION**) is a kind of situation which is conceived of as existing (rather than as being done, taking place or developing) and as homogeneous (because unchanging) throughout its duration. A state is not agentive (i. e. when there is actualization, it is not performed or instigated by

an agent – see section 1.35 above) and is not conceived of as needing a continuous input of energy to continue.

1.42.2 Situations that are not static are called **NONSTATIC** or **DYNAMIC**. A dynamic situation may be (conceived of as) either punctual (e.g. knocking) or durative (e.g. building something). In the latter case, the dynamic situation is conceptualized as consisting of a number of stages ('slices'), each of which may be different from (though possibly of the same kind as) the previous stage. This means that durative dynamic situations involve change and therefore as a rule require a continuous input of fresh energy in order to continue.

Bill was a teacher. (*static*)

I need more money. Everything costs so much. (*static situations*)

I believe he is right. (*static situations*)

John walked in the wood this morning. (*dynamic: the situation is conceived of as made up of a number of temporal stages which are similar to each other but are essentially different: at every new stage John has moved a bit forward and his body is in a slightly different position.*)

Bill will write a novel. (*Writing a novel is a dynamic situation.*)

1.42.3 Within the class of nonstatic (dynamic) situations, we will distinguish between actions, events and processes. **ACTIONS** differ from the latter two situation types in that they actualize under the control of an agent (e.g. *John dug a hole*), whereas the latter do not (e.g. *John fell off the ladder*; *The population diminished rapidly*). An **EVENT** is a dynamic kind of situation which is not controlled by an agent but just happens (e.g. bursting, exploding, falling off a ladder, snowing). As is clear from these examples, an event may be (conceived of as) punctual or durative. A **PROCESS** (e.g. changing, getting dark, diminishing) is also dynamic and nonagentive, but is always (conceived of as) durative and involving incremental change that implies a scale of some sort. This means that each stage of a process is similar to the preceding stage, except that it usually represents a higher or lower value on a scale. While prototypical process verbs like *change* or *develop* just imply movement on an implicit scale, process verbs like *increase* or *decrease* emphasize that the subsequent stages of the process correspond with different quantificational values on the scale, each value being placed just above or below the value of the preceding stage.²¹

1.42.4 Certain verbs can only be used with reference to a dynamic (nonstatic) kind of situation (i.e. an action, event or process), unless they are used in a

21. In the (especially philosophically or logically oriented) linguistic literature the term *process* is sometimes used in a different sense, viz. in the sense of our cover-term 'situation'. A sentence like *John is walking* is then considered as a process (rather than as an action in progress). We will not follow this convention.

sentence that receives a habitual interpretation.²² Such verbs are commonly called ‘dynamic verbs’. However, we will stick to the convention introduced in 1.37.2 (in connection with punctual / durative) and speak of ‘dynamic situation verbs’ and ‘dynamic situation verb phrases’, which are more consistent and more transparent terms than ‘dynamic verbs’ and ‘dynamic verb phrases’.

Verbs which in their default meaning (i.e. without habitual meaning and without being put in the progressive form) refer to a process, action or event will be called **PROCESS VERBS**, **ACTION VERBS** and **EVENT VERBS**, respectively. The following are some illustrations:

(*process verbs*) change, grow, mature, die, widen, slow down, improve, thicken, deteriorate, strengthen, diminish, darken, deepen, develop, increase

(*action verbs*) walk, read, drink, look at, write, eat, abandon, ask, play

(*event verbs*) explode, burst, take place, rain, occur, happen, break down, snow, be-fall

1.42.5 The above classification is based on the ontological features [\pm static], [\pm evolving] and [\pm agentive]. A **STATE** is a static situation (see section 1.34.1). An **ACTION** is an agentive dynamic situation (e.g. digging a hole); an **EVENT** is a nonagentive nonevolving dynamic situation (e.g. falling off a ladder); a **PROCESS** is a nonagentive evolving dynamic situation (e.g. becoming dark). This means that this ontologically based classification can be represented by the following chart:

	static	evolving	agentive
state	+	–	–
action	–	–	+
process	–	+	–
event	–	–	–

In this chart all the relevant distinctive features are referred to. Other ontological features need not be mentioned because they either follow from the three that are exploited or do not help to clarify the classification. Thus, it is not useful to mark the four situation types for the distinctions (a)telic and (non)homogeneous because (a) all states are atelic and homogeneous, and (b) all three nonstatic situation types may or may not be telic or homogeneous. Similarly, it is superfluous to refer to the feature [\pm transitional], since states and processes are always nontransitional, whereas actions and events may or may not be transitional. (As noted in 1.38.1, a situation is transitional if it consists in a single transition, conceived of as punctual, from one state into another.) And

22. In section 1.23.3 we have argued that a habit is a kind of characteristic, and hence a state.

it would also be redundant to refer to the feature [\pm durative], since states and processes are always durative, whereas actions and events may or may not be. In sum, the only features that are relevant are those that set off one situation type from all the others, i. e. those for which only one situation type is marked as [+ *feature*]. Thus, only states are [+ static], only processes are [+ evolving] and only actions are [+ agentive].²³

It is also important to keep in mind that this classification is exclusively based on ontological features. As we will see in 1.49.1, progressive aspect can overrule the classification (e. g. whereas *I am always careful* denotes a state, *I am being careful* denotes an action), but [\pm progressive] is not an ontological feature and is therefore immaterial to the ontological classification.

1.42.6 The four types of situation distinguished in the preceding sections are the same as those distinguished by Lyons (1977). However, the definitions differ in a number of ways. Firstly, Lyons does not mention the feature [\pm evolving]. Secondly, whereas Lyons seems to allow for agentive processes and agentive events (referring to agentive processes as ‘activities’ and agentive events as ‘acts’) we shall assume that all agentive dynamic situations are actions, and that processes and events are always nonagentive. This adaptation is necessary to clarify Lyons’ distinctions, which are not clearly defined in his text. Lyons’ (1977: 483) account says: “If a dynamic situation is extended in time, it is a process; if it is momentary, it is an event; and, if it is under the control of an agent, it is an action.” This suggests that the three dynamic situation types – processes, events and actions – are mutually exclusive and that all dynamic situations that are under the control of an agent are actions. (The inference that the three are mutually exclusive is strengthened by the fact that Lyons talks about “states on the one hand, and events, processes and actions on the other” [p.483].) However, Lyons goes on to talk of agentive processes (which are ‘activities’) and agentive events (‘acts’), which makes it clear that, if all agentive situations are actions, then the three types of situation cannot be mutually exclusive, and that some actions are processes and some actions are events. This, though, prompts the question: what do we mean when we say that a situation is a process or an event? If a process is agentive, it is an activity, so when we say merely ‘process’, do we mean *only* a nonagentive process? But then what is the point of having the term ‘process’ include agentive and nonagentive situations if it is only ever interpreted as referring to nonagentive situations? Because of the puzzling nature of this categorization, we have simply borrowed from Lyons what we believe to be the essential distinctions that

23. Of course, the border-line between these situation types is sometimes rather fuzzy. In *Sit still!* the situation referred to is arguably both static and agentive. However, it remains a fact that the chart correctly denotes the features which distinguish between prototypical states, actions, processes and events.

he makes. We base the typology on the major distinction between stative and dynamic situations, as well as on the distinctions between agentive and non-agentive dynamic situations and between evolving and nonevolving dynamic situations.

1.43 Classification 2: Vendler's taxonomy

1.43.1 Vendler (1967) distinguishes between 'states', 'activities', 'accomplishments' and 'achievements'. The criterial ontological features here appear to be [\pm durative] and [\pm telic] (although Vendler himself does not use the terms 'telic' and 'atelic'). In Vendler's analysis, all situations can be classified by means of these two features:

	durative	telic	example
state	–	–	<i>know the answer</i>
activity	+	–	<i>dance, walk</i>
accomplishment	+	+	<i>build a house</i>
achievement	–	+	<i>win the game, die</i>

1.43.2 It will be clear that we disagree with this categorization on a number of points. Firstly, we do not accept that states are by definition nondurative. In our opinion, states are by definition durative, though a sentence denoting a state can pick out a point from it (e.g. *Yes, I knew the answer at 3 p.m. [In fact, I knew it much earlier.]*) because states are by definition homogeneous. (Note that homogeneity presupposes duration.) Secondly, we do not accept the definition of 'achievement' as a punctual telic situation. In our opinion only durative situations can be telic, i.e. tend towards a natural point of completion (culmination point). A verb phrase like *win the game* or *die* denotes a punctual transitional event which is the culmination point of a telic situation, but it does not denote the telic situation itself.

If we were to incorporate Vendler's terms into our theory, we would have to redefine them. A **STATE** would be defined as having the feature [+ static]. The ontological features [+ homogeneous], [+ durative], [– evolving], [– transitional], [– telic] and [– agentive] would automatically follow from this. An **ACTIVITY** would be defined as a situation that is (represented as) nonstatic (dynamic), durative and atelic (e.g. walking, thinking, knitting socks). The feature [+ homogeneous] would automatically follow from [– telic]. An **ACCOMPLISHMENT** would be defined as a situation that is represented as telic (e.g. walking a mile, thinking for an hour, climbing a hill, typing out a report). The features [+ dynamic], [+ heterogeneous] and [+ durative] would automatically

follow from this. An **ACHIEVEMENT** would be defined as a transitional situation (e.g. winning the game, finding a lost ring, dying, reaching the top). Because a transition is by definition punctual, and states are by definition durative, our achievements would automatically be dynamic. They would also be neither telic nor atelic: the feature [\pm telic] is not applicable to punctual situations, because ‘telic’ means that the situation is ‘tending towards a natural point of completion’, which presupposes that it is durative.

In sum, if we were to use Vendler’s terms, we would redefine them as follows:

	static	telic	durative	transition
state	+	–	+	–
activity	–	–	+	–
accomplishment	–	+	+	–
achievement	–	not applicable	–	+

1.43.3 Note that neither in Vendler’s classification nor in our adapted version of it is there room for situations that are both non-durative and non-transitional, such as knocking on the door, hitting someone, firing a shot, etc. This means that a Vendlerian classification will only work if it is supplemented with a category having the following features:

	static	telic	durative	transition
???	–	not applicable	–	–

1.43.4 Because the problems engendered by Vendler’s classification we will work with a different categorization in this book, viz. the fourfold distinction between states, actions, events and processes made in 1.42.

VII. Actualization aspect: ‘bounded’ vs ‘nonbounded’

An actualizing situation is (represented as) bounded if the clause referring to it represents the situation as *reaching* a (natural or arbitrary) terminal point, i. e. as coming to an end. Otherwise it is nonbounded.

1.44 Definition of (non)bounded situations/clauses

1.44.1 As we have seen, ontological aspect concerns the lexical representation of kinds of situations – (non)static, (non)durative, (a)telic, etc. (see 1.33) – while grammatical aspect refers to the grammatically expressed distinction between ways of looking at the internal temporal structure of a situation. (In English, the only relevant grammatical aspects concern the distinction between progressive and nonprogressive representations of situations and habitual aspect expressed by auxiliaries like *used to* or *would* – see 1.25.) We now come to a third kind of ‘aspect’, which is not concerned with how an abstract *type* of situation (corresponding to a situation-template) is conceptualized and lexicalized, nor with the question how the internal temporal structure of a particular situation is grammatically represented, but rather with a distinction between two possible ways of representing or interpreting a particular instance of *actualization* of a situation. On this level of **ACTUALIZATION ASPECT** we must distinguish between **BOUNDED** and **NONBOUNDED** representations of actualizing situations. An actualizing situation is (represented as) bounded if the clause referring to it represents the situation as *reaching* a (natural or arbitrary) terminal point, i. e. as coming to an end. Otherwise it is nonbounded.

Tonight I will drink champagne! (*nonbounded: no reference to a terminal point*)

Tonight I will drink five glasses of champagne! (*bounded: the action will terminate when the fifth glass is empty*)

Tonight I will drink a lot of glasses of champagne! (*nonbounded: since the number of glasses is not specified, there is no reference to a terminal point: I may in principle drink any number of glasses of champagne.*)

The above three sentences can all be used to announce the same situation. This means that the actualization of a situation is not inherently bounded or nonbounded; it is *represented as* bounded or nonbounded by a particular clause. For this reason we will adopt the practice of applying the labels *bounded* and *nonbounded* both to clauses and to situations. (By ‘situation’ we really mean ‘actualization of a situation as represented by the utterance of a

clause.) A **BOUNDED SITUATION** is a situation whose actualization is represented as bounded by a clause. A **BOUNDED CLAUSE** is a clause which represents the actualization of a situation as bounded. If the clause constitutes a sentence, we can also speak of a **BOUNDED SENTENCE**.

In the linguistic literature, 'not bounded' is more often referred to as 'unbounded' than as 'nonbounded'. There is in principle nothing wrong with this – the prefix *un-* can mean 'not', as in *unaware, unbeaten, unavoidable*, etc. – but in 1.48 we will discern a category 'unbounding clause constituent' (which renders a bounded clause to which it is added nonbounded). The *un-* of *unbounding* is the same as in *undo, unfasten, unbuckle, undress*, etc. To avoid any confusion about the precise meaning of *un-* we will use *un-* in the latter sense only, and thus speak of 'unbounding' and 'nonbounded'.

1.44.2 In some cases (non)boundedness is a question of *interpretation* rather than *representation*. A clause like *John was in the library* is normally understood as 'meaning' that John is no longer in the library at the time of speech. However, this meaning is only implicated (i. e. invited for pragmatic reasons): it can be cancelled by the context, as in *Two minutes ago John was in the library, so you will probably find him there.*²⁴ In sum, *John was in the library* is a nonbounded linguistic *representation* of (the actualization of) a situation but is, in the default case, *interpreted* as referring to a bounded situation. When it is crucial to distinguish between these two, we will refer to the former as '**L-BOUNDED**' (i. e. linguistically represented as bounded) and to the latter as '**W-BOUNDED**' (i. e. pragmatically interpreted as bounded in the world that is being referred to). However, since interpretation is usually determined by representation, the default meaning of 'bounded' is 'represented as bounded', i. e. 'L-bounded'. Unless we are explicitly distinguishing between interpretation and representation, a sentence like *John was in the library* will be referred to as 'nonbounded' rather than as 'L-nonbounded'.

Because (non)boundedness can be a question of interpretation rather than representation, there are sentences that allow both readings:

The miner walked through the tunnel inspecting the seam.

This sentence may or may not be taken to mean that the miner reached the end of the tunnel. The interpretation is bounded or nonbounded accordingly.

24. This boundedness implicature of the past tense is due to the Gricean Maxim of Relation (better known as the Maxim of Relevance). Other things being equal – more specifically: if the clause is not couched in a piece of discourse about the past – the present is more relevant to the speaker than the past. This means that a situation whose actualization time includes the time of speech will not normally be represented as lying in the past. By locating a situation in the past when the discourse is not currently 'about' the past, the speaker suggests that it is a past situation, not a present one. Thus, when used in isolation, *Two minutes ago John was in the library* suggests that the proposition 'John be in the library' *only* applies in the past and not in the present, i. e. that the situation is no longer actualizing at the time of speech.

(Remember that ‘nonbounded’ means ‘not represented and/or interpreted as bounded’.)

1.45 ‘Nonbounded actualization’ = ‘homogeneous actualization’

A clause that does not represent the actualization of a situation as bounded (and which is thus nonbounded) invariably represents (the actualization of) its situation as both durative and homogeneous, whereas a durative bounded clause automatically represents the situation referred to as heterogeneous. (The feature [\pm homogeneous] is not applicable to nondurative clauses.)

As noted in section 1.36, ‘homogeneous’ here means that the actualizing situation is (represented as) remaining essentially unchanged from beginning to end. This means that the same description (clause) can be used to refer to the (actualization of the) situation as a whole and to any (representative) part of it.²⁵ Thus, any clause that represents a particular situation as nonbounded can also be used to refer to portions of that situation. For example, if we can use the clause *John was walking in the woods* to report what John was doing from 2 to 4 p.m., we can also use this clause to report what he was doing between 2 o’clock and 3, or to report what he was doing from 2.30 to 3.30, etc. In other words, the tensed proposition is true at any (relevant, i. e. representative) portion of the interval taken up by its actualization.

Bounded clauses, on the other hand, refer to heterogeneous situations. That is, if the clause can be used to denote the actualization of a situation as a whole, it cannot be used to refer to any part of this actualization. Thus, if we can use *John wrote six letters* to report what kept John occupied from 2 to 4, we cannot use the same sentence to report what kept him occupied between 2 and 3, or to report what kept him occupied from 2.30 to 3.30, etc.

The distinction between bounded and nonbounded clauses is similar to the distinction between count and mass nouns. Like bounded clauses, count nouns (e. g. *table, printer*) represent their referents as delimited; neither nonbounded clauses nor mass nouns (e. g. *water, honesty*) represent their referents as having boundaries. It follows that both bounded situations and countable entities are heterogeneous (nonhomogeneous), whereas nonbounded situations and uncountable (= mass) entities are both homogeneous. The difference between bounded clauses and count nouns, and between nonbounded clauses and mass nouns, is the kind of bounding: the actualizing situations referred to by bounded clauses have temporal boundaries, whereas count nouns usually refer

25. Many situations involve ‘gaps’ that are not drawn attention to. For example, *We walked for three hours* does not imply that we did not stop once to have a rest. Naturally, such gaps are not representative parts of the situation.

to entities that have spatial boundaries (although they may also refer to a restricted quantity or amount). In connection with (representations of) actualization, '(non)bounded' means 'represented as (non)bounded *in time*'.

In sum, nonbounded situations or clauses are always homogeneous and bounded situations or clauses are always heterogeneous.

1.46 (Non)boundedness and duration adverbials

1.46.1 A formal test to distinguish between bounded and nonbounded clauses is the addition of a particular type of duration adverbial. A **NONINCLUSIVE DURATION ADVERBIAL** (answering the question *For how long?*) can be added (barring a repetitive interpretation) to nonbounded clauses only, while (barring an inchoative interpretation) an **INCLUSIVE DURATION ADVERBIAL** (answering the question *Within what time?*) can only be added to bounded clauses. For example:

John was speaking. (*nonbounded*)

John was speaking for hours. (*nonbounded + noninclusive duration adverbial*)

#John was speaking in an hour. (*nonbounded + inclusive duration adverbial*) (Note that *in an hour* should be read as measuring the temporal distance between the beginning and end of John's speaking. Only in that sense is it an inclusive duration adverbial. If *in an hour* measures the temporal distance between a contextually given time of reference and the beginning of John's speaking, it is not an inclusive duration adverbial and the sentence may be judged acceptable. The sentence is certainly impeccable if we replace *in an hour* by *within an hour* and front it: *Within an hour John was speaking*. This receives an inchoative interpretation: 'It was at most an hour before John was speaking, i. e. before John began speaking'.)

Similarly:

John ran a mile. (*bounded*)

John ran a mile in an hour. (*bounded + inclusive duration adverbial*)

#John ran a mile for hours. (*bounded + noninclusive duration adverbial*) (The sentence is ungrammatical on a nonrepetitive reading. It is relatively acceptable on the reading 'For hours on end John repeated the action of running a mile' because in this reading the overall situation is nonbounded because the number of times that John ran a mile remains vague.)

1.46.2 In the linguistic literature, the (im)possibility of collocating with a (non)inclusive adverbial is usually considered to be a test for (a)telicity rather than (non)boundedness: it is claimed that telic VPs and atelic VPs are only compatible with inclusive and noninclusive adverbials, respectively. That there is some truth in this becomes clear when we consider VPs in isolation. *Walk three miles* is a telic VP, and in isolation the VP *walk three miles in an hour* makes sense, while *walk three miles for an hour* does not. Similarly, *be upset*

is an atelic VP, and we can easily conceptualize *be upset for an hour* as a kind of situation, but not *be upset in an hour* (barring an inchoative interpretation). However, there are also examples in which an inclusive adverbial combines with an atelic VP:

Within the last week John has been at home only three times.

Within the last week John hasn't been at home at all.

In these examples the VP is not telic,²⁶ but the situation (which is a hypersituation consisting of a series of subsituations) is bounded because the speaker 'MEASURES' it: he is concerned with the number of actualizations there have been in the period identified by the inclusive adverbial. Self-evidently, 'measuring' a situation means considering it from beginning to end. Nonbounded (actualizations of) situations cannot be measured.

It is in keeping with this that the presence of a *within*-adverbial does not entail boundedness in sentences whose purpose is not to measure a (hyper)situation:

Within three weeks after his accident he was out of hospital.

Downslope of the vents, there have been some dramatic changes within the last few weeks. (www)

Oral presentations are in general within the last few weeks of the semester you are registered. (www)

In sentences like these, the *within*-adverbial is used as a time-specifying adverbial rather than an inclusive duration adverbial.

In sum, it is true that, (in isolation, only telic VPs are compatible with an inclusive adverbial. But it is not true that inclusive adverbials cannot be found in sentences that do not involve a telic VP. An inclusive duration adverbial can be added not only to clauses with a telic VP but also to clauses which do not have a telic VP but 'measure' a (hyper)situation.

It is also important to see that the rationale of the test is not that a nonbounded clause cannot *contain* an inclusive adverbial but rather that an inclusive adverbial cannot *be added to* a nonbounded clause. This means (amongst other things) that if an inclusive adverbial has been added to a bounded clause with a telic VP, we can still render that bounded clause (including the adverbial) nonbounded by making the verb form progressive:

26. As pointed out in footnote 20, the VP of a sentence referring to a hypersituation consisting of a number of atelic subsituations following each other cannot be telic, because the last subsituation is atelic. This was argued as follows: "Not only in *John walked* but also in *Three people walked* the VP is atelic. It is irrelevant to this whether the three people walked together or one after another. Since *walk* is atelic, the situation of the third person walking has no inherent point of completion, and so the cumulative hypersituation of three people walking cannot have an inherent point of completion either."

I am going to walk three miles in an hour.

I was walking three miles in an hour [when I sprained my ankle].

The first example is a bounded sentence with a VP that is telic because the length of the walk is pre-determined – see 1.39.8. In the second example, the VP is also telic because the distance is again pre-determined – it has been determined before the walking started – and because *in an hour* forms part of the situation-template (VP). However, the sentence is L-nonbounded because the progressive form *was walking* only refers to some middle part of the actualization of the situation and disregards its possible terminal point.

1.47 (Non)boundedness vs (a)telicity

1.47.1 The bounded versus nonbounded distinction is often identified with the telic versus atelic distinction (discussed in section 1.39). However, there is clear evidence that these two distinctions represent two quite different parameters. (A)telicity is a question of verb phrases (situation-templates – see 1.29.1) whereas (non)boundedness is a question of clauses. (Put differently, (a)telicity has to do with whether the speaker *conceptualizes* a kind of situation as *having* a natural point of completion or not, whereas (non)boundedness has to do with whether the speaker *represents* the *actualization* of a situation as *reaching* an (inherent or arbitrary) endpoint or not. A VP like *run five miles* is telic (because *five miles* implies a natural point of completion), but it can be used both in a bounded clause (*Bill ran five miles*) and in a nonbounded one (*Bill was running five miles*). This shows how grammatical aspect can interact with ontological aspect to determine actualization aspect: *run five miles* is a telic VP, but since the progressive form only refers to a portion of the middle part of the actualizing situation, the sentence does not represent the actualization of the situation as bounded, i. e. as reaching the natural point of completion. (In fact, since the sentence *Bill was running five miles* only makes a statement about a portion of the middle part of the actualizing situation and not about the actualization as a whole, it leaves vague whether or not the natural point of completion was eventually reached in the actual world.)

The reason why (non)boundedness is often confused with (a)telicity is that both pairs involve the homogeneous versus heterogeneous distinction discussed in 1.36. Telic and atelic verb phrases refer to abstract types of situations and are heterogeneous and homogeneous expressions, respectively. Bounded and nonbounded clauses refer to concrete actualizations of situations and are heterogeneous and homogeneous expressions, respectively. The difference between the two becomes clear when a heterogeneous (telic) verb phrase is used in a homogeneous (nonbounded) clause, as in *Bill was running his usual five miles [when he sprained his ankle]*. As is clear from this example, 'telic' means

'nonhomogeneous' on the level of situation-templates (i. e. descriptions of conceptualized types of situations) whereas 'bounded' means 'nonhomogeneous' on the level of clauses (i. e. descriptions of actualizations of concrete situations).

1.47.2 In a sentence like *I will answer these three letters tomorrow*, the type of situation is represented by the verb phrase as telic (i. e. tending towards a natural point of completion) but one might wonder whether the actualization of the situation is represented as bounded (i. e. reaching the point of completion). Boundedness is a question of actualization, but a sentence in the future tense refers to a situation that has not yet actualized. A future situation may be intended or expected to actualize in a particular way (i. e. as bounded or nonbounded), but the speaker can never be quite certain that the situation is actually going to actualize in this way. It does not follow, however, that it would be appropriate to say that *I will answer these three letters tomorrow* is a nonbounded sentence. The correct way of interpreting the facts is to say that the sentence refers to a 'possible world' which is not the actual world but a future imagined world. In this world, the situation is represented as bounded. This conclusion is supported by the following data:

I will answer these three letters when he rings tomorrow [and then I shall post them].
(This has to be interpreted as predicting the actualization of a situation which reaches a terminal point.)

I will be answering these three letters when he rings tomorrow [and then I shall post them].

The first sentence is interpreted as something like 'I will answer these three letters immediately after he rings tomorrow [and then I shall post my letters of reply]'. By contrast, the second example in principle allows two interpretations. One is that the progressive form is chosen to express a 'matter-of-course' future interpretation (see 7.7), in which case the situation of writing three letters is bounded and the *and*-clause sounds quite natural. In this reading, the *when*-clause situation does not interrupt the answering of the letters but precedes it (as in the first example). The second interpretation is a progressive reading. This means that the *when*-clause situation is taken to occur during the answering of the letters, which is therefore represented as nonbounded. In this reading the addition of the *and*-clause is rather odd because there is no implication that the letter-answering situation is terminated. (Because *answer three letters* is a telic VP, saying that the situation is terminated is equivalent to saying that the letters are answered, i. e. that the situation is completed).

In sum, a sentence in the future tense can also represent the actualization of a situation as bounded, but then in a projected possible world which is not yet factual at t_0 .

1.48 (Un)bounding clause constituents

1.48.1 Any argument constituent of a clause can in principle add the idea of a right temporal boundary (= terminal point) and thus render the clause L-bounded (= linguistically represented as bounded – see 1.44.2) or leave it L-nonbounded:²⁷

{A litre / three litres} of water will run out of this tap. (*L-bounded: the boundary is specified by the quantifier in the subject NP, which indicates a precise quantity*)

{Water / litres of water} will run out of this tap. (*L-nonbounded*) (Note that run out of the tap is anyhow an atelic VP. This means that the subject NP cannot determine (a)telicity, although it can determine (non)boundedness.)

Bill read {a poem / three poems}. (*L-bounded: the boundary is specified by the quantified count NP functioning as direct object*)²⁸

Bill read poetry. (*L-nonbounded: the unquantified mass NP functioning as direct object does not specify a boundary*)

The Belgian athlete Puttemans ran the 5,000 metres at the Olympic Games in Moscow. (*L-bounded because the VP is telic and the situation is located at a past time.*)

Bill handed out the Labour Party badge to {a party activist / 112 party activists / every party activist present}. (*L-bounded: the boundary is specified by the indirect object*)

Bill handed out the Labour Party badge to party activists. (*L-nonbounded because the number of activists is not specified*)

1.48.2 Adverbials that indicate duration or distance and which 'measure' (see 1.46.2) the actualization of a situation, either beforehand or at (or after) the terminal point of the actualization, may or may not have an L-bounding effect:

I am going to run the marathon for another twelve years. (*L-bounded: the reference is to a repetitive hypersituation whose terminal point is specified by the definite duration adverbial for another twelve years*)

I am going to run the marathon for many more years. (*L-nonbounded: because of the indefiniteness of many more, the duration adverbial for many more years indicates a period of indefinite length and therefore does not specify the terminal point of the period (though it implies the existence of a terminal point); this means that*

27. All the examples below are nonprogressive, because the progressive form as a rule renders the representation of the situation nonbounded. This follows from the fact that the progressive form as a rule picks out a moment or interval from the middle of a situation and disregards its end.

28. In this example and the following one, the use of the past tense implicates that the situation is not continuing at t_0 and therefore induces a W-bounded reading. However, this does not alter the fact that the situations are L-nonbounded, i. e. not linguistically represented as bounded.

the actualization of the repetitive situation, whose duration is indicated by the adverbial, is not represented as L-bounded, though it is pragmatically interpreted as ‘W-bounded’ – see 1.44.2 – because everybody knows that there is an age at which people are no longer able to run a marathon.)

Until a couple of years ago I knew the answer to that question. (*L-bounded: the until-adverbial specifies the endpoint of the actualization of the situation.*)

[Melissa drove, and] John sulked from France to the Hungarian border. (*L-bounded by the adverbial, which specifies both temporal boundaries of the actualization of the situation.*)

John was in his study from two to five. (*similar*)

[He isn’t a prolific writer.] He’s only published three novels in eleven years. (*L-bounded because of the inclusive adverbial in eleven years, which specifies a period leading up to speech time, and because of the fact that the speaker measures the number of subsituations making up the repetitive hypersituation.*)

1.48.3 In the previous section it was pointed out that *I am going to run the marathon for many more years* is L-nonbounded because of the indefiniteness of the duration adverbial. However, the sentence to which the adverbial is added (viz. *I am going to run the marathon*) is itself L-bounded if it refers to the complete actualization of a single telic situation. This means that the addition of *for many more years* to *I am going to run the marathon* has an **UNBOUNDED** effect because it induces a nonbounded-repetitive interpretation. This follows from the fact that *for many more years* does not refer to, or imply, a well-defined endpoint of the actualization of the repetitive hypersituation.

1.48.4 In its basic use, viz. when it serves to reduce the reference to the middle of the situation only, the progressive form also has an unbounding effect. Thus, unlike *I read a poem last night*, which is L-bounded, *Last night I was reading a poem [when John called me up]* is L-nonbounded, because the progressive form excludes the end of the situation from the reference.

VIII. The aspectual interpretation of a clause

1.49 Aspectual interpretation

1.49.1 The aspectual interpretation of a clause depends on an interaction between ontological aspect (see 1.33), grammatical aspect (see 1.20) and actualization aspect (see 1.44).

An example of interaction between ontological aspect and grammatical aspect is the interpretation of sentences like *He is being a fool* (= 'He is behaving foolishly'). The verb *be* usually refers to a state, and static ontological aspect is normally incompatible with progressive aspect. When *be* is nonetheless used in the progressive form, the progressive grammatical aspect overrides the static ontological aspect and results in a dynamic (nonstatic) representation of the situation.

An example of interaction between ontological aspect, grammatical aspect and actualization aspect is the interpretation of the actualization of situations described by sentences with a telic verb phrase and progressive aspect. This interpretation is determined by the second of the following regularities:

telic verb phrase + nonprogressive aspect \rightarrow L-bounded clause (*L-bounded*' means 'linguistically represented as bounded' – see 1.44.2.)

telic verb phrase + progressive aspect \rightarrow L-nonbounded clause

In other words, a telic verb phrase (e.g. *draw a circle*) represents a situation as having (and tending towards) a natural and necessary point of completion. The use of a nonprogressive form in the description of an actualization of this situation results in an L-bounded representation of the situation (e.g. *Jenny drew a circle on the blackboard*): the actualization of the situation is represented as coming to an end when the inherent point of completion is reached. However, the use of the progressive form (e.g. *Jenny was drawing a circle on the blackboard*) means that the natural terminal point is not referred to: the speaker only refers to (some part of) the middle of the situation. It follows that, though the situation is still telic, its actualization is not represented as L-bounded: the (actualization of the) situation is not represented as actually reaching a terminal point.

1.49.2 The regularity 'telic + progressive \rightarrow L-nonbounded' forms part of the more general rule that clauses involving a progressive form that truly expresses progressive meaning automatically represent the actualization of the situation referred to as nonbounded (since progressive aspect means that no reference is

made to the end of the situation – see 1.48.4).²⁹ This actually provides us with a test for checking the (non)bounded character of nonprogressive sentences:

- (a) If we make a nonbounded nonprogressive clause progressive, this has no effect on the nonbounded character of the clause. Thus, the nonbounded sentence *Bill slept in the attic* remains nonbounded when we substitute *was sleeping* for *slept*.
- (b) If we make a bounded nonprogressive clause progressive, it loses its bounded character. Thus, whereas *Bill ran the 100 metres* is bounded, *Bill was running the 100 metres* is nonbounded. (In both cases, however, the VP is telic.)
- (c) It follows that a nonprogressive clause must be nonbounded if its truth follows from the truth of the corresponding progressive clause. For example, the fact that we can infer the truth of *John drank coffee* from the truth of *John was drinking coffee* means that *John drank coffee* is a nonbounded clause.

By contrast, a nonprogressive clause is L-bounded if its truth does not follow from the truth of the corresponding progressive clause. For example, we cannot infer the truth of *John drew a triangle* from the truth of *John was drawing a triangle*. (The former is true only if John drew a complete triangle, whereas the latter was true as soon as John started drawing the triangle.) It follows that *John drew a triangle* must be a bounded clause.³⁰

Needless to say, the above test relies on the fact that L-nonbounded and L-bounded clauses are homogeneous and heterogeneous expressions, respectively – see section 1.44 above.

29. An exception to this is the ‘explanatory-resultative’ use of the progressive present perfect, as in *You’ve been fighting!*, where the speaker refers to some unintended side effect (such as a black eye, or torn clothes) of a situation that has come to an end – see section 5.19.1. In fact, in applying this test it is best to disregard clauses in the present perfect tense altogether, because, in order to account for the ‘continuative’ interpretation of *I’ve {been living / lived} here for 5 years now* we need to distinguish between the ‘factual full situation’ (which leads up to t_0) and the ‘potential full situation’ (which extends into the post-present) – see 5.9. The factual full situation is bounded by t_0 whereas the potential full situation is nonbounded. This means that in present perfect tense clauses, the progressive form does not represent the situation as nonbounded if by ‘situation’ we mean the factual full situation.

30. It is well-known that a similar test is often used to identify (a)telicity rather than (non)-boundedness. However, it has been shown in 1.39 that (a)telicity is a question of VPs, not clauses, and that it is not situations but situation-templates that can be telic or atelic. The categories applying to situations and clauses (= linguistic representations of situations) are ‘bounded’ and ‘nonbounded’. (This does not alter the fact, though, that in nonprogressive clauses the (a)telic nature of the VP is one of the strongest factors determining the (non)boundedness of the sentence using the VP in question.)

IX. Summary of chapter 1

1.50 Parts I and II

Our concern in chapter 1 has been to provide definitions and explanations of the basic linguistic terms and the conceptual apparatus that will be used in this and subsequent volumes. In part I, after providing information about notational conventions to be used, and the sources of our data, we have given a chapter-by-chapter outline of the content of the book. We went on, in part II, to define some general linguistic terms as we shall use them. Note, especially, that for us, the VP will be that part of the predicate constituent that does not contain optional adverbials (the predicate constituent of a clause being everything but the subject noun phrase). Two terms are both fundamental and are used in a very particular way here. **Situation** refers to anything that can be denoted by a clause. Events, states, processes etc. are all types of situations. **Actualization** refers to the taking place or being in place of situations. Where possible, instead of saying that events ‘take place’, states ‘hold’, processes ‘are ongoing’ etc., we will say that situations ‘actualize’ – irrespective of the type of situation involved.

1.51 Part III

1.51.1 Part III looked at three areas of meaning grammaticalized in the verb phrase: tense, mood and modality, and grammatical aspect. We saw that **tenses** (as individual realizations of the abstract category **tense**) express the temporal relation between the time of a situation and an **orientation time** which may be either the **temporal zero-point** (t_0), which is usually speech time, or another orientation time that is temporally related (directly or indirectly) to the temporal zero-point. There are **absolute tenses**, which relate the time of a situation directly to t_0 , and there are **relative tenses**, which express a relation (e.g. of anteriority) of a situation time to an orientation time other than t_0 . There are also **absolute-relative tenses** (e.g. the future perfect) which combine these two functions. The conditional perfect (*would have left*) and some nameless tense forms (e.g. *was going to have left*) are **complex relative tenses**, expressing more than one temporal relation. Some tense forms have the form and semantics of absolute tenses except that the orientation time to which they relate the situation time is not t_0 but another time treated as if it were t_0 . We call these **pseudo-absolute tense forms**.

1.51.2 Our overview of **grammatical aspect** began by looking at aspectual meaning in general. Grammatical aspect is the formal expression (by means of

a special suffix and/or auxiliary) of an aspectual meaning that has to do with the way the speaker views the internal temporal structure of a situation. For example a speaker may view a situation as just beginning, focusing on the initial part of it (**ingressive** or **inchoative** aspectual meaning) or he may view the situation as a **hypersituation** which consists of repeated subsituations, as in *She tapped a few times on the elephant's head*. This is **iterative** or **repetitive** aspectual meaning. (In this work we will refer to the repetition of what is seen as the same situation as iterative or repetitive aspectual meaning even when the repetitions are seen as taking place on different occasions and do not form a hypersituation, as in *I've only been in this town three times*). **Grammatical aspect** is the pairing of these meanings with specific forms of the verb. Different aspectual meanings are grammaticalized in different languages. In English, although many sorts of aspectual meaning can be expressed by, for example, aspectual verbs (as in *It began to rain*), only two sorts of aspectual meaning are grammaticalized. The first is **progressivity**. Progressive aspect combines the progressive form, *be + V-ing* (e.g. *It is raining*), with the meaning 'focus on the middle part of the situation'. The second sort of aspectual meaning that is grammaticalized is **habituality** (e.g. *When I was a child, my mother would buy chocolate for us every Friday*), though the expression of grammaticalized habituality is restricted to verb forms involving one of the auxiliaries *will*, *would* or *used to*.

1.51.3 The third system of the verb phrase introduced in part III is **modality**. Modality is a semantic category which covers two main areas of meaning. The first has to do with the speaker's assessment of the likelihood of actualization (in the past, present or future) of a situation. This is called **epistemic modality**, since it is concerned with the truth of propositions or utterances. The second has to do with factors affecting the likelihood of actualization of situations (such as obligation, willingness, permission, ability, etc.). This is called **nonepistemic** or **root modality**. In English, modality is most often expressed by a modal auxiliary verb such as *must*, *will*, *may*, *can*, etc.

1.52 Part IV

In part IV, we discussed the question of what units of language refer to situations, and conversely, what it is that verbs, clauses etc. refer to. Verbs, verb phrases and other, more complex, predicate constituents, we saw, **denote** rather abstract entities which we call '**situation-templates**'. Clauses, which involve subjects as well as predicate constituents, denote fully-fledged situations.

The **referents** of the linguistic expressions denoting situation-templates are abstract **types of situations** (or '**situation types**'). The **referent** of a (finite) clause is a/the **actualization** of a situation.

However, most of the time we do not really have to make a strict distinction between denotation and reference, nor between situation-templates and situations or between abstract situation types and concrete actualizing situations. This means that we can, and will, often talk of clauses and even verb phrases as ‘referring to situations’.

1.53 Part V

1.53.1 In part V we saw how **ontological aspect** (or **Aktionsart**, or **lexical aspect**) distinguishes different situation-templates according to the semantic features that are automatically conferred on the template by the choice of lexical verb and its complements. (Because it is the lexical verb that counts, progressive or nonprogressive meaning does not play a part in lexical aspect.) While grammatical aspect is clearly concerned with the internal temporal structure of a situation, lexical aspect is much more loosely concerned with this. For example, an important feature is that of **(non)agentivity** (i. e. agentivity or nonagentivity, which we can write as $[\pm \text{agentive}]$). A situation-template is agentive if it entails an agent that (virtually always intentionally) causes the situation to actualize. (Compare: *Sylvia shouted* and *Sylvia breaks windows*, which are both agentive, with *Sylvia looks determined* and *The window broke*, which are nonagentive). Agentivity is only indirectly to do with how the situation is seen as unfolding in time, in that it may affect the possibility of using the progressive, and of using verb phrases in certain ways. (Compare: *Sylvia’s breaking windows with her fellow protesters tomorrow* (agentive) with **Sylvia’s looking determined tomorrow* (nonagentive)).

1.53.2 The other features – all binary, like (non)agentivity – that play a role in lexical aspect are briefly repeated here. A situation-template may be **static** or it may be **nonstatic** (dynamic). A static situation-template is one which refers to a situation type that involves no change and requires no energy in order to continue actualizing. Such situations include **habits** (as implied by the template *walk to work every day*). Conversely, a type of situation referred to by a dynamic situation-template involves change and requires an input of energy in order to actualize or to continue actualizing. The term ‘static’ is extended to situations and to clauses which contain a static verb phrase. (The same, naturally, applies to the term ‘dynamic’). Verbs which only denote static situations are called **static situation verbs** or **state verbs**, and verbs which only denote dynamic situations are called **dynamic situation verbs**.

1.53.3 The feature $[\pm \text{homogeneous}]$ also belongs to the realm of lexical aspect but only in a limited way. The meaning of homogeneity is most easily explained by considering types of situations. **Homogeneous** situation types are

ones in which every portion of the situation can be described in the same way as the whole situation (for example *drink beer*). **Nonhomogeneous**, or **heterogeneous**, types of situations are made up of parts which are each different from the whole (for example *drink a glass of beer*, in which no single part of the situation constitutes a full instance of drinking a glass of beer).

Some of the information which determines the (non)homogeneity of a concrete actualization of a situation is lexical information found in the situation-template, and in some cases the (non)homogeneity of a clause can even be fully determined by the situation-template. However, apart from the fact that the nature of the subject NP may affect the interpretation of the actualization of a situation as homogeneous or not, it is often not possible to decide on the homogeneity of a situation unless we know whether or not the clause referring to it receives a progressive interpretation. This in turn, of course, is often dependent on grammatical aspect. Thus, if we take the telic situation-template represented by *drink a glass of beer*, it may be involved in the representation of (the actualization of) a situation as nonhomogeneous as well as one which is homogeneous: *Sylvia drank a glass of beer* represents its situation as nonhomogeneous, *Sylvia was drinking a glass of beer* focuses purely on the activity in progress and represents the actualization of the situation referred to as homogeneous. (In addition, a habitual interpretation may also alter the homogeneity value of a situation, since a habit is a kind of state, and habituality may be indicated by elements outside the predicate constituent, as in *Elephants are intelligent*, where the repetitive-habitual aspect of meaning is induced by the generic plural subject NP.) In sum, (non)homogeneity is ultimately a feature of clauses referring to actualizing situations, but it can be determined by the nature of the situation type, or/and by the (non)progressive or (non)habitual aspectual interpretation that is assigned to the clause.

1.53.4 An important distinction made at the level of situation-templates – but, like most of the distinctions discussed here, a distinction which is often applied by extension to clauses and to situations – is that between **punctual** and **durative** situation-templates. Punctual situation-templates imply a situation which is conceived of as taking up no measurable time, or lasting just a moment, while durative situation-templates imply a situation conceived of as extending over an appreciable interval. Verbs that are typically used to refer to punctual situations are called ‘punctual situation verbs’, but even such verbs may sometimes be involved in the reference to durative situations. This happens most notably when a punctual situation verb is used in a clause that is interpreted as referring to the repetition of a punctual situation, so that the repetitions constitute a durative **hypersituation**. For example, *Sylvia smashed a window* is interpreted as referring to a punctual situation, but *Sylvia smashed twenty windows* is normally interpreted as referring to a durative situation

composed of multiple instances of window-smashing rather than as a single punctual situation of smashing twenty windows simultaneously.

1.53.5 A situation-template (and hence, informally, a situation) may be **transitional** or **nontransitional**. A transition consists of a (punctual) change from one state to another. In *open the window* the situation-template involves the window undergoing a transition from the state of being closed to the state of being open (as a result of some sort of agency). In *Meg opened the window* the entire transition is referred to; in *Meg was opening the window* only the **preparatory phase** leading up to the actual transition.

1.53.6 A situation-template is **telic** if it denotes a type of situation which is represented as tending towards an inherent terminal point, without which the situation is not complete and at which it naturally comes to an end. An example is *Sylvia {drank / was drinking} a glass of beer*. Otherwise, it is **atelic**, for example *Sylvia {drank / was drinking} beer*.

1.53.7 Finally, a situation-template may be **evolving** or **nonevolving**. A situation that is [+ evolving] is one involving a gradual process of change that is not represented as caused by an agent, for example *The beer was fermenting*.

1.53.8 Of course, in any given situation-template we will be able to discern one value or the other (i. e. a plus or a minus) for most if not all of the features discussed above. Thus a situation-template like *break a window* can be characterized as [+ agentive], [+ dynamic], [+ telic], [+ transitional] and [– durative]). (Since the template is punctual, the features [+ evolving] and [± homogeneous] do not apply).

1.54 Part VI

In part VI we explained how we can use different combinations of lexical aspect values, in combination with information from subject NPs, to divide into broad types the situations denoted by whole clauses. The two most frequently used categorizations of situation types are those described by Lyons (1977) and Vendler (1967), or variations on these. Because we have some reservations about Vendler's categorization, we are adopting (our own version of) Lyons' taxonomy. This divides situations into four types: states, actions, events and processes. These can all be distinguished from one another by reference to just three parameters (i. e. three features of lexical aspect): [± static], [± evolving] and [± agentive]. As shown in the chart in section 1.42.5, states are static, nonevolving and nonagentive; actions are nonstatic, nonevolving but agentive; processes are nonstatic, evolving and nonagentive; and events are nonstatic, nonevolving and nonagentive.

1.55 Part VII

1.55.1 In part VII we introduced ‘**actualization aspect**’, i. e. the distinction between **boundedness** and **nonboundedness**. An actualizing situation may or may not be represented as coming to an end, i. e. as reaching a (natural or arbitrary) terminal point. It will be clear that boundedness is essentially concerned with the **right temporal boundary** of the actualizing situation, and it turns out that many elements may provide this boundary. For example, the object NP determines, respectively, the boundedness and nonboundedness of the (actualizations of the) situations represented by *Sylvia broke a window last night* and *Sylvia broke windows last night*. (In the latter example, although we can assume that in the extra-linguistic world Sylvia stopped breaking windows, there is no linguistic specification of a terminal point.) In some cases, boundedness is merely an implicature arising from the Gricean Maxims of conversation or from our knowledge of the world. In that case we speak of **W-boundedness**, in contrast with linguistically indicated **L-boundedness**.

1.55.2 We should distinguish on the one hand between (non)boundedness and (non)homogeneity and on the other hand between (non)boundedness and (a)telicity. While [+ bounded] and [− homogeneous] pick out identical sets of situations, and [− bounded] and [+ homogeneous] do likewise (so that it is not, for example, possible to have a situation which is [+ bounded] and [+ homogeneous]), the two features nevertheless refer to different aspects of those situations. (Non)boundedness refers to whether or not the actualization of the situation reaches a terminal point, while (non)homogeneity refers to whether or not the internal consistency of the situation is uniform, i. e. whether any (relevant) part of the actualizing situation is representative of the whole situation. The same symmetry does not exist when it comes to (non)boundedness and (a)telicity. It is possible for a telic situation-template (e. g. *climb over the wall*) to be used in a clause which represents the actualization of a situation as bounded (e. g. *She climbed over the wall*) and in one which represents the situation as nonbounded (e. g. *She was climbing over the wall*). This is because telicity deals with whether or not a type of situation is represented as *having* an inherent terminal point (which is a point of completion) whilst boundedness deals with whether or not an actualizing situation is represented as actually *reaching* a terminal point (which, depending on whether the situation is telic or atelic, may or may not be a point of completion).

1.56 Part VIII

Finally, in part VIII, we saw that the three different types of aspect (viz. ontological aspect, grammatical aspect and actualization aspect) interact so as to determine the aspectual meaning of a given sentence. For example, progressive

meaning, whether grammatically expressed or not, always produces nonbound-
edness, irrespective of whether the situation-template is telic (as in *I'm going
to write a book*) or atelic (as in *This time next year I'll be writing poetry*).

DEMO

DEMO

2. Towards a theory of tense and time

I. Introduction	93
2.1 Tense <i>vs</i> time	94
2.2 ‘Orientation time’ and ‘situation time’: provisional definitions	95
2.3 Tenses	95
2.4 Temporal zero-point (t_0)	97
2.5 Nonfinite clauses are tenseless	98
2.6 Progressive tenses?	99
2.7 Theoretical discussion: does English have more than two tenses?	100
2.8 Does English have a ‘future tense’?	102
2.9 Future tense forms <i>vs</i> ‘futurish’ tense forms	106
2.10 Does English have a present perfect tense?	108
2.11 More on the notion of temporal zero-point (t_0)	110
2.12 Full situation <i>vs</i> predicated situation	113
2.13 Time of the predicated situation <i>vs</i> time of the full situation	116
2.14 Orientation time	117
2.15 The semantics of tenses: temporal domains	119
2.16 Kinds of temporal relations	121
2.17 Expanding a temporal domain: expressing T-relations	123
2.18 Temporal relations that are not linguistically expressed: W-relations	125
II. Special uses of tense forms	128
2.19 Modal uses of tenses	128
2.20 Shifts of temporal perspective	129
2.21 Universal sentences	130
III. The role of temporal adverbials	132
2.22 Definition and basic classification of ‘temporal adverbials’	132
2.23 The function of a time-specifying adverbial	134
2.24 Situation-time adverbial	136
2.25 Orientation-time adverbial	137
2.26 Multiple-orientation-time adverbial	137
2.27 The relation between one Adv-time and another	137
2.28 Durative time-specifying adverbials referring to the present	138
2.29 Adv-time-simultaneity	139
2.30 Punctual Adv-times and durative bounded situations	140
2.31 The role of pure duration adverbials	142
2.32 Summary of section III	144
IV. The present and past time-spheres	147
2.33 The conceptualization of ‘time-spheres’	147
2.34 Defining the time-spheres	148
2.35 Present time-sphere zones	148

2.36	Visual representation of time-spheres and zones	149
2.37	Absolute zones	149
2.38	Past <i>vs</i> pre-present	150
2.39	The length of the time-spheres and zones	151
2.40	Present time-sphere tenses <i>vs</i> past time-sphere tenses	152
V.	Temporal domains	153
2.41	Absolute <i>vs</i> relative tenses	153
2.42	Temporal domain	153
2.43	Unexpanded domain	155
2.44	Absolute and relative past tenses	155
2.45	Past (time-sphere) tenses	156
2.46	Present (time-sphere) tenses	156
2.47	Absolute-relative tenses	156
2.48	Terminology: relative <i>vs</i> absolute-relative tenses	157
2.49	Temporal subordination or (temporal) binding	157
2.50	Temporal subdomain	158
VI.	Summary	161
2.51	The basic terminology of tense	161
2.52	What counts as a tense?	162
2.53	Full situation and predicated situation	164
2.54	What is (and is not) expressed by tenses	164
2.55	Special uses of tenses	166
2.56	Types of temporal adverbials	167
2.57	The conceptualization of time that tenses encode	168
2.58	Establishing and expanding temporal domains	169

DEMO

I. Introduction

Chapter 1 provided some general terminological and conceptual background preparatory to looking at tense in English. In chapter 2 we set out the fundamental elements of a theory of tense and time.

In part I (2.1–18), we briefly discuss the distinction between tense and time, and the distinction between tense, tenses and tense forms. We provide working definitions of three related temporal concepts: ‘orientation time’, ‘situation time’, and ‘temporal zero-point’ (t_0), which is nearly always speech time. These crucial concepts, whose provisional definitions are refined later on, enable us to describe how a situation can be temporally related to another situation or to the temporal zero-point by the use of a particular tense. In part I, we also touch on various general questions about tenses in English, including the question whether English has only two tenses – the present and the past tense – and whether it has a future tense. Part I further introduces some more key distinctions. We distinguish between ‘full situations’ and ‘predicated situations’, noting that only predicated situations are relevant when we discuss how tense forms locate situations in time. We distinguish between ‘absolute tenses’ and ‘relative tenses’, which jointly play a role in the definition of what we call a ‘temporal domain’ (a notion that is discussed more fully in part V). Finally, we distinguish between ‘T(ense)-relations’, ‘Adv(erbially indicated)-time-relations’ and ‘W(orld)-relations’, referring to whether a situation time is temporally linked to another time by direct linguistic means (tenses or temporal adverbials) or not (in which case the interpretation of temporal relations is largely based on the hearer’s knowledge of the world).

In part II (2.19–2.21), we mention some special uses of tenses, such as the modal past, as in *I wanted to ask you a favour*, uses involving a so-called ‘shift of temporal perspective’, including the well-known ‘historic(al) present’ as in *Suddenly this man walks in ...*, and the present tense in universal sentences, as in *Two and two is four*.

Part III (2.22 – 2.32) is concerned with the various kinds of interactions between tenses and temporal adverbials, and, especially, those between types of situations and temporal adverbials. For example, we argue that the representation of a durative bounded situation can combine with a punctual time adverbial (e.g. *At seven o’clock he ate a three-course dinner*) only on a special interpretation.

Part IV (2.33–2.40) is devoted to the way in which the English tense system divides up time into what we refer to as the ‘present time-sphere’ and the ‘past time-sphere’, the former of which is further divided into three separate ‘time-zones’.

In part V (2.41–2.50) we take a closer look at the concept of ‘temporal domain’. As pointed out above, this concept involves the distinction between

absolute and relative tenses, which are used to link a situation time to the temporal zero-point or to another orientation time, respectively. For example, in a sentence like *John said he had worked hard*, a past temporal domain is established by the past tense, which linguistically represents the time of John saying something as anterior to t_0 and which is therefore an absolute tense. The past domain is then expanded by the past perfect, which linguistically represents the time of the ‘working hard’ situation as anterior to the time of the saying situation and which is therefore a relative tense.

Finally, part VI provides a summary of the chapter.

2.1 Tense *vs* time

A tense is the pairing of a morpho-syntactic form with a meaning, the meaning being the specification of the temporal location of a situation. Thus, in the future tense, the form ‘*will* + present infinitive’ is paired with the meaning ‘location after speech time’. A tense relates the temporal location of a situation to the temporal zero-point – usually speech time – or to some other known time which is itself related either directly or indirectly to the temporal zero-point.

As we have seen in chapter 1, it is important not to confuse tense with time. Time is an extralinguistic category, i. e. it exists independently of language. (So, many million years ago time existed – and we refer to it in sentences like *This rock was formed many million years ago* – but there were not human creatures nor languages yet.) The term ‘tense’ is a linguistic concept: it has to do with the phenomenon that a language has different verb forms corresponding to the different ways in which a speaker can locate the actualization of a given situation in time. More specifically, ‘tense’ refers to the role of specific verb forms in a given language to locate situations in time.¹ That is, as a grammatical category, tense consists of the combination of grammatical form and meaning. Since the only way to locate a situation in time is to take a point in time whose location is known, and then locate the situation in relation to this point, this means that any tense linguistically expresses the temporal relation between the time of actualization of a situation and some other time, which may be the temporal zero-point (which is normally the moment of speech) or some other ‘time of orientation’ (i. e. time to which another time is related by a tense –

1. A more refined definition will be given in section 2.13.2, after some technical notions have been introduced. We will say there that tense is ‘the grammatical expression of the temporal location of the actualization of a predicated situation’.

see 2.2), such as the time of another situation. Thus, in the sentence *John said that Bill had left*, the past tense form *said* locates the actualization of the situation of John speaking at a time which is conceived of as a past time, i. e. as a time of orientation (or ‘orientation time’) which lies completely before the moment of speech. The past perfect form *had left* expresses that Bill’s leaving actualized before John’s utterance; the time of the latter situation is thus the orientation time to which the time of Bill’s leaving is represented as anterior.

2.2 ‘Orientation time’ and ‘situation time’: provisional definitions

Provisionally, an orientation time is a time to which the time of a situation can be related by a tense form. A situation time is also an orientation time.

Any time to which the time of a situation can be temporally related by a tense is an **ORIENTATION TIME**. The time of a situation can always function as the orientation time to which the time of another situation is temporally related by a tense. For this reason we could refer to the time of a situation as the ‘situation orientation time’, but to keep things simple we will use the term **SITUATION TIME**. This is the time of a situation as it is located in time by a tense form (i. e. as it is temporally related to speech time or to another orientation time) and to which the time of another situation can be temporally related by a tense form. (The word *can* makes it clear that a situation time need not be an actual orientation time; it may also be a potential one, as in the independent sentence *John left*.)² See 2.14 for a more elaborated technical definition of ‘situation time’.

2.3 Tenses

A tense expresses a tense structure. A tense structure is a blueprint for one particular way of locating a situation in time. The structure expresses the temporal relation(s) between the situation time and one or more orientation times. For every tense structure

2. In one-clause sentences the situation time never functions as orientation time. An example of an orientation time which is not a situation time is the time indicated (in the sense explained in 2.16.1) by *at five* in *John will already have left at five*.

that can be expressed, we can talk of a matching tense. A tense form may be an inflected main verb or a main verb plus one or more auxiliaries.

2.3.1 The various grammatical expressions of location in time which constitute the linguistic category ‘tense’ are ‘tenses’. A **TENSE** is the linguistic expression of a particular temporal meaning by a particular form (a ‘tense form’). In English, as in most languages that have tense, this is a form of the verb. The particular temporal meaning expressed by a tense is a **TENSE STRUCTURE**. This is the temporal structure (minimally involving a situation time, an orientation time and a temporal relation between them) which represents a specific way of locating a situation in time. We will argue that each tense has an invariant meaning. It follows that there are as many tenses as there are tense structures that can be expressed by tense forms of the verb. Thus, in English, *does, has done, had done, will do, will have done*, etc. are all verb forms expressing different tenses. Tenses represent a pairing of form and meaning.

2.3.2 A **TENSE FORM** can be either a simple or a complex verb form. That is, it may consist of one constituent (the main verb) only or be a phrase involving one or more auxiliaries next to the main verb. We can distinguish the following possibilities:

- (a) ‘verb stem + present or past tense morpheme’ (*helps, helped*)
- (b) ‘[verb stem of perfect tense auxiliary + present or past tense morpheme] + past participle’ (*has helped, had helped*)
- (c) ‘[verb stem of future tense auxiliary + present or past morpheme] + present infinitive’ (*will help, would help*)
- (d) ‘[verb stem of future tense auxiliary + present or past morpheme] + perfect infinitive’ (*will have helped, would have helped*)
- (e) combinations involving both the perfect tense auxiliary and the future tense auxiliary *will* and/or the ‘futurish’ (see 2.9) semi-auxiliary *be going to* (e.g. *has been going to help, would have been going to help*, etc.).

These five kinds of expressions of tense will all be referred to as ‘tense forms’. Every one of them can be interwoven with the progressive marker ‘*be + V-ing*’, which expresses progressive aspect, not tense (see 2.6).

2.3.3 The most common tenses in English are traditionally indicated by the following terms:

- (a) the present tense: *I live here / I am living here.*
- (b) the past tense (or preterite):³ *I lived there / I was living there.*

3. In Am. E. the term *preterite* is spelled *preterit*.

- (c) the future tense: *I'll go there / I'll be going there.*
- (d) the present perfect: *I've lived here / I've been living here for ages.*
- (e) the past perfect (or pluperfect): *I had lived there / I had been living there for ages.*
- (f) the future perfect: *I will have left by then / By then she will have been living in London for some time.*
- (g) the conditional tense: *We would soon find out / The next day he would be working on his thesis.*
- (h) the conditional perfect: *She would have left by then / By then she would have been living in London for some time.*

However, there are other tenses, indicating more complex structures, for which there are no traditional names. Examples of these are the 'complex relative' (see 1.18.3) tenses expressed by the tense forms in the following sentences:

[The council already adopted one version last month. The landlords spend [sic] a fortune to [...] wipe out that plan.] So this Tuesday night the council *will be going to do* a second plan, as a compromise. (www)

You've been going to pay me back for ages [but I still haven't seen a penny].

[The bottom line is what Celtic did to me last Monday is not the way to treat people who have done what I have done for the club. They stabbed me in the back when] they said they *had been going to sack* me anyway. [I can't understand why they said that. No one ever said it to my face.] (COB)

Moreover, we will argue that there are actually two past tenses in English: the 'absolute past tense' and the 'relative past tense' (see especially 8.23–32).

2.4 Temporal zero point (t_0)

The temporal zero-point is the time from which all the temporal relations expressed by a tense ultimately take their starting point. It is usually speech time. Thus in *He had left when I arrived*, the structure of the past perfect tells us that *had left* locates the leaving relative to (more specifically, prior to) a time which is itself located relative to (more specifically, prior to) speech time. English treats t_0 as punctual.

By **TEMPORAL ZERO-POINT** or **ZERO-TIME** (abbreviation: t_0) we mean the time which is the ultimate 'origin' of all the temporal relations expressed by the temporal structure of a tense, i. e. the only time in a tense structure that is not itself represented as dependent on another (more basic) time. It is the only time that is given ('assumed known') whenever a sentence is uttered. In English, the

temporal zero-point is nearly always the encoding time, i. e. the time of uttering or writing the message. (Exceptions will be dealt with in 2.11.1.) Another feature of English is that it conceives of t_0 as punctual (nondurative).

2.5 Nonfinite clauses are tenseless

Because nonfinite verbs carry no indication of their (ultimate) temporal relation to t_0 , they can never be said to be tensed. However, a situation denoted by a nonfinite clause is interpreted as temporally related to some other time in the context (as simultaneous with it, for example, in the case of a present participle, or as anterior to it, for example, in the case of a past participle).

It follows from our definition of tense and tenses in 2.1 and 2.3 that nonfinite clauses must be treated as tenseless (untensed), because they lack the present or past tense morpheme and therefore fail to express present or past time reference. (They can express simultaneity or anteriority, but that is a different matter – see 1.11.1.) Only finite verb forms are tense forms. Nonfinite forms do not belong to the tense system, in which all the temporal relations expressed ultimately find their origin in the temporal zero-point (which is usually the moment of speech – see section 2.4). Though nonfinite verb forms express one temporal relation, they do not express a full tense structure which necessarily hinges on the temporal zero-point (t_0). A nonfinite verb form simply relates the time of the situation referred to to some other, contextually given, time. The latter is mostly the time of the head clause situation, but (since t_0 is always given) it may also be the temporal zero-point:

The workers downing tools will be fired. (*The present participle downing expresses no more than simultaneity with another time, which may be the present (= time of speech) or a future time.*)

My late grandfather hated walking under a hot sun. (*The gerund form walking is interpreted in terms of simultaneity with the past time indicated by hated.*)

I {admit / admitted / will admit} having been in love with her. (*The gerund form having been expresses anteriority to the time of the head clause situation, irrespective of the latter's location in time.*)

Some people taken in by these confidence tricksters will lose everything they own. (*The past participle taken in means 'having been taken in' and expresses anteriority either to the time of the head clause situation or to the time of speech.*)

He claims to have been there. (*The 'perfect infinitive' expresses anteriority to the head clause situation.*)

The lack of tense morphology and the fact that when the participle expresses simultaneity with a time other than t_0 , it does not formally indicate the (past, future, etc.) nature of the time to which the time of its situation is temporally related, constitute solid evidence that participles are tenseless, even though they are either ‘perfect’ or ‘present’ in form, depending on whether the one relation they express is or is not that of anteriority. The same is true of the other nonfinite forms, viz. infinitives and gerunds. (In other words, verb forms are only tense forms if the main verb or the tense auxiliary involves an inflectional tense morpheme expressing a direct relation with t_0 .)⁴

2.6 Progressive tenses?

There are no progressive tenses – progressivity has to do with aspect, not tense – but there are progressive *verb forms* when progressive aspect combines with a tensed form. *She was climbing* contains a progressive past tense form.

2.6.1 The difference between the progressive form and the nonprogressive form is a matter of grammatical aspect rather than tense. Thus, both *walked* and *was walking* are past tense forms. The labels ‘progressive tenses’ and ‘nonprogressive tenses’ will therefore be avoided in this grammar. On the other hand, we will use phrases like ‘the past progressive’, etc., which refer to *verb forms* encoding both tense and aspect, but which do not confuse the different conceptual natures of tense and aspect.

2.6.2 Some grammars speak of the ‘continuous form’ or ‘*be + -ing*’ instead of the ‘progressive form’. The nonprogressive form is sometimes referred to as the ‘simple form’, but this is potentially confusing because ‘simple past’ and ‘past simple’ are more frequently used to denote forms like *said*, *was saying*, *went*, *was going*, *lived*, etc. In this use of the term, ‘simple’ distinguishes *said*, etc. from more complex forms like *had said*, *would say* and *would have said*.

In order to avoid confusion, we will not use ‘simple past’ in the latter sense: a form like *said* or *was saying* will be referred to as a ‘past tense form’ or ‘preterite’. Similarly, we will call *said* a ‘nonprogressive past tense form’ rather than a ‘simple past tense form’. And for the sake of simplicity, we will use only the former of the terms ‘progressive’ and ‘continuous’.

4. This also applies to ‘relative tenses’, which express a relation in a ‘temporal domain’ – see 2.15.3. Such tenses (e.g. the past perfect) contain an inflectional tense morpheme revealing the temporal location of the temporal domain relative to t_0 .

2.7 Theoretical discussion: does English have more than two tenses?

On the view that only forms marked for tense by inflectional morphemes qualify as tenses, English has only two tenses: past and present. There is also a view that the fact that English has two temporal perspectives, past and present (reflected in the morphological facts) supports the two-tense analysis. However, there is no *a priori* reason why complex (multi-word) forms should not be considered to be tense forms, and the fact that English has two temporal perspectives reflects (or is reflected in) the fact that it has two *sets* of tenses, not that it has only two tenses.

2.7.1 There are many linguists who disagree with the view (expressed in 2.3.1) that there are as many tenses as there are temporal structures represented by tense forms. These people hold that there are only two tenses in English, viz. the present and the past, because this is the only distinction that is expressed by inflectional morphemes (especially by suffixes, i.e. verb endings). However, there is no *a priori* reason for assuming that tense can only be expressed by bound (= inflectional) morphemes and not by free morphemes (viz. tense auxiliaries). On the contrary, there are several reasons why the view that English has only two tenses should not be adopted.

2.7.2 The claim that there are only two tenses in English is mainly based on two observations. The first is that the inflectional tense morphology of the verb only reveals a distinction between an inflected and an uninflected form. The inflected form (mostly realized as *-ed*) is used in the forms *walked*, *had walked*, *would walk* and *would have walked*, which are therefore all referred to as realizations of ‘the past tense’. The uninflected form (i.e. the form without the past tense morpheme) is used in the forms *walks*, *has walked*, *will walk* and *will have walked*, which are therefore all referred to as realizations of ‘the present tense’. The second observation underlying the claim that English has only two tenses is that there are only two temporal perspectives in English, viz. the past and the nonpast (present). What is meant by this is that English treats the distinction between past and nonpast as more important than the distinction between present and nonpresent (the latter including both the past and the future) or between future and nonfuture (the latter including both the past and the present). However, this view is essentially based on the observation that English tense forms show either past or nonpast morphology, so it is not clear to us in what way the second observation is different from the first.

However this may be, it is doubtful whether either of these observations necessarily leads to the claim that there are only two tenses in English. To

begin with, the observation that there are basically two temporal perspectives can lead us to conclude that there are two sets or kinds of tenses, but does not warrant the conclusion that there are only two tenses. (In French, where the future is morphologically marked, so that we must recognize the existence of a future tense in addition to a present and a past tense, we also find that there exist basically two temporal perspectives: past and nonpast. The nonpast perspective is therefore typical of a *set of tenses*, one of which is the future tense.) In other words, the observation that English and French (and most languages that have tense) treat the distinction of past and nonpast as being of greater importance than the distinction of present and nonpresent or future and nonfuture supports the view that the tenses in these languages are better subclassified into ‘past tenses’ *vs.* ‘nonpast tenses’ than into ‘present tenses’ *vs.* ‘nonpresent tenses’ or ‘future tenses’ *vs.* ‘nonfuture tenses’,⁵ but does not provide any evidence for the claim that these languages make use of only two tenses.

As to the observation that the inflectional tense morphology of the verb only reveals a distinction between past and present, there is no evidence that only inflectional morphology is criterial to the designation of a form as a tense form. It is well-known that it is often the case that one and the same meaning is expressed morphologically in one language and by means of an independent morpheme in another. The definite article is a free morpheme in English, but it is a suffix in Swedish. Many languages use suffixes to express relations which are expressed by means of prepositions in English. Why should we not accept that some tenses can be expressed by inflectional morphemes while others make use of free morphemes (= auxiliaries) such as *will*? This question becomes particularly pertinent when we observe that in some cases an inflectional indication of tense has developed from an auxiliary. The modern French future tense suffix is a case in point: Latin originally had a ‘synthetic’ (i. e. inflectionally marked) future (e. g. *cantabo* – ‘I will sing’); later on this was replaced by the ‘periphrastic’ (= multi-word) or ‘analytic’ structure *cantare habeo* (literally: ‘I have to sing’), which itself ultimately agglutinated and developed into the modern French synthetic future *chanterai*. The French present perfect (*j’ai chanté*) has similarly originated as a periphrastic verb phrase which came to function as a marker of the perfect, but unlike the future, it has not been subject to synthesis but has remained analytic. These examples from French show that whether a tense is marked by an inflectional morpheme added to

5. Languages that have future and nonfuture tenses have a tense or set of tenses to refer to the future and a tense or set of tenses to refer to whatever is not future, i. e. the present and the past. Hopi and Dyrbal are instances of such languages in which the basic distinction made by the tense system is between the future and the nonfuture. We do not know of any languages that have a tense system based on the distinction between the present and the nonpresent. If such languages exist, they use the same tense form(s) to refer to the past and to the future, both of which are ‘nonpresent’.

the verb stem or by a special auxiliary (e.g. *will*) is the result of a historical development determined by arbitrary factors that have nothing to do with the essence of the phenomenon of tense itself: the morphological changes were not accompanied by semantic changes, i.e. they did not alter the ways in which the tense forms located situations in time. It is therefore unwarranted to claim that tenses can only be marked by an inflectional morpheme (e.g. *-(e)s* or *-ed*) and not by a free morpheme such as an auxiliary (e.g. *will*).

2.7.3 Apart from the fact that they do not involve a particular inflectional tense morpheme, the present perfect and the future tense are often excluded from the English tense system on the basis of the claim that instead of expressing tense, they express ‘perfect aspect’ and ‘future (or: predictive) modality’, respectively. Sections 2.8 and 2.10 will be devoted to a refutation of this double claim.

2.8 Does English have a ‘future tense’?

A sentence that locates a situation in the future is always ‘modal’ inasmuch as it is by definition nonfactual and involves a (to varying degrees) subjective judgement about the likelihood of the future situation’s actualizing. However, in many cases, ‘*will* + present infinitive’ is used primarily to express the future temporal location of the situation referred to. The fact that this can be the main purpose of the form justifies its status as a tense form. We distinguish between ‘pure future’ uses of *will*, ‘prediction’ uses of *will*, and ‘predictability’ uses of *will*, according to the degree of subjectivity involved in the use of the form. All are instances of future tense. Predictability *will* takes a future time as the evaluation time for a statement about (usually) the present or the past. (For example, *Don’t worry, he will have taken a taxi home* is equivalent to ‘It will become clear when we know the facts that he {has taken / took} a taxi home.’)

2.8.1 The claim that **THE FUTURE** “is not a tense at all, but a mode” (Cyan 1972: 9) is unwarranted, because it is an overstatement. The future tense is often used for no other apparent purpose than to locate the time of a situation in the future. We will argue that in *The train will arrive at 7.32* the form *will arrive* serves primarily to locate the train’s arrival in time and therefore satisfies the definition of a tense form given in 2.3.1. This is not to say that we do not recognize the fact that the future tense has modal aspects of meaning, more specifically ‘not-yet-factuality-at- t_0 ’ and subjectivity. Whatever is still to actualize is not yet a fact at t_0 . ‘Not-yet-factual at a given time’ is a modal notion. An utterance about a situation that has not yet held is also of necessity “a subjectively modalized utterance: a prediction rather than a statement” (Lyons

1977: 815). True as this may be, the presence of elements of epistemic modality in *will* do not alter the fact that, in the above example *The train will arrive at 7.32*, the primary aspect of meaning of *will*, and the basic reason for its use, is that it locates the situation referred to in the future. Since this function of *will* satisfies the definition of ‘tense’ given in 2.3.1, and ‘*will* + present infinitive’ satisfies the definition of ‘tense form’ given in the same section, we claim that there *is* a future tense in English.

Because a future situation is by definition not-yet-factual-at- t_0 , and because any sentence about the future must to some extent be an expression of the speaker’s (subjective) judgement or belief, there is always an element of epistemic modality in the meaning of the future tense: no use of *will* is purely temporal. However, some uses are close to it because they do not appear to involve subjectivity, i.e. they do not clearly express a judgement on the part of the speaker. These very low subjectivity uses of *will* to locate a situation in the future will therefore be called ‘pure future’ (see 2.8.2) and will be taken as evidence that *will* in all its uses in which the situation is located in the future, is a future tense, but with instances of use varying in the degree of (remaining) modal meaning.

2.8.2 Self-evidently, the modal idea ‘not-yet-factual-at- t_0 ’ is invariably present when there is reference to the future. However, the implication of subjectivity, i.e. of speaker’s judgement, can vary considerably. We can roughly distinguish between ‘PURE FUTURE’, ‘PREDICTION’ and ‘PREDICTABILITY’. Pure future is the least subjectified, because it comes closest to a statement of plain fact. That is, the speaker just locates the time of a situation in the future without there being a clear implication that it is his own expectation, volition or conclusion that the situation is going to actualize in the future.

The seventh annual European Biotech Crossroads – “Biotech Nantes 2003” – *will be held* at the Cité des Congrès conference centre, Nantes, France, on September 25–26. (www)

The inquest *will be* the first official public hearing in Britain to examine the circumstances surrounding the death of the princess and her boyfriend. (www)

‘Prediction’ and ‘predictability’ involve a (respectively weaker and stronger) sense of expectation based on deductive or inductive reasoning. The following sentence can help to make the distinction clear:

(1) If there’s a knock at the door, it’ll be the milkman.

This sentence can be interpreted in two ways, depending on whether the *if*-clause is interpreted as expressing an ‘open condition’ or ‘closed condition’. (A condition is open if it is treated as one which may or may not be fulfilled in the future; it is closed if the speaker treats its fulfilment as a fact. In the latter

case the *if*-clause is normally echoic.) The two readings of (1) can be paraphrased as follows:

- (2) It is possible that there will be a knock at the door. If so, I predict that it'll be the milkman.
- (3) You tell me there's a knock at the door. If so, it is predictable that it is the milkman.

On reading (2), the speaker of (1) uses the future tense to make a prediction about the future; on interpretation (3), he uses *will* to express the predictability of a conclusion concerning a present situation. The epistemic aspect of meaning is clearly strongest in reading (3). 'Prediction' concerns an assumption about the actualization of a situation in the future (or, in the case of *would*, actualization at a time posterior to the time of making the prediction). 'Predictability' is a more strongly epistemic notion in that it concerns the speaker's assumption of the strong plausibility of a conclusion. This conclusion usually concerns the past or present, seldom the future. (In 2.8.3 it will be argued that this statement only seemingly contradicts the claim – made in 2.8.1 – that predictability *will* is also an instance of future tense *will*.) Whereas in sentences with a first person subject in which *will* expresses pure future or prediction, *shall* can be substituted for *will*, it is not as a rule possible to substitute *shall* for first-person *will* when *will* expresses predictability:

["Who wrote this incomprehensible nonsense?" – "I did. It may be incomprehensible, but it's not nonsense."] I *will* / *shall* have used too many difficult words, as usual."

So, prediction *will* is closer to pure future *will* than to predictability *will*.

In practice, the distinction between 'prediction' and 'predictability of a future situation' is often difficult to make. If the reference is to a specific future situation, both prediction and predictability concern a statement that is based on a present expectation. Though one could say that the expectation in question is based on evidence in the case of predictability, whereas it need be no more than an assumption in the case of prediction, it may actually be hard to distinguish between the two interpretations. Consider the following sentence:

- (4) If you don't do your homework, you *will* fail the exam.

There is certainly a case for treating *will* as a prediction form here, since we can use *shall* in the corresponding first person sentence:

- (5) If I don't do my homework, I *shall* fail the exam.

However, apart from the prediction reading 'If you don't do your homework, I assume that you will fail the exam', (4) can also be interpreted as 'If you don't do your homework, it is predictable that you will fail the exam' (= predictability). There is no clear-cut borderline between these interpretations.

In conclusion, our ‘future tense’ will cover not only the ‘pure future’ interpretation but also the ‘prediction’ sense and the ‘predictability’ meaning of *will*.

2.8.3 It is clear from 2.8.1 and 2.8.2 that we agree that there is an epistemic modal aspect of meaning in the future tense,⁶ and that we assume that *will*-forms with the weak or strong epistemic connotation of pure future, prediction or predictability can all be treated as future tense forms. In doing so we follow Declerck (1991: 87), who argues that the use of *will* for predictability – a use which is traditionally treated as modal rather than temporal – can in fact be analysed as the use of future tense *will* in order to put the ‘temporal focus’ on a future time of evaluation. The idea of ‘temporal focus’ will be dealt with at length in 11.1–3, but is in fact clear from the following examples:

I spoke to the foreigner in French because he *didn’t understand* English. (*The foreigner presumably still does not understand English, so the speaker could have used doesn’t understand. Using the past tense, however, he focuses on the time when he spoke to the foreigner rather than on t₀.*)

Bill finally saw the town, which *lay* in a wide valley. (*The town still lies in that valley, but putting the temporal focus on the past time when Bill saw the town is a means of representing things as Bill experienced them, i.e. from his point of view.*)

I {need / will need} a stamp for this envelope. (*With will need the speaker focuses on the future time when he will make the envelope ready to be sent off.*)

These examples show that tense forms can reflect a choice, not only of temporal location of a situation relative to another time, but also of point of view (temporal focus). Predictability *will* can be explained similarly as a result of putting the temporal focus on a future time of evaluation:

They will be across the border by now.

(*when the bell rings*) That will be the milkman.

This car will have cost a good deal, I suppose.

These uses of *will* can be explained as cases in which the temporal focus is shifted from the present to the future. Instead of simply claiming that a situation is actualizing at t_0 , the speaker suggests that it will become apparent in the future that the situation was actualizing at his present t_0 . That is, the speaker takes a future time of orientation (rather than t_0) as the time at which the truth of the statement is evaluated. Needless to say, the idea of a future evaluation time is essential to these uses of *will*. Sentences like those above are

6. Epistemic modality has to do with the speaker’s expression of the degree to which he thinks a statement is true. A statement can be represented, e.g. as likely (*He may well do it*), as possible (*He might do it*), as contrary-to-fact (*He might have done it*). The epistemic modality expressed by the future tense is the idea ‘not-yet-factual at t_0 ’ (see 14.4.2): the future situation is not yet a fact at t_0 , when the prediction is made.

not interpreted as asserting a fact, but rather as expressing a belief which is expected to be confirmed in the future. *That'll be the milkman* implies something like 'as you will see when you open the door'. Such a temporal, rather than modal, analysis of *will* accords with the fact that the French future tense, which does not involve the use of an auxiliary, can be used in exactly the same way: *Ce sera le laitier* ['It will be the milkman'].

2.9 Future tense forms vs 'futurish' tense forms

Some forms in English have dual time reference: forms such as *be about to*, or the present progressive in *I'm leaving in a minute*, or, in some of its uses, *be going to* refer to the time of an implied present state (which is one from which a future outcome can be predicted) as well as to the time of a future situation. It is the actualization of the future situation which is the outcome predictable from the present state. Only the future situation – the one associated with the lexical verb – is actually referred to. Such verb forms establish a future domain but are not future tense forms. We call them futurish forms. '*Be going to* + verb' may be a futurish form and it may be a future tense form, depending on whether it has 'pure future' time reference or also implies a present state. (There is no clear cut-off point between the two uses.)

2.9.1 Apart from the future tense, which (from a temporal point of view) does no more than locate a situation in the future and which therefore has 'single time reference' (i.e. future time reference only), there are also verbal expressions which would seem to effect 'dual time reference', viz. a combination of future time reference and present time reference. Such expressions will be referred to as **FUTURISH** tense forms. These forms link the future actualization of a situation to a particular kind of present state. For example:

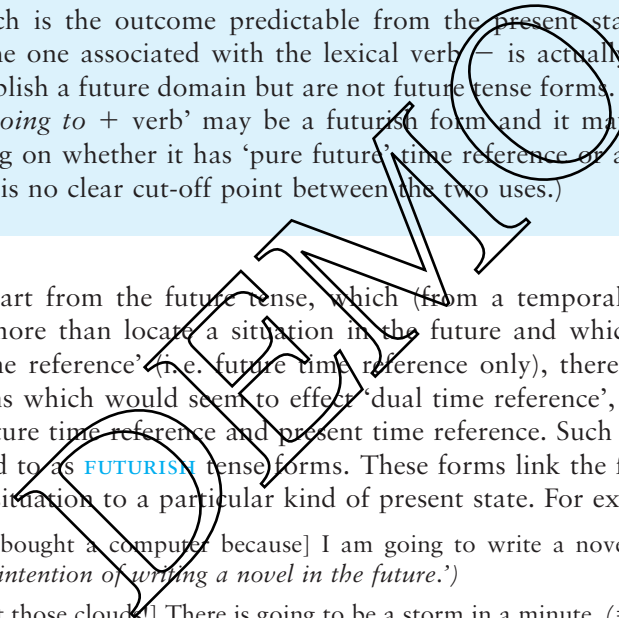
[I have bought a computer because] I am going to write a novel. (= '*I have the present intention of writing a novel in the future.*')

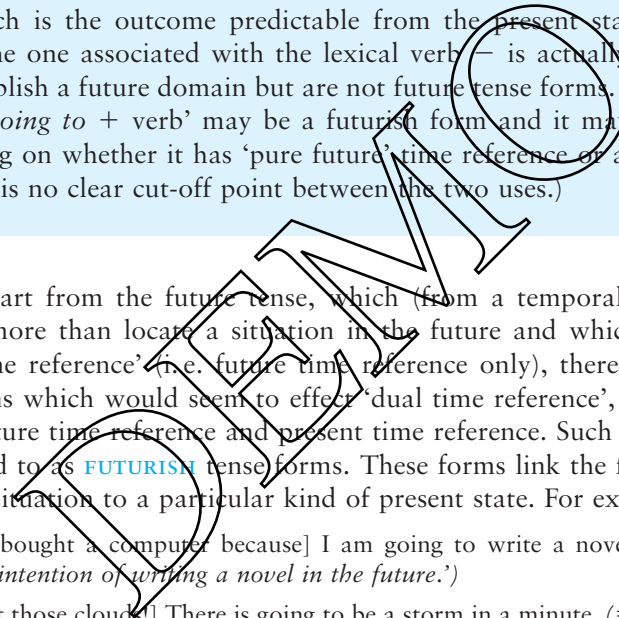
[Look at those clouds!] There is going to be a storm in a minute. (= '*There are signs in the present that there will be a storm soon.*')

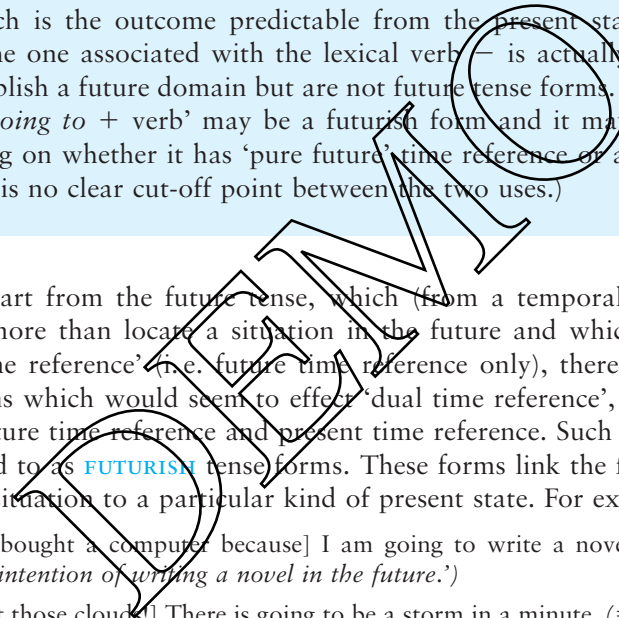
I'm leaving in a minute. (= '*There is a present arrangement for me to leave in a minute.*')

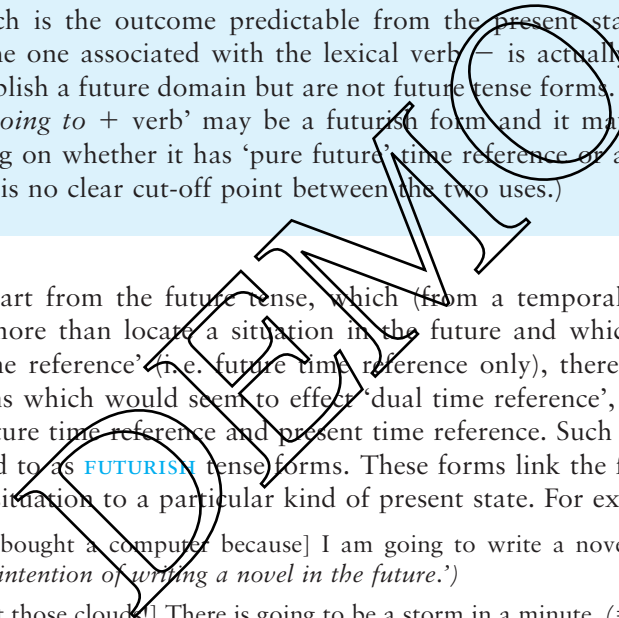
[Look at her!] She is about to faint. (= '*You can see now that she will faint in the very near future.*')

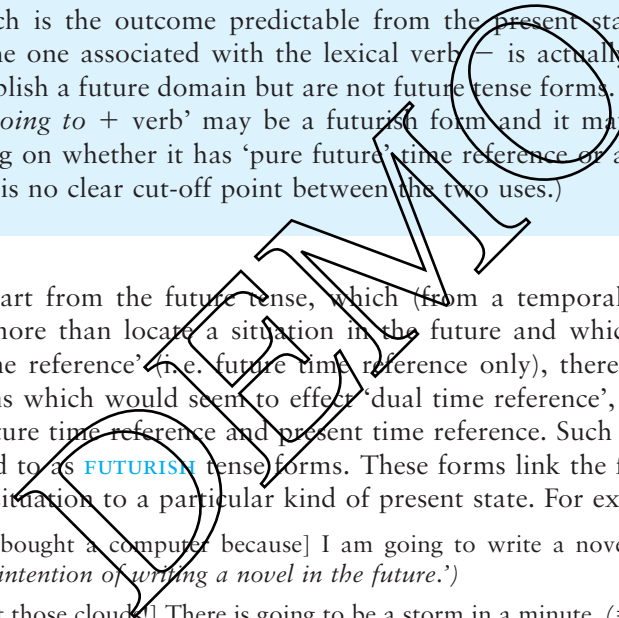
The Queen is to leave for Canada tomorrow. (= '*There is an official decision that the Queen will leave for Canada tomorrow.*')

In the last three examples, the forms *am leaving*, *is about to faint* and *is to leave* will not be treated as lexical realizations of the future tense. However,

they are ‘futurish’ forms because they clearly locate the situation of leaving or fainting in the future (and in doing so establish a future ‘temporal domain’ – see 2.15).

As to *be going to*, this auxiliary has two uses when it is used in the present tense: one as a futurish form, in which its primary meaning has to do with present factors, such as present intention, as in *I’m going to pick the lock*, and one as a future tense form, in which its primary meaning is simply future time reference, as in *Tomorrow the weather’s going to be better than it’s been today*. In the first function it parallels other futurish forms like *am leaving*, whose primary meaning is present time reference. In the second function it parallels *will* (as future tense auxiliary), which simply expresses future time reference – see 2.9.2. The only difference is that *be going to* is less grammaticalized as a marker of future tense than *will* is, since it is more frequently found with predominantly present time reference. (Though there are clear enough examples of futurish *be going to* and clear enough examples of future tense *be going to*, there are of course intermediate cases that do not fall so clearly into the one or the other sort of *be going to*.)

The observation that futurish forms link the future actualization of a situation to a present state and therefore have ‘dual time reference’ does not mean that they refer to two different situations (one present, the other future). Only lexical verbs can denote situations. All the futurish forms contain only one lexical verb, which refers to the situation that is located in the future. In this respect a sentence like *I’m going to help her* differs from (the semantically similar) *I intend to help her*, which involves two lexical verbs and therefore refers to two different situations.

2.9.2 In English, the prototypical realization of the future tense involves *will* (or, in the first person, *shall*). However, as we have seen above, the auxiliary *be going to* can sometimes also express ‘pure future’, which means that we must recognize ‘*be going to* + present infinitive’ as a possible (albeit less prototypical) realization of the future tense. In the following examples there is no real difference of meaning between *will* and *be going to*:

Tomorrow there {*will be / is going to be*} frost in the northern part of England.

{*Will she be / is she going to be*} there? I wonder.

How many of these animals {*will survive / are going to survive*} winter is anybody’s guess.

Our decision to treat such *be going to*-forms as (less prototypical) lexical realizations of the future tense is in keeping with (some of) the literature: in spite of the fact that *be going to* and *will/shall* are not always interchangeable, some researchers have argued that they do have the same basic temporal meaning. After investigating the use of the future tense and the *go*-future in a variety of

languages, Fleischman (1982: 97) concludes that her findings “militate strongly in favour of regarding the *go*-paradigm as a legitimate future-tense form”. Haegeman (1989: 291) similarly argues “that at the level of sentence meaning *be going to* and *shall/will* are equivalent, and that the difference between them is to be found in the constraints they impose on the processing in context of the utterance in which they occur”.

The claim that the *will/shall* future tense is more prototypical than the *be going to* future tense accords with the following observations. First, in Standard English, the future perfect is nearly always formed with *shall* and *will*, very seldom with *be going to* (as future tense form) and never with a futurish form. Compare:

John {will take / is going to take / is taking / is about to take} the bus in five minutes.

John {will have taken / ?is going to have taken / *is having taken / *is about to have taken} the bus by the time we reach his office.

Secondly, *shall* and *will* are the auxiliaries that combine with a progressive infinitive to form progressive future tense forms. Progressive future tense forms built with *be going to* are very seldom used and are restricted to an informal register:

This time tomorrow I {will / ??am going to} be driving to London.

2.9.3 In sum, we will work with the following assumptions:

- (a) There does exist a future tense in English. This tense has future time reference only.
- (b) English also has ‘futurish’ forms. These have dual time reference in the sense that, semantically, they link the future actualization of a situation to a present state.
- (c) The prototypical realization of the future tense is by means of *will / shall*. A secondary, less prototypical realization of the future tense is by means of *be going to*. The latter can also be used as part of a futurish form.

2.10 Does English have a present perfect tense?

Some authors consider that the English present perfect is not a separate tense, but is rather a combination of another tense (present or past) and an aspectual meaning component of ‘current relevance’. However, since we analyse the present perfect as having a tense structure different from that of the present tense or the past tense, we consider it to be a tense in its own right. The present perfect locates a situation in the

pre-present zone while the past tense locates it in the past zone. The claim that the present perfect has a different temporal structure from the past tense is supported by the fact that the two tenses behave differently with certain adverbs. (In chapter 6 it will be shown that certain adverbials referring to a time that is connected to the present combine with the present perfect but not with the past tense, and that adverbials referring to a bygone time that is dissociated from the present combine with the past tense but not with the present perfect.)

2.10.1 It is often claimed that a form like *has arrived* is not a *present perfect tense* form but rather expresses ‘perfect aspect’. In this view there is no present perfect tense in English. The so-called ‘present perfect’ is claimed to be a combination of a genuine tense (the present tense for some, the past tense for others – see below) and a special kind of aspect, viz. ‘perfect aspect’, which is expressed by *have ... -en*. The meaning of ‘perfect aspect’ is defined in terms of ‘current relevance’ (i. e. the anterior situation referred to by *have ... -en* is still relevant at the time to which it is represented as anterior), which is sometimes narrowed down to ‘resultant state’: *John has arrived* represents John’s arrival as still relevant at t_0 , or expresses the resultant state ‘John is here’. This definition of the present perfect is essentially aspectual: the perfect focuses on the fact that the situation is finished and on the ensuing resultant state (in the same way as the progressive focuses on the middle of a situation).

It is striking, however, that there is no unanimity as to which ‘genuine’ tense – present or past – is realized by forms like *has come*. Whereas some linguists (e. g. Palmer 1988: 35) claim that the present perfect is a combination of the present tense with ‘perfect aspect’ (or ‘perfect phase’), others (e. g. Comrie 1985: 78) claim that the present perfect realizes the same temporal structure as the preterite and differs from the latter only in that it also expresses ‘perfect aspect’ (defined as ‘current relevance’). These claims cannot both be true. In fact, we will argue in 5.1–2 that the present perfect minus ‘perfect aspect’ yields neither the temporal schema of the present tense nor that of the preterite. The present perfect realizes a temporal structure of its own, and should therefore be considered a tense in its own right.

2.10.2 In 2.33–37 we will argue that the preterite, the present perfect tense and the present tense locate the time of the situation referred to in three different ‘time-zones’, viz. the ‘past’, the ‘pre-present’ and the ‘present’. (The past is conceived of as lying completely before t_0 and as disconnected from it; the pre-present is conceptualized as a period leading up to t_0 ; the present zone is restricted to t_0 itself.) Since these are three different ways of locating a situation in time, the three forms represent three different tenses – see the definition of ‘tense’ and ‘tense forms’ in 2.1 and 2.3.

The choice between locating a situation in the past and locating it in the pre-present is determined by whether the speaker is concerned with ‘THEN’ or ‘NOW’. Concern with NOW is equivalent to ‘current relevance’ – see 5.35, (but not necessarily to ‘present result’ – see 5.36). We therefore agree with the claim that the present perfect expresses current relevance, but do not see this as evidence for the claim that the present perfect is not a tense. The present perfect is a tense because, by locating a situation in the pre-present rather than the past or present, it expresses a temporal structure which is different from the semantic structure of any other tense.

The above view is consistent with the fact that the past tense, the present perfect tense and the present tense differ as to their compatibility with adverbs like *still* or *already*. This shows that the meaning of the present perfect is neither ‘past tense + current relevance’ nor ‘present tense + current relevance’.

It was five o’clock. John {was still / *has still been} in his office.

It is five o’clock. John {is still / *has still been} in his office.

It was five o’clock. John {was already / *has already been} in his office.

It is five o’clock. John {is already / has already been} in his office. (*If the present perfect is substituted for the present tense, we do not arrive at a meaning which is a combination of the meaning of the present tense and current relevance. Rather, the time reference of the clause is completely different: John’s being in his office precedes speech time rather than coinciding with it.*)

Clearly, the present perfect has a temporal meaning (semantic structure) of its own.

2.11 More on the notion of temporal zero-point (t_0)

Although the temporal zero-point (t_0) is nearly always speech time, in certain contexts it is possible for the speaker to choose the decoding time as t_0 . (For example, this is the case when a road sign reads *You are now entering Washington County*). Whether t_0 is the encoding time or the decoding time, English treats it as a point (rather than an interval). Thus, durative situations cannot be located in their entirety at t_0 .

2.11.1 In 2.4 we have defined t_0 as the time which is the ultimate ‘origin’ of all the temporal relations expressed by the temporal structure of a tense, i. e. the only time in a tense structure that is not itself represented as dependent on another (more basic) time. We have said that t_0 is the only time that is always given (‘assumed known’) when a sentence is uttered. We have also noted that in English the temporal zero-point is nearly always the encoding time, i. e. the

time of uttering or writing the message. In this section we will explain why t_0 is only ‘nearly always’ the encoding time: when the time of decoding (= hearing or reading) the message is later than the encoding time, it is possible for the speaker to choose the decoding time as temporal zero-point.⁷ The following are some typical examples in which the speaker makes use of the latter possibility:

- (a) Suppose you go to someone’s office and find a note on his door saying *I am in room 21*. In this case the time referred to by the present tense is not the time when the message was written but the time at which the message was expected to be read and interpreted. (If the note said *I have gone to room 21* the same remark would be applicable.) Road signs of the kind *You are now leaving East Sussex* constitute similar examples.
- (b) Most newspaper articles are written the day before the newspaper is on sale to the public, or earlier. In such cases, writers may use a tense system in which t_0 is not the time when the articles are written but the time of publication.

At the time of going to press, the two parties *were* still not decided as to whether the meeting should take place. (www) (*If t_0 were the author’s speech time, the appropriate form would be are still not decided.*)

The following example shows that this choice of t_0 is not obligatory:

At time of going to press, this software (named ‘PaTeAS’) *is* in the final stages of testing and should be available to a small group of users for field trials early in the new year. (www)

However, t_0 has to be the decoding time if there is a temporal adverb whose interpretation is shifted to the point of view of the reader. Thus, if someone dies on 23 July this may be reported (in a text written the same day for publication on 24 July) as *Yesterday X died*, but not as **Yesterday X dies*. Note that in this case the journalist selects as t_0 the official date of publication, since it is expected that most of the public are going to read the paper that day. Whoever reads the paper after that date must therefore compute the absolute deictic indications of time (i. e. the deictic adverb *yesterday* and the deictic tense form *died*) from the temporal standpoint of this publication time.

7. This double possibility concerning the choice of t_0 (temporal deictic centre) runs parallel with the double choice that is sometimes possible in connection with the spatial deictic centre. For example, verbs like *come* and *bring* allow the spatial deictic centre to lie either with the speaker or with the addressee:

(i) “*Come* and stay for the weekend and *bring* the children.” – “Thanks, we’d love to *come*. Can we *bring* the dog too?”

In the first sentence, *come* and *bring* imply movement towards the speaker’s deictic centre. In the reply they imply movement towards the addressee’s deictic centre.

- (c) Similarly, pre-recorded radio or TV programmes may take the hearing time as t_0 :

The programme you *are now listening to was recorded* yesterday.

The sound you *have just heard* is the mating call of the lesser spotted otter.

- (d) The writer of a letter may take the time of decoding as t_0 . Thus, in a letter which is written and sent before Christmas but which is expected to reach its destination only after Christmas, we may read such sentences as *I hope you had a nice Christmas*.⁸
- (e) The author addressing the reader of a book may take as t_0 the stage in the book where the reader has arrived.

Mention *has been* already *made* more than once, of a certain Dragon who swung and creaked complainingly before the village alehouse door. (CHUZ)

- (f) Descriptions of travel itineraries may also take the time of reading as t_0 .

Florence to Rome. This morning our local guide *takes* us on a walking tour to see the Duomo, Giotto's Belltower, Basilica of Santa Croce and Piazza della Signoria. Time to shop for silver and gold and see a demonstration of Florentine leathercraft, before we *continue* to the fabled city of Rome. Tonight a walking tour of this ancient city *includes* Piazza Navona, the Trevi Fountain the Pantheon and Piazza Venezia. (www)

Here, the reader is supposed to imagine himself (at the time of reading) on the trip, experiencing the itinerary as it unfolds.

- (g) Stage directions are typically written in the present tense. Here, t_0 is the time when the play actualizes (i. e. the time when it is read, rehearsed, acted, recalled in memory...). The same is true of sentences in which a character in a play is asking the audience to show patience or to applaud. For example, it would sound very silly if Shakespeare had written such lines in the future tense, locating the request in the future from his own deictic centre, so to speak.

In examples like these, absolute deictic temporal adverbials (i. e. adverbials like *now*, *yesterday*, *two days ago*, *today*, *tomorrow*, *the day after tomorrow*, which are interpreted as defining a time interval relative to t_0) are also related to the time of decoding the message.

2.11.2 In the real world, actions like speaking, writing, reading, etc. take up a certain time. Still, as a linguistic concept, t_0 is conceived of as a point in time

8. In Latin it was customary to use 'epistolary tenses' when writing letters. In this tense system, t_0 is the time of reception, and the past tense is used for any situation preceding this time, i. e. even for situations holding at the time of writing the letter. Thus we read sentences of the type *I was writing to you to tell you that ...* (where English would use *I am writing to you to tell you that ...*).

in English. Evidence for this is that durative situations cannot be located in their entirety at t_0 . A sentence like **You threaten me* cannot be used to locate a single (nonhabitual) situation at t_0 : we have to use *You're threatening me* instead. In the latter sentence the progressive form does not refer to the situation as a whole but rather to a point in the middle of the situation. It is this point that is located at t_0 – see section 3.1.1 for more details.

2.12 Full situation vs predicated situation

When we say that a clause is used to refer to a situation, we have to distinguish between the ‘full situation’ and the ‘predicated situation. The full situation is the complete situation that the speaker implies (or the hearer infers) has actualized, is actualizing or will actualize, however long it turns out to be or to have been. The predicated situation is the part of the full situation which is actually referred to in the clause used. The predicated situation – the linguistically indicated situation – and the full situation – the inferred situation – may coincide with one another, or the predicated situation may be shorter than the full situation.

The latter possibility is only available when the situation is represented as homogeneous. (In that case, an utterance that is true of the whole situation is also true of any part of the situation.) If a situation is bounded, as, for example, the situation represented in *Meg sat in the chair for ten minutes*, it is nonhomogeneous and the length of the predicated situation is the same as the length of the full situation.

2.12.1 When referring to a situation we must distinguish between the ‘full situation’ and the ‘predicated situation’. The **FULL SITUATION** is the complete situation as it actualizes in whatever ‘possible world’ (e.g. the actual world or the not-yet-factual future world) is being referred to; the **PREDICATED SITUATION** is that part of the full situation (possibly all of it) about which an assertion is made (or a question is asked) in the sentence. As is clear from *Ten minutes ago John was in the library* (which does not exclude the possibility that John is still there), it is the predicated situation rather than the full situation that is located in time by the use of the tense form. That is, the above sentence expresses no more than that John was in the library ten minutes ago. In the real world, John may have been there for a much longer time, i.e. the full situation almost certainly lasted much longer (and indeed may still continue at t_0), but the sentence does not make a claim about this. It only makes a claim about the predicated situation, i.e. that part of the full situation that coincides with the time indicated by *ten minutes ago*. This means that when we are concerned purely with the contribution of the tense form to the interpretation

of the sentence, the full situation is irrelevant. What a tense form locates in time (i. e. what a tensed clause *represents*) is the predicated situation.

The predicated situation (= the linguistically indicated situation) and the full situation (= the inferred situation) may coincide with one another, or the predicated situation may be shorter than the full situation. The latter possibility is only available when the situation is represented as homogeneous. (In that case, an utterance that is true of the whole situation is also true of any part of the situation – see 1.36.4). If a situation is ‘bounded’ (see 1.44), like, for example, the situation represented in *Meg sat in the chair for ten minutes*, it is nonhomogeneous and the length of the predicated situation is the same as the length of the full situation. That is, the speaker cannot say *Meg sat in the chair for ten minutes* and mean the hearer to infer that she sat there for longer. This is because of the fact that the situation has an end, and the length of time it took to reach that end are clearly communicated. The same applies to *Meg threw the chair*: both the fact that the situation has an end and the length of time it takes to reach that end are communicated linguistically, but here they are communicated implicitly via the meaning of *throw the chair*. It is in the nature of throwing a chair that the situation takes a few seconds at most and ends when the chair has been thrown. Because this end is part of the meaning of ‘throw the chair’, the speaker can only expect the hearer to infer the normal time it takes to reach that end – say, a couple of seconds – unless he specifies otherwise. If the speaker wants the hearer to understand that the chair-throwing went on for several minutes, (Meg threw the chair, picked it up, threw it again etc.) this must be clear from the context, either implicitly – for example *They competed as to who could hit the target most often with a piece of furniture. Jim threw the coffee table and Meg threw the chair* – or explicitly – *Meg threw the chair over and over at the spider, but she never managed to squash it*.

To sum up: since a bounded situation must take up a finite amount of time, it is necessary for the hearer to supply the amount of time taken up in order to reach a satisfactory interpretation. The hearer will assume a default length of situation associated with the lexical item(s) involved unless a different length of situation is specified (or otherwise made clear). That is, the clause used to represent a situation as bounded cannot imply a full situation longer than the situation actually referred to in the clause. Since the situation actually referred to in the clause is the predicated situation, it is inevitable that when a situation is represented as bounded, the length of the full situation will be the same as the length of the predicated situation.

2.12.2 It follows that it is only when the clause represents the situation as homogeneous that the predicated situation can be shorter than the full situa-

tion. As noted in section 1.36.4, a situation is represented as homogeneous if the clause representing it can be used not only to refer to the full situation but also to refer to parts of that situation. Homogeneous situations are either 'atelic' situations or 'telic' situations which are (intended to be) interpreted as progressive whether or not a progressive verb form is used. (For the definition of '(a)telic', see 1.39). Thus, in all of the following examples the situations are represented as homogeneous:

At 5 p.m. I was at home. (*atelic situation represented as being in progress at the 'vantage time' indicated by at 5 p.m.*)

At 5 p.m. I *was walking* home. (*idem*)

The sun *was shining*, birds *were singing* in the branches overhead, and the city *was generally at ease with itself*. (*similar, except that the vantage time is not referred to in the sentence itself*)

[Saturday had come at last. Jane was sitting on a low limb of an apple tree. It was a sunny June afternoon.] Flowers *bloomed*, birds *sang*, butterflies *flitted* everywhere. (www) (*The dynamic situations are interpreted as being in progress in spite of the fact that nonprogressive forms are used.*)

At that time I *walked* to work. (= *At that time I was in the habit of walking to work.*) (*A habit is a state: it denotes what is characteristic of the referent of the subject NP over an extended period of time.*)

The following is similar, except that the relevant verb form is a relative tense form:

[John said that] he *was ill*. (*The time of saying is much shorter than the time of the full situation of John being ill. Yet the two times are interpreted as simultaneous with each other. This is possible because he was ill is homogeneous: this makes it possible for the time of the predicated situation of John being ill, which is represented as coinciding with the time of saying, to be a proper subinterval of the time of the full situation of John being ill.*)

When the actualization of a situation is represented as bounded (see 1.44), the predicated situation coincides with the full situation and the clause is automatically nonhomogeneous (see 1.45):

I wrote two letters this morning. (*Because it is bounded, this sentence can only be a true description of the full situation; it cannot be used to represent any subpart of the full situation.*)

[John said that] at that very moment he {*was writing* / **wrote*} a book. (*The time of saying is much shorter than the time of writing the book. The sentence is fine with he was writing a book because the progressive form represents the telic situation as homogeneous. The sentence is ungrammatical with he wrote a book because this clause represents the situation as bounded and hence as nonhomogeneous. If this is the case, the predicated situation coincides with the full situation. Since the full*

situation of writing a book necessarily takes up more time than the situation of saying something, it is impossible for the time of the predicated (= full) situation to coincide with the time of the saying.)

2.13 Time of the predicated situation vs time of the full situation

2.13.1 The distinction between ‘full situation’ and ‘predicated situation’ leads to a further distinction between the ‘**TIME OF THE FULL SITUATION**’ and the ‘**TIME OF THE PREDICATED SITUATION**’. The latter is the (durative or punctual) time interval taken up by the predicated situation. It is the latter notion that we have in mind when we speak of ‘**SITUATION TIME**’ (see 2.2) in connection with tenses.⁹

[You can come tomorrow if you like.] I’ll be at home. (*It is possible that the speaker is at home at t_0 and will continue to be at home until and including tomorrow. However, the statement I’ll be at home does not say anything about t_0 : the predicated situation is located exclusively in the future. In other words, the interval taken up by the actualization of the full situation is irrelevant. What counts is the representation of the situation: will be represents the predicated situation as future. Other parts of the full situation, such as that coinciding with t_0 , are not being referred to.*)

2.13.2 It is important to see that by ‘time of the predicated situation’ (= situation time) and ‘time of the full situation’ we mean ‘time of the actualization of the predicated situation’ and ‘time of the actualization of the full situation’, respectively. This is especially relevant when the reference is to the future:

John {will / is going to / is to} be in Berlin tomorrow.

Every one of these verb forms locates the (predicated) time of the situation of John being in Berlin in the future: in each case the *actualization* of the predicated situation is located in the future. The fact that there is also a present aspect of meaning – there is a sense of present prediction, present intention, present decision – is irrelevant to this. It only means that reference to the future has an aspect of present modality (more specifically: ‘not-yet-factuality at t_0 ’ – see 7.4), but this is unrelated to the definition of ‘tense’ as the grammatical expression of the temporal location of the actualization of a (predicated) situation.¹⁰

9. This definition of ‘time of the situation’ (introduced in Declerck 1991a) is called ‘topic time’ in Klein (1992, 1994).

10. It follows that the predicated situation in *John will leave* is not a prediction – the prediction is the speech act. The predicated situation is ‘[future [John leave]]’, so what is future is not the situation of making a prediction but just the time reference that the

2.14 Orientation time

Any time that can provide the ‘known’ time (or one of the known times) required for the expression of the temporal relation(s) encoded in a tense form is an ‘orientation time’. For example, the past perfect has a structure which places the (time of actualization of the) situation earlier than some other time which is itself earlier than some other time. It requires two orientation times. Thus, in *I had left before the elephant arrived* the time of the arrival of the elephant provides the orientation time before which my leaving takes place, and speech time provides the orientation time before which the arrival of the elephant takes place. There are five types of orientation time: t_0 , situation times, unspecified orientation times (times which are recoverable from the context), Adv-times and implicit orientation times (times which are implicit in the structure of temporal conjunctions). An example of the latter can be found in *I will have left before the elephant arrives*. *Before* is analysed as meaning ‘before the time at which’. This means that our example is paraphrasable ‘I will have left before the time at which the elephant arrives’. This in turn means that the time of my leaving is analysed, not as located anterior to the elephant’s arrival, but as located anterior to a time simultaneous to which the elephant will arrive. It is thus located prior to an implicit orientation time – the time simultaneous to which the elephant will arrive – rather than anterior to a situation time – the time of actualization of ‘The elephant will arrive’.

Any time capable of functioning as the origin of a temporal relation expressed by a tense form will be called an **ORIENTATION TIME**. There are five types of orientation time:

- (a) The **TEMPORAL ZERO-POINT** is one kind of orientation time: in sentences like *I left yesterday*, the orientation time to which the time of the predicated situation is related (as anterior) is t_0 . Tenses that relate the time of a predicated situation directly to t_0 are called **ABSOLUTE TENSES** (see 2.41). The temporal zero-point is the most basic (unmarked) orientation time in the English tense system, as it is the only orientation time that is by definition given (assumed known).
- (b) An orientation time may also be a **SITUATION TIME**, i.e. the ‘time of a predicated situation’ (as defined in sections 2.12–13 above): in *John said that Bill had left*, the past tense form *said* represents the time of its predicated situation as anterior to t_0 , whereas the past perfect form *had left*

use of *will* effects. The prediction part is not involved in the predication; it just modalizes the predication (as based on the speaker’s expectation concerning the future).

represents the time of its predicated situation as anterior to the time of the predicated situation of *said*. This shows that an orientation time may be the time of a predicated situation: the orientation time to which the time of Bill's leaving is related by *had left* is the time of the head clause situation. For ease of reference, we call an orientation time which is the time of a predicated situation a 'situation time'. Since the (punctual or durative) time of a predicated situation can always serve as the origin of a temporal relation, any time of a predicated situation is an orientation time.¹¹

John stayed in the kitchen after he had finished his dinner. (*t₀ functions as the orientation time to which the situation time of John staying in the kitchen is represented as anterior, and this latter situation time is the orientation time to which the situation time of John finishing his dinner is represented as anterior.*)

This example allows us to make the following two generalizations. First, a situation time may or may not be a 'binding time' i.e. a time to which the situation time of another situation is temporally related by a tense (see 2.49). For example, the situation time of *stayed* is a binding orientation time, but the situation time of *had finished* is not. Second, an orientation time may or may not be a 'bound time', i.e. a time which is temporally related by a tense to another orientation time (see 2.49). Thus, the situation times of *stayed* and *had finished* are bound situation times, but *t₀* is not.

- (c) A third type of orientation time is an **UNSPECIFIED ORIENTATION TIME**: in *Bill had left*, the time of the predicated situation is represented as anterior to an unspecified orientation time which (in the prototypical use of the past perfect – see, however, 9.18.6) is understood as being anterior to *t₀*. An unspecified orientation time is an orientation time which forms part of the tense structure of a tense, but which is neither *t₀* nor the time of a predicated situation which is referred to in the sentence itself. However, for a full understanding of the sentence it is necessary that this orientation time be identifiable (given) in some way. For example, the unspecified orientation time may be the time of a predicated situation referred to in the linguistic context, as in [*It was no longer dark when she woke up.*] *Bill had left the room*. Here, *she woke up* provides the unspecified orientation time to which Bill's leaving is anterior. The following tense forms also imply an unspecified orientation time:

We must hurry up or the train *will have left*. (*The unspecified orientation time to which the situation time of leaving is represented as anterior is interpreted as being the time of our reaching the platform.*)

11. In fact, as we will see in 2.50.1–2, a situation time is always the 'central orientation time' of either a temporal domain or a 'subdomain' within a temporal domain.

He *had got up* early that morning. (*This could be the first sentence of a novel. In that case the unspecified orientation time is not immediately recoverable, in the same way as the referent of he is not. Starting a novel this way, with a sentence containing one or more ‘unbound variables’, is an often used rhetorical device.*)

- (d) A fourth type of orientation time is an (otherwise unspecified) time ‘contained in’ an **ADV-TIME** (= a time indicated by a time adverbial), as in *At that time Bill had (already) left the room.* (In section 2.23.1 we will go into the special way in which a time adverbial indicates an orientation time by ‘containing’ it in terms of either inclusion or coincidence.)
- (e) A final type of orientation time is an **IMPLICIT ORIENTATION TIME**. This is an orientation time which is implicit in the semantics of a temporal conjunction:

By the time Bill had left the room it was too late to act. (*Had left represents the leaving as anterior to the implicit orientation time referred to by the time in the phrasal conjunction by the time (that).*)

I will read the book before I pass it on to you. (*The present tense form pass on represents its situation as simultaneous with an orientation time which is implicit in the conjunction before. The meaning of the conjunction before can be paraphrased ‘before the time that’. In this paraphrase, the implicit orientation time is lexicalized by the NP the time – see 14.2 for a full discussion.*)

He is always very nervous when he is about to play. (*The situation of playing is located posterior to the implicit orientation time lexicalized by the time in the paraphrase ‘at the time at which’, which represents the temporal structure of when – see 13.3.1–2.*)

2.15 The semantics of tenses: temporal domains

The semantics of a tense are found in the structure of temporal relations that the tense represents. These relations hold between the situation time (= time of the predicated situation) that is to be located by the tense and one or more orientation times. The tense structure may specify a relation between the situation time and t_0 . Such tenses are absolute tenses.

Other tenses express tense structures which specify the relation of the situation time to an orientation time other than t_0 . These are relative tenses. Although relative tenses do not relate a situation time directly to t_0 , their structure does specify the nature of the temporal domain in which the situation time is located, and the nature of the temporal domain (past or post-present, for example) is determined by how the orientation time that establishes the domain is located relative to t_0 .

An absolute tense establishes a temporal domain. Relative tenses expand a temporal domain that has already been established. Thus, in the two-sentence text *Meg jumped with surprise. She had just seen the elephant.*, the (absolute) past tense of *jumped* establishes a past temporal domain and the (relative) past perfect tense of *had seen* expands that domain by specifying a relationship of anteriority in a past domain, leading to the interpretation that the seeing is anterior to the jumping.

2.15.1 The **SEMANTICS OF A TENSE** is the tense structure expressed by the tense form. This structure consists of orientation times and temporal relations holding between them. For example, the structure of the future tense consists of two orientation times, viz. t_0 and the situation time, and the temporal relation ‘situation time posterior to t_0 ’. The structure of the future perfect (*will* + perfect infinitive) involves three orientation times (viz. t_0 , an intermediate orientation time and the situation time) and two temporal relations (viz. ‘situation time anterior to intermediate orientation time’ and ‘intermediate orientation time posterior to t_0 ’). Thus, in *At five o’clock John will already have left* the tense form *will have left* represents John’s leaving as preceding the intermediate orientation time indicated (in the special sense defined in 2.23.1) by *at five o’clock* and represents this intermediate orientation time as future with respect to t_0 .

A tense structure can also consist of a single relation between the situation time and another orientation time plus information about the temporal location of the latter orientation time. Thus, the semantics of the past perfect is ‘situation time anterior to another orientation time in a past temporal domain’ – see section 9.1.

2.15.2 We speak of an **ABSOLUTE TENSE** when the tense in question relates the situation time directly to t_0 by locating that situation time in one of the ‘absolute time-zones’ – see 2.57 below. In *John {was / has been / is / will be} happy*, the preterite, the present perfect, the present tense and the future tense locate the situation time in the past, the pre-present, the present and the post-present (= future), respectively.

2.15.3 We speak of a **RELATIVE TENSE** when the tense in question specifies a particular temporal relation between the situation time and an orientation time other than t_0 . In *John said that he had been ill*, the past perfect form *had been* is a relative tense form because its situation time is represented as anterior to the situation time of the absolute tense form *said*. The relation between the situation time of *had been* and t_0 is not expressed. (In the above example, we can deduce that the situation time of *had been* is anterior to t_0 , but this is not always the case. Consider, for example, the sentence *Yesterday John said that*

he would help us tomorrow, after he had finished his article. This sentence can be true irrespective of whether the finishing of the article actualizes before, at or after t_0 – see also 8.24.1 below.)

In addition to specifying one temporal relation (to an orientation time other than t_0), a relative tense also reveals the temporal nature of the domain (see 2.15.4) to which the relation belongs. (This distinguishes relative tenses from nonfinite verb forms, which also express one temporal relation.) Thus, the semantics of the past perfect is ‘situation time anterior to an orientation time in a past domain’. (The nature of the domain – in this case: past – is determined by the absolute time-zone in which the situation time establishing the domain (= the ‘central orientation time’ of the domain – see 8.15) is located.)

2.15.4 A **TEMPORAL DOMAIN** is a set of orientation times which are temporally related to each other by means of tenses. At least one of these orientation times is a situation time (since any tense form locates a situation in time). A domain is normally established by an absolute tense form and expanded by one or more relative tense forms. For example:

John *said* he *was* tired because he *had worked* hard all day and that he *would go* to bed early.

Here all the tenses locate their situation times in the same past domain. This is established by the preterite form *said*, which is therefore an absolute tense form. The other tense forms are relative tense forms. *was [tired]* represents its situation time as simultaneous with the situation time of *said*, *had worked* represents its situation time as anterior to the situation time of *said*, *would go* relates its situation time as posterior to the situation time of *said*. For more details, see 9.1–6.

2.16 Kinds of temporal relations

The temporal relations established by tenses (‘T-relations’) must be distinguished from those established by inferencing from the linguistic and nonlinguistic context (‘W-relations’). For example, in *Meg went to the doctor. She felt ill.*, we have an absolute past tense in each sentence and these tense forms do not express a temporal relation between the two situations. However, our knowledge of the world leads us to infer that Meg went to the doctor because she felt ill and that therefore the situation described in the second sentence began before and continued during the situation described in the first sentence. A third type of temporal relation is that which holds between the time indicated by a temporal adverbial and a situation time. This will be called an ‘adv-time relation’. We may also note the temporal relation between the time of the full situation

and the time of the predicated situation (= the situation time). The former ‘contains’ the latter in terms of either inclusion or coincidence. When a situation is nonhomogeneous (bounded), the time of the full situation coincides with the situation time; when the situation is homogeneous (nonbounded), the time of the full situation may coincide with or include the situation time.

The temporal interpretation of sentences has to take into account different kinds of temporal relations.

2.16.1 To begin with, we must distinguish between relations linguistically expressed by tenses, relations linguistically expressed by adverbials, and temporal relations that are not linguistically expressed but play a part in interpretation. We will refer to them, respectively, as **T-RELATIONS** (with ‘T’ standing for ‘tense’), **ADV-TIME-RELATIONS** (with ‘ADV-TIME’ standing for ‘adverbially indicated time’) and **W-RELATIONS** (with ‘W’ standing for ‘world’, since W-relations are understood as holding in the world referred to, without being linguistically expressed, although the evidence used to infer W-relations may well be linguistic.) For example:

Ian met Sybil yesterday afternoon. (*There is an Adv-time-relation between the time of Ian meeting Sybil and the time interval indicated by yesterday afternoon: the former is included in the latter – see 2.23.1.*)

When she *had* first met him, he had been wearing a blue T-shirt and shorts. (*The situation time of the when-clause is interpreted as W-simultaneous with the situation time of the head clause, but it is not represented as T-simultaneous with the latter because the tense form used is not met but had met – see 13.10.1.*)

2.16.2 Another kind of temporal relation which plays a role in temporal interpretation is the ‘containment relation’ between the time of the full situation and the situation time: the time of the full situation **CONTAINS** the situation time in terms of either inclusion or coincidence. In bounded clauses, the time of the full situation coincides with the situation time, whereas in nonbounded clauses it may either coincide with or include the situation time.

Yesterday John ran two miles before breakfast. (*The sentence is bounded because the VP is telic and nonprogressive – see 1.47. A bounded sentence is ‘nonhomogeneous’ – see 1.45, which means that the time of the full situation coincides with the situation time.*)

At five a.m. John was already running his usual two miles before breakfast. (*The sentence is nonbounded because of the progressive form. A nonbounded sentence is homogeneous, which means that the time of the full situation can include the situation time. This is the case here: because the situation time coincides with the punc-*

tual Adv-time indicated by *at five a.m.*, the situation time must also be punctual, and must therefore be included in – i. e. form part of – the time of the full situation.) [“What was John doing from 5 to 5.30?”] – “From 5 to 5.30 John was running his usual two miles before breakfast.” (The sentence is nonbounded because of the progressive form and because *from 5 to 5.30* is not new information. Because a nonbounded sentence is homogeneous, the time of the full situation may or may not coincide with the situation time. There are therefore two cases in which the reply may be true: (a) John started running at 5 and completed his two-mile run at 5.30; (b) He ran throughout the period from 5 to 5.30 but started earlier than 5 and/or stopped running after 5.30.)

The containment relation between the time of the full situation and the situation time is a W-relation, but whether that containment relation is interpreted as a relation of inclusion or coincidence is partly determined by a linguistic factor. That linguistic factor is the L-(non)boundedness of the clause, which corresponds with a (non)homogeneous meaning. The L-(non)boundedness of the clause depends on the L-(non)boundedness of the constituents functioning as arguments to the verb and / or the use of the (non)progressive form – see 1.46–48.

2.17 Expanding a temporal domain: expressing T-relations

A situation time may be T-related to an orientation time in one of three different ways: it may be located simultaneous to, posterior to or anterior to the orientation time. The T-relation of simultaneity is always one of strict coincidence, not overlap or inclusion. In *Meg said that she was feeling ill*, the W-relation between the situation of saying and the situation of feeling ill is a simultaneity relation which involves overlap or inclusion: we assume that the feeling ill started before the saying and that it continues during and probably after the saying. But the simultaneity expressed by the tense form *was feeling* – the T-relation – is strict coincidence. The two situation times are punctual and coincide. When a situation is located anterior to an orientation time it may be located at a certain distance before the orientation time or it may lead right up to the orientation time. In the same way, a situation located posterior to an orientation time may be located some time after the orientation time or may start immediately after it.

2.17.1 A tense form can relate a situation time to an orientation time in three different ways. Firstly, there is **T-SIMULTANEITY** if the situation time is linguistically represented as simultaneous with the orientation time. T-simultaneity is by definition a relation of strict coincidence. This is in keeping with

the distinction between ‘situation time’ (= time of the predicated situation) and ‘time of the full situation’. In [*John said*] *he was feeling ill*, the past tense form *was feeling* represents its situation time as coinciding with the situation time of *said*. The situation time of *was feeling* is not the time of the full situation: it is the time of the predicated situation, i. e. that part of the time of the full situation that coincides with the situation time of *said*.

The claim that T-simultaneity has to be defined in terms of strict simultaneity (coincidence) rather than overlap is based on empirical evidence, more specifically on the way we interpret sentences like the following:

- (6) [On leaving the classroom] John *told* me that he *believed* that Bill *was brooding* over something.

The unmarked interpretation of this sentence is that the situations of telling, believing and brooding are all simultaneous with each other. When we consider the times of the full situations, we see that all three of them are durative. The tense forms *believed* and *was brooding* are relative past tense forms expressing T-simultaneity (see 9.3.1): the brooding is represented as T-simultaneous with the believing, and the believing is represented as T-simultaneous with the telling. The time of the telling is specified by the adverbial *on leaving the classroom*. Now, if T-simultaneity were to be defined in terms of overlap between two full situations, (6) would allow the interpretation that Bill’s brooding was not simultaneous with John’s telling (and hence with the time of leaving the classroom): according to this definition, the telling could overlap one interval of the believing, while the brooding could overlap another (completely different) one, so that there would be no overlap between the brooding and the telling. This definition of T-simultaneity would therefore allow the reading in which the brooding was W-posterior to the telling. However, this interpretation is obviously not available in (6). What is available is the reading in which the brooding, the believing and the telling are all actualizing at the time indicated by *on leaving the classroom*.¹² This can only be explained if T-simultaneity is defined as strict coincidence between situation times. Since the situations of believing and brooding are interpreted as nonbounded (and hence homogeneous – see 1.45), their situation times can be proper subintervals of the times of their full situation. So, even if the time of the full situation of leaving Bill brooding does not completely coincide with the time of the full situation of John believing, and the time of the full situation of John believing does not completely coincide with the time of John’s telling, the three situation times do coincide

12. Because *believed* and *was brooding* can in principle be interpreted as absolute rather than relative tense forms, the sentence does not rule out the (pragmatically unlikely) interpretation in which the believing precedes the telling, and whether the believing precedes the telling or not, the brooding precedes the believing – see section 8.25 for a fuller discussion. However, we are not concerned with this secondary interpretation here.

with each other. T-simultaneity must therefore be defined as coincidence between situation times, not as an overlapping relation between the times of full situations.

Further evidence that T-simultaneity has to be defined in terms of strict simultaneity (coincidence) rather than overlap is the fact that it is impossible to represent a bounded durative situation as T-simultaneous with a (more or less) punctual situation time, even if the former situation overlaps the latter in real time:

John said that he {*built / was building} a house.

There is no problem using *was building*, because this represents the situation as homogeneous, so that a relation of coincidence can be expressed between the time of the situation referred to by *said* and any time of the situation referred to by *was building* – see also 2.30.

2.17.2 The second possible T-relation that a tense can express is **T-ANTERIORITY**. Here the situation time is represented as preceding the orientation time in either of two ways. Either the situation time lies at some distance before the orientation time (as in *I knew I had locked the door*) or it begins before the orientation time and leads up to it (as in *I told them that we had been friends since we first met*).¹³

2.17.3 Finally, there is **T-POSTERIORITY** if the situation time is represented as following the orientation time, as *He said he would do it the next day*. The situation time may then start from the binding orientation time onwards (as in *He said that from then onwards he would treat me as a friend*) or be separated from it (as in *He said he would do it the next day*).¹⁴

2.18 Temporal relations that are not linguistically expressed: W-relations

T-relations are temporal relations, expressed by tenses, between the times of predicated situations (i. e. situation times) and orientation times. W-relations are temporal rela-

13. The first possibility is the past domain counterpart of either the past tense or the present perfect on an ‘indefinite’ (see 5.5.1) interpretation, while the second is the past domain counterpart of the present perfect on a ‘continuative’ (see 5.5.1) interpretation: the past tense and the ‘indefinite present perfect’ locate the situation time at some distance before t_0 , while the ‘continuative present perfect’ represents it as covering an entire period leading up to t_0 .

14. As noted before, a ‘binding orientation time’ is an orientation time to which the situation time of a situation is temporally related by a tense (see 2.49).

tions, inferred from contextual information or pragmatic knowledge, between the times of full situations and orientation times. W-simultaneity occurs when at least one point of one full situation coincides in time with any point of another full situation: strict coincidence of the times of the entire situation is not necessary.

2.18.1 A situation may be interpreted as simultaneous, anterior or posterior to another situation without this being expressed by a tense form or temporal adverbial. In that case the temporal relations are not tense relations (T-relations) or adverbially indicated relations (Adv-relations), but simply temporal relations that are inferred to exist in the real world (or in whatever world is being referred to) on the basis of the context or of the hearer's pragmatic knowledge of the world in question. We will refer to such temporal relations as **WORLD RELATIONS (W-RELATIONS)**.

["What were they doing?"] – "Betty was reading the paper, Bill was watching TV and Jeremy was sleeping on the sofa." (*The three past tense forms are absolute tense forms which do no more than locate the three situation times in the past. In other words, none of them expresses T-simultaneity. However, it is clear from the context that the three situation times must be interpreted as W-simultaneous with each other.*)

When they had first visited the house, they hadn't noticed the wet patch on the ceiling of the kitchen. (*The past perfect tense forms both represent their situation time as T-anterior to an unspecified past orientation time. The relation of W-simultaneity that is understood to exist between the two situations is not expressed by the tense forms.*)

John told me he was involved in an accident in France. (*The two absolute past tense forms merely locate their situation times in the past – see 1.10.3. Pragmatic knowledge tells us that John's accident must be understood as W-anterior to his telling me about it.*)

2.18.2 Unlike simultaneity expressed by a tense form (= T-simultaneity), W-simultaneity is not a semantic relation but a pragmatic one. In other words, while T-simultaneity forms part of the semantics of, for example, the relative past tense (see 2.17), W-simultaneity is to be inferred from a combination of linguistic information, the linguistic and nonlinguistic context, and other pragmatic knowledge. It follows (a) that W-simultaneity is largely a question of pragmatic *interpretation* rather than linguistic *representation*, and (b) that W-simultaneity is less rigidly defined than T-simultaneity: whereas the latter is equivalent to coincidence, W-simultaneity can, according to context, be interpreted as coincidence, overlap or inclusion. In other words, two time intervals are W-simultaneous the moment they have one point of time in common. This

is clear from the following examples, in which all the tense forms are absolute preterites:

Suddenly somebody fired a gun. I heard it. (*The two punctual situations coincide with each other, at least in our everyday understanding of the actual world.*)

I met John yesterday. He was walking to work. (*The full situation of John's walking includes the punctual situation of my meeting John.*)

Whereas Mary was painting the front door, I was working in the garden. (*The two full situations may either coincide or overlap: one situation may have started at, before or after the beginning of the other situation, and either of them may have ended at, before or after the end of the other situation. The two situations are W-simultaneous in the sense that they have at least one point of time in common.*)

As is clear from the comment added to these examples, a temporal W-relation holds between times that are 'the time of a full situation' – see sections 2.12–13 – rather than between situation times (= the times of predicated situations). This is logical, since W-relations are not linguistically represented, and full situations are not either (except if the situation time is represented as bounded, in which case the situation time coincides with the time of the full situation – see section 2.12.2.) 'Situation time', by contrast, is a linguistic concept, which is needed to explain how a situation is located in time by a tense form. In other words, both 'W-relation' and 'full situation' refer to nonlinguistic concepts, in the sense that they have to do with pragmatic interpretation and not (or not exclusively) with linguistic representation. By contrast, 'T-relation' and 'situation time' are the names of linguistic concepts, which have to do with the way tense forms represent the temporal location of a situation.

DEMAN

II. Special uses of tense forms

In sections 2.15–17 we have pointed out the ‘normal’ uses of tenses as either absolute tenses (establishing a temporal domain) or relative tenses (expressing a T-relation in a domain.) In this section we will have a brief look at some special uses of tenses which are clearly distinguishable from the normal uses.

2.19 Modal uses of tenses

Past and past perfect tense forms can be used to express tentativeness or unreality. The tentativeness may be social, as in *I wondered if you might like this book* or it may concern the likelihood of actualization of a situation, as in *If you wanted to, you could write a book*. (Note that in the first of these, the past tense *wondered* is a literal past tense – it has past time reference.) Both tentativeness and unreality are standardly expressed by past (perfect) tense forms in conditional sentences, as in the counterfactual *If I were President, I would cancel third world debt*.

The past tense and the past perfect can be used to express such modal concepts as tentativeness or unreality:

- (a) With some verbs of volition the past tense can be used to represent a present wish or hope as more tentative (diffident, indirect, polite) than the present tense would do.

I wanted to ask you a favour.

[Will we see each other at the dance tonight?] *I hoped* you might be there.

- (b) Some verbs of volition can be used in the past perfect tense in order to express unreality, i.e. nonactualization of an initial expectation, intention, etc.

I had {*wanted* / *meant* / *hoped* / *expected* / *intended*} to be in London today.
(*implies: but I'm not*)

- (c) In *that*-clauses depending on a form of the verb *wish* and in clauses introduced by *if only* or *would that*, the past tense or the past perfect can be used in order to express unreality (counterfactuality). In that case these tenses do not realize their normal tense structures but (apart from expressing counterfactuality) merely express T-simultaneity and T-anteriority, respectively.

I {wish / wished / had wished / will probably wish} I *didn't know* his number. (*modal past; the situation time in question is T-simultaneous with the situation time of the head clause.*)

I {wish / wished / had wished / will probably wish} I *had never met* him. (*modal past perfect; the situation time in question is T-anterior to the situation time of the head clause.*)

- (d) The past tense can be used to add a tentative meaning to the *if*-clause of a conditional sentence:

I'd be happy if you *did* that for me. (*modal past: the reference is not to the past but to future actualization, which is represented as tentatively possible.*)

I'd be surprised if she *arrived* on time. (*more tentative than I'll be surprised if she arrives on time*)

- (e) Under certain conditions, either the past tense or the past perfect can be used in a conditional clause so as to represent fulfilment of the condition as counterfactual:

If I *was* a rich man, I would travel a lot. (*modal past: the reference is not to the past but to the present, which is represented as counterfactual (unreal).*)

If he *had been* here today, he would have been very happy. (*modal past perfect: the reference is not to the past but to the present, and the actualization of the situation is represented as counterfactual.*)

- (f) There are still other environments in which a modal past or modal past perfect can be used. For example:

He looks as if he *had seen* a ghost. (*modal past perfect, expressing counterfactuality as well as T-anteriority*)

2.20 Shifts of temporal perspective

When the temporal location of a situation is obvious from the context, it is possible for a speaker to represent a situation as lying in one time-zone whilst *apparently* locating it in another time-zone. In that way, by relying on the hearer to establish the temporal location from the context, the speaker combines correct time-reference with the connotations of location in a different time-zone. For example, *The train leaves at eight* represents a post-present situation as if it is already the case, thus emphasizing that the future is in this case seen as already fixed.

There is a **SHIFT OF TEMPORAL PERSPECTIVE** if a tense is selected, not in order to locate a situation time in a particular time-zone (e.g. the present or the

past – see section 2.37) but in order to represent it *as if* lying in that time-zone. The following illustrate two different typical cases:

And a week later I'm on Rupert's lawn again. And who should come squealing and bellowing through the hedge but Bill. And *does* he *ask* about my trip to America? No. *Does* he *want* my story of the upside down helicopter flight over Central Park? Or the Watneys Red Barrel ride over Niagara? (...) Not him. He's *jabbering* about his brand-new putty-knife, *shrieking* about his broken fretsaw and intent on introducing me to every single socket in the socket-set his dad got him for passing O-level French twenty years ago. (www) (*This use of the present tense, which is called the 'historic present' or 'historical present' is a way of describing past situations vividly, as if they were happening here and now – see 3.3.1.*)

The soldiers {leave / are leaving} tomorrow.

In the latter example, a future situation is represented as if it were actualizing at t_0 . This use of the present tense is a means of expressing that the speaker thinks that there can be no doubt about the future actualization of the situation. The temporal domain that is established is a post-present one, but it is established as if it were a present domain. Evidence that it is really a post-present domain is the presence of *tomorrow* and the possibility of adding an adverbial *when*-clause: *The soldiers are leaving tomorrow when they have finished their job*. Such an addition is not possible to the corresponding sentence establishing a present domain: compare *The soldiers are now leaving* with **The soldiers are now leaving when they have finished their job*.)

2.21 Universal sentences

An apparently special use of the present tense is found in 'universal' sentences, which refer to a state which holds at all times. (Such sentences may cite universal truths or they may refer to permanent characteristics (including habits).) For example: *Elephants never forget*. However, these are actually not special uses of the present tense, since they refer to homogeneous situations and thus locate a punctual situation time – which represents the time of a representative punctual section of the full situation – simultaneous with speech-time, in accordance with the meaning of the present tense.

2.21.1 Sentences in the present tense sometimes refer to a state which holds at all times or at every time in the existence of the referent of the subject. Such sentences are called **UNIVERSAL** (or **GNOMIC**) sentences.

Two and two is four.

The sun rises in the east.

Is Greenland a continent of its own?

Gnomic sentences that predicate a typical characteristic of a kind (species) are also called **GENERIC SENTENCES**.

{A / The} horse is a four-footed mammal.

Horses do not eat meat.

Habitual sentences that predicate a typical and permanent (nontemporary) characteristic of an individual are also sometimes called generic.

Bill's cat chases bikes.

Most of us walk to work.

2.21.2 In fact, gnomic sentences in the present tense do not really represent a special use of this tense, because they are quite in keeping with our definition of T-simultaneity in terms of strict coincidence (see 2.17 and 8.17.1). Like habitual sentences, gnomic sentences express a characteristic. As pointed out in section 1.34.4, a characteristic is a state, and states are by definition homogeneous. To illustrate this with a nongnomic example, if *John was in the kitchen* can be truly predicated of the entire interval that John spent in the kitchen, it can also be truly predicated of the various subintervals making up this interval. In the gnomic sentence *Two and two is four*, the situation time is located at t_0 . Since 'is located at' means 'is represented as T-simultaneous (i. e. coinciding) with', and since t_0 is conceived of as punctual in English (see 2.4), the situation time (= time of the 'predicated situation' – see 212.) is a punctual subinterval of the time of the full situation. The fact that the predicated situation is punctual does not prevent the situation from being interpreted as gnomic and making a statement about the full durative situation. The fact that we conceive of a state as unchanging and homogeneous renders that interpretation possible.

In sum, in gnomic clauses – and also in habitual and progressive clauses – the use of the present tense means that the situation time is punctual, because it is represented as T-simultaneous (i. e. coinciding) with t_0 , which is conceived of as punctual. However, the fact that such clauses represent their situation time as punctual does not prevent them from being pragmatically *interpreted* as referring to a durative situation. This is because the situation time is only a point included in a longer, homogeneous situation. The temporal *interpretation* of a clause usually concerns the time of the full situation rather than the situation time only (which is a quite abstract concept). The full temporal interpretation of a clause is not exclusively determined by the choice of tense and Adv-time: pragmatic considerations (i. e. contextual information, knowledge of the world and accepted principles of conversation) are often as important as the semantics of the tense and the Adv-time (if any).

III. The role of temporal adverbials

2.22 Definition and basic classification of ‘temporal adverbials’

We distinguish three types of adverbial that give temporal information. ‘Time-specifying’ adverbials (e.g. *at six o’clock*) temporally locate an orientation time (which may be a situation time) by specifying a particular time (an ‘Adv-time’) which may be punctual or durative and which contains (i.e. coincides with or includes) the orientation time. Pure duration adverbials (e.g. *for six hours*) specify the length of time occupied by a full situation, but do not locate it in time. Bifunctional adverbials (e.g. *from six to eight*) both temporally locate a situation time and specify the length of the corresponding full situation. Thus in *Meg watched the elephant from six to eight*, the temporal adverbial locates the situation time (the time of the predicated situation) at the time indicated by ‘from six to eight’ and measures the (time of the) full situation (as taking up two hours).

The term **TEMPORAL ADVERBIAL** will be used here in the wide sense of ‘adverbial that has to do with time’. This covers the following three types:

2.22.1 **TIME-SPECIFYING ADVERBIALS** locate an orientation time in time by indicating a specific **ADV-TIME** (‘adverbially indicated time’) which **CONTAINS** the orientation time in question in terms of inclusion or coincidence – see 2.23.1:

John was here {yesterday / at five o’clock}.

The Adv-time that is indicated by a time-specifying adverbial may itself be durative or punctual. This leads to a second distinction, between **DURATIVE TIME-SPECIFYING ADVERBIALS**, which specify a durative Adv-time, and **PUNCTUAL TIME-SPECIFYING ADVERBIALS**, which refer to a nondurative time, i.e. a moment or point in time. In both cases the relevant orientation time is contained (in terms of inclusion or coincidence) in the Adv-time. In the case of a punctual Adv-time the containment relation has to be a relation of coincidence; with a durative Adv-time it can also be inclusion.

John left at five. (*punctual Adv-time coinciding with the situation time*)

John had already left at five. (*punctual Adv-time coinciding with the unspecified orientation time to which the situation time is T-anterior*)

John was in London at five. (*punctual Adv-time coinciding with the situation time; the situation time is included in the time of the full situation*)

John left yesterday. (*durative Adv-time including the punctual situation time*)

John was in London yesterday. (*durative Adv-time containing the durative situation time in terms of inclusion – John was in London at or for some time yesterday – or coincidence – John was in London all day yesterday*)

2.22.2 **PURE DURATION ADVERBIALS** do not identify an Adv-time but only specify duration, more specifically the duration of the full situation.

John was here for a couple of hours. (*pure duration adverbial: it specifies the duration of John's visit but offers no clue as to when it took place*)

As will be noted in 2.31.1, a pure duration adverbial specifies the duration of the full situation and not of the situation time (except indirectly, when the two happen to coincide – see 2.31.2.) Thus in, *Today John is in London for most of the day*, the situation time is punctual (because it coincides with t_0 – see 2.21.2) and *for most of the day* indicates the (pre-determined) duration of the full situation of John being in London.

Needless to say, it is important to distinguish carefully between pure duration adverbials and durative time-specifying adverbials. Durative time-specifying adverbials indicate the Adv-time containing the situation time but do not necessarily specify the duration of the situation time (as in *John had a walk yesterday*), whereas pure duration adverbials specify the duration of the full situation but do not specify its time, i. e. the precise temporal location of the situation time in the absolute zone in which the tense places it (e.g. *John walked for three hours*).

2.22.3 **BIFUNCTIONAL TEMPORAL ADVERBIALS** have a double function: they function as time-specifying adverbial and duration adverbial at the same time. For example:

["What were you doing from Monday to Thursday?"] – "I was abroad from Monday to Thursday." (*The adverbial specifies the time as well as the duration of the predicated situation. The latter may happen to coincide with the full situation but is more likely to be a portion of it.*)

["When were you abroad?"] – "I was abroad from Monday to Thursday." (*The adverbial specifies the time as well as the duration of the predicated situation. Because the adverbial gives the information that is asked for, the Gricean Maxim of Quantity stipulates that the duration indicated must be the duration of the full situation. In other words, in this W-bounded reading, the situation time coincides with the time of the full situation.*)

They were together the whole morning.

It rained heavily all afternoon.

I've been waiting for her for two hours now. (*For two hours now indicates the duration of the predicated situation, which is also the 'factual full situation', i. e. the full situation as it has actualized up to now – see 2.31.2. Because the situation time fills the entire period leading up to now, the adverbial also specifies the relevant pre-*

present period. In doing so it functions as a time-specifying adverbial: the Adv-time is the period up to now, which contains the situation time, in this case in terms of coincidence.)

As is clear from the last example, duration adverbials are always bifunctional if they are ‘anchored’ to t_0 by *now*.

2.23 The function of a time-specifying adverbial

As we have seen, a time indicated by a time-specifying adverbial (an Adv-time) contains the situation time (or other orientation time) whose temporal location it specifies. The situation time may be shorter than the Adv-time (i. e. it is included in it) or it may be exactly the same length (i. e. it coincides with it). In either case we can speak of ‘Adv-time-simultaneity’. When the Adv-time is punctual, the situation time is necessarily included in a punctual time and must therefore itself be punctual. A durative situation can be represented as simultaneous with a punctual Adv-time provided that the situation is homogeneous (nonbounded). (The situation time is then the time of a punctual portion of the situation which is representative of the whole situation.) The fact that a progressive clause can combine with an adverbial specifying a punctual Adv-time means that a progressive clause represents the predicated situation as a punctual situation which is representative of the longer full situation.

2.23.1 As we have seen, tenses only express (one or more) T-relations between orientation times. (One of these orientation times is necessarily a situation time, viz. the time of the situation referred to by the tensed clause.) This means that tenses do not express a T-relation between a situation time and the time specified by an adverbial. However, as noted in section 2.16.1, there is an ‘Adv-time-relation’ between an adverbially specified time interval (henceforth: **ADV-TIME**) and an orientation time. This relation is a relation of ‘containment’. **CONTAINMENT** covers two possibilities:

- (a) *inclusion*: the included orientation time is shorter than the Adv-time; it may coincide with the beginning or end of the Adv-time or with some middle part of the Adv-time.
- (b) *coincidence*: the contained orientation time coincides with the Adv-time. In other words, the boundaries of the Adv-time coincide with the boundaries of the contained orientation time.

In both cases the contained orientation time is simultaneous with the Adv-time in a well-defined sense. In 2.29 we will call this relation ‘**ADV-TIME-SIMULTANE-**

ity', which is to be distinguished from T-simultaneity (expressed by certain tenses) and W-simultaneity (which is a question of interpretation in context).

2.23.2 The following sentences illustrate the two kinds of Adv-time-simultaneity, viz. inclusion and coincidence.

John left yesterday. (*The past tense form left locates its situation time in the past time-sphere. Its exact location there is specified by yesterday, which specifies a durative Adv-time which includes the situation time of John leaving.*)

John had already left yesterday. (*Let us consider the reading 'John left before yesterday'. The past perfect form had left then represents its situation time as T-anterior to a past orientation time. This past orientation time is an unspecified orientation time – see 2.14. However, the precise location of the unspecified orientation time in the past time-sphere is indicated by yesterday, which refers to a durative Adv-time containing the unspecified orientation time prior to which John left.*)

John left at four o'clock. (*At four o'clock indicates a punctual Adv-time which coincides with the situation time of John leaving.*)

["Where was John during the lecture?"] – "John was in the library during the lecture." (*During the lecture denotes an Adv-time which coincides with the situation time of John being in the library: the interpretation is that John was in the library throughout the lecture. In other words, the time of the predicated situation is exactly as long as the time interval indicated by during the lecture. Obviously the time of the full situation of John being in the library may be considerably longer than this.*)

[It can't have been John you saw yesterday.] He was in India yesterday. (*Yesterday denotes an Adv-time which either includes the situation time of John being in India (in which case the interpretation is that John was in India for some time yesterday, but not all day) or coincides with the situation time (in which case the interpretation is that John was in India all day yesterday). In the latter interpretation, the time of the full situation of John being in India may extend beyond the boundaries of the Adv-time: the sentence is true, e.g. if John has been in India for the past week.*)

By four o'clock John will have left. (*The Adv-time denoted by four o'clock contains (in the sense of: coincides with) the unspecified orientation time to which the situation time is T-anterior and which is itself T-posterior to t_0 .*)

2.23.3 The following sentence is similar to *John left at four o'clock* above:

John was reading at four o'clock. (*At four o'clock indicates a punctual Adv-time which coincides with the situation time of John reading.*)

Examples like this naturally raise the question of whether this analysis entails that the situation referred to by a clause with a progressive verb phrase and a punctual time-specifying adverbial is represented as punctual. The answer is that it does. The situation represented by the progressive tense form is the situation time. This situation time is punctual because it is contained in (in the sense of: coincides with) the punctual Adv-time. This analysis accords with the fact that *John was reading at four o'clock* is not a suitable answer to *When*

was John reading?, unless there was only one moment that John was reading and that moment coincided with four o'clock. That is, if John's reading took up a certain time, the reply *John was reading at four o'clock* is not false, but it is pragmatically unacceptable because it is insufficiently informative. The Gricean Maxim of Quantity sees to it that (except in special contexts) the question *When was John reading?* is interpreted as asking information about the length of the full situation. An answer like *John was reading from 2 p.m. to 4* is a suitable reply to this, because it specifies an Adv-time that is long enough to be able to contain (coincide with) a situation time that is the time of the full durative situation. An answer like *John was reading at four o'clock* is not normally a suitable reply to *When was John reading?* because it is not sufficiently informative: it specifies an Adv-time that is punctual and therefore cannot contain (coincide with) a situation time that is the time of the full situation, except in the very unlikely case that John's reading took up just one moment. In other words, *When was John reading?* asks for a specification of the complete period when John was reading, while *John was reading at four o'clock* normally only specifies a point in the course of that period.

Of course, the fact that such a clause with a progressive verb phrase and a punctual time-specifying adverbial represents its situation time as punctual does not prevent such a clause from being pragmatically *interpreted* as referring to a durative situation. This is because the progressive form implies that the situation time is only a portion of a longer, homogeneous situation. Our knowledge of the world too tells us that reading is not normally a punctual situation. As explained in 2.21.2, the full temporal interpretation of a clause is not determined by the choice of tense and Adv-time only: the interpretation is based on pragmatics as well as semantics.

2.24 Situation-time adverbial

In a given context, a temporal adverbial may contain (i. e. by inclusion or coincidence) a situation time, an orientation time other than a situation time, or several orientation times (usually situation times). We refer, respectively, to 'situation-time adverbials', 'orientation-time' adverbials' and 'multiple-orientation-time adverbials'.

A time-specifying adverbial denoting an Adv-time which contains the situation time (in either of the senses described in 2.16.2, viz. inclusion or coincidence) will be called a **SITUATION-TIME ADVERBIAL**.

I left there yesterday. (*Yesterday* is a situation-time adverbial because the Adv-time that it denotes includes the situation time, i. e. the time of my leaving.)

2.25 Orientation-time adverbial

An **ORIENTATION-TIME ADVERBIAL** is a time-specifying adverbial denoting an Adv-time which contains (in either of the two senses) an orientation time other than a situation time.

At five o'clock John had already left. (*At five o'clock* specifies an Adv-time which contains the unspecified orientation time to which John's leaving is represented as T-anterior.)

[I don't know how people will react to the next news bulletins, but] right now only two of the guests are going to interrupt their holiday tomorrow because of the approaching tornado. (*Now* is an orientation-time adverbial, *tomorrow* is a situation-time adverbial. The orientation time contained in (= coinciding with) 'now' is t_0 .)

She intends to come at six, when most people will have left. (*The when-clause* is used here as a relative clause in which *when* has an adverbial function: *when* means 'at which time' and functions as orientation-time adverbial in the relative clause. That is, *when* does not specify (contain) the situation time (i.e. the time of the people leaving) but the implicit orientation time to which the situation time is T-anterior.)

2.26 Multiple-orientation-time-adverbial

A **MULTIPLE-ORIENTATION-TIME ADVERBIAL** denotes an Adv-time which contains more than one orientation time. (The orientation times in question are usually situation times.)

Yesterday John left before Bill arrived. (*Before Bill arrived*, which means 'at a time before Bill arrived', is a situation-time adverbial in the head clause: it denotes an Adv-time which includes the situation time of John's leaving. *Yesterday*, which indicates an interval including both the situation time of John's leaving and the situation time of Bill's arrival, is a multiple-orientation-time adverbial.)

2.27 The relation between one Adv-time and another

When there is more than one time-specifying adverbial, the various adverbially specified time intervals are normally related to each other in terms of containment (i.e. inclusion or coincidence). The situation time is contained in the shortest of these intervals. (Remember that an Adv-time interval may be durative or punctual.)

I left at 5 a.m. in the morning on Tuesday last week. (*The situation time* is contained in the Adv-time specified by *at 5 a.m.*, which is included in the Adv-time specified

by *in the morning*, which is itself included in the Adv-time specified by *on Tuesday*, which in its turn is included in the Adv-time specified by *last week*.)

Exceptionally, we can find a combination of a time-specifying adverbial specifying (= containing) a situation time and an adverb referring to t_0 as a ‘time of evaluation’:

Now there will be no water left for the rest of the day. (*This is interpreted something like ‘Now that X has actualized, there will be no water left for the rest of the day’.*)

At present we have answered two-thirds of these letters.

2.28 Durative time-specifying adverbials referring to the present

Adverbials like *today*, *at present*, *these days*, etc. denote a durative Adv-time which includes t_0 . The temporal zero-point resembles a punctual Adv-time in that it contains (in the sense of ‘coincides with’) the situation time of the clause. This means that a predicated situation that is located at t_0 must be punctual, hence that the full situation has to be either punctual or homogeneous. This is illustrated by the grammaticality of *At this very moment I’m writing a letter* versus the ungrammaticality of **At this very moment I write a letter*: the situation time can only be located at (i. e. represented as coinciding with) t_0 if it is punctual, and in the case of writing a letter this condition is only satisfied if the durative situation is represented as homogeneous by the use of the progressive form. This is also true when there is a durative adverbial like *today*, *these days*, etc. The situation time again coincides with t_0 , which is a point of time that is included in the Adv-time denoted by the durative adverbial. For example:

[As you can see,] we’re eating on the verandah today.

The temporal interpretation of this sentence is determined by the following factors: (a) The progressive form represents the (full) situation as homogeneous; (b) The present tense represents the situation time as T-simultaneous with t_0 ; (c) Because t_0 is punctual, the situation time must be punctual too: this follows from the definition of T-simultaneity as being a relation of strict coincidence (see 2.17); (d) Because *today* indicates a longer period including t_0 , and because the situation time is understood as forming part of a longer homogeneous full situation, the time of the full situation will be interpreted as coinciding with a durative subinterval of the Adv-time indicated by *today* (or even with the Adv-time as a whole, but this is pragmatically unlikely).

If, in the same sentence, the Adv-time is indicated by *these days*, the factors determining the full temporal interpretation of the sentence (*We’re eating on the verandah these days*) are the following: (a) The full situation is homogene-

ous because it is a temporary habit: as noted in 1.23.3, a habit is a state and, unless it involves a ‘bounding adverbial’ (see 1.48.2) like *from 3 to 5*, the representation of a state is by definition homogeneous; (b) The present tense represents the situation time as T-simultaneous with t_0 ; (c) Because t_0 is punctual, the situation time must be punctual too (cf. the definition of T-simultaneity): the time of the predicated situation (= situation time) is therefore a ‘moment-of-a-habit’; (d) Because *these days* indicates a longer period including t_0 , and because the situation time is pragmatically understood as forming part of a longer homogeneous full situation (of which it may be any moment, including the initial and terminal points), the time of the full situation is interpreted as coinciding with the Adv-time indicated by *these days*.

2.29 Adv-time-simultaneity

Adv-time simultaneity is unlike W-simultaneity in that it is linguistically expressed and it is unlike T-simultaneity in that it is not expressed by a tense and it allows for a relation of proper inclusion as well as one of strict coincidence, though it does not allow for mere overlap. When there is more than one Adv-time in a clause, the relation between the Adv-times is also one of Adv-time simultaneity – i. e. proper inclusion or coincidence.

In the previous sections we have seen that an Adv-time can contain a situation time, or t_0 , or another orientation time. This containment relation, which may be either inclusion (provided the Adv-time is durative) or coincidence, is a kind of simultaneity relation. However, it is not T-simultaneity, since the containment relation does not form part of the semantics of any tense, and it is not W-simultaneity, since it is not a question of pragmatic interpretation. Like T-simultaneity, it is a linguistic relation: it is inherent in the English language system that the temporal information provided by an adverbial specifying an Adv-time is always interpreted in terms of simultaneity (containment). In section 2.16 we have therefore distinguished between three kinds of simultaneity: T-simultaneity (expressed by some tense forms), W-simultaneity (which is a question of interpretation-in-context) and Adv-time-simultaneity. The last is the relation of containment between an Adv-time and a situation time, t_0 or another orientation time.¹⁵

15. Because an Adv-time by definition contains a situation time, Adv-time-simultaneity is the only possible temporal relation between the contained orientation time and the containing Adv-time. There is no such a thing as ‘Adv-time-anteriority’ or ‘Adv-time-posteriority’. That is, the relation between the contained orientation time and the containing Adv-time cannot be such that the orientation time precedes or follows the Adv-time. When we speak of anteriority or posteriority, what we have in mind can only be a T-relation or a W-relation.

If there is more than one Adv-time, as in *He left at 4 p.m. on 1 May 1999*, the relation between the various Adv-times is also Adv-time-simultaneity: 1999 includes *on 1 May*, which includes *at 4 p.m.* It is the last (i. e. shortest) of these Adv-times that contains the situation time.

2.30 Punctual Adv-times and durative bounded situations

When a durative situation is bounded, it is (by definition) nonhomogeneous and therefore the situation time cannot be a punctual portion of the time of the full situation. Rather, the situation time has the same duration as the time of the full situation. This means that a durative bounded situation cannot be located at a punctual time (such as t_0 or *at five o'clock*). However, a durative bounded situation may be referred to in a clause containing a punctual adverb as long as the description of the situation can be interpreted as inchoative or terminative. (For example, *The elephant will have a bath at four* locates the beginning of the bathing, not the entire process, at four o'clock).

2.30.1 When a durative situation is represented as L-bounded or interpreted as W-bounded, the situation time coincides with $-$, i. e. has the same length as $-$ the time of the full situation (because a bounded situation is by definition heterogeneous – see 1.45). It goes without saying that such a durative situation time cannot coincide with t_0 or with a punctual Adv-time, and cannot be contained in an Adv-time that is shorter than the time of the full situation.

*I write a book. (*A bounded durative situation cannot coincide with t_0 .*)

I am writing a book. (*Here the full situation is homogeneous, so that the situation time can be a punctual portion of the time of the full situation. That punctual situation time can be represented as coinciding with t_0 .*)

*I wrote a book at five o'clock. (*Ungrammatical because a bounded durative situation cannot coincide with (or otherwise be contained in) a punctual Adv-time.*)

I was writing a book at five o'clock. (*Here the full situation is homogeneous, so that the situation time can be a portion of the time of the full situation. Since that portion can be punctual, the situation time can be represented as coinciding with the punctual Adv-time.*)

2.30.2 The constraint that a durative bounded situation time cannot be contained in (= coincide with) a punctual Adv-time does not automatically render any combination of a punctual adverbial with a bounded description of a durative situation ungrammatical. If the adverbial specifies a past or future point of time, the combination is often grammatical on a special interpretation, viz. a *partly inchoative* or *partly terminative* reading. Compare:

At seven o'clock he was eating a three-course dinner. (*This sentence is fine on a coincidence interpretation because the progressive form represents the telic situation as nonbounded and homogeneous, which means that the situation time can be a punctual portion of the time of the full situation and can therefore be represented as coinciding with the punctual Adv-time denoted by at seven o'clock.*)

At seven o'clock he ate a three-course dinner. (*This sentence is ungrammatical if it is to express that the situation time coincided with the punctual Adv-time, because the nonprogressive form of a telic verb phrase represents the durative situation as bounded (and therefore as heterogeneous), which means that the situation time is also the time of the full situation, which is durative and therefore cannot coincide with a punctual Adv-time. However, when such a sentence is uttered by a cooperative speaker, a cooperative hearer will look for a suitable reading and assume the 'partly inchoative' interpretation 'He ate a three-course dinner and started doing so at seven o'clock'. Note that we speak of a 'partly inchoative interpretation' because '(purely) inchoative interpretation' means that only the beginning of the actualization is referred to. This is not the case in this example: the sentence asserts the actualization of the full situation. What is inchoative about it is that the time adverbial specifies only the beginning of the situation.*)

John came to the station at 4. (*The most suitable interpretation here is a 'partly terminative' one: 'John came to the station and arrived there at four.'*)

At 8 p.m. John will come here. (*Ambiguous between an inchoative reading – John will leave (somewhere) at 8 p.m. to come here – and a terminative reading – John will arrive here at 8 p.m. (having come from somewhere).*)

It should be noted that a partly inchoative or terminative reading is not automatically possible when a punctual Adv-time is combined with a durative-bounded description of a situation. Compare:

At five o'clock I wrote a letter.

*At five o'clock I wrote a book.

Only the former of these is acceptable on a partly inchoative reading. Given the minimal difference between the examples, it must be something pragmatic that blocks the partly inchoative reading of the second sentence. However, it is not at all clear what the blocking factor is. Granted that *at five o'clock* is pragmatically odd as a starting time for such a large enterprise as writing a book, a particular *day* should not sound absurd and yet the following are also completely unacceptable on an inchoative interpretation:

On 27th September I wrote a book. (*only acceptable if I wrote a complete book on 27th September*)

At the end of September I wrote a book. (*similar; there is no acceptable partly inchoative reading*)

2.31 The role of pure duration adverbials

2.31.1 Whereas a time-specifying adverbial indicates a (punctual or durative) Adv-time which contains the situation time of the situation referred to, a **PURE DURATION ADVERBIAL** like *for two weeks* only measures (i. e. indicates the length of) an interval of time. The interval in question is the time of the full situation, not the time of the predicated situation (i. e. the length of the situation time), unless the two coincide (see 2.16.2).

John told us that he was working in Portsmouth for two weeks. (*The situation time indicated by was working coincides with the (almost punctual) situation time indicated by told. For two weeks indicates the length of the full situation of John working in Portsmouth. In other words, for two weeks belongs to the description of the full situation: at the time of John's speaking, the situation of John-working-in-Portsmouth-for-two-weeks was in progress. Notice that the fact that the speaker knows about the length of the situation means that the situation must have been pre-determined, i. e. planned in advance.*)

(*telephone conversation with somebody travelling through France*) ["Where are you today?"] – "Today I'm here in Rennes until six. [At six I'm leaving for Paris.]" (*The situation time is that part of the time of the speaker's being in Rennes that coincides with t_0 . The adverbial until six indicates the duration of the remaining part – the part following t_0 – of the full situation of the speaker's being in Rennes. This knowledge is available to the speaker only if the full situation has been scheduled in advance. In other words, the adverbial forms part of the description of the full situation: what is going on at t_0 is the speaker's-being-in-Rennes-until-six. The situation time can be a punctual subinterval (of that full situation) which coincides with t_0 because I'm here in Rennes until six represents its situation as homogeneous: at any point between t_0 and six the speaker can truly say I am here in Rennes until six. Today refers to the whole of 'what counts as today' (here, roughly the working day); this Adv-time includes t_0 as well as the situation time coinciding with t_0 .)*)

I am only in my office for two hours. (*The situation time (= time taken up by the predicated situation) is that part of the time of the full situation that coincides with t_0 . The adverbial for two hours indicates the (pre-determined) duration of the full situation and belongs to the description of that situation.*)

John had come for two hours. (*For two hours can only indicate the duration of the time of the full situation. The only possible readings that are in keeping with this are 'John had come and stayed for two hours' or 'John had come with the intention of staying for two hours'.*)

2.31.2 There are a couple of cases in which the situation time coincides with the time of the full situation. In these cases a pure duration adverbial measures not only the length of the time of the full situation but also the length of the situation time.

- (a) The situation time and the time of the full situation coincide if the situation is L-bounded (see 1.44). In that case the predicated situation is represented

as heterogeneous (see 1.45), which means that it is incompatible with a time-specifying adverbial indicating an Adv-time that is shorter than the situation time (because the Adv-time has to either include the situation time or coincide with it – see 1.46.2). Compare:

I worked on my thesis for five and a half years. (*The situation time coincides with the time of the full situation because the duration-measuring adverbial represents the situation as bounded, i. e. as reaching a terminal point.*)

*Last week I worked on my thesis for five and a half years. (*The duration-measuring adverbial for five and a half years represents the situation as bounded, which means that the situation time is also the time of the full situation. The sentence is pragmatically unacceptable because the Adv-time specified by last week is too short to contain a situation time that lasts for five and a half years.*)

When I was in my twenties, I worked on my thesis for five and a half years. (*This time the Adv-time is long enough to contain the situation time.*)

- (b) In clauses in one of the perfect tenses, the period indicated by a duration adverbial with *for* again coincides with the time of the full situation. In addition, this period may sometimes be interpreted as being the period that leads up to t_0 or to a past or post-present binding orientation time.¹⁶ Compare:

For the past two years she has worked intermittently for various companies. (*The situation of working intermittently for various companies took up the whole of the past two years, i. e. the entire two-year period up to t_0 .*)

{*For / in} the past two years she has worked once or twice. (*For cannot be used because there is no reference to a situation of working once or twice which lasts throughout the two-year period up to now.*)

However, in some sentences (in one of the perfect tenses) the *for*-adverbial only indicates the length of the time of the full situation:

Have you ever been abroad *for longer than two weeks* [since you came to live here]? (*The relevant ‘period up to orientation time’ in which the present perfect tense locates one or more situation times is a ‘period up to t_0 ’. The for-adverbial indicates the duration of these situations (if any), not the length of the period leading up to t_0 .)*

[When I went to Australia] I had been away *for longer than two days* only twice in my life. (*The relevant ‘period up to a past orientation time’ presupposed by the past perfect is a period leading up to the past situation time of the when-clause. The for-adverbial specifies the duration of the full situations corresponding with the two situation times that are located in this period.*)

Under certain conditions a perfect tense can receive a ‘continuative’ interpretation, i. e. the reading in which the full situation starts before some orientation

16. As noted before, a ‘binding’ orientation time is an orientation time to which a situation time is temporally related by a tense (see 2.49).

time and continues up to (and into) the orientation time in question, as in *I'd been waiting for her for two hours [before she finally arrived]* – see 5.3.2. In that case the period whose length is specified by the durational adverbial is the time of the full situation (which is interpreted as containing the orientation time in question – see 5.3.2). This ‘time of the full situation’ is the time of actualization of the situation in the actual world. However, such a continuative interpretation does not exclude the possibility that the situation will continue in the (not-yet-factual) future world: *I've lived here since 1998* suggests that the situation may well continue after t_0 . The function of a *for*-adverbial accompanying a ‘continuative present perfect’ (= the representation, by means of a clause in the present perfect, of a situation as starting before t_0 and as still actualizing at t_0) is to specify the duration of the **FACTUAL FULL SITUATION**, i. e. the full situation covering the period up to t_0 plus t_0 itself, but leaves open the possibility that the actualization will continue in the (not-yet-factual) post-present, in other words that the **POTENTIAL FULL SITUATION** is longer than the factual one.

I've been waiting for her for two hours now. (For two hours now indicates the length of the factual full situation, i. e. the full situation as it has actualized up to now. Nothing is said about the length of the potential full situation.)

In two weeks' time Maggie will have been in prison for exactly three years. (For exactly three years specifies the length of the full situation up to the time (point) indicated by in two weeks' time. This situation is assumed to be a factual situation. The sentence leaves it vague whether or not this factual full situation will potentially extend beyond the post-present point indicated by in two weeks' time. Only world knowledge can tell us this, i. e. can tell us whether Maggie is due to serve exactly three years or more.)

2.32 Summary of section III

We have distinguished three types of adverbial that give temporal information. **Time-specifying adverbials** (e. g. *at seven o'clock*) temporally locate an orientation time (which may be a situation time) by specifying a particular time (an **Adv-time**) which may be durative or punctual and which contains (i. e. coincides with or includes) the orientation time. **Pure duration adverbials** (e. g. *for seven hours*) specify the length of time occupied by a full situation, but do not locate it in time. **Bifunctional adverbials** (e. g. *from six to eight*) both temporally locate a situation time and specify the length of the corresponding full situation. Thus in *Sam worked in the garden from six to eight*, the temporal adverbial locates the situation time (the time of the predicated situation) at the time indicated by *from six to eight* and measures the (time of the) full situation (as taking up two hours). To sum up: time-specifying adverbials locate orienta-

tion times (including situation times), pure duration adverbials measure the length of the time of a full situation, and bifunctional adverbials simultaneously locate a situation time and specify the length of the corresponding full situation time.

As we have seen, a time indicated by a **time-specifying adverbial** (= an Adv-time) **contains** the situation time (or other orientation time) whose temporal location it specifies. The situation time may be shorter than the Adv-time (i. e. it is included in it) or it may be exactly the same length (i. e. it coincides with it). In either case we can speak of **Adv-time-simultaneity**. Adv-time-simultaneity differs from W-simultaneity in that it is linguistically expressed and it is unlike T-simultaneity in that it is not expressed by a tense and it allows for a relation of proper inclusion as well as one of strict coincidence, though it does not allow for mere overlap. When there is more than one Adv-time in a clause, the relation between the Adv-times is also one of Adv-time-simultaneity – i. e. proper inclusion or coincidence.

When the Adv-time is punctual, the situation time, in order to be included in the Adv-time, must of necessity be punctual. A durative situation can be represented as simultaneous with a punctual Adv-time provided that the situation is homogeneous (nonbounded). (The situation time is then the time of a punctual portion of the situation which is representative of the whole situation.) The fact that a progressive clause can combine with an adverbial specifying a punctual Adv-time means that a progressive clause represents the predicated situation as a punctual situation which is representative of the longer full situation. When a durative situation is bounded, it is (by definition) nonhomogeneous and therefore the situation time cannot be a punctual portion of the time of the full situation. Rather, the situation time has the same duration as the time of the full situation. This means that a durative bounded situation cannot be located at a punctual time (such as t_0 or *at five o'clock*). However, a durative bounded situation may be referred to in a clause containing a punctual adverb as long as this adverb can be interpreted as indicating the beginning or end of the full actualizing situation. For example, *We'll have lunch at one p.m.* locates the beginning of the situation of having lunch, not the entire situation, at one o'clock. (This does not alter the fact that the speaker envisages the entire situation as actualizing in the future.)

In a given context, a time-specifying or bifunctional adverbial may contain (i. e. by inclusion or coincidence) a situation time, an orientation time other than a situation time, or several orientation times (usually situation times). We speak, respectively, of **situation-time adverbials**, **orientation-time adverbials** and **multiple-orientation-time adverbials**.

As we have seen, a **pure duration adverbial** measures the time of the full situation. In *Midge said that the baby was crying for two hours*, the predicated situation expressed by *the baby was crying for two hours* must be punctual

because it is T-simultaneous with the (more or less) punctual situation time indicated by *said*. However, the full, i. e. the implied, situation is measured as lasting for two hours. Usually the time of the full situation is longer than the time of the predicated situation and so the duration adverbial *only* measures the time of the full situation, but in some cases, notably when the situation is explicitly bounded, the situation time coincides with the time of the full situation. In those cases, of course, the adverbial time indirectly also measures the predicated situation.

DEMO

IV. The present and past time-spheres

2.33 The conceptualization of ‘time-spheres’

English tenses appear to reflect a mental division of time into past and nonpast. The main evidence for this is that all tenses carry either a past or a nonpast (present) tense morpheme. There is no future tense morpheme. We will represent this division of time as involving two time-spheres: a past time-sphere and a present time-sphere.

In English, the use of tenses implies a conceptual division of time into two ‘time-spheres’: the **PRESENT TIME-SPHERE** and the **PAST TIME-SPHERE**. (Note that a time-sphere is a length of time and should not be visualized as something spherical (round).)

The claim that English speakers conceptualize linguistic time as divided into two, not three (viz. past, present and future), time-spheres is based on several observations. Firstly, all the tenses make use of an inflectional tense morpheme which expresses either past or nonpast.¹⁷ There is no inflectional future tense morpheme in English: the future tense is formed with the help of the present tense form of an auxiliary (*will*), i. e. a ‘free’ morpheme rather than a ‘bound’ one. Thus, *will do* (which realizes ‘PRESENT + *will* + *do*’) contains a present tense inflectional morpheme, and *would do* (which expresses ‘PAST + *will* + *do*’) contains a past tense inflectional morpheme. Secondly, it is in keeping with this that the future tense use of *shall* and *will* has developed from their use as forms expressing *present nonepistemic modality* (more specifically, some kind of volition). Thirdly, in order to temporally relate a situation time to a future situation time, English uses the same tense system as it uses to temporally relate a situation time to t_0 : compare *I am ill* with [*Next time, he will pretend that*] *he is ill*, and *He has left* with [*I will do it when*] *he has left* (see 7.6.2). This means that English treats a future situation time which functions as a starting point for the temporal location of other situation times as a ‘pseudo- t_0 ’. This accords perfectly with the view that the post-present is a portion (‘zone’ – see 2.35) of the present time-sphere. (Note that this argument is not refuted by the observation that the present tense can also refer to the past, viz. in the ‘historic present’ use. The point is that in [*Next time, he will pretend that*] *he is ill* and [*I will do it when*] *he has left*, the forms *is* and *have left* cannot be replaced with *will be* and *will have left*, respectively, while a historic present form can

17. If the tense form consists of more than one verb form, the tense morpheme is always to be found in the first auxiliary (the so-called ‘operator’ of the tense form).

always be replaced by a past tense form. This means that the use of the present tense with future time reference is normal and obligatory in the above examples, whereas the use of the present tense with past time reference is special and optional.)

2.34 Defining the time-spheres

The past time-sphere lies wholly before t_0 , while the present time-sphere includes t_0 and extends either side of it for an indefinite amount of time.

2.34.1 The **PAST TIME-SPHERE** is conceived of as a timespan of indefinite length which lies wholly before t_0 and is disconnected from t_0 . The absolute tense locating a situation time in the past time-sphere is the preterite (past tense). (As explained in 2.41, an absolute tense is a tense that relates a situation time directly to t_0 and not to another orientation time.)

I left the house around midnight. (*Left locates its situation time in the past time-sphere, which is defined in direct relation to t_0*)

2.34.2 The **PRESENT TIME-SPHERE** (or **NONPAST TIME-SPHERE**) is conceived of as a timespan of indefinite length which includes t_0 .

2.35 Present time-sphere zones

The present time-sphere is conceived of here as containing the present zone, which coincides with t_0 , the pre-present zone, which leads up to t_0 , and the post-present zone, which begins immediately after t_0 . To locate a situation in one of these zones, we use the present tense, the present perfect or the future tense (or a futurish tense) respectively.

The zero-time (t_0) is taken to divide the present time-sphere into three **ZONES**. The portion of the present time-sphere that precedes t_0 is the **PRE-PRESENT ZONE**; the portion that coincides with t_0 is the **PRESENT ZONE**; and the portion that follows t_0 is the **POST-PRESENT ZONE** (or ‘future zone’). It should be stressed that these three zones follow each other without overlap. This means that the post-present starts from t_0 but does not include it, and that the pre-present

leads up to t_0 but does not include it. (In 5.2 it will be shown that the latter claim does not run counter to the observation that the present perfect receives a ‘continuative’ interpretation in *We’ve been living here for six weeks now.*)

To locate situations in these three zones we use the present perfect, the present tense and the future tense (or a ‘futurish form’ – see 2.9), respectively. Each of these tenses shows present (nonpast) morphology.

I have already spoken to John. (Have spoken is a present perfect tense form locating its situation time somewhere in the pre-present zone.)

I am very happy with her. (Am locates its situation time at t_0 .)

I {will / am going to} be there tomorrow. (Not only will be but also am going to be locates the situation time in the post-present. As noted in 2.13, the situation time is the time of the actualization of the predicated situation, not the time of anticipation of that actualization.)

2.36 Visual representation of time-spheres and zones

The linguistic conceptualization of time in terms of time-spheres and zones can be represented as in Figure 2.1. In this diagram the time line is represented as consisting of two time-spheres. The dotted line in the middle of the time line is meant to represent the fact that there is felt to be a break between the two time-spheres. (There is a slight but hard to avoid technical problem with this diagram: it makes the pre-present look as though it is more recent, i. e. closer to t_0 , than the past. That this impression is false is stressed in 2.39.)

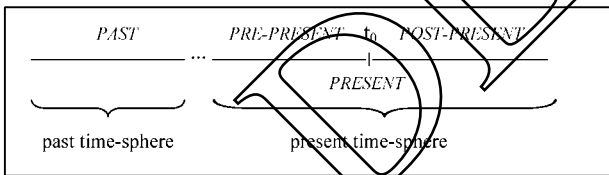

Figure 2.1. Linguistic conceptualization of the time line in English.

2.37 Absolute zones

The past time-sphere is conceived of as consisting of a single zone (the past time-zone). To locate a situation in the past time-zone we use the past tense. The four zones (pre-present, present and post-present plus past) that are defined in direct relation to t_0 are

called the ‘absolute’ zones. The tenses used to locate situations in these absolute zones are referred to as ‘absolute tenses’.

Whereas the present time-sphere is automatically divided into three zones by t_0 , the past time-sphere consists of a single time-zone, which is defined as lying completely before t_0 and as disconnected from t_0 . The past time-sphere and the three present time-sphere zones together constitute the set of **ABSOLUTE ZONES** (or **ABSOLUTE TIME-ZONES**), i. e. the four time-zones that are defined in direct relation to t_0 . (Note that ‘zone’ is equivalent to ‘time-sphere’ where the past is concerned and equivalent to ‘portion of the time-sphere’ where the pre-present, present and post-present are concerned.) (To a layman, the use of ‘time-zone’ to refer to t_0 may seem odd, because t_0 is conceived of as punctual, but the concept ‘punctual interval’ is well-established in the literature on tense.)

2.38 Past vs pre-present

Situation times that precede t_0 can in principle be located either in the pre-present zone or in the past time-sphere, but the choice depends on whether the speaker’s ‘temporal focus’ is on the present or on the past.

There is a generally accepted intuition that the use of the present perfect in English implies that the speaker is somehow concerned with the present (see 5.1.3). In our tense model this is reflected in the claim that the time of a situation referred to by a present perfect is not located in the past, but rather in the ‘pre-present’. Situation times that precede t_0 can in principle be located either in the pre-present zone or in the past time-sphere, but the choice depends on whether the speaker’s ‘temporal focus’ (see 11.1) is on the present or on the past. This explains why the present perfect is incompatible with adverbials like *yesterday*, *two weeks ago*, etc., which place the temporal focus on the past. The choice of temporal focus is more important than the notion of ‘current relevance’, because only the former has to do with the location of the predicated situation in time. Since tense is the grammaticalization of locating a situation in time by means of a verb form (see 2.1), adverbials of past time are incompatible with the present perfect, even if there is an idea of current relevance. This is clear from the following examples:

[I know what Paris looks like.] I *have visited* it several times.

[I know what Paris looks like.] I {*visited* / **have visited*} it several times two years ago.¹⁸

2.38.1 To avoid any misunderstanding, we would like to point out that a situation can be viewed as past even when it is represented as contained in an Adv-time (= adverbially indicated time interval) that also includes t_0 , as in *I had a copious breakfast today*. In this case the speaker has the situation time (which here coincides with the time of the full situation) in mind, which is a past situation time, even though it is included in a larger Adv-time which also includes t_0 . Here, as in other cases, the tense form does not relate the situation time to the Adv-time, but rather to an orientation time (in this case: t_0 , since *had* is an absolute past tense form).

2.39 The length of the time-spheres and zones

The present zone coincides with t_0 and is thus punctual. However, the length of the other zones is purely a matter of how they are conceptualized on a given occasion. (Compare *The elephant has just arrived* with *The Asian elephant has been worshipped for centuries*.) The interval between a past situation and t_0 does not determine whether the situation is located in a past time-zone or in a pre-present time-zone. (Compare *The elephant has just arrived* and *The elephant arrived just a moment ago*.)

Except for the present zone, which is by definition conceived of as punctual (see 2.35), the length of the time-spheres and the zones cannot be defined in terms of objective time. Everything depends on how the speaker conceptualizes time. For example, the pre-present can be conceived of either as very short (e.g. *I have just seen him*), or as stretching indefinitely far back (e.g. *The earth has existed for billions of years*), while the past time-sphere may be conceived of as distant from t_0 (e.g. *Things were different in ancient Rome*) or as almost reaching up to it (e.g. *The phone rang a minute ago*). It follows that one and the same situation can often be conceptualized either as lying in the past time-sphere or as lying in the pre-present (compare *I met Ann just now* with *I have just met Ann*). This is in keeping with the observation (made in 2.36) that the past time-sphere is not conceptualized as more distant from t_0 than the pre-

18. The constraint that the present perfect is incompatible with a past temporal focus is typical of English. It does not hold for other Germanic languages, like Dutch and German. Thus, the German and Dutch equivalents of **I have seen him yesterday* are perfectly grammatical: *Ich habe ihn gestern gesehen*; *Ik heb hem gisteren gezien*.

present zone. (The past time-sphere is conceived of as *separated* from the present time-sphere, whereas the pre-present zone forms part of it, but the actual distance between the situation time and t_0 is immaterial to this conceptualization.)

2.40 Present time-sphere tenses *vs* past time-sphere tenses

The past tense, the past perfect, the conditional tense, and the conditional perfect typically locate situation times in the past time-sphere. The present tense, the present perfect, the future tense and the future perfect typically locate situation times in the present time-sphere.

There are four tenses that typically represent a situation time as belonging to the past time-sphere. We call them the **PAST (TIME-SPHERE) TENSES**: the past tense, the past perfect, the conditional tense (realized as ‘*would* + infinitive’) and the conditional perfect (realized as ‘*would have* + past participle’). These tenses all involve a past tense inflectional morpheme.

The other four tenses typically represent a situation time as lying in the present time-sphere. We call them the **PRESENT (TIME-SPHERE) TENSES**: the present tense, the present perfect, the future tense and the future perfect. These tenses all involve a present tense inflectional morpheme.

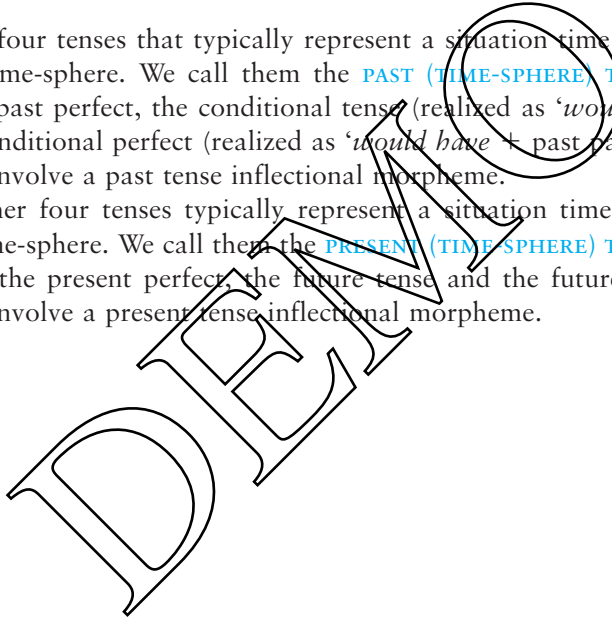

V. Temporal domains

2.41 Absolute tenses *vs* relative tenses

We have seen that an absolute tense relates a situation time directly to t_0 , whereas a relative tense relates a situation time to an orientation time other than t_0 .

2.41.1 An **ABSOLUTE TENSE** relates a situation time directly to t_0 . English has four absolute tenses: the present tense, the absolute past tense,¹⁹ the present perfect and the future tense. They locate the situation time in the present, past, pre-present and post-present time-zone, respectively.

A **RELATIVE TENSE** relates a situation time to an orientation time other than t_0 , i. e. to another situation time, an unspecified orientation time (see 2.14.c), an (otherwise unspecified) time contained in an Adv-time (see 2.14.d) or an implicit orientation time (see 2.14.e). Thus, the past perfect is a relative tense, because it relates its situation time as anterior to an orientation time which is not t_0 . For example, in *John said he had worked hard*, the past perfect represents the situation time of *had worked hard* as T-anterior to the situation time of *said*. The relative tense does not itself relate the time of working to t_0 , even though we can usually deduce that the working, as well as being T-anterior to the time of John's saying, is also W-anterior to t_0 . (However, this is not always the case, witness the fact that the situation referred to by *had cleaned* is interpreted as W-posterior to t_0 in *He said he would do it tomorrow after he had cleaned the floor*.)

2.41.2 While the four absolute tenses are always realized by the four forms referred to above, it will be argued below that the same forms may sometimes also have the function typical of relative tenses. This occurs either (in one case, that of the past tense) because there are two homonymous tenses or (in a second case, namely when a post-present domain is expanded) because the semantics of the set of absolute tenses is 'hijacked' for use in a relative manner.

2.42 Temporal domain

A temporal domain consists of various orientation times (situation times or not) which are temporally related to one another. Only the orientation time which establishes the

19. It will be argued in 2.44 that English has two past tenses: an absolute one and a relative one.

domain is directly related to t_0 . Together, they form a set whose relations we can represent in a diagram.

A temporal domain is typically established by an absolute tense (locating a situation time in a particular time-zone) and is expanded by relative tenses. In *Meg will buy a bike that has loads of gears* the future tense form *will buy* establishes a post-present domain. The present tense form *has* expands that temporal domain because it relates the situation time of the bike having loads of gears to the situation time of Meg's buying a bike. Specifically, it locates the having simultaneous to the buying. That is, the present tense in this sentence is used as a relative tense – it does not relate the situation time to t_0 but to another orientation time, in this case the situation time located by the future tense main clause.

A temporal domain need not be expanded: it may consist just of a single situation time, as in *Meg bought a bike*.

2.42.1 A **TEMPORAL DOMAIN** is a set of orientation times which are temporally related to each other by means of tenses. Since a domain is always established by a tense form and every tense form refers to a situation time, at least one of the orientation times in the set is a situation time. As we will see, a domain sometimes also contains an orientation time which is not a situation time, such as the unspecified orientation time to which the situation time of *had got up* is represented as anterior in *He had got up early that morning* when this sentence is used as the first sentence of a novel.

An absolute tense form always establishes a domain. This means that a domain can only be expanded by relative tense forms. Thus, in

- (1) John *said* he *was* tired because he *had worked* hard all day and that he *would go* to bed early.

the reference is to a past domain. This is established by the past tense form *said*, which is therefore an absolute tense form. The other tense forms are relative tense forms: *was [tired]* represents its situation time as T-simultaneous with the situation time of *said*, *had worked* represents its situation time as T-anterior to the situation time of *was [tired]* and *would go* represents its situation time as T-posterior to the situation time of *said*. See Figure 2.2.

2.42.2 When representing a temporal domain by means of a diagram, we will observe the following *conventions*. The domain is represented by a Venn-diagram because it is a set of orientation times (related to each other by the tense forms). The 'central orientation time' (= the situation time establishing the domain – see 8.15) is the only orientation time which is placed on the time line, since it is the only orientation time that is directly related to t_0 . A vertical

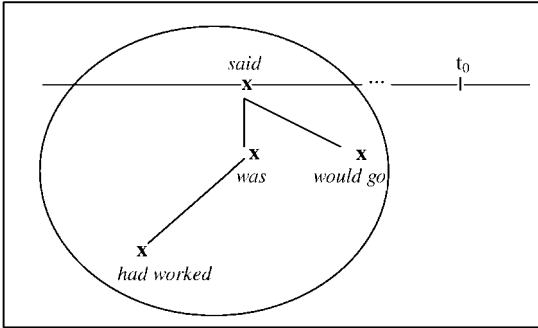

Figure 2.2. The tense structure of *John said that he was tired because he had worked hard all day and that he would go to bed early.*

line is used to represent the relation of T-simultaneity, whereas a slanting line represents either T-anteriority or T-posteriority. A situation time that is T-anterior to another orientation time is located to the left of the latter; a situation time that is T-posterior to another orientation time is located to the right of the latter. All orientation times and situation times are represented by a cross (or ‘x’), irrespective of whether they are durative or punctual.

2.43 Unexpanded domain

A temporal domain is **UNEXPANDED** if it consists of just one situation time: the set of orientation times forming the domain is a singleton. This is the case in *He left at five and I will leave at eight*, where both tense forms establish a domain of their own, which is not further expanded – see Figure 2.3.



Figure 2.3. The tense structure of *He left at 5 and I will leave at 8.*

2.44 Absolute and relative past tenses

As is shown in Figure 2.2, English has an **ABSOLUTE PAST TENSE**, which establishes a past domain, and a **RELATIVE PAST TENSE**, which expresses T-simultaneity in a past domain. The semantics of the absolute past tense is: ‘The situation time is located in the past time-sphere (defined relative to t_0)’; the semantics of

the relative past tense is: ‘The situation time is represented as T-simultaneous with an orientation time in a past domain’.²⁰ Arguments for this distinction are adduced in 8.23–32.

2.45 Past (time-sphere) tenses

The past (time-sphere) tenses comprise (a) the absolute past tense (creating a past domain), (b) the relative tenses expressing a single T-relation in a past domain, viz. the past tense (T-simultaneity), the past perfect (T-anteriority), the ‘conditional’ tense (T-posteriority), and (c) the ‘complex relative’ (see 1.18.3) tenses expressing two or more relations in a past domain at once, viz. the ‘conditional perfect’ tense (*would have V-en*), as well as such (nameless) tenses as are built with *had been going to*, *would be going to*, *would have been going to*, *had been going to have V-en*, *would be going to have V-en* and *would have been going to have V-en*. All these tenses have in common that they show past tense inflectional morphology.

2.46 Present (time-sphere) tenses

These comprise the present tense, the present perfect, the future tense and the absolute-relative tenses (see the next section). They all show present tense inflectional morphology.

2.47 Absolute relative tenses

An absolute-relative tense is a tense which both establishes a domain and indicates a relation in it. In English, the absolute-relative tenses are the future

20. This is actually a simplification. In section 10.2 we will see that a post-present binding orientation time may be treated as if it were t_0 , i.e. as a ‘pseudo- t_0 ’, and that in that case we can speak of a ‘pseudo-past time-zone’ and ‘pseudo-past subdomains’. A pseudo-past subdomain is established by a ‘pseudo-absolute’ past tense and expanded by the relative tenses typical of (true) past domains:

- (i) [Even if there are witnesses to the hold-up we are planning] they will no doubt say to the police that they *didn’t notice* what *was going on*.

In this example, *didn’t notice* is a pseudo-absolute past tense form establishing a pseudo-past subdomain in the post-present domain established by *will say*; *was going on* expresses T-simultaneity in that pseudo-past subdomain – see section 10.2.2. It follows that the correct definition of the semantics of the relative past tense is: ‘The situation time is T-simultaneous with an orientation time in a (pseudo-)past (sub)domain’.

perfect (*will have V-en*) – see Figure 2.4 – and such (nameless) present time-sphere tenses as are built with *has been going to* or *will be going to* (and, at least theoretically, *has been going to have V-en* and *will have been going to have V-en*.)

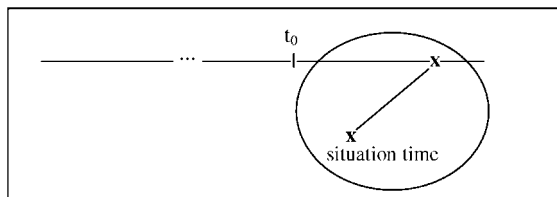

Figure 2.4. The tense structure of the future perfect.

2.48 Terminology: relative tenses *vs* absolute-relative tenses

The terms ‘relative tense’ and ‘absolute relative tense’ are not used in a uniform manner in the linguistic literature. For example, Comrie (1985) applies the label ‘relative tense forms’ to nonfinite verb forms (which express a single temporal relation with a contextually given orientation time – see 1.10.4), and refers to the past perfect as an ‘absolute-relative tense’ – a label which we reserve for the future perfect and for forms built with *will be going to* (see 2.47). We do not follow this practice. In section 1.10.4 we argued that nonfinite clauses are untensed, i. e. that only finite verb forms are tense forms.

2.49 Temporal subordination or (temporal) binding

A relative tense, by definition, requires the presence of some other orientation time in order to locate the time of the situation expressed by the relative-tense clause. (For example, such an orientation time is missing in *Meg had bought a bike*, rendering the clause difficult to interpret, while in *Meg said that she had bought a bike* we have a clearly accessible orientation time – the time of Meg’s saying – to which the relative tense, the past perfect, can relate its situation.) We say that the situation time located by a relative tense is ‘temporally bound’ by (or ‘subordinated’ to) the orientation time from which the temporal location of the situation time takes its starting point. (In the example above, the situation time of the buying is located by starting at the time of saying and locating the buying anterior to it.) In the same way, we talk of ‘binding orientation times’ and ‘bound situation times’.

When a situation time is T-related to another orientation time in a domain, we have **TEMPORAL SUBORDINATION** or **TEMPORAL BINDING**. Thus, in *John said he would do it*, the situation time of *would do* is ‘temporally bound by’ (or: ‘temporally subordinated to’) the situation time of *said*. (We know this because the conditional tense, in its purely temporal use, can only be used as a relative tense representing its situation time as T-posterior to another orientation time in a past domain. In other words, the conditional tense is the grammaticalization of the expression of T-posteriority in a past domain.) In this case the **BOUND SITUATION TIME** is the time of the predicated situation described by [*he*] *would do* [*it*], whereas the **BINDING ORIENTATION TIME** is the time of the predicated situation described by [*John*] *said*.

2.50 Temporal subdomain

The situation time which establishes a temporal domain is the ‘central orientation time’ of the domain. When a temporal domain is expanded, each situation time (if any) that is introduced into the domain is itself the central orientation time of a domain-within-a-domain, which we call a ‘temporal subdomain’, even if that domain is not expanded. Thus in *Meg said she bought a bike* the situation time of *she bought a bike* is the central orientation time of an unexpanded domain, whilst in *Meg said she bought a bike that didn’t have any brakes*, the situation time of *bought* is the central orientation time of a domain which is expanded by the bound situation time of the relative clause *that didn’t have any brakes*. In a past zone, tenses function in exactly the same way in temporal subdomains as in the temporal domains which they expand – i.e. the rules for relating situation times by means of tenses are recursive in a past zone. The same does not necessarily go for the three zones that make up the present time-sphere, but we nevertheless find that specific sets of tenses for expressing the set of temporal relations in a domain are re-used in other zones, so that the total number of tenses required to express temporal relations in all the temporal zones is very small.

2.50.1 A ‘temporal domain’ has been defined as a set of orientation times, containing at least one situation time – see 2.42. The set may consist of no more than one situation time, in which case the set is a singleton and we speak of an ‘unexpanded’ (see 2.43) domain. A set may also be an **EXPANDED DOMAIN**, in which case it contains several orientation times, each of which is related to another by a tense relation. In the same way as any multiple set contains subsets, which may be singletons, an expanded temporal domain contains subdomains, which may be unexpanded subdomains. That is, when we expand a temporal domain, each situation time that is introduced into the domain cre-

ates a **TEMPORAL SUBDOMAIN**, whose ‘central orientation time’ (i. e. the orientation time from which the first T-relations in the subdomain start) is the newly introduced situation time.²¹ It is important to see that the tenses used to express T-relations in a past subdomain are exactly the same as those used to express T-relations in the overall past domain. Consider, for example, the following:

Bill *said* something. (*Said* creates a past domain which is not further expanded.)

Bill *said* that some day I *would lose* my job. (*Said* creates a past domain which is further expanded: *would lose* expresses T-posteriority within the domain; *would lose* creates a past subdomain which is not further expanded.)

Bill *said* that some day I *would lose* the job that I *had had* for over twenty years. (*Would lose* expresses T-posteriority within the overall past domain established by *said* and creates a past subdomain; *had had* expresses T-anteriority in the subdomain created by *would lose*, thus expanding it; the new subdomain created by *had had* within the subdomain created by *would lose* is not further expanded.)

Ryan *said* Sheila *had told* him that she *would resign* if she *didn't get* her way. (*Said* creates a past domain. *Had told* expresses T-anteriority in it and creates a subdomain. In this subdomain, *would resign* expresses T-posteriority and creates a new, smaller, subdomain. Within this subdomain *didn't get* expresses T-simultaneity and in doing so creates a further subdomain.)

Figure 2.5 represents the tense structure of the last example.

2.50.2 There are some interesting theoretical conclusions to be drawn from this. First, in section 2.14 we defined ‘orientation time’ as ‘any time capable of functioning as the origin of a temporal relation expressed by a tense form’ and pointed out that it follows that a situation time (= the time of a predicated situation) is always an orientation time. We can now reformulate this and say that a situation time is always the central orientation time of a domain or subdomain. Secondly, the tenses expanding a subdomain of a past domain are exactly the same as those expanding the overall past domain: both past domains and past subdomains use the past perfect for T-anteriority, the conditional tense for T-posteriority and the past tense for T-simultaneity. This means that we need only a very limited number of tenses to build quite complex past domains, since the rules for expanding a past domain apply recursively to each of the subdomains. The same thing is not necessarily true of domains in the present time-sphere, but it will be shown in chapter 9 that the expansion of

21. In 2.42.2 we wrote that “The central orientation time is the only orientation time which is placed on the time line, since it is the only orientation time that is directly related to t_0 .” It is clear that this remark only applies to the central orientation time of an overall domain, not to the central orientation time of a subdomain.

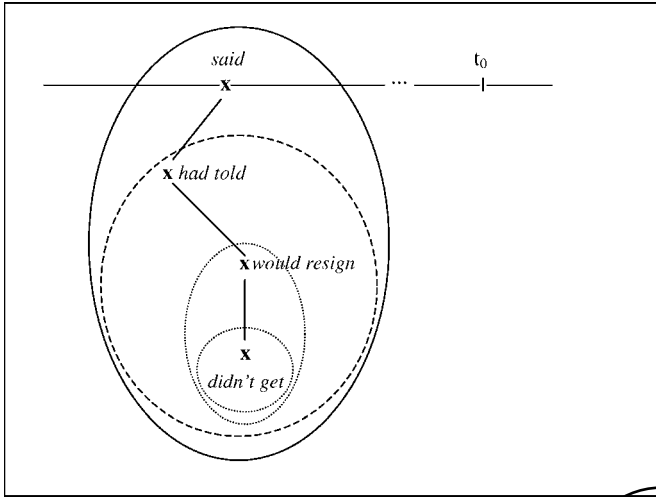

Figure 2.5. The tense structure of *Ryan said Sheila had told him that she would resign if she didn't get her way.*

pre-present and post-present domains is also governed by a limited number of rules. (Present domains cannot be expanded because a tense form relating a situation time to t_0 is by definition an absolute tense form, which therefore establishes a domain of its own – see 9.14.)

DEEMO

VI. Summary

2.51 The basic terminology of tense

We started this chapter with some basic terminology and definitions. These included terms such as ‘tense’, ‘temporal zero-time’, ‘orientation time’, etc. Below we review the definitions that have been given.

2.51.1 A **tense** is the pairing of a particular verbal form with a meaning, the meaning being the specification of the temporal location of a situation. A tense relates the temporal location of a situation to the temporal zero-point (see below), which is usually speech time, or to some other known time which is itself related either directly or indirectly to the temporal zero-point. A **tense form** may be an inflected main verb or a main verb plus one or more auxiliaries. Thus, in the future tense, the form ‘*will* + present infinitive’ is paired with the meaning (here slightly simplified) ‘location after speech time’.

2.51.2 Every tense expresses a **tense structure**. A tense structure is a blueprint for one particular way of locating a situation in time. The structure expresses the temporal relation between a situation time (see below) and a ‘known’ time, which we call an **orientation time**. If the orientation time is not speech time, the tense structure also characterizes the orientation time by reference to its ultimate (not necessarily direct) relation to speech time. For example, the past perfect locates a situation time prior to an orientation time which in turn either (a) directly precedes speech time or (b) is ultimately related to a time that precedes speech time. We will only consider the simpler case of (a) here. In *Meg announced that the elephant had arrived* the time of Meg’s announcement provides the orientation time before which the elephant’s arrival took place, and that orientation time itself precedes (= is past relative to) speech time.

2.51.3 Any time that can provide the known time required for the expression of the temporal relation(s) encoded in a tense form is an **orientation time**. There are five types of orientation time: t_0 , situation times, ‘unspecified’ orientation times (which are recoverable from the context), (otherwise unspecified) orientation times contained in an Adv-time, and ‘implicit’ orientation times (= times which are implicit in the structure of temporal conjunctions). An example of the last can be found in *I left before the elephant had arrived*. *Before* is analysed as meaning ‘before the time at which’. This means that our example is paraphrasable ‘I left before the time at which the elephant had (already) arrived’. This in turn means that the time of the elephant’s arrival is analysed, not as located posterior to my leaving, but as located anterior to an implicit time that is W-posterior to the time of my leaving. It is thus located prior to an implicit orientation time – the time that is explicit in the paraphrase ‘before the *time* at which’ – rather than prior to a situation time.

2.51.4 The **temporal zero-point** (t_0) is the time from which all the temporal relations expressed by a tense ultimately take their starting point. It is usually speech time. Although the temporal zero-point is nearly always speech time, in certain contexts it is possible for the speaker to choose the decoding time as t_0 . (For example, this is the case when a road sign reads *You are now entering Washington County*). Whether t_0 is the encoding time or the decoding time, English treats it as a point (rather than an interval). Thus durative situations cannot be located in their entirety at t_0 .

2.52 What counts as a tense?

2.52.1 We have examined various issues in connection with the number of tenses in English. We have seen that every tense ultimately involves the relation of a situation time to the temporal zero-point. Because nonfinite verbs (such as the gerund *riding* or the perfect infinitive *having ridden*) carry no indication of their (ultimate) temporal relation to t_0 , they cannot be said to be tense forms. However, a situation denoted by a nonfinite clause is interpreted as temporally related to some other time in the context (as simultaneous with it, for example, in the case of a present participle, or as anterior to it, for example, in the case of a past participle).

2.52.2 Sometimes, too, there is confusion about whether we can talk of ‘progressive tenses’. There are no progressive tenses – progressivity has to do with aspect, not tense. However, there are progressive verb forms when progressive aspect combines with a tensed form.

2.52.3 Another debate about the number of tenses that exist in English concerns the fact that the only temporal information that is encoded in verbal inflections is past *vs* present, or nonpast. For example, *likes* and *will* are morphologically present, or nonpast, and *liked* and *would* are morphologically past. Thus, on the view that tenses must be distinguished by inflectional morphemes, English has only two tenses: past and present. There is also a view that the fact that English has two temporal perspectives, past and present (reflected in the morphological facts) supports the two-tense analysis. However, we have argued above that there is no *a priori* reason why complex (multi-word) forms should not be considered to be tense forms, and the fact that English has two temporal perspectives reflects (or is reflected in) the fact that it has two *sets* of tenses, not that it only has two tenses.

2.52.4 A related issue concerns the question whether English has a future tense. A sentence that locates the actualization of a situation in the future is always ‘modal’ inasmuch as the actualization is by definition not-yet-factual at t_0 and involves a (to varying degrees) subjective judgement about the likelihood

of the future situation's actualizing. However, in many cases, 'will + present infinitive' is used primarily to express the future temporal location of the situation referred to. We have argued that the fact that this can be the main purpose of the form justifies its status as a tense form. In addition, we argue that for every tense structure that can be expressed, we can talk of a matching tense. Thus, because the form 'will + present infinitive' (e.g. [Meg] *will like* [*the elephant*]) expresses a structure which for the moment we can simplify as 'situation time posterior to speech time' and the present tense form (e.g. [Meg] *likes* [*the elephant*]) expresses the structure (again, temporarily simplified) 'situation time simultaneous with speech time' we claim that these are two different tenses.

2.52.5 We distinguish between 'pure future' uses of *will*, 'prediction' uses of *will*, and 'predictability' uses of *will*, according to the degree of subjectivity involved in the use of the form. (Predictability *will* takes a future time as the evaluation time for a statement about (usually) the present or the past. For example, *Don't worry, he will have taken a taxi home* is equivalent to 'It will become clear when we know the facts that he {has taken/took} a taxi home'.) All are instances of future tense. However, we have seen that there are other forms which have future time reference which require a more complex analysis.

2.52.6 Some forms in English have dual time reference: forms such as *be about to*, or the present progressive in *I'm leaving in a minute*, or, in some of its uses, *be going to*, evoke both the time of an implied present state (which is one from which a future outcome can be predicted) and the time of a future situation. (It is the actualization of the future situation which is the outcome predictable from the present state.) Only the future situation – the one associated with the lexical verb – is actually referred to. Such verb forms establish a future domain but are not future tense forms. We call them **futurish forms**. 'Be going to + verb' is a future tense form if it has pure future time reference and is a futurish form if it also implies a present state. (There is no clear cut-off point between the two uss.)

2.52.7 Finally, in our discussion of what counts as a tense we have considered the case of the present perfect. Some authors consider that the English present perfect is not a separate tense, but is rather a combination of another tense (present or past) and an aspectual meaning component, viz. 'current relevance'. However, we analyse the present perfect as having a tense structure different from that of the present tense or the past tense and consider it to be a tense in its own right. The present perfect locates a situation in the pre-present 'zone' (see 2.57.2) while the past tense locates it in the past zone. The claim that the present perfect has a different temporal structure from the past tense is supported by the fact that the two tenses behave differently with certain adverbs.

(In chapter 6 it will be shown that certain adverbs connected to the present combine with the present perfect but not with the past tense, and past time-reference adverbs dissociated from the present combine with the past tense but not with the present perfect.)

2.53 Full situation and predicated situation

A very important distinction that we have made is that between the ‘full situation’ and the ‘predicated situation’. When a clause is uttered, the full situation is the complete situation that the speaker implies (or the hearer infers) has actualized, is actualizing or will actualize, however long it turns out to be or to have been. The predicated situation is the part of the full situation which is actually located in time by the tense used. The predicated situation – the linguistically indicated situation – and the full situation – which is often inferred – may coincide with one another, or the predicated situation may be shorter than the full situation. It is the time of the actualization of the predicated situation that we have in mind when we speak of **situation time** in connection with tenses. (For example, when we say that a tense relates a situation time to an orientation time.)

2.54 What is (and is not) expressed by tenses

Here we have discussed absolute and relative tenses, semantically expressed and pragmatically implied temporal relations, and special uses of tenses.

2.54.1 As we have seen, the semantics of a tense are found in the structure of temporal relations that it represents. The tense structure may simply specify a relation between the situation time and t_0 . Such tenses are **absolute tenses**. An example is the past tense in *Meg jumped* when this sentence is used in isolation. Other tenses express tense structures which specify the relation of the situation time to an orientation time other than t_0 . These are **relative tenses**. An example is the past perfect in *She had just seen the elephant*.

2.54.2 An absolute tense establishes a ‘temporal domain’ (see further below), and relative tenses expand a temporal domain that has already been established. (In fact, as well as pure absolute tenses and relative tenses, English has **absolute-relative tenses**, such as the one used in *By Friday, the elephant will have arrived*. These both establish a temporal domain and express a temporal relation within it.)

2.54.3 Although relative tenses do not relate a situation time directly to t_0 , their structure does specify the temporal nature of the temporal domain in

which the situation time is located, and the nature of the temporal domain (past or post-present, for example) is determined by the location relative to t_0 of the orientation time that establishes the domain. For example, the tense structure of the past perfect specifies that the situation time is located anterior to an orientation time which is in a domain established by a past orientation time – i. e. a past domain.

2.54.4 As an example of the way a temporal domain is established and expanded, consider the two-sentence text *Meg jumped. She had just seen the elephant.* Here, the past tense form *jumped* establishes a past temporal domain. The tense structure of the past perfect sees to it that *had seen* is interpreted as locating the situation time of the second clause anterior to the situation time of the first clause, and this means that the second clause expands the temporal domain established by *jumped* by relating a new situation time to the one that is already in the domain.

2.54.5 We have stressed that the temporal relations established by tenses (**T-relations**) must be distinguished from those established by inferencing from the linguistic and nonlinguistic context (**W-relations**). For example, in *Meg went to the doctor. She felt ill.*, we have an absolute past tense in each sentence and these tense forms do not express a temporal relation between the two situations. However, our knowledge of the world leads us to infer that Meg went to the doctor because she felt ill and that therefore the situation described in the second sentence began before and continued during the situation described in the first sentence. A third type of temporal relation is that which holds between the time indicated by a temporal adverbial and a situation time. This will be called an **Adv-time relation**. We may also note the temporal relation between the time of the full situation and the time of the predicated situation (the situation time). The former contains the latter either in terms of inclusion or in terms of coincidence. When a situation is nonhomogeneous (bounded), the time of the full situation coincides with the situation time; when the situation is homogeneous (nonbounded), the time of the full situation may coincide with or include the situation time.

2.54.6 A situation time may be T-related to an orientation time in one of three different ways: it may be located simultaneous to, posterior to or anterior to the orientation time. The T-relation of simultaneity is always one of strict coincidence, not overlap or inclusion. When **T-simultaneity** is expressed between the situation times of clauses which refer to situations which are assumed to differ in length, we should remember that it is the time of the predicated situation, not the time of the full situation, that is involved in T-relations. Thus in *Meg said that she felt ill*, we argue that the second past tense is a relative past tense expressing T-simultaneity in a past domain (see below), and that the T-simultaneity holds between the punctual situation time of the com-

plement clause and the punctual situation time of the head clause, even though the implied full situation of *she felt ill* is durative. When a situation is located anterior to an orientation time it may be located at a certain distance before the orientation time or it may lead right up to the orientation time. In the same way, a situation located posterior to an orientation time may be located some time after the orientation time or may start immediately after it.

2.54.7 As we have seen, T-relations are temporal relations expressed by tenses, between the times of predicated situations (i.e. situation times) and orientation times. W-relations are temporal relations, inferred from contextual information, between the times of full situations and orientation times. **W-simultaneity** occurs when any point of one full situation coincides in time with any point of another full situation: strict coincidence of the times of the entire situations is not necessary.

2.55 Special uses of tenses

2.55.1 We have pointed out that some uses of tenses either are or appear to be at odds with the core meaning of the tense. To begin with, there are ‘modal’ uses of tense. Past tenses (including the past perfect and the conditional tense) can be used to express tentativeness or unreality. The tentativeness may be social, as in *I thought you might like this book*, or it may concern the likelihood of actualization of a situation, as in *If you wanted to, you could write a book*. Both tentativeness and unreality are standardly expressed by past tenses in conditional sentences, as in the counterfactual *If I were President, I would cancel third world debt* and the tentative *It would be a great help if she gave me the recipe*.

2.55.2 The second special use of tenses that we mentioned involves a **shift of temporal perspective**. When the temporal location of a situation is obvious from the context, it is sometimes possible for a speaker to represent the situation as lying in one time-zone whilst *apparently* locating it in another time-zone. In that way, by relying on the hearer to establish the temporal location from the context, the speaker combines correct time reference with the connotations of location in a different time-zone. For example, *The train leaves at eight* represents a post-present situation as if it is already the case, thus emphasizing that the future is in this case seen as already fixed.

2.55.3 An apparently special use of the present tense is found in ‘universal’ sentences, which refer to a state which holds at all times. Such sentences may cite universal truths or they may refer to permanent characteristics (including habits). For example: *Elephants never forget*. However, these are actually not special uses of the present tense, since characteristics are states and hence

homogeneous situations and the present tense thus locates a punctual situation time – which represents the time of a representative punctual section of the full situation – simultaneous with speech-time, in accordance with the meaning of the present tense (viz. ‘The situation time is T-simultaneous with the zero-point’).

2.56 Types of temporal adverbials

2.56.1 We have distinguished three types of adverbial that give temporal information. **Time-specifying adverbials** (e.g. *at six o'clock*) temporally locate an orientation time (which may be a situation time) by specifying a particular time (an **Adv-time**) which may be punctual or durative and which contains (i.e. coincides with or includes) the orientation time. **Pure duration adverbials** (e.g. *for six hours*) specify the length of time occupied by a full situation, but do not locate it in time. **Bifunctional adverbials** (e.g. *from six to eight*) both temporally locate a situation time and specify the length of the corresponding full situation. Thus in *Meg watched the elephant from six to eight*, the temporal adverbial locates the situation time (the time of the predicated situation) at the time indicated by ‘from six to eight’ and measures the (time of the) full situation (as taking up two hours). To sum up: time-specifying adverbials locate orientation times (including situation times), pure duration adverbials measure the length of the time of a full situation, and bifunctional adverbials simultaneously locate a situation time and specify the length of the corresponding full situation time. Below we review what has been said about the first two of these types of temporal adverbial.

2.56.2 As we have seen, a time indicated by a **time-specifying adverbial** (= an Adv-time) ‘contains’ the situation time (or other orientation time) whose temporal location it specifies. The situation time may be shorter than the Adv-time (i.e. it is included in it) or it may be exactly the same length (i.e. it coincides with it). In either case we can speak of **Adv-time-simultaneity**. Adv-time-simultaneity is unlike W-simultaneity in that it is linguistically expressed and it is unlike T-simultaneity in that it is not expressed by a tense and it allows for a relation of proper inclusion as well as one of strict coincidence, though it does not allow for mere overlap. When there is more than one Adv-time in a clause, the relation between the Adv-times is also one of Adv-time-simultaneity – i.e. proper inclusion or coincidence.

2.56.3 When the Adv-time is punctual, the situation time, in order to be included in the Adv-time, must of necessity be punctual. A durative situation can be represented as ‘Adv-time-simultaneous’ with a punctual Adv-time provided that the situation is homogeneous (= nonbounded). (The situation time is then

the time of a punctual portion of the situation which is representative of the whole situation.) The fact that a progressive clause can combine with an adverbial specifying a punctual Adv-time means that a progressive clause represents the predicated situation as a punctual situation which is representative of the longer full situation. When a durative situation is bounded, it is (by definition) nonhomogeneous and therefore the situation time cannot be a punctual portion of the time of the full situation. Rather, the situation time has the same duration as the time of the full situation. This means that a durative bounded situation cannot be located at a punctual time (such as t_0 or *at five o'clock*). However, a durative bounded situation may be referred to in a clause containing a punctual adverb as long as the description of the situation can be interpreted as inchoative or terminative. (For example, *The elephant will have a bath at four* locates the beginning of the bathing, not the entire situation, at four o'clock.)

2.56.4 In a given context, a time-specifying or bifunctional adverbial may contain (i. e. by inclusion or coincidence) a situation time, an orientation time other than a situation time, or several orientation times (usually situation times). We refer, respectively, to **situation-time adverbials**, **orientation-time adverbials** and **multiple-orientation-time adverbials**.

2.56.5 As we have seen, a **pure duration adverbial** measures the time of the full situation. In *Meg said that the elephant was bathing for two hours*, the predicated situation expressed by *the elephant was bathing for two hours* must be punctual because it is T-simultaneous with the (more or less) punctual situation time indicated by *said*. However, the full, i. e. the implied, situation is measured as lasting for two hours. Usually the time of the full situation is longer than the time of the predicated situation and so the duration adverbial *only* measures the time of the full situation, but in some cases, notably when the situation is explicitly bounded, the situation time coincides with the time of the full situation. In those cases, of course, the adverbial time indirectly also measures the predicated situation.

2.57 The conceptualization of time that tenses encode

2.57.1 We have discussed the way in which tenses in English appear to encode a specific way of dividing up time. First, English tenses reflect a division of time into past and nonpast. The main evidence for this is that all tenses carry either a past or a nonpast tense morpheme. There is no future tense morpheme. We represent this division of time as involving two time-spheres: a **past time-sphere** and a **present time-sphere**. The past time-sphere lies wholly before t_0 , while the present time-sphere includes t_0 and extends on either side of it for

an indefinite amount of time. The past tense, the past perfect, the conditional tense, and the conditional perfect typically locate situations in the past time-sphere. The present tense, the present perfect, the future tense and the future perfect typically locate situations in the present time-sphere.

2.57.2 Second, the two time-spheres contain **zones** (or ‘time-zones’). The present time-sphere is conceived of as containing the ‘present zone’, which coincides with t_0 , the ‘pre-present zone’, which leads up to t_0 , and the ‘post-present zone’, which begins immediately after t_0 . The past time-sphere is conceived of consisting of a single zone (the ‘past time-zone’). To locate a situation in one of these four **absolute zones** we use the present tense, the present perfect, the future tense (or a futurish form) and the past tense, respectively – i. e. the four absolute tenses. Situation times that precede t_0 can in principle be located either in the pre-present zone or in the past time-sphere: the choice depends on whether the speaker’s **temporal focus** is on the present or on the past.

2.57.3 The present zone coincides with t_0 and is thus punctual. However, the length of the other zones is purely a matter of how they are conceptualized on a given occasion. (Compare *The elephant has just arrived* with *The Asian elephant has been worshipped for centuries*). The length of the interval between a ‘bygone’ situation and t_0 does not determine whether the situation is located in a past time-zone or in a pre-present time-zone. (Compare *The elephant has just arrived* and *The elephant arrived just a moment ago*).

2.58 Establishing and expanding temporal domains

2.58.1 A temporal domain consists of a set of various orientation times (situation times or not) which are temporally related to one another. (When the domain consists of just one orientation time, we speak of an **unexpanded domain**). Only the orientation time which establishes the domain is directly related to t_0 . The use of an absolute tense always establishes a temporal domain. A relative tense, by definition, requires the presence of some other orientation time in order to locate the time of the situation expressed by the relative-tense clause. To express this relationship, we speak of **temporal binding** or **temporal subordination**: the situation time of the relative-tense clause is temporally bound by the orientation time from which it takes its temporal location.

2.58.2 The situation time which establishes a temporal domain is the **central orientation time** of the domain. When a temporal domain is expanded, each situation time that is introduced into the domain (if any) is itself the central orientation time of a domain-within-a-domain, which we call a **temporal subdomain**, even if that domain is not expanded. Thus in *Meg said she bought a bike* the situation time indicated by *bought* is the central orientation time of

an unexpanded subdomain, whilst in *Meg said she bought a bike that didn't have any brakes*, the situation time indicated by *bought* is the central orientation time of a subdomain which is expanded: the situation time of the relative clause, indicated by *didn't have*, is T-simultaneous with the situation time of *she bought a bike*.

2.58.3 As explained at greater length in chapter 8, we argue that in English, in addition to the absolute past tense, there exists a homonymous **relative past tense** whose semantics is 'T-simultaneity with (= coincidence with) an orientation time in a past domain'. This means that the set of relative tenses for the past time-sphere consists of the relative past tense, the past perfect, the conditional tense and the 'complex relative' tenses such as the conditional perfect. There are no forms specific to relative tenses in the present time-sphere. It is not possible to expand a present temporal domain and the expression of temporal relations in both the pre-present zone and the post-present zone depends on re-using forms whose core meaning is something other than the expression of a temporal relation in a present time-sphere domain.

Directly related to this, we find that in a past zone, tenses function in exactly the same way in temporal subdomains as in the temporal domains which they expand – i. e. the rules for relating situation times with past time-sphere tenses are recursive. The same does not go for the two present time-sphere zones that can be expanded, but we nevertheless find that specific sets of tenses for expressing the set of temporal relations in a domain are re-used in other zones, so that the total number of tenses required to express temporal relations in all the temporal zones is very small.

DELETED

3. The absolute use of the present tense

I.	The basic meaning and use of the absolute present tense	173
3.1	The present tense establishing a present domain	173
II.	The present tense as part of the ‘Special Present Time-sphere System’	176
3.2	Definition	176
3.3	The historic present	176
3.4	The present tense expressing combined past and present time reference	178
3.5	The present tense as unmarked tense	179
3.6	Pre-present situations represented as if present	180
3.7	The nonprogressive present in <i>wh</i> -questions expressing a suggestion	181
3.8	The nonprogressive present referring to a pre-determined post-present situation	181
3.9	The progressive present referring to an arranged future situation	183
3.10	Constraints on the use of the present tense with post-present time reference	184
3.11	The present tense substituting for a ‘continuative perfect’	188
III.	Summary	190

DEMO

Abstract

While chapters 1 and 2 provided the conceptual foundations for a theory of the tense system in English, the present chapter, addressing the present tense, is the first in a series of chapters that use this theory to describe in detail how tenses are used in English discourse.

In part I we describe the most basic use of the present tense, which is to establish a present domain, as in *I wish you a merry Christmas* or *I am working*.

In part II (3.2–3.11) we discuss some special uses of the present tense. Many of these involve

a ‘shift of temporal perspective’. Such a shift is clear in the case of the ‘historic present’, where a past situation is represented as if it were happening at the time of speech. We also address several other cases, particularly those in which present tense forms are used for situations which are to be interpreted as actualizing in the future, e.g. *The sun sets at 9.36 tomorrow* or *I’m staying at the Gardners’ next week*.

Part III provides a summary of the chapter.

DEMO

I. The basic meaning and use of the absolute present tense

3.1 The present tense establishing a present domain

The meaning of the absolute present tense is that the situation time (i. e. the time of the predicated situation) coincides with t_0 . Since t_0 is a point, the situation time is a point. If the full situation is punctual, the situation time coincides with the time of the full situation and the full situation is located at t_0 . If the full situation is durative and heterogeneous, we cannot locate the situation time at t_0 . If the full situation is durative and homogeneous, then the situation time can be a punctual subinterval of the time of the full situation and that punctual subinterval can be located at t_0 . *I live here* locates a punctual subinterval of the full situation of ‘living here’ at t_0 . Similarly, we can say *I’m making a wheelchair at the moment* or *I use a wheelchair* (both referring to homogeneous situations) but not **I make a wheelchair at the moment* (because the reference is to a heterogeneous situation).

3.1.1 In its basic use, the absolute present tense establishes a present ‘temporal domain’ (see 2.15.4) by locating its situation time as coinciding with t_0 , which (at least in English) is by convention conceived of as punctual (i. e. lasting no longer than a moment) – see section 2.4. (The zero-time thus resembles a punctual Adv-time in that the situation time coincides with it. However, a punctual Adv-time differs from t_0 in that it needs to be specified by a time adverbial whereas t_0 does not because it is ‘given’ whenever we speak.) Since the situation time coincides with t_0 and t_0 is punctual, the situation time must be punctual too. This means that the relation between the situation time and the time of (actualization of) the full situation must be of one of the following two types.

- (a) One possibility is that the full situation is punctual (and therefore has to be represented as punctual). In that case the situation time coincides with the time of the full situation and is therefore punctual too.

[Now watch closely.] *I hit the nail once with a hammer.*

Such an inherently punctual situation cannot be represented as in progress. If the progressive form is used (which represents the situation as durative), the interpretation is an iterative one: *I am hitting the nail (*once) with a hammer.* (The progressive form *am hitting* is also possible in special contexts, e. g. when the speaker is commenting on slow motion pictures, or when the virtually

punctual situation is ‘frozen’ in its middle, as in *In this photograph I’m hitting a nail with a hammer.*)

Sometimes a full situation which has a certain (restricted) duration in the actual world is represented as if it were punctual. This is the case, for example, in nonprogressive present tense sentences expressing a **PERFORMATIVE SPEECH ACT**:

I wish you a merry Christmas. (*This is a ‘performative sentence’, i. e. it is by uttering this sentence that the speaker performs the speech act of wishing the hearer a merry Christmas.*)

I *pronounce* you man and wife.

I *declare* the meeting closed.

[You can start looking for another vocalist for the band.] I *quit*.

In these examples the full situation (and hence the situation time) is represented as if it were punctual. (This does not mean that all these situations are inherently punctual, i. e. that they cannot be represented as durative. This is clear from the fact that their progressive counterparts yield an ‘in progress’ reading rather than an iterative interpretation:

I am pronouncing you man and wife. (= ‘I am in the process of pronouncing you man and wife’.)

Needless to say, such a progressive sentence is not interpreted as performative.)

(b) The second possibility for the situation time to coincide with t_0 is when the situation time is conceived of as constituting a proper subpart of the time of the full situation. This possibility requires that the predicated situation (see 2.12.1) is representative of the durative full situation, in other words that the clause referring to the full situation is homogeneous. As noted in 1.66, a sentence is homogeneous if it can be used to describe not only the situation as a whole but also relevant portions of it.

I am working. (*homogeneous: if I am working for a certain time, then I am working is a suitable description of any part of the situation that coincides with a t_0 .*)

My wife is in the shop. (*similar*)

She is a clever woman. (*similar*)

Right now I {am reading / *read} a book. (*Unlike the progressive form, the nonprogressive form represents the telic situation as bounded and hence as nonhomogeneous – see section 1.45. Since the nonprogressive sentence describing the durative full situation is not homogeneous, the situation time cannot be punctual. This renders the sentence ungrammatical because only punctual situation times can coincide with t_0 .*)

In sum, when we say *John is in the kitchen*, strictly speaking, we only predicate something about a point in time. However, the W-interpretation in terms of a

situation that lasts for a longer time is very ‘real’ and is no doubt the one that most people would indicate when asked to indicate what (temporal) information is conveyed by such a sentence. This shows that there is a considerable input of pragmatics even when we process the temporal information of very ‘basic’ sentences – something we have already pointed out in 2.18.

3.1.2 Since an absolute present tense form expresses no more than that the situation time coincides with t_0 , and since the situation time may be either the time of the full situation (if the situation is punctual) or a punctual subinterval of the full situation (if the situation is conceived of as homogeneous), the present tense does not say anything about the length of the (actualization of the) full situation in the real world. It can therefore be used irrespective of whether the full situation is viewed as punctual or durative.

Here comes the winner! (*The situation time is punctual while the full situation has a certain (limited) duration. The sentence is therefore treated as homogeneous.*)

It’s drizzling. (*The full situation is durative and represented as homogeneous; the situation time is punctual because it coincides with t_0 .*)

He works as a history teacher at the local boys’ school. (*The full situation is a permanent habit.*)

Our teacher speaks Swedish fluently. (*The full situation is a permanent ability, which is a kind of characteristic state.*)

I like every kind of perfume. (*The full situation is a permanent characteristic.*)

The full situation is interpreted as having maximal duration in ‘universal sentences’ (expressing an eternal truth – see 2.21):

The sun sets in the west.

Ice melts at zero degrees Centigrade.

Paris lies on the Seine.

II. The present tense as part of the ‘Special Present Time-sphere System’

In English it is possible – in well-defined contexts – to use the set of present time-sphere tenses to refer to situations that are understood to actualize in the past, the pre-present or the post-present.

3.2 Definition

We will use the term ‘**SPECIAL PRESENT TIME-SPHERE SYSTEM**’ to refer to a systematic use of present-time-sphere tenses which is special in that the present tense is used, not because the situation referred to actualizes (or is actualizing) at t_0 , but for another reason. (We speak of ‘system’ because the other present time-sphere tenses – present perfect and future tense – are involved as well – see 3.3.2.) In the various usages of the Special Present Time-sphere System, the choice of the present tense represents a ‘shift of temporal perspective’ (see 2.20) or is motivated by the fact that the present tense is the unmarked tense in the English tense system, i.e. the tense with the simplest semantics and forms. In the following sections we examine the most typical uses of the present tense in the Special Present Time-sphere System.

3.3 The historic present

The historic present locates the situation time of a past situation in the present for dramatic effect. The hearer knows that the situation is in the past although it is represented as if it were present.

3.3.1 In the **HISTORIC PRESENT**, a past situation is represented as if it were a present situation. This use is therefore an example of a ‘shift of temporal perspective’ (see 2.20). The historic present is generally assumed to be a means of describing a past situation vividly, as if it were actualizing in the speaker’s and hearer’s here-and-now.

So yesterday we’re all sitting on the couch in the living room when Dexter *walks* in through the door holding a still live bird in his mouth. And he then *proceeds* to toss it around and kill it in front of us. [...] That cat is insane. (www)

Suddenly a man in uniform *takes* me by the arm and *asks* me what I’m *doing* there.

So this drink *turns up* at the counter in a plastic cup. It's murky and *looks* horrible as [if] it's *got* some kind of mocha colored whipped cream on top that's all flat and falling into the drink. (www)

We frequently find such sentences in the historic present intermixed with past tense sentences and combining with adverbials indicating a past Adv-time. Such co-occurrence is not surprising because the felicitous use of the historic present depends, of course, on its being clear that the time reference of the present tense is past.

Suddenly the door swings open and a man rushes into the room. He snatches Maud's handbag from her hand and disappears through the French windows. We *were* so flabbergasted that he *was gone* before any one of us *reacted*.

Last week I'm watching 'Newsnight' on television when suddenly there's a terrific explosion. You'll never believe this, but my whole TV-set *was gone*; it *had*, as they say, '*imploded*'.

So *last week* I'm with a client, discussing the finer points of navigating a new release of their flagship web application. We *had come* to easy consensus on virtually every aspect of the design save one, and the group around the table *was* pretty evenly divided on just how the function should be implemented on the page. (www)

So *yesterday*, we're just driving home and we see the Brazil Nut so we stop and chat. She *was* pleased to see us, well Tallboy in particular, because she *needed* someone who was au fait with things electric. The lawnmower *wasn't working* properly, the handles should come up as soon as it switches on and is pulled backwards. Tallboy isn't one to refuse a mending challenge, so once the shopping has been unloaded and put away, we wander over. (www)

As is clear from these examples, the sentences in the past tense usually belong to the 'background', not to the 'foreground' (= the 'backbone' of the story). That is, they do not normally belong to the narrative clauses that move the story forwards.

3.3.2 The historic present is actually only one tense in a special system, in which T-anteriority is expressed by the present perfect and T-posteriority by the future tense (or by a futurity form – see 2.9).

Do you know what John *did* to me the other day? Well, just as I *was leaving* for the office, he comes in and tells me I've won on the pools and some big chap is going to come and pay me over a million pounds. I nearly *fainted* on the spot. And two minutes later he tells me it's all a hoax and I haven't won anything at all.

Well before going into the clothes I *got* this bright idea, I will go to the magazines and get a hair style magazine first. So I *did*. Well I *was looking* at clothes, I *sat* the magazine down on the rack. Totally forgetting about it. Well I *got* disgusted about the clothing selection and just *decided* to leave. As I *was walking out* I *reached* in my pockets to get my keys, so I *was* kind of standing just outside the doors. This gentleman (if you want to call him that) approaches me, and says 'Did you enjoy

the magazines, miss?’ Baffled by his question, I turn to him and say ‘Excuse me?’ He grabs my shirt and starts searching me, and tells me the cops are on the way. I am very mad at this point I swear a lot, jerk away and I leave crying. [...] I go home and decide that I am going to call Wal-Mart. So I call and demand to speak to a manager. (www)

However, the fact (referred to in 3.3.1) that speakers sometimes alternate between present zone tenses and past zone tenses has the (very interesting) effect that anteriority to a situation referred to by a clause with a historic present tense form can be expressed by means of a past perfect form, and that posteriority can be expressed by means of a conditional tense form:

So, Bob Dylan *had* just *finished* singing with The Byrds which was the back of the Mr. Tambourine album – whatever that thing was called – and this girl and I are talking and here comes Bob Dylan. So I figure I owe him a favour because he’d *fed* us, y’know, so I *said* to the girl, ‘Look over there! Isn’t that where he is? – he’s going over there’. [...] So she goes away with her baby and ... (www)

Then he wanders away from the microphone and the other people on stage *started* hugging and kissing him. So there I am, on stage, packed hall, TV cameras in my face, singing with the band. I *was thinking* to myself ‘where the fuck is he, HELP!’ But no, he *wasn’t coming* back to the mic, so I continue singing hoping that I *wouldn’t forget* the words to a song I *hadn’t heard* for years. I then *went* over to the guitarist and *got* him to sing a few lines with me, and of course by then I *was* really *getting* into it and *took* control of the stage. (www)

3.3.3 The use of the historic present is conventionalized in synopses of novels or plays, in historical summaries, tables of date, references to publications, etc.

That night Cinderella *goes* to the ball in the clothes the fairy has given her.

It is then that David Copperfield *decides* to run away from his horrible stepfather.

The Book of Exodus *relates* how the Israelites *leave* Egypt, pursued by the Pharaoh, and *wander* through the desert for many years.

May 1940 – Hitler *invades* Belgium and the Netherlands.

February 1944 – Belgium *is* still an occupied country.

In his review of my book, C.N. Smith *writes* that he fails to see the relevance of ...

3.4 The present tense expressing combined past and present time reference

When a past situation is reproduced (visually or orally) at the zero-time, formulaic usage may use the present tense to refer to the reproduction rather than to the original

situation, while simultaneous reference to the past situation nevertheless takes place via the reference to the reproduction.

3.4.1 There are some cases in which the speaker can use the present tense to refer to a past situation because this situation is somehow made visible in the present. Captions underneath a photograph or painting representing a historical situation form a typical example:

(caption underneath a photograph showing President Carter in Ireland) President Carter *meets* the Irish Prime Minister in Dublin.

(caption) The Queen *visits* Saint Mary's college in 1991.

This use of the present tense need not be analysed as a 'shift of temporal perspective' from the past to the present because the situation described is in a certain sense present in the reader's here-and-now. (Remember that t_0 may sometimes be the time of decoding the message rather than the time of coding it – see 2.11.1.)

3.4.2 As another illustration, we can refer to cases where a TV sports commentator is commenting on a replay of some event. Here too, the speaker may shift between past time reference and present time reference, but the use of the present is different from the 'classic' case of story-telling: the commentator may revert to the present tense because he or she is referring to a scene effectively actualizing at the present moment even if both commentator and viewers know it 'really' occurred some seconds or minutes ago. The commentator's shift from a past to a present frame of reference in 'REPLAY COMMENT' (= comment on a replay) does not involve the representation of some past situation *as if* it were present. Instead, television creates a set of conditions where the situation 'really obtains' both in the past and in the present, and where the shifts back and forth from a past to a present frame of reference are therefore warranted by the double location of the situation on the 'real' time line.

3.5 The present tense as unmarked tense

In a few very clearly defined contexts, the present tense may be used when it is not important to give explicit information about the temporal location of a situation.

In some cases the choice of the present tense is motivated by the fact that the present tense is the unmarked tense in the English tense system, i. e. the tense

with the simplest semantics and forms. A typical example of such a use of the present tense as unmarked tense is to be found in a standard joke style:

Two atoms *are sitting* next to each other and chatting, and the first atom *says* “You know, I lost an electron yesterday.” “Are you sure?” *asks* its friend. The first atom *smiles*. “Yes,” it *says*. “I’m positive.” (www)

Newspaper headlines provide another illustration:

(Brighton) Man *bites* leopard. Both now in hospital.
Two gangsters *escape* from the Old Bailey.
Typhoon *ravages* East Malaysia.

It is typical of headlines that a simplified language is used: marked forms are generally replaced by unmarked ones. The omission of articles (marking definite or indefinite reference) and of the linking verb *be* forms part of this process, and so does the use of the present tense when the reference is really to a past situation.

3.6 Pre-present situations represented as if present

When news has recently been received, the source of the news (e.g. the telling or the hearing) can be referred to using a verb in the nonprogressive present tense.

The nonprogressive present tense can be used to refer to a pre-present speech act that is still relevant at t_0 . This shift of temporal perspective is only possible with verbs of communication, i.e. verbs referring to the encoding, the reception, or the mental decoding of the message.

I *hear* you’re going to buy a new car.

Gayle O’Connor, our division’s immediate past chair, *writes* that she will be presenting two programs to the Legal Services Corporation-Access to Justice Foundation. (www)

I *learn* from your letter that you are not happy with your position.

They *tell* me you’ve just been to Greece.

I *am informed* that your contribution is long overdue.

I *see* there’s been another earthquake in Turkey.

I {*gather* / *understand*} he left the firm rather suddenly.

This use of the present tense is conventionalized to the point that in most of the examples above, a present perfect would sound decidedly odd, if not quite

bizarre. In some cases the present tense has simply become standard. For example *They have told me ...* is hardly acceptable if *they* does not have identifiable referents, because in that case *They tell me ...* is formulaic.

The present tense has the following common uses to refer to the post present:

- (1) The nonprogressive present may be used in a *wh*-question to suggest an action or ask advice about a future action (*What on earth do we do now?*) – see 3.7.
- (2) The nonprogressive present may be used to refer to a post present situation which is predetermined (*The funeral is on Friday*) – see 3.8.
- (3) The progressive present may be used to represent a situation as resulting from a present plan or arrangement (*I'm having dinner with them tonight*) – see 3.9.

3.7 The nonprogressive present in *wh*-questions expressing a suggestion

Some *wh*-questions using a nonprogressive present tense form either make or ask for a suggestion concerning a post-present course of action. (The reference may be to the near or more distant future.)

Why don't we go home? (*negative rhetorical question expressing a positive suggestion*)

Why don't you have a little nap, [and you'll feel better]? (*id.*)

Who do I ask for [when I get there?]
(*positive question asking for a suggestion*)

What do we do [if this turns out to be true]? (*id.*)

3.8 The nonprogressive present referring to a pre-determined post-present situation

3.8.1 Situations that are expected to actualize in the post-present (future) are sometimes referred to in the present tense. In that case the choice of tense represents a shift of temporal perspective: a situation time which is to be interpreted as a post-present situation time is represented as if it were a present one. This shift of perspective has semantic import, which is slightly different according to whether the present tense form is nonprogressive or progressive. In this section we will deal with the former possibility.

What we will call the **NONPROGRESSIVE PRESENT** (= the nonprogressive version of a present tense form) is used when the post-present situation is felt

to be completely determined by circumstances that already exist at t_0 . The nonprogressive present therefore represents the future situation as absolutely certain to actualize, i. e. as inevitable. It implies that the speaker feels that he has no control over the actualization of the post-present situation.

The sun *sets* at 9.36 tomorrow.

The plane *leaves* from Heathrow.

Do that and you *lose* your pocket money! (*By representing the post-present situation as if it were a present one, the speaker makes the threat more forceful than he would do if he used the future tense, which would merely express a prediction.*)

However, a nonprogressive present tense form cannot be used if the post-present situation is of a kind that is not felt to be completely pre-determined.

*It snows tomorrow. (*The weather is not felt to be pre-determined.*)

*John falls down the stairs next week. (*Unacceptable unless there is a present plan to make John fall down the stairs next week which is felt to be a plan that cannot fail.*)

3.8.2 The following are some typical cases in which a nonprogressive present form is used to refer to a post-present situation which is felt to be pre-determined and certain:

- (a) The nonprogressive present is used in statements about the calendar.

Next year Whit Sunday *falls* on 11 May.

[Above shows the first lunar month for 2004.] Chinese New Year *falls* on January 22, 2004. (www)

Tuesday of next week *is* 21st August.

- (b) The nonprogressive present is used to express that a post-present situation is the result of a definite plan, agreement or arrangement which already exists at t_0 and which is regarded as unalterable.

[We have reached an agreement with the landlord.] He *moves out* in at the beginning of the week and we *move in* during the weekend.

The wedding *is* on Saturday May 24th at 11:30 am, [so we suggest out of town guests arrive on Friday night and sleep in.] (www)

Most of the academic people that have attended the conference *leave* tonight.

The chairman *retires* at the end of the year.

What *do* we do after the performance? (*said e. g. by a theatre usher inquiring about their duties*)

The use of the nonprogressive present in timetable announcements (where the subject is mostly inanimate) can be treated as belonging here:

Today flight 106 *takes off* at 11.45 p.m.

[During the summer 2003 the gallery will host an exhibition of pen and ink drawings by New York artist Elisabeth Condon.] The show *opens* on Friday, June 20th at 6:30 p.m. [The artist will give a slide show and lecture at 7:30 p.m.] (www)

Compare:

[Reminder to people planning on going to the FFA basketball tournament:] the bus *leaves* at 1:30 tomorrow. (www) (*This is a simple statement of fact: the post-present situation is seen as unalterable, inevitable, because absolutely predetermined.*)

The bus *will leave* at 1:30 tomorrow. (*This is merely a prediction: the speaker just says what he believes will happen.*)

- (c) The nonprogressive present is used if the post-present actualization of the situation is felt to be certain because it results from a habitual or regular pattern that already exists at t_0 .

The *delivery van calls* again tomorrow. (*The use of the nonprogressive present tense is fine, e. g. if the van always comes on the same day every week and 'tomorrow' is such a day.*)

Dinner *is served* at seven. [See that you're on time.] (*This can be said by someone who has not received specific information about the time of dinner today but knows that it is standard routine that dinner is served at seven every day.*)

[There is no need to hurry.] The gates of the park *only open* in about fifty minutes. (*The speaker can say this confidently if the gates always open at the same time.*)

Where do I find John? (*This can be uttered by a speaker who wants to find John and who indirectly asks for help – 'Where will I find John?' – by asking a question meaning 'Where does one find John whenever one wants him?' or 'Where does one find John {on a day like this / at this time of the day / etc.}?'*)

In most of these examples the reference is to a regular pattern which results from a timetable repeating itself. The same is true of the following:

The bus *leaves* at 4 (which is in half an hour) – it always does.

Class 4b *has* geography in room 341 on Wednesdays. (*refers to a number of time-tabled situations rather than to a specific event*)

3.9 The progressive present referring to an arranged future situation

When a post-present situation is referred to by the **PROGRESSIVE PRESENT** (i. e. the progressive form of the present tense), it is represented as resulting from a present plan or arrangement.

I'm *staying* at the Gardners' next week.
 Next they're *playing* a cello sonata by Bach.
 We're *working* late tomorrow evening.
 He's *going* to Iraq next week.

This use of the progressive differs from the 'arranged future' use of the nonprogressive present (referred to in 3.8.2) in that it implies that the referent of the subject NP has control over (the actualization of) the situation. This means that the progressive present implies less certainty than the nonprogressive present: it refers to a present plan which may possibly still be altered, while the nonprogressive present denotes a plan or arrangement that is regarded as unalterable. It also means that the progressive present suggests that it is the referent of the subject NP who is responsible for the plan or arrangement, whereas the nonprogressive present suggests that it is somebody else or circumstances.

I'm *visiting* them tonight. (= *my personal planning*)

I *visit* them tonight. (= *It has been arranged (by some authority) for me to visit them tonight.*)

Margaret *is dining* out tonight.

?Margaret *dines* out tonight. (*This sentence sounds strange in isolation because it suggests that someone else has decided that Margaret should dine out tonight.*)

Margaret *dines* out with the French ambassador tonight. (*This is more readily contextualizable, because the engagement can more easily be seen as somehow having been made for Margaret, if not literally by another person then by the circumstances of, say, her position as foreign secretary.*)

3.10 Constraints on the use of the present tense with post-present time reference

There are four constraints on the use of the present tense with post-present time reference. Informally, these are:

- (1) It must be clear from the context that the reference is to the future and not the present.
- (2) The nonprogressive present cannot be used for post-present situations that are not predetermined (**It rains tomorrow*).
- (3) The progressive present can only refer to post-present situations that are intentional and have a human agent (*The dog's going to the vet tomorrow* means 'I'm taking the dog to the vet tomorrow').
- (4) There may be constraints on the interpretation of a present tense form referring to the future when that form is used in combination with an epistemic modal adverb

like *perhaps, possibly, probably*, etc. In such cases it may be unclear whether the judgement implicit in the adverb is attributable to the subject referent or to the speaker.

3.10.1 **CONSTRAINT 1:** Since the basic meaning of the present tense is location of a situation time at t_0 , its use with post-present reference is only acceptable if it is clear from a time adverbial, from the context or from pragmatic knowledge that the situation referred to should be interpreted as lying in the post-present. Compare:

We go to the local pub. (*The only interpretation out of context is in terms of a present habit.*)

Tomorrow we go to the local pub. (*Post-present reference is imposed by tomorrow.*)

John is travelling to Greece. (*can be interpreted as referring to the present or as forming part of a present arrangement concerning the future*)

John is travelling to Greece next month. (*post-present reference only*)

We're having roast beef for lunch. (*Unless uttered during lunch, this sentence can only refer to the post-present. In that case the post-present reference is pragmatically clear, since the hearer can see that the speaker is not actually having lunch.*)

When the progressive present is used with post-present reference and the post-present time of actualization is not specified by a temporal adverbial or by the context, the reference is normally to the near future.

(*said while Mr Snowdon is getting up in the morning*) Mr Snowdon is leaving for New York. (*suggests 'today'*)

(*said during the tea break*) I'm taking Cheryl out to the cinema. (*suggests 'today', or 'within the next week or so', not 'in two years' time'*)

Is anyone coming to dinner?

This 'near future' interpretation follows from the Gricean Maxim of Relation (relevance): in general, the present (= the speaker's here-and-now) is more relevant to the speaker than the past, pre-present or post-present. It follows that the recent past and the near future are also felt to be more relevant than the remote past or distant future. So, if there is no explicit indication of a distant future time, a present tense form referring to the post-present will be interpreted as referring to the immediate or near future rather than to a more distant time.

3.10.2 **CONSTRAINT 2:** The use of the nonprogressive present to refer to a post-present situation is only possible with reference to a situation that can be represented as completely pre-determined by some (often unnamed) authority

or (often unspecified) circumstances. It is especially common with verbs of directional or inchoative movement.

The plane takes off in fifteen minutes.

The delegation {leaves for / arrives in} Paris tonight.

The state verb *be* also allows this use if there is pre-determination:

We're in Vienna tonight. (*pre-determined by arrangement or scheduling*)

I am {busy / engaged / at the office} all day tomorrow. (*idem*)

Our daughter is here next week. (*idem*)

Our daughter is eighteen next week. (*not scheduled, but still pre-determined because it means 'Our daughter turns eighteen next week'.*)

*I'm in good spirits all day tomorrow. (*not pre-determinable, for pragmatic reasons*)

*The boy is as tall as his father in a few years' time. (*The speaker may be convinced of this, but the sentence remains a prediction. The situation is not pre-determined.*)

Other state verbs are not normally used this way because what they refer to cannot easily be seen as pre-determined:

I {will know / *know} the answer tomorrow.

[You should buy it now.] Tomorrow it {will cost / *costs} a fifth more.

We {will have / *have} fresh bread this afternoon. [The delivery van comes around midday.]

However, there may be contexts in which states referred to by verbs other than *be* can be treated as pre-determined. In those cases the nonprogressive present tense can be used. For example, if you look at the table of 'prices over months' in a travel brochure, and see that in May a particular holiday apartment costs € 400 and in June it costs € 600, you can easily say *Next month it costs 50% more.*

3.10.3 CONSTRAINT 3: Because of its 'personal arrangement' meaning, the use of a progressive present with post-present time reference is restricted to sentences expressing an intentional situation performed by an agent (i. e. sentences describing an action or a process under the control of an agent).

I think he {is leaving / *is coughing / *is sneezing / is going to cough / is going to sneeze} in a minute.

The bomb {will explode / *is exploding / is going to explode} any minute now.

These miners are going down at ten.

*The sun is going down at ten.

He {is opening a new shop / *is dying in an accident} next week.

*It's raining tomorrow morning.

The (normally human) agent need not always be the subject of the sentence. Sometimes it is implicit.

[We have a lot of fun events coming up.] First of all, Fall Recruitment *is starting* soon. [We are hoping to add many new faces to the sorority.] (www) (*This is roughly equivalent to: 'We are starting Fall Recruitment soon.'*)

Concert and Chamber Choirs, be reminded that rehearsals *are beginning* this Saturday for you all. (www)

3.10.4 **CONSTRAINT 4:** Because of the special meaning of a present tense with post-present time reference, there may be constraints on the interpretation of such a present tense form in combination with adverbs like *perhaps*, *possibly*, *maybe*, *probably*, etc. Such epistemic modal adverbs express the degree to which the speaker is sure of the truth of what he is saying. However, these adverbs have a certain scope, and it is not always clear what is in that scope and what is not. This may lead to ambiguity (or at least vagueness) between various interpretations. A sentence like *Jim's probably leaving tomorrow* can be interpreted in four ways:

- (a) One reading of *Jim's probably leaving tomorrow* is 'I am not sure Jim {intends / has arranged} to leave tomorrow, but he probably {does / has}.' (= '*Jim probably has the intention of leaving tomorrow.* Probably here expresses the speaker's lack of certainty concerning the existence of an arrangement or intention on Jim's part.)
- (b) Another interpretation of *Jim's probably leaving tomorrow* is 'Jim hasn't fully decided whether he will leave tomorrow, but he says he will probably decide to do so.' (= '*Jim has half-arranged, or half-intends, to leave tomorrow, but nothing is definitive yet. However, he is likely to confirm the arrangement or intention.*' Probably here expresses Jim's lack of certainty as to whether he really intends to leave tomorrow.)
- (c) A third reading of *Jim's probably leaving tomorrow* is 'Jim {intends / has arranged} to leave tomorrow, and I think he probably will.' (*There is no doubt that there is a present intention or arrangement on Jim's part, but fulfilment is uncertain. Probably* expresses the speaker's expectation that Jim will carry out the intention or arrangement.)
- (d) Finally, *Jim's probably leaving tomorrow* can also mean 'Jim {intends / has arranged} to leave tomorrow, and he says he probably will.' (*There is no doubt that there is a present intention or arrangement on Jim's part, but fulfilment is uncertain. Probably* expresses Jim's expectation to carry out the intention or arrangement.)

In (a) and (c), *probably* expresses the speaker's assessment of likelihood, while in (b) and (d) it expresses the subject referent's assessment. In (a) and (b), the likelihood concerns the existence of a present 'pre-determining factor' (in this

case: intention or arrangement); in (c) and (d) it concerns the post-present actualization of the pre-determined situation. However, not all four interpretations (a)–(d) are always available:

Perhaps the train leaves at five. (*The only possible reading is (a), i.e. ‘It is possible that the train is scheduled to leave at five’. Reading (c) – ‘The train is scheduled to leave at five and I think it will perhaps do so.’ – is not available because perhaps has scope over the entire sentence (including the verb expressing the scheduling). The other two readings do not arise because the referent of the subject is nonhuman: a train cannot have the intention or expectation to do something.*)

Maybe he’s leaving tomorrow. (*Maybe has wide scope. This rules out readings (c) and (d). Reading (a) – ‘It is possible that he has arranged to leave tomorrow’ – is quite plausible, whereas reading (b) – ‘He has half-arranged, or half-intends, to leave tomorrow, but nothing is definitive yet’ – is not normally expressed this way. (It can be expressed by He’s maybe leaving tomorrow, but many people consider this on the periphery of grammatical acceptability.)*)

?He’s perhaps leaving tomorrow. (*For those who find this sentence acceptable, it allows reading (a) – ‘I think it is possible that he has arranged to leave tomorrow’ – as well as reading (b) – ‘He says that perhaps he’s leaving tomorrow’, i.e. ‘He has it half in mind to leave tomorrow’. Readings (c) and (d) – ‘He has arranged to leave tomorrow and {I think / he thinks} it is possible that he will actually do so’ – are not readily available out of context, but are presumably possible in a suitable context.*)

I’m probably leaving tomorrow. (*It is difficult to find a context in which reading (a) – ‘I am not sure I {intend / have arranged} to leave tomorrow, but I probably {do / have}’ – makes sense, for the speaker knows better than anyone else whether or not he has arranged something. Out of context, the only plausible readings are therefore (b) – ‘I haven’t fully decided yet’ – and (c) – ‘I have decided, but I’m not sure about the actualization’. Reading (d) here coincides with (c) because the referent of the subject is also the speaker.*)

3.11 The present tense substituting for a ‘continuative perfect’

The head clause of a *since*-adverbial referring to a ‘period up to t_0 ’ is usually in the present perfect. But occasional examples can be found in which the present tense is used. In that case there is special focus on the present continuation of the situation that leads up to now.

As we will see in 12.11, a *since*-adverbial referring to a ‘period up to t_0 ’ normally combines with a present perfect in the head clause. This present perfect

often yields a 'continuative' interpretation, i. e. the reading that the full situation is still continuing at t_0 . This is the case, for example, in sentences like *He has been sleeping since he's been here* or *I have been afraid ever since I came to live here*. However, it will be noted in 12.11.5, that the present tense can sometimes be found instead of the present perfect if the speaker focuses on the present continuation of a (permanent or temporary) habit whose beginning is specified by the *since*-construction.

[It was a daunting experience but a good boost for my learning process.] Since then I *am* a little more relaxed in front of the crowds. (www) (*since then* = 'since and because of that experience'; Compare: *Since then I've been a little more relaxed...*)

[I am by origin catholic but also went through the born-again stage with the Assembly of God for 2 years.] Since then I *am* back to being a catholic but with many different beliefs. (www) (Compare: {*From that time onwards* / *For the last three years*} I {*have been* / **am*} back to being a catholic.)

It should be noted, however, that not all native speakers find the use of the present tense with a *since*-adverbial grammatical.

DEMO

III. Summary

3.12.1 The meaning of the absolute present tense is that the situation time coincides with t_0 . Since t_0 is a point, the situation time is a point. If the full situation is punctual, the situation time coincides with the time of the full situation and the full situation is located at t_0 . If the full situation is durative and homogeneous (i. e. nonbounded), then the situation time (i. e. the time of the predicated situation) is a punctual subinterval of the time of the full situation and that punctual subinterval is located at t_0 . *I live here* locates a punctual subinterval of the full situation, which is the (homogeneous) state of ‘living here’, at t_0 . If the full situation is durative and heterogeneous, we cannot locate the situation time at t_0 . This is because, when the clause refers to a durative heterogeneous situation, the situation time and the time of the full situation coincide. Obviously, a durative situation time cannot coincide with a point (and as we have seen in chapters 1 and 2, tense-indicated simultaneity is a relation of exact coincidence). *I’m making a wheelchair at the moment* and *I use a wheelchair* are both impeccable because they locate a punctual situation time at t_0 . That the situation time is punctual is due to the fact that the durative (actualizations of the) situations (of being in the process of a making a wheelchair or of being in the habit of using a wheelchair) are homogeneous. However, **I make a wheelchair at the moment*, which refers to a heterogeneous (bounded) situation is not acceptable, because the situation time cannot be represented as punctual.

3.12.2 In English it is possible – in well-defined contexts – to use the set of present time-sphere tenses to refer to situations that are understood to actualize in the past, the pre-present or the post-present. One special use of present time-sphere tenses is what is commonly called the ‘historic present’. The historic present represents the location of the situation time of a past situation as if it were in the present, for dramatic effect. (The historic present can only be used when it is evident that the actual location of the situation time is in the past). For example *So there we were, and Tommy goes* “Oooh, that’s nice”.... Although we talk of the historic ‘present’, the present tense in this use is indeed part of a set of tenses used to locate a situation or a set of situations in the past time-sphere as though they were in the present time-sphere. For example, in *So there we were, and Tommy has still not seen anything he likes, and the shops are about to close ...*, it is the present perfect *has (not) seen* which sets up the use of the ‘Special Present Time-sphere System’: the present tense *are (about to)* occurs as a continuation of the use of this system. When a present time-sphere tense form inaugurates the use of the Special Present Time-sphere Tense System, it effects a ‘shift of temporal perspective’ (see 2.20).

3.12.3 There are some cases in which the speaker can use the present tense to refer to a past situation because this situation is somehow made visible in the present. Captions underneath a photograph representing a historical situation (e.g. *The Queen visits Saint Mary's college in 1991*) form a typical example. 'Replay comment' in the present tense forms another.

3.12.4 In a few very clearly defined contexts, the present tense may be used when it is not important to give explicit information about the temporal location of a situation. Newspaper headlines provide an illustration: *Israel strikes back*.

3.12.5 When news has recently been received, the source of the news (e.g. the telling or the hearing) can be referred to with the help of a verb in the nonprogressive present tense: *I hear you're going to buy a new car*.

3.12.6 The present tense has some common uses to refer to the post-present. As regards the nonprogressive present, we have discussed *wh*-questions suggesting an action or asking advice about a future action (*What do we do now?*) and clauses referring to a post-present situation which is seen as predetermined (*The funeral is on Friday*). As regards the progressive present, we have seen that it can be used to represent a situation as resulting from a present plan or arrangement (*I'm having dinner with them tonight*).

There are four constraints on the use of the present tense with post-present time reference. Informally, these are:

- (a) It must be clear from the context that the reference is to the future and not the present.
- (b) The nonprogressive present cannot be used for post-present situations that are not predetermined (**It rains tomorrow*).
- (c) The progressive present can only refer to post-present situations that are intentional and have a human agent (*The dog's going to the vet tomorrow* means 'I'm taking the dog to the vet tomorrow').
- (d) There may be constraints on the interpretation of a present tense form referring to the future when that form is used in combination with an epistemic modal adverb like *perhaps*, *possibly*, *probably*, etc. In such cases it may be unclear whether the judgement implicit in the adverb is attributable to the subject referent or to the speaker.

3.12.7 The head clause of a *since*-adverbial referring to a 'period up to t_0 ' is usually in the present perfect. But occasional examples can be found in which the the present tense is used. In that case there is special focus on the present continuation of the situation that leads up to now. For example: *Since then I am a little more relaxed in front of the crowds*. (www) However, not all native speakers judge this use of the present tense grammatical.

DEMO

4. The absolute past tense

I.	Introduction	195
4.1	The semantics of the absolute past tense	195
4.2	Bygone situations: ‘W-bygone’ <i>vs</i> ‘T-bygone’	196
4.3	The implicature of discontinuation	197
4.4	The nonprogressive past <i>vs</i> the progressive past	199
II.	Uses of the absolute past tense	200
4.5	Concern with THEN is clear from the context	200
4.6	The past tense used to focus on the ‘when?’ of the situation	201
4.7	The past tense used for ‘actualization focus’	204
4.8	The past tense contrasting what is W-bygone with what is not	206
III.	Summary	207

DEMO

Abstract

In this chapter we continue our description of the meaning and use of the four ‘absolute’ tenses in English, i. e. the tenses that relate the time of the situation referred to directly to the temporal zero-point (which is usually the time of speech). One such tense, the absolute present tense, was dealt with in chapter 3; in the present chapter, we discuss the absolute past tense.

The absolute past tense is used to represent a situation as actualizing at a specific past time. Contrary to the present perfect (see chapter 5), the past tense is used when the speaker is not thinking of the present. We argue that this does not necessarily mean that, in the extralinguistic

world, the situation referred to is completely over at the temporal zero-point, although there is usually a strong suggestion (technically, an ‘implicature’) that it is completely over.

The rule that the past tense is used when the speaker is concerned with THEN rather than with NOW implies that the past tense has to be used when the speaker focuses on a particular past time at which the situation actualized or on another aspect of the past situation.

A comparison between the past tense and the present perfect, both of which can be used to refer to a ‘bygone’ situation, is reserved for chapter 6.

DEMO

I. Introduction

4.1 The semantics of the absolute past tense

The semantics of the absolute past tense is its tense structure: the situation time is located in the past time-sphere. (The past tense itself does not give information as to where exactly the situation time is located in the past time-sphere.) The absolute past tense always establishes a past domain.

The absolute past tense is used to locate a situation time in the past time-sphere and in doing so create a past domain. As noted in 2.10.2, the past time-sphere is conceived of as disconnected from the present time-sphere (which comprises the pre-present, the (punctual) present, and the post-present). The fact that the speaker locates the situation time in the past rather than in the pre-present therefore means that he is not thinking of t_0 when he utters his sentence. That is, he is not concerned with NOW but rather with THEN, i. e. with a specific past time, which may be either definite, as in *I met him last week*, or indefinite, as in *We don't know when this pyramid was built*. ('Indefinite' means 'not assumed to be identifiable to the hearer'.) It follows that using the past tense is the rule when the speaker is primarily concerned with the past situation itself rather than with its possible relation to the present.

It is important to see that for an adequate (interpretable) use of the past tense it is not necessary that the 'anchor time' THEN should be definite (in the sense that the hearer is assumed to know exactly which time it is). All that is necessary is that an anchor time (= a THEN) should be given or be retrievable. Whether or not that anchor time is definite is irrelevant. For example, *There was a princess who felt very lonely* is not fully interpretable in isolation because there is no specific past time to anchor the situation time to. But *Once upon a time there was a princess who felt very lonely* is fully interpretable because *once upon a time*, which has indefinite reference, provides the anchor time. Similarly, adverbials like *one day*, *one sunny morning*, *a long time ago*, etc. are fully indefinite but license the use of the past tense because they refer to a specific past time.

4.2 Bygone situations: ‘W-bygone’ vs ‘T-bygone’

A situation is W-bygone if it is completely over at t_0 . Both *I did it* and *I have done it* refer to W-bygone situations. A situation is T-bygone if the situation time is represented as bygone by the tense form used.

The fact that a situation time is represented as T-bygone does not always mean that the full situation has to be over at t_0 . Thus, it does not follow from *Five minutes ago Meg was washing an elephant* that the washing must have stopped before t_0 .

4.2.1 We will refer to a situation which is completely over at t_0 in the actual world (or in the fictional world referred to) as a **W-BYGONE** situation. Since the reference is to a real-world situation, a W-bygone situation is always a ‘full situation’ – see 2.12.

The label ‘past situation’ will not be used in this sense, because bygone situations may under certain conditions be located in the pre-present (*I have closed the door*) rather than in the past (*I closed the door*). By ‘past situation’ we will mean a W-bygone situation whose situation time is located in a past domain. The name ‘finished situation’ is not suitable as an alternative to ‘W-bygone situation’ either, because ‘finished’ is applicable to telic situations only – see 1.39.6 – whereas W-bygone situations may be referred to by VPs which are either telic (*John told me a story*) or atelic (*John was a nice guy; I was reading poetry*).

4.2.2 A situation whose situation time is located completely before t_0 by a tense is a **T-BYGONE** situation. Since the reference is to how a situation is located in time by a tense, a T-bygone situation is a ‘predicated situation’ rather than a ‘full situation’ – see 2.12. In *ten minutes ago John was working in the garden*, the predicated situation (i. e. that portion of the full situation that coincides with the time indicated by the adverbial) is completely over at t_0 (i. e. T-bygone), but the full situation may still be continuing.

4.2.3 For ease of reference, we will speak of **BYGONE** situations rather than ‘W-bygone’ or ‘T-bygone’ situations when it is not necessary to make the distinction explicitly or when the distinction is difficult to make. An example of the latter possibility is when we make statements like the following:

Under certain conditions either the past tense or the present perfect can be used to locate a bygone situation in time. (*What a tense locates in time is the time of a predicated situation, i. e. a ‘situation time’, not the time of a full situation. In this sense the preterite represents the situation as T-bygone. At the same time, however,*

the use of the past tense entails (if the sentence is bounded) or implicates (if the sentence is nonbounded – see 1.44.2) that the full situation is over at t_0 . The unmarked W-interpretation of a sentence in the past tense is therefore that the situation is W-bygone.)

4.2.4 It is often claimed that a situation that is described in the past tense cannot be still actualizing at t_0 . That this is not correct appears from examples like the following:

[“Where is John?” – “I don’t know. But look in the kitchen]. He *was* there two minutes ago. [Perhaps he is still there.]

The use of the past tense here means no more than that the speaker claims that two minutes ago it was the case that the static situation was (then) holding. This claim does not exclude the possibility that the situation was actualizing at other times too, nor that it is still actualizing at t_0 . In other words, when uttering *He was there two minutes ago* the speaker just focuses on that part of the situation that is simultaneous with the ‘anchor time’ (see 4.1) indicated by *two minutes ago*. He does not make any claims about other parts of the situation or about the situation as a whole. In technical terms, what is located in the past is not the time of the full situation but the situation time (the time of the predicated situation), which is punctual here because it is contained in the punctual Adv-time denoted by *two minutes ago*. (‘Containment’ here means ‘coincidence’ – see 2.23.1.) In this case the situation time is represented as past (and hence as T-bygone), but this does not exclude the possibility that the full situation is not W-bygone.

4.3 The implicature of discontinuation

Though the fact that a situation time is represented as T-bygone does not always mean that the full situation has to be over at t_0 , homogeneous clauses in the past tense do implicate this if they do not form part of a stretch of discourse about the past.

4.3.1 If the full situation is homogeneous (nonbounded – see 1.45) and there is no adverbial or contextual indication that the situation time (= the time of the predicated situation) is not the time of the full situation, the absolute past tense implicates that the full situation is completely over at t_0 – see 1.44.

There was somebody in the kitchen. (*implicates that this is no longer the case*)

This **IMPLICATURE OF DISCONTINUATION** follows from the Gricean Maxim of Relation (Relevance).¹ Unless they form part of a stretch of discourse about the past, statements about the present are more relevant than statements about the past. It follows that a situation that includes t_0 should be located in the present, not in the past. Hence, if the speaker uses the past tense, this is interpreted as a sign that he cannot locate the situation in the present, i. e. that the reference is to a situation which is completely over.

I lived in a flat for ten years. (*implicates that I am not living in a flat any more*)

John was an excellent centre forward. (*implicates that this is no longer the case, e. g. because John's capacities have diminished as a result of age or injuries, or because John does not play football any more, or now plays as goalkeeper, or as centre forward for another team, etc.*)

As is typical of implicatures, this interpretation of discontinued full situation can be cancelled or blocked (= prevented from arising) by the context:

["If you can't bear Norman's habits, why did you move in with him?"] – "I liked him. Still do, for that matter. [It's just his habits I can't stand.]" (*The implicature of discontinuation evoked by I liked him is cancelled by the addition of Still do.*)

Compare:

When he was a baby, Sam *had* white hair. (*suggests that he no longer has white hair*)

When he was a baby, Sam *already had* red hair. (*It is difficult for the implicature of discontinuation to arise because already tends to block it.*)

When he was a baby, Sam *had* white hair. [Now he's eleven, and his hair is still white. It gets him noticed.] (*The implicature of discontinuation is cancelled by the second sentence.*)

4.3.2 It is important to note that if a situation is linguistically *represented* as L-bounded rather than merely *pragmatically interpreted* as W-bounded be-

1. An aspect of meaning (or rather interpretation) is an 'implicature' (or is 'implicated') if it does not follow from the semantics of the construction or the lexical items (= words) used but rather from the context, from pragmatic knowledge of the world, or from "principles of conversation" which are conventionally observed by "cooperative" speakers and hearers (Grice 1975). For example, *Clear away the glasses!* is by implicature interpreted (and meant to be interpreted) as an instruction to clear away *all* the glasses that are relevant in a particular context. However, like all implicatures induced by conversational principles, this aspect of meaning (*the* = 'all the') can be cancelled. This is the case, for example, in *Clear away the glasses, except those that are not empty*, and also in *The person who cleared away the glasses overlooked those on the window-sill.*

The most relevant principles of conversation are discussed in Grice (1975), where they are called 'Maxims' (hence the term 'Gricean Maxims'). The 'Maxim of Relation' (now more often referred to as the Maxim of Relevance) stipulates that a cooperative speaker will only say things that are relevant at the given point of the discourse.

cause of the above mentioned implicature), that situation is by definition referred to as a whole. In that case the situation time coincides with the time of the full situation (see 2.12.1), so that locating the situation time in the past time-sphere (by means of the ‘absolute past tense’ – see 2.44) is tantamount to locating the full situation in the past. In such sentences the idea of discontinued situation is more than pragmatically implicated: it is linguistically asserted.

[“How far did John walk?”] – “He walked three and a half miles.” (*The combination of the telic VP walk three and a half miles and nonprogressive aspect results in a bounded representation – see 1.49.1. Because of this, the situation time is interpreted as being the time of the full situation – see 2.12.2. Since the past tense locates the situation time in the past, it follows that the entire situation is interpreted as lying in the past, i. e. that the situation of John walking three and a half miles cannot be interpreted as continuing into the present.*)

I wrote him a letter last night. (*similar*)

4.4 The nonprogressive past *vs* the progressive past

As noted in 1.22.4, the difference between the nonprogressive form and the progressive form is not a distinction that has to do with tense but an aspectual distinction: the main reason for using these forms is to express ‘nonprogressive’ and ‘progressive’ aspect, respectively (see 1.21–22 for an explanation of these terms.) Thus, both *walked* and *was walking* are past tense forms. Because these verb forms also express the absence or presence of progressive aspect, we will call them examples of the ‘NONPROGRESSIVE PAST’ and the ‘PROGRESSIVE PAST’, respectively, wherever this aspectual distinction is relevant.

It was noted in 3.8–9 that the nonprogressive present and the progressive present have a special shift-of-perspective use in which they establish a future domain rather than a present one: *He {leaves / is leaving} tomorrow*. This special use has a past counterpart, but we do not need to be concerned with it in the present discussion of the absolute past tense, because past tenses expressing posteriority can only be used as relative tenses, as in *He said he {left / was leaving} the next day*, where (from a purely temporal point of view) *left* and *was leaving* are equivalent to *would leave*, which is a relative tense form. (This is not to say that this use of the past tense is restricted to subordinate clauses. Under certain conditions it is also found in independent clauses:)

[John was very nervous.] The game *was starting* in a few minutes now. (*free indirect speech*)

II. Uses of the absolute past tense

Needless to say, in this volume we only deal with the nonmodal uses of the past tense.

The situation time of a bygone situation can in principle be located either in the pre-present zone (by the use of a present perfect form) or in the past time-sphere (by the use of the past tense). As will be further explained in chapter 7, the speaker chooses the former possibility if he is somehow thinking of t_0 while referring to the bygone situation; otherwise he uses the past tense. In the latter case he is not concerned with NOW but with THEN. In what follows we will investigate the factors that can induce or reveal the speaker's concern with THEN.

4.5 Concern with THEN is clear from the context

A speaker using the absolute past tense is concerned with a past time (THEN) rather than with the present (NOW). This concern is sometimes clear from the context.

The speaker's concern with a past time is obvious when the sentence forms part of a text (or stretch of spoken discourse) which only uses past time-sphere tenses (i. e. the past tense, the past perfect, the conditional tense or the conditional perfect). In this case the 'discourse topic' to which the bygone situations relate clearly concerns THEN rather than NOW. (By 'discourse topic' we mean what a stretch of discourse, i. e. spoken or written text, is about.)

We *embarked* at *dawn*, when it *was* still relatively dark. None of us *said* a word. We all *felt* nervous and afraid.

["How *did* you get here so fast?"] – "I *managed* to catch a bus five minutes after you rang, then there *was* a train due as I *arrived* at the station. I just *had* time to buy a ticket and I *jumped* onto the train as the doors *were closing*. When I *got* to Brussels I *was* really lucky because the tube trains had been running late, but one *arrived* just as I *got* to the platform, and then when I *got out* at your tube station I *ran* all the way here." (Though the reply as a whole is an explanation of the speaker's unexpectedly early presence at speech time, the speaker uttering the reply is essentially concerned with what he had to do to manage to reach the addressee so quickly. In each of the clauses in the past tense, the speaker is concerned with one particular situation forming part of the past sequence of situations resulting in his early arrival.)

4.6 The past tense used to focus on the ‘when?’ of the situation

For a good temporal understanding of a clause in the absolute past tense the minimal requirement is that the hearer be aware of the existence of a specific past time at which the situation actualized. For a full temporal interpretation it is often necessary that that specific time should also be definite (identifiable) to the hearer. Past times may be identifiable in various ways. In each case the use of the past tense (rather than the present perfect) is obligatory.

4.6.1 The speaker will use the past tense if he is concerned with the question of *when* a bygone situation actualized. This is automatically the case if the sentence involves an adverbial referring to a specific past time, such as *last week, a week ago, then, the other day, yesterday, at the time, in 1989, on Tuesday, earlier this summer ...*

John {*left* / *has left} his wife last week.

It was then that things {*started* / *have started} going wrong.

4.6.2 Questions beginning with *when* normally use the past tense rather than the present perfect, because *When ...?* normally means that the speaker is concerned with THEN rather than NOW:

{When / at what time} {*did those incidents take place* / *have those incidents taken place}?

When {*did he arrive* / *has he arrived}?

When {*did you see* / *have you seen} her house for the first time?

These examples should be compared with the following:

[“I don’t believe you. You always lie to me.” — “That’s not true.”] When *have* I ever *lied* to you?

In this example, the message is that there do not exist any occasions on which the speaker lied to the addressee. The question does ask ‘when?’, because one could answer ‘last week’, but it is also rhetorical since it assumes that the addressee cannot provide such an instance, and it thus means ‘I don’t believe that you can cite any instance – I don’t believe that one exists.’ This means that the speaker is not concerned with the THEN of a particular situation or set of situations but with the question whether the kind of situation referred to has or has not actualized (in a period leading up to t_0). This kind of meaning is typically expressed by the present perfect – see 6.5.4.

4.6.3 For a full temporal understanding of a clause using the past tense to focus on a particular past time it is usually necessary that the time in question should be identifiable to the hearer, or at least that the hearer should be familiar with the existence of such a time. Out of context, a sentence like *Bill ran away* is rather pointless from a communicative point of view because the hearer does not know what time or occasion the speaker is referring to. This means that a speaker using the past tense has a specific past time in mind. (As noted in 4.1, this ‘anchor time’ need not be definite in the technical sense of the word. The time referred to by the past tense in *We don’t know when this pyramid was built* is specific but not definite, i. e. not assumed to be identifiable to the hearer. The same is true in past tense sentences introduced by indefinite adverbials like *once upon a time, one winter morning, a long time ago*, etc. Still, in most cases the specific past anchor time is also definite.)

There is a similarity here between the use of the preterite and the use of a definite NP. If used in isolation, a sentence like *Did the man water the plants?* presupposes some shared knowledge. To fully understand this sentence, the hearer must check his memory stock, not only for suitable referents for the NPs *the man* and *the plants* but also for a suitable occasion (time) for the situation to have taken place. Similarly, a question like *Did John lock the door?* cannot be answered with *Yes* or *No* if it is not clear to the addressee what time is referred to as the time at which John may or may not have locked the door. It should also be noticed that *Mary did not lock the door* is not equivalent to *Mary never locked the door*; unlike the latter sentence, *Mary did not lock the door* asserts that Mary did not lock the door on some specific past occasion.

As noted in 4.1, the semantics of the past tense is such that it tells us no more than that the situation referred to is located in the past time-sphere. Further temporal information can be given in the form of a time adverbial, whether definite (*two years ago, just before Bill came in*) or indefinite (*some years ago*). However, it may also be deducible from the context or from pragmatic knowledge. The following are some typical examples of this.

- (a) Place adverbials may imply a past time, viz. the time when the relevant person or entity was at the place in question.

I knew him in the *army*. (= *when I was in the army*)

I met her at a *conference* in Oxford. (= *when we were at a conference in Oxford*)

[I know he had the book before it was published.] I sent a proof copy to him in *Zimbabwe*. (= *when he was in Zimbabwe or when I was in Zimbabwe*)

Place adverbials of this kind offer sufficient information for the hearer to be able to deduce the temporal location of the situation in the past. (This information reveals the speaker’s focus on a past THEN, even though it may not be very precise. As with other indications of the temporal location of a past situa-

tion, a place adverbial may sometimes give only a very general idea of when the situation actualized. All that is required is that the situation can be located with sufficient precision for the purposes of the discourse. Thus *I learned to swim in Australia* uttered when the hearer knows that the speaker was in Australia between the ages of twenty and twenty-five is sufficiently precise to convey the message ‘I was already an adult when I learned to swim’, and this may be the main point that the speaker wishes to communicate by using the adverbial.)

- (b) There may be other constituents in the clause that are pragmatically linked with a particular past time.

[“I haven’t got any cash left.”] – “I gave all mine to the milkman”. (*Reference to the milkman implies ‘this morning’ in the default case, assuming that the milkman comes every morning.*)

Did the ferry bring any visitors to the island? (*implicit time: when the ferry came to the island, as it does (e.g. around noon) every day*)

- (c) If there are no constituents in the sentence indicating or suggesting a specific past time, such a time may still be recoverable from the linguistic or extralinguistic context.

Did you *switch* off the lights? (*implicit time: when we left*)

I couldn’t resist buying this book. (*The hearer is expected to interpret the temporal location as being the specific time when the speaker was in the bookshop. This time does not have to be identifiable (definite) to the hearer; it needn’t be identifiable to the speaker either, because the speaker may have forgotten the exact time when he bought the book. All that is required is that the speaker and hearer take it as given that there was an occasion of buying the book.*)

In some cases past time reference is pragmatically inferrable from the immediate situation of speaking. Thus, if I see you with a broken leg, I can ask the question *How did you break your leg?* The fact that you have broken it, hence that there was a time when you broke it, is ‘given’ (assumed known) information. It is therefore natural to use the past tense to ask for further information about the incident.

- (d) That the reference is to a particular past time may be clear from people’s general pragmatic knowledge of the world. For example, we can use historical events or shorthand references to historical events as a means of providing an adequately precise location in time for a situation (and at the same time often giving more information about the circumstances of the situation). For example, we can say *My ancestors arrived here with William the Conqueror* or *My family lost everything under Idi Amin*.

4.6.4 In sum, for a temporal understanding of a clause in the past tense the minimal requirement is that the hearer be aware of the existence of a specific

past time at which the situation actualized. For a full temporal interpretation it is often necessary that that specific time should also be definite (identifiable) to the hearer.

In most contexts, using a past tense without there being an identifiable time of actualization is as inappropriate as using a (formally) definite noun phrase without there being an identifiable referent. (Note that for a referent to be 'identifiable', i. e. for an NP to be definite, it is sufficient that the hearer be familiar with, or be able to assume, the existence of the referent, even if the mere use of the NP is not sufficient for the hearer to pick out the referent from a given set, as in *The police still don't know who the murderer is*, where *the murderer* is an 'attributive definite NP' in the sense of Donnellan (1966).) The necessity of there being a specific, preferably definite, past time at which the situation time is located explains why the sentence *John went for a stroll*, when uttered in isolation, automatically invites the question 'when?'. The information answering this question may be given by a specific (definite or indefinite) time adverbial in the sentence itself (e.g. *three days ago*, *a long time ago*). If there is no such adverbial, the necessary temporal information must be available from the linguistic or extralinguistic context in which the sentence is used or from the pragmatic knowledge that is shared by the speaker and the hearer.

4.7 The past tense used for 'actualization focus'

'Actualization focus' means that the speaker is only concerned with one of the aspects of the bygone situation, such as why, where, how, etc. the situation actualized. In that case he uses the past tense, not the present perfect. It should be noted, however, that question words like *why*, *where*, etc. do not automatically entail actualization focus and can therefore in some cases combine with the present perfect.

4.7.1 Sometimes the reason why the speaker uses the past tense (rather than the present perfect) to describe a bygone situation is that he is *only* concerned with one of the aspects of the bygone situation, such as why, where, how, etc. the situation actualized, or who was involved in it. This idea of past **ACTUALIZATION FOCUS** includes the concept of focus on a particular past time (THEN) discussed in 4.6. In the present section we will concentrate on the other cases in which actualization focus induces the use of the absolute past tense. The following provide some typical examples:

[I have *bought* so many clocks in Switzerland that] I can't remember which town I *bought* that one in. (*The speaker is only concerned with the question 'where?'*.)

["Someone has sent me *an* anonymous letter."] — "I think it *was* Lisa who *sent* it."
(*The speaker is only concerned with the question 'Who sent it?'*)

Please tell *me* how you *did* it.

[I know he's back.] What I'd like to know is *WHY* he *came back*.

In cases like these there is actualization focus on the past: the speaker focuses on some aspect of the past actualization of the situation (rather than on the structure of the world at t_0 , as is the case when the present perfect is used.)

4.7.2 It is important to see that question words like *why*, *where*, etc. do not automatically entail actualization focus. There are three cases in which they are followed by the present perfect because the conditions for using the present perfect are satisfied. The first is if there is a 'continuative' meaning (see 5.4.1) to be expressed, as in *Why have you been living in such a small house?* The second is when the meaning to be expressed is that of an 'indefinite perfect' (see 5.4.1), as in *Why have you never taken a holiday abroad yet?*, or of a 'constitution perfect' (see 5.4.1), as in *Who's been in here recently?* *How many times have you met him since then?*, etc. The third is when the speaker is primarily concerned with the present result or relevance of the bygone situation:

Where have you hidden the ring? (*What the speaker wants to know is where the ring is now.*)

Why have you come back? (*The speaker is concerned both with the fact that the hearer is back and with the reason for his coming back.*)

[He said to Blackie: "Have you taken my private diary?" — "Of course not Mr Gerard. Isn't it in your right-hand desk drawer?" — "If it were I should hardly be asking for it." — "I made it up to date on Monday afternoon and put it back in the drawer. I haven't seen it since." — "It was there yesterday morning.] If you haven't taken it you had better discover who *has* [I presume you accept that looking after my diaries is part of your responsibility."] (OSIN)

[Mary sat down on the stairs. "Where is he then?" she said. (...) Alan told her how things were.] "Who *have you checked* with? [The Bruces? The Smails? The Willoughbys? The Cartwrights?]" At each name Alan nodded. "I phoned them. And the police are going round." (LOB)

4.7.3 There is also actualization focus on the past in sentences which provide further details about an already mentioned bygone situation, or which explain the past origin of such a situation:

["How do you know she changed her will?" — "I have been making enquiries.] It *was* not difficult. [Everybody in the village knows all about it.] (*The sentence It was not difficult provides further information about the already mentioned situation of the speaker making enquiries.*)

["He's not with us any more." — "You mean] he *left* the company?" — "No, he *had* a heart attack and *died*."

In many cases the speaker uses a present perfect to introduce a bygone situation and then switches to the past tense when he gives further information about it – see also 6.2.1:

I *have* already *made* the acquaintance of the local doctor. His car *broke down* in front of the house and he *asked* if he could use our telephone.

Joan *has moved* out of the building. She *said* she couldn't stand living on her own any more.

4.7.4 There is also actualization focus on the past when the speaker just wants to inform the hearer of the *fact that* the situation actualized, without representing it as part of the structure of the world at t_0 :

A doctor friend of mine *told* me that you don't need to take vitamins if you eat a balanced diet.

You know, I nearly *forgot* about my wife's birthday.

4.8 The past tense contrasting what is W-bygone with what is not

The speaker uses the past tense rather than the present perfect if he wishes to contrast a bygone situation with a present one, as in *The firm is no longer what it was*.

The past tense will also be used when the speaker explicitly contrasts a bygone situation with a present one.

This *country* is no longer the economic superpower that it *was* / *has been*.

Things aren't what they *were* / *have been*.

He isn't half the man he *was* before the stock market crash. (*The present perfect is totally ruled out by the presence of the adverbial referring to a definite past time.*)

In this context we may also refer to sentences like the following:

I *didn't know* you were a teacher.

This sentence means something like 'I didn't know you were a teacher until you told me so (or: until I found out) just now'. A contrast is thus established between the past and the present. Similar examples are:

[Gosh! *That* girl is a regular tiger.] I *had* no idea she could be so brave.

I never *thought* she was spying on us. (*implies: but now I know better*)

III. Summary

4.9.1 A (full) situation which is located anterior to t_0 is a **bygone situation**. (See further below). There are two absolute tenses that may be used to refer to such a situation: the absolute past tense and the present perfect tense. The semantics of the absolute past tense is the location of a situation time in the past time-sphere, creating a temporal domain. The past time-sphere is conceptualized as disconnected from the present time-sphere. The semantics of the present perfect tense is the location of a situation time in the pre-present zone. The pre-present zone is in the present time-sphere and therefore connected to NOW. The fact that the speaker has the choice of using the present perfect or the past tense to refer to a bygone situation means that when a speaker chooses to use an absolute past tense, he is choosing to focus on the past exclusive of the present, i. e. on THEN and not NOW.

4.9.2 We distinguish between **W-bygone** situations and **T-bygone** situations. A situation which is conceived of as completely over at t_0 is a W-bygone situation (i. e. one which world knowledge tells us is over at t_0). A situation whose situation time is located either in the past time-sphere or in the pre-present zone (i. e. anterior to t_0) is a T-bygone situation (i. e. one whose location is established by a tense). W-bygone situations are full situations, since they are situations as we conceive of them in the extralinguistic world. T-bygone situations are 'predicated situations', since it is only the time of predicated situations that tenses locate (see 2.12.1). A situation may be T-bygone and not W-bygone, as when the past tense is used to refer to a situation that is still continuing at t_0 . (For example: *John was in the pub when I passed it five minutes ago, so I expect you can find him there*.) However, in the absence of such a context triggering the idea that the situation is continuing at t_0 , the absolute past tense in itself gives rise to an **implicature of discontinuation**, i. e. the idea that the full situation is over at t_0 . This implicature clearly arises in *Meg swore a lot when she was younger*, but is cancelled in *Meg swore a lot when she was younger – and she still does*.

4.9.3 Under what circumstances is a speaker likely to be concerned with THEN rather than with NOW when locating a bygone situation, and thus to prefer the past tense to the present perfect for establishing a domain? We mentioned three general cases. (The dividing lines between these are necessarily somewhat artificial – a given use of the absolute past tense could easily fit all three cases at once.) First, a stretch of discourse which already uses past time-sphere tenses to locate situations in the past time-sphere is clearly concerned with THEN, so that in order to establish a new domain introducing a bygone situation, the speaker is more likely to use an absolute past tense than a present perfect tense. Second, the speaker's focus is definitely on THEN rather than

NOW if there is **actualization focus** on a bygone situation. That is, if the speaker is concerned, not with the existence, or not, of a bygone situation (in which case the present perfect may be preferred, depending on how the speaker conceives of the situation) but with questions about when, where, how, etc. a situation actualized. One typical case is when the speaker gives more information about a bygone situation whose existence has already been introduced. The third case in which the speaker uses the past tense rather than the present perfect is that in which the speaker explicitly contrasts the present with the past, as in *He is no longer the powerful leader that he was*.

4.9.4 For the successful interpretation of a clause in the past tense, the hearer must be able to treat as 'known' the time at which the bygone situation is located. Compare: *Meg has ridden on an elephant* with *Meg rode on an elephant*. The first of these sentences can be used without any indication of when it was that Meg rode on an elephant. The speaker does not have to provide any information to help the hearer to anchor the time of Meg's riding the elephant to any 'known' time in the past. We only know that the situation time is located before speech time. The second sentence would make a rather odd utterance in the absence of further temporal information, since its successful interpretation requires that the hearer can identify some known time at which the situation actualized. The known time need only be sufficiently specified for the purposes of the discourse. For example, in *I couldn't resist buying this book*, the time is 'known' because the existence of a time of buying can be (and here is) treated as inherent in the situation of possessing the book. Thus that time, whenever it was, can be treated as 'known', even though the hearer may have no more information about when it was than that it was during the speaker's (book-buying) lifetime.

5. The absolute use of the present perfect

I.	The semantics of the present perfect	212
5.1	Introduction	212
5.2	The semantics and the T-interpretations of the present perfect	214
II.	The temporal W-interpretations of present perfect clauses	218
5.3	Introduction	218
5.4	The three W-interpretations of clauses in the present perfect	222
5.5	Further arguments for distinguishing between three W-interpretations	229
5.6	Summary of the meaning(s) and W-readings of the present perfect	233
III.	More on the continuative reading of the perfect	235
5.7	The 'factual full situation' <i>vs</i> the 'potential full situation'	235
5.8	Conditions for the continuative W-interpretation	236
5.9	Factors triggering a continuative interpretation	238
IV.	More on the indefinite reading of the perfect	241
5.10	Further remarks on the indefinite reading	241
5.11	The indefinite reading and temporal adverbials	242
5.12	Indefinite readings of negative present perfect sentences	245
5.13	The 'experiential perfect' use of the indefinite perfect	245
5.14	The indefinite perfect used to express 'hot news'	247
5.15	The resultative reading of the indefinite present perfect	248
5.16	The 'recency reading' of the indefinite present perfect	249
V.	More on the up-to-now reading of the perfect	251
5.17	Functional types of up-to-now reading	251
5.18	The unmarked up-to-now reading	252
5.19	The constitution readings	255
5.20	The specificational function of the constitution reading	259
5.21	Two-clause specificational sentences combining two readings	263
5.22	Summary of part V	269
VI.	The relation between the W-readings and (non)progressive aspect	271
5.23	(Non)progressive aspect and a continuative nonhabitual reading	271
5.24	(Non)progressive aspect and a continuative habitual reading	271
5.25	The indefinite reading and (non)progressive aspect	273
5.26	The unmarked up-to-now reading and (non)progressive aspect	277
5.27	The nonquantificational constitution reading and (non)progressive aspect	279
5.28	The duration-quantifying constitution reading and (non)progressive aspect	282
5.29	The number-quantifying constitution reading and (non)progressive aspect	283
VII.	Factors influencing the choice of temporal W-interpretation	287
5.30	The indefinite reading versus the continuative interpretation	287

5.31	The up-to-now reading versus the continuative reading	289
5.32	The up-to-now reading versus the indefinite interpretation	291
VIII.	Factors blocking the location of a situation in a 'period up to now'	295
5.33	Introduction	295
5.34	Reference to entities that no longer exist	295
5.35	Verb of creation + definite 'effected' object NP	298
IX.	'Current relevance' and 'present result'	301
5.36	The present perfect and current relevance	301
5.37	The present perfect and the idea of present result	301
X.	Summary	308

DEMO

Abstract

In this chapter we discuss the present perfect tense as it is used to locate a ‘T-bygone’ situation in time. As we saw in the previous chapter, this is also the function of the absolute past tense, but we argue that a speaker using the present perfect tense is concerned with NOW rather than with THEN – see chapter 7 for a separate treatment of the choice between these two tenses.

Part I (= sections 5.1–5.2) deals with the semantics of the present perfect. We argue that the core meaning conveyed by the present perfect is ‘The situation time is located in (i. e. is contained by) the pre-present time zone’. This meaning is compatible with two ‘T-readings’, namely the readings on which the situation time is, respectively, included in or coincident with a time span that is thought of as starting before and leading up to ‘now’. (Compare, for example, *I have already met that man and I have been working in the garden*).

In part II (= sections 5.3–5.6), we discuss three interpretations with respect to the time of the ‘full’ (rather than the ‘predicated’) situation, referring to them as ‘W(orld)-interpretations’: the ‘indefinite’, the ‘continuative’ and the ‘up-to-now’ interpretations. On the indefinite reading, the time of the full situation lies at some distance from t_0 . On the continuative reading the full situation lasts throughout the pre-present and is still continuing at t_0 . On the up-to-now reading the full situation fills the entire pre-present but does not include t_0 . These three W-readings are distinguished according to the way adverbials and aspectual, contextual and pragmatic factors interact with the (ambiguous) semantics of the present perfect to yield a particular temporal relationship between the time of the predicated situation, the time of the full situation and the time of the pre-present time zone. In section 5.6 we then provide an interim summary of the core meaning of the present perfect, its two related T-readings concerning the tempo-

ral location of the predicated situation, and the three W-interpretations concerning the temporal location of the full situation.

Parts III (= sections 5.7–5.9), IV (= sections 5.10–5.16) and V (= sections 5.17–5.22) zoom in, respectively, on the continuative W-interpretation, the indefinite W-interpretation (including the so-called ‘experiential perfect’ use, the ‘hot news’ reading, the ‘resultative reading’ and the ‘recency’ reading), and the up-to-now interpretation. Within the last we distinguish between an ‘unmarked up-to-now W-reading’, which can have an ‘explanatory-resultative’ function, and a ‘constitution W-interpretation’, which has a ‘specificational’ function and is concerned with the situational constitution of the pre-present. We include a discussion of two-clause structures, like the ‘*It’s been X amount of time since Y*’ type of construction.

In part VI (= sections 5.23–5.29) we discuss the interplay between grammatical aspect (progressive vs nonprogressive verb forms) and the various W-readings.

Part VII (= sections 5.30–5.32) is concerned with multiple W-readings that exist for some clauses using the present perfect.

In part VIII (= sections 5.33–5.35) we have a look at two cases in which the use of the present perfect is excluded on semantic grounds: when there is reference to entities that no longer exist (e. g. *My late uncle {was / *has been} a commercial traveller*), and when a verb of creation is combined with a definite ‘effected’ object NP (e. g. *John {wrote / *has written} this poem*).

In part IX (= sections 5.36–5.37), finally, we discuss our view on the notions of ‘current relevance’ and ‘present result’, which are often associated with the present perfect in the linguistic literature – justly in the case of the former notion, and less so in the case of the latter.

A summary of chapter 5 is provided in part X (section 5.38).

I. The semantics of the present perfect

The present perfect locates the situation time in the pre-present, i. e. in that portion of the present time-sphere that precedes t_0 (without including it). The pre-present thus ‘contains’ the situation time in terms of inclusion or coincidence. The pre-present may be indicated adverbially or may remain implicit. The fact that the speaker chooses the present perfect (rather than the past tense) to locate a W-bygone situation in time means that he is concerned with NOW (rather than with THEN).

5.1 Introduction

5.1.1 We will argue that the function of the present perfect is to locate a situation in the pre-present zone (i. e. in that portion of the present time-sphere that precedes t_0 – see 2.35). The semantics of the present perfect is therefore: ‘The situation time is located in the pre-present zone of the present time-sphere’. In other words, the pre-present **CONTAINS** the situation time in terms of inclusion or coincidence.¹ It is important to keep in mind that the pre-present zone is conceived of as leading up to t_0 without including t_0 (see 2.35). The theoretical necessity of this analysis will be corroborated by the discussion below.

5.1.2 As noted in 2.39, the pre-present zone is an interval which is conceptualized, not a zone whose length is determined in any objective way. If the clause contains a time-specifying adverbial, as in *I haven’t seen him since last week*, the pre-present zone is taken to be the Adv-time (i. e. the interval indicated by the time-specifying adverbial). If there is no time-specifying adverbial, the pre-present is interpreted as the shortest possible time span leading up to t_0 that is in keeping with the semantics and pragmatics of the clause and its context (see also 5.1.6 below). Thus, *I have already had lunch* will be interpreted as meaning that the pre-present is that *part of today* which began when I started having lunch and which leads up to t_0 , and not, say, a period starting a week ago (because lunch is eaten every day).

5.1.3 To locate a ‘T-bygone’ (see 4.2) situation in time, the speaker can in principle choose between the past tense and the present perfect. Generally

1. Note that in this respect the pre-present is no different from the other nonpresent absolute time-zones: when an orientation time is located in the past or post-present, the past or post-present time-zone also contains the situation time in terms of either inclusion or coincidence. For example, compare *He left yesterday* (= inclusion) with *He was living in the country until now* (= coincidence), and *He will leave tomorrow* (= inclusion) with *From now onwards you will have free access to the internet* (= coincidence).

speaking, this choice is determined by whether the speaker is concerned with (some aspect of) the bygone situation itself or with the structure of the world at t_0 : a speaker who uses the present perfect is thinking of NOW, not of THEN – see chapter 6. Whereas the past tense requires that the speaker should place the ‘temporal focus’ (see 11.1) on the past, the present perfect is a sign that the speaker is primarily concerned with the present. In fact, the observation that the present perfect reveals a concern with NOW is the main reason for our claim that a distinction needs to be made between a pre-present and a past time-zone, and that the present perfect locates a situation time in the present time-sphere (more specifically, in the pre-present zone) rather than in the past time-sphere.

The speaker’s concern with NOW, which is a consistent feature of the present perfect, carries with it a requirement that the situation referred to, or a result produced by it, should be deemed relevant at t_0 and should therefore form part of the speaker’s t_0 -world – see 5.37.

5.1.4 As we will see, locating a situation time in the pre-present zone is compatible with more than one interpretation of the relation between the time of the full situation and t_0 . When a situation time is located in the pre-present zone, the time of the full situation may be W-bygone, as in *He’s been to Spain*, or it may lead up to t_0 without including it, as in *Where have you been?*, or it may be interpreted as including t_0 , as in *I’ve been living here for three months now*. There are various factors (such as the type of time-specifying adverbial used, if any) that help to determine these interpretations.

5.1.5 Locating a situation time in the pre-present means locating it in a time span that is conceived of as beginning before t_0 and leading up to t_0 but not including it. As we will see, the time of the full situation may sometimes be interpreted as including t_0 , but the situation time (= the time of the predicated situation – see 2.12–13) never includes t_0 .

The use of the present perfect therefore requires that the speaker should have a pre-present period (period up to t_0)² in mind. In many cases the idea of a pre-present period is evoked by an adverbial of the type *since 1970*, *up to now*, *so far*, etc.

I have visited Rome twice {since 1996 / since I was born}.

So far nothing has happened.

He’s been abroad for the last three weeks.

In such examples the adverbial denotes an Adv-time leading up to t_0 . (An *Adv-time* is an adverbially specified time span which ‘contains’ the situation time in terms of either inclusion or coincidence – see 2.23.1.)

2. Throughout this chapter, ‘period up to t_0 ’ or ‘period up to now’ should be interpreted as ‘pre-present period’, i.e. as a period which leads up to t_0 but does not include it.

5.1.6 When there is no time-specifying adverbial or context specifying the length of the pre-present, the pre-present remains **‘IMPLICIT’**. In that case it is normally interpreted as the shortest time span leading up to now that is relevant to the discourse and is in keeping with the semantics and pragmatics of the sentence and its context.

Have you seen my car keys? (*This only makes sense if interpreted as maximally indicating a period ‘since I last used the car’ – so usually, ‘in the last few hours’ or ‘since I got in yesterday’.*)

Have you had breakfast yet? (*The implicit period leading up to now is ‘today’; an answer like Yes, I did three weeks ago would therefore be quite inappropriate, as it would imply that breakfast is eaten only once in a period of at least three weeks.*)

John has already visited Tokyo. (*The time span leading up to now may be contextually identified as, for example, the particular journey through Japan which John is making at this moment; otherwise it will be interpreted as John’s lifetime.*)

I’ve been waiting for him. (*The length of the period leading up to t_0 will be clear from the context. If it is said by a mother waiting for her son at the gates of the school, it will be a relatively short time. If it is said by someone waiting for a sailor to come home, it is likely to be the time since the sailor left.*)

Have you seen John? (e.g. {since you arrived at the party / in the last twenty minutes})

Have you been to the Van Gogh exhibition? (*since it has been open to the public*)

5.2 The semantics and the T-interpretations of the present perfect

The semantics of the present perfect is. ‘The pre-present contains the situation time in terms of inclusion or coincidence. This semantics allows two ‘T-interpretations’. Firstly, on the ‘before now’ T-interpretation, the situation time is included in the pre-present and covers a portion of the pre-present that is not adjacent to t_0 . For example: *I have already met that man*. Secondly, on the ‘co-extensive’ T-interpretation, the situation time is co-extensive with the pre-present and therefore leads up to t_0 . For example, in *I have been working in the garden*.

5.2.1 In the tense model used here, the **CORE MEANING** (= semantics) of the present perfect is its tense structure: ‘The situation time is located in the pre-present zone of the present time-sphere’. In 5.1.1 we saw that this is equivalent to ‘The pre-present contains the situation time’. Since ‘containment’ means either inclusion or coincidence, this means that from a tense-structural (= semantic) point of view there are two possibilities: either the situation time fills

the entire (subjectively conceived) period up to now or it is included in it. Since the pre-present is defined as the time-zone which forms part of the present time-sphere and precedes t_0 in the sense that it leads up to t_0 but does not include t_0 , these two possibilities can be formulated as follows: either the situation time is conceived of as leading up to t_0 , i. e. as stopping just before t_0 but without any temporal space between the right bound of the situation time and t_0 , or the situation time is conceived of as lying at a certain distance from t_0 . (Note that all this is a matter of conceptualization rather than of what is the exact temporal location of the situation relative to t_0 in the real world. When a person comes back from somewhere I can ask him *What have you been doing?* or *Where have you been?* In the real world there has to be some interval (however short) between the situation referred to and my asking the question, but that interval is linguistically irrelevant: it does not prevent the situation time as being conceived of as leading up to t_0 .)

Within the two T-interpretations allowed by the semantics of the present perfect, we can distinguish three 'temporal W-interpretations': the 'indefinite reading' (i. e. the full situation comes to an end before t_0), the 'continuative reading' (i. e. the time of the full situation includes t_0) and the 'up-to-now reading' (i. e. the terminal point of the full situation is adjacent to t_0).

5.2.2 In sum, the semantics of the present perfect is 'The pre-present contains the situation time'. Since 'containment' means either inclusion or coincidence, this means that the present perfect is semantically (= tense-structurally) ambiguous between two meanings (which we will refer to as **T-INTERPRETATIONS**):

- (a) The '**BEFORE NOW**' T-interpretation: the situation time is included in the pre-present and covers a portion of the pre-present that is not adjacent to t_0 . This meaning is realized, for example, in *I have already spoken to that man*.
- (b) The '**CO-EXTENSIVE**' T-interpretation: the situation time is co-extensive with the pre-present and therefore leads up to t_0 . This meaning is realized, for example, in *I have been working in the garden*.

In both (a) and (b), the beginning of the pre-present zone can be indicated by adverbials like *since then*, *within the last three weeks*, etc. If there is no such adverbial, the pre-present zone is conceptualized as the shortest period up to t_0 that is in keeping with the semantics and pragmatics of the clause and its context (see 5.1.6).

It should be clear from the above paragraphs that, unlike the situation time (i. e. the time of the 'predicated situation' – see 2.12–13), the time of the full

situation does not play a part in the semantics of the present perfect, nor in the ensuing two T-interpretations. It does play a part, however, in the definition of the three **TEMPORAL W-INTERPRETATIONS** that can be assigned to present perfect clauses. These will be discussed in section 4, where we will distinguish between the ‘*indefinite reading*’ (i. e. the full situation comes to an end before t_0), the ‘*continuative reading*’ (i. e. the time of the full situation includes t_0) and the ‘*up-to-now reading*’ (i. e. the terminal point of the full situation is adjacent to t_0). The last two W-readings are illustrated by the following examples, in which *I have been working in the garden* each time receives a co-extensive T-interpretation but receives two different W-interpretations:

[“What have you been doing for the last hour?”] – “*I have been working* in the garden.”

I have been working in the garden [*for two hours now, and I still haven’t finished.*]

In the first example, *I have been working in the garden* may be uttered by someone who has just come inside (and has therefore stopped working in the garden), whereas in the second example it is uttered by somebody who is still working in the garden. This means that within the co-extensive (= ‘situation time up to now’) meaning two different temporal interpretations of the location of the full situation relative to t_0 are possible. (We will speak of the ‘up-to-now reading’ and the ‘continuative reading’, respectively.) These readings are W-interpretations: they belong to the same semantic type of present perfect and are triggered by factors having to do with the linguistic or extralinguistic context. Moreover, they refer to the location of the time of the *full* situation relative to t_0 .

5.2.3 In sum, as far as temporal interpretation is concerned, we have to distinguish between the following three levels:

- (a) The **CORE MEANING** of the present perfect is its semantics, i. e. the tense structure which it expresses. This core meaning is: ‘The situation time is contained in the pre-present’. The pre-present is that zone of the present time-sphere that is conceptualized as starting before t_0 and leading up to it, without including it.
- (b) There are two ‘**T-INTERPRETATIONS**’ which are in keeping with the semantics of the present perfect. They have to do with the location of the situation time (= the time of the ‘predicated situation’ – see 2.13) relative to t_0 . These T-interpretations are: ‘The situation time lies wholly before t_0 ’ (= ‘situation time before now’) and ‘The situation time is co-extensive with the pre-present’ (= ‘situation time up to now’). The existence of these T-interpretations follows naturally from the fact that the statement *The situation time is contained in the pre-present* can mean either ‘The situation time is included in the pre-present’ or ‘The situation time coincides with the pre-present’.

- (c) As far as the full situation is concerned, there are three **TEMPORAL W-INTERPRETATIONS**: the ‘indefinite reading’ (i. e. the full situation comes to an end before t_0), the ‘continuative reading’ (i. e. the time of the full situation includes t_0) and the ‘up-to-now reading’ (i. e. the terminal point of the full situation is adjacent to t_0). These will be discussed in 5.3–4 below.

5.2.4 Later on in this chapter we will explain that the present perfect has not only one core meaning, two T-interpretations and three W-interpretations, but also (at least in its ‘up-to-now’ W-interpretation) two functional readings, one of which allows further possible readings. Figure 5.1 gives an overview of all these ‘meanings’ (in the nontechnical sense of the word). (What is not mentioned in this table is that, as we will see, it is sometimes possible to distinguish a few *usage types* within a given W-interpretation. Thus, the so-called ‘resultative perfect’, ‘hot news perfect’ and ‘perfect of experience’ are all (nontemporal) W-readings which are assigned to certain present perfect sentences that receive the indefinite temporal W-interpretation – see 5.13–16.)

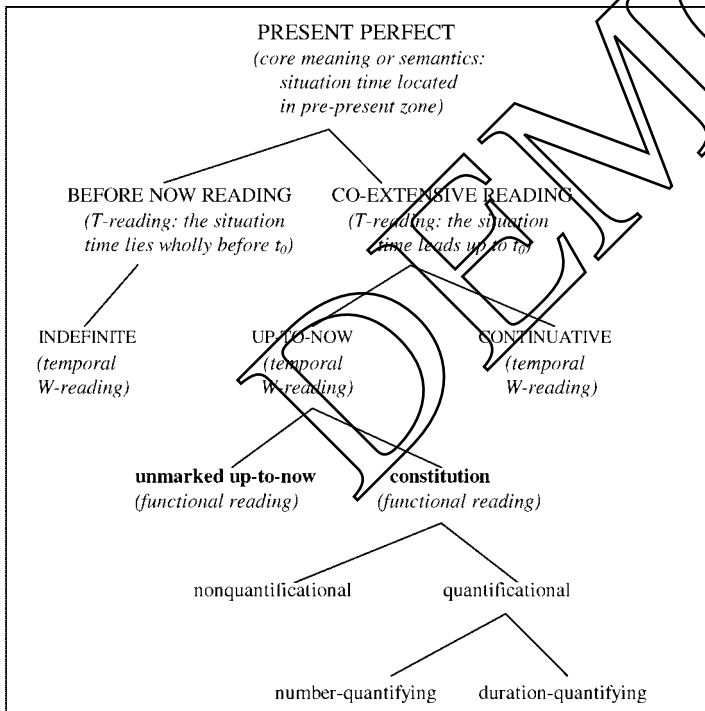

Figure 5.1. The various readings of clauses in the present perfect.

II. The temporal W-interpretations of present perfect clauses

5.3 Introduction

Since the situation time may coincide with the pre-present or be included in it, and since the time of the full situation can similarly contain the situation time in terms of coincidence or inclusion, there are in principle four possibilities as far as the W-relation between the time of the full situation and the pre-present time-zone is concerned. In practice, however, clauses in the present perfect can only receive three different temporal W-interpretations concerning the location of the full situation relative to the pre-present: an ‘indefinite’, ‘continuative’ or ‘up-to-now’ reading. The reading is ‘indefinite’ if the time of the full situation does not lead up to the endpoint of the pre-present zone, as in *Meg has already washed the elephant*. The reading is ‘continuative’ if the time of the full situation is taken to include t_0 , as in *Meg has been washing the elephant for half an hour now*. The reading is an ‘up-to-now’ interpretation if the full situation covers the entire pre-present but does not include t_0 , as in *Where have you been?* (addressed to someone who has just come in).

5.3.1 Whereas the T-interpretations of a clause in the present perfect concern the location of the situation time (= time of the predicated situation) relative to t_0 , the temporal W-interpretations concern the relation between the time of the ‘full situation’ (see 2.16.1) and t_0 . Such a temporal W-interpretation depends in part on the semantics of the tense (i. e. on the location of the situation time in the tense structure) but also on other factors, such as ontological aspect (Aktionsart), grammatical aspect, actualization aspect (bounded *vs* non-bounded – see 1.44.1), time-specifying adverbials, duration adverbials, and other contextual and pragmatic factors. This is true of all W-interpretations. Thus, the temporal W-interpretation of *At five o’clock I was working* involves (at least) the following elements: (a) The situation time is located in the past time-sphere; (b) The situation time coincides with the Adv-time (= at five o’clock); (c) The time of the full situation is not represented as bounded and is longer than the situation time.

5.3.2 A situation time may in principle either coincide with the time of the full situation or be a subpart of it – remember the discussion of *Ten minutes ago John was in the library; perhaps he still is* in 1.44.2. In other words, irrespective of the tense used, the time of a full situation ‘contains’ the situation time in terms of inclusion or coincidence. (Inclusion requires the clause to be homogeneous, i. e. the full situation must not be represented as bounded – see

1.44.2.) When the present perfect is used, the pre-present similarly contains the situation time in terms of inclusion or coincidence. We can conclude from these statements that there are four theoretical possibilities as to the temporal relation between the pre-present zone and the time of the full situation.

- (a) The first possibility is that the situation time coincides with the time of the full situation and is included in the pre-present. In that case the clause receives a **'BEFORE NOW'** T-interpretation. This allows only one temporal W-interpretation, viz. that in which the time of the full situation lies entirely before t_0 in the pre-present. This possibility is illustrated by the following:

[Nobody can enter the house, because] I have locked the door and hidden the key.
(*The full situations are interpreted as lying wholly before t_0 .*)

Because it is typical of this temporal W-reading that the precise temporal location of the situation in the pre-present zone remains indefinite, we call this the **INDEFINITE READING** of the present perfect (or, more correctly, of the clause in the present perfect).

- (b) The second theoretical possibility is that the situation time coincides with the pre-present zone and is included in the time of the full situation. (The latter is only possible if the full situation is homogeneous and hence non-bounded – see 1.45.) In this case the full situation not only fills the entire period leading up to t_0 but also extends beyond it. That is, the full situation also includes t_0 and possibly part of the post-present, though the present perfect itself does not say anything about the post-present (nor, directly, about the inclusion of t_0 , because it is the situation time, not the time of the full situation, that is relevant to the semantics of a tense). This possibility leads to a temporal W-interpretation which is traditionally referred to as the **CONTINUATIVE READING**. For example:

Ian's been living in Lincoln since 1998. (*continuative reading: the sentence is W-interpreted as implying that Ian is still living in Lincoln*)

For two months now there has been a famine in this country. (= 'There has been a famine throughout the pre-present, and it is still continuing.')

- (c) The third theoretical possibility is that the situation time coincides with the time of the full situation and with the pre-present zone. This leads to the temporal W-interpretation that the time of the full situation fills the entire period leading up to t_0 but does not include t_0 . We refer to this as the **UP-TO-NOW READING**. (In this label, 'up-to-now' has the same meaning as in 'period up to now': in the same way as a pre-present period leads up to t_0 but does not include it, the up-to-now reading of a clause means that the full situation is taken to lead up to t_0 but without including t_0 .) For example:

(said to someone who has just come in) *Where have you been?*

[Representative Jo Ann Emerson recently announced Dec. 13 as the day traffic is anticipated to cross the new Bill Emerson Memorial Bridge. “We couldn’t be more excited about this,” said MoDOT District Engineer Scott Meyer.] “*We’ve been telling* the public the bridge would be opened by the end of the year [and we are very pleased to finally have an anticipated date for the bridge completion.]” (www)

- (d) The fourth theoretical possibility is that the situation time is included in (i. e. is shorter than) the pre-present and is also included in the time of the full situation. Since the latter possibility requires the full situation to be homogeneous and nonbounded, this leads to the expectation that the situation must be either a state or a dynamic (nonstative) situation represented as ongoing by the progressive form. Let us consider these two possibilities separately.

As regards states, it would at first sight seem to be impossible to find examples of present perfect sentences in which the full situation is a state and the two conditions (viz. the situation time is included in the pre-present and also included in the time of the full situation) are satisfied. In all of the following examples the full situation is interpreted as bounded (= having come to an end), which means that the situation time is interpreted as coinciding with the time of the full situation, so that the temporal W-interpretation is an indefinite reading: the full situation lies wholly before t₀.

John has been in the house.

John has just been in the house.

Has John ever been in the house?

The reason why the time of the full situation is W-interpreted as coinciding with the situation time is that this is the unmarked kind of containment relation between the time of the full situation and the time of the predicated situation (= situation time). In these examples there is nothing triggering the marked interpretation that the situation time is only a portion of the time of the full situation.

However, the situation time of a state *is* interpreted as included in the time of the full situation if the state functions as ‘background’ situation for an intervening situation:

You’ve never been behind someone when all of a sudden they slow down for no apparent reason and make a turn with no signal? (www) (*The time of the predicated situation is the portion before the slowing down and the full situation continues during the slowing down.*)

Clearly, this reading is not a new kind of reading but an ‘indefinite reading’.

If the situation is not a state, the two conditions (viz. the situation time is included in the pre-present and also included in the time of the full situation) can only be fulfilled if the progressive form is used. As noted in 1.22.4, the progressive form refers to some middle part of the full situation (because it disregards the situation's terminal point). That middle part is the situation time. Unlike an expression of state (e.g. *be in the house*), a progressive form thus automatically represents the situation time as included in (i.e. shorter than) the time of the full situation, which means that the second condition is fulfilled. Fulfilment of the first condition (viz. the situation time is included in the pre-present rather than co-extensive with it) is then also possible.

It should be noted, however, that this use of the progressive form is restricted to three types of present perfect sentences, illustrated by the following:

- (1) Who's the man you've just been talking to?³
- (2) Have you ever been working on a project?
- (3) Have you ever been working on a project [when you had to give it up temporarily for lack of funding]?

In (1), the full situation, which is longer than the situation time which coincides with the Adv-time (*just*), can only be W-interpreted as having come to an end before t_0 . This means that (1) receives an indefinite W-interpretation which is a 'recency interpretation' (see 5.16 and 5.25.5). Sentence (2), which is not acceptable for some speakers, also receives an indefinite reading (which, however, is not a recency reading). The speaker asks the hearer if the situation of his working on a project has been in progress at one or more bygone times within the pre-present. Sentence (3), which is fully acceptable because the *when*-clause provides the vantage point from which the situation is viewed as being in progress, receives a similar indefinite reading.⁴

In sum, possibility (d) does not give rise to a fourth type of W-interpretation: all the examples given receive an indefinite reading, i.e. the same reading as engendered by possibility (a).

3. The following is an authentic example of this type:

Are you quite sure you haven't just been speaking to the cryptic "K" herself? (DOC)

4. This kind of sentence is special in that the *when*-clause is not a time-specifying adverbial but a 'narrative' *when*-clause, i.e. a clause which 'pushes forward' the action – see 13.1.3. This means that the *when*-clause does not specify the time of the head clause situation. It is rather the other way round: the head clause expresses the background situation in the middle of which the *when*-clause situation actualizes. This means that this sentence is only acceptable if one mentally restructures it so that the perfect is separated from the progressive: the perfect goes with the (indefinite) interruption – *have you ever had to give up a project temporarily for lack of funding?* – and the progressive goes with the background situation – *while you were working on that project*. These paraphrases make it clear that the sentence receives an indefinite reading.

5.4 The three W-interpretations of clauses in the present perfect

This section goes further into the three temporal W-interpretations of clauses in the present perfect, viz. the indefinite, continuative and up-to-now readings.

5.4.1 As far as the W-relation between the time of the full situation and the pre-present time-zone is concerned, clauses in the present perfect can thus receive three different temporal W-interpretations: an indefinite, continuative or up-to-now reading. (When it comes to interpreting tensed clauses, it is the time of the full situation that is important. This is because a full temporal W-interpretation depends not only on the semantics of the tense – i. e. the location of the situation time – but also on other factors, such as adverbials and aspectual, contextual and pragmatic factors.)

On the **INDEFINITE INTERPRETATION**, the full situation is taken to actualize at some indefinite time (or times) in the course of the pre-present (which leads up to t_0 but does not include it). Even if the clause is L-homogeneous, as in *I have lived in Rome* or *Have you ever been watching your favourite programme [when unexpected visitors arrived]?*, not only the situation time but also the time of the full situation is taken to be included in the pre-present, i. e. the full situation is interpreted as not extending up to t_0 . (In other words, the situation is interpreted as W-bounded, though it is L-homogeneous.) On the **CONTINUATIVE INTERPRETATION** the speaker's message is taken to be that the full situation not only covers the entire pre-present period but also includes t_0 . That is, the full situation is still continuing at t_0 . (For example: *I've been waiting for him for two hours now.*) Finally, on the **UP-TO-NOW INTERPRETATION**, the full situation is taken to cover the entire pre-present, but without including t_0 . (For example: [*Oh, there you are!*] *What have you been doing?*)

The following sentences further illustrate the threefold distinction:

I've received e-mails from her before, you know. (*indefinite reading; the full situation lies completely before t_0*)

Someone has opened the window! (*similar*)

[I know my way around here because] I've been working for this firm since 1998. (*continuative reading: I am still working for this firm.*)

I've had this car for a long time. (*continuative reading: I still have the car in question*)

[Hello, Tom! It's a long time since I last saw you.] What have you been doing? (*up-to-now reading: the question concerns the addressee's actions during the complete pre-present period, but these actions are not continuing at t_0*)

Three weeks have elapsed since then. (*up-to-now reading: the reference is to a duration-specifying situation which fills the entire pre-present*)

“How many times has Bill seen Sharon this week?” – “Bill’s seen her three times.” (*up-to-now readings of the subtype which in 5.4.7 we will call the ‘number-quantifying constitution reading’: both speakers are concerned with the question how many times Bill has seen Sharon in a period leading up to now. This means that they are not concerned with the occurrence of one or two full situations at some indefinite time(s) in the pre-present but rather with the situational constitution of a specific period leading up to now. In other words, speaker A asks speaker B to ‘measure’ the period leading up to now by counting the number of actualizations in it. Speaker B does so in his reply.*)

[Helen is going through a depression. I know because] I’ve seen her three times this week [and each time she talked about how bad she felt.] (*indefinite reading: the speaker’s concern in this sentence is not with the situational constitution of the period leading up to now, i. e. with the number of actualizations in this period, but with adducing evidence for the claim that the speaker knows that Helen is going through a depression.*)

The last two examples illustrate an important point: the indefinite, continuative and up-to-now readings are W-interpretations that are allowed by the semantics of the present perfect but which the present perfect does not suggest on its own. Which reading is intended must be clear from the context (i. e. either from elements inside the sentence – e. g. an adverbial, the (non)homogeneous representation of the situation – or from the context in which the sentence is used).

5.4.2 The three temporal W-interpretations that can be assigned to a present perfect clause are represented in Figures 5.2–4. (The circles around t_0 are meant to visualize the fact that the pre-present zone does not include t_0 , but leads up to it. The horizontal slanting line in Figure 5.4 means that the full situation covers both the pre-present zone and t_0 .)

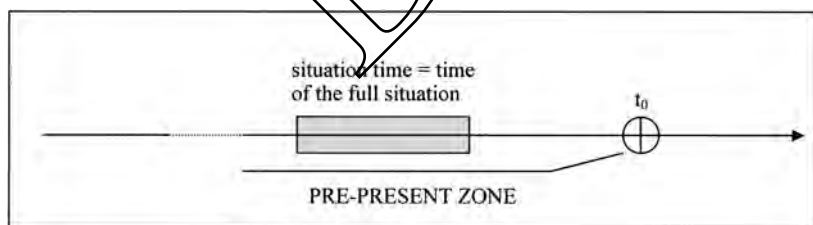

Figure 5.2. Representation of the indefinite reading.

5.4.3 It may be necessary to reiterate that in the examples given in 5.4.1 the three readings concern the times of the full situations. They are therefore W-

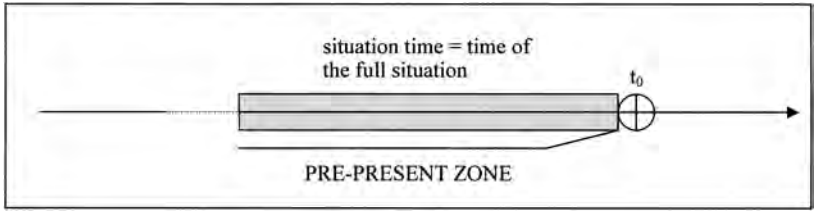

Figure 5.3. Representation of the up-to-now reading.

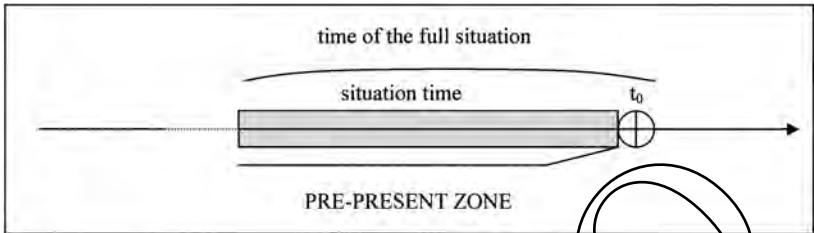

Figure 5.4. Representation of the continuative reading.

interpretations. Whichever interpretation is selected in connection with the time of the full situation, the semantics of the present perfect is always ‘The situation time is located in the pre-present zone’, i. e. ‘The pre-present zone contains the situation time’. As noted in 5.2.3, this leads to two possible T-interpretations, viz. ‘situation time wholly before t_0 ’ (= ‘the time of the predicated situation is included in the pre-present’) and ‘situation time up to t_0 ’ (= ‘the time of the predicated situation is co-extensive with the pre-present’). Each of the three context-dependent W-interpretations has to fit in with one of these.

5.4.4 The following is a summary of what has been said so far about the temporal W-interpretations:

- (a) The *indefinite reading* implies that the time of the full situation (and hence the situation time) is located at some indefinite time in the course of the pre-present and does not include (or coincide with) the terminal point of the pre-present, which lies right before t_0 . This is the W-reading that corresponds with the T-interpretation ‘The situation time is included in the pre-present’.

The indefinite reading means that the full situation is interpreted as W-bounded and thus the predicated situation time is the same as the full situation (i. e. the predicated situation occupies the same interval as the full situation) and is interpreted as over at t_0 . This is true not only if the present perfect form is nonstative and nonprogressive, as in *He has played football*, but also if the

present perfect form is stative, as in *I've been happy*, or progressive, as in *I've sometimes been watching a film on TV* [*when Bill suddenly rang at my door*] (where the situation functions as 'background' situation for a W-bounding intervening or interrupting situation – see section (d) of 5.3.2).

- (b) The *continuative interpretation* is an instance of the T-interpretation 'The situation time is co-extensive with the pre-present'. The full situation is W-interpreted as longer than the situation time and hence as still actualizing at t_0 : *Sharon has lived here since she was born* implies that Sharon still lives here. (However, as far as the tense structure is concerned, the situation time does not include t_0 . The continuative W-interpretation is rendered possible by the fact that the situation time can be shorter than the time of the full situation, because *live here* is a homogeneous (atelic) verb phrase. The continuative interpretation itself is triggered by factors other than the tense structure, such as the progressive form and/or the presence of an adverbial like *since 1995* or *for two weeks now* (etc.).
- (c) The *up-to-now reading* is another instance of the T-interpretation 'The situation time coincides with the pre-present'. This time the situation time is interpreted as also being the time of the full situation. The speaker makes a statement (or asks a question) about the entire (subjectively conceptualized) pre-present zone (which does not include t_0).

5.4.5 In sum, the three interpretations of present perfect clauses are W-interpretations concerning the location of the time of the full situation relative to t_0 . They can be distinguished on the basis of the features given in Figure 5.5.⁵

For a good understanding of Figure 5.5, the following things should be noted:

- (a) On the up-to-now reading, the time of the full situation is definite by virtue of being adjacent to t_0 . As we will see in 5.4.7, the situation is often a 'hypersituation' consisting of a number of 'subsituations' (e.g. *We've been telling our customers that we would give them any information they might need*). In that case the times of the subsituations except the last one are indefinite, but the time of the hypersituation as a whole is definite.

5. Note that we treat the so-called 'hot news', 'experiential', and 'resultative' interpretations of some clauses in the present perfect as usage types of the indefinite interpretation – see 5.13–5 and 5.37. Thus, the 'resultative' interpretation of a present perfect sentence like *Now she has gone to Singapore* is an indefinite reading, in spite of the presence of the definite time adverb *now*. The interpretation is indefinite because the location of the situation time in the pre-present is indefinite, i.e. the time when she went to Singapore is indefinite. The semantics of the present perfect is all about the temporal location of a situation time in the pre-present, not about the temporal location of a result, if any.

	indefinite reading	continuative reading	up-to-now reading
The situation time is conceived of as 'up to now', i.e. as including the terminal point of the pre-present (which is adjacent to t_0)	–	+	+
The time of the full situation coincides with the situation time	+ in possibility (a) in 5.3.2 ± in possibility (d) in 5.3.2	–	+
The time of the full situation includes t_0	–	+	–
The time of the full situation is definite	–	+	+ see note (a) below
The full situation is interpreted as bounded	+ in possibility (a) in 5.3.2 ± in possibility (d) in 5.3.2	– / (±) see note (b) below	+

Figure 5.5. The features of the W-interpretations of the present perfect.

- (b) In a sentence receiving a continuative reading (e.g. *We've been working since 9*), the full situation is not represented as L-bounded and is not usually interpreted as W-bounded, as the full situation may easily extend beyond t_0 . However, the full situation is interpreted as W-bounded if the context makes it clear that the full situation includes t_0 but does not extend beyond it. This possibility, though, is more theoretical than real, because it is pragmatically very unlikely. (Moreover, it is not easy to determine what 'full situation' means on a continuative interpretation. In section 5.7 we will make a distinction between the '*factual full situation*', which is that part of the situation up to and including t_0 , and the '*potential full situation*', which is the full situation including the potential portion which continues into the post-present. Needless to say, the former is interpreted as W-bounded – with t_0 as the provisional endpoint reached – whereas the latter is not.)

5.4.6 We cannot exaggerate the importance of the statement that the distinction between 'continuative perfect', 'up-to-now perfect' and 'indefinite perfect' is a matter of temporal W-interpretation rather than of tense-structural ambiguity, i.e. that it is not true that the present perfect can express three different tense structures. There is only one present perfect tense, and its semantics (= tense structure) is always 'The situation time is contained in the pre-present'. It follows that, if for ease of reference we speak of a '**CONTINUATIVE PERFECT**', we really mean a 'perfect in a clause receiving a continuative W-interpretation'. Similarly, the terms '**INDEFINITE PERFECT**' and '**UP-TO-NOW PERFECT**' are shorthand for 'present perfect in a clause receiving an indefinite reading' and 'present perfect in a clause receiving an up-to-now interpretation', respectively. And

when we speak of ‘continuative / indefinite / up-to-now meaning’, we are actually using ‘meaning’ in the sense of ‘interpretation’. The readings in question are W-interpretations, which can be provoked or excluded by the semantics or pragmatics of the linguistic or extralinguistic context. Let us illustrate this briefly in connection with the continuative interpretation:

- (a) The continuative reading of *He has been working in the garden since 8 o'clock* is due to the following factors. The use of the progressive form suggests that the situation time is only some ‘middle part’ of the time of a larger homogeneous full situation. That middle part is interpreted as coinciding with the period leading up to t_0 specified by the time-specifying adverbial. Since the time of the full situation is longer than the situation time, and the latter leads up to t_0 , the full situation is naturally interpreted as including t_0 (which is the time point adjacent to the terminal point of the pre-present zone and of the situation time), and often as extending beyond it.
- (b) In examples like *I have been taller than my mother since I was twelve* the continuative reading of the head clause is the only one that makes sense. This is due to pragmatic factors. Firstly, the referent of the subject is the speaker, who must be alive at t_0 since he is speaking at t_0 . Secondly, as a rule, once you are taller than your mother you remain taller than her (at least in the world as we know it). It follows that the speaker must still be taller than his mother at t_0 . The addressee will therefore assign a continuative interpretation to the head clause of the sentence.
- (c) In examples like *I've sung in the choir for as long as I can remember*, the duration adverbial refers to a period including t_0 and indicates the duration of the ‘factual full situation’ (i.e. the full situation as it has actualized over a period reaching up to and including t_0 – see 5.7).⁶ In doing so the duration adverbial triggers a continuative interpretation. (The precondition for the continuative reading – that the situation be homogeneous, in other words that the situation time can be a proper subpart of the time of the full situation – is satisfied because *I've sung in the choir* refers to a permanent habit: as noted in 1.23.3, a habit is a kind of state; a state that is not represented as restricted in time by an adverbial like *until five* or *for two hours* is by definition L-nonbounded and therefore homogeneous.)

6. Since this reading means that the full situation includes the entire pre-present zone plus t_0 , the duration adverbial indirectly also specifies the length of the pre-present zone (which has the same duration except that it does not include t_0). In 2.22.3 we have named such adverbials which specify not only duration but also time ‘bifunctional temporal adverbials’.

It may also be noted that in the discussion here we are only concerned with the continuative reading of *I've sung in the choir for as long as I can remember*. The up-to-now reading is disregarded.

- (d) The same is true of examples like *She's known him for many years now*. The adverbial *for many years now* indicates a period which includes t_0 . Like any duration adverbial, it specifies the time of the full situation, which therefore also includes t_0 . The result is a continuative interpretation.

Apart from cases like the above ones, in which a continuative reading is invited by an adverbial and/or the progressive form and/or pragmatic factors, a continuative interpretation will not suggest itself, because the semantic structure of the present perfect does not itself invite such a reading. The idea 'The pre-present contains the situation time' does not by itself suggest that the situation time is only part of the full situation (which is a precondition for a continuative interpretation). In fact, there is nothing in the semantics of the present perfect that provides information about whether the time of the full situation extends into a time-zone, or time-zones, other than the pre-present zone in which the situation time is located. This is clear from a comparison of the following examples: the examples in (1) all invite a continuative reading, whereas the examples in (2), which are the same as the examples in (1) except that they are stripped of the progressive form and/or the time-specifying adverbial, all receive an indefinite interpretation:

- (1) I have been working in the garden since 8 o'clock. (*single continuative dynamic situation*)
 Mr Whorf has been our sales representative for 21 years. (*continuative state*)
 He's been going to that shop for as long as I can remember. (*continuative habit*: 'He's had the habit of going to that shop for as long as I can remember')
 Bridget has sung in the church choir for 15 years. (*continuative habit*)
- (2) I have worked in the garden. (*indefinite reading*)
 Mr Whorf has been our sales representative. (*indefinite reading*)
 He's gone to that shop. (*indefinite reading*)
 Bridget has sung in the church choir. (*indefinite reading*)

The only clue as to the temporal interpretation of the sentences in (2) is the semantics of the present perfect: the situation time is contained in the pre-present. Since the pre-present leads up to t_0 but does not include t_0 , and since there is no indication that the situation time is only part of the time of the full situation, these sentences naturally receive a noncontinuative interpretation (i. e. the situation time does not include t_0 and is the time of the full situation). That the noncontinuative interpretation in question is an indefinite one rather than an up-to-now reading follows from the fact that a nonprogressive form is used – see 5.25–29.

5.4.7 As we will see in 5.17–19, there are various kinds of up-to-now reading. We are going to introduce them in a nutshell here because we need the terms for a good understanding of the subsections of 5.5. The various kinds of up-to-now reading all have in common that the full situation is taken to cover

the entire pre-present, i. e. the full situation leads up to t_0 in such a way that it does not include t_0 and that there is no significant interval between the end of the full situation and t_0 .

One type of up-to-now reading is the ‘**CONSTITUTION READING**’. Here the speaker looks back on the pre-present to ‘measure it’ or to see how this period has been filled ‘situationwise’. The speaker thus focuses on the situational constitution of the pre-present zone and not only on the temporal location of a situation in that zone. On the constitution reading the pre-present may be filled either by one full situation which actualizes throughout the pre-present period (but without including t_0) or by a number of full situations which (possibly in combination with gaps) form a ‘hypersituation’ which coincides with the pre-present but does not include t_0 . In the latter case, the number of constituting subsituations may be zero, one or more.)

There are three subtypes of constitution reading, all of which are ‘specificational’ (see 5.20):

- (a) The speaker may be concerned with the nature of the situation that is conceived of as having lasted throughout the pre-present without including t_0 (e. g. *What have you been doing?*; *Where have you been?*). In that case there is a ‘**NONQUANTIFICATIONAL CONSTITUTION**’ interpretation.
- (b) The speaker may be concerned with the length of the pre-present zone and indicate this by a bounded present perfect sentence referring to a duration-specifying situation (e. g. *Nearly a year has gone by since then*). In that case there is a ‘**DURATION-QUANTIFYING CONSTITUTION**’ interpretation.
- (c) The speaker may also be concerned with how many times a specific situation (or kind of situation) has actualized in the course of the pre-present (e. g. *How many times have you met him in the past week?*). In that case there is a ‘**NUMBER-QUANTIFYING CONSTITUTION**’ interpretation.

An up-to-now reading which is not a constitution reading, because it is not ‘specificational’ (see 5.20), will be called an ‘**UNMARKED UP-TO-NOW**’ reading. An example is *You’ve been thinking of something else all the time I’ve been talking to you about this machine*.

The label ‘**QUANTIFICATIONAL CONSTITUTION READING**’ will be used as a cover-term for duration-quantifying constitution readings and number-quantifying constitution readings.

5.5 Further arguments for distinguishing between three W-interpretations

5.5.1 The need for distinguishing between three different W-interpretations of present perfect clauses is particularly clear from the fact that one and the

same present perfect form is sometimes compatible with each of the three interpretations. This is true of *have been*, which can be used in three kinds of (W-interpretation-determining) context. Compare the following:

[How much longer will I have to wait?] I *have been* here since five a.m. (*continuative reading*)

[Oh, there you are!] Where *have you been* all this time? (*up-to-now reading*)

Have you ever *been* in Singapore at New Year? (*indefinite reading of the subtype 'perfect of experience' – see 5.13.1*)

The American president *has been* in Beijing today. (*Nothing in the sentence represents the situation as bounded. Out of context, both a continuative and an indefinite interpretation are possible.*)

The American president *has been* in Beijing today. [Now he is on his way to Shanghai.] (*The second sentence rules out the continuative interpretation of the first.*)

The American president *has been* in Beijing all day today. [Now he is on his way to Shanghai.] (*The second sentence again rules out the continuative interpretation of the first. The presence of all day enforces the up-to-now reading.*)

Similarly, the present perfect form *have been waiting* can be used in three kinds of (disambiguating) context:

I've *been waiting* for her for nearly half an hour now. (*continuative reading*)

[Oh, there she is!] I've *been waiting* for her. (*up-to-now reading*)

[This isn't the first time I've waited for her. In fact, she's often gone on business trips and] every time I've *been waiting* for her when she's arrived back. (*indefinite reading*)

5.5.2 The threefold interpretive distinction has a few grammatical correlates. Firstly, some temporal adverbials are compatible with one or two of the readings only. For example:

From *childhood* she's *had* a timid character. (*continuative reading only*)

I've hated her ever *since* (I was a child). (*continuative reading only*)

Has she *ever* been in a foul temper? (*indefinite interpretation only*)

[I've been away for two hours, and] *all this time* you've been sitting there doing nothing! (*indefinite and continuative readings excluded*)

Where have you been {*within / in*} *the last four days*? (*continuative reading excluded*)

Where have you been *for the last four days*? (*indefinite and continuative readings excluded*)

I've killed three people in the past. (*indefinite interpretation only; this can only mean that there has been an occasion in the past on which I killed three people: the*

sentence cannot be used in answer to the question How many people have you {ever killed / killed up to now}?⁷

[The way I rationalised these conflicting emotions was entirely predictable.] It's the view that I have seen expressed everywhere *ever since*: [what was offensive was not the image itself, but its blatant exploitation for a commercial purpose.] (www) (*continuative reading only*)

Secondly, there are a few syntactic constructions that are only compatible with an up-to-now reading of the constitution kind:

It's *been* three weeks since I last saw him.

This is only the first time they *have met*.

These constructions will be discussed in 5.21.1 and 5.21.3, respectively.

Thirdly, there is a relation between the (im)possibility of using the progressive form (when the verb is nonstative) and certain temporal W-interpretations. The indefinite reading is incompatible with progressive aspect, except on a recency reading and if the situation in question serves as background for an intervening situation (see 5.16 and 5.25.5). Thus, in isolation *Have you written a book?* is interpreted as indefinite, and *Have you been writing a book?* as continuative, but the latter clause receives an indefinite reading in *Have you ever been writing a book when you suddenly suffered from writer's block?* (The relevance of the (non)progressive form to the temporal W-interpretations and even to functional subtypes of the up-to-now W-interpretation will be dealt with in more detail in 5.23–29.)

Fourthly, a temporal W-interpretation can be invited or excluded by the presence of a definite indication of frequency. Compare:

We've been eating on the verandah since this spell of good weather started. (*continuative reading; the situation that is interpreted as continuing at t_0 is a temporary habit, which is a static hypersituation involving a number of dynamic subsituations.*)

7. The example is interpretable as an answer to the question *How many people have you killed in the past?* only if the question is interpreted in the same way as the example has to be interpreted. In fact, neither the reply nor the question is easy to interpret. As said in the text, the example can only be interpreted as referring to a single indefinite experience of killing three people, as in

Whenever I've been on patrol I've killed someone. I don't often manage to kill more than one person, but *I've killed three people in the past*.

(The rather bizarre nature of the context we have to conjure up gives some idea of why it is so hard to interpret the example). Now, if one interprets the question in the same way, it is acceptable:

["How many people do you expect to kill while you're on patrol today?" – "I don't know." – "How many people have you killed in the past? [i. e. on individual past occasions of being on patrol]" – "Usually only one, but I HAVE killed three people."

But the example *I've killed three people in the past* cannot be used as an answer to *How many people have you killed in the past five years?* or *How many people have you ever killed?*

*We've been eating on the verandah three times since this spell of good weather started. (*The fact that the number of subsituations is specified rules out the habitual interpretation.*⁸ *The reading that a static hypersituation is still continuing at t_0 is therefore not available, and neither is an indefinite reading or a quantificational constitution reading. The latter two would require a nonprogressive verb form.*)

We've eaten on the verandah three times since this spell of good weather started. (*The continuative reading is again unavailable. If the sentence is taken to answer the (overt or covert) question 'How often have you eaten on the verandah since this spell of good weather started?' it receives an up-to-now reading. This up-to-now reading is of the subkind which in 5.4.7 we have called the 'number-quantifying constitution' reading, i.e. the reading on which the speaker specifies the number of subsituations making up the hypersituation leading up to now. If the speaker is not so much concerned with the exact number of times the situation has actualized as with the fact that it HAS actualized, the intended interpretation is an indefinite one.*)

See sections 5.23–29 for a detailed treatment of the connection between (non)-progressive aspect and the three W-interpretations.

Fifthly, in a complex sentence, a head clause in the present perfect may sometimes support a subclause using a **RELATIVE TENSE**, i.e. a tense which relates the situation time of the subclause to the situation time of the head clause rather than to t_0 . (A tense relating a situation time directly to t_0 by locating it in the past, pre-present, present or post-present is an **ABSOLUTE TENSE**.) It appears that relative tenses can be used in subclauses depending on a present perfect head clause which receives an indefinite reading or up-to-now reading, but not after a head clause using a present perfect which receives a continuative reading – see 2.17 and chapter 9.

Has he ever told you that he had been beaten up by his father? (*indefinite reading of the head clause; had been beaten up represents the beating as T-anterior to the telling.*)

[It's disastrous that the stock market has crashed.] We've been reassuring our customers that this wouldn't happen in the near future. (*unmarked up-to-now reading of the head clause; wouldn't happen represents its situation time as T-posterior to the reassuring, which has now come to an end.*)

So far he has kept quiet about what {happened / has happened /*had happened}. (*continuative reading of the head clause; had happened cannot be used to represent the subclause situation as anterior to the keeping quiet: we have to use one of the 'absolute' (see 2.15.2) tense forms happened or has happened instead.*)

8. A habitual interpretation always requires that the total number of subsituations should not be specified. This is even true of past habits expressed by *used to* or *would*: unlike *I (often) used to meet him that summer* and *We would occasionally play together*, the sentences **I used to meet him thirteen times that summer* and **We would play together three times* are ungrammatical.

5.5.3 It is also interesting to note that in other Germanic languages, the continuative perfect reading can (or must) be expressed by the present tense, while the present tense cannot express the indefinite reading or an up-to-now interpretation. The following examples are from Dutch:

*Ik ken hem al vele jaren. (continuative reading; the literal English translation is *I know him for many years.)*

*Ik {heb dat nooit geweten / *weet dat nooit}. (indefinite reading; the literal English translation is I {have never known / *never know} that.)*

*[Ik ben net verhuisd, maar] ik {heb tot nu toe in Londen gewoond / *woon tot nu toe in London}. (indefinite reading; the literal English translation is [I have just moved but] I {have lived / *live} in London until now.)*

5.6 Summary of the meaning(s) and W-readings of the present perfect

5.6.1 The pre-present zone should not be assumed to be conceived of as leading up to *and including* t_0 . The pre-present zone does not include t_0 , but many sentences in the present perfect are interpreted as referring to a (full) situation that includes t_0 . There is no contradiction between these statements because it is a general rule that locating a situation time in a particular absolute zone (i. e. past, pre-present, present or post-present) does not exclude the possibility that the time of the full situation also includes (part of) another zone. (Remember the discussion of *Ten minutes ago John was in the library. [Perhaps he still is.]* in 1.44.2.)

Neither does the claim that the pre-present does not include t_0 clash with the observation that the present perfect is often accompanied by a 'bifunctional' adverbial which (is interpreted as referring to, and indicating the length of a period that not only lasts up to t_0 but also includes it, e. g. *for two days now, from childhood, since 1998.* We speak of **bifunctional adverbials** because they specify both duration and time – see 2.22.3.) In *I've known her from childhood*, the adverbial indicates the duration of the full situation and at the same time specifies the Adv-time leading up to t_0 (= the pre-present), which contains the situation time in terms of coincidence. This is in keeping with the semantic principles 'The time of the full situation contains the situation time' and 'The pre-present contains the situation time', where 'contain' each time means either inclusion or coincidence.

5.6.2 The semantics of the present perfect is such that it represents a situation time as contained in the (subjectively conceived) pre-present. Since containment means either coincidence or inclusion, and since the pre-present does not include t_0 (but stops right before it), it follows that the situation time also fails

to include t_0 . This does not prevent the time of the *full* situation from being W-interpreted as including (i. e. as continuing at, and possibly beyond) t_0 . As with any other tense, the semantics of the present perfect concerns the temporal location of the situation time, not the temporal location of the full situation.

5.6.3 The semantics of the present perfect allows two T-interpretations: ‘The situation time lies wholly before t_0 ’ and ‘The situation time is co-extensive with the pre-present’ (= ‘situation time up to t_0 ’). In the former case there is some interval of time between the situation time and t_0 ; in the latter case the endpoint of the situation time is adjacent to t_0 . The indefinite reading is of the former type, the continuative and up-to-now readings of the latter. (Irrelevant gaps between the situation time and t_0 are disregarded.)

5.6.4 As far as the W-relation between the time of the full situation and the pre-present time-zone is concerned, clauses in the present perfect can receive three different temporal W-interpretations: an indefinite, continuative or up-to-now reading. (It is the time of the full situation rather than the situation time alone that is relevant to the temporal W-interpretation(s) of a clause. This is because a full temporal W-interpretation depends not only on the semantics of the tense – i. e. the location of the situation time – but also on other factors, such as adverbials and aspectual, contextual and pragmatic factors.)

- (a) The **indefinite interpretation** is the W-reading that corresponds with the T-interpretation ‘situation time before t_0 ’. The situation is taken to actualize at some indefinite time (or times) in the course of the pre-present; there is a non-negligible interval of time between the actualization(s) and t_0 . Examples are *I have been in Paris too* or *Have you ever been reading a thrilling book [when you were interrupted by a visitor]?*
- (b) On the **continuative interpretation** the speaker’s message is taken to be that the full situation not only covers the entire pre-present period but also includes t_0 . This means that the situation time coincides with the pre-present, but that the full situation, which is homogeneous, is longer and also includes t_0 and possibly extends into the post-present.
- (c) On the **up-to-now reading**, the time of the full situation coincides with the situation time, which itself coincides with the pre-present time-zone. All three have an ‘up to now’ meaning: they lead up to t_0 but do not include it, and there is no relevant gap between the time or period and t_0 .

III. More on the continuative reading of the perfect

5.7 The ‘factual full situation’ vs the ‘potential full situation’

On a continuative reading, the full situation may continue beyond t_0 . We therefore distinguish between the ‘factual full situation’, i. e. the portion leading up to and including t_0 , and the ‘potential full situation’, i. e. the full situation including the potential portion following t_0 .

A continuative interpretation of a present perfect sentence means no more than that the full situation is taken to start before t_0 and to continue at t_0 . It leaves open the possibility that the full situation does not continue beyond t_0 as well as the possibility that the full situation extends into the post-present.

Ever since the death of his wife he has been in that pub for at least six hours a day. (*The sentence leaves vague whether this continuative temporary habit will continue into the future or not.*)

We’ve been waiting for two hours. (*This sentence can be followed either by I’ve had enough; I’m leaving, which implies that the waiting will not continue beyond t_0 , or by Let’s give him one more hour, but then we’re leaving, which implies the opposite.*)

Examples like these render it necessary to distinguish between the factual portion of the full situation and the full situation itself. We will use the labels ‘FACTUAL FULL SITUATION’ and ‘POTENTIAL FULL SITUATION’ to refer to these two possibilities. On a continuative reading, a duration adverbial specifies the length, not of the potential full situation but of the factual portion of it, i. e. the portion of it whose terminal point is t_0 . If the potential full situation is homogeneous, it can extend beyond t_0 , in which case it consists of a part which is factual at t_0 and a part which is ‘not-yet-factual’ at t_0 . (Anything that follows t_0 belongs to a possible world which is not yet factual at t_0 .)

It follows that a present perfect clause involving an NP that renders the full situation heterogeneous (e. g. *I have written two letters*) cannot receive a continuative interpretation: in that case there is no potential full situation that is homogeneous and can extend beyond t_0 . It also follows that if a present perfect clause is rendered L-bounded by a bifunctional adverbial specifying a period reaching up to (and including) t_0 , as in *I have been here for two hours now*, only the factual full situation is L-bounded (the boundary in question being t_0). The potential full situation, which also includes the not-yet-factual (potential) part, is interpreted as W-nonbounded.

5.8 Conditions for the continuative W-interpretation

5.8.1 When the present perfect sentence is used out of context, a continuative reading normally suggests itself only when there is an adverbial indicating the relevant period leading up to now. Compare:

I have lived here. (*indefinite reading*)

I have lived here since 1989. (*continuative reading strongly invited*)

Similarly, the following example cannot be interpreted, as it stands, as continuative.

I have been shampooing this poodle.

The only interpretation here (without further context) is: ‘In the period leading up to now I have been shampooing this poodle and have very recently stopped doing so’. (This is an up-to-now reading.) When there is a contextual or adverbial indication of a period leading up to t_0 , a continuative interpretation is possible, provided it is allowed by the context. Compare:

I *have been shampooing* this poodle for half an hour [and I’m still trying to rinse the soap out of its fur]. (*continuative reading*)

I *have been shampooing* this poodle for half an hour. (*continuative reading*)

[“Your dress is crumpled. How come?”] – “I *have been shampooing* the poodle. [As a result my dress was soaked, but at least the poodle is clean now.] (*up-to-now reading*)

[“What have you been doing for the last half hour?”] – “I *have been shampooing* the poodle. (*up-to-now reading*)

5.8.2 A second condition for the continuative W-interpretation to arise is that the factual full situation must not be represented as bounded. The only exception to this is the case in which the situation is only represented as bounded due to the presence of a time-specifying adverbial and that adverbial, while it specifies the length of the factual full situation, does not exclude the possibility of there being a potential post-present part of the full situation. In such a case, while the full situation is bounded at t_0 , it is at the same time potentially unbounded beyond t_0 .

I have worked here for nearly fifteen years. (*The sentence receives a continuative interpretation. The time-specifying adverbial specifies a period which is bounded by t_0 .*)

I have lived in a small flat until now. (*The time-specifying adverbial specifies a period up to now and implicates that the situation is seen as closed off, i. e. bounded. Because it is suggested that the situation will not have a potential post-present part, a continuative interpretation is unlikely. The normal reading is the unmarked up-to-now one.*)

The claim that, except in examples like the above ones, a continuative W-interpretation will not arise if the factual full situation is represented as bounded is illustrated by examples like the following.

I have written a book since I started university. (*indefinite interpretation only*)

I have walked three miles since I left. (*up-to-now reading only*)

I have marked three exam papers since breakfast. (*up-to-now reading only*)

These sentences combine a telic VP with a nonprogressive verb form. As explained in 1.49.1, such a combination always triggers an L-bounded reading. If we try enforcing a continuative interpretation by adding an adverbial like *ever since*, *for the last ten minutes*, etc., to the above sentences, the result is ungrammatical:

**I have written* a book ever since I started university.

**I have marked* three exam papers for the last ten minutes.

**I have walked* three miles ever since I left home this morning.

Using the progressive form renders such sentences acceptable if there is a suitable continuative interpretation (in which the progressive situation is seen as nonbounded):

I have been writing a book ever since I started university. (= *I've been working on a book ...*)

For the last ten minutes *I have been marking* three exam papers. (*This is acceptable on a continuative reading implying that the marking is not finished – either each paper is not fully marked or the three papers are seen as a unit and at least one is not fully marked.*)

I have been walking three miles a day ever since I left home. (*This is grammatical as an expression of a continuative habit – see 5.24 below. The idea of repetition comes from a day, which can therefore not be omitted.*)

5.8.3 The requirement that the full situation should not be interpreted as bounded implies that a continuative W-interpretation will not arise if it is blocked by a context imposing a W-bounded interpretation of the full situation, and that it has to be discarded at once if it is cancelled by the context following the clause. For example, the continuative reading is the unmarked reading of [*Since she left Bristol,*] *Caroline has lived* in London, but it is blocked when the speaker specifies other places where Caroline has lived in the relevant period: *Since she left Bristol, Caroline has lived in London, Glasgow and Southampton*. Similarly, the continuative reading is the unmarked interpretation of *Jane has been supplying* John with heroin, but it can be cancelled by the context, as in *Jane has been supplying* John with heroin, [*but now she can no longer afford to*].)

5.8.4 When the situation referred to is a repetitive habit (which is a static hypersituation – see 1.23.3), the continuative interpretation is ruled out if the precise number of subsituations making up the hypersituation is specified. This too has to do with the criterion of nonboundedness, since a specification of the number of subsituations automatically renders the clause bounded. Compare:

We've been eating on the verandah since this spell of good weather started. (*continuing temporary habit* – see 5.24.1 below)

**We've been eating* on the verandah eight times since this spell of good weather started. (*Of course, we can say We've eaten on the verandah eight times since this spell of good weather started, but this clause receives an up-to-now reading, not a continuative one. As we will see in 5.19.1, the up-to-now reading in question is a 'quantificational constitution reading': the sentence answers the (overt or covert) question 'How often have you eaten on the verandah since this spell of good weather started?'*)

The reason for this constraint is the following. Since a continuative reading in which the (potential) full situation may extend beyond t_0 requires the sentence to be W-nonbounded, this reading cannot be assigned to a sentence specifying the exact number of times a telic situation has been repeated in the pre-present, because such a specification entails a bounded (more specifically: bounded-repetitive – see 1.49.1) reading. This explanation is also in keeping with the fact that a bounded representation of a situation is incompatible with an adverbial enforcing a continuative reading:

**I have written* three books ever since I entered university. (*Compare with I have written three books so far, which is grammatical but cannot receive a continuative interpretation.*)

**I have come* to this shop thirteen times for years. (*Compare with I've come to this shop thirteen times since then, which receives a noncontinuative reading.*)

This restriction is not affected by the use of the progressive form, because (as noted in 5.29.1) the progressive only renders the individual telic situations nonbounded, but not the series as a whole:

**I have been writing* three books ever since I entered university.

**I have been coming* to this shop thirteen times for years.

5.9 Factors triggering a continuative interpretation

5.9.1 Because a continuative reading means that the time of the full situation, which starts before t_0 , includes t_0 , many languages use the present tense to convey this interpretation. In Standard English, however, this reading requires the use of the present perfect when there is a time-specifying adverbial or bi-functional adverbial interpreted as referring to a pre-present period.

I {have lived / *live} here since 1965.

I {have known / *know} him for a very long time.

I {have already been waiting / *am already waiting} for her for two hours.

An adverbial specifying a period up to t_0 imposes the T-interpretation that the situation time is co-extensive with the pre-present and in doing so rules out an indefinite reading. The presence of such an adverbial is, however, compatible with a continuative interpretation (as well as with an up-to-now one). Moreover, there are adverbials that are compatible with the continuative reading only. Compare:

The Johnsons *have lived* in London for three years. (*This sentence in principle allows an indefinite reading, an up-to-now reading or a continuative reading. The last is the preferred interpretation if the sentence is used out of context.*)

The Johnsons *have lived* in London for three years now. (*The presence of now in the adverbial means that the period indicated can only be a period up to t_0 . The continuative interpretation is therefore enforced.*)

I've *worked* in London since I left home. (*naturally interpreted as continuative, though the other readings are not ruled out*)

Since I left home, I've *worked* in London, Durham and Swansea. (*The continuative and the up-to-now interpretations of I've worked in London are ruled out by the other indications of place, at least if the latter are taken to indicate the consecutive places where I have worked.*)

I've *worked* in London ever since I left home. (*The continuative reading is imposed by the addition of ever to the since-clause.*)

Ever since I left home, I've *worked* in London, Durham and Swansea. (*Because of ever, the only possible reading is the continuative one, which implies that I have worked in London, Durham and Swansea simultaneously or alternately, but not consecutively.*)

5.9.2 When the situation referred to is a permanent (unalterable, irreversible) state, the present perfect sentence will automatically be interpreted as continuative:

He's been dead for a while. (*The indefinite reading is excluded because an irreversible state of affairs is L-nonbounded and cannot be interpreted as W-bounded. An attempt to cancel the continuative reading by adding but he no longer is leads to unacceptability, at least in the world as we know it.*)

5.9.3 As we will see in 5.23, when the reference is to a single dynamic (= nonstatic) agentive situation, it is often necessary to use the progressive form if a continuative reading is intended. Conversely, the progressive form often invites a continuative reading because the indefinite reading is not normally compatible with it, while an up-to-now reading usually needs a context imposing it. Compare:

I've worked hard. (indefinite reading)

I've worked hard for a long time. (This allows the indefinite reading 'Somewhere in the pre-present there has been a period when I worked hard.' In the absence of the progressive, a continuative reading is possible, but only if the situation is interpreted as a continuative habit (which is a kind of state – see 1.23.3.). A habitual reading can also be an unmarked up-to-now reading if the sentence is couched in a suitable context, as in I've worked hard for a long time. [I retired yesterday and I'm going to enjoy my retirement.])

I've been working hard. (Out of context, this receives a continuative reading.)

I've been working hard for some time. (The indefinite reading is ruled out because the sentence is progressive and contains a bifunctional adverbial. Out of context, the sentence invites a continuative reading.)

I've worked hard since I've been a member of this club. (Out of context, the sentence is interpreted as referring to a continuative habit.)

I've worked hard since five o'clock. (Out of context, the sentence is interpreted as referring to a single dynamic situation which started before t_0 and still continues at t_0 .)

The relation between the continuative perfect and (non)progressive aspect is explored in more detail in 5.23–24 below.

5.9.4 In spite of the fact that adverbials like *still*, *these days* or *nowadays* imply that the situation referred to started before t_0 , these adverbials are not compatible with a continuative present perfect. The present tense has to be used instead (because the speaker focuses more strongly on what is the case at t_0 than on the fact that the situation initiated before t_0).

It's nearly dark and they {*are still working* / **have still been working*}.

He doesn't realize yet that things {*are* / **have been*} different these days.

People {*don't believe* / **haven't believed*} in ghosts nowadays.

IV. More on the indefinite reading of the perfect

5.10 Further remarks on the indefinite reading

5.10.1 A present perfect receives an indefinite W-interpretation if the sentence is taken to express that (or to ask whether) a particular situation has or has not actualized at some indefinite time in a period leading up to (but not including) t_0 . The actualization, if any, is considered to be over before t_0 . (Otherwise the situation would not be located at an indefinite time, for both t_0 itself and a point adjacent to it are definite times.) Such a sentence thus says either that there have been no actualizations at all or that there have been one or more actualizations, none of which includes the terminal point of the pre-present (i. e. the point immediately preceding t_0):

[I don't know whether John is here.] I haven't seen him yet.

[I'm sure] I've met that man before.

I have already fallen out with him.

[I know he's in London because] I've run across him a couple of times.

The observation that the situation time cannot reach up to the terminal point of the pre-present is in keeping with the observation (made in 5.4.1) that, on an indefinite perfect interpretation, the time of the predicated situation is by definition indefinite:⁹ if a situation time reaches up to the terminal point of the pre-present, it is automatically definite because it includes a time (viz. the terminal point of the pre-present) which is treated as definite by virtue of being adjacent to t_0 . The latter is the definite time *par excellence* (since it is by definition 'given').

This is not to say that on an indefinite reading the distance between the situation time and t_0 cannot be very small. Adverbials like *just* or *until recently* locate the situation time very close to t_0 , but at a time which is treated as sufficiently separated from t_0 to count as an unanchored (indefinite) time. The idea of separation is especially clear when a present perfect sentence with *just* is used to express a contrast with what is the state of affairs at t_0 :

["Is John in here?] – "No, he isn't, but he's just *been* here."

5.10.2 As is clear from the examples in the previous subsection, an indefinite interpretation is due to the interplay of various factors: the semantic meaning of the present perfect (= 'The pre-present contains the situation time'), the kind of situation referred to (e. g. a punctual situation cannot be continuative)

9. In fact, the term 'indefinite reading' of the present perfect is a reflection of this phenomenon.

and the absence of elements evoking a continuative interpretation (such as an adverbial like *for three days now*, which represents the factual full situation as including t_0) or evoking an up-to-now reading. The indefinite interpretation can also be imposed by the presence of certain adverbials denoting a pre-present Adv-time that explicitly excludes t_0 (e.g. *just, this minute, ever, before, in the past*), as illustrated by the following examples:

Have you ever been to Nicaragua? (*Here the pre-present is conceived of as being the hearer's lifetime up to t_0 .*)

I don't believe I've heard about it before.

I've just received a threatening letter.

Nothing much has been done about it in the past.

There are further factors that can trigger an indefinite interpretation – see below.

5.11 The indefinite reading and temporal adverbials

5.11.1 The term 'indefinite' perfect reflects the fact that a present perfect clause can only receive the indefinite reading if it does not contain a time-specifying adverbial specifying a definite time and if it is not couched in a context referring to such a time.¹⁰ An indefinite interpretation of the present perfect is only possible when the precise temporal location of the situation time of the bygone situation remains indefinite. The moment this location is specified, the past tense has to be used. Compare:

This morning I {got up / *have got up} at three a.m. (*At three a.m. is related to a particular identifiable day, and is therefore a definite Adv-time.*)

["I got up at three this morning. You've never done that in your life." – "You're mistaken."] I HAVE got up at 3 a.m. [Several times.]

In the former example *at three a.m.* indicates a definite past time at which the situation time of the situation expressed by *I got up* is located. In the second example, *at three a.m.* forms part of the description of the situation: the sequence '*I HAVE got up at 3 a.m. Several times.*' expresses that the situation time of the situation of my getting up at three a.m. has actualized on several (temporally unspecified, i.e. indefinite) occasions in the pre-present. In this case *at three a.m.* does not establish an Adv-time containing the situation time but forms part of the description of the situation whose situation time is located at some indefinite time in the pre-present.

10. In the linguistic literature, the term 'existential perfect' is sometimes used in the sense of 'indefinite' perfect. It is inspired by the idea that this kind of perfect expresses that an actualization has or has not 'existed' in a period leading up to now.

The following pair of examples also illustrates the rule that (on an indefinite interpretation) the time of actualization of the situation is never specified or otherwise identifiable:

I have helped him with his papers. (*indefinite reading*)

I have helped him with his papers for two years. (*continuative or indefinite*)

The indefinite interpretation of the second example is ‘Somewhere in a period leading up to now there has been a two-year period when I helped him with his papers, but that period is over now.’ This interpretation only arises in particular contexts, e.g. when the sentence is used in reply to *Have you ever helped him with his papers for two years?*, meaning ‘Have you ever done a two-year stint of helping him with his papers?’ or ‘Do you have experience of a two-year-helping-him-with-his-papers situation?’. If the sentence is used in this context, *for two years* forms part of the description of the situation itself: ‘The situation of my helping him with his papers for two years has actualized at some indefinite time in the pre-present’. The duration adverbial here does not just limit a situation in time but is part of the characterization of the situation referred to. That is ‘help him with his papers for two years’ is what the speaker is saying he has done. In this respect, *for two years* is syntactically similar to *at three a.m.* in *I HAVE got up at 3 a.m.* in the second example of the previous pair of examples.

The observation that an indefinite perfect use is ruled out by a definite Adv-time indicating a bygone time is further illustrated by the following:

Have you ever helped him with his papers? (*ever* ⇒ ‘at any time in your life’; we cannot add a definite past time adverbial like *yesterday*)

I {helped / *have helped} him with his papers until two years ago. (*By specifying the exact location of the end of the Adv-time, until two years ago indicates a bygone period whose temporal location is definite because it is anchored to t₀.*)

5.11.2 This does not mean, however, that (apart from the cases mentioned in the preceding section) an indefinite perfect can never co-occur with a temporal adverbial. For obvious reasons it can co-occur with adverbials which just denote a period leading up to now or denote an indefinite time in a period leading up to now, without saying anything about the precise location of the situation time in that period. Adverbials like *before*, *in the past*, *in the last year*, *latterly*, *of late*, etc., can be used in this way:

[Don’t worry.] I have dealt with problems of this kind before.

This has often happened in the past.

Have you had an accident in the last year? (= *in the 12 months leading up to t₀*)

Latterly, the firm has had difficulties because of the recession.

Moreover, the present perfect can co-occur with the adverbials *recently*, *lately*, *just* and *this minute*, particularly in British English.

This telegram has just arrived.

I have this minute heard that the deal is off.

I have recently met him.

The company has been sold just lately to an engineering firm.

In this connection, the following remarks are in order:

- (a) *Just* and *this minute* cannot be used in sentences made negative by *not*, except if the *not* expresses ‘METALINGUISTIC’ (external, contradictive) **NEGATION** (i. e. when the sentence is used to reject a statement to the contrary), or when the *not* only negates *just*:

John has just arrived.

[“John has just arrived.”] – “John has NOT just arrived. [He’s been here for hours.] (*metalinguistic negation*)

[“John has just arrived.”] – “John hasn’t ‘just arrived’. [He’s been here for hours.] (*metalinguistic negation*)

John hasn’t just arrived. (*can only be interpreted as in the preceding example*)

John hasn’t JUST arrived. [He arrived a long time ago.] (*The negation has narrow scope: it only negates just.*)

- (b) If *recently* and *lately* are to be interpreted as ‘at some recent time within the pre-present’, they can combine with *not* under the same conditions as apply to *just* and *this minute*. However, they can also be used in unmarked negative sentences if they indicate the pre-present zone as a whole rather than an indefinite time in that zone:

There haven’t been any burglaries here {lately / recently}.

- (c) The four adverbials in question (viz. *just*, *this minute*, *lately* and *recently*) express recency, and might therefore be argued to refer to a time which is definite by virtue of being adjacent to t_0 . However, recency is not the same thing as adjacency. English speakers apparently treat the times indicated by these adverbials as sufficiently cut off from t_0 to count as indefinite times, so that they can combine with an indefinite perfect. This is particularly clear from examples like the following:

[If we consider how many billion years the earth has existed,] man has just appeared on the scene, so to speak.

Moreover, these recent times can also be viewed as quite separated from t_0 , i. e. as past times, so that the adverbials specifying them can also combine with the past tense:

I {have met / met} him {recently / lately}.

I {have just seen / just saw} him leave the house.

I {have only this minute arrived / only this minute arrived} [and Sue already wants to know when I'm leaving!]

5.12 Indefinite readings of negative present perfect sentences

A clause triggering an indefinite perfect interpretation can be used not only to say that (or to question whether) a situation has actualized in a period leading up to now but also to say that it has not actualized in that period. The latter possibility is illustrated by the following:

[I don't know that song.] I've never heard it in my life.

We haven't met {yet / before}, have we?

It is important to see that the interpretation given to such sentences is an indefinite rather than a continuative interpretation. Thus, the correct interpretation of *We haven't read that letter before* is not 'Our not reading of that letter has lasted until now' but 'It has not happened before that we read that letter'. This is in keeping with the fact that the sentence can hardly be made progressive: ??*We haven't been reading that letter before*. As noted in 5.9.3, a continuative reading of a nonstatic sentence normally requires the progressive form (unless the reference is to a repetitive habit). An example of a progressive perfect sentence referring to a single dynamic situation and yielding a continuative reading is *We've been playing cards since 7.45 a.m.*

This is not to say that negative present perfect sentences can never be interpreted as continuative. Under certain conditions (minimally: the negator must not be *never*, and the situation referred to must be a state) they can be:

It's three months now that I haven't had a car. (= 'The situation of my doing without a car started three months ago and is still continuing.')

However, sentences like the following (with a dynamic VP) cannot be interpreted continuatively:

For the last three years I haven't driven a car. (*indefinite reading*: 'The situation of my driving a car hasn't actualized in the last three years')

For a fuller treatment of negative present perfect sentences, see 5.30.3 and 5.30.5.

5.13 The 'experiential perfect' use of the indefinite perfect

5.13.1 One of the typical usage types of the indefinite perfect is the so-called **PERFECT OF EXPERIENCE** (or **EXPERIENTIAL PERFECT**). In this use, the indefinite

present perfect refers to the actualization of one or more W-bygone situations which are not necessarily recent but which are still ‘with us’ as part of our experience and knowledge.¹¹

He has read a lot about their culture.

Have you read Dante’s *Inferno*?

She hasn’t had flu yet this winter.

Have you ever been to Japan?

It should be noted that the category ‘perfect of experience’ (as well as the categories ‘resultative perfect’ – see 5.15 – and ‘hot news perfect’ – see 5.14) does not belong to the same categorial distinction as the categories ‘indefinite reading’, ‘up-to-now reading’ and ‘continuative reading’. While the latter three are a question of different temporal W-interpretations allowed by the present perfect’s temporal T-interpretations (‘situation time located in the pre-present but wholly before t_0 ’ and ‘situation time co-extensive with the pre-present zone’), the ‘experiential’, ‘resultative’ and ‘hot news’ readings are *functional* interpretations which belong to the array of usages compatible with the ‘indefinite’ temporal W-interpretation of the present perfect. It follows that we consider a sentence like *I’ve been to Japan* as ‘experiential’ in the first of the following two examples only:

[I know a bit about Japanese culture.] I’ve been to Japan three times. (*indefinite perfect; the speaker wants to say that a visit to Japan forms part of his present experience.*)

[“How many times have you been to Japan?”] – “I’ve been to Japan three times.” (*up-to-now reading of the ‘quantificational constitution’ kind – see 5.19.1; the purpose of the sentence is not to say that a visit to Japan forms part of the speaker’s present experience.*)

This means that within the indefinite reading and the up-to-now reading (which are temporal W-readings) we can distinguish several functional types. Each of these functional types is a use of a present perfect clause which is meant to convey a particular interpretation (reading). This means that the terms ‘interpretation’ (or ‘W-interpretation’) and ‘reading’ (or W-reading) will be applied not only to the three temporal W-interpretations (W-readings) of the present perfect (viz. ‘indefinite’, ‘up-to-now’ and ‘continuative’), but also to readings produced by a particular functional use. So, the functional use of the indefinite perfect to convey ‘hot news’ (see 5.14) will be said to give rise to

11. The term ‘perfect of experience’ is sometimes used in a wider sense, viz. as a synonym of what we call ‘indefinite perfect’. Even examples of ‘constitution perfects’ are sometimes treated as experiential perfects. We will use the term exclusively in the way it is defined in this section.

a ‘hot news reading’, and we will similarly speak of an ‘experiential reading’ and a ‘resultative reading’ in connection with some uses of the indefinite perfect. In 5.17.2 we will see that the temporal up-to-now reading too is compatible with various functional readings.

5.13.2 *Have gone* cannot be interpreted as a perfect of experience when *go* is understood as a more or less literal verb of motion. We use *have been* instead. Compare:

That man has been to Japan. (= ‘*That man has visited Japan at least once in his life so far.*’) (*This allows various pragmatically determined W-readings, e.g. ‘That man may know something about Japanese culture.’ The sentence anyhow implies that the man has returned.*)

He has gone to Japan. (*The implicated resultative meaning is: ‘He is in Japan or on his way to Japan.’ The sentence implies that he has not returned yet from Japan.*)

5.14 The indefinite perfect used to express ‘hot news’

Because it links a bygone situation to the present (thus expressing ‘current relevance’ – see 5.36), the indefinite perfect is the tense that is used in sentences presenting the bygone actualization of a situation as news. This means that the indefinite present perfect can have a function similar to that of an indefinite NP: as is well-known, we use indefinite NPs to introduce referents into the discourse, because definite NPs usually presuppose an already existing familiarity with their referents (or at least with their existence – see the ‘*attributive*’ use of definite NPs pointed out by Donnellan (1966)).¹²

An American oil tanker *has been attacked* by an Iraqi fighter in the Gulf of Oman.

Robert *has failed* his exam. [He’s feeling depressed.]

[I’m glad to inform you that] the referees *have advised* me to accept your manuscript for publication.

One of the puppies that were born this morning *has died*.

In such examples the situation lying before the terminal point of the pre-present and reported as ‘hot news’ is naturally a recent situation.

Needless to say, the reason why an indefinite perfect can be used to express ‘hot news’ is the implication of current relevance which forms an essential part of the interpretation of clauses in the present perfect – see section 5.35 below.

12. A definite NP is used in an ‘attributive’ way if the hearer is assumed to be familiar with the existence of the referent of the NP, but without being able to identify (e.g. pick out from a set) the referent in question. Thus, if the speaker assumes that the addressee knows that a murder has been committed, he can speak of *the murderer* even if he knows that the identity of the murderer is still unknown to the hearer (and possibly to himself too).

5.15 The resultative reading of the indefinite present perfect

5.15.1 The **RESULTATIVE READING** of the indefinite present perfect is again a functional reading: a clause with an indefinite present perfect can be used to draw attention to a present ‘direct result’.

I’ve locked up the shop. (*resultative reading: ‘The shop is locked up.’*)

As explained in 5.37, a **DIRECT RESULT** is the resultant state that inevitably comes about when a situation is completed. For example, the completion of the action of locking up a shop automatically (and immediately) produces the state of the shop being locked up. (This need not be a lasting result, but it is there immediately after the locking up.)

5.15.2 Only present perfect sentences that receive an indefinite reading can implicate a present direct result, and even then the ‘experiential use’ of the indefinite perfect (see 5.13.1) forms an exception. Thus, none of the following examples implicates the persistence of a *direct result*:

Have you ever been to Greece? (*indefinite reading of the experiential usage type*)

I’ve been standing here for the last ten minutes. (*continuative reading*)

[“What have you been doing?”] – “I’ve been digging the flower beds.” (*nonquantificational constitution reading; note that, out of context, I’ve dug the flower beds would be interpreted as nonexperiential indefinite and hence as referring to a direct result.*)

Four years have passed since then. (*duration-quantifying constitution reading*)

So far I’ve had three jobs [and none of them lasted a month]. (*number-quantifying constitution reading*)

5.15.3 In sum, a present perfect sentence yielding a (non-experiential) indefinite reading implicates the persistence of the direct result. This entails that such a sentence can be used as an indirect way of conveying a message about the present.

A letter has arrived for you. (*message: ‘There is a letter for you.’*)

He has learnt to swim. (*message: ‘He can swim.’*)

They’ve cut off the electricity. (*message: ‘We don’t have any electricity.’*)

I’ve been to the hairdresser’s. (*message: ‘My hair is done.’*)

I’ve finished my poem. (*message: ‘My poem is finished.’*)

She’s been bitten by a snake. (*This implicates that the injury is current, i.e. that it is not healed yet.*) (*Compare with She was bitten by a snake, which implicates that the injury is healed or in some other way no longer exists – perhaps she is dead – or that even if the injury is not healed it is no longer causing trouble.*)

5.16 The ‘recency reading’ of the indefinite present perfect

5.16.1 In the ‘hot news’ use (see 5.14) of the indefinite perfect the situation time is always represented as lying close to t_0 . The reading produced by the ‘hot news’ use of the indefinite present perfect is therefore automatically a **RECENCY READING**. A recency reading can also arise in some cases where the indefinite perfect does not have the function of conveying hot news. For example, an indefinite perfect reading is also a recency reading if the present perfect combines with an adverb like *just*, *recently* or *this minute*, which establishes a recent indefinite bygone Adv-time. For example:

I’ve just met John in the street.

I have this minute heard that the deal is off.

This kind of present perfect sentence is rather special because of the nature of the adverbial. Adverbs like *just* refer to an Adv-time which would seem to be anchored to t_0 by virtue of lying ‘just before t_0 ’. This means that the time of the situation (‘contained’ by the Adv-time – see 2.23.1) would seem to be ‘semi-definite’ rather than indefinite. The important thing, however, is that the time is not definite, because it is impossible to say what time exactly is specified by *just*, *recently* or *this minute*: all that we know is that there is only a short interval of time between the Adv-time and t_0 . However, the interpretation of ‘short’ is largely pragmatic, and may differ considerably in different contexts. Compare:

He’s crying because he’s just *fallen* off the swing.

[You can’t expect her to look happy.] She’s still grieving over her husband who’s just *died*. (*Her husband may have died several months ago.*)

[If we consider the time that has elapsed since the earth was formed,] man *has* only just *come* into being.

Because of this semi-definite meaning, *just* can collocate either with an indefinite perfect (especially in British English) or with the past tense (especially in American English). By convention, *just now*, which has a similar ‘recent indefinite past’ meaning combines with the past tense only (except when it means ‘only just’ – see 12.17.6).

If *just* combines with the present perfect, the resulting temporal interpretation is always an indefinite one. From a functional point of view, such a sentence (e.g. *I’ve just seen Sharon*) can be used to express ‘hot news’ (see 5.14) or a present result (see 5.27), but not to convey an ‘experiential reading’ (see 5.13). This means that an indefinite perfect combining with *just* always receives a ‘recency reading’ (since, unlike the experiential reading, the hot news reading and the present result reading are recency readings).

5.16.2 The fact that the indefinite present perfect has a recency use is not surprising, given that the location of the bygone situation time in the present time-sphere emphasizes that the speaker, in talking about the situation, is concerned with NOW, and given that (perhaps because of this) the default temporal location of a present perfect situation is the most recent one that makes sense in the context in question. In Br. E., the recency use of the indefinite perfect is normally signalled by an adverbial such as *just* or *recently*, or by a context which invokes a special ‘hot news’ use interpretation, such as *Run! The river has burst its banks*. In American English and increasingly in British English, the past tense can be used for a very similar recency meaning: *Did you wash your hands?* (In both Am. E. and Br. E., *just* and *recently* may occur with either the past tense or the present perfect, with little or no difference in meaning. This is probably because these recency adverbs are both semi-definite, in that the time that they indicate closely precedes t_0 and semi-indefinite, in that the time is nevertheless not precisely identifiable. It is possible that in Am. E. a similar duality applies when a recent situation is referred to in the absence of these adverbials, so that the past tense is possible for any situation whose proximity to speech time is evident, as in *Did you wash your hands?*).

5.16.3 As we will see in 5.25.5, a recency reading of the indefinite perfect easily allows the verb form to be progressive, except if the recency reading in question is a hot news reading, in which case the progressive cannot be used at all. Compare:

Who's the man you have just {*spoken* / *been speaking*} to? (*recency reading which is not a hot news reading*)

[Have you heard?] An American oil tanker has {*sunk* / **been sinking*} in the Suez Canal. (*hot news reading*)

I've never {*read* / **been reading*} a financial newspaper (in my life). (*experiential reading; an experiential reading is never a recency reading — see 5.16.1*)

V. More on the up-to-now reading of the perfect

In this section we go into a number of characteristics of the use of the present perfect conveying an up-to-now reading:

- (a) There are two types of up-to-now interpretation, viz. the ‘unmarked up-to-now reading’ and the ‘constitution reading’. The latter may be of two kinds, viz. the ‘nonquantificational’ kind and the ‘quantificational’ one (which is either ‘duration-specifying’ or ‘number-specifying’) – see 5.17–9.
- (b) One of the functions of a present perfect situation with an unmarked up-to-now reading is to convey an ‘explanatory-resultative’ message – see 5.18.3.
- (c) Sentences with a constitution reading typically have a ‘specificational’ function – see 5.20.
- (d) There is a hybrid type of present perfect sentence, which receives an interpretation that is a combination of a constitution reading and a continuative reading – see 5.21.3.

5.17 Functional types of up-to-now reading

5.17.1 The temporal differences between this W-reading and the other two (viz. the continuative and indefinite interpretations) have been explained in 5.4.1 and 5.4.5, where the temporal characteristics of the three readings were summarized in Figure 5.5 (repeated here).

	indefinite reading	continuative reading	up-to-now reading
The situation time is conceived of as ‘up to now’, i.e. as including the terminal point of the pre-present (which is adjacent to t_0)	–	+	+
The time of the full situation coincides with the situation time	+ in possibility (a) in 5.3.2 ± in possibility (d) in 5.3.2	–	+
The time of the full situation includes t_0	–	+	–
The time of the full situation is definite	–	+	+ see note (a) below
The full situation is interpreted as bounded	+ in possibility (a) in 5.3.2 ± in possibility (d) in 5.3.2	– / (±) see note (b) below	+

Figure 5.5. The features of the W-interpretations of the present perfect.

5.17.2 Sentences receiving the up-to-now reading may serve various functions. This means that within the up-to-now reading (which is a temporal W-reading) we can distinguish several functional types. Each of these functional types represents a use of a present perfect clause which is meant to convey a particular interpretation (reading). This means that the terms ‘interpretation’ (or ‘W-interpretation’) and ‘reading’ (or W-reading’) will not only be applied to the three temporal W-interpretations (W-readings) of the present perfect (viz. ‘indefinite’, ‘up-to-now’ and ‘continuative’), but also to readings produced by a particular functional use.

Within the up-to-now reading, we first of all distinguish between the ‘unmarked up-to-now reading’ and the ‘constitution reading’. Within the latter, we can distinguish further between a ‘nonquantificational constitution reading’ and a ‘quantificational constitution reading’. A quantificational constitution reading can be either ‘duration-specifying’ or ‘number-specifying’. In the following sections these various categories and subcategories of readings will be defined and examined.

5.18 The unmarked up-to-now reading

This functional version of the up-to-now reading is not concerned with the temporal or situational constitution of the pre-present. In this respect it differs from the functional version which we call the ‘constitution reading’ – see 5.19. In [*At last you're here!*] *I've been trying to get in touch with you for days*, the second sentence receives an unmarked up-to-now reading, i.e. the situation referred to has lasted until right before the moment of speech.

Sentences which receive an unmarked up-to-now reading are often used with an ‘explanatory-resultative’ function. This means that they explain the bygone origin of a present result. For example: [*Sorry I'm dirty.*] *I've been cleaning the cellar.*

5.18.1 The **UNMARKED UP-TO-NOW READING** can be defined negatively as being the up-to-now reading which is not concerned with the temporal or situational constitution of the pre-present. The latter kind of up-to-now reading is the ‘*constitution reading*’. As will be shown in 5.19, it is typical of a constitution reading that the clause in the present perfect is concerned with how a pre-present period (i.e. a period leading up to t_0 but not including t_0) is constituted or filled ‘situationwise’. This means that the speaker is concerned either with characterizing or accounting for the entire relevant pre-present period (e.g. *I've been telling her for years that I would never leave her*) or with ‘measuring’

that period, either by using a clause whose situation indicates its duration (e. g. *Five years have elapsed since then*) or by counting the number of times that the same situation (or kind of situation) has actualized within that period (e. g. *I've seen her three times so far*). We will refer to the non-measuring reading as the 'nonquantificational constitution reading' and to the two measuring readings as 'quantificational constitution readings'. What they have in common is that the speaker is concerned with how the pre-present is constituted in terms of one or more situations.

In the unmarked up-to-now reading the speaker is not concerned with the constitution of the period leading up to now but merely represents a situation as actualizing throughout this period. As shown in Figure 5.5, this means that (a) the situation time is conceived of as 'up to now', i. e. as including the terminal point of the pre-present (which is adjacent to t_0), (b) the time of the full situation coincides with the situation time, (c) the time of the full situation does not include t_0 , (d) the time of the full situation is definite (because it is adjacent to t_0), and (e) the full situation is bounded (nonhomogeneous).

5.18.2 In the following examples the relevant clause in the present perfect receives (or can receive) such an unmarked up-to-now reading:

Since I left for school I've been telling my mom that I would show her how to use the computer and send e-mail, so she could keep in touch with me. (www) (*Both a continuative reading and an unmarked up-to-now reading make sense: the repetitive hypersituation of telling may or may not be still continuing at t_0 .*)

And for years I've been telling people that someday noise would be assimilated into mainstream pop music, and it's already starting to happen. (www) (*similar*) (*said by someone coming in from the garden*) [I'm going to wash my hands.] I've been working in the garden.

[Representative Jo Ann Emerson recently announced Dec. 13 as the day traffic is anticipated to cross the new Bill Emerson Memorial Bridge. "We couldn't be more excited about this," said MoDOT District Engineer Scott Meyer.] "We've been telling the public the bridge would be opened by the end of the year [and we are very pleased to finally have an anticipated date for the bridge completion]." (www)

(*The speaker suddenly interrupts his story and says:*) You've been thinking of something else all the time I've been talking to you.

[At last you're here!] I've been trying to get in touch with you for days.

Are you the idiot who has been blowing his horn for the last ten minutes?

(*uttered during the examination*) The boys have been preparing for this examination for the last fortnight.

(*George Bush Jr. speaking about the CIA-boss who has just resigned*) He has been a very good and diligent boss of the agency. (www)

5.18.3 Sentences which receive an unmarked up-to-now reading are often used with an **EXPLANATORY-RESULTATIVE** function. (As we will see below, sen-

tences with a nonquantificational constitution reading can also have this function.) For example:

[Sorry I'm dirty.] *I've been cleaning* the cellar.

Such sentences explain the origin of a present result. The result in question is not a 'direct result' (see 5.37.1) which follows from the completion of the telic situation of cleaning the cellar. This direct present result (= the cellar is clean now) can only be suggested by *I've cleaned the cellar*, which receives an indefinite interpretation. If the progressive is used, which is seldom possible on an indefinite reading (see 5.25) but obligatory (with dynamic verbs) on an unmarked up-to-now reading, the implicated present result is one which does not presuppose completion of the situation but which comes into being while the pre-present situation is unfolding. Thus, *I've been cleaning the cellar* does not convey the message 'The cellar is clean now' (though it implies approachment to that direct result, i. e. the cellar is cleaner now than it was) but is used to explain an indirect result, e. g. why my hands are dirty, or why I am feeling cold, etc. That is, the reference is to a situation that has recently actualized and has produced an indirect result which is still apparent at t_0 . The indirect result in question does not follow from the completion of the situation, but is produced by the pre-present situation while it is in progress. (This explains why the perfect has to be progressive in this use – see also 5.26.2.) In most cases the indirect result is an unintended side-effect.

This use of the up-to-now perfect is called *explanatory-resultative* because the sentence in question normally has the discourse function of an explanation or excuse, or of a reproach in which the speaker gives his own interpretation (explanation) of what has happened. The following are further examples of this use. (The indirect result indicated within brackets is not necessarily the only one possible.)

It's been snowing! (= Look, the road is covered with snow.)

You've been working too fast. (That's why the result is not good.)

I've been waiting for Jack. (That's why I am late.)

You've been drinking again! (reproach: 'You're drunk again!')

["You look tired."] – "Yes, I've been working too hard lately." (explaining)

5.18.4 When it is a *wh*-question or provides an answer to a *wh*-question, a sentence with an explanatory-resultative function belongs to the 'nonquantificational constitution' type rather than the 'unmarked up-to-now' type. This is because *wh*-questions always have a 'specificational' function: the *wh*-word represents a variable for which a value should be specified. As will be pointed out in 5.20, a constitution reading is automatically a specificational up-to-now reading, as in the following examples:

What *have* you *been using* this knife for? [It's got blunt and rusty.]

“Why *have* you *been in* the kitchen so long?” – “[The dishes were dirty.] I *have been washing* them up.”

Who's *been watering* the plants? [There's water spilt on the floor.]

“Why *have* you *been crying*?” – “I *haven't been crying*. I've *been cutting* onions.”
(All three sentences have an explanatory-resultative function.)

There are also present perfect sentences with an explanatory-resultative function which respond to an anticipated request to account for a period up to now:

(*said by someone passing Tom while he is sitting on a chair in his front garden*)
[“Hello Tom. How are you?” – “I'm exhausted.] I've *been raking* leaves for three hours.”

Here the speaker (= Tom) sets up a ‘need to account’ by asserting that he is exhausted, and then gives the reason for the exhaustion. In doing so he sets up an implicit period leading up to now in which the cause for the exhaustion has come about and then locates the causal situation in it.

5.19 The constitution readings

An up-to-now interpretation of a present perfect clause is a ‘constitution reading’ if the speaker is taken to be concerned with one of the following three questions: (a) ‘How much time has elapsed between a bygone time and t_0 ?’ (e.g. *Two weeks have gone by since then*); (b) ‘How many actualizations have there been in the period up to now?’ (e.g. *Meg has washed the elephants three times this week*); (c) ‘How has the pre-present been filled “situationwise”?’ (e.g. [Oh, you're back at last!] *What have you been doing?*).

Readings (a) and (b) are ‘quantificational constitution readings’: they are ‘duration-quantifying’ and ‘number-quantifying’, respectively. Reading (c) is the ‘nonquantificational constitution reading’.

5.19.1 An up-to-now reading is a **CONSTITUTION READING** if the speaker is taken to be concerned with one of the following questions:

- (a) ‘How much time has elapsed between a bygone time and t_0 ?. This question is answered by using the present perfect of a sentence whose situation is ‘duration-specifying’:

Three years have gone by since that accident [and I still haven't seen a penny!]

In such sentences the situation is **DURATION-QUANTIFYING**, i.e. the situation referred to in the sentence is the specification of the duration of the interval

separating two times. (In this case the times in question are the time of the accident, which is also the beginning of the conceptualized pre-present zone, and t_0 .)

(b) ‘How many actualizations have there been in the period up to now?’

You are the third colleague who has asked me this question today. (*The speaker is concerned with the situational constitution of the pre-present, more specifically with the question how many times a particular kind of situation has actualized in it.*)

In such sentences the situation is **NUMBER-QUANTIFYING**.

(c) ‘How has the pre-present been filled ‘situationwise’?’

[Oh, you’re back at last!] What have you been doing? (*The speaker wants to know what action(s) of the addressee has/have filled the pre-present. This action or these actions is or are viewed as leading up to t_0 but without continuing at t_0 .*)

[Ah, there you are!] Where have you been? (*The question concerns the addressee’s whereabouts during the complete pre-present period that the speaker has in mind, but the state of the addressee being somewhere else is not viewed as continuing at t_0 .*)

[Jim appears to be suffering from culture shock because he’s just come home from Africa.] He has been travelling through Ethiopia, Sudan and Chad. (*The speaker is concerned with the nature of the situations constituting the pre-present trip which has led to Jim’s present suffering from culture shock. Since the pre-present zone is conceived of as the time of the trip, the speaker can be said to be concerned with the situational constitution of the pre-present zone.*)

In each of these three cases (a)–(c), the speaker ‘looks back on’ the pre-present (from his own temporal standpoint, i.e. t_0) and evaluates it. This evaluation may be a measuring of the pre-present by indicating either its length or the number of subsituations making up the (hyper)situation that coincides with the pre-present. It may also be a specification of the nature of the situation(s) that has/have filled the pre-present. In all three cases the speaker is concerned with the situational constitution of the pre-present zone. We will therefore refer to a reading of one of these kinds as a **CONSTITUTION READING**. This sort of reading is a kind of up-to-now reading. This means that it differs from the indefinite and the continuative readings in that the time of the full situation fills the entire pre-present but does not include t_0 . (As is typical of up-to-now readings – see Figure 5.5 – a constitution reading is always a bounded reading: the (single or repetitive) full situation is taken to come to an end before t_0 , with no relevant time interval between the end of the situation and t_0 .) Since the above readings (a) and (b) have to do with ‘measuring’ the pre-present situation (and the pre-present period with which it coincides), we will call these readings **QUANTIFICATIONAL CONSTITUTION READINGS**. Reading (c) will be referred to as the **NON-**

QUANTIFICATIONAL CONSTITUTION READING. As will be explained in 5.20.1, the latter reading differs from the unmarked up-to-now reading in that it is ‘specificational’.

5.19.2 The following examples further illustrate the **NONQUANTIFICATIONAL** subtype:

“[Oh, there you are.] What *have you been doing?*” – “*I’ve been putting* the children to bed.” (*Both the question and the answer concern the nature of speaker B’s action(s) during the pre-present period when he was absent.*)

“[Oh, there you are.] Where *have you been?*” – “*I’ve been* in the attic. [It needed cleaning.]” (*similar*)

(*uttered at a school reunion*) “What *have you been doing* for the last twenty years?” – “*I’ve been raising* three children and *establishing* a multinational corporation.”

[“After years of hard soil (...) my front lawn has become very soft. (...) Is it possible that critters like say red ants has [sic] colonized my yard and loosened up the ground soil in the process?”] – “Aside from the ants what *have you been doing* to that soil that might make it that way? If you *have been adding* organic matter over the years that may help explain what is going on.” (www)

In each of these examples, the questions form a request to account for a pre-present period. The perfect forms in both the questions and the replies refer to situations which, possibly in combination with other situations, have ‘filled’ the relevant period.

5.19.3 The **QUANTIFICATIONAL** uses of a present perfect yielding a constitution reading are illustrated by the following:

Nearly four years *have elapsed* since his accident. (*duration-quantifying*)

“How many times *have you met* him?” – “So far *I’ve met* him {once / three times}. (*number-quantifying*)

“How many times *have you met* him?” – “So far I {*have never met* him / *haven’t met* him} at all.” (*number-quantifying; the number is zero*)

That is the first word he *has said* to me today. (*number-quantifying*)

You’re the third student who’s *fallen* asleep in the library this week. (*number-quantifying*)

“How many students *have fallen* asleep in the library this week?” – “THREE students *have fallen* asleep in the library this week.” (*number-quantifying*)

There are a couple of things to be noted here. First, as is clear from the second and third examples, the number of times that a situation has actualized in the relevant period leading up to now may be zero, one or more. Secondly, the claim that the constitution reading (which is one of the functional readings compatible with the temporal up-to-now W-interpretation) and the indefinite

W-interpretation are context-dependent interpretations (like the continuative W-interpretation) is corroborated by the fact that the same sentence can receive different (temporal or functional) interpretations in different contexts:

[“Have you ever *met* John?”] – “So far {I’ve never *met* him / I haven’t *met* him}.”
(*indefinite interpretation*)

[“How many times *have* you *met* John?”] – “So far I {I’ve never *met* him / I haven’t *met* him} at all.” (*quantificational constitution reading*)

In the former example, speaker A is only concerned with the question whether or not the situation of speaker B’s meeting John has actualized at some time(s) in an implicit pre-present period. B’s answer is ‘no’. In the second example, speaker A *presupposes* that B has met John in the pre-present and asks him how many times this has happened. Speaker B’s reply is that scanning the pre-present does not reveal a single instance of such an encounter, which implies that speaker A is wrong to presuppose that at least one such encounter has taken place.

5.19.4 All constitution readings share the characteristic that the situation filling the pre-present may consist of a number of **SUBSITUATIONS** forming one **HYPER-SITUATION**:

[“What have you been up to since I last saw you?”] – “Quite a lot.] I’ve been raising three adopted children and *running* a small company. And I’ve had holidays in Italy, Greece and Sweden. And, most of all, I’ve been *looking* after my husband, [who would be totally lost without me.]” (*nonquantificational constitution reading; what situationally constitutes the pre-present is actually a set of subsituations.*)

Three years have passed since the child went missing, [and the police haven’t found out anything at all.] (*duration-quantifying constitution reading: we can say that Three years have passed refers to a hypersituation consisting of three subsituations of one year passing. The speaker treats the three years as ‘one period’, viz. the length of the hypersituation, rather than as three individual years.*)

[“How many books has she written?”] – “So far she’s written four.” (*number-quantifying constitution reading*)

Of course, the hypersituation may contain gaps between the subsituations, but these gaps are considered negligible. (In this respect, pre-present hypersituations are like habits: *I always go to school on foot* does not imply that the speaker is actually walking at t_0 .) Moreover, we can speak of a ‘hypersituation’ the moment there is at least one subsituation and one gap. Let us illustrate this with the sentence *I have published only one article so far*. This sentence (which receives a number-quantifying reading) refers to a hypersituation because not only the actualization of the one situation referred to but also the nonactualization of other (potential) subsituations is taken into account. This is because this number-quantifying constitution reading is paraphrasable as ‘There are n

subsituations in the pre-present', which allows the hypersituation to involve gaps in between the actualizations of the subsituations or to consist of only one subsituation surrounded by gaps or even of one gap and zero subsituations (as in [*How often have you met him since then?*] – *I haven't met him at all since then.*). In other words, what determines this kind of constitution reading is that the speaker expresses the result of scanning the entire pre-present for situations actualizing within that period. Whether the result of counting the number of actualizations is zero, one or more is irrelevant: in all cases, the hypersituation that is 'measured' fills the entire pre-present period (indicated by *so far* or *since then* in the above examples). The same is true if the measured hypersituation is expressed in a 'duration-quantifying' form, as in *Six weeks have passed since then* or *Only a week has passed since the accident* or *Not even a week has passed since his funeral [and his relatives are already quarrelling over the heritage]*. The only difference is that in this case the hypersituation does not include any gaps.

It should be noted that this analysis does not imply that speakers perceive sentences like *Only a week has passed since the accident, I've written only one article since then* or *I've been running a small company* as referring to a hypersituation. Ordinary language users do not take irrelevant gaps into account and do not treat single situations as potentially repetitive. However, on the level of linguistic analysis, we sometimes need to acknowledge the existence of gaps, so that there is nothing wrong with speaking of a hypersituation even if there is only one subsituation, as long as there is the theoretical possibility of the hypersituation involving several subsituations and gaps. (This does not alter the fact that the unmarked interpretation of 'hypersituation' is 'repetitive (or otherwise complex) situation consisting of several subsituations'. In what follows we will therefore avoid speaking of 'hypersituation' if there is only one situation or no situation at all, except when the term is really indispensable for constructing a particular argument.)

5.20 The specificational function of the constitution reading

Any type of constitution reading of a present perfect clause is a 'specificational' reading, i. e. the speaker specifies a value for a presupposed variable.

5.20.1 Let us begin by defining the term **SPECIFICATIONAL SENTENCE**. A declarative sentence is specificational if it specifies a 'VALUE' for a presupposed 'VARIABLE' (= 'an x '). This is similar to the solution of an equation in algebra: given that ' $4x = 24$ ', you can work out that the value satisfying the variable x is 6.

Similarly, in the pseudo-cleft *What I gave him was a BOOK*, there is a (presupposed) variable ('the x that I gave him') and the sentence specifies the value 'a book' for this variable. The same happens in the cleft sentence *It was a BOOK that I gave him* and in the inverted pseudo-cleft *A BOOK was what I gave him*, as well as in *I gave him a BOOK* (with contrastive focus on *book*). The value is the 'focus' of the declarative specificational sentence. It contrasts with all the potential values which are not said to satisfy the variable.

A *wh*-question is automatically specificational because it asks the addressee to specify a value for a variable: *What did you give him?* The 'x' of the variable is represented by the question word. The sentence *What did you give him?* presupposes the existence of 'an x that you gave him' and asks for the specification of a value for this variable: its logical form is 'x = ?' (or, more explicitly, 'The x that you gave him = ?'). The variable is the 'focus' of the specificational question. It needs stressing that only *wh*-questions are inherently specificational. *Yes/no*-questions like *Has he arrived yet?* do not ask for the specification of a presupposed variable.¹³

A sentence that does not have a specificational function is referred to as '**PREDICATIONAL**', i. e. it merely says (or asks) something about the referent of the constituent functioning as topic (theme) of the sentence. An example of this is *John has already read this book*, provided there is no contrastive (= extra heavy) accent on one of the constituents. A contrastive accent is typical of a specificational reading.

5.20.2 The distinction between specificational and predicational sentences is a functional distinction. Most sentence types allow either interpretation. Thus, any affirmative sentence or *yes/no*-question can in principle be read specificationally or predicationally, depending on whether it contains a contrastive accent or not. Compare the following sentences:

John has always known about their affair. (*predicational sentence receiving a continuative perfect reading*)

It is JOHN who has always known about their affair. (*specificational sentence with a continuative reading of has known in the variable 'the x who has always known about their affair'*)

JOHN has always known about their affair. (*same interpretation: specificational sentence with a continuative reading of has known in the variable 'the x who has always known about their affair'*)

13. *Yes/no*-questions can also be specificational, viz. when they concern the truth of a specificational statement. In a *yes/no*-question like *Was it a book that you gave him?* the speaker asks if it is true that a particular value (in this case: a book) satisfies the presupposed variable (in this case: 'the x that you gave him').

Similarly, compare the following:

Have you written a letter to him? (*predicational sentence receiving an indefinite perfect reading*)

Have YOU written a letter to him? (*specificational sentence with an indefinite perfect reading of has written in the variable 'the x who has written a letter to him'*)

Wh-questions, by contrast, are always specificational because the question word represents a variable for which a value should be specified. Because they are specificational, *wh*-questions in the present perfect naturally receive a constitution reading, even though the clause representing the presupposition (which is typical of specificational sentences) can yield a continuative or indefinite interpretation:

Since when has he been living here? (*The presupposition 'He has been living here (for some time)' yields a continuative reading, but the specificational sentence as a whole asks for duration-quantifying information and therefore receives a quantificational constitution reading. A suitable reply will specify the duration of the situation up to t_0 .*)

What has happened to you? (*The presupposition 'Something has happened to you' yields an indefinite reading, but the specificational sentence as a whole asks for specification of the nature of the relevant situation(s) in the pre-present and is therefore given a nonquantificational constitution reading.*)

5.20.3 A sentence providing an answer to a (covert or overt) *wh*-question is also specificational, so that, if the present perfect is used, its only possible interpretation is the constitution reading. This is illustrated by the following examples:

"[Ah, there you are. Where have you been?]" – "I've been in the shed." (= 'The *x* where I have been is: (in) the shed'.)

"[Well well. I see you're back at last. Where have you been (until now)?]" – "I've been talking to the neighbours." (*The question Where have you been (until now)? carries the presupposition 'You have been somewhere', which creates the variable 'the *x* where you have been'; this implicitly evokes the variable 'the *x* that you have been doing (while you were there)' and it is for this variable that the reply sentence specifies a value: 'The *x* that I have been doing is: talking to the neighbours'.*)

It has been exactly SIX years since he stopped answering my letters. (*The sentence states '[It {is / has been} *x* years since he stopped answering my letters] + [*x* = six]'. There is no clear difference of interpretation between this and 'The number of times he has answered a letter of mine in the last six years is zero', in which 'The number of times ...' represents the variable and the value assigned to it is 'zero'. Both readings are obviously constitution readings.*)

SIX YEARS have elapsed since that accident. (*constitution reading; the presupposition of the specificational sentence is 'there is a time *x* that has elapsed since that accident', while the assertion is '*x* = six years'.*)

5.20.4 The fact that present perfect sentences providing an answer to a (covert or overt) *wh*-question are always specificational and receive a constitution reading does not mean that a present perfect sentence giving quantificational information is automatically specificational and receives a constitution reading. This is clear from the following:

[I know Brazil well because] I *have been* there six times. (*This sentence is predicational and receives an indefinite reading: the speaker is not so much concerned with the exact number of times he's been in Brazil as with the fact that he knows Brazil well as a result of having been there a number of times.*)

["Have you ever been to Brazil?"] – "I've been there **SIX** times. (*This sentence is specificational and receives a quantificational constitution reading: this time the speaker is concerned with the exact number of times he's been in Brazil.*)

The first example shows clearly that quantificational information can be provided in a predicational sentence. In that case there is no presupposed variable for which a value needs to be specified and there is no implication that the quantificational information has been obtained through scanning the pre-present (see 5.19.3, where this is mentioned as a diagnostic). In sum, there is no quantificational constitution reading. The second example, by contrast, shows how an indefinite reading can be overlaid by a constitution reading. In the given context, *I've been there six times* is read something like 'Yes, I have been to Brazil – in fact x times [$x = \text{six}$]. In this paraphrase, the first clause receives an indefinite interpretation and functions as presupposition for the rest of the paraphrase, which can be read as 'the number of times I've been to Brazil is: six', which is a specificational sentence producing a constitution reading.

5.20.5 It is clear from the latter example that the constitution reading can be added to an indefinite reading. The following sentence shows how it can be added to a continuative interpretation:

["For how long has he been living here?"] – "He's been living here for only a **WEEK!**" (*The answer is given a quantificational constitution reading because it specifies the duration of the pre-present. The implicit presupposition 'He has been living here (for some time)' yields a continuative reading.*)

In this example, the reply is read as 'The time that he has been living here is: only a week'. The NP 'the time that he has been living here' presupposes 'he has been living here for x time', which receives a continuative interpretation. Because of the specificational nature of the sentence as a whole, this reading is overlaid by a constitution reading (more specifically, a duration-quantifying interpretation).

5.21 Two-clause specificational sentences combining two readings

There are three types of specificational sentences consisting of two clauses that combine an indefinite or continuative interpretation with a kind of constitution reading. The first type consists of sentences like *It {is / has been} three weeks since he has been around*, which we call ‘*since*-clefts’. The second type is illustrated by *It is only since 1989 that I have been in contact with my cousins in the west*, the third by *This is the first cigarette I have smoked today*. In this section we examine the special features of these three hybrid structures.

There are a couple of specificational constructions consisting of two clauses at least one of which is in the present perfect. The clause representing the presupposition (i. e. introducing the presupposed variable) receives either an indefinite or a continuative reading, while the head clause, which specifies a value for the variable, yields a constitution reading.

5.21.1 One of them is what we can call the **SINCE-CLEFT**, i. e. an *it*-cleft construction whose second clause is introduced by *since* (rather than by *that* or by a *wh*-word, as in *It was John {who / that} did it*). The highlighted (focused) value constituent is always an indication of duration.¹⁴

It’s been three weeks since I *have heard* from him.

It’s been a long time since I’ve had a decent meal.

The head clause, which can also make use of the present tense (*It’s three weeks ...*), is clearly duration-quantifying. The *since*-clause receives an indefinite reading: it is concerned with the question whether a situation has actualized in a period up to now.

It is interesting to note that a condition for the use of the present perfect in the *since*-clause is that the situation referred to is potentially repeatable: the sentence implies both that the situation referred to in the *since*-clause actualized a certain time ago and that it could have actualized again at any time (or at various times) in the pre-present period following its actualization – see the end of this section for a theoretical remark on this condition. Compare:

14. This is also true in similar examples in which *since* is not a conjunction but a preposition, as in *It’s been fifty years since the beginning of the civil rights movement for black people*.

It's five years since I've had an accident. (*This is another way of saying I haven't had an accident for five years, which implies both that I had an accident five years ago and that I might have had one or more accidents since then but have not had any.*)

It's five years since I {had / *have had} that accident. (*With the present perfect this would be another way of saying *I haven't had that (particular) accident for five years, with a similar implication of repeatability: 'I might have had that accident at any time in the period since I had it.' However, this implication is unacceptable because one specific accident cannot happen more than once.*)

It's five years since I {had / *have had} my accident. (*The present perfect is unacceptable because the idea of repeatability which it would express is unacceptable: the sentence would be interpreted as 'I had my accident five years ago and I might have had that accident again at any time since then'. The second part of this reading is unacceptable: I cannot have 'my accident' more than once.*)

Similarly:

It's (been) five years since I've seen him. (*implies 'I haven't seen him for five years'. The situation is 'repeatable' in the sense that it could have actualized (once or several times) in the specified pre-present period.*)

It's (been) five years since I {saw / *have seen} him on the 20th anniversary of his marriage. (*The situation of seeing him on the 20th anniversary of his marriage is not repeatable.*)

It's (been) five years since {I last saw him / *I've last seen him}. (*Last blocks the idea of repeatability.*)

In sum, a *since*-cleft with the present perfect in the *since*-clause is a special specificational construction which can be used to express two readings at once: the speaker specifies the length of the pre-present and at the same time says that a situation has not actualized in that period.

It's (been) a year since we've been in the cellar. (*specifies the length of the relevant period leading up to t_0 and expresses that there has not been an actualization of the since-clause situation in that period.*)

The condition that the *since*-clause of a *since*-cleft can use the indefinite perfect (instead of the past tense) only if the situation referred to is potentially repeatable fits in with other constraints on indefinite perfects, viz. the constraint that blocks the use of the present perfect of verbs of creation whose direct object refers to an effected entity (see 6.34), and the constraint which (on the whole) blocks the indefinite present perfect in clauses referring to dead people (see 5.34):

That cottage {was / *has been} built by my grandfather.

Shakespeare {didn't live / *hasn't lived} in Scotland.

Still, repeatability cannot be an over-all condition for indefinite perfects generally, as the constraint in question does not apply to indefinite perfect clauses

that receive a recency reading, as in [*Have you heard the news?*] *John has died!* (which is an example of a present perfect clause with a ‘hot news’ function – see 5.14).

5.21.2 Apart from *since*-clefts, there are also ordinary *it*-clefts highlighting the duration of the pre-present:

It’s since 1968, not since 1986, that I’ve known Jack. (*The speaker corrects a previous statement that he has known Jack since 1986. The that-clause receives a continuative interpretation.*)

It’s been three weeks now that I haven’t heard from him. (*indefinite reading of the that-clause*)

It’s only three days that he’s been dead [and the heirs are already quarrelling among themselves]. (*continuative reading of the that-clause*)

This type of sentence is a normal *it*-cleft with a durational adverbial as focused constituent. The head clause each time expresses the specificational speech act ‘X is: [indication of period (which is the length of the pre-present zone)]’ in the same way as a constitution perfect does on a duration-quantifying reading. The *that*-clause, which represents the presupposition of the specificational construction, receives either a continuative or an indefinite interpretation. In the first example, the *it*-cleft combines the message ‘I have known Jack since x’ with the assertion ‘x = 1968 (not 1986, as you said just now)’. The corresponding noncleft specificational construction is the simple (= one-clause) sentence *I’ve known Jack since 1968* (with the nuclear accent on 1968).

Like any *it*-cleft with a truly specificational function, the kind of cleft illustrated by the above examples normally requires that the value specified for the variable (in this case: the measure phrase) should contrast with other potential values which are not selected. (It is only when the value constituent is anaphoric and the new information is expressed in the *that*-clause, as in *It’s since then that I’ve been feeling ill* that the value constituent need not be contrastive. However, in that case the *it*-cleft is not truly specificational.) Hence the difference in acceptability between the following:

??It is since the fall of the Berlin Wall in 1989 that I have been in contact with my cousins in the west.

It is only since the fall of the Berlin Wall in 1989 that I have been in contact with my cousins in the west. (*Only creates a sense of contrast between 1989 and earlier times.*)

??It’s only since 2003 that I have been living here.

Of the first two examples, only the version with *only* is fine, because *only* implies ‘This could have happened earlier but has only happened since the fall of the Berlin Wall in 1989’. In other words, because of the presence of *only*, 1989 is contrasted with earlier times. However, out of context ??*It’s only since*

2003 *that I have been living here* is odd because its default reading is ‘I haven’t been living here long, in fact (only) since 2003’ rather than ‘I could have lived here before 2003 but have only lived here since 2003’.

In sum, in the sentences that are unacceptable (in isolation), the phrases that are supposed to function as the value of a specificational sentence are unsuitable values because they are not clearly contrastive. This renders the sentences unacceptable. However, this problem does not arise if the sentences are used in a suitable context inviting a ‘contrary to expectation’ reading (which is a kind of contrastive interpretation), irrespective of whether it is the value constituent that is contrastive or the variable constituent:

[It isn’t since I moved to Berlin,] it’s since the fall of the Berlin Wall that I have been in contact with my cousins in the west. (*Since the fall of the Berlin Wall* contrasts with *since I moved to Berlin*, which is echoic: someone has intimated that it is since I moved to Berlin that I have been in contact with my cousins in the west.)

[“You have been working in this town since 2003?” – No, I’ve been working in this town since 1998.] It’s since 2003 that I *have been* LIVING here. (*Here the relevant contrast is to be found in the variable constituent.*)

Two further things should be noted here:

- (a) If the highlighted constituent of the cleft is a *since*-constituent, the *that*-clause sometimes evokes a mixture of indefinite and continuative reading:

[She was Ellen Leicester, and Mr. Gastonel ran away with her, and she died. That was last spring,] and it’s since then that Mr. Leicester *has got* so ill. (www)

[Let me recap the everyday story of teacher training folk, just the edited highlights. I’ll begin in the 1980s after the Robbins period. (...)] It’s since then that much has gone wrong, since then that the confusion *has set in*. (www)

[Unfortunately, the American company I was working for, pulled all of their development out of the UK last year. While I could have had a job with them in the USA, I didn’t really want to bring my children up over there, so I accepted redundancy.] It’s since then that I’ve *discovered* just how bad the IT sector is at the moment. (www)

The forms *has got*, *has set in* and *have discovered* are indefinite perfects in the sense that the literal meaning of *get* (*ill*), *set in* and *discover* is inchoative: these (more or less punctual) situations constitute the beginning of a longer period. However, the above sentences foreground the full resultant states (of Mr. Leicester being ill, of there being a state of confusion and of ‘my’ knowing how bad the IT sector is at the moment) rather than the initial point of these states only, so that the indefinite reading is rejected in favour of a continuative state interpretation. (In the first example there is surely no possibility that Mr Leicester could be well at speech time, which there ought to be if the meaning were purely indefinite.)

- (b) As noted in 5.20.2, cleft sentences alternate with other types of specificational structures, some of which consist of one clause only. Thus, there is no difference of interpretation between the following:

["Who did this?"] – "It was Maud who did this."

["Who did this?"] – "MAUD did this."

In the same way, there is no interpretational difference between the following:

It's four weeks that she's been missing now.

She's been missing for FOUR weeks now.

Both sentences are interpreted in terms of a presupposition 'She's been missing for x time' (which receives a continuative reading) plus a specificational speech act ' $x = \text{four weeks}$ ' (which reminds us of a constitution reading). The only difference between the two examples is that in the cleft sentence the presupposition and the specification are encoded as two separate clauses, whereas they are encoded within the same clause in the noncleft version.

5.21.3 There is another special type of construction in which a constitution reading is combined with a continuative reading.

When a present perfect sentence receiving a constitution reading expresses the number of times a (kind of) situation has actualized in the pre-present, the situation referred to by the present perfect tense form is a 'hypersituation' consisting of several 'subsituations' – see 5.19.4. In that case it is possible that the last of the subsituations is still in progress at t_0 .

This is the third time I {*have watched* / *am watching / *watch / *have been watching} this film. [I like it.]

The cigarette I'm smoking now is the third I {*have smoked* / *am smoking / *smoke / *have been smoking} today.

This is the first cigarette I {*have smoked* / *am smoking / *smoke / *have been smoking}. (*The set of subsituations here is a singleton. The one subsituation in question is actualizing at t_0 .*)

It is telling that neither the present tense nor the progressive form can be used in the relative clause of such examples, even though the last (or even only) subsituation is interpreted as in progress at t_0 . This is because of the quantificational constitution interpretation:

- (a) The speaker does not use the present tense because his primary concern is not with the fact that a subsituation is actualizing at t_0 but rather with the question of how many subsituations have actualized in the pre-present. That the time of the full situation whose situation time is located at the end of the pre-present may include t_0 is not expressed by the perfect, which only expresses that the situation time of the hypersituation is contained in

the pre-present. (In this case ‘contain’ is interpreted as ‘coincide with’.) The present perfect says nothing about the possible continuation of the full hypersituation into the present. In the above examples the idea that the last subsituation of the full hypersituation includes t_0 is evoked by the use of *This is ...* or by *The cigarette I’m smoking now is ...*.)

- (b) Because a quantificational constitution reading is always W-bounded (see 5.4.5 and 5.19.1), the progressive form (which triggers L-nonboundedness) is incompatible with such a reading. This is why we cannot say **This is the third cigarette I’ve been smoking today*, even if the last subsituation is in progress at t_0 – see also 5.29.2–3.

However, in the following paragraphs we will draw attention to an exception to principle (a). An exception to principle (b) will be discussed in section 5.29.2–3.

There is one apparent exception to rule (a): the present tense *can* be used if it represents the post-present actualization of a situation as pre-determined by present circumstances. (This use of the present tense has been discussed in 3.8–9.) The following example illustrates this:

This is the last visit I {*am paying* / **have paid* / **have been paying*} you. [You will never see me again.]

In this type of sentence the presently ongoing situation again forms part of a pre-present series. However, the speaker no longer focuses on the idea of ‘pre-present series’ – the idea of how many times a situation has actualized in a period leading up to t_0 – but is concerned with the post-present. The predominant idea is not that there have been similar situations before the present one but that there are not going to be any similar situations after this. This means that the present tense form *am paying* refers to the future rather than to the present: it is an instance of how a present tense can be used as a ‘futurish’ form to refer to the post-present (see 2.9). The above example therefore expresses something like ‘I am not paying you any more visits’, which can come close in meaning to ‘I refuse to pay you any more visits’. This use of the present tense is further illustrated by the following:

This is the best meal we’re *giving* you. [So make the most of it.]

This is the worst meal we’re *giving* you. [So don’t despair.]

In both cases the present tense refers to the post-present: ‘You will not be given a {better / worse} meal than this’.

There are two further pieces of evidence supporting this analysis. Firstly, sentences like *This is the first time I am paying you a visit* can only be used if the speaker is phoning the addressee, or writing a letter to him, since the addressee cannot be with the speaker at speech time. The following is a suitable context for the sentence to be used:

[I'm coming to see you tomorrow.] This is the first time I am paying you a visit, [so I'm looking forward to meeting you.]

Secondly, replacing the progressive present tense by the nonprogressive present is only possible if the situation in question forms part of a habitual routine:

This is the worst meal we give you.

The use of *give* is only acceptable on an understanding that the meal-giving forms part of a habitual routine, and 'you' really means 'not only you but anyone who is in your position'. This is the case, for example, in the following context:

[Anyone who stays at this monastery for a week gets a good meal most days – for example, it's roast duck on Saturdays and beef casserole on Sundays, but on Mondays it's always boiled tripe, and here's yours. Don't worry,] this is the worst meal we give you.'

As noted in 3.8, forming part of a habitual routine is a typical instance of how a post-present situation can be viewed as 'pre-determined' and can therefore be referred to in the nonprogressive present tense.¹⁵

5.22 Summary of part V

5.22.1 We speak of an **up-to-now reading** if the full situation is taken to cover the entire pre-present, i. e. if the full situation leads up to t_0 in such a way that it does not include t_0 and that there is no significant interval between the end of the full situation and t_0 .

5.22.2 One type of up-to-now reading is the **constitution reading**. Here the speaker looks back on the pre-present to 'measure it' or to see how this period has been filled 'situationwise'. The speaker thus focuses on the situational constitution of the pre-present zone and not only on the temporal location of a situation on the time line. On the constitution reading the pre-present may be filled either by one full situation which actualizes throughout the pre-present period (but without including t_0) or by a number of full situations which (possibly in combination with gaps) form a 'hypersituation' which coincides with the pre-present but does not include t_0 . In the latter case, the number of constituting subsituations may be zero, one or more.)

15. Things are different in the following sentence, where *give* is not used as a futurish form (establishing a post-present domain) but as a 'pseudo-absolute' present tense form expressing simultaneity in the post-present domain established by the head clause (see 9.17.3):

[You will get some food tonight.] This will be the first and only meal we *give* you today.

5.22.3 There are three subtypes of constitution reading:

- (a) The speaker may be concerned with the nature of the situation that is conceived of as having lasted throughout the pre-present without including t_0 (e.g. *What have you been doing?*; *Where have you been?*). In that case there is a **nonquantificational** constitution interpretation.
- (b) The speaker may be concerned with the length of the pre-present and indicate this by a bounded present perfect sentence referring to a duration-specifying situation (e.g. *Nearly a year has gone by since then*). In that case there is a **duration-quantifying** constitution interpretation.
- (c) The speaker may also be concerned with how many times a specific situation (or kind of situation) has actualized in the course of the pre-present (e.g. *How many times have you met him in the past week?*). In that case there is a **number-quantifying** constitution interpretation.

In all three constitution readings, the time of the full situation coincides with the situation time (= the time of the 'predicated' situation), which coincides with the pre-present zone, which does not include t_0 . This means that the full situation is always W-interpreted as bounded: in each case the right boundary is the point of time immediately preceding t_0 .

5.22.4 An up-to-now reading which is not a constitution reading is an **unmarked up-to-now reading**. Sentences receiving this reading often have an **explanatory-resultative** function.

DEMO

VI. The relation between the W-readings and (non)progressive aspect

5.23 (Non)progressive aspect and a continuative nonhabitual reading

A continuative interpretation is by definition a *progressive interpretation* (even though stative verbs do not allow the use of the progressive *form*): the full situation that started before t_0 includes t_0 , i. e. is still in progress at t_0 .

It is therefore not surprising that, when the conditions for using the progressive form are satisfied (minimally: the verb phrase is compatible with the progressive form and the reference is not to a permanent habit or characteristic), a present perfect sentence referring to a single situation which is to be interpreted as continuative normally uses the progressive form, though this 'rule' is less strict if a continuative interpretation is anyhow enforced by an adverbial like *ever since* or *for the past two hours*. This is illustrated by the following examples:

John has been working on his dissertation for two hours. (*continuative*)

John has worked on his dissertation for two hours. (*indefinite reading possible*)

John has worked on his dissertation for the past two hours. (*continuative*)

In sum, if the speaker refers to a dynamic (= nonstatic) situation and wants to express progressive meaning – in this case the idea that the pre-present situation is still ongoing at t_0 – he will normally use the progressive form. This is in keeping with the Gricean Maxims. A speaker will not normally be understood as wanting to represent a dynamic situation as still continuing at t_0 if he uses a nonprogressive present perfect in a context where the progressive form is grammatically possible. In other words, if the progressive is grammatically available and not used, the speaker is understood not to wish to convey progressive meaning and thus not to wish to convey continuative meaning.

5.24 (Non)progressive aspect and a continuative habitual reading

5.24.1 It is typical of repetitive habits that, irrespective of the time zone in which they are located, the progressive form represents them as **TEMPORARY HABITS**, whereas the nonprogressive form represents them as **PERMANENT HABITS**, i. e. as not restricted in time:

I'm writing poems these days. (*temporary habit*)

I write poems. (*permanent habit*)

In those days Shakespeare was writing sonnets rather than plays. (*temporary habit*)

In those days Shakespeare wrote sonnets rather than plays. (*permanent habit: in the restricted period indicated by in those days it was a permanent characteristic of Shakespeare that he wrote sonnets rather than plays.*)

The same is true when the present perfect is used on a continuative interpretation. (Remember that in the present section – section 5.24 – we are only concerned with the continuative interpretation.)

Ever since I was fifteen I *have slept* only five hours a night. (*The sentence asserts the continuative repetition of the situation of the speaker sleeping only five hours a night, which constitutes a continuative permanent habit.*)

I *have been sleeping* ten hours a night since we have been on holiday. (*The continuative repetition of situations is taken to constitute a temporary habit.*)

Jimmy, 41, a former pit worker at the Bevercotes colliery, in Ollerton Nottinghamshire, *has looked* in vain for work ever since. (www) (*Ever since enforces a continuative reading. The progressive form is not used, because the speaker treats Jimmy's looking for work as constituting a permanent habit rather than a temporary habit or a single nonhabitual situation.*)

It is the same mixture of cunning and inspiration which *has helped* Morita's business career to prosper ever since. (www) (*similar*)¹⁶

He *has used* his physical shortcomings to advantageous effect ever since. (www) (*Ever since enforces a continuative reading. The reference is not to a single situation of using physical shortcomings to advantageous effect but to repeated use of this device, which has become characteristic of the referent of the subject NP. By using has used the speaker represents that characteristic as a permanent habit. He could also have used has been using, which would have represented the habit as still temporary.*)

We've only {*been working* / *?worked*} as waiters for four days, [so we haven't acquired a lot of experience yet].

[I'm ninety-two and] I {*have had* / *??have been having*} long walks in the country since I was four.

I {*have written* / *have been writing*} books ever since I started working at the university. (*In this case each subsituation is telic because the underlying proposition is 'I write a book'. However, the habitual hypersituation as a whole is not telic, because a habit is a state. The use of the nonprogressive form therefore does not represent the situation as L-bounded and forms no obstacle to the continuative interpretation.*)

16. One might object to our speaking of a habit here because the speaker does not attribute a habit to the referents of the coordinate subject NP. (He could hardly do so because these referents are inanimate.) However, this is beside the point. What counts is that it has been characteristic of Morita's business career that it has prospered 'ever since'.

5.24.2 In sum, the use of the progressive form is the rule if the repetitive habit is to be explicitly represented as temporary (rather than permanent), i. e. as restricted in time, as covering a relatively short period leading up to t_0 . One reason why a habit may be seen as temporary is that it is seen as induced by volatile rather than stable factors (and may therefore easily come to an end). Compare:

We've {*been eating* / ²*eaten*} outside since the weather became hot. (*relatively short period; the habit started only recently and will come to an end as soon as the weather conditions change*)

We've {*eaten* / ³*been eating*} outside ever since we came to live here twelve years ago. (*permanent habit; the habit started a considerable time ago and there is no reason to expect that it will suddenly come to an end*)

The spring creeks *have been fishing* ok lately, [but we have not had enough hatch activity to get the fish feeding regularly on the surface.] (www)

5.24.3 A condition for a repetitive habit to be interpreted as continuative is that the clause (or the context) must make it clear that the reference is to a repetitive hypersituation:

I {*have been coming* / ³*have come*} to this shop for years. (*Have come is odd because there is nothing triggering a repetitive interpretation; have been coming can only be interpreted as repetitive – because of the combination of the progressive form and a punctual VP – and is taken to express a temporary habit continuing into the present.*)

I *have come* to this shop on the first Friday of every month for years. (*on the first Friday of every month implies repetition*)

I *have come* to this shop for my shirts ever since I came to live here last year. (*This implicates 'Since I came to live here there have been several occasions on which I have wanted to buy a shirt' and is understood as 'on each of those occasions I have come to this shop'. There is a sense of repetition here, which renders it possible to interpret have come as a continuative perfect.*)

I *have always come* to this shop – ever since it opened. (*Always implies repetition if the situation is punctual.*)

I *have run* the mile for years. (*This sentence is odd unless it is interpreted as 'For years I have taken part in the activity known as running the mile'. This interpretation implies repeated actualization of the situation referred to by the telic VP.*)

5.25 The indefinite reading and (non)progressive aspect

5.25.1 A present perfect sentence which is to receive an indefinite reading is not normally in the progressive form. This is because an indefinite reading is a bounded reading, while a progressive clause typically represents its situation

as nonbounded. Besides, a speaker using an indefinite perfect is not so much concerned with the duration or progressiveness of the situation (or a portion of it) as with the fact that (or the question whether) the situation *has* actualized in the relevant period leading up to now. Compare:

Has Tim worked in a colliery? (*The speaker only wants to know if the situation has ever actualized. He is not interested in the duration of the possible actualization. In all likelihood he only wants to know if Tim has had the experience of working in a colliery.*)

Has Tim been working in a colliery? (*According to the context in which it is couched, this may receive a continuative reading or an up-to-now reading.*)

This does not mean, however, that an indefinite perfect is never in the progressive form. In the following subsections, several exceptions are pointed out.

5.25.2 An indefinite perfect used as an experiential perfect is not automatically incompatible with progressive meaning. There is clear progressive meaning if the situation in question is represented as a 'background' situation for another situation, or, more generally, if the context provides a vantage point from which the situation is viewed as being in progress. Compare:

?Have you ever been writing a novel? (= 'Has it ever been the case that you were working on a novel (without necessarily completing it)?')

Have you ever been writing a novel [when you suddenly lost interest and decided to do something else]? (*The progressive form is unpedicable because the when-clause provides a vantage point from which the situation of writing a novel (if any) is viewed as being in progress.*)

?Has Tim ever been working in a colliery?

Has Tim ever been working in a colliery [and experienced a cave-in]? (*Ever enforces the indefinite reading, and the second clause provides the temporal vantage point from which the working is viewed as being in progress.*)

Have you ever been writing lyrics [and found you 'watered down' what you really wanted to say]? (www)

Similarly, compare:

Have you been working on a dissertation? (*The context should make it clear whether the continuative interpretation or an up-to-now reading is invited.*)

Have you ever been working on a dissertation [and had to abandon it for some time and then return to it]? (*The indefinite interpretation is enforced by 'ever' plus the context. The sentence means 'Has there ever been a time in your life when the situation of your working on a dissertation was in progress (and then was interrupted by your having to abandon it)?'*)

Have you ever been sitting in the pub with no money dying for a pint or a pack of cigarettes, [then shoved your hand in your pocket and found £20 you'd forgotten about?]

The temporal vantage point can be expressed by an adverbial *when*-clause, provided there is the idea of (at least the possibility of) repeated actualization in a period leading up to t_0 . (When the *when*-clause refers to a single bygone situation, the past tense must be used). For example:

Sometimes when I've entered her room *she's been crying*.

Whenever I've gone into his room in the past week he *has been sleeping*. (*With whenever the idea of repeated actualization in a period leading up to t_0 is automatically present.*)

The temporal vantage point can also be provided by a 'narrative *when*-clause', i. e. a *when*-clause which does not establish an Adv-time containing the situation time of the head clause but which 'pushes forward' the action – see 13.1.3.

Have you ever been sitting around bored, when all of a sudden a song comes on and makes you feel all tingly and good? (www)

The following example is similar, except that the narrative clause is now introduced by *and then* rather than by *when*:

[You've never been behind someone when all of a sudden they slow down for no apparent reason and make a turn with no signal? You've never had someone change into your lane right in front of you without signalling?] You've never been waiting to make a right turn onto a fast road, but don't because you see someone coming, [and then only when they turn onto your road do you realize] that you could have gone before he and the entire pack of cars behind him went by – if only he had signalled.] (www)

5.25.3 For some speakers at least, there are some other cases in which the progressive form is not unacceptable on an experiential indefinite reading even though there is no overt reference to a vantage point, because the sentence evokes the idea of a vantage point in some other way. The following are some examples resulting from a Google search for the form *have been waiting*:

[I've never used Amazon for anything other than books/CDs, how do their prices compare with specialist mailorder computer places? I've never had any big delays from them, but then] I've never been waiting for something urgently from them. (*This is paraphrasable 'I've never been in the position of (someone) waiting for something urgently (so I've never been in the position where a couple of days extra would feel like a big delay)'. It seems to be this 'being in the position of' that provides the vantage point for the progressive.*)

So considering I've never been waiting impatiently for any Sarah album besides Afterglow, [I tried not to have expectations of it.] (www) (= 'I haven't been in the position of waiting impatiently for any Sarah album (as a die-hard fan would be).')

The following example does not suggest a clear vantage point. However, it is easily paraphrased 'I've never been in the position of waiting', and the focus is

on the irritation of being kept waiting, of standing around doing nothing (or rather on the minimal amount of such irritation), whilst the alternative ‘I’ve never had to wait longer than 20 minutes’ would simply report a maximum delay:

[Queues are generally kept to a minimum, except at 2 o’clock when everyone wants to get their coat from the cloakroom, but] *I’ve never been waiting* longer than 20 minutes. (www)

The following sentences too encourage an interpretation along the lines of ‘I’ve never had the experience of waiting ...’ in a way that a nonprogressive version would not, because it would not encourage the hearer to take a viewpoint on the waiting from inside the waiting, so to speak:

[The entire staff has always been friendly and courteous.] *I have never been waiting* for anything I have ordered. (www)

[They carry HL1 mods and the fancy Half-Park cartoons, they link to a neat download page with EXTREME SPEED! Fileplanet gives the schools 10 Mbit about 56 KBPS, not bad itself, but it is average, this wannabe fileplanet site rules, AUTO server chose with the least traffic,] *I have never been waiting* in line, [never paid a dime and gotten an Average download speed of 556 KBPS!!!] (www)

5.25.4 There may still be other types of present perfect sentences (containing an adverb enforcing an indefinite reading) in which there can be progressive meaning without explicit reference to a vantage point from which the situation is viewed as being in progress. Thus, *I have been cycling to Greece before* could be acceptable if it is uttered by someone experiencing partial and fuzzy recall, and thus wanting to make it clear that he is only able to remember some midpoint of a situation and nothing further. This is the case in the following example:

I’ve been cycling to Greece before. [That is, I’m cycling to Greece now, and this has suddenly triggered a memory of being in the same situation before, but I can’t remember anything about what preceded or followed the recollected moment of being in the process of cycling to Greece.]

5.25.5 The progressive form presents no problem for the ‘recency use’ (see 5.16) of the indefinite perfect, because adverbials like *just* or *this minute* are anchored to t_0 and can function as the vantage point from which the situation is viewed as being in progress:

Are you quite sure you *haven’t just been speaking* to the cryptic “K” herself? (DOC) (*Because the time of the ‘speaking’ is anchored by being ‘just before speech time’, it provides a vantage point from which the situation referred to using the progressive can be viewed.*)

[“How can I help, sir? Two things, you said.” – “Ah! Well, yes. That’s one, isn’t it?” What we’ve *just been talking* about. [You see, I’m jacking the job in next year, as you’ve probably heard?]] (DOC)

5.26 The unmarked up-to-now reading and (non)progressive aspect

5.26.1 Present perfect sentences yielding an unmarked up-to-now reading and referring to a habit use the nonprogressive form to represent the habit as non-temporary (permanent) and the progressive form to represent it as temporary (restricted in time):

We have *always* said that the car was reliable. (*permanent habit up-to-now*)

We have *always* said that the car was reliable [but we must admit that it broke down this morning]. (*permanent habit up-to-now*)

We have *always* said that the car would break down some day. (*permanent habit up-to-now*)

We've been telling people that the car was reliable. (*temporary habit up-to-now*)

We've been telling people that the car was reliable [but we must admit that it broke down this morning]. (*temporary habit up-to-now*)

We've been telling people that the car would break down some day [and it has]. (*temporary habit up-to-now*)

5.26.2 Semelfactive (= nonhabitual) situations that are in progress throughout a pre-present period (but have come to an end shortly before t_0) are referred to by means of a progressive present perfect form:

[I'm glad he's moved away from the window.] He's *been sitting* there for an hour [and I think the people opposite believe he's spying on them.] (*nonhabitual temporary situation up-to-now*)

We have only recently discovered what *has been going on*.

Someone *has been mowing* the lawn. [It looks perfect.]

5.26.3 The verb form is always progressive (if the verb allows this form) if the sentence yielding the unmarked up-to-now reading is used in an 'explanatory-resultative' way (see 5.18.3), i. e. if the sentence gives (or asks for) an explanation for a state of affairs that is an indirect (and usually unintended) result produced by the actualization of the situation referred to in the sentence. The reason is that in this use the situation is always interpreted as nonhabitual and temporary.

["Your hands are dirty."] – "I've *been working* in the garden." (*The speaker explains how the result of his hands being dirty has come about. The result in question did not suddenly come about at the end of his working in the garden but was an unintended side effect of his working which showed itself during the working situation itself.*)

I've been writing a book. (*This sentence may, according to context, suggest 'That's why I am so tired', 'That's why I have seldom come to the pub recently', etc.*)

["Why are you upset?"] – "The two women over there *have been insulting* me."

These sentences have an explanatory-resultative function because they offer an explanation for a contextually given state of affairs. The explanation in question relates to an (often unintended) result which came about *while* the situation indicated by the verb phrase was in progress and *because* that situation was in progress.

As noted in 5.18.3, it is typical of the explanatory-resultative use of present perfect sentences receiving an unmarked up-to-now reading that the sentence in question has the discourse function of an explanation, excuse or reproach. The reference is to a situation that has recently actualized (but is conceived of as filling the pre-present because it is the only relevant situation in that period – see 5.19.4)¹⁷ and has produced a result which is still apparent at t_0 . The sentence has to be in the progressive form (if possible)¹⁸ because the result in question does not follow from the completion of the situation, but is produced by the pre-present situation while it is in progress.

It follows that such sentences in the progressive present perfect can only be used if the effect which the speaker wants to express does not presuppose completeness or termination of a telic situation. The use of the progressive, indeed, does not guarantee that the situation has been properly completed. Thus, *I've been planting the shrubs* can suggest 'That is why I am tired' but, while it does not rule it out, it does not suggest 'All the shrubs are planted now'. The latter idea requires the sentence *I've planted the shrubs*, which represents the situation as both telic and bounded. In sum, while the unmarked up-to-now reading does mean that the situation has stopped at t_0 , the terminal point reached does not have to be the point of completion of a telic situation. In *I've been working in the garden*, the situation is not referred to by a telic

17. In 5.19.4 we discussed examples like *I've been raising three children and establishing a multinational corporation* – which can easily be uttered two years after the last child left home and a year after the multinational has been sold. We see no difference between this sentence uttered in response to *What have you been doing for the last twenty years?* and *I've been gardening* uttered in response to *Your hands are dirty* and telling the addressee what the speaker has been doing in order to get dirty hands. The gardening situation fills the pre-present just as well if it finished, say, two hours ago as if it finished two seconds ago – it is anyhow seen as the relevant 'filler' for the relevant period up to now. (The fact that the situation(s) mentioned need not literally fill the entire pre-present is similar to the fact that a repetitive habit can be located at t_0 even if there is no subsituation actualizing at t_0 : the speaker does not have to be dancing now to say *I do ballroom dancing*. A repetitive habit is anyhow seen as homogeneous because accidental gaps are treated as irrelevant. In the same way, *I have been writing a book* (which may receive a nonquantificational constitution reading) is homogeneous even though the writer will normally have stopped occasionally to sleep, eat, etc.

18. The following is an example in which the progressive form cannot be used because the verb is stative:

["Your hands are dirty."] – "I've been in the garden."

verb phrase; in the explanatory-resultative use of *I've been writing a book*, the situation is telic but the terminal point reached need not be the natural point of completion: it may also be any time preceding the natural point of completion.

5.27 The nonquantificational constitution reading and (non)progressive aspect

In this section we will argue that a clause receiving a nonquantificational constitution perfect reading is always progressive, and will try to account for this.

5.27.1 A present perfect sentence triggers a nonquantificational constitution reading if the speaker is clearly concerned with the 'situational constitution' of the pre-present, i. e. with the kind of situation(s) filling the pre-present. On this reading the present perfect clause generally uses the progressive form (if that use is allowed by the verb):

[Ah, I see you're back at last.] What *have* you {*been doing* / **done*}? (*What have you done?* cannot yield the intended nonquantificational constitution reading.)

[During my first twenty years I have learned the recorder, the violin] and until recently I *have been teaching* myself the acoustic guitar. (www) (nonquantificational constitution reading if the sentence is used specificationally; otherwise an unmarked up-to-now reading)

In these examples, the length of the pre-present period is to be inferred from the pragmatics of the context. In the following, it is indicated by the bifunctional adverbial *for the last twenty years* in the preceding sentence:

(uttered at a school reunion) ["What have you been doing for the last twenty years?"] – "I've been raising three children and establishing a multinational corporation."

In examples like this, the relevant sentence responds to a request to account for a period up to now. It refers to a hypersituation involving one or more subsituations. The enumeration of the subsituations constituting the hypersituation which fills the relevant period leading up to now does not need to be exhaustive. In this case the speaker has obviously been doing many other things – the situations of child-rearing and corporation-establishing may even have come to an end – but the speaker's concern is obviously with providing an informative response to the question. The questioner is understood not to want an exhaustive list of the speaker's activities over the last twenty years but information about what we may call the relevant reportable activities. These

then ‘account for’ the twenty years, and are thus treated as filling the period up to now. In other words, the subsituations mentioned are selected according to what the speaker deems relevant as filling and characterizing the period leading up to now. (This phenomenon is similar to the phenomenon that one can say *I am establishing a multinational corporation* although one is actually watching a movie at t_0 .)

In the example under discussion, the perfect forms refer to situations which fill a period leading up to now that is set up by the time-specifying adverbial in the preceding sentence: *for the last twenty years* establishes an Adv-time. As noted in 2.23.1, an Adv-time ‘contains’ the situation time (in terms of either inclusion or coincidence – in this example it is in terms of coincidence). Since one of the uses of the progressive form is to express that a situation is continuous (i.e. in progress) throughout a given period, the progressive form is used to refer to the present perfect situation filling the pre-present. In sum, the only difference between (4) and (5) below is that the filled Adv-time is a past time span in (4) and a pre-present one in (5):

(4) From two to four I *was writing* a letter to our sponsors.

(5) (*uttered on coming out of the study*) For the last two hours, I *‘ve been writing* a letter to our sponsors.

Examples (6) and (7) are similar to (5), except that in (7) the pre-present period is to be inferred rather than being expressed by a time-specifying adverbial:

(6) What have you been doing for the last two hours? (= ‘*With what action(s) have you filled the last two hours?*’)

(7) What have you been doing? (*This implies something like ‘since I last saw you’, which could imply a period of two minutes, as in A couple of minutes ago you disappeared, but now you’ve reappeared and I can see you’ve been up to something: what have you been doing?, or twenty years, as above.*)

The fact that questions (6) + (7) can easily be put to someone who is just coming in, or has just come in, makes it clear that the progressive form is not used to trigger a continuative interpretation: the situation(s) referred to by *have been doing* are not continuing at t_0 . The perfect forms do not receive an indefinite reading either, because the time at which the situation time of the hypersituation is temporally located (in terms of coincidence) is each time quite definite, since it is a period whose terminal point is adjacent to t_0 (and the latter is the most definite time conceivable, since it is the speaker’s deictic centre). The only interpretation that makes sense is an up-to-now reading. Because (6) and (7) ask for specificational information, this reading is a (nonquantificational) constitution interpretation rather than an unmarked up-to-now reading.

5.27.2 This conclusion is in keeping with the observation (made in 5.18.3) that a present perfect sentence implicating a ‘direct’ (see 5.37.1) present result

receives an indefinite interpretation, which means that it refers to a bounded (complete) situation and is therefore in the nonprogressive form. Compare:

I've emptied the cesspool. (*direct result: the cesspool is now empty*)

I've been emptying the cesspool. (*The speaker does not suggest that the cesspool is empty, but may be explaining why he smells awful – see 5.18.3.*)

This means that the progressive form does not normally implicate the coming about of the direct present result of a pre-present telic situation, but can describe the pre-present situation itself. Thus, unlike *I've emptied the cesspool*, which implicates 'The cesspool is now empty' (= the direct present result of the pre-present telic situation of my emptying the cesspool), *I've been emptying the cesspool* describes the situation itself.

In other words, while the present perfect is normally nonprogressive on an indefinite reading, a nonquantificational constitution reading as a rule requires the use of the progressive form (if the conditions for its use are satisfied, e.g. the VP must be dynamic and agentive). For example, compare the sentences in the following pairs:

- (a) I have been redecorating the drawing-room. (*nonquantificational constitution reading or unmarked up-to-now reading: the speaker is not concerned with a possible direct present result but with the nature of his action filling the pre-present*)
- (b) I have redecorated the drawing-room. (*indefinite reading: the speaker is primarily concerned with the direct present result. 'The drawing-room is redecorated now.'*)
- (a) ["Who's going to answer the application letters?"] – "I've already answered the application letters." (*indefinite reading: the stress is on the direct result 'The application letters do not need answering any more.'*)
- (b) I have been answering the application letters this morning. (*nonquantificational constitution reading or unmarked up-to-now reading: the speaker tells the hearer what he has spent this morning doing, i.e. what his pre-present actions have been.*)
- (a) [So this is Christmas] and what have you done? (*from John Lennon's song Happy Christmas (War is Over)*) (*indefinite reading; the speaker is concerned with the direct result of the action: 'What have you achieved?'*.)
- (b) What have you been doing in the past year? (*nonquantificational constitution reading: the speaker wants to know how the pre-present (= the past year) has been filled 'situationwise'.*)
- (a) ["Oh, there you are.] What have you been doing?" – "I've been writing letters." (*nonquantificational constitution readings*)
- (b) ["Oh, there you are.] Where have you {been / *been being}?" – "I've {written / been writing} three letters." (*nonquantificational constitution readings, but the progressive cannot be used in the question because be is used as a stative verb;*)

the reply I have been writing three letters is fine because Where have you been? is reinterpreted as 'What have you been doing?'.)

In the following examples, both the question and the reply receive a nonquantificational constitution reading:

“What have you been doing today?” – “I have been studying.” (*The question says: 'Tell me about your pre-present action(s).' The reply describes the action.*)

“Where have you been?” – “I’ve been making up the beds.”

“What have you been doing?” – “I’ve been shopping.”

5.27.3 The only case in which a present perfect sentence yielding a nonquantificational constitution reading does not have to be progressive is when it is a ‘specificational’ (see 5.20) question whose presupposition is formulated in the form of a clause with an indefinite present perfect. (An indefinite perfect is not normally progressive.) For example:

What {has happened / has been happening} to you? (*specificational: the speaker asks for the specification of a value for the presupposed variable 'the x that has happened to you'.*)

The presupposition ‘Something has happened to you’ yields an indefinite reading, but the sentence as a whole asks for specification of the nature of the relevant situation(s) in the pre-present and is therefore given a nonquantificational constitution reading (see 5.19.1). Because both aspects of interpretation are present, the verb form may or may not be progressive.

5.28 The duration-quantifying constitution reading and (non)progressive aspect

In the previous section we have seen that as a rule the progressive form needs to be used (in verb phrases that are dynamic and agentive) if the present perfect sentence is to receive a nonquantificational constitution reading, i. e. when the focus is on the nature of the situation(s) filling the pre-present. By contrast, the progressive form is never used if the present perfect sentence measures the duration of the pre-present, i. e. when it receives a ‘duration-quantifying’ (see 5.19.1) constitution interpretation:

Seven long years have {passed / *been passing} since the death of my wife.

Six months have {elapsed / *been elapsing} since then.

The reason for this is obvious. In the duration-quantifying reading, the sentence expresses the result of ‘measuring’ the pre-present. The situation referred to is therefore the state of the pre-present having a certain duration. States are not normally referred to by a progressive form. Besides, measuring the duration of a period requires considering it from beginning to end. The situation of a

period having a certain duration must therefore be represented as bounded – see 1.46.2). It follows that the progressive form cannot be used, because the progressive refers to a middle part of the situation only and thus fails to represent it as bounded. (This is true irrespective of the tense used. There are very few contexts in which one can talk of seven years as being in the process of passing, whatever the tense: **Seven years {have been / are / were / will be} passing {since my accident / before my graduation}*. Only sentences referring to a predetermined (and ‘pre-measured’) situation, like a prison sentence, form an exception: *My seven years of imprisonment are passing, [but I still have three to go].*)

5.29 The number-quantifying constitution reading and (non)progressive aspect

5.29.1 For the same reason, the progressive form is not normally used when the sentence is to receive a ‘number-quantifying constitution interpretation’ (see 5.19.1), i. e. when the focus is on the number of discrete occasions on which a situation has actualized in the pre-present:

How many times have you {visited / **been visiting*} Ireland?

He’s {insulted / **been insulting*} me three times so far.

I {have eaten / **have been eating*} steak tartare at least five times since we’ve been on holiday.

When the speaker is concerned with measuring a hypersituation by counting the number of times a subsituation has actualized (or, which amounts to the same thing, the number of subsituations constituting the hypersituation), it is very improbable that he is thinking of these actualizations as incomplete (i. e. in progress). Still, it is not impossible for the speaker to scan the pre-present for actualizations and at the same time be concerned with their on-goingness. However, this is only possible when the context provides the temporal vantage points from which the subsituations are viewed as in progress:

Four times, I’ve been working on my dissertation but had to leave off doing so.
(= ‘So far there have been four occasions when I was in the process of working on my dissertation when I had to stop and do something else.’)

In such sentences it is not the ‘hypersituation’ filling the pre-present period that is represented as in progress. On a quantificational constitution reading the hypersituation filling the pre-present is always a state. States are not normally referred to in the progressive form. If the progressive is used, it is the individual subsituations whose number is counted that are represented as in progress (as in the above example). In other words, the above example does not form an answer to ‘Has the hypersituation of your-working-on-your-dissertation

tation-four-times been in progress throughout a period leading up to now?’ but answers the question ‘How many times has a situation of your-working-on-your-dissertation been in progress in a period leading up to now?’. The sentence is therefore interpreted as ‘So far there have been four situations of my being in the process of working on my dissertation ...’.

5.29.2 As noted in 5.21.3, a sentence receiving a number-quantifying constitution interpretation sometimes refers to a series of situations, the last of which is in progress at t_0 . Even in that case the perfect form must as a rule be non-progressive, except if all the subsituations are explicitly represented as ‘background situations’ (i. e. if the context provides the temporal vantage points from which the subsituations are viewed as in progress):

This is the third time I {*have watched* / *am watching / *have been watching} this programme.

This is the third time I {*have watched / *am watching / *have been watching*} this programme and been interrupted.

This is the third time I *’ve been watching* this programme when you’ve arrived. [I don’t really watch this rubbish every week, you know. It’s just a coincidence that the only times I’ve watched it, you’ve arrived during my watching it.] (*Each of the subsituations referred to by I’ve been watching this programme is a background situation.*)

These examples illustrate the following:

- (a) In spite of the fact that there is a situation of watching in process at t_0 , the present tense cannot be used in Standard English (while it must be used in most other Germanic languages in this type of sentence expressing a number-quantifying meaning). The fact that the speaker is concerned with the question of how many times a situation has actualized in a period leading up to now is apparently sufficient to require the use of the present perfect in English.
- (b) On a number-quantifying constitution interpretation, the present perfect form which has to be used is not normally a progressive form, unless all the pre-present subsituations are explicitly represented as background situations.

5.29.3 In some cases, the ‘series’ of situations constituting the hypersituation (referred to in a sentence receiving a number-quantifying constitution reading) is a set which is a singleton – see 5.21.3. In that case the one and only actualization of the situation may be in progress at t_0 . Even then, the tense to be used is the present perfect because a hypersituation (consisting of a gap and one subsituation) is said to fill a period leading up to now.

This is the first time you {have spoken / *are speaking} to me.

Is that the first cigarette you {have smoked / *are smoking} today?

In such examples, the progressive form cannot be used (even though the single subsituation is in progress at t_0), unless the subsituation is explicitly represented as a background situation during which another situation actualizes:

[Now that I come to think of it,] this is only the first cigarette {I've smoked / *I've been smoking} today.

[Now that I come to think of it,] this is only the first cigarette *I've been smoking* today [and had to throw away.]

The latter sentence means 'Of the cigarettes I've smoked today, this is the first one that I've had to throw away while I was smoking it'. This means that *This is the first cigarette I've been smoking today and had to throw away* does not make two discrete statements – 'this is the first cigarette today' and 'I've had to throw it away' – but only one: 'This is the first cigarette today I've had to throw away while smoking it'. This statement implies that the present subsituation is not the first today: there has been at least one subsituation of my smoking a cigarette earlier today which was not interrupted by my having to throw it away.

In sum, the following rules apply in the relative clause forming part of the pattern '{definite NP (e.g. *it / this / that / that cigarette*) + *is the* + ordinal numeral or superlative + noun head + relative clause' if the reference is to a pre-present hypersituation consisting of a number of subsituations of which the last is located at t_0 :

- (a) The relative clause uses a progressive present perfect form if the present subsituation is seen as background for another situation. The time of the latter situation is the vantage time from which the background situation is seen as being in progress:

This is the first letter *I've ever been writing* [and couldn't finish because of a bomb scare.]

This is the second time I *have been speaking* / *am speaking} to him [and {have had / had} to put the receiver down because someone came into the room.]

- (b) Otherwise, the relative clause uses a nonprogressive present perfect form:

This is the first time (that) she *has gone out* / *goes out / *is going out / *has been going out} for months.

This is only the second time (that) I *have paid* / *pay / *am paying / *have been paying} a contribution.

That's the fifth glass of champagne (that) he *has drunk* / *drinks / *is drinking / *has been drinking} today.

The painting he's working on now is the best he *has produced* / *produces / *is producing / *has been producing} since he started painting two years ago.

As noted in 5.21.3, the temporal interpretation of the clause in the present perfect here combines a quantificational constitution reading – the speaker is concerned with the number of actualizations in a period leading up to now – with a partly continuative interpretation: the last situation in the series is in progress at t_0 . However, the quantificational constitution aspect of meaning rules out the use of the progressive, unless this form is needed to represent the individual subsituations as background situations for something else, as described in (a).

DEMO

VII. Factors influencing the choice of temporal W-interpretation

5.30 The indefinite reading versus the continuative interpretation

5.30.1 As we have seen, there are present perfect sentences that can only receive a continuative reading (for one of the reasons given in 5.9) and others that can only receive an indefinite reading (e. g. because the situation time is punctual, as in *He has been shot*). In some cases the same VP in the present perfect can be used in a sentence receiving a continuative interpretation and in a sentence receiving an indefinite reading. In that case, if there is an adverbial specifying a period leading up to now (e. g. *since then*) the continuative interpretation is the unmarked reading (i. e. it is the reading that is automatically selected unless it is rendered unlikely or impossible by the context).¹⁹ If there is no such adverbial and no contextual specification of a particular period leading up to now, only the indefinite interpretation suggests itself.

Since 1982 John has lived in Paris. (*naturally interpreted as continuative*)

Since 1982 John has lived in Paris, and in London, and in several other places too. (*The continuative interpretation of has lived in Paris is blocked by the rest of the sentence.*)

John has lived in Paris. (*indefinite interpretation*)

5.30.2 Nonprogressive present perfect clauses containing a duration adverbial with *for* can in principle yield either the indefinite or the continuative reading. This is true of each of the following:

John has watched TV for 3 hours. (*The continuative reading is 'It is now three hours that John has been in the progress of watching TV', while the indefinite reading is 'It has happened (at least once) in a pre-present period that the situation of John-watching-TV-for-three-hours actualized'.*)

John has {played tennis / dug the garden / sat on that stool} for 3 hours.

However, an indefinite reading can be imposed by the context or by an adverb like *ever, before, yet* or *still ... not*:

19. The following are examples in which a present perfect sentence with *since then* receives an indefinite interpretation:

(i) Since then I *have lived* in Paris, Rome, Budapest and Oslo.

(ii) [She was Ellen Leicester, and Mr. Castonel ran away with her, and she died. That was last spring,] and it's since then that Mr. Leicester *has got* so ill. (www)

Example (ii) expresses a mixture of indefinite and continuative reading – see 5.21.2.

John has lived in Paris for three years and in Moscow for two and a half years. [For the rest he has been a Londoner.] (*indefinite reading imposed by the fact that a list of bounded situations is given*)

You *still* haven't {done / *been doing} what I asked you to do. (*indefinite reading*)

Has John *ever* {played tennis / dug the garden / sat on that stool} for 3 hours?

Have you lived in Paris for three years *yet*? (= 'Has there yet been a three-year-period in your life during which you lived in Paris?')

Have you stayed in Paris for three days *before*? (= 'Has it happened before that you stayed in Paris for three days?')

Conversely, only the continuative interpretation is possible in nonprogressive sentences involving a *for*-adverbial combined with an adverb like *now* or *today* which anchors the situation to t_0 :

John has lived in Paris for three years *now*. ('For three years' indicates the duration of the 'factual full situation', i.e. the situation as it has actualized up to t_0 – see 5.7. The addition of 'now' entails that the full situation includes t_0 , in other words that the sentence is given the continuative interpretation.)

John has {watched TV / played tennis / dug the garden} for many years *now*. (*continuative habit*)

Today John has been our leader for exactly five years. (*continuative state*)

She's been a non-smoker for three years *today*. (*continuative state*)

5.30.3 If the verb is in the progressive form, present perfect sentences with a *for*-adverbial only allow an interpretation on which the situation time is co-extensive with the pre-present and therefore exclude the indefinite reading. Thus, the following all naturally yield a continuative interpretation:

John has been watching TV for 3 hours.

John has been playing tennis for 3 hours.

John has been digging the garden for 3 hours.

John has been sitting on that stool for 3 hours.

5.30.4 The adverb *never* (or *not ... ever*) is also incompatible with a continuative reading. However, it allows either an indefinite or a constitution reading:

Never in my life have I worked as a waitress. (*indefinite*: 'The situation of my working as a waitress has never actualized in my lifetime.')

I've never been there in my life. (*indefinite or quantificational constitution reading, depending on the context – see 5.32.3.*)

[She's very punctual.] I've never had to wait for her. (*indefinite*)

["How often have you had to wait for her?"] – "I've never had to wait for her." (*quantificational constitution reading*: 'The number of times I've had to wait for her is zero'.)

The incompatibility of a continuative reading with *never* is, of course, logical: a situation that has never actualized before t_0 cannot be still continuing at t_0 .

5.30.5 In the absence of adverbials like those mentioned above, a negative present perfect clause invites a continuative interpretation if it refers to a state (which may be a habit) and has a context (adverbial or other) which allows a continuative reading. On the other hand, a negative present perfect clause triggers an indefinite reading if it is taken to refer to a ‘NONEVENT’. We speak of a ‘nonevent’ if a (dynamic or static) situation that is expected to actualize (or could actualize) in fact does not actualize, and this nonactualization is treated as a situation in its own right, so that it is associated with a particular time which can serve as time of orientation or anchor time for the expression of a temporal relation (as in *The terrorists left the country soon after the bomb they had hidden in the theatre did not explode*). Compare:

He *hasn't been* here for some time. (*state; continuative reading*)

We *haven't had* a car since Maggie died. (*state; continuative reading*)

We haven't visited Uncle Ben once since we *haven't had* a car. (*idem*)

[Boggs is hoping to play well this weekend and take another step towards getting the Jackets back to Omaha for the College World Series for the first time since 1994. “When I came to college, that was the top priority. It feels like] something’s missing since we *haven't been* there.” (www) (*state; continuative reading*) (*The sentence is interpreted as ‘Something is missing and has been missing {throughout the period in which our going there hasn't taken place } throughout the period in which we haven't gone there}’. This is a continuative interpretation.*)

He *hasn't sent* the letter after all. (*nonevent; indefinite reading*)

The expected terrorist attack on the White House *hasn't taken* place. (*nonevent; indefinite reading*)

I've been very angry with him since he {*didn't send* / **hasn't sent*} the letter. (*The reference is to a ‘Bygone’ – see 4.2.2 – nonevent. However, the present perfect cannot be used because it is a general rule that, in a temporal since-clause, the present perfect can only be used on a continuative reading. If the situation is felt to be over at t_0 we have to use the past tense.*)

5.31 The up-to-now reading versus the continuative reading

What the up-to-now reading and the continuative reading have in common is that the situation (which may be a single situation, a repetitive hypersituation or a habit) fills the whole of the contextually or pragmatically determined period leading up to (but not including) t_0 . What distinguishes them is the following:

- (a) On the up-to-now reading, the time of the full situation does not include t_0 ,²⁰ whereas it does on the continuative reading. For example:

I've been helping John for hours now. (*continuative: I am still helping John.*)

["Oh, there you are. Where have you been?"] – "I've been helping John. [He didn't understand his homework.]" (*up-to-now reading: I'm not helping John any more.*)

- (b) The use of the progressive form is partly different on the two readings – see 5.23–4 and 5.26–29 above. In fact, there are also differences within the up-to-now reading.

Let us consider the continuative reading first. Here, the sentence in the present perfect does not use the progressive form if it refers to a *permanent habit*, even if that consists of dynamic subsituations.

I've helped John for many years now.

We've always worked very hard in the past.

A continuative reading does, however, require the progressive form if the reference is to a *temporary habit* made up of dynamic subsituations and (at least in most cases) if the reference is to a single dynamic agentive situation:

I've {been helping / *helped} John for hours now. (*The reference is to a single nonstative situation which is still continuing.*)

I've been helping John for months. (*The reference is to a temporary habit which includes t_0 .*)

As to the up-to-now reading, we notice a similar use of the (non)progressive form on an unmarked up-to-now reading: the verb form is progressive if the situation is temporary and nonprogressive if it is habitual – see 5.26:

(Up to now) *we've been telling* people that the car was reliable. (*temporary habit*)

(Up to now) *we've always told* people that the car was reliable. (*permanent habit because of always*)

A present perfect sentence (referring to a durative dynamic agentive situation) is as a rule in the progressive form if it is to receive the nonquantificational constitution reading – see 5.27:

[At last you're there!] What have you {been doing / *done}?

["You're late!"] – "Yes. I've {been talking / *talked} with the janitor.

By contrast, a quantificational constitution reading is as a rule incompatible with the progressive form – see 5.28–29:

20. With the exception of sentences of the type *This is the third cigarette I have smoked today* (spoken while the speaker is smoking his third cigarette) – see 5.21.3.

Six years have {passed / *been passing} since my accident.

It's two years since I have {spoken / *have been speaking} with him.

“How many times have you {watched / *been watching} that film?” – “I have {watched / *been watching} it four times.”

- (c) There are adverbials that are compatible with the continuative reading only (see 5.9.1). Compare:

The Johnsons *have lived* in London for three years. (*This sentence in principle allows an indefinite reading, an up-to-now reading or a continuative reading. The latter is the preferred interpretation if the sentence is used out of context.*)

The Johnsons *have lived* in London for three years now. (*The presence of now in the adverbial means that the period indicated includes t_0 . The continuative interpretation is therefore enforced.*)

I've *worked* in London since I left home. (*naturally interpreted as continuative, though the other readings are not ruled out*)

Since I left home, I've *worked* in London, Liverpool and Lincoln. (*The continuative and the up-to-now interpretations of I've worked in London are ruled out by the other indications of place, at least if the latter are taken to indicate the consecutive places where I have worked.*)

I've *worked* in London ever since I left home. (*The continuative reading is imposed by the addition of ever to the since-clause.*)

- (d) As noted in 5.9.2, when the situation referred to is a permanent (unalterable, irreversible) state, the present perfect sentence will automatically be interpreted as continuative:

He's been dead for a while. (*The indefinite reading is excluded because an irreversible state of affairs is nonbounded and cannot be interpreted as W-nonbounded. An attempt to cancel the continuative reading by adding but he no longer is leads to unacceptability, at least in the world as we know it.*)

5.32 The up-to-now reading versus the indefinite interpretation

5.32.1 The up-to-now reading implies that the time of the full situation (which is often a hypersituation possibly involving gaps) coincides with the situation time, which is co-extensive with the pre-present. This means that the time of the full situation leads up to t_0 without including it. In this respect the up-to-now reading differs from the indefinite reading, which implies that the pre-present situation time is located at some distance from t_0 . (However, as noted in 5.1.6, if there is no temporal adverbial like *ever*, *before*, *in the past*, etc., this distance is as short as is allowed by the semantics and pragmatics of

the sentence and its context. Thus, *I haven't had breakfast yet* implies 'this morning', not 'in the last week'.)

5.32.2 A point of similarity between the up-to-now reading and the indefinite reading is that they both imply that the situation time coincides with the time of the full situation. A point of dissimilarity is that an indefinite reading is seldom compatible with the progressive form – see 5.25 – whereas an unmarked up-to-now reading normally requires the progressive form (though a quantificational constitution reading forbids using it) – see 5.26–29.

5.32.3 The indefinite reading is the only one possible in present perfect sentences involving adverbs like *ever*, *yet* and *before*:

Have you {helped / ?been helping} your daughter with her homework before?

Have you ever {helped / ?been helping} your daughter with her homework?

Have you {helped / ?been helping} your daughter with her homework yet?

In the absence of such an adverbial, a present perfect sentence may sometimes allow an indefinite reading as well as a quantificational constitution reading. This is the case, for example, in negative sentences involving *never*, such as *I've never seen him*. According to the context in which it is used, such a sentence can receive a different interpretation:

["What can you tell me about the man in this picture?" – "Nothing.] I've never SEEN him. (*indefinite reading*: 'It has not happened yet that I saw the man'; the default location of the nuclear accent is on *seen*.)

["How many times have you seen the man in this picture?"] – "I've NEVER seen him." (*constitution reading*: 'The number of times I have seen the man is zero'. This reading is enforced by the fact that both the question and the reply are specificational sentences – see 5.20.)

The second example can be compared with the following:

["How many times have you seen the man in this picture?"] – "Actually, I've NEVER seen him."

The nuclear accent is again on *never*, but this time the sentence is not used to specify the number of subsituations making up the hypersituation filling the pre-present. Instead, it is used to reject the presupposition 'You have seen the man in this picture at least once' which forms part of the interpretation of *How many times have you seen the man in this picture?*. The interpretation of the reply sentence is therefore an indefinite one: 'Contrary to what you suggest, it has not happened yet that I saw this man'. Because of this, the sentence can involve *before* or *yet*:

["How many times have you seen the man in this picture?"] – "Actually, {I've never seen / I haven't seen} him {yet / before}."

5.32.4 As will be noted in 5.37.5, the use of a present perfect with an indefinite reading may be an indirect way of drawing attention to a present result. Thus, *I've opened the door* can be an indirect way of saying 'The door is open'. A present perfect with a constitution reading is never used in this way (i. e. to draw attention to a present result) because its function is specificational, i. e. it is concerned with the question what value satisfies the variable – see 5.20.1. For example, in *This is the first cigarette I've smoked today* there may be a clear 'message' that the speaker has achieved a longer period than usual (or than assumed) without a cigarette, but it is not really possible to see what *result* of this being the first cigarette he has smoked today is directly implied or implicated by this utterance.

When the up-to-now reading is not a constitution reading but an unmarked up-to-now interpretation, the speaker is clearly concerned with a present result when the sentence is used with an explanatory-resultative function – see 5.18.3. However, the result is not a 'direct result', as in the case of an indefinite perfect, but an 'indirect' one – see 5.37.1.

5.32.5 If a head clause in the present perfect supports a temporal *while*-clause, its interpretation ('up to now' *vs* 'indefinite') can help to determine the choice of tense – present perfect versus past tense – in the *while*-clause.

When the head clause is to receive an up-to-now reading, the *while*-clause (whose situation time then coincides with the situation time of the head clause) must also receive an up-to-now reading and must therefore also be in the present perfect:

Has this house been deserted all the time while I *{have been / *was}* away? (*unmarked up-to-now reading of the head clause situation*)

(Both speaker and hearer enter a room, but from different sides.) What have you been doing while I *{have been / *was}* feeding the chickens? (*nonquantificational constitution reading of the head clause situation*)

This is the third cigarette I have smoked while *{I've been / *I was}* waiting in here. (*quantificational constitution reading of the head clause situation*)

Have all these things been fizzling away in here while we've been at the inquest? [Suppose they'd been all burnt up.] (FFFP)

What's been going on while I've been gone?

When the head clause is to receive an indefinite reading, the *while*-clause can in principle use either the present perfect or the past tense, but there are restrictions on both choices:

Has he ever mentioned his son while he *{was / has been}* talking to you?

Have they ever wrecked the house while their parents *{were / have been}* on holiday?

They've wrecked the house while their parents *{^{??}were / have been}* on holiday.

He has often tossed the ball at me while I *{wasn't / haven't been}* looking.

I've noticed some hair loss while *I've been doing* Atkins [= the Atkins diet]. (www) (*The past tense could not be used.*)

A lot of stuff has changed while you've been gone. (www) (*The past tense could also be used, especially in American English.*)

Reading a few sites on CSS has brought it home to me how much I've forgotten while *I've not been adding* anything to any sites. (www) (*The past tense could not be used.*)

Has anything really embarrassing ever happened to you or anyone while you've been performing? (www) (*The past tense could also be used.*)

The precise rules governing the choice of tense here are not clear, but we notice the following interpretational difference between the tense options in the first example (repeated here):

Has he ever mentioned his son while he *has been* talking to you?

Has he ever mentioned his son while he *was* talking to you?

The first example presupposes that 'he has been talking to you' is true, i.e. that this is not within the scope of the question. The sentence is interpreted as 'During the time(s) that he's been talking to you, has he ever mentioned his son?'. In contrast, in the second example, the question has scope over both clauses: 'Has it ever been the case that he was talking to you and mentioned his son in the course of that conversation?'. As we will see in 9.9, it is only in the latter example that the situation time of the *while*-clause is 'temporally subordinated' (see 2.49) to the situation time of the head clause.

5.32.6 Unlike up-to-now perfects, indefinite perfects are compatible with adverbials denoting an indefinite time in a period leading up to now, without saying anything about the precise location of the situation time in that period. Adverbials like *before, in the past, recently, lately, just* and *this minute* can be used in this way:

[Don't worry.] I have dealt with problems of this kind before.

This has often happened in the past.

This telegram has just arrived.

I have this minute heard that the deal is off.

I have recently met him.

The company has been sold just lately to an engineering firm.

VIII. Factors blocking the location of a situation in a 'period up to now'

5.33 Introduction

The conceptualization of a pre-present period may be excluded by certain semantic or pragmatic elements (in the clause or in its context) which force the speaker / hearer to conceptualize the bygone period in which the situation is to be located as past rather than pre-present. In such cases we cannot use the present perfect, since, in the terminology of our tense model, the meaning (semantic structure) of the present perfect is: 'The situation time is located in the pre-present zone of the present time-sphere'. If it is impossible to conceptualize the bygone period as a 'pre-present zone', there is no possibility of using the present perfect. That is, the present perfect cannot locate a situation time in the past time-zone (which is defined as being separated from, rather than forming part of, the present time-sphere). Conversely, the past tense cannot locate a situation time in a period which is conceived of as pre-present rather than past.

5.34 Reference to entities that no longer exist

5.34.1 When the referent of the subject or of another argument NP is a person who is now dead or something that no longer exists, the situation time is normally located in the past time-sphere, i.e. in a period which is seen as 'completely over at t_0 ' and conceptualized as separated from the present time-sphere:

My late uncle {was / *has been} a commercial traveller.

My late uncle {never lived / *has never lived} in Spain. (*never* = 'never in his life', which is a past period)

King George IV {turned / *has turned} Brighton into a tourist resort.

Brighton {was / *has been} turned into a tourist resort by King George IV.

Keats {died / *has died} in Italy.

{Did you see / Have you seen} our latest exhibition? (*The present perfect is only acceptable if the exhibition is not yet over.*)

My father worked in a bank all his life. (*The past tense implies that my father is now dead or has retired. At any rate, all his life refers to a period which is conceived of as forming part of the past time-sphere.*)

I {played / *have played} tennis with Elvis Presley.

However, there are speakers for whom the idea of an implicit period leading up to now (i.e. a pre-present zone) is not automatically excluded by the fact

that the reference is to 'bygone' people or things. These speakers accept examples like the following under certain conditions.

President Roosevelt has visited our cathedral.

Our cathedral has been visited by President Roosevelt.

For some people these sentences are acceptable, for instance, if the speaker is thinking of the many famous people that have visited the cathedral so far; or if he is discussing the topic 'American presidents and how many of them have visited our cathedral over the years', etc. At any rate, the discourse topic is not President Roosevelt but something else, and the case of President Roosevelt is just brought up as an example. Since this 'something else' (i. e. the discourse topic) implies the idea of a time span leading up to now (e. g. the history of the cathedral up to now), the speaker uses the present perfect.²¹

Speakers who accept the above examples will also distinguish between pairs like the following:

D. H. Lawrence never *lived* in Brighton. (*The speaker is concerned with the situations that Lawrence was (not) involved in in the course of his life, which is a period that is over.*)

D. H. Lawrence *has written* several excellent novels. (*The speaker is concerned with the structure of the world now. The message is that there exist several excellent novels written by D. H. Lawrence.*)

However, for many speakers the present perfect in the latter sentence is unacceptable.

5.34.2 Still, there are a few cases in which the combination of a present perfect with an NP referring to a deceased person is acceptable even for speakers who do not accept sentences like *President Roosevelt has visited our cathedral* or *D. H. Lawrence has written several excellent novels* in isolation.

(a) The first case is when the relevant NP forms part of a list of names that currently exists and is treated as relevant at t_0 :

21. Palmer (1974: 53) finds *President Roosevelt has visited our university* acceptable under the given conditions. However, an informal search of the internet failed to produce any examples of this kind from sources that could be identified as British English. There were, however, several from Am. E. sources. For instance:

(i) Anything which Joseph Conrad *has written* is worth reading! (www)

(ii) Jane Austen has written six major novels: *Emma*, *Mansfield Park*, *Northanger Abbey*, *Persuasion*, *Pride and Prejudice*, and *Sense and Sensibility*. [An overwhelming amount of readers have chosen their favorite Austen novel to be *Pride and Prejudice* in this poll.] (www)

A Google search yielded 193 examples of *Queen Victoria wrote* and none of *Queen Victoria has written*. And there were 237 examples of *Disraeli wrote* and none of *Disraeli has written*, except one by Trollope, presumably written during Disraeli's lifetime.

In recent years our university *has given* an honorary doctorate to Prince Charles, the businessman Jimmy Smith, and the late John Lennon. (*The sentence gives a list of names, which together with in recent years sets up a 'package' – a composite entity which exists now – of people given an honorary doctorate in recent years. Within that package it does not matter whether people are alive or dead. It also does not matter whether the honorary doctorate was given to the late John Lennon while he was still alive or posthumously.*)

Among those to whom our university *has given* an honorary doctorate are Prince Charles, the businessman Jimmy Smith, and John Lennon. (*Note the use of the present tense form are in the head clause, which is consistent with the idea of a current list.*)

This estate *has belonged* to my grandfather, it *has belonged* to my father, it *has belonged* to me, and now it is yours. (*My grandfather and father may well be dead, but they figure on the currently existing list of people who have ever owned the estate in question.*)

All the great thinkers of our time, including Einstein, *have visited* Princeton.

Listed in the Domesday Book, this castle *has been* a Norman stronghold, a royal residence for six of England's medieval queens, a palace of Henry VIII, and a retreat for the powerful and influential. (www: website of Leeds Castle)

[Along with the Single Cube, this is probably the finest surviving room in England from the mid-17th century. A perfect Double Cube, it is 60 feet long by 30 feet wide and 30 feet high. Designed by Inigo Jones as the central feature of his suite of State Rooms] it *has been visited* by virtually every British monarch since Charles I. (www)

- (b) A second type of exception (to the rule that the combination of a present perfect with an NP referring to a deceased person is unacceptable) is illustrated by the following:

Great news! Our university *has awarded* a posthumous honorary doctorate to Martin Luther King!

What distinguishes this from examples like *D.H. Lawrence has written several excellent novels* and *President Roosevelt has visited our university*, which are questionable for some, is that the above example is used to express 'hot news': a recent situation is introduced into the discourse for the first time (see 5.14). For this reason, this sentence is only acceptable because it is understood that the bestowal of the doctorate on the late Martin Luther King is posthumous. Since 'hot news' is linked up with t_0 (both in terms of recency and relevance), it can only be expressed by the present perfect. It is in keeping with this analysis that the following is odd, because it is difficult to assign a hot news interpretation to a sentence beginning with *in recent years*:

??In recent years our university has given an honorary doctorate to Martin Luther King.

The present perfect can more easily be used if there is a constituent in the sentence making it clear that the reference is to a posthumous situation that has present relevance. Compare:

He has bought some flowers for his late grandfather. (*This is fine as long as one has a scenario in mind in which the flowers go on the grandfather's grave and are seen as a tribute to the grandfather despite his being dead.*)

He {bought / *has bought} this book for his late grandfather. (*Unacceptable if we assume that buying a book for someone cannot be interpreted as a posthumous tribute to that person.*)

He {gave / *has given} this book to his late grandfather. (*idem*)

In other words, it is an act of present relevance to buy flowers for a dead person, because the flowers pay tribute to that person, but people do not buy a book for a dead person in order to pay tribute to him.

- (c) A final exception to the rule that the present perfect is not used with reference to people and other entities that no longer exist is illustrated by the following:

(*The speaker is describing an official US document*) [The large, wide-bordered document is attractively printed.] President Roosevelt *has signed* at the lower right, and Cordell Hull *has countersigned* as Secretary of State at the lower left. [There is an intact U.S. seal of white paper, embossed with an eagle, at the lower left.] (www)

Rembrandt has placed the figure of a little girl at the centre of 'The Night Watch'. (*This could be an entry in a guide to Rembrandt's paintings.*)

In these examples the use of the present perfect is similar to the use of the present tense in summaries, captions underneath photographs, etc. – see 3.3.3. The only difference is that the present perfect represents the situation time as (if it were) T-anterior to t_0 (= the time of writing the summary, caption, etc.) rather than as coinciding with it (as in the caption *American policeman arrests illegal immigrant* underneath a photograph).

5.35 Verb of creation + definite 'effected' object NP

5.35.1 The second case in which the idea of an implicit period leading up to now is excluded concerns sentences that contain a 'verb of creation' (expressing the bringing or coming into existence of something) and an 'EFFECTED' NP (i. e. an NP referring to the entity that comes into existence) which is semantically definite in the sense that the existence of the referent is assumed to be known to the hearer.

John {wrote / *has written} this poem. (*verb of creation + definite effected NP*)

John has read this poem. (*no verb of creation*)

Who {built / *has built} this wall? (*verb of creation + definite effected NP*)

Who else has built a wall? (*indefinite effected NP*)

Who has papered this wall? (*no verb of creation*)

Who {discovered / *has discovered} America? (*This sentence refers to the 'creation' and coming into existence of America in a metaphorical sense, in that America did not 'exist' for Europeans until it was discovered by Columbus.*)

The painting over the fireplace {was / *has been} done by my daughter. (*verb of creation + definite effected NP*)

The explanation for this restriction is as follows. An NP with definite reference as a rule implies the existence of a referent that is assumed to be identifiable to the hearer. That is, a speaker using such a (semantically) definite NP considers the current existence of the referent as given (i. e. known or inferable) information. It follows that when he uses a sentence involving a verb of creation he is not concerned with the *fact that* the referent has come into existence and is now part of the structure of the world — (this information) is given. Instead he is concerned with providing new information, i. e. information concerning one of the aspects (when?, how?, who?, etc.) of the situation that led to the existence of the referent — a situation which is necessarily seen as lying entirely in the past and separated from the present. Thus, in sentences like *PETER* built this wall, It was *JOHN* who wrote the novel, *COLUMBUS* discovered America, etc. the focus of interest is on the agent of the action, i. e. the question 'Who did it?'. (This is in keeping with the fact that the nuclear accent each time falls on the name of the agent.) Clearly, the speaker focuses his attention on some past aspect of the situation, on THEN rather than NOW.

Consider also:

My brother {wrote / *has written} that poem. (*verb of creation + definite effected NP*)

My brother {wrote / *has written} that poem in London. (*id.*)

My brother has written an impressive poem. (*indefinite effected NP*)

In the last sentence, the speaker is concerned with the fact that there now exists an impressive poem written by his brother. In the first two examples, by contrast, the existence of the poem referred to is taken for granted (as is clear from the use of the definite object NP *that poem*); the speaker is not concerned here with NOW but with an aspect of the actualization of the situation that happened THEN, viz., in these cases, with the question of who was the agent performing the action or where it was that the action was performed. This **ACTUALIZATION FOCUS** (= focus on the actualization of the situation itself — see 4.7) requires the use of the preterite. The following sentence can be ac-

counted for in a similar way: the focus is not on the current existence of Rome, which is taken for granted, but on the duration of the building activity:

Rome {was not built / *has not been built} in a day. (*This is the passive version of an active clause involving a verb of creation and a definite effected NP.*)

5.35.2 It goes without saying that not every formally definite NP represents information that is assumed ‘given’ (in the sense of ‘already known or inferable’). In some cases a formally definite NP has indefinite reference in that it is used to *introduce* the existence of a new referent, without there being any assumption that the existence of the referent should be known to the hearer prior to the use of the NP. For example:

Please come in. *My stepdaughter* will be here in a moment to take you to the lounge.

It is perfectly possible that the guest does not know that his host has a stepdaughter, and that the host knows that his guest does not know this (e.g. because the guest is a stranger). In this case the formally definite NP *my stepdaughter* is used to introduce the existence of the referent, in other words, the speaker does not assume that the addressee is familiar with the referent or can infer its existence via an ‘inferential bridge’ (as when you first speak of *a book* and then of *the pages*): the existence of the referent is new rather than given information. This use of an NP that is formally definite but semantically indefinite is a conventionalized device to introduce a referent to the addressee. (The same device is used when *this* is used instead of the indefinite article in (informal) examples like the following:)

About five minutes went by, and out of nowhere *this* man comes up to my best friend’s cousin [and says, “Congratulations, Ma’am. You are our 1 millionth customer at Fiddler’s Green this summer.”] (www)

One case in which an NP is thus definite in form but does not express information that is given prior to the use of the NP is when the NP involves a demonstrative that is used literally (= deictically) rather than anaphorically. Such an NP can sometimes be used as object of a sentence in the present perfect even if the verb is a verb of creation. This is because the demonstrative then introduces the referent into the discourse and hence into the hearer’s t_0 -world:

My brother has written this poem! (*This is grammatical, for example, if the speaker is waving a sheet of paper on which a poem is written. In that case, no prior knowledge of the existence of the poem is assumed: its existence is introduced here for the first time.*)

IX. 'Current relevance' and 'present result'

The present perfect tense implies 'current relevance': the bygone situation is considered as being relevant at t_0 . Current relevance is equivalent to 'concern with NOW', which is what distinguishes the present perfect from the preterite (which implies 'concern with THEN'). However, current relevance does not necessarily mean that the speaker is concerned with a present result of the bygone situation.

5.36 The present perfect and current relevance

5.36.1 According to one linguistic tradition, the most important, or even only, semantic difference between the present perfect and the past tense is that the former expresses 'current relevance' (i. e. the bygone situation is still relevant at t_0) while the past tense does not. As noted in 1.21.6 and 2.10.1, this claim then usually leads to the further claim that the present perfect is not a tense but an aspect: 'current relevance' is said to be equivalent to 'perfect aspect'. In 2.10 the claim that there is no such thing as a present perfect tense has been rejected. However, we do subscribe to the view that the present perfect tense implies current relevance. In our opinion, current relevance is equivalent to 'concern with NOW', which is what distinguishes the present perfect from the preterite (which implies 'concern with THEN').

5.36.2 On the other hand, we distance ourselves from those linguists who narrow current relevance down to 'resultativeness', i. e. who claim that what distinguishes the present perfect from the preterite is that only the former represents the bygone situation as having yielded a result which is still holding at t_0 . It will be shown in 5.37 that, except in the 'hot news' use of the perfect, the idea of a present resultant state is only an implicature of the present perfect, which arises in some contexts, but not in others. On some W-interpretations, such as the up-to-now readings, the implicature does not arise at all.

5.37 The present perfect and the idea of present result

5.37.1 It has sometimes been claimed that a sentence in the present perfect is, or at least can be, used to express a present result. This may or may not be correct, depending on the meaning that is assigned to 'present result'. Compare:

I've locked up the shop. (*resultative reading: 'The shop is locked up.'*)

[I've taken a lot of responsibility in my first job already. I've taken the takings to the bank, I've dealt with difficult customers and] I've locked up the shop. (*This does not suggest that the shop is locked up now.*)

Clearly, these examples are different as regards what is meant by ‘present result’. However, it is not possible to state flatly that the first implies a present result and the second does not. What we can say is that the first suggests that the immediate effect on the world produced by the situation of locking up the shop still holds at t_0 , whereas the second does not, but it is difficult to rule out entirely some sort of understanding of present result in the second example, e. g. ‘I am seen as a responsible employee’, ‘I have shown that I am very capable’, etc. These examples show that (as noted in 5.32.4) we must distinguish between ‘direct’ and ‘indirect’ results. A **DIRECT RESULT** is the resultant state that inevitably comes about when a situation is completed: the completion of the action of locking up the shop automatically (and immediately) produces the state of the shop being locked up. (This need not be a lasting result, but it is there immediately after the locking up.) An **INDIRECT RESULT** is not an immediate and automatic result, but one which is linked with the preceding action because the link in question is in keeping with the meaning of the sentence and the context in which it is used. That it is not an inevitable (automatic, natural) result is clear from the second example above, which allows the reading in which the present result is ‘My colleagues consider me over-zealous and therefore dislike me’.

5.37.2 A direct result obtains as soon as the situation producing it is finished. Roughly speaking, and allowing for the fact that what counts as ‘recent’ in one situation may be far from recent in another (compare, for example, recency in connection with the birth and death of stars with recency in connection with locking a door), the chance that the direct result still holds at t_0 decreases according as the lapse of time between the bygone situation and the present becomes greater. This is true irrespective of whether we use the present perfect or the past tense. Thus both *I've just locked the door* and *I locked the door a minute ago* implicate that the door is locked now. However, neither *I have recently locked the door [but YOU never have]* nor *I locked the door a year ago* invite this interpretation, because the distance between the situation and t_0 is sufficiently long for it to be possible (in fact, likely) that the temporary direct result has been undone by the actualization of another situation.

5.37.3 The past tense does not implicate that the direct result produced by the past situation is still holding at t_0 because the past is felt to be separated from the present. Thus, *I locked the door* does not suggest anything that is relevant to the present. However, the same is not true of *I have locked the door*, which locates the situation in a period leading up to t_0 . As we saw in 5.1.2, unless an adverbial or context indicates otherwise, the pre-present is conceptualized as the shortest time span leading up to now that makes sense (i. e. that is in keeping with the semantics and pragmatics of the sentence and its context). This means that in *I have locked the door* the present perfect

implicates recency, which in its turn implicates that the direct result is still holding at t_0 . This explains why *I have locked* the door implicates 'The door is locked', whereas *I locked the door* does not.

5.37.4 Of the three W-types of sentences in the present perfect, only the ones receiving an indefinite reading can implicate a present direct result, and even then the 'experiential use' of the indefinite perfect (see 5.13.1) forms an exception. Thus, none of the following examples implicates the persistence of a *direct result*:

Have you ever been to Japan? (*indefinite reading of the experiential usage type*)

I've been waiting for you for the last ten minutes. (*continuative reading*)

["What have you been doing?"] – "I've been digging the vegetable patch." (*non-quantificational constitution reading; note that, out of context, I've dug the vegetable patch would be interpreted as nonexperiential indefinite and hence as referring to a direct result.*)

Fourteen years have passed since then. (*duration-quantifying constitution reading*)

So far I've had three jobs [and none of them lasted a month]. (*number-quantifying constitution reading*)

5.37.5 The fact that a present perfect sentence yielding an indefinite reading can implicate the persistence of the direct result entails that such a sentence can be used as an indirect way of conveying a message about the present.

A parcel has arrived for Gordon. (*message: 'There is a parcel for Gordon.'*)

He has learnt to type. (*message: 'He can type.'*)

They've cut off the electricity. (*message: 'We don't have any electricity.'*)

I've been to the hairdresser's. (*message: 'My hair is done.'*)

I've finished my homework. (*message: 'My homework is done.'*)

She's been bitten by a goat. (*This implicates that the injury is current, i.e. that it is not healed yet.*) (Compare with *She was bitten by a goat*, which implicates that the injury is healed or in some other way no longer exists – perhaps she is dead – or that even if the injury is not healed it is no longer causing trouble.)

5.37.6 The idea of a direct result is not incompatible with the implicature that there are also indirect results. Thus, the message 'My hair is done' (implicated by *I've been to the hairdresser's*) can be evoked to trigger other interpretations, such as 'My hair looks nice now', 'I don't need to have my hair done for some time', etc. Similarly, saying *I've finished my homework* may be an indirect way of asking 'Can I go out to play now?'. There can even be contexts in which the importance of the present direct result is downgraded in favour of the importance of an indirect present result. For example, *She has closed the door*, whose default implicature is clearly 'The door is closed', can be used in contexts that do not invite the interpretation 'The door is closed' as

a direct result communicated by the utterance. This is the case, e.g. if the door has just been painted. Then the primary result the speaker wants to convey by *She has closed the door* is likely to be ‘The door is probably now stuck to the door-frame (and the new paint will be a mess when we open the door again)’ rather than simply ‘The door is closed’.

5.37.7 In some present perfect sentences there is an idea of indirect result without there being an idea of direct result. Such sentences too can be used as an indirect way of conveying a message about the present:

This gate *has* often *been locked* in the past, but now nobody bothers to do so any more.

This gate *has been locked* in the past, but now nobody bothers to do so any more.

This gate *has* often *been locked*, but now nobody bothers to do so any more.

None of these sentences carries the direct result implicature ‘The gate is now locked’ because that implicature is blocked by *in the past* and/or cancelled by the *but*-clause. However, in a suitable context an indirect result implicature like ‘The sheep may be all over the road’ can arise, in the same way as *I haven’t had breakfast* can implicate ‘I can’t go to work yet.’ Similarly, the sentence

Your boy has fallen off the swing.

can be used to explain the existence of a present indirect result, e.g. that there’s a very loud wailing coming from the direction of the swings, or that several people are currently grouped round the swing, etc. It is not really possible to tell what the direct result is.

5.37.8 It should be clear now that, contrary to what is sometimes claimed in the linguistic literature, the idea of ‘present result’ does not form part of the semantics of the present perfect. (As noted in 2.15.1, the semantics of a tense is the temporal structure it realizes.) It is true, though, that ‘current relevance’ follows from the fact that the situation is located in the pre-present rather than in the past, and that that current relevance meaning is most readily interpreted as result, if that is possible. The latter statement – the present perfect implies a result if the context allows it – means that the idea of a present result is no more than a cancellable implicature of the (indefinite) present perfect. The implicature results from the fact that the choice of the present perfect means that the speaker is concerned with the present relevance of the bygone situation. The idea of present result represents the most salient form of present relevance, and will therefore suggest itself unless there is some contextual or pragmatic factor ruling it out or rendering it unlikely. It is in keeping with this that the implicature of a direct present result arises only when the lapse of time between the bygone situation and the present is relatively short, so that, failing any indication to the contrary, the speaker can assume that the direct result which the bygone situation has produced is still holding.

The 'relative shortness' of the lapse of time between the bygone situation and t_0 may of course be different according to the pragmatics of the sentence and its context which determine the kind of interpretation that is assigned to the sentence involving the indefinite present perfect:

I haven't had breakfast yet. (*The speaker may be referring to a present indirect result: his message may be 'I cannot leave for the office yet; I need to have breakfast first'. This resultative interpretation of the indefinite perfect is partly determined by our pragmatic knowledge that breakfast is eaten every day. If breakfast was eaten, say, once a week, the fact that the speaker has not had breakfast yet today would not necessarily lead to the conclusion that today he cannot leave for the office without having breakfast first.*)

(*doctor to patient*) Have you had a cold? (*This implies a relevant period of only a few weeks, because it is common for a person to have a cold at least once a year and because the effect of a cold does not last longer than a few weeks.*)

(*doctor to patient*) Have you had malaria? (*The question may relate either to a relatively short period leading up to now or to a period which is as long as it is possible for the question to be asked about, namely the addressee's lifetime. In both cases the speaker is considering the possibility of a present result, viz. that the illness might be currently affecting the addressee or might affect the addressee again in the future.*)

(*doctor to patient*) Have you had rubella? (*This is a 'present result' question for which the relevant period of occurrence of the questioned present perfect situation is the addressee's life, since the most obvious interpretation of the question – namely that it is asked in order to ascertain the addressee's current immunity to rubella – involves the assumption that an occurrence at any time in the addressee's life is relevant.*)

All this is in keeping with what was said in 5.1.2, viz. that when the pre-present period remains implicit (unspecified), it is normally interpreted as the shortest time span leading up to now that is in keeping with the semantics and pragmatics of the sentence and its context.

5.37.9 In the previous subsections we have spoken about 'direct' and 'indirect' present results. Let us now have a closer look at the factors determining which of these two kinds of result is implicated on an indefinite perfect interpretation.

- (a) If the situation referred to in the present perfect is represented as telic and bounded, the direct present result which may be communicated by the choice of the indefinite present perfect concerns the state of affairs that comes about when the situation is completed:

I have written a book. (*message: 'There now exists a book of which I am the author.'*)

Ian has shut the window. (*message: 'The window is shut now.'*)

I have learned to drive. (*message: 'I can drive.'*)

This does not mean, however, that the direct result is necessarily the most salient or most relevant present result in the given context (see 5.37.6). Moreover, there are examples of bounded telic sentences in the present perfect where there is no clear idea of direct present result. For example, although *I have written a book* has ‘there exists a book by me’ as direct result (because it has an ‘effected entity’ as direct object), it is not clear what the direct present result is of *I have run a mile*, though this sentence too is telic and bounded.

- (b) If the situation referred to is not represented as telic or/and is not represented as bounded, the idea of a present result can only be suggested by the context or the pragmatics of the situation. In other words, it is not a direct result but an indirect one:

John has been in the cellar. (*atelic*) (*This sentence may, according to context, suggest ‘So he must be dirty’, ‘So he must be cold’, ‘So he must have found out our secret’, etc.*)

I have been writing a book. (*telic but not bounded*) (*This sentence may, according to context, suggest ‘That’s why I am so tired’, ‘That’s why I haven’t been to the pub much recently’, etc. — see also section 5.26.3 above.*)

There is no suggestion of a direct result here. Any resultative reading that may be selected is a context-dependent indirect result reading.

5.37.10 The implicature of a present result does not arise when the bygone situation is explicitly represented as broken off before t_0 and as no longer belonging to the speaker’s world of thinking:

I *have*, until recently, *been* a contributing member to SPLC for several years, and until recently, I *have been* proud of that association. [(...) Unfortunately, the SPLC’s new focus is detracting from our solid reputation, and if it does not change soon, I fear that the damage to an excellent organization will be permanent.] (www)

5.37.11 In a literary (or semi-archaic) register, the verb *go* allows the direct present result to be expressed not only by *have gone* but also by *be gone*:

{Jill has gone / Jill is gone}.

[Today it is fruitless to seek Matthews’s own views on the future,] for he *is gone* from the bungalow and not likely to be back for some time. (www)

Now that Sharon is gone, we’ll have to appoint a new secretary. (*is gone* = ‘*is no longer with us*’)

[Christmas in Panama this year is a season of genuine Thanksgiving.] Noriega is gone. [Things are on the mend and there remains a widespread sense of gratitude to Uncle Sam for making a new start possible.] (COB-S) (= *The Noriega regime is over.*)

It should also be noted that unlike *has gone*, which denotes a movement and implicates a resultant state, *be gone* normally directly denotes a present state

(without referring to a movement producing it). The only normal interpretations are therefore 'be away', 'no longer be at a (contextually given) place', 'have disappeared', or 'be over', 'be dead'. This explains why we cannot say **Jill is gone home* (whereas we can say *Jill has gone home*). In other words, *be gone* normally expresses a pure state, without reference to movement.

DEMO

X. Summary

5.38.1 The semantics of the present perfect – its **core meaning** – is: ‘The situation time is contained in the pre-present zone of the present time-sphere’. This means that the situation time is contained in a period leading up to, but not including, t_0 , in terms of either inclusion or coincidence. The length of the period conceptualized as constituting the pre-present depends on contextual factors, including temporal adverbials, but is always the shortest time required to make sense of the clause concerned in context.

5.38.2 There are two semantic types of present perfect – its **tense interpretations (T-interpretations)** – which arise because of the two possible ways in which a situation time can be contained in a period, namely by inclusion or by coincidence. One T-interpretation arises when the situation time is included in the pre-present and does not include the terminal point of the pre-present. That is, the time of the predicated situation is seen as finishing some time before t_0 . (Thus, although the situation is located in the present time-sphere, it is seen as temporally cut off from t_0 .) The other T-interpretation arises when the situation time is co-extensive with the pre-present. That is, the predicated situation is seen as taking place over an interval that occupies the whole of the pre-present period and reaches right up to (but does not include) t_0 . These two semantic types of the present perfect are called, respectively, the ‘before now’ T-interpretation and the ‘co-extensive’ T-interpretation.

5.38.3 Depending firstly on the T-interpretation that a present perfect receives, and then on many other contextual and pragmatic factors, there are three different ways in which the relation between the time of the *full* situation and the pre-present period can be interpreted. The time of the full situation may be included in the pre-present and lie wholly before t_0 (= the **indefinite W**-reading), it may extend throughout the pre-present and also include t_0 (= the **continuative W**-reading) or it may simply coincide with the pre-present, leading up to, but not including, t_0 (= the **up-to-now W**-reading). This means there are three temporal W-interpretations of the present perfect. (In fact, since W-interpretations only arise by taking into account the full grammatical and contextual information available about a clause in the present perfect, we should, strictly speaking, talk of W-interpretations of present perfect clauses.)

5.38.4 If the T-interpretation is a ‘before now’ interpretation, the time of the full situation usually coincides with the situation time (= the time of the predicated situation). This time is included in the pre-present period and ends some time before t_0 . Even if the time of the full situation is longer than the situation time (because the progressive form is used), the full situation is interpreted as being over before t_0 . The resulting temporal W-interpretation is called the **indef-**

inite reading. This term reflects the fact that the situation time is not anchored to another time: (a) unlike on the other temporal W-interpretations of the present perfect, it is not anchored to t_0 by virtue of including t_0 or being adjacent to t_0 , and (b) the precise location of the situation time in the pre-present must not be specified by an adverbial, e.g. *I have met her* [*last night].

5.38.5 When the T-interpretation of the present perfect is a ‘co-extensive’ interpretation, the time of the predicated situation may either be included in or coincide with the time of the full situation. In the first of these possibilities, the time of the full situation does not only fill the pre-present period but also, necessarily, continues beyond it to include t_0 . (This interpretation has nothing to say about whether or not the full situation extends into the post-present.) This temporal W-interpretation is called the **continuative reading** (e.g. *I’ve been a widow for the last five years*). In the second possibility, in which the situation time coincides with the time of the full situation, the time of the full situation necessarily also extends throughout the pre-present period and up to t_0 , thus including the terminal point of the pre-present (but not t_0). This temporal W-interpretation is called the **up-to-now reading** (e.g. *What have you been doing [since we last met]?*).

5.38.6 Because these three categories of temporal W-interpretation of the present perfect are intended to capture the different ways in which the time of the full situation is interpreted as relating to t_0 (i.e. as wholly before t_0 , as leading up to t_0 and including t_0), we naturally find that there are differences between the three temporal W-interpretations as to their compatibility with certain temporal adverbials. For example, *ever* only occurs with the indefinite interpretation. By contrast, *ever since* or *since childhood* only occurs with the continuative interpretation.

5.38.7 The interpretation of a given present perfect (or more precisely, of a clause with a present perfect verb) as either indefinite, up-to-now or continuative always depends on various grammatical and pragmatic factors. The former include, notably, the effect of time adverbials (as mentioned above) and of the progressive (as will be mentioned below). The latter include, for example, the knowledge that being taller than someone who is already an adult is a more or less permanent condition, so that *He has already been taller than his mother for a year* is necessarily understood to be continuative and not indefinite or up-to-now. Often several factors are simultaneously at work in arriving at a given interpretation of the present perfect (see part VII).

5.38.8 Another important factor in determining the W-interpretation of present perfect clauses is one that lies on the borderline between grammar and pragmatics, namely boundedness. The role of boundedness is evident when we consider the continuative reading. The continuative reading is not possible if

the full situation is bounded (either explicitly or by interpretation in context). This is because the predicated situation, being contained in the pre-present, cannot include t_0 , so that the full situation must be longer than the predicated situation if it is to include t_0 , and such a relation is only possible if the full situation is conceived of as homogeneous, and thus nonbounded. The only exception to this constraint on the continuative reading is when a time adverbial specifies the length of the ‘**factual full situation**’, i. e. the situation as it has actualized up to and including t_0 , thus bounding it, but does not exclude the possibility that in fact the situation will continue beyond t_0 , so that the ‘**potential full situation**’ is nonbounded. For example: *Meg has been talking to the elephant for an hour now.* [*I wonder if the elephant is getting bored.*] In such a case, we still have a continuative interpretation despite the fact that the factual full situation is bounded.

5.38.9 The indefinite perfect has a variety of functional uses which are often identified in the literature. These uses give rise to particular functional readings. We note the **experiential** reading, and the **recency** reading, which includes a ‘**hot news**’ reading. The experiential use typically refers to a bygone situation seen as having relevance as part of the (current) experience, knowledge or history of a person or other entity, for example: *Have you ever made lemon meringue pie?* or *I’ve read most of Raymond Chandler’s novels.* The recency use of the indefinite present perfect is unsurprising, given that the location of the bygone situation time in the present time-sphere emphasizes that the speaker, in talking about the situation, is concerned with NOW, and given that (perhaps because of this) the default temporal location of a present perfect situation is the most recent one that makes sense in the context in question. In Br.E., the recency use of the indefinite perfect is normally signalled by an adverbial such as *just* or *recently*, or by a context which invokes a ‘hot news’ use interpretation, such as *Run! The river has burst its banks.*

5.38.10 As we have mentioned above, when the T-reading of a present perfect is that the situation time occupies the whole of the pre-present, and when the temporal W-reading is that the full situation also leads up to t_0 (and is therefore bounded), we have the ‘up-to-now’ W-reading of the present perfect. In many cases, this reading occurs when the speaker is concerned with the temporal or situational constitution of the pre-present. That is, the utterance or question scans the pre-present, either to quantify the length of time that separates the situation time from t_0 , or to give the number of times that a situation has actualized in the pre-present, or to consider how the pre-present has been filled. We call this ‘pre-present scanning’ function of the up-to-now perfect the **constitution use** and the corresponding reading the **constitution reading**. When the speaker using an up-to-now perfect does not make an assertion about or ask a question about the constitution of the pre-present, we speak of the **unmarked**

up-to-now use, or reading, of the present perfect clause. An example is *Hi! I've been wondering where you were*. The unmarked up-to-now use of the present perfect often has an **explanatory-resultative** function. That is, it is used to give or request an explanation for some result that has come about during the actualization of the situation referred to. E.g. [*I won't shake hands.*] *I've been cleaning out the drains* or *Have you been cleaning out the drains?* [*You smell a little strange.*]

5.38.11 As for the constitution reading of (the up-to-now W-reading) of the present perfect, it has three main functions:

When it is **duration-quantifying**, it refers to a duration-specifying situation which fills, and in doing so describes the length of, the pre-present period. An example is *Three weeks have gone by since your last letter*.

When it is **number-quantifying**, the constitution use of the perfect refers to the number of actualizations of a situation that there have been in the pre-present period. (The number may be zero). For example: *That's the third glass I've broken this week* or [*How often have you taken cocaine?*] *I've never taken it*. (Note that *I've never taken cocaine*, outside the sort of context given, will probably receive an (experiential) indefinite perfect reading, since there is no implication that it specifically provides the number of instances of cocaine taking that have taken place in the pre-present, but rather refers to the non-actualization of a situation in the pre-present.) These two readings are jointly **quantificational** readings of the constitution perfect.

Finally, when the constitution use of the perfect is **nonquantificational**, the speaker looks back on the pre-present and describes or asks what sort of situation(s) has or have filled it. For example, both the perfects in the following example receive nonquantificational constitution use readings:

"What has kept you so long?" – "I've been checking that the windows were all closed."

5.38.12 Figure 5.1 (repeated here) gives an overview of the various readings that can be attributed to a clause in the present perfect.

5.38.13 Constitution readings of the up-to-now present perfect involve what are often referred to as **specificational** sentences. A specificational sentence specifies or asks for a value for a presupposed variable. For example, *It was Meg who gave the elephant John's dinner* presupposes 'someone gave the elephant John's dinner' and specifies the value 'Meg' for the value 'the x who gave the elephant John's dinner'. (Nonspecificational sentences, which are called **predicational** sentences, do not similarly presuppose a 'gap' in knowledge that needs to be filled: *Meg gave the elephant John's dinner* does not, on its unmarked reading, supply a value for a presupposed 'gap' or variable.) All *wh*-questions are specificational, because a question word always represents a vari-

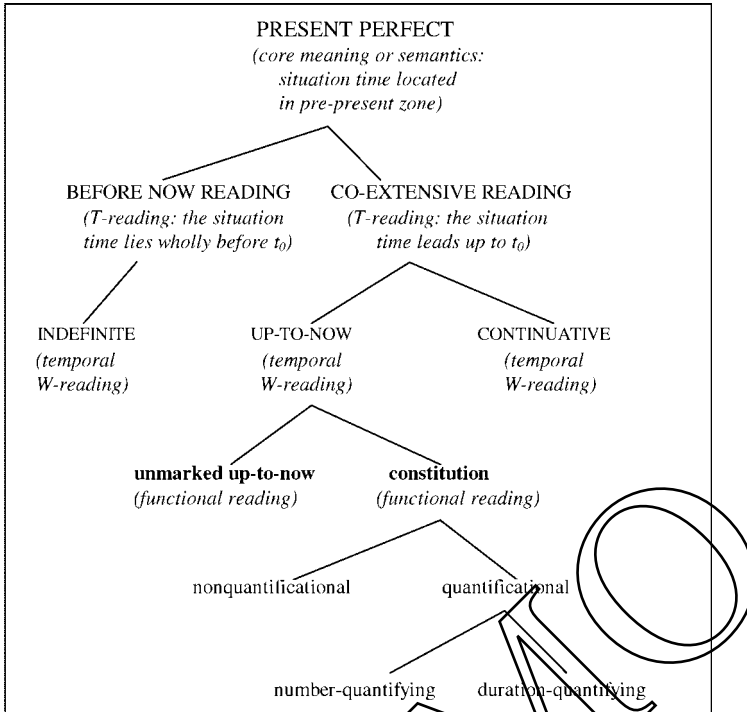

Figure 5.1. The various readings of clauses in the present perfect.

able. Thus, *Who gave the elephant John's dinner?* makes it clear that there is a gap in knowledge concerning the variable 'the x who gave the elephant John's dinner'. All replies to a *wh*-question are similarly specificational: *BILL gave the elephant John's dinner* or *It was Bill who gave the elephant John's dinner* specifies the value 'Bill' for the variable 'the x who gave the elephant John's dinner'.

A present perfect sentence receiving a constitution reading is always specificational. *Shirley has met Tim four times so far*, which yields a 'number-quantifying constitution reading' specifies the value 'four times' for the variable 'the x number of times that Shirley has met Tim'. *Three years have elapsed since then* specifies the value 'three years' for the variable 'the time x that has elapsed since then'. These two readings are 'quantificational constitution readings'. In *What have you been doing? – I've been feeding the elephant*, both sentences receive a nonquantificational constitution reading. The speaker asks the hearer for the situational constitution of the pre-present (which is conceptualized as a very recent period), and the hearer specifies the value 'I've been feeding the elephant' for the variable 'the x that I have been doing'.

5.38.14 On an up-to-now reading, the time of the full situation extends right up to t_0 (without, of course, including t_0). However, this is not to say that the extralinguistic situation to which the speaker refers extends right up to t_0 – rather, it is conceived as doing so. This means, first, that a situation may evidently end shortly before t_0 ‘in reality’ but still be considered as occupying the entire pre-present. For example: *The American president has been in Beijing all day today.* [Now he is on his way to Shanghai.] In a similar way, when the full situation is a hypersituation composed of a number of subsituations, the total of these subsituations is seen as filling the pre-present. The fact that there may be gaps between the subsituations is discounted – the subsituations are conceived of as collectively accounting for the totality of the period up to now. (In addition, of course, it may be that in the extralinguistic world there is a gap between the last subsituation and t_0 , but, as we have just seen, this does not mean that the hypersituation is not considered to extend up to t_0 .) Thus, when a speaker replies to the question *What have you been doing since I last saw you?* by saying: *I've been raising three adopted children and running a small company*, it is clear that other activities have gone on in the extralinguistic pre-present. However, the reported activities are conceived of as filling the pre-present for the purposes of the discourse in question.

5.38.15 The different temporal W-readings of the present perfect – the continuative reading, the indefinite reading and the up-to-now reading – variously affect the possibility of using the progressive, and, conversely, the use of the progressive affects the possibility of arriving at a given reading of the perfect. For example, if a speaker wishes to express continuative meaning, then if the situation is nonstatic (at least in the absence of a continuative-enforcing context such as the adverbial *ever since*), he will normally use the progressive. The progressive means that the full situation is nonbounded and thus, in the case of a ‘co-extensive T-reading’ (i. e. the situation time coincides with the pre-present zone), it (i. e. the full situation) is capable of including t_0 . If the speaker does not use the progressive in a context which permits it, the assumption is likely to be made that he does not want to represent the full situation as (non-bounded and) including t_0 . Conversely, the progressive will normally block an indefinite interpretation of the present perfect because the progressive does not normally combine with boundedness and the full situation on an indefinite reading of the perfect is bounded. Thus *Meg has been washing the elephant* will be interpreted as continuative or up-to-now rather than as indefinite.

5.38.16 Finally, there are two general issues concerning the present perfect that need to concern us. These are, first, that certain elements of meaning exclude the possibility of locating the situation time in a ‘period up to now’, and second, that the notion of ‘present result’ is closely associated with the present perfect, but is not completely straightforward.

5.38.17 The semantics of the present perfect, we have said, is: ‘The situation time is contained in the pre-present zone of the present time-sphere’. The fact that the speaker who uses a present perfect is focusing on NOW rather than THEN means that it is normally presupposed that entities referred to in a present perfect clause exist now. Thus *Marilyn Monroe has read my book* is not normally acceptable (if uttered after her death) because the topic of this sentence relates to THEN rather than to NOW: the present perfect is blocked because the time zone which the speaker has in mind is past rather than pre-present. However, when a no-longer existing entity is not part of the topic of the clause, in the sense that it is not ‘what the speaker is talking about’ but forms part of what the speaker is saying *about* the topic, then for some speakers the present perfect is not excluded, provided it is possible for the speaker to conceptualize a pre-present period. For example: *This hotel has one claim to fame: it has been slept in by Marilyn Monroe.*

5.38.18 Because the present perfect links a bygone situation to t_0 , as relevant to ‘now’, there is usually an assumption that some sort of result of the bygone situation is relevant at t_0 . The result that we can identify may be direct, as in *I’ve locked the door*, which entails that the door was locked after the situation was completed and implicates that the door is locked now or *The tomatoes have ripened*, which implicates that the tomatoes are ripe, but it may also be an indirect result. A **direct result** is the resultant state that inevitably comes about when the situation is completed. Any other result is **indirect**. For example, *The tomatoes have ripened* may implicate the indirect result *It’s time to pick them* or it may implicate *It’s therefore too late to make green tomato chutney*. Only indefinite perfects can implicate clear direct results. Compare *I have bottled the chutney*, which is indefinite, and *I have been bottling chutney since 9 o’clock*, which is continuative. The former implicates the direct result ‘The chutney is bottled’. The latter can be used to refer to such indirect results as ‘The house smells of tomato chutney’ or ‘That’s why I’m tired’, but will not be used to suggest ‘The chutney is bottled now.’

6. The present perfect *vs* the preterite in clauses without temporal adverbials

6.1	Introduction	317
6.2	Actualization focus	319
6.3	The influence of definite noun phrases	320
6.4	The present perfect <i>vs</i> the preterite in <i>wh</i> -questions	322
6.5	The present perfect <i>vs</i> the preterite in <i>when</i> -questions	326
6.6	Summary	330

DEMO

Abstract

Before embarking on a discussion of the fourth absolute tense, viz. the future tense (chapter 7), we provide a brief chapter on the principles guiding the choice between the past tense (or ‘preterite’) and the present perfect, both of which can be used to locate a ‘bygone’ situation in time. Our concern here is with clauses that do not contain a time-specifying adverbial – for the role played by such adverbials in the selection of the one or the other of the two tenses, see chapter 12.

In the present chapter, we first have a look at the central notion of ‘actualization focus’, i. e. the phenomenon that the speaker focuses on one or other aspect of a past situation and therefore has to use the past tense. We then address the use of the preterite vs the indefinite present perfect in clauses with a definite noun phrase and in *wh*-questions other than *when*-questions. Finally, we consider the use of the present perfect yielding a number-quantifying constitution reading in *when*-questions.

DEMO

6.1 Introduction

The speaker is concerned with NOW when he uses the present perfect and with THEN when he uses the preterite. In other words, the present perfect implies that the speaker's 'temporal focus' is on the pre-present time zone, whereas the past tense puts the temporal focus on the past time-sphere. Whether the speaker is concerned with NOW or THEN can be clear from the way the sentence is used in context or from particular constituents of the sentence. In this chapter we will not deal with the impact of particular types of temporal adverbials but will examine the relevance of 'actualization focus' and the impact of definite noun phrases and of question words.

6.1.1 This chapter is about the factors that determine the choice between the past tense and the present perfect when the clause does not contain a temporal adverbial and refers to a 'bygone situation', i. e. a situation that is wholly anterior to t_0 . We will first deal with the past tense versus the 'indefinite perfect' (= the use of the present perfect in clauses receiving an 'indefinite' (see 5.4.1) interpretation), and then – in section 6.5 – with the past tense versus a 'number-quantifying constitution perfect' (see 5.19.1) in *when*-questions. The other readings of the present perfect are not relevant because none of them can appear in a formal environment (without a time-specifying adverbial) in which the past tense can also be used. In other words, while we can contrast *I've seen him* with *I saw him* and *When have I lied to you?* with *When did I lie to you?*, we cannot contrast with past tense clauses such present perfect clauses as receive a 'continuative reading' (see 5.7), an 'unmarked up-to-now reading' (see 5.18), a 'nonquantificational constitution reading' (see 5.19.1) or a 'duration-specifying constitution reading' (see 5.19.1).

For ease of reference, in connection with the present perfect the term 'bygone situation' will only be used to refer to the indefinite reading, except in 6.5, where we discuss the use of *when*-questions receiving a number-quantifying constitution reading.

6.1.2 When, in a noninterrogative clause referring to a bygone situation, there is no time-specifying adverbial, both the preterite (= past tense) and the indefinite present perfect are in principle possible. The preterite is used when we are thinking of the time of actualization of the bygone situation or when we are concerned with the actualization of the situation itself (i. e. with the question of when / where / why / how the situation took place, or who was involved in it – see 4.7.1). The indefinite present perfect (as we will continue to call a present perfect receiving an indefinite interpretation) is used when the speaker

wishes to announce the actualization of the situation as news or when he is otherwise concerned with its current relevance. Compare:

Have you seen 'King Lear'? (*indefinite perfect: 'Have you ever seen 'King Lear'?'*)

Did you see 'King Lear'? (*The speaker is thinking of a particular production of the play, for example, that which was shown on TV the other day. Since he assumes that the addressee understands which production he has in mind, the situation of seeing 'King Lear' is located at a definite bygone time.*)

You can't imagine the difficulties Henry got me into! (*The emphasis is on what happened THEN: that was a very difficult time for me.*)

You can't imagine the difficulties Henry has got me into! (*One interpretation implies that the speaker is currently in difficulties as a result of having been got into difficulties by Henry: 'You can't imagine the difficulties that I am having because of him'. This is an indefinite reading, highlighting the present 'direct result' (see 5.37.1) of a single bygone situation. Another interpretation is that the speaker has, at various times in the past, been in difficulties as a result of having, at indefinite times in the past, been got into difficulties by Henry and that the speaker is currently in some way affected by this experience. For example: 'He's got me into terrible difficulties over the years. [I'm not getting involved in (one of his schemes again).] This is an indefinite interpretation of the 'experiential' kind (see 5.13), which does not suggest a direct present result but refers to the indirect present result that my experience has been widened as a result of various bygone situations.*)

["Have you ever received a reply to any of your letters of application?" – "Yes, I have.] A Canadian firm offered me a job in Toronto, [but I declined because I would rather stay in Britain]." (*The offer has only historical significance. The speaker has already lost interest in it. The form has offered would be difficult to interpret in this context: the present perfect would suggest that the offer is still relevant whilst the ensuing context shows that the offer has been declined and is thus 'out of play'.*)

["Have you ever received a reply to any of your letters of application?" – "Yes, I have.] A Canadian firm has offered me a job in Toronto. [Isn't that splendid?]" (*The speaker is still excited about the offer and clearly intends to accept it. The past tense form offered would not have the implication that the speaker intends to accept the job, though it does not rule out the possibility.*)

The puppy you gave me has grown into a magnificent collie. (*While the present perfect implies (a) that the dog is still alive and (b), given normal world-knowledge, that the speaker still has the dog, the preterite would imply that the dog is in some way no longer on the scene – for example, it is dead, or has been given away.*)

{Did you go / *have you gone} to bed after eleven? (*The speaker has a particular time in mind.*)

6.1.3 The above examples illustrate the basic principles underlying the choice between the preterite and the present perfect which were explained in 2.38.1 and 5.35.1: the speaker is concerned with NOW when he uses the present perfect and with THEN when he uses the preterite. In other words, the present

perfect implies that the speaker's 'temporal focus' (see 11.1.1) is on the pre-present time zone, whereas the past tense puts the temporal focus on the past time-sphere. Whether the speaker is concerned with NOW or THEN can be clear from the way the sentence is used in context or from particular constituents of the sentence. The impact of particular types of temporal adverbials was referred to in 4.6.1 and 5.5.2 and will be discussed in more detail in chapter 12. In the rest of this chapter we will examine the relevance of 'actualization focus' and the impact of definite noun phrases and of question words.

6.2 Actualization focus

When there is 'actualization focus', i. e. concern with some aspect of the bygone situation (such as *where?*, *how?*, *when?*, etc.) we use the past tense. By contrast, to introduce a new topic into the current discourse we use the present perfect.

6.2.1 We normally use the indefinite perfect when a bygone situation that is relevant to the present is referred to for the first time. We do not use it to talk about any aspect of a situation that the hearer is already familiar with. Sentences in which this is done concentrate on the past situation itself (i. e. show 'ACTUALIZATION FOCUS' – see 4.7), and therefore make use of the past tense. (In other words, expressing actualization focus is equivalent to putting the temporal focus on the past situation.)

"Some idiot *has put* diesel in the tank instead of petrol. Which of you *did* that?" – "I *did*."

It follows that the present perfect is often used to introduce a topic into a conversation; the next sentence(s) then use(s) the past tense to give further details about the situation in question.

I *have tried* using that kind of detergent, but the result *was* not satisfactory.

"*Have* you ever *considered* growing roses there?" – "Yes, I *have*. But my wife *decided* against it."

"I've *lived* in China." – "When *was* that?"

I *have drunk* champagne a couple of times, but I *didn't like* it much.

I've *visited* the ESA headquarters. It *was* fascinating.

I've just *moved* your trunk into another room. It *was* surprisingly heavy.

"[I'm giving up my job.]" – "So I've *heard*." – "When *did* you *hear* about it?" – "The milkman *told* me this morning."

6.2.2 In some cases the fact that the situation has actualized is ‘given’ (= assumed known) information because it is obvious from the extralinguistic context. In that case there is actualization focus at once:

You should be glad that you {*were* / **have been*} born rich. (*Self-evidently, it does not make sense to introduce the situation of the addressee having been born: it is given information that whoever exists was born.*)

How {*did you get* / **have you got*} that scar on your cheek? (*The existence of the scar is given information: the speaker can actually see it when uttering this sentence. This means that there is actualization focus at once, in this case on the aspect ‘how?’.*)

In this context we can also refer to section 5.35, where it is pointed out that the present perfect cannot be used if the clause combines a verb of creation with a definite object NP (e.g. *Who {built / *has built} that cottage over there?*).

It may also be noted here that examples like the above ones refute the widespread claim that the preterite requires there to be a definite (= assumed identifiable to the hearer) past time at which the situation is located. This is not to say that it is not true that many past tense sentences are only fully interpretable if the time of actualization is known – for example, there is not much point in saying *The door was closed* without such a temporal ‘anchor’. However, the above examples make it clear that being anchored to a definite time is not an absolute requirement of the preterite, and therefore has nothing to do with the semantics of the preterite. The requirement holds for the *W-interpretation* of most past tense sentences, because the temporal anchor is usually necessary to see the applicability and relevance of the utterance. However, the requirement does not apply to the above examples because identifiability of the exact time of actualization is unnecessary for (and irrelevant to) the correct understanding of the intended interpretation of these sentences. (The same is true if the preterite is used to express a contrast between what is present and what is *W*-bygone, as in *He is no longer the successful painter that he was.*)

6.3 The influence of definite noun phrases

The use of the indefinite perfect is prevented by the presence of a definite NP that entails actualization focus. We therefore have to use the past tense in examples like *How {did Sue get / *has Sue got} the scar on her hip?*

6.3.1 The fact that the hearer is already familiar with the situation is sometimes clear from the use of a definite NP. (Formal definiteness is usually a sign

that the speaker assumes that the hearer can identify the referent of the NP.) This explains why the use of the indefinite perfect is prevented by the presence of a definite NP entailing actualization focus, i. e. by the presence of an NP whose definiteness entails that the situation referred to is interpreted as definite (assumed to be identifiable). (That not all definite NPs have this effect is shown in 6.3.2.) Thus, the past tense is the rule in examples like the following:

How {did Sue get / *has Sue got} the scar on her hip? (*As is clear from the use of the definite NP the scar on her hip, the speaker knows, and assumes that the hearer also knows, that Sue has a scar on her hip. It follows that both also know that there must be a time in the past when Sue got the scar, and that she must have got it in a particular way. The question that is asked concerns that way. This means that there is actualization focus.*)

[He says that] he has witnessed a terrible accident. (*The indefiniteness of the NP a terrible accident reveals that the speaker does not expect the hearer to know about the accident. The accident is mentioned here for the first time, i. e. it is introduced as a topic into the discourse. This means that there is no actualization focus, hence no temporal focus on the past.*)

[He says that] he {witnessed / *has witnessed} the accident that everybody is talking about. (*The relative clause tells the hearer which accident the speaker is referring to. This renders the NP definite: its referent is identifiable. This means that the existence of the accident is presupposed when the speaker makes a statement about it. The speaker therefore uses the past tense to talk about the past accident: there is actualization focus on the fact that the speaker saw the accident happen when it did.*)

[These flowers are lovely.] Who {did you get / *have you got} them from? (*That the referents of these flowers and them are assumed to be identifiable is clear from the use of these definite NPs. That these definite NPs entail actualization focus is in keeping with the fact that the wh-question Who did you get them from? carries the presupposition 'You got these flowers from someone'.)*

[This cake tastes wonderful.] {Did you bake / *have you baked} it yourself?

[I have been to a bullfight once,] but I did not enjoy *it*.

6.3.2 As already said, this does not mean that every definite NP excludes the use of an indefinite present perfect. The only definite NPs that have this effect are those that entail actualization focus, i. e. that make it clear that the speaker is not introducing a bygone situation but is focussing on some past aspect of a bygone situation whose existence is (or is taken to be) given information in the current world of discourse.

I have bought the book that you recommended to me. (*The existence of the referent of the definite NP the book that you recommended to me is given information in the current world of discourse, but the situation of my having bought it is new information.*)

Somebody has drunk out of this glass. [It is dirty.] (*The existence of the referent of this glass is given information in the current world of discourse (since the speaker is pointing at it or showing it), but the situation of somebody having drunk out of it is new information.*)

6.4 The present perfect vs the preterite in *wh*-questions

Wh-questions that do not contain a time-specifying adverbial and which are introduced by a question word other than *when* can in principle use either the past tense or the present perfect to refer to a bygone situation. The choice of tense is determined by whether the speaker is concerned with (i. e. focuses on) THEN or NOW.

6.4.1 As in the rest of this chapter, we will only be concerned here with clauses without a time-specifying adverbial. *Wh*-questions introduced by *when* will not be dealt with here either: they will be treated in section 6.5, where the difference between the past tense and the ‘number-quantifying constitution perfect’ (see 5.19.1) in *when*-questions will be discussed.

6.4.2 *Wh*-questions introduced by *why*, *where*, *who*, *what*, *how*, etc. and not containing a time-specifying adverbial can in principle use either the past tense or the present perfect to refer to a bygone situation. The choice of tense is determined by the usual factors, i. e. by whether the speaker referring to the bygone situation is concerned with (i. e. focuses on) THEN or NOW (see 6.1.3). For example:

How many cars have you sold? (*The present perfect does not yield an indefinite reading but receives a number-quantifying constitution reading. The speaker is concerned with NOW, viz. with such questions as ‘How much profit has our firm made [in an implicit period leading up to now] from selling cars?’ or ‘How much commission do I owe you?, etc.’*)

How many cars did you sell? (*There is actualization focus here on the specific time when the cars were sold. The speaker does not have a period up to now in mind.*)

As is clear from these examples, the concern with THEN or NOW actually reveals itself in the tensed proposition which these sentences presuppose. Thus, *How many cars have you sold?* pragmatically presupposes ‘You have sold *x* cars’ and asks for a specification of a value for the variable *x* (see 5.20.1). In contrast, *How many cars did you sell?* presupposes the truth of ‘You sold *x* cars’, which implies actualization focus on the time of the selling.

The following further illustrate these remarks:

Who broke a glass? (*The speaker assumes that somebody broke a glass. He is concerned with the question who was responsible for this. In other words, the presupposition is 'X broke a glass' and the question asks 'X is who?'*)

Who's broken a glass? (*The speaker assumes that somebody has broken a glass and is concerned with the question who is the person to be held responsible for this. Because of the meaning of the present perfect and the requirements of Grice's Maxim of Relevance, the sentence is only acceptable if the speaker believes that all the people who might turn out to be the person who broke the glass are somehow 'present' and not 'not here'. So, if a bartender utters the sentence after the pub has closed and all the customers are gone, the bartender must be assuming that one of the staff still in the pub broke the glass in question, and not one of the customers.*)

Who broke this glass? (*The speaker assumes that the glass in question was broken. He is concerned with the question who was responsible for this.*) (*As is clear from the grammaticality of Who's broken a glass?, the use of the past tense is not triggered by the definiteness of this glass: this is used because the glass is being shown; it is not through the use of the definite NP that the speaker makes it clear that he assumes familiarity with the fact that someone broke the glass.*)

Who has broken this glass? (*As in the case of Who's broken a glass?, the use of has broken is due to a link with the present: the speaker wants to know which person is to be held responsible for this, i.e. he is concerned with the present relevance of the bygone situation. This sentence too is only acceptable if the speaker believes that all the people who might turn out to be the person who broke the glass are somehow 'present'.*)

Consider also:

Why {did you punish / have you punished} Tom? (*The speaker's focus may be either on THEN or on NOW. In other words, the presupposition may be either 'You punished Tom' or 'You have punished Tom'.*)

Why {haven't you spoken / *didn't you speak} to him yet? (*Yet requires reference to a period leading up to now, which means that the speaker has a pre-present period in mind. In Br.E. this requires the use of the present perfect.*)¹

Why {have you been / were you} waiting for me? (*If the speaker uses the present perfect why have you been waiting, the presupposition 'You have been waiting for me' receives either a continuative or an up-to-now reading. These readings involve the location of the situation in a period leading up to t_0 . This means that they are unavailable if the past tense is used. A speaker who uses the past tense form were waiting has a past vantage time in mind, i.e. a bygone time conceived of as cut off from the present.*)

[And if Lord Douglas is so distressed about the loss incurred by the Scottish service,] why *has* BEA *been* so reluctant to allow any other airlines an opportunity to provide

1. In Am.E. the past tense is acceptable: *Why didn't you speak to him yet?*

service? (LOB) (*The intended interpretation of the presupposition is probably continuative. Anyhow, the speaker does not focus on a specific past time.*)

[The Prince stared at it and said: “The Princess has taken the trouble to wear a tiara.] Why have you not done so?” (LOB) (*The speaker is concerned with the present result of the bygone action of putting on special headgear. The time when it was put on is irrelevant.*)

Why have you come here? (LOB) (*focus on NOW: ‘You’ve come here. Why?’ is interpreted as ‘You’re here. Why?’*)

6.4.3 The following are examples with *how*:

How did John do in Africa? (*This is interpreted as ‘How did John do when he was in Africa?’. It is presupposed that John was in Africa, which implies that he is no longer there.*)

Well, how has he done in Africa himself? (LOB) (*One likely interpretation is that the referent of he is still in Africa (= continuative reading of the presupposition). If the situation is seen as a situation that is just over (= indefinite reading of the presupposition), the speaker may also be concerned with its present result.*)

6.4.4 Examples with *where*:

[Five minutes ago this room was full of people.] Where have they all gone? (*focus on NOW: ‘Where are they now?’*)

[“Where is Mary?” – “She left half an hour ago.”] – “Where did she go?” – [“To her mother’s.”] (*focus on the time when the addressee saw Mary leave*)

However, Br. E. normally uses *Where have you been?* rather than *Where were you?* when addressing a person who has just come back from somewhere. This is a typical example of the use of the present perfect to trigger a ‘nonquantificational constitution reading’ (see 5.19.1).

[I’ve been waiting for over an hour, cruising around on my own in the car, then I knew you must return sometime.] Where have you been? (LOB)

Compare:

Where have you been? (*presupposes ‘You haven’t been here.’, ‘You’ve been somewhere else.’*)

Where did you go? (*presupposes ‘You went somewhere.’*)

Although *Where have you been?* need not at all imply that the speaker feels negatively about the absence, *if* the speaker is annoyed or has been worried by the absence, then *Where have you been?* is more likely than *Where did you go?*

6.4.5 The following are examples with *what* illustrating how both the preterite and the present perfect can be found in direct and indirect *what*-questions, depending on the usual factors determining the choice between these tenses. In

all the examples that choice is in keeping with whether the speaker is concerned with THEN or NOW:

[There a UNO army of Africans, bossed by an Indian, has been in charge for months.] And what *has it made* of the Congo? (LOB) (= *What's the present state of the Congo resulting from that UNO action?*)

Your statement that the German people knew what *happened* to the Jews is wrong. (LOB) (*Both knew and happened locate their situation at a time which is seen as cut off from the present.*)

Certainly [the film] 'A bout de Souffle' is extremely exciting, especially if you can forget what *has come* since. (LOB) (*The present perfect is obligatory because since refers to a period leading up to now and has come refers to a hypersituation filling this period.*)

I now turn to the question of overspill, in respect of which it is very difficult to discover what *has been happening*. (LOB) (*The presupposition 'Something has been happening' is intended to be interpreted as continuative.*)

Dr Edgar H. Schein's article 'The Chinese Indoctrination Process for Prisoners of War' gives a generalized picture of what *happened* to the average soldier from capture to repatriation. (LOB) (*focus on what happened (THEN)*)

The reader is now in possession of all the facts needed to determine what *has happened* to the aliens, [and I hope not to be pointing out the obvious if I explain that the clue is in the apparent speeding-up of their television broadcasts.] (LOB) (*There is current relevance here. The present perfect functions as the perfect of a narrative present. That is, the point that the narrative has reached is identified with the reader's 'now' in order to place the reader inside the story, and the present perfect thus invites the reader to locate the aliens' experience in the period leading up to 'now', rather than, as the preterite would indicate, locating their experience in the past time-sphere, separate from the reader's here and now.*)

[The proceedings opened with Colleano's giving me a summary of the case. From our point of view this was mere camouflage;] but it is necessary to repeat it here for the purpose of clarifying what *happened* subsequently. (LOB) (*The past tense has to be used because of the presence of the time-specifying adverb subsequently, which refers to a past time.*)

[Do come and sit down, Celia.] And what *have you done* with your friend? (LOB) (*present relevance*)

In some cases there does not seem to be an obvious reason why the speaker chooses a past or pre-present focus:

[It is now five years since his first play, 'The Quare Fellow', was produced, three years since 'Borstal Boy' was published and 'The Hostage' was put on.] What *has happened* to the play, 'Richard's Cork Leg', begun 18 months ago and due for presentation at the Theatre Royal, Stratford, last spring? It was never finished. What *happened* to the new book partially tape-recorded by his publishers in March of last year? (LOB)

6.5 The present perfect vs the preterite in *when*-questions

6.5.1 As noted in 4.6.2, *when*-questions referring to a single bygone situation cannot make use of an indefinite present perfect:

When {did she leave / *has she left}? (*direct question*)

I wonder when the accident {happened / *has happened}. (*indirect question*)

The reason for the obligatory use of the preterite is that the use of *when?* with reference to a single given situation reveals that the speaker is not concerned with NOW but with THEN. *When?* asks for the identification of the time of actualization of a particular situation whose actualization is presupposed. (Thus, *When did John hit Jane?* carries the presupposition ‘John hit Jane’.) Since NOW is a time that is by definition given, *when?* presupposes that the time asked for is not the present. The use of *when?* in a clause referring to a single bygone situation thus automatically means that there is actualization focus, hence that the temporal focus is on the past time of actualization of the bygone situation. In other words, *When?* is incompatible with an indefinite perfect. (In fact, the very reason why we speak of ‘indefinite perfect’ is that the time of actualization remains indefinite and that the speaker is not concerned with it.)

6.5.2 On the other hand, we use the present perfect, not the preterite, in sentences like the following, in which the present perfect is the perfect version of the ‘timeless’ (or rather, omnitemporal) use of the present tense:

When *have* I *done* enough? [When I have worked seven hours, seven and a half, eight ...?] (www)

When *have* you *achieved* “rapport”? [When you model and the customer follows, you have achieved a high degree of “rapport”.] (www)

[One of the dilemmas facing a prospective buyer involves the number of homes that should be seen before making a final buying decision. Some people are not content until they have seen every home on the market in their price range.] How do you know when you *have seen* enough homes in order to make an offer on a certain home with the confidence that it is the right one for you? (www)

When *have* I *mastered* the clarinet? (www)

In every case the meaning of the *when*-question is something like ‘At what point on its progress along a scale of increasing approximation to Y does X count as Y?’

6.5.3 There is another use of *when* that goes with the present perfect. In this use, which involves the number-quantifying constitution type of present perfect, the speaker asks the addressee to look back over the pre-present – usually the question is in the second person and the pre-present is the period of the

addressee's life – and asks for the/an occasion or occasions on which a situation has actualized. These *when*-questions do not ask for temporal locations but for instances of experience in a period up to now. Usually they seem to ask too what characterized the 'occasion' or context of the situation. A typical context for such *when*-questions is a list of questions about one individual's experiences. In other cases, though, the speaker is interested in one particular situation-type (experience) and how that situation-type has been experienced by various people – see the last two of the following examples.

[What makes you happy? In looking over your life, where and] *when have you been* the happiest? [Where were you, and what were you doing?] (www)

[Another area to explore is the expert's past history as a witness.] *Where and when has she testified*, and how often? [Has it been more for plaintiffs or the defence? (...) Has he ever served the opponent before, or been represented by that firm?] (www)

When *have you* successfully *executed* a project within a tight time-frame and with a limited budget?

[Do I enjoy making decisions? What steps do I take when making decisions? Do I have leadership potential?] *When have I demonstrated this potential?* [What are some examples of my ability to motivate others? Do I enjoy making decisions that affect other people?] *When have I done this* and what were the results? (www)

When have you found yourself losing the sense of God's presence in prayer? [Have you found out why? What was the lesson you learned, if any? (...)] When have you most felt that you had lost touch with God? *When have you felt most intimate with God?* [How have these moments affected your prayers?] (www)

When *have you been asked* to produce your birth certificate for ANY purpose? (www)

When *have you experienced* Stendhal syndrome? [Or rather, to what piece of art or music? (...)] When *have you felt* like your entire existence was swallowed by something you either looked into or listened to? [How, exactly did you feel it happen?] (www)

Occasionally the past tense can be found in *when*-questions of this type:

[What motivates you? Make four lists:] When *were* you happiest? When *were* you unhappiest? When *did* you *feel* successful? When *did* you *feel* unsuccessful? (www)

[The following exercise may help you to recognize what personal strengths make you more self-responsible. First answer the following questions by writing down a key word or phrase that will help you to remember specific situations.] When *did* you *resist* buying something under pressure? When *have you disagreed* with something in a discussion or argument, [or when you were on a committee, even though there was pressure to conform?] When *have you rejected* a drink, drug, or food when you felt pressure to take it, but you really didn't want it? When *did* you successfully *resist* manipulation to do something that you really didn't want to do? [In each case, there was probably some characteristic of your personality that led to your choice.] (www) (*In this stretch of discourse the speaker apparently does not*

distinguish between the present perfect and the past tense in when-clauses inquiring about someone's experience.)

Such *when*-questions in the preterite most often follow one or more clauses in the preterite:

[It does not matter] when, who you *were working* for, what you *were doing*, etc. When *were* you happiest? [Think of all of the elements that made you happy.] (www)

[Consider opportunities you *had* to respond to God's love.] When *were* you successful? When *did* you *miss* opportunities? (www)

How *did* you *create* that opportunity? When *were* you successful in selling a concept to people who initially opposed you? How *did* you *convince* them? (www)

In these examples the *when*-question each time concerns one or more bygone occasions which have already been referred to in the past tense. It is natural that the past tense should be used in such a *when*-question.

However, the kind of *when*-question treated in this section (6.5.3) only allows the past tense if the speaker presupposes actualization of the situation of which instances are sought. Thus, in the last examples the past tense is possible because, although the *when*-question looks for instances rather than precise times of presupposed situations, it can be taken for granted that there has been a time which fits the description 'the time when you were happiest' or 'the time when you were successful'. If this condition is not satisfied, the past tense is hardly acceptable. This is the case in the following example, which hardly allows the idea that actualization is presupposed of the situation of which instances are sought:

[Another area to explore is the expert's past history as a witness.] ??Where and when *did* she *testify*, and how often?

This is clearly odd in the context of the original example (given above), namely guidance for the treatment of experts in general in court cases, because it is unlikely that one can presuppose that every possible expert will already have testified at some time. (Note that *the expert* does not refer to a specific expert: the speaker is talking of experts in general.)

The second reason why the past tense is odd in the above example is that the speaker's concern is with present experience rather than past actualization. In fact, the latter factor is sufficient in itself, as appears from the following example, in which the second clause makes it clear that the speaker does assume that all his addressees have experienced Stendhal syndrome:

When {*have* YOU *experienced* / ??*did* YOU *experience*} Stendhal syndrome? [Or rather, to what piece of art or music?] (...) When {*have* you *felt* / ??*did* you *feel*} like your entire existence was swallowed by something you either looked into or listened to? [How, exactly did you feel it happen?] (www)

6.5.4 In the previous section we have seen that if the speaker of a *when*-question is asking about the time of actualization of a bygone situation, the fact of actualization of the situation is taken for granted, and it is the past tense that is used:

When {*did you mislay* / **have you mislaid*} all the butter that I bought yesterday?

However, there are cases in which a *when*-question asks the addressee to supply an occasion or occasions on which a situation has actualized, rather than asking for the temporal location of the actualization of a situation (which is thus presupposed to have actualized). In these cases, the present perfect (with number-quantifying constitution interpretation) can be used. Typically, such *when*-questions are rhetorical and are used to imply that no occasion of actualization of the situation referred to exists. For example:

[Sixty-seven minutes – hell’s bells.] When *have* I ever *spent* more than an hour in front of one picture in a gallery?

[You wouldn’t think it was so much to ask after all this time, would you Alfred?] When *have* I *asked* anything from him? (www)

[Batman has everything known to man inside his utility belt.] When *has* he ever *been* in a situation where his utility belt was not able to save him? (www)

Such *when*-questions in the present perfect can be used to challenge an explicit or implicit assumption on the part of the addressee or someone else (including the speaker). Thus the speakers of the following challenge the implicit assumption that they would possibly lie:

["Ask me a question and I’ll answer it; it’s as simple as that." – "But I won’t know if you’re telling the truth."] – "And when *have* I *lied* to you?" (www)

["You snapped up the cutest guy in school before the rest of us even saw him!" Jean blushed. "Really?" Ororo rolled her eyes.] "When *have* I ever *lied* to you?" – ["Never." – "There, then."] (www)

The message is: ‘Your suspicion implies that it’s possible that I would lie to you, but that belief is unreasonable since you have no experience of my having lied on past occasions.’ Similarly, the speaker of

[Whew! I ain’t seen this stuff before, either, so I take no responsibility for what it says] (but then when *have* I ever *taken* responsibility for anything?). (www)

rejects the implication of his own utterance: normally refusing to do something implies that it is possible in theory that one would or could do that thing. The speaker rejects this implication of ‘I could take responsibility for what it says’ by pointing out that there is no evidence that such responsibility-taking has ever occurred, so it is not reasonable to assume that there was ever a chance that he *would* take responsibility.

["Can I go over to the island?" – "You don't need my permission to go over to the island.] When *have* I ever *stopped* you?" (adapted from www)

The past tense too can sometimes be found in such examples:

["But mum ... I'm not lying! She's the one that's lying!" – "Just go to bed, won't you? I'm too angry to deal with you." – "You're an idiot!"] When *did* I ever *lie* to you!" (www)

[I have problems managing stress, that's true, but] when *did* I ever *ask* him to handle my problems? (www)

[Sixty-seven minutes – hell's bells.] When *did* I ever *spend* more than an hour in front of one picture in a gallery? [Previous personal best was probably 0.6 minutes in front of a Vermeer in the Rijksmuseum in Amsterdam during Euro 2000.] (www) (*Despite the follow-up to the question, the question should still be taken to mean 'I've never spent more than an hour in front of one picture', because the follow-up does not so much answer the question as back up the assertion 'I've never spent long in front of one picture'.*)

It should be noted, finally, that, although the speaker of these *when*-questions (in the present perfect or past tense) clearly believes in each case that the answer to the question is 'never', the utterance is still not equivalent to an assertion that the situation referred to has never taken place. Thus it is not impossible for the question to be treated by the hearer and/or the speaker as (to some extent, at least) a genuine challenge to cite instances of actualizations of the situation referred to:

["Do you believe John Kerry voted for this war?" – "Yes I do."] – "When *has* he ever *said* he voted for the war? [Told me the interview. I want to look it up." – "I don't know exactly – well, go to gop.com. There's about – there's 11 minutes of different interviews." – "He never says he voted for the war." – "Well, I'm not saying in that interview, but I'm saying in some." – "Which one?" – "Oh, I don't know. I don't have that in front of me." – "OK. I don't think he ever said it. But anyway, we'll look ... I will continue my search ..."] (www)

["He has never ever said that he wanted to cut pensions or cut child benefit or cut the benefits that go to disabled people. He has never said that." – "He did actually, according to this quote."] – "When *did* he ever *say* that he was going to cut benefits?" – ["It has been pointed out to me that in *Newsweek* of 7 October 1996 he said 'Our priorities should be to re-order public spending so that we are spending less on welfare and more on areas like education.'"] (www)

6.6 Summary

6.6.1 In order to locate a situation time entirely before t_0 , the speaker has the choice, as far as time reference is concerned, between a past tense form and an indefinite present perfect. The present perfect is used when the speaker is con-

cerned with the relevance of the bygone situation to the present. As we have seen in chapter 4, the past tense is used when there is focus on the actualization of the bygone situation itself. (That is, focus on the actualization as a whole or on some aspect of it, such as when or how the situation took place).

The indefinite present perfect is used to introduce a bygone situation that is relevant to the present, but once a situation can be treated as ‘given’ in the discourse, reference to it involves actualization focus, and it is the past tense that is used. For example, *I’ve just seen Meg. She was washing an elephant.* Sometimes a situation can be treated as given because it is implied by the (linguistic or extralinguistic) context, rather than because it has been explicitly introduced. Here, too, the present perfect is not appropriate. For example, in *How did you get that scar on your cheek?* the existence of the scar is presupposed, which means, given our world knowledge, that we can assume that the hearer *got* the scar at some time in the past. The actualization of a bygone situation of getting the scar is ‘given’, and the present perfect cannot be substituted for the past tense.

6.6.2 In most *wh*-questions, the speaker has the choice, in principle, between using the past tense and using the present perfect, depending on whether the focus is on THEN or NOW. For example, in the first example below, the speaker focuses on the past activity of putting the butter somewhere; he may not even want to know where it is now. In the second example the focus is on the present – the same activity is the subject of the question, but the speaker is looking for a response that will tell him where the butter is now.

Where *did* you *put* the butter?

Where *have* you *put* the butter?

6.6.3 However, one sort of *wh*-question, namely *when*-questions, is more restricted. If the speaker of a *when*-question is asking about the time of actualization of a bygone situation, the fact of actualization of the situation is taken for granted, and it is the past tense that is used:

When {*did* you *mislaid* / **have* you *mislaid*} all the butter that I bought yesterday?

However, there are cases in which a *when*-question asks the addressee to supply an occasion or occasions on which a situation has actualized, rather than asking for the temporal location of the actualization of a situation (which is thus presupposed to have actualized). In these cases, the present perfect may be used, but with a number-quantifying constitution meaning rather than with an indefinite one.

[What makes you happy? In looking over your life, where and] when *have* you *been* the happiest? [Where were you, and what were you doing?] (www)

When *have* you successfully *executed* a project within a tight time-frame and with a limited budget?

The past tense can often be used in such examples, too, but not when it is unacceptable to presuppose the actualization of a specific instance or specific instances of the sort of situation referred to. For example, in a discussion of the use of experts in general (and not of any particular expert), we find:

[Another area to explore is the expert's past history as a witness.] *Where and when has she testified*, and how often? [Has it been more for plaintiffs or the defence? (...)
Has he ever served the opponent before, or been represented by that firm?] (www)

To substitute the past tense here, as in:

Another area to explore is the expert's past history as a witness. *Where and when did she testify*, and how often?

would be to presuppose that the situation of the expert testifying has actualized at some time in the past. This would significantly change the interpretation of the sentence, since *Where and when has she testified?* leaves open the possibility that the witness in question has actually never testified before. (This is inherent in the meaning of an indefinite perfect.) The presupposition (inherent in the past tense) that she *has* done so is not easily acceptable, since the NP 'the expert' is a generic NP, which refers to witnesses in general. In the world as we know it, many people that are called as witness have never been in the witness box before. The presupposition accompanying the past tense thus runs counter to our pragmatic knowledge of the world.

6.6.4 *When*-questions with a number-quantifying constitution perfect are often rhetorical and are used to imply that no occasion of actualization of the situation referred to exists. For example:

[Sixty-seven minutes – hell's bells.] *When have I ever spent* more than an hour in front of one picture in a gallery?

Such *when*-questions in the present perfect can be used to challenge an explicit or implicit assumption on the part of the addressee or someone else (including the speaker). Thus the speaker of the following challenges the implicit assumption that he would possibly lie:

["Ask me a question and I'll answer it; it's as simple as that." – "But I won't know if you're telling the truth."] – "And when *have I lied* to you?"

The message is: 'Your suspicion implies that it's possible that I would lie to you, but that belief is unreasonable since you have no experience of my having lied on past occasions.' Similarly, the speaker of

[Whew! I ain't seen this stuff before, either, so I take no responsibility for what it says] (but then when *have I ever taken* responsibility for anything?). (www)

rejects the implication of his own utterance: normally refusing to do something implies that it is possible in theory that one would or could do that thing. The

speaker rejects this implication of 'I can take responsibility for what it says' by pointing out that there is no evidence that such responsibility-taking has ever occurred, so it is not reasonable to assume that there was ever a chance that he *would* take responsibility.

DEMO

DEMO

7. Absolute tense forms referring to the post-present

I.	'Future tense' forms vs 'futurish' forms	337
7.1	Definition of 'future tense'	337
7.2	Dual time conceptualization in sentences referring to the post-present	338
7.3	'Futurish' tense forms	338
7.4	Modal implication: not-yet-factual-at- t_0	340
7.5	The distribution of <i>shall</i> and <i>will</i> in the future tense	340
7.6	The various meanings of <i>shall</i> and <i>will</i>	341
7.7	The progressive future tense (without progressive meaning)	344
II.	Remarks on <i>be going to</i>	345
7.8	' <i>Be going to</i> + infinitive': futurish form or future tense form	345
7.9	' <i>Be going to</i> + infinitive' as futurish form: general meaning	346
7.10	<i>Be going to</i> expressing a present intention	346
7.11	<i>Be going to</i> expressing present predictability of a post-present actualization	350
7.12	A special use of <i>be going to</i> in <i>if</i> -clauses	352
7.13	Constraints on the use of <i>be going to</i>	352
III.	Futurish forms other than <i>be going to</i>	356
7.14	<i>Be about to</i> and <i>be on the point of</i>	356
7.15	The auxiliary <i>be to</i>	356
7.16	The present tense	357
IV.	Summary	358

DEMO

Abstract

In the preceding four chapters, we dealt with the meanings and uses of three absolute tenses (= tenses that relate a situation time directly to the temporal zero-point), viz. the present tense, the past tense (or preterite) and the present perfect, and with some principles underlying the choice between the preterite and the present perfect. In this chapter, we examine the fourth absolute tense, viz. the future tense. We also consider other verb forms that have an element of future time reference as part of their semantics.

In section I (7.1–7.6) we first deal with the distinction between ‘future tense’ forms and what we call ‘futurish’ forms, the latter of which do not express pure future and combine future time reference with present time reference.

Section II (7.7–7.12) provides some comments on *be going to*, which wavers between a futurish auxiliary and a future tense auxiliary, depending on whether it expresses the idea that a future situation is predictable because of present indications (e.g. *My little girl is going to be very clever*) or whether it is a more neutral means of referring to the future (e.g. *It’s going to rain tomorrow*). This section also deals, among other things, with the use of *be going to* to express a present intention (e.g. *Cheryl is going to marry Gordon when she has graduated*).

Section III discusses some further futurish forms, including (among others) ‘*will + be Verb-ing*’ (used without progressive meaning), the auxiliary *be about to*, and the auxiliary *be to*.

DEMO

I. 'Future tense' forms vs 'futurish' forms

7.1 Definition of 'future tense'

The future tense locates a situation time in the post-present and normally expresses 'pure future'. 'Futurish forms' are not future tense forms and do not express pure future.

7.1.1 The **FUTURE TENSE** refers to the post-present in the sense that it locates a situation time (= the time of a 'predicated' situation – see 2.12–13) in the post-present zone of the present time-sphere. In English, future tense forms are not built by means of a special suffix but by means of the present tense of one of the auxiliaries *will* or *shall* (the latter in the first person only) or of the semi-auxiliary *be going to* (which, however, can also be used as a 'futurish form' – see 2.9 and 7.8–9). For example:

According to the weather forecast it {will / is going to} rain tomorrow.
We {shall / will} all die – one day.

It is typical of the future tense that the speaker merely makes a prediction, i. e. he just expresses what he thinks will happen in the post-present. In the literature this is known as the expression of '**PURE FUTURE**'.

7.1.2 '**FUTURISH FORMS**' (see 2.9 and 7.3) are not future tense forms. For one thing, they do not express pure future. For another, they combine reference to a post-present actualization with a sense of present judgement. Moreover, some of them (viz. progressive and nonprogressive present tense forms) basically refer to the present. Their use as a futurish form is a metaphorical extension of this (i. e. a 'shift of temporal perspective' – see 2.20): the post-present is treated as if it were the present. For example:

I'm leaving. (*The reference is to a situation which is either actualizing at t_0 or arranged to actualize in the post-present. The latter interpretation is an example of how a post-present situation is represented as if it were actualizing at t_0 . This interpretation is marked in that it requires a contextual or pragmatic indication that the reference is not to the present.*)

[I've bought some paint because] I'm going to redecorate my bedroom. (*The reference is to a post-present actualization based on a present intention.*)

7.2 Dual time conceptualization in sentences referring to the post-present

In 6.1.2 we noticed that the difference between the ‘indefinite present perfect’ and the past tense is that the speaker is concerned with NOW and THEN, respectively. This means that there is a dual time conceptualization in the meaning of the indefinite present perfect: while referring to a bygone situation, the speaker is actually thinking of the present. This dual time conceptualization can actually become dual time reference, when both times are specified by different Adv-times, as in *Now we have sold forty-three cakes since the fair started*. There can also be dual time reference when the future tense is used in combination with a present time adverbial, witness examples like *Now we won't have any wine when Uncle Grégoire arrives*. In this example *now* refers to a present state of affairs and is equivalent to something like ‘Now that X has happened ...’. (This is a different kind of *now* from the one in *Now we have sold forty-three cakes since ...*. This explains why we can also say *We have now sold forty-three cakes since ...*, but hardly *?We won't now have any wine when ...*. However, the two examples do illustrate a kind of dual time reference.)

When there is no time-specifying adverbial referring to the present, the sense of present time reference in sentences in the future tense is restricted to the idea that the speaker makes a prediction at t_0 ; he just expresses what he thinks will happen in the post-present. The temporal focus of the future tense is then clearly on the post-present time of actualization rather than on t_0 . This means that we can no longer speak of dual time reference.

7.3 ‘Futurish’ tense forms

In *Meg {is leaving / is going to leave / is to leave / leaves} tomorrow*, a ‘futurish’ tense form is used. Such forms differ from future tense forms in that they effect dual time reference, viz. a combination of future time reference and present time reference. *Be going to* can be used to build such a futurish tense form, but it may also form part of a future tense form. In the latter case it refers exclusively to the post-present, just like the future tense auxiliary *will*.

7.3.1 As noted in 7.1.2, apart from the future tense, there are other expressions referring to the possible actualization of a situation in the post-present. However, they differ from the future tense in that, even in the absence of future time adverbials, they effect dual time reference, viz. a combination of future

time reference and present time reference – see 7.2. In fact, the idea of present time reference is at least as salient as the idea of post-present actualization:

The train leaves at 7.12 tonight. (*reference to present scheduling*)

I'm seeing her tomorrow. (*reference to a present arrangement, intention, programme...*)

I'm going to give up my job. (*reference to a present intention*)

In examples like the following, the element of present time reference is even more salient:

The President is to visit Rome next week. (= *There exists a present arrangement for the President to visit Rome next week.*)

[Look out!] The milk is about to boil over. (*The speaker is referring to the present state of the milk, which forebodes boiling over.*)

Bill is on the point of having a nervous breakdown. (*The speaker is referring to Bill's present state of mind, which forebodes a nervous breakdown.*)

However, there is a clear sense of post-present actualization in all of the above examples, which is sufficient for them to establish a post-present temporal domain' (see 2.15.4). The 'central orientation time' of this domain is the time of actualization of the situation referred to by the predicate whose verb form is *leaves*, *am seeing*, *give up*, *visit*, *boil over* and *having*, respectively. For ease of reference, we will refer to the complete verb forms (e.g. *am going to give up*) as 'FUTURISH FORMS'. As we will see in 10.1, a post-present temporal domain established by a futurish form is expanded in exactly the same way as a post-present domain created by a future tense form.

7.3.2 The futurish auxiliary *be going to* is a borderline case as far as dual time reference is concerned. In most cases the speaker's main concern is with the present cause or origin of the post-present actualization of a situation. For example:

My little girl is going to be very clever. (= *'There are present indications that my little girl will turn out to be clever.'*)

[This is so important that] I'm going to do it myself. (*emphasis on my present intention*)

However, there are also examples in which the post-present time of actualization is much more salient than the present (e.g. *It is going to rain tomorrow*), in which case the difference between *be going to* and *will* is less pronounced: whereas the latter expresses a prediction, *be going to* seems to be a means of talking about the future in a neutral way. Compare:

It will rain tomorrow. (*present prediction about the post-present: sort of prophesy*)

It's going to rain tomorrow. (*either a prediction based on present evidence or a neutral statement about the post-present*)

It is going to rain soon. [I just know it. Not predictive weather skills, just long, damp experience.] (www) (*relatively neutral statement about the post-present*)

There is hardly any difference of meaning between the following, because of the question format:

What'll happen next?

What's going to happen next? Are those men going to kill us?

Both questions treat the addressee as somehow knowing something about the future that the speaker does not know. The prediction element of *will* is not salient and so does not have much semantic weight here. *Be going to* does not have the connotation that characterizes it as a futurish form, viz. the idea that the post-present actualization depends on a present intention or otherwise has its roots in the present. So both *will* and *be going to* refer to the post-present in a neutral way. In this case *be going to* is no longer a futurish form with dual time reference but can be considered as an alternative to *will*, i. e. as a future tense auxiliary.

7.3.3 The distribution of the future tense and the various futurish forms (with their typical connotations) will be discussed in 7.7–16 below.

7.4 Modal implication: not-yet-factual-at- t_0

Any sentence referring to the post-present is modalized because it refers to something that is 'not-yet-factual' at t_0 .

A situation whose actualization is located in the post-present is '**NOT-YET-FACTUAL-AT- t_0** ': the actualization is not yet a fact at t_0 , and has not even started to become a fact at t_0 . This means that, synchronically speaking, the future tense is a 'modalized' tense, i. e. a tense with a modal implication. However, it is first and foremost a tense, not (as is often claimed in the literature) a mood: its basic function is to locate a situation in time, and in doing so it automatically expresses the modal connotation of not-yet-factuality-at- t_0 . In other words, the future tense satisfies our definition of tense (see 2.1 and 2.7): it is the correlation between a particular temporal meaning ('The situation time is located posterior to t_0 ') and a formal expression of this.

7.5 The distribution of *shall* and *will* in the future tense

7.5.1 The future tense is normally built with *will*. *Shall* is possible only in the first person, where it is a formal alternative to *will*. It is rare in spoken Br. E.

and very rare in colloquial Am. E. It is not normally used when the subject is *both of us*, *all of us*, *none of us*, *some of us*, etc., even though these are expressions of the first person, nor after subjects that are coordinated NPs with a first person pronoun as one of its constituents (e. g. *You and I*, *We or they*, etc.).¹

Both of us {will / *shall} be in trouble if she does not keep her mouth shut.

You and I {will / *shall} probably go our own ways after college.

My wife and myself {will / *shall} join the rest of the company later.

7.5.2 The above mentioned distribution also holds for *shall* and *will* in the future perfect and for the (nonmodal) conditional tense auxiliaries *should* and *would*.

By that time I {will / shall} have left the building.

By that time she {will / #shall} have left the building. (*Shall could only be used as a modal auxiliary expressing a command.*)

I told him what I {would / (should)} do about it. (*Should can be interpreted either as a tense auxiliary or as a modal expression of advice, duty, moral obligation, etc.*)

She told him what she {would / #should} do about it. (*Should could only be interpreted as a modal expression of advice, duty, moral obligation, etc.*)

[I realized that] I {would / should} probably have left the building before 5 p.m. (*Should can be interpreted as a tense auxiliary or as a modal auxiliary.*)

[I realized that] she {would / #should} probably have left the building before 5 p.m. (*Should can only be interpreted as a modal auxiliary.*)

[We knew that] both of us {would / *should} be shot because of what we had done. (*Should is not normally used as tense auxiliary after a first person subject like both of us.*)

Of course, the distinction is obscured when the contracted form 'll or 'd is used.

7.6 The various meanings of *shall* and *will*

As tense auxiliaries, *shall* and *will* express pure future, i. e. they convey a sense of neutral prediction.

1. Occasional exceptions can be found, but these may be instances of hypercorrection. (*Shall* was, and perhaps is still, considered by some to be the 'correct' first person form.)

My wife and I *shall* be only too pleased to take advantage of your offers to prospective customers. (www)

[The idea of just solo rep. in a recital is also relatively new, it used to be that you would go to a concert, hear a symphony, a sonata and a trio all in the same concert.]

Now the two of us *shall* be crucified for our elitist theories. (www)

7.6.1 *Shall* and *will* can both be used not only as future tense auxiliaries but also as modal auxiliaries. As tense auxiliaries they locate a situation time in the post-present and in doing so express one of the related ideas ‘PURE FUTURE’, ‘PREDICTION’ or ‘PREDICTABILITY’ – see 2.8.2. This means that the speaker merely predicts something or assumes that something is likely to happen: he does not represent the post-present actualization of the situation as determined by present circumstances, such as the present volition or intention of the subject of the sentence or a present possibility, necessity, arrangement, etc. (As noted in 7.3.1, this emphasis on the present is typical of ‘futurish forms’.) This sense of PURE FUTURE or NEUTRAL PREDICTION without attitudinal implications is clearest when the post-present actualization depends upon external factors. This is the case, for example, in the head clause of sentences containing or implying a conditional or temporal clause referring to a situation that has not yet actualized at t_0 .

We’ll go camping next week if the weather is fine.

You’ll change your mind after you’ve read this letter. (*implies an as yet unfulfilled condition: if you read this letter, then you’ll change your mind*)

I’ll tell her everything about it when she comes tomorrow.

[Don’t go near the puma.] It’ll bite you. (*implicit condition: if you go near it*)

[Why don’t you invite a couple of friends?] It’ll cheer you up. (*implicit condition: if you invite them*)

Tomorrow it will be rainy but warm. (*In weather forecasts the predicted situation by definition does not depend on anybody’s volition or intention.*)

Shall and *will* can be used as modal auxiliaries expressing some kind of volition. There are a few constructions in which this interpretation comes to the fore and in which futurity is therefore better expressed by other means.

7.6.2 When used as modal auxiliaries (rather than future tense auxiliaries), *shall* and *will* can express various meanings that have to do with volition. According to context, they can express willingness, a promise, a desire, a wish, a threat, a warning, an intention, insistence, determination, etc. In contexts inviting one of these modal interpretations, *shall* or *will* will be avoided if the speaker just wishes to express pure future. The following are some typical examples of this.

- (a) In questions, ‘*shall I/we* + the present infinitive of an intentional (agentive) verb’ is used to inquire about a person’s will. The unmarked interpretation of this construction is therefore that of a suggestion or offer of service. It

follows that *will* (rather than *shall*) is the normal auxiliary in questions which involve a first person subject and an agentive verb and which merely ask for information about the future.

["Take the 6.33 train." – "Fine."] What time will I be in Leeds? (*pure future: asking for information*)

What time shall I be in Leeds? (= 'What time would you like me to be in Leeds?')

Shall I help you? (*offer of service: 'Would you like me to help you?'*)

Will I help you? (= 'What do you think? Will I help you or not? Guess.')

Mummy, will I be as clever as aunt Emma when I grow up? (*pure future*)

What time shall I collect you tonight? (= 'What time would you like me to come?')

- (b) With volitional (intentional) verbs (i.e. verbs referring to a consciously performed action), '*will not + nonprogressive nonperfect infinitive*' can often be understood as expressing a present or post-present refusal. To avoid such an interpretation, speakers who want to express pure future tend to use the progressive form of the future tense, which does not yield an interpretation that has to do with willingness. Similarly, they prefer to use *be going to* to express post-present actualization depending on a present intention.

Mummy, Jane won't give me back my bow and arrow. (*refusal*)

He won't be leaving his house before eight o'clock. (*pure future*)

He probably won't leave his house. (*ambiguous*)

I am not going to leave my house. (*present intention*)

- (c) With volitional verbs, *yes/no*-questions introduced by '*will you + nonprogressive nonperfect infinitive*' are normally understood as expressing a request, an offer or an invitation (unless the intonation renders this kind of reading unlikely). Such an interpretation is avoided by the use of the progressive form of the future tense for pure future and by the use of *be going to* for future with present intention.

Will you come to the party? (*probably a request or invitation*)

Will you be coming to the party? (*pure future*)

Are you going to use this towel? (*intention*)

Will you come inside? (*invitation*)

Will you be all right tomorrow? (*pure future: nonagentive verb phrase*)

Will you have some cocoa? (*offer*)

Will you please stop shouting? (*request*)

7.7 The progressive future tense (without progressive meaning)

Post-present time reference can also be expressed by the progressive form of the future tense. Apart from its basic use as a progressive form with progressive meaning (= representing a situation as in progress at a future ‘vantage time’), there is also a special use of the progressive form of the future tense, which combines the following characteristics: (a) There is no implication of progressive aspectual meaning; (b) The reference is mostly to ‘pure future’, i.e. there is no implication of intention, plan or volition; (c) There is usually a suggestion that the post-present situation will actualize as a matter of routine or as part of what is (or is expected to be) the normal ‘course of events’.

We will not be using the gymnasium for a couple of weeks [because it is being refurbished]. (It is only natural that a gymnasium is out of use as long as it is being refurbished.)

Bill will be driving to London on Thursday. [Why don't you ask him to deliver the parcel?] (The sentence implies that Bill will be driving to London anyhow. This idea – that his driving to London next Thursday forms part of the expected course of events – may be due to the fact that there is a habitual pattern: Bill drives to London every Thursday. It is also possible, though, that next Thursday is understood to be the only time in Bill's life that he will drive to London, but that this trip is nevertheless simply something that will happen as a matter of course.)

When will you be seeing Rose again? (Because of when, the sentence presupposes (whether or not correctly) that the addressee will see Rose again. The form will be seeing is in keeping with this, because it suggests that it can be taken for granted that the addressee will see Rose again within a contextually ‘reasonable’ period of time. If Rose is going to the other side of the world to live, that period will quite possibly be several years, and if she lives in the same town and is a good friend of the addressee, the period the speaker has in mind will probably be no more than a few weeks.)

When will Helen be leaving?

The next thing you know he'll be asking for a pay rise.

II. Remarks on *be going to*

7.8 ‘*Be going to* + infinitive’: futurish form or future tense form

7.8.1 The auxiliary *be going to* is basically used to express the idea that the post-present situation is predictable at t_0 because its origin lies in the present or because there is present evidence that the situation is going to actualize. That is, ‘*be going to* + present infinitive’ is basically a ‘futurish form’ (see 7.3.1) rather than a future tense form. However, as noted in 7.3.2, there are also examples (especially in nonformal English) in which the post-present time of actualization is more salient than the present (e.g. *It is going to rain tomorrow*), in which case the difference between *be going to* and *will* is less pronounced: whereas the latter expresses a prediction, *be going to* is a means of talking about the future in a more neutral way. In the following examples, there is little difference in meaning between *will* and *be going to*, so that there seems to be a case for analysing both of them as future tense auxiliaries:

Tomorrow’s weather {will be / is going to be} mild and dry. (*Will is used by a speaker who is in a position to make a prediction, or wants to be heard as making a prediction, while be going to is used by someone simply making a statement of fact based on some source such as a prediction.*)

Do you think Leeds {will / are going to} beat Crystal Palace in the match tomorrow?

The Prince of Wales {will / is going to} attend the concert next Sunday.

{What’ll / What’s going to} happen to us?

In sum, we will treat *be going to* as a futurish auxiliary when it expresses the idea that the post-present situation is predictable at t_0 because its origin lies in the present or because there is present evidence that the situation is going to actualize. When this connotation is lacking, and *be going to* just refers to the post-present in a neutral way, we will treat it as a future tense auxiliary.

7.8.2 The phrase *will be going to* can in principle be used as an ‘absolute-relative tense form’ – see 2.47. Like the future perfect, it then both establishes a post-present domain and expresses a relation (in this case: T-posteriority) in it.

By the time we get there, they will be going to leave. (= ‘it will be the case that they are going to leave’)

However, when we googled *will be going to*, we did not find any examples of this use. On the other hand, we found quite a few examples in which *will be going to* simply establishes a post-present domain, i. e. is used as an alternative to either *will* or *be going to*:

Ever wondered what the winter weather *will be going to be*? [If anyone would only know for sure. So far, we have conflicting messages.] (www)

We just came home and *will be going to have* some well-deserved sleep. (www)

How many *will be going to be switching* to this when or if it becomes available to you? I know damn well I will. (www)

Doubt anyone here *will be going to be going* to South Africa soon, but if you do, (and god help South Africa if any of you do go there) they'll be handy ones to... (www)

[Right at this time, I am not allowed to inform you about details, but] – I *will be going to ask* headquarters. Wait a minute. (www)

This use of *will be going to* is typical of a (very) informal register and can presumably not (yet) be considered as Standard English. We will pay no further attention to it in this book.

7.9 'Be going to + infinitive' as futurish form: general meaning

As a futurish form, *be going to* expresses dual time-reference with emphasis on the present (see 7.3.2). This concern with the present may be of various kinds, but all of them can be subsumed under the heading of 'concern with the present source (origin) of the predicted post-present actualization'.

We use *be going to* rather than *will* to express a 'premeditated intention'. However, *will* is the normal auxiliary to express an 'unpremeditated intention'.

7.10 *Be going to* expressing a present intention

7.10.1 With agentive verb phrases, *be going to* can be used to express the idea that the agent has the present intention of doing something in the post-present. The agent is as a rule the referent of the subject NP in active sentences and the referent of the NP of the *by*-PP in passive sentences. However, in passive sentences without a *by*-adjunct the agent is implicit.

Cheryl is going to marry Gordon when she has graduated. (*reference to Cheryl's present intention or decision*)

These regulations are going to be abolished by the new government.

These trees are going to be cut down. (*agent not specified*)

Next year we're going to employ more workers.

When are you going to speak to him again?

7.10.2 In sentences with a first person subject, *will* (but not *shall*) can sometimes also be used to represent the future as depending on a present intention. However, the intention in question is of a different kind from the sort of intention expressed by *I am going to ...* This difference may not always be 100 % clear, but in general we can accept the following as a rule:

- (a) When the intention is clearly *premeditated*, i. e. when the speaker has already made up his mind about what he proposes to do (e. g. when he is already preparing for it), *be going to* is the form to be used. Compare:

[I've bought a computer.] I'm going to do the paperwork myself in future. (*premeditated intention*)

[I've bought a computer.] I'll do the paperwork myself in future. (*In this context, will is interpreted as fairly volitional. It suggests something like 'I've given up expecting anyone else to do it properly, so I've made up my mind to do the paperwork myself in future', or 'OK, I give in, I will do the paperwork myself in future'.*)

Similarly:

[Why have you written to a solicitor?] Are you going to make a will?

Will you make a will? (*interpreted as volitional – 'Will you agree to make a will?' – or as having an implicit condition.*)

[Why have you written to a solicitor?] Will you make a will? (*difficult to interpret in the given context*)

Because of its premeditated intention meaning, *be going to* can be chosen to express strong determination:

I'm going to wait for her, even if it means sitting here all night! (*The even if-clause ensures that the whole utterance is understood as conveying strength of determination; with be going to the speaker is likely to be understood as making a defiant statement of determination. Will can also be used; if it is not accented it has more the effect of a statement of objective 'fact'; if accented it has an effect similar to that of a toddler stamping his foot.*)

I'm going to keep talking to him until he changes his mind. (*With be going to this is a statement of strong determination, with will the effect is more of a calm plan.*)

I'm going to get out of here if it kills me! (*Will would be somewhat less appropriate than be going to here because of the element of strong determination expressed in the conditional clause.*)

[I've told you before and I'm telling you again:] I'm not going to buy you a dog. (*This expression of strong determination comes close to the expression of a refusal. With will the sentence would actually BE a refusal because the volition meaning would come to the fore: will not = 'am not willing to'.*)

- (b) *Will* is the auxiliary to be used when the intention is clearly *unpremeditated*, i. e. when the subject has only just thought of performing the action,

when the action is an immediate and spontaneous reaction to something that has been said or that has happened. (In this use, *will* is usually weakened to 'll in spoken English.)

["Would you like some biscuits?" – "Oh, yes. Thank you.] I'll take ONE. [I love custard creams but I'm trying to cut down.] (*unpremeditated decision*)

["It's dark in here." – "Don't worry.] I'll fetch a torch." (*decision made on the spur of the moment*)

[Look! She's waving to us.] I'll go and see what she wants to tell us. (*id.*)

["The tap is leaking."] – "I'll have a look."

In these examples *shall* could not be substituted for *will*, because *will* here expresses not only unpremeditated intention but also volition (willingness). As is well-known, the modal idea of willingness is expressed by the modal auxiliary *will*, not by *shall*. However, in examples which completely lack the idea of willingness and seem to be more like simple statements (decisions) about the future, *shall* is not unacceptable as an alternative to *will*.

["Make up your mind!" – "OK.] I {*will / shall*} wear the blue shirt."

[I am fed up with reading. I think] I {*will / shall*} write some letters now.

[Hmmm, what else to do today? Erm, oh yes, I think] I *shall* phone Ali this evening to find out if she is indeed coming up for Easter. (*www*)

[There are only two podiatrists in this town, one of which is the moron. The other is his partner.] I think I *shall* skip my next appointment with him (without calling ahead of time) and go to somebody in a neighboring town. (*www*)

7.10.3 As noted in section 7.6.2, *yes/no*-questions beginning with 'will you + nonprogressive nonperfect infinitive' and involving an agentive verb phrase are normally understood as requests, offers or invitations rather than as questions about intentions for future action. The latter are, therefore, more normally expressed by *are you going to?* Compare:

Are you going to have a word with Tom? (*intention*)

Will you have a word with Tom? (*easily understood as a request*)

We certainly use *are you going to?* when the intention is premeditated.

[You haven't changed into your suit yet.] Aren't you going to attend the meeting?

The past tense of *be going to* carries the implicature of nonactualization of the posterior situation.

7.10.4 Because of the connotation of premeditation, an assertion using *is/are going to* usually implies a strong expectation that the intention (plan, decision)

will be carried out. In this respect it differs from the past tense forms *was/were going to*, which are most often used in contexts implying nonfulfilment of the intention:

I'm going to throw away these papers. (*premeditated intention; fulfilment is expected*)

He was going to throw these papers away, [but I told him we might need them again some day].

I was just going to lock the door [when someone tapped on it].

I was going to attend the meeting tomorrow. (*strongly suggests that I will not go there after all*)

When the idea of nonfulfilment of the past intention is not induced by the context, it still often arises as an implicature. This implicature has to do with the Gricean Maxim of Relation (Relevance). If, at a certain time in the past, the subject had the intention of doing something later, then there are three logical possibilities as regards the time of actualization: the situation was intended to take place either before, at or after t_0 . In the first two cases, fulfilment of the intention means that the situation takes place before t_0 or at t_0 . In that case the speaker will normally represent the situation as actualizing or as having actualized (i. e. as factual) by using the present or the past tense, respectively. If he does not do this but refers to the intention instead (by using *was/were going to*) this will have the effect of suggesting that the actualization of the situation cannot be referred to, because it did not take place or is not taking place as expected. If it is the third logical possibility that is at play, i. e. the time of actualization of the intended situation is not before or at t_0 but after t_0 , then in the unmarked case, the speaker will represent the intention as a present intention (e. g. *I'm going to attend the meeting tomorrow*) rather than as a past one (e. g. *I was going to attend the meeting tomorrow*). All this is in keeping with the Maxim of Relation (Relevance) since, other things being equal, statements about the present are more relevant than statements about the past. If, in a nonpast context, the speaker explicitly locates an intention in the past by using *was going to*, this can only mean that he thinks the intention is (or may be) no longer valid, i. e. that it will not (or may not) be carried out.

The above explanation concerns the use of *was going to* in independent clauses. When it is used in an 'intensional' context (such as indirect reported speech or free indirect speech),² the idea of nonfulfilment only arises if it is

2. An intensional context (or 'opaque context') is one in which the reference is not to the real world but to an alternative (e. g. imaginary) world. Such a context is created by (amongst other things) 'intensional verbs' ('verbs of propositional attitude') like *want*, *expect*, *believe*, *think*, *imagine*, etc. Clauses that form part of an intensional context receive an 'opaque' ('de dicto') interpretation, i. e. their truth is not evaluated in relation to the real world but in relation to the alternative world referred to.

evoked by the context. There is no implicature of nonfulfilled intention in *He said he was going to do something about it*, unless we add something like *but it still looks the same to me*.

7.10.5 A form built with *has/have been going to* receives a continuative interpretation which implies that the (situation of having the) intention leads up to (and includes) t_0 , and hence that there has not been actualization of the intended situation yet.

You've been going to talk to the landlord for months. (*implies: but you still haven't done it.*)

You have been going to buy a tennis racket of your own for years, [but you still come to borrow mine].

If it does not imply a present intention, *be going to* implies that the speaker's prediction is based on present evidence or knowledge.

7.11 *Be going to* expressing present predictability of a post-present actualization

7.11.1 Apart from a present intention, there are various other factors that can render the post-present (non)actualization of a situation predictable at t_0 . For the use of *is/are going to* it suffices that the speaker's prediction is based on present evidence or knowledge.

In many cases the post-present situation is predictable because there are signs in the present of what is going to happen. In other words, the post-present situation is predictable because its origin or beginning lies in the present.

There's going to be a row in a minute. (*implies, for example, that the speaker can see that some people are getting upset.*)

Clauses belonging to a nonintentional context receive a 'transparent' ('de re') interpretation, i.e. their truth is evaluated in relation to the real world. It is typical of such an interpretation that the truth value of the clause is not affected when a referring expression in the clause is replaced by an 'identical' expression (i.e. by an expression with the same referent). Thus, since in the real world *the capital of France* and *Paris* have the same referent, we can replace the former by the latter in *The capital of France has ten million inhabitants* without altering the truth value of the sentence.

In sentences that receive an opaque interpretation, the replacement of a term by an 'identical' expression may affect the truth value: the sentence *Bill thinks that Paris is the capital of Spain* may be true even if *Bill thinks that the capital of France is the capital of Spain* is not true.

[The little girl showed her drawings to the visitors.] Everyone agreed that she was going to be a real artist. (= *The girl was already showing signs of being a gifted artist.*)

[Look out!] We're going to bump into that van!

Oh no! Betty's going to sing. (*implies that the speaker knows this, e.g. because Betty has taken the microphone.*)

I think I'm going to be sick. (*implies: I'm feeling queasy.*)

[Iraqi troops have invaded Kuwait this morning.] Surely, the United States is not going to accept this. (*expectation based on present knowledge of foreign policy*)

7.11.2 When followed by a stative verb referring to a nonintentional (nonvolitional) situation, *be going to* is automatically interpreted as expressing this sense of predictability:

We're going to *see* the finish soon.

You're not going to *like* this review of your book.

Are you going to *remember* this? [Or shall I write it down?]

[Jake already finds that bed a bit too short, and] he's going to *be* taller by the time he comes next summer. [We'll have to get a new one before his next holiday.]

She's going to *know* what's happened to her predecessor, [so she's going to have armed herself against any similar occurrences.] (= '*It is predictable that she will have found out about what happened to her predecessor*')

7.11.3 The fact that *be going to* represents the post-present actualization of a situation as related to the present means that the situation referred to is normally interpreted as lying in the immediate or near future, unless there is an adverbial, contextual or pragmatic indication to the contrary. Compare:

We're going to have the chimney repaired. (*interpreted as referring to the immediate or near future, unless an adverbial like one day is added.*)

[Be careful.] The bath-tub is going to overflow. (*idem*)

What are you going to read to us? (*interpreted as referring to the immediate or near future, unless an adverbial like next time is added.*)

Because of this immediacy implicature, *be going to* can be used without an adverbial or contextual specification of a specific future time. In this respect it differs from *shall* and *will*, which are often hard to interpret without such a specification. Thus, a sentence like *It will snow* is pointless without an adverbial or contextual specification of a specific future time (in the same way as *It snowed* is not fully interpretable if we do not know what time the speaker is referring to), but *It's going to snow* is impeccable in isolation, because it is interpreted as a statement about the near future. This interpretation accords with the observation (made in 7.2) that, as a futurish form, '*be going to + V*' has 'dual time reference': reference to the post-present time of actualization is

combined with reference to the present. This means that *be going to* does not need a temporal anchor for the post-present situation time because it already has speech time as a temporal anchor for what determines the post-present actualization.

7.12 A special use of *be going to* in *if*-clauses

In 7.15.2, it will be pointed out that *be to* can be used in a conditional clause in order to represent the possible future actualization of the *if*-clause situation as a goal that is envisaged at t_0 . In informal English, *be going to* is more common than *be to* in this use.

You'll have to hurry if you're (*going to*) be there on time.

If you're (*going to*) pass your exams you'll have to work much harder than you're doing.

You should try and get your articles published in better scientific journals if you're (*going to*) become a name in the academic world.

7.13 Constraints on the use of *be going to*

The use of *be going to* presupposes that all the necessary conditions for the future actualization of the situation referred to are fulfilled. Because of this, *be going to* is not normally used in the head clause of a conditional sentence whose conditional clause expresses an 'open' condition (which may or may not be fulfilled in the future).

7.13.1 Because *be going to* represents the post-present as having its roots in the present, its use presupposes that all the necessary conditions for the post-present actualization of the situation have been met. This is true not only when it is used as a futurish form but also when it is used as future tense auxiliary, because even then it has some trace of the futurish meaning that the situation's actualization is dependent on present factors, even when that element of meaning in itself is virtually negligible (because it is reduced to the sense that the speaker makes a confident prediction at t_0 – a sense that is shared by 'pure future' *will*).

It follows that *be going to* is not normally used to refer to a situation whose actualization crucially depends on the future fulfilment of a condition. In other words, *will* is the normal auxiliary if the context refers to (or implies) an essential condition which is not yet fulfilled (i. e. an 'OPEN CONDITION' concerning the possible actualization of a post-present situation). Consider:

If Sue asks Jim, he {will / is going to} help her.

Depending on the choice of auxiliary, there are two interpretations:

- (a) With *will*, the sentence is interpreted as ‘If Sue asks Jim to help her, the result is predictably that he will do so’. Here the future actualization of Jim’s helping Sue is dependent on, and will result from (i. e. be caused by), Sue’s asking him to do so. Sue’s asking Jim to help her is thus a necessary *and* sufficient condition for Jim to do so.
- (b) *Be going to* suggests the reading ‘I predict that Jim will help Sue provided that Sue asks him’. That is, Sue’s asking Jim for help is a necessary but not a sufficient condition for Jim to help Sue.

The following further illustrate that if we want to refer to a situation which is only brought about by some future situation we cannot use *be going to*, because *be going to* requires the cause (i. e. the fulfilment of the condition) to be present:

[“Let’s sit on that bough.” – “No, it’s not strong enough.”] {It’ll break / *It’s going to break}.” (*implicit condition: if we sit on it*)

If you ever go to France, you {will / ??are going to} enjoy your meals there.

If she manages to improve her serve and her backhand, she {will / ??is going to} take her place among the top players.

[Be careful!] The bathtub {is going to / ??will} overflow. (*For lack of an indication of time, will strongly suggests that there is a condition missing.*)

Compare further:

[“Isn’t the bookcase ready yet?”] – “The glue *will* be dry in half an hour, [and then you can use it].”

[If you want to tear these things apart again, you’ll have to do so quickly.] The glue {*is going to be* / *will be*} dry in half an hour.

In the first example, *will be dry* is much more natural than *is going to be dry* if the speaker’s intention is to advise the hearer to be patient. This is because *will be dry in half an hour* puts a certain emphasis on the fact that not all the conditions for the glue to be dry (and for the bookcase to be ready) are satisfied yet (though they will be in half an hour): the main message is ‘Don’t touch the bookcase. It’ll be ready in half an hour if you let the glue dry without interfering’. In the second example, *is going to* conveys the idea of inevitability: all the conditions for the future actualization of the situation are fulfilled, so the situation is inevitable, unless something interferes with the necessary conditions before it is too late. *Will* is also possible in this context: it brings the implicit condition ‘if you do not do something quickly’ to the fore.

The above observations also explain the following:

I must speak to my brother or he {*will* / ??*is going to*} make a big mistake.

I must speak to my brother because he {**will* / *is going to*} make a big mistake.

The first sentence is interpreted as ‘I must speak to my brother because he will make a big mistake if I don’t speak to him’. Because of the implicit reference to an as yet unfulfilled condition, the choice of *will* rather than *be going to* is normal. In the second example, only *be going to* can be used, because the idea to be expressed is that my brother’s future action (which I consider a mistake) has been arranged and is fully predictable. In this case the future actualization has its roots in the present – an idea which is expressed by *be going to*, but not by *will* (which expresses a neutral prediction – see 7.6.1).

It should be noted, finally, that even in a conditional context locating the fulfilment of the condition in the future, *be going to* with strong determination is fine:

If John is still there when we arrive, I’m *going to walk* straight back out.

There is no problem here because the strong determination in question is already present at t_0 . (There is a similarity here with examples like

If John is still there when we arrive, you *must walk* straight back out.

where *must* refers to a present obligation though *must walk* locates the potential (actualization of the) situation of walking in the future.)

There is no problem using *be going to* in the head clause of a conditional sentence if the conditional clause expresses a ‘closed’ condition.

7.13.2 It is in keeping with the previous remark that the use of *be going to* in the head clause of a conditional sentence presents no problem if the condition expressed is not treated as an ‘open’ condition (which may or may not be fulfilled in the post-present) but rather as a ‘**CLOSED CONDITION**’, i.e. as a condition which, at t_0 , is assumed to be fulfilled or to be certain to be fulfilled. (A closed condition typically echoes something that has just been said or a conclusion the speaker has just arrived at.)

[“I’ve lost my passport.”] – “If you have lost your passport, you’re *going to have* a lot of trouble with the police.”

If you’ve come here to find out more about our plans, you’re *going to be* disappointed. (= *if, as I believe is the case, you’ve come here ...*)

Sentences like the following are slightly different, because the conditional clause is not echoic:

You *are going to be* late if you don't hurry. (*The speaker sees that the hearer is too slow.*)

[Don't always go to your mother if you have a problem.] If you never try to solve a problem yourself, life *is going to be* very difficult for you when your mother dies.

However, the reason why *be going to* can be used in the head clause is again that the speaker has no doubt about the fulfilment of the condition, i. e. that he treats the condition as closed. In these cases the speaker makes a prediction about the future on the basis of the state of the world (as he knows it) now, with the claim that the prediction will come true unless something happens in the future to prevent its coming true. In other words, there is sufficient evidence for the prediction now, although certain events can prevent the actualization of the predicted situation. Thus the semantic pattern is: 'If the conditions conducive to the actualization of Y, which currently prevail, do not change, Y is going to actualize'. Another example of this is *If you carry on like that, you're going to have a problem one of these days*. In contrast, the following are examples in which (out of context) it is difficult or virtually impossible to treat the condition as closed, so that *be going to* is less acceptable or unacceptable:

If you accept that invitation, you {*will only* / **are only going to*} meet a lot of boring people.

You {*will* / **are going to*} learn to drive a car proficiently if you take this course.

Forms consisting of a form of *be* plus *going to go* or *going to come* tend to be avoided in favour of progressive present forms of *go* or *come*.

7.13.3 Although it is not ungrammatical, the use of *be going to* sounds rather awkward before *go* and *come*. People therefore tend to use the present progressive form of these verbs instead.

[I'm studying Spanish because] I'm going to Spain next month. (*generally preferred to 'am going to go'*)

She's coming here next week. (*generally preferred to 'is going to come'*)

III. Futurish forms other than *be going to*

7.14 *Be about to* and *be on the point of*

These two auxiliaries express immediate future. *Be on the point of* is most often used with an agentive subject.

[A local radio station is prompting a village to evacuate with an ugly tale about the local landfill site,] which they claim *is about to* suffer a methane explosion and shower the neighbourhood with rocket-propelled refuse. (COB)

[Neither my political nor my journalistic interests would be well served if the Government took the advice] which, free of charge, I *am about to* offer them. (www)

[Mrs Bottomley threatened to set up NHS operations with dentists on fixed Government salaries, but now she seems *about to* give in by increasing the amount surgeons can charge. (www)

BHP Australia Coal, we discovered, *is about to* trade in its old Lear jet on a larger model, which seats 11 people. (www)

Anne Diamond and her husband Mike Hollingsworth are both *on the point of* announcing exciting new jobs. (www)

Mr Hollingsworth, 46, former director of programmes at TV-am, *is on the point of* confirming a big new entertainments appointment with the BBC say friends. (www)

I'm *on the point of* leaving my husband just to get rid of his dreadful mother. [She makes me feel so inadequate.] (www)

Grey squirrels have now reached plague proportions in many parts of the country, and in Northumberland and Scotland *are on the point of* eliminating the last healthy populations of red squirrels. (www)

7.15 The auxiliary *be to*

7.15.1 Apart from its use to convey modal ideas (e.g. obligation or necessity resulting from an order or prohibition, etc.), *be to* can be used as a futurish auxiliary expressing an arranged future. It differs from the progressive present in that it normally denotes either an official plan or decision or a scheduled action imposed by an outside will.

The measures *are to take* effect next week.

(The) Prime Minister *(is) to visit* Australia next summer. (*headline*)

These collieries *are to close down* before the end of the year.

The ambassador *is to return* to Egypt tomorrow.

7.15.2 One special use of *be to* is in *if*-clauses referring to a goal that is envisaged at t_0 . As noted in 7.12, the same idea can be expressed by *be going to* in informal English.

[A word about weeds and mulching. Weeding is therapeutic to some, a real bore to others, but] it has to be done if you *are to* stay in control of your garden, rather than the other way round. (www)

[The Protestant marching season coincides with the preparations for elections to Northern Ireland's peace convention.] If Ulster *is to* avoid a descent into communal violence then a mixture of delicacy and resolution will be required to maintain public order and sustain political progress. (www)

If we *are to* be effective and authentic, Oxfam staff, volunteers and supporters must function as an integrated movement. (www)

7.16 The present tense

Both the progressive and the nonprogressive present tense can under certain conditions be used to talk about a situation whose post-present actualization is dependent on present circumstances:

The new teacher *arrives* tomorrow.

We're *leaving* in a minute.

This use of the present tense, which represents a shift of temporal perspective, is treated in detail in 3.8–10.

DEMO

IV. Summary

7.17.1 The meaning of the **future tense** is: ‘The situation time is located in the post-present zone’. The principal **future tense form** in English is ‘*will* (or *shall*) + present infinitive’. (*Shall* is only ever used in the first person and then only in restricted grammatical and pragmatic contexts). An alternative future tense form is ‘*be going to* + present infinitive’, which, however, can also be used as a ‘futurish’ form – see 7.17.2.

The progressive future tense can be used without progressive meaning to express ‘future as a matter of course’:

[Their centre forward is limping. I expect that] his substitute *will be playing* the second half.

7.17.2 Unlike future tense forms, ‘**futurish forms**’ always combine some sort of reference to the present with the location of a situation time in the post-present zone. Because the location of a situation time in the future is not the main meaning of these forms (reference to the present is at least as important and in some cases is the core temporal meaning) they are not future tenses, but they do establish post-present domains.

The form *be going to* is not only used as future tense form but also, and more usually, as a futurish form. The dividing line between the two uses is not a clear one, but in cases in which *be going to* refers to the future more or less devoid of reference to the present, we consider it to be a future tense form.

As a futurish form, *be going to* expresses the idea that the post-present actualization of a situation is predictable from present circumstances. That is, the source or cause of the actualization of the future situation is already present. The present ‘roots’ of the future situation may lie in an intention: *She’s going to wash the elephant* means ‘she has the intention of washing the elephant’. The future situation may also have its roots in any other sort of present circumstances that can be used as evidence for a prediction. For example, *The elephant is going to be sick* implies ‘The elephant is showing signs that I recognize as evidence that it will shortly be sick’. Unlike *will*, which normally requires that there be a contextual **temporal anchor** for the situation referred to, *be going to* can be used without such an anchor.

The observation that *will* normally requires a temporal anchor explains why it is hardly possible in examples like the following:

[Be careful!] The bathtub {is going to / ??will} overflow. (*For lack of an indication of time, will strongly suggests that there is a condition missing.*)

Because *will* (and *shall*) in their use as future tense auxiliaries simply locate a situation at some unspecified time in the future, it can be difficult to interpret a clause with a future tense form with *will* if there is no indication of where

in the future the situation lies. Thus *Be careful, the bathtub will overflow!* tends to provoke the reaction ‘when?’ or, more likely, ‘if what?’, since conditions are often left implicit and one of the most characteristic uses of the *will* future is in sentences with a conditional meaning or connotation. In such sentences, the post-present situation does not have to be located at any particular point in the future, but is simply presented as logically posterior to the situation in the *if*-clause (or the equivalent, in sentences with a conditional connotation).

7.17.3 However, *be going to* can also be argued to function at times as a future tense form, since it is sometimes used to refer to the future actualization of a situation with little attention to the present roots of that situation: *The concert is going to be held in the open air.* In such cases, we treat *be going to* as a future tense auxiliary. *Be going to* as a future tense auxiliary can also be argued to be even more ‘neutral’ than *will* as a future tense auxiliary, since it lacks the subjective element present in the prediction meaning of *will*.

Nevertheless, since *be going to* retains some sense of the situation’s having its roots in the present, its use implies that the conditions for the actualization of the situation have been met at speech time. This means that it does not normally combine with a conditional clause which refers to a condition that has yet to be met. In such cases, *will* is normally used. Thus *be going to* is somewhat difficult to interpret in the following example:

If your dog bites a post office worker, the post office {*will* / *is going to*} sue you.

Similarly, in *If that dog bites him he'll sue*, the speaker simply makes a prediction about a future situation that will actualize if a future condition is met. However, in *If that dog bites him he's going to sue*, the meaning is either ‘He has already decided that he is going to sue if the dog bites him’ – i. e. the conditions for his suing if the dog bites him have already been met – or something like ‘I can see that he’s the type to sue if the dog bites him’ – i. e., again, the conditions for his suing if the dog bites him – namely his being the type to do so – are already there.

7.17.4 *Will* and *shall* also have uses as modal auxiliaries expressing volition. For example *Shall I help you?* inquires about the addressee’s wishes and *I won't help him* expresses unwillingness or refusal on the speaker’s part. As tense auxiliaries, *will* and *shall* simply locate a situation in the post-present, albeit with varying degrees of subjectivity. (In 2.8.2 we have distinguished between pure future, prediction and predictability.) They do not have connotations of present factors that affect the actualization of the future situation, such as those found in the use of futurish forms or modal forms. The ‘neutral prediction’ value of *will* and *shall* as tense auxiliaries is most evident when the post-present actualization of the predicted situation is dependent on factors that are external to the subject referent of the future tense clause: *If that dog barks*

much more the neighbours will complain. In certain contexts, the modal meaning of *will* or of *shall* is particularly salient. In those contexts, the speaker wishing to express pure future time reference has to find an alternative form.

7.17.5 The futurish forms other than *be going to* include ‘*be about to* + present infinitive’ and ‘*be on the point of* + present gerund’ for immediate future and *be to* for (externally imposed) arranged future. In addition, both the progressive present tense and the nonprogressive present tense can be used to refer to the future by treating it as if it were the present, as in *The new helper arrives this afternoon.* (This ‘shift of temporal perspective’ use of the present tense is addressed in 3.6).

DEMO

8. Temporal domains and relative tenses: theoretical foundations

I.	Introduction	364
8.1	Full situation <i>vs</i> predicated situation	364
8.2	Orientation time & situation time	367
8.3	Temporal relations expressed by tenses: T-relations	368
8.4	Temporal relations not expressed by tenses: W-relations	369
8.5	The two 'time-spheres'	370
8.6	Present time-sphere zones	370
8.7	Visual representation of time-spheres and zones	371
8.8	Absolute zones	371
8.9	The length of the time-spheres and zones	372
8.10	Absolute <i>vs</i> relative tenses	372
8.11	Temporal domain	372
8.12	Two past tenses: the absolute preterite <i>vs</i> the relative preterite	373
8.13	Past <i>vs</i> present (time-sphere) tenses	374
8.14	Temporal subordination or temporal binding (T-binding)	374
II.	Temporal domains: further terminological apparatus	376
8.15	Central time of orientation (central orientation time)	376
8.16	The temporal nature of the domain	377
8.17	The definition of T-simultaneity	377
8.18	The definition of W-simultaneity	378
8.19	Temporal subordination <i>vs</i> syntactic subordination	380
8.20	Definition of 'head clause' and 'matrix'	380
8.21	Shift of domain	381
8.22	Shift of temporal perspective	382
III.	Arguments for distinguishing between the absolute and the relative past tense	383
8.23	Argument 1: similarity between past and post-present domains	384
8.24	Argument 2: past tenses whose situation time is W-posterior to t_0	385
8.25	Argument 3: tense use in represented speech	390
8.26	Argument 4: the incompatibility of a punctual adverbial with a relative preterite	398
8.27	Argument 5: a relative past tense form cannot be replaced by <i>used to</i>	402
8.28	Argument 6: the use of the preterite rather than the conditional tense	405
8.29	Argument 7: ambiguity or vagueness?	408
8.30	Argument 8: choosing between the progressive and the nonprogressive form	412
8.31	Argument 9: T-simultaneity is a unidirectional relation	414
8.32	Argument 10: the Dutch test	416

IV. Theoretical conclusions from these arguments	419
8.33 Theoretical conclusion 1	419
8.34 Theoretical conclusion 2	420
8.35 Theoretical conclusion 3	421
8.36 Theoretical conclusion 4	422
8.37 Theoretical conclusion 5	424
8.38 Theoretical conclusion 6	425
8.39 Theoretical conclusion 7	426
V. The principle of unmarked temporal interpretation	427
8.40 Introduction	427
8.41 The ‘Principle of Unmarked Temporal Interpretation’	427
VI. Summary of chapter 8	434
8.42 Terminology	434
8.43 Evidence for the existence of two past tenses	435
8.44 Further theoretical conclusions	437
8.45 The role of (non)boundedness in the unmarked temporal interpretation of situations	438

DEMO

Abstract

In the previous chapters we provided an overview of the four absolute tenses in English: the present tense, the past tense (or preterite), the present perfect tense and the future tense (which we discussed together with ‘futurish tense forms’). The current chapter deals with the notion of ‘temporal domain’, which is established by an absolute tense form and which can be expanded by one or more relative tense forms. For example, in the sentence *Mary told me she felt sick*, the first past tense form (*told*) is an absolute tense form, establishing a past domain, while the second past tense form (*felt*) is a relative one, representing the situation of feeling sick as simultaneous with the telling.

In part I (= sections 8.1–8.14) we first recapitulate (and in some cases further develop) some of the key concepts we introduced in chapter 2. We begin by stressing the difference between ‘full situation’ and ‘predicated situation’. For instance, in the example above, the full situation of Mary feeling sick takes up a longer portion of time than the predicated situation, which is ‘temporally bound’ by (more specifically, represented as T-simultaneous with) the virtually punctual situation of telling and whose duration is thus confined to the time taken up by the telling situation (since T-simultaneity is defined as coincidence).

Part II (= sections 8.15–8.22) lays out the additional conceptual machinery we need to talk about temporal domains, such as ‘central time of orientation’, ‘T-simultaneity’, ‘W-simultaneity’, ‘head clause’, ‘matrix’, ‘shift of domain’ and ‘shift of temporal perspective’.

In part III (= sections 8.23–8.32) we adduce no fewer than ten arguments in support of the claim that there exist two distinct past tenses in

English, viz. the ‘absolute past tense’ and the ‘relative past tense’. The most decisive argument is based on the observation that a past tense form can be used to refer to a situation that lies in the future rather than in the past, as shown by the last verb form (*felt*) in *Mary told me on the phone last night that at the dinner party tomorrow she would suddenly say that she felt sick*. This means that not all past tense forms locate a situation in the past. An absolute past tense form does, but a relative past tense form just expresses coincidence between two times in a past domain and can therefore be used even if the two times are interpreted as lying in the future, as in the above example.

In part IV (= sections 8.33–8.39) we draw a number of theoretical conclusions based on the arguments adduced in the preceding part. Among other issues, we take a stance with respect to the question whether we are dealing with two past tenses being homophonous or with a single past tense morpheme with ambiguous meaning.

Part V (= sections 8.40–8.41) is devoted to default principles guiding the interpretation of temporal relationships between consecutive clauses with absolute tense forms. We show how, in the absence of any direct linguistic clues as to the temporal relations holding between the situations, the (non)boundedness of the situations involved is of central importance. For example, the bounded situations in *John went to the door and knocked three times* are interpreted in terms of temporal succession, whereas the nonbounded situations in *John stood by the window and enjoyed the scenery* are interpreted in terms of temporal coincidence.

Part VI provides a summary of chapter 8.

I. Introduction

In chapter 2 and elsewhere a number of concepts and definitions have been introduced. Since these are essential to a good understanding of what follows, we will start by summarizing them (and in some cases elaborating on them).

8.1 Full situation *vs* predicated situation

8.1.1 We have defined the **FULL SITUATION** as the complete situation as it actualized in the past, has actualized (or has been actualizing) in the pre-present, is actualizing at t_0 or is expected to actualize in the post-present. The **PREDICATED SITUATION** is that part of the full situation (possibly all of it) about which a claim is made in the clause. As is clear from *Ten minutes ago John was in the library* (which does not exclude the possibility that John is still there), it is the predicated situation rather than the full situation that is located in time by the use of the tense form – see 2.12.1.

8.1.2 In connection with the ‘continuative (W-)interpretation’ (see 5.6) of the present perfect, we have distinguished further between the **FACTUAL FULL SITUATION** and the **POTENTIAL FULL SITUATION** (see 5.7). The factual full situation is that part of the full situation (possibly all of it) that leads up to and includes t_0 . The potential full situation is the full situation including that part, if any, that follows t_0 . Thus, in *John has been sleeping for seven hours now*, the factual full situation covers a seven-hour period reaching up to (and including) t_0 .¹ Since John may keep on sleeping after t_0 , there is also an idea of a potential full situation whose length is unpredictable at t_0 . However, the potential part of a full situation (referred to by a ‘continuative present perfect’ – see 5.6) is not linguistically referred to; it can only be inferred. Thus, the above sentence *John has been sleeping for seven hours now* only asserts the factual (part of the) full situation, and the duration adverbial indicates the length of this factual part only. That John will probably go on sleeping for some (short or long) time after t_0 is a pragmatic inference based on our knowledge that it would be an exceptional coincidence if John woke up at the precise moment when the sentence was uttered (i. e. at t_0).

This distinction between a factual and a potential part of the full situation is not only necessary in connection with ‘continuative perfects’ but is also pertinent to present tense sentences like *John is sleeping*, because the full situation is durative and has a potential part (since it can extend into the future) while

1. Since, in the present perfect, the situation time can lead up to t_0 but cannot include it (see 5.2.1), the predicated situation differs from the factual full situation in that it does not include t_0 .

the predicated situation, which coincides with t_0 , is punctual. The distinction may also apply to sentences in the past tense, provided the ‘implicature of discontinuation’ (= the suggestion that the situation is over at t_0 – see 4.3) is cancelled, as in *Five minutes ago John was in the kitchen – he is probably still there*. In this case the full situation may possibly extend beyond t_0 and thus have a potential part.

As far as reference to the post-present is concerned, there is no distinction to be made between ‘factual’ and ‘potential’ *full* situation because there is no part of the full situation that includes t_0 (and is therefore factual): the entire full situation lies in the post-present.

In the present chapter we will not need to refer explicitly to the distinction factual *vs* potential, because only factual situations are relevant to the discussion. We will therefore simply speak of ‘full situation’. This term will always have to be interpreted as ‘factual (part of the) full situation’. (As a matter of fact, in this chapter, which is concerned with temporal domains and relative uses of tenses, the notion of ‘full situation’ will hardly ever need to be referred to. Much more important will be the notion of ‘predicated situation’, since relative tenses express a relation between a situation time (= the time of a predicated situation) and another orientation time – see 8.1.3.)

8.1.3 The distinction between ‘full situation’ and ‘predicated situation’ leads to a further distinction between the ‘**TIME OF THE FULL SITUATION**’ and the ‘**TIME OF THE PREDICATED SITUATION**’ (or **SITUATION TIME**). It is the situation time rather than the time of the full situation that is located in time by the tense form used – see 2.12.1.

(on the telephone) [You can come at three if you like.] I’ll be at home. (*It is possible that the full situation of the speaker being at home has already started – i.e. the speaker is at home and the full situation of his being at home will still be continuing at three. However, the statement I’ll be at home does not represent the time of the predicated situation as coinciding with t_0 . It represents it as coinciding with the time indicated by at three.*)

8.1.4 The predicated situation can only form a proper subpart of the full situation if it is representative of the latter, i.e. if the full situation is represented as homogeneous. A situation is represented as **HOMOGENEOUS** if the verb phrase representing it can be used not only to refer to the full situation but also to refer to parts of that situation (see 1.36.4). This is the case in each of the following examples:

John said he was ill. (*The time taken up by John’s utterance is much shorter than the time of the full situation of his being ill. Still, the sentence is fine, even on the reading in which the being ill is taken to be represented as T-simultaneous (i.e. as coinciding – see 2.17) with the saying, because he was ill represents the full situation as homogeneous, which means that the time of the predicated situation can be a*

proper subinterval of the time of the full situation, and can therefore coincide with the time of saying.)

John said that at that very moment he {was reading / *read} a book. (*The time of saying is much shorter than the time of reading the book. The that-clause is fine in the progressive because be reading a book is a homogeneous VP. The sentence is ungrammatical with he read a book because this clause is nonhomogeneous.*² *In this case the time of the predicated situation (= the situation time of he read a book) cannot coincide with the time of saying because it cannot be a proper subinterval of the time of the full situation of reading a book: this renders read a book unacceptable because reading a book takes up considerably more time than saying something.)*

The artist whistled while she worked. (*Both clauses are homogeneous.*)

At 5 p.m. I was at home. (*homogeneous*)

At the time I walked to work. (*The sentence is interpreted as ‘at that time I was in the habit of walking to work’, which is a homogeneous situation.*)

At 5 p.m. I was walking. (*atelic VP + progressive aspect → homogeneous clause*)

At 5 p.m. I was walking home. (*telic VP + progressive aspect → homogeneous clause*)

When the full situation is not (represented as) homogeneous, the predicated situation cannot be a subpart of the full situation. (A proper subpart of a nonhomogeneous situation cannot be representative of the whole situation). Instead, when the actualization of a situation is represented as nonhomogeneous, the predicated situation coincides with the full situation. The following examples represent the situation as heterogeneous (nonhomogeneous):

I wrote two letters this morning. (*The sentence can only refer to the situation as a whole, not to any portion of it.*)

John ran around the lake before breakfast. (*id.*)

John was in his office until 8 p.m. (*idem: there is no portion of ‘being in one’s office until 8’ that is itself an instance of ‘being in one’s office until 8’. In this case it is the until-phrase that renders the sentence bounded and hence nonhomogeneous.*)

8.1.5 The distinction between homogeneous and nonhomogeneous (heterogeneous) situations coincides with the distinction between **L-NONBOUNDED** (i. e. not linguistically represented as bounded) and **L-BOUNDED** (= linguistically represented as bounded) situations – see 1.44.2. As explained in 1.44.1, a situation is L-bounded if it is represented as reaching a terminal point. Thus, *John ran a mile* represents its situation as bounded because it combines a telic VP (implying an inherent terminal point) with nonprogressive (perfective) aspect: the situation is referred to as a whole (from beginning to end), and therefore as reaching the inherent terminal point. The sentence *John will run*

2. A clause representing a telic situation as bounded (by using a nonprogressive verb form) is automatically heterogeneous (= nonhomogeneous) – see 1.45.

for two hours represents its (atelic) situation as L-bounded in the not-yet-factual-at- t_0 world referred to because the duration adverbial involves reference to a terminal point and the nonprogressive aspect refers to the post-present situation as a whole.

The reader should keep in mind that, because L-boundedness is not a characteristic of the situation referred to (which is something extralinguistic) but rather of a particular kind of linguistic representation of a situation, we have adopted the habit of applying the label ‘L-bounded’ not only to (actualizations of) situations that are represented as L-bounded by the clauses referring to them but also to clauses which represent (the actualization of) a situation as L-bounded – see 1.44.1.

8.2 Orientation time & situation time

8.2.1 We call any time functioning as the origin of a temporal relation expressed by a tense form a **TIME OF ORIENTATION** (or **ORIENTATION TIME**). As noted in 2.14, there are five types of orientation time: t_0 , situation times, (otherwise unspecified) orientation times ‘contained’ in an Adv-time, orientation times that are ‘implicit’ in the meaning of a temporal conjunction, and ‘unspecified’ orientation times.

- (a) In sentences like *I left yesterday*, the orientation time t_0 to which the time of the predicated situation is T-related is t_0 . Tenses that T-relate the time of a predicated situation directly to t_0 are called absolute tenses (see 2.44.)
- (b) In *John said that Bill had left*, the past tense form *said* locates the time of its predicated situation anterior to t_0 , whereas the past perfect form *had left* locates its situation time anterior to the time when John spoke. This shows how a situation time can itself be the orientation time to which another situation time is T-related. In fact, since the time of a predicated situation can always serve as the origin of a temporal relation, any situation time is at least a potential orientation time.³

John stayed in the kitchen after he had finished his dinner. (t_0 functions as the orientation time to which the situation time of John staying in the kitchen is represented as anterior, and this situation time is the orientation time to which the situation time of John finishing his dinner is represented as anterior.)

- (c) A third type of orientation time is an (otherwise unspecified) time ‘contained in’ an **ADV-TIME** (= a time indicated by a time adverbial), as in *At*

3. This is why in earlier work we referred to a situation time as a ‘situation-time of orientation’ (abbreviated to ‘TO_{sit}’ in Declerck (1991) and to ‘STO’ in Declerck (1997) and Declerck & Reed (2001)).

that time Bill had (already) left the room. (In section 2.23.1 we went into the special way in which a time adverbial indicates an orientation time by ‘containing’ it in terms of either inclusion or coincidence.)

- (d) An orientation time may also be **IMPLICIT** in the semantic structure of a temporal conjunction. For example:

I will be exhausted {before / when / by the time that} this job *is finished*.

Here the situation time of the job being finished is represented as T-simultaneous with the implicit orientation time in the temporal structure of *before* (which means ‘before the time that’ – see 14.2.1) or *when* (which means ‘at the time that’ – see 13.1.2) or *by the time that* (where the implicit orientation time is overtly lexicalized as *the time*).

- (e) When we use *Bill had left* in isolation, we interpret the time of the predicated situation as anterior to an ‘unspecified orientation time’ which is understood as being anterior to t_0 . An orientation time is **UNSPECIFIED** if it is neither t_0 nor the time of a predicated situation nor a time contained in an Adv-time nor an orientation time that is ‘implicit’ in the semantic structure of a temporal conjunction. For a good understanding of *Bill had left*, the unspecified orientation time to which Bill’s leaving is T-anterior will have to be recoverable from the context.

8.2.2 As noted in 8.1.4, the situation time (= the time of the predicated situation) can only be a subinterval of the time of the full situation if the situation is represented as homogeneous. Thus, in *At 7 p.m. John was still in the library* the situation time is a punctual time coinciding with the punctual Adv-time (see 2.23) specified by *at 7 p.m.*, but *still* implies that the full situation of John’s being in the library started before 7 p.m. It is therefore important to distinguish carefully between ‘the time of the predicated situation’ (= situation time), which is a **T-CONCEPT** (i.e. a concept relevant to the description of the tense system), and ‘the time of the full situation’, which is a **W-CONCEPT** (i.e. a concept which has to do with the interpretation of situations and temporal relations in the actual world or in whatever alternative world is being referred to). A tense temporally locates a situation time and does not say anything about whether that situation time is the time of the full situation or not.

8.3 Temporal relations expressed by tenses: T-relations

A tense form can relate a situation time to an orientation time in three different ways:

- (a) *T-simultaneity*: the tense represents the situation time as simultaneous with the orientation time. It is in keeping with the distinction between ‘situation

time' and 'time of the full situation' that T-simultaneity is defined as a relation of **STRICT COINCIDENCE**.

- (b) *T-anteriority*: the tense represents the situation time that is temporally 'bound' (see 2.49) as preceding the 'binding' orientation time in either of two ways. Either the situation time lies completely before the orientation time, as in [*He claimed that*] *I had locked the door*, or it begins before the orientation time and leads up to it (without including it), as in [*By the time Gertie and I went to Iceland,*] *we had been friends for years*.
- (c) *T-posteriority*: the tense represents the bound situation time as following the binding orientation time in either of two ways. Either the situation time lies completely after the binding orientation time, as in [*I promised*] *I would do it the next day*, or it begins immediately after the binding orientation time, as in [*He said that*] *from then onwards he would call me Jim*.

We refer to a temporal relation expressed by a tense form as a **TENSE RELATION** (or **T-RELATION**).

8.4 Temporal relations not expressed by tenses: W-relations

8.4.1 A situation may be interpreted as simultaneous, anterior or posterior to another situation without this being expressed by a tense form. In that case the temporal relation in question is not a tense relation but simply a relation that is inferred (for reasons referred to in 8.4.2) to exist in the real world (or in whatever alternative world is being referred to). We refer to such temporal relations as **WORLD-RELATIONS** (or **W-RELATIONS**).

When they *had first visited* the house, they *hadn't noticed* the wet patch on the ceiling of the kitchen. (*The past perfect tenses each locate their situation time anterior to an (unspecified) past orientation time. The relation of W-simultaneity that is understood to exist between the two situations is not expressed by the tense forms.*)

John *told* me he *wrote* Jim a letter. (*The past tense forms merely locate their situation times in the past. The use of the nonprogressive form wrote means that the durative situation of John writing Jim a letter is referred to in its entirety. Since the VP is telic, this means that the writing is represented as finished – see 1.39.1–2. Pragmatic knowledge tells us that this interpretation requires that the writing should be understood as W-anterior to the telling.*)

The distinction between 'T-' and 'W-' will not only be applied to relations but also to temporal interpretations: a '**T-INTERPRETATION**' is a temporal reading which is based on the semantics of the chosen tense only; a '**W-INTERPRETATION**' also takes into account such elements as temporal adverbials, context, situation

of speaking, knowledge of the world and pragmatic principles such as the Gricean Maxims of conversation.

8.4.2 Unlike simultaneity expressed by a tense form (T-simultaneity), W-simultaneity is not a semantic relation but a pragmatic one. In other words, while T-simultaneity forms part of the semantics of certain tenses, W-simultaneity is to be inferred from various factors, including the context and/or pragmatic knowledge. It follows (a) that W-simultaneity is a question of pragmatic *interpretation* rather than linguistic *representation* only, and (b) that W-simultaneity is a less rigid temporal relation than T-simultaneity: whereas the latter is equivalent to coincidence, what counts as W-simultaneity can, according to context, be coincidence, overlap or inclusion. In other words, two time intervals are W-simultaneous the moment they have one point of time in common (see 2.18.2). This is illustrated by the following:

Jim was in London yesterday. I saw him there.

The two sentences here use an absolute past tense form, each creating a domain of its own. The two past domains are interpreted as W-simultaneous with each other. In this case the most natural interpretation of the W-simultaneity is that of inclusion: the situation of Jim being in London temporally included the situation of my seeing him there.

8.5 The two ‘time-spheres’

In English, the use of tenses implies a division of time into two (rather than three) distinct ‘time-spheres’: the present time-sphere and the past time-sphere (see 2.33 for arguments supporting this claim). The **PRESENT TIME-SPHERE** is conceived of as a time span of indefinite length which includes the temporal zero-point (t_0). The **PAST TIME-SPHERE** is conceived of as a time span of indefinite length which lies wholly before t_0 and is disconnected from t_0 . The absolute tense locating a situation time in the past time-sphere is the past tense (preterite). (As explained in 2.41, an absolute tense is a tense that relates a situation time directly to t_0 and not to another orientation time.)

I left the house around midnight. (*Left* locates its situation time in the past time-sphere, which is defined in direct relation to t_0 .)

8.6 Present time-sphere zones

The zero-time (t_0) is taken to divide the present time-sphere into three **TIME-ZONES** (or **ZONES**). The portion of the present time-sphere that precedes t_0 (and leads up to it) is the ‘pre-present zone’; the portion that coincides with t_0 is the

‘present zone’; and the portion that follows t_0 (and starts immediately after t_0) is the ‘post-present zone’.

To locate situations in these three zones we use the present perfect, the present tense and the future tense (or a ‘futurish form’ – see 7.3.1), respectively. Each of these tenses shows present (nonpast) morphology.

I have already read that article. (Have read is a present perfect tense form locating its situation time somewhere in the pre-present zone.)

I am very angry with her. (Am locates its situation time at t_0 .)

I {will / am going to} be in France tomorrow. (Note that am going to be locates its situation time in the post-present. As stressed in 2.13.2, the situation time is the time of the actualization of the predicated situation, not the time of anticipation of that actualization. See also the definition of ‘tense’ in 2.12.1 and the discussion of futurish forms in 7.3.)

8.7 Visual representation of time-spheres and zones

As noted in 2.36, the linguistic conceptualization of time in terms of time-spheres and zones can be represented as in Figure 8.1. In this diagram the time line is represented as consisting of two time-spheres. The dotted line in the middle of the time line represents the fact that there is felt to be a break between the two time-spheres. (As stressed in 2.36, the diagram should not be interpreted as representing the pre-present as more recent, i.e. closer to t_0 , than the past – see also 2.39.)

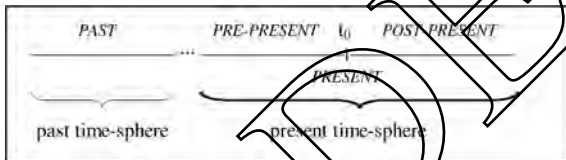

Figure 8.1. Linguistic conceptualization of the time line in English.

8.8 Absolute zones

Whereas the present time-sphere is automatically divided into three zones by t_0 , the past time-sphere consists of a single time-zone, which is defined as lying completely before t_0 . The past time-sphere and the three present time-sphere zones can therefore be said to make up the set of **ABSOLUTE ZONES**, i.e. the four time-zones that are defined in direct relation to t_0 . (Note that, because the past time-sphere consists of only one zone, it does not really matter whether we speak of ‘past zone’ or ‘past time-sphere’.)

8.9 The length of the time-spheres and zones

Except for the present zone, which is by definition conceived of as punctual (see 2.35), the length of the time-spheres and the zones cannot be defined in terms of objective time. As noted in 2.39, everything depends on how the speaker conceptualizes time. Thus, the pre-present can be conceived of either as very short (e.g. *I have just met your brother*) or as stretching indefinitely far back (e.g. *The universe has always existed*), while the past time-sphere may be conceived of as distant from t_0 (e.g. *In those days Cleopatra ruled over Egypt*) or as almost reaching up to it (e.g. *The manager left his office a minute ago*). It follows that one and the same situation can often be conceptualized either as lying in the past time-sphere or as lying in the pre-present (compare *I met her just now* with *I have just met her*). This is in keeping with the observation (made in 2.36) that the past time-sphere is not conceptualized as more distant from t_0 than the pre-present zone. (The past time-sphere is conceived of as *separated* from the present time-sphere, whereas the pre-present zone forms part of it, but the actual distance between the situation time and t_0 is immaterial to this conceptualization.)

8.10 Absolute vs relative tenses

An **ABSOLUTE TENSE** relates its situation time (= the time of its predicated situation) directly to t_0 by locating that situation time in one of the absolute zones. As we have seen, English uses the (absolute) past tense, the present perfect, the present tense and the future tense (or one of the ‘futurish tense forms’ – see 2.9) to locate a situation in the past, the pre-present, the present and the post-present, respectively.

A **RELATIVE TENSE** relates its situation time to an orientation time other than t_0 . In doing so it expresses a T-relation in a temporal domain (see 8.11 below).

The two terms can be illustrated by the sentence *Yesterday I already knew that I was getting ill*. Here *knew* is an absolute past tense form representing its situation time as lying in the past, while *was getting* is a relative past tense form representing its situation time as T-simultaneous (= coinciding) with the situation time of *knew*.

8.11 Temporal domain

8.11.1 A **TEMPORAL DOMAIN** has been defined as a structured set of orientation times with the following characteristics: (a) except for the ‘central orientation time’ – see 8.15, each orientation time is temporally related to another orientation time in the domain by means of a tense; (b) at least one of the

orientation times in the domain is a situation time (see 2.15.4). A domain is established by an absolute tense form and expanded by relative tense forms. Thus, in *John said he had worked hard all day*, the reference is to a past domain. This is established by the absolute past tense form *said* and expanded by *had worked*, which is a relative tense form representing its situation time as T-anterior to the situation time of *said*. See Figure 8.2.

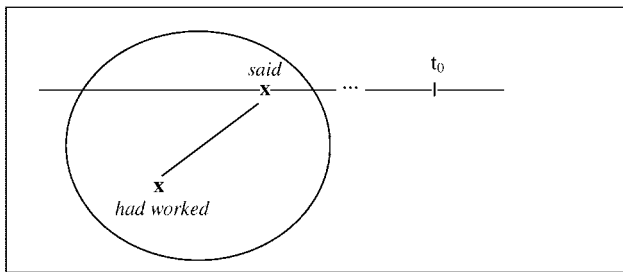

Figure 8.2. The tense structure of *John said that he had worked hard all day*.

When representing a temporal domain by means of a diagram, we observe the following conventions. The domain is represented by a Venn-diagram because it is a set of orientation times (each related to another orientation time by a tense form). The ‘central orientation time’ (see 8.13) is the only orientation time that is placed on the time line, since it is the only orientation time that is directly related to t_0 . A vertical line is used to represent the relation of T-simultaneity, whereas a slanting line represents either T-anteriority or T-posteriority. A situation time that is T-anterior to its binding orientation time is located to the left of the latter; a situation time that is T-posterior to its binding orientation time is located to the right of the latter. All orientation times and situation times are represented by a cross (or ‘x’), irrespective of whether they are durative or punctual.

8.11.2 A domain is **UNEXPANDED** when it consists of just one situation time. In that case the set of orientation times forming the domain is a singleton. An example of this is *He left at five and I will leave at eight*, where each tense form establishes a domain of its own (the one in the past, the other in the post-present), neither of which is further expanded.

8.12 Two past tenses: the absolute preterite vs the relative preterite

English has an **ABSOLUTE PAST TENSE**, which establishes a past domain, as well as a **RELATIVE PAST TENSE**, which expresses T-simultaneity in a past domain.

The semantics of the absolute preterite is ‘The situation time is located in the past time-sphere (defined relative to t_0)’; the semantics of the relative preterite is: ‘The situation time is T-simultaneous with an orientation time in a past domain’.⁴ Arguments for this distinction are adduced in sections 8.23–32 below.

8.13 Past *vs* present (time-sphere) tenses

The past (time-sphere) tenses are the tenses showing past tense morphology: the absolute past tense, the relative tenses expressing a single relation in a past domain, viz. the relative past tense (T-simultaneity), the past perfect (T-anteriority) and the ‘conditional’ tense (T-posteriority), and the complex-relative tenses with past tense morphology, viz. the ‘conditional perfect’ tense (*would have V-en*) and such (nameless) tenses as are built with *had been going to*, *would have been going to* and *would have been going to have V-en*.

The present (time-sphere) tenses are the tenses showing present tense morphology. These are the present tense, the present perfect, the future tense (plus the present tense of the ‘futurish’ tense forms) and the absolute-relative tenses (i. e. the future perfect and such (nameless) tenses as are built with *have been going to*, *will have been going to* and *will have been going to have V-en*).⁵

8.14 Temporal subordination or temporal binding (T-binding)

By this we mean the phenomenon that a tense form T-relates a situation time to another orientation time in a domain. Thus, in *John said he would do*

4. This is actually a simplification. In 9.17.1 we will see that a post-present binding orientation time may be treated as if it were t_0 , i. e. as a ‘pseudo- t_0 ’, and that in that case we can speak of a ‘pseudo-past time-sphere’ and ‘pseudo-past subdomains’. A pseudo-past subdomain is established by a ‘pseudo-absolute’ past tense and expanded by the relative tenses typical of (true) past domains:

(i) [Even if there are] witnesses to the hold-up we are planning] they will no doubt say to the police that they *didn’t notice* what *was going on*.

In this example, *didn’t notice* is a pseudo-absolute past tense form establishing a pseudo-past subdomain in the post-present domain established by *will say*; *was going on* expresses T-simultaneity in that pseudo-past subdomain – see section 9.18.3. It follows that the correct definition of the semantics of the relative past tense is: ‘The situation time is T-simultaneous with an orientation time in a past or pseudo-past domain or subdomain’. (Another example of a relative past tense expressing T-simultaneity in a pseudo-past (sub)domain is when a pre-present domain is developed as if it were a past one: *He’s told me once or twice that he was an only child* – see 9.10.1.)

5. Judging from the Internet, some of these ‘nameless’ tenses are hardly ever used, but this does not alter the fact that they are theoretically possible and that their semantics (i. e. the structure of temporal relations which they express) is fully transparent.

it, the situation time of *would do* is **TEMPORALLY BOUND** by (= **TEMPORALLY SUBORDINATED** to) the situation time of *said*. The latter is the **BINDING ORIENTATION TIME**. In order to avoid any confusion with other meanings attributed to the terms ‘bind’, ‘binding’ and ‘bound’ in the linguistic literature (e. g. ‘bound pronouns’, ‘bound variables’) we will regularly use ‘**T-BIND**’, ‘**T-BINDING**’ and ‘**T-BOUND**’ in our discussion of T-relations (i. e. temporal relations expressed by tenses – see 2.16.1).

It is important to see that T-binding is only possible within one and the same temporal domain. A T-relation between a situation time and t_0 is not a T-binding relation: in a clause using an absolute tense, the situation time is by definition not T-bound (i. e. not temporally subordinated).

DEMO

II. Temporal domains: further terminological apparatus

The one orientation time that is not T-bound by any other in a domain is the **central orientation time**. The absolute zone in which it is located determines the overall temporal nature of the domain. Thus, in *(He said) he would do it tomorrow*, the situation time referred to by *would do* forms part of a past domain, established by the past tense form *said* (or, in the absence of a head clause in the past tense, by an unspecified central orientation time located in the past zone). There is a certain correlation between temporal subordination and **syntactic subordination**: for one, the use of a relative tense to express T-simultaneity is excluded in a syntactically independent clause; for another, the use of an absolute tense is excluded in some types of subclauses.

If a situation time is represented as **T-simultaneous** with another situation time, the exact duration and temporal location of the T-bound situation time is unidirectionally determined by the binding situation time. Thus, in *I noticed at once that Jim was ill*, the situation time expressed by *[Jim] was [ill]* strictly coincides with the time of my noticing it, which is merely a point (rather than a durative interval) in the past time-sphere. Of course, the full situation time of Jim being ill will be extralinguistically interpreted as much longer than, and as properly including, the time of me noticing it and may possibly even include t_0 , which shows that **W-simultaneity** is a concept quite different from T-simultaneity.

Sometimes the speaker does not use a relative tense form, expanding an already established domain, but instead uses an absolute tense form, causing a **shift of domain**, either within the same time-zone or from one time-zone to another. When the shift of domain is within the same zone, the hearer may draw clues as to the temporal ordering of the situation times from such sources as the presence of temporal adverbials, the order of appearance of the clauses, the linguistic and extralinguistic context, his pragmatic knowledge of the world or, as will be summarized below in 8.45, the (non)-bounded representations of the situations referred to.

We speak of a **shift of temporal perspective** when a situation intended to be interpreted as located in one absolute zone is referred to by a tense form that is characteristic of another zone, as when the present tense is used with reference to the post-present zone (e.g. *They're leaving soon*), to the past zone (e.g. *Napoleon strikes back*) or to the pre-present zone (e.g. *I hear John has been promoted*).

8.15 Central time of orientation (central orientation time)

The **CENTRAL ORIENTATION TIME** is the one orientation time in the domain that is not T-bound by any other orientation time in the domain but is directly

related to t_0 . In most cases the central orientation time is the situation time of the clause which establishes the domain by using an absolute tense form (as in *He left yesterday*). When an absolute-relative tense is used (e.g. *He will have left by tonight*) the central orientation time is the unspecified post-present orientation time (here ‘contained’ in the Adv-time specified by *tonight*) to which the situation time is temporally subordinated. As noted in 2.42.2, the central orientation time is the only orientation time of the domain that is put on the time line when we represent the semantics of a tense (i.e. the tense structure) by means of a tense diagram.

8.16 The temporal nature of the domain

The temporal nature of the domain is determined by the absolute zone in which the central orientation time is located. Thus, in *He said he would do it tomorrow* the reference is to a past domain, established by *said*. The form *would do* locates its situation time in that past domain, even though the ‘doing it’ is W-understood as lying in the post-present. Similarly, in *He would do it tomorrow* (interpreted as free indirect speech), the situation time forms part of a past domain because the unspecified central orientation time (= the time of ‘his’ thinking, saying, etc.) which T-binds the situation time is located in the past time-sphere. This definition of the nature of a temporal domain accords with the claim that a relative tense expresses no temporal relation other than a domain-internal relation between a T-bound situation time and a T-binding orientation time. (As pointed out in 2.16.1, tenses express T-relations, not W-relations.)

8.17 The definition of T-simultaneity

8.17.1 As noted in 2.16.1, the simultaneity relation expressed by a relative tense form can be referred to as **T-SIMULTANEITY** (‘tense simultaneity’) in order to distinguish it from **W-SIMULTANEITY** (‘world simultaneity’ – see also 8.18.1). In section 2.17, T-simultaneity was defined as a relation of *strict coincidence*. This is in keeping with the distinction made between a situation time (the time of a ‘predicated situation’ – see 8.1.3) and the time of a full situation: what is represented as T-simultaneous with an orientation time is always a situation time, not the time of a full situation.⁶ Thus, in *I noticed at once that Jim was ill*, the situation time expressed by [*Jim*] *was* [*ill*] and represented as T-simultaneous (coinciding) with the situation time of [*I*] *noticed* is only a subin-

6. Of course, if the situation is L-bounded, the situation time is also the time of the full situation – see 2.12.2.

terval of the time of the full situation of Jim's being ill. This subinterval is identified through the relation of coincidence with the binding orientation time. (This implies that, since the situation time of *noticed* is interpreted as punctual, the situation time of *was* is also punctual, i. e. a punctual interval of the homogeneous durative full situation of Jim being ill.)

8.17.2 It follows that T-simultaneity is a **UNIDIRECTIONAL** relation: the bound situation time derives its temporal specification from the relation of coincidence with the T-binding situation time, not the other way round. This means (a) that the duration of the T-simultaneous situation time is determined by the duration of the T-binding situation time, and (b) that the precise temporal location of the T-simultaneous situation time in a particular time-zone is determined by the precise temporal location of the T-binding situation time in that time-zone.

8.18 The definition of W-simultaneity

8.18.1 In 2.18, **W-RELATIONS** were defined as temporal relations that exist in the (real or nonfactual) world referred to but are not necessarily expressed by a tense form. Thus, two situations are (interpreted as) W-simultaneous if the times of the two full situations are interpreted as coinciding with each other or as overlapping (i. e. as having at least one point in common), even if there is no tense form expressing T-simultaneity. See 2.18.2 for some illustrations.

8.18.2 The times of two W-simultaneous situations can be referred to by absolute tense forms, which locate the two situation times in two different temporal domains within the same time-zone. In that case neither situation time is T-bound by the other, but the two situation times are the central orientation times of two different **W-SIMULTANEOUS DOMAINS** (i. e. separate domains which are *interpreted* as W-simultaneous). For example:

He looked at the figure in the distance but *didn't recognize* him. (Both *preterites* establish a T-domain of their own, but these are interpreted as W-simultaneous with each other.)

He watched the spectacle and thoroughly *enjoyed* it. (*idem*)

Someone *has used* my bike and *has damaged* it (while doing so). (W-simultaneous pre-present domains)

8.18.3 It is also possible to locate the situation times of two W-simultaneous situations in the same domain. This is the case not only if one of the situation times is related to the other in terms of T-simultaneity (= coincidence), but also in cases of 'indirect binding'. As we will see in 9.28, **INDIRECT BINDING** means that the situation time of a subclause is T-bound, not by the situation

time of its head clause but by the situation time of the superordinate clause T-binding that head clause. In such cases the situation time of the subclause may be interpreted as W-simultaneous with the situation time of its head clause (though the former is not represented as T-simultaneous with the latter). Consider the following examples:

[I remembered that] I *had met* a man who *had been wearing* blue jeans.

[I remembered that] when I *had* first *met* him he *had been wearing* blue jeans.

In both these examples, the situation times of *had met* and of *had been wearing* are interpreted as W-simultaneous with each other, but neither tense form expresses this W-simultaneity relation: both situation times are related as T-anterior to the situation time of *remembered* – see Figure 8.3. (The wavy line in Figure 8.3 represents the W-simultaneity relation not expressed by the tense form.) The kind of T-binding illustrated by *had met* will be called ‘indirect binding’.

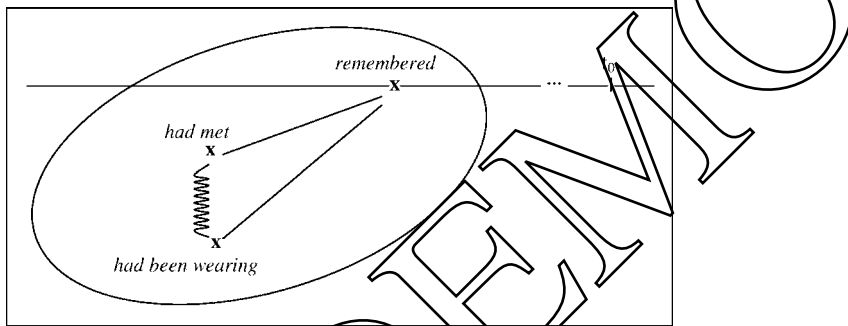

Figure 8.3. The tense structure of *I remembered that when I had first met him he had been wearing blue jeans.*

8.18.4 Unlike the T-simultaneity relation expressed by a relative tense, W-simultaneity need not be a relation of coincidence: it may also be a relation of inclusion (overlap) – see 2.18.2. Consider:

[I remembered that] I *had met* Tim briefly at a party, where he {*was wearing* / *had been wearing*} a tuxedo.

Here the situation of Tim wearing a tuxedo is interpreted as W-simultaneous with the situation of my meeting Tim, but, since the latter situation is interpreted as shorter than the former, W-simultaneity here means inclusion. Similarly, in

I don't want to tell him that. I'm a coward.

the two situations (located in different present domains) are interpreted as W-simultaneous, but they do not coincide: the second includes the first.

8.19 Temporal subordination *vs* syntactic subordination

There is a certain correlation between temporal binding and syntactic subordination:

- (a) Syntactically independent clauses cannot use a relative tense expressing T-simultaneity. This applies not only to the relative past tense but also to any other tense expressing T-simultaneity, such as the present tense used to express T-simultaneity in a post-present domain (see 10.3.1). Compare:

[If you do that] I will tell your mother that you are being naughty. (*Will tell* establishes a post-present domain, while *are being* expresses T-simultaneity in it and is therefore also W-interpreted as referring to a post-present situation.)

You are being naughty. (*In isolation this is not interpreted as referring to a post-present situation. The reason is that in a syntactically independent clause we cannot use the present tense as a relative tense form. Rather, it is an absolute tense form establishing a present domain.*)⁷

- (b) Some kinds of adverbial subclauses (e.g. *if*-clauses referring to the future and expressing an ‘open’ condition) cannot use an absolute tense (e.g. *The party will be ruined if it {rains / *will rain}.*)

However, the correlation between temporal subordination and syntactic subordination is far from perfect, as is clear from the following three considerations. Firstly, some types of subclause may or may not show T-binding: *He said he {would / will} come.* (*Would come* is a relative tense form, *will come* is an absolute one.) Secondly, relative tenses, which effect T-binding, may sometimes occur in syntactically independent clauses. This is the case, for example, when a sentence like *He had worked hard all day* is the opening sentence of a novel. Thirdly, in a sentence like *The boy who told us about the accident had witnessed it himself*, the subclause uses an absolute tense form while the head clause uses a relative tense form (effecting temporal subordination, i. e. T-binding).

8.20 Definition of ‘head clause’ and ‘matrix’

By **HEAD CLAUSE** we mean *superordinate clause*. This is the clause on which a given subordinate clause (subclause) is syntactically and semantically depend-

7. There exist present tense forms that refer to the post-present in a syntactically independent clause (e.g. *I’m leaving tomorrow*), but these are not relative tense forms but ‘futuristic forms’ establishing a post-present domain – see 2.9.

ent. A head clause may be a clause that does not syntactically depend on any other clause, but it may also itself be a subordinate clause. If it is a syntactically independent clause, it can also be referred to as the **MATRIX**, i. e. the highest clause in the inverted tree structure representing the syntactic structure of a sentence.⁸

I knew he had told a lie when he had accused them of treason. (*I knew is the matrix. It is the head clause of he had told a lie, which is itself the head clause supporting the when-clause.*)

8.21 Shift of domain

8.21.1 We speak of a **SHIFT OF DOMAIN** when, instead of expanding an already established domain, the speaker uses an absolute tense form to create a new domain. Compare:

John left after I *had arrived*. (*temporal binding*)

John left after I *arrived*. (*shift of domain – see 14.18.1*)

Jill has often come to tell me that she *had been beaten* by her husband. (*temporal binding*)

Sybil has never told me that she *has had* an abortion. (*shift of domain*)

A shift of domain can also be a shift from one absolute time-zone to another:

I was told he *will be* here tomorrow. (*shift from the past to the post-present*)

I've never met anyone who *lives* in Singapore.

In the following example, each clause establishes a domain of its own, as shown in Figure 8.4:

Suddenly the phone *rang*. Jill *stood up* from her chair, *went* to the telephone and *picked up* the receiver.

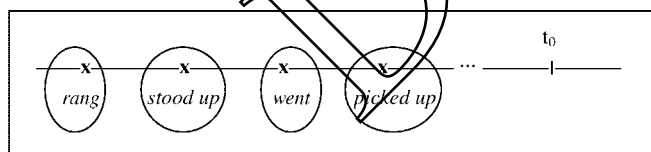

Figure 8.4. The tense structure of *Suddenly the phone rang. Jill stood up from her chair, went to the telephone and picked up the receiver.*

8.21.2 When there is a shift of domain within the same absolute zone, the two domains are established by forms of the same absolute tense. This means

8. 'Matrix' is sometimes used in the sense of 'superordinate clause'. We will not follow this practice.

that the tense forms themselves do not express the temporal relation between the two domains. It follows that such a shift of domain is only pragmatically acceptable if the temporal order of the situations is either irrelevant or recoverable in some other way, e.g. from the use of time adverbials, from the order in which the situations are reported, from the linguistic context, from pragmatic knowledge (i.e. the extralinguistic context and our general knowledge of the world) or from the bounded or nonbounded aspectual character of the new clause and the preceding or following one.⁹ The role of (non)boundedness is discussed in 8.41, which deals with the ‘Principle of Unmarked Temporal Interpretation’.

The following is an example in which the precise temporal order of the situations is irrelevant:

[“What became of your two sisters?”] – “Betty married an Australian. Meg died in a car accident.”

8.22 Shift of temporal perspective

As noted in 2.20, this is the phenomenon that the tense system that is characteristic of a particular absolute zone is used in referring to another zone, i.e. a situation that is intended to be interpreted as located in one time-zone is referred to by a tense form whose basic meaning is to locate a situation time in another zone. The use of the present tense with post-present reference (e.g. *They’re leaving soon*) is a typical illustration of such a shift of perspective: the present tense is used although the situation referred to is interpreted as actualizing in the post-present. The domain established by the present tense is treated as a post-present domain when another situation time is introduced into it: *They’re leaving soon, in fact right after the performance has ended* – see 9.19.1. Another illustration of a shift of perspective is the use of the historic present: the present tense is used although the situation referred to is ‘bygone’, i.e. over at t_0 . (This is a metaphorical use of the present tense: the past time-zone is treated as if it were the present.) Another example (already mentioned in section 3.6) is the use of *I {hear / understand / am told / etc.} that ...* instead of *I have {heard / understood / been told / etc.} that ...* as in *I hear John has been promoted*.

9. As explained in 1.44, a situation is L-bounded if it is represented as reaching a (natural or arbitrary) terminal point. Otherwise it is L-nonbounded, i.e. not represented as L-bounded. A situation that is not *represented* as L-bounded can often still be *interpreted* as W-bounded for reasons that have to do with the context or with pragmatics.

III. Arguments for distinguishing between the absolute and the relative past tense

In section 8.12 we have claimed that English has two past tenses, i.e. two tenses which use the same past tense morphology and are therefore formally indistinguishable, but which differ in their semantics (temporal structure). An **ABSOLUTE PAST TENSE** establishes a domain in the past time-sphere, whereas a **RELATIVE PAST TENSE** expresses T-simultaneity in such a past domain. In other words, the semantics of the absolute preterite is: ‘The situation time is located in the past time-sphere (defined relative to t_0)’, while the semantics of the relative preterite is: ‘The situation time is T-simultaneous with an orientation time in a past domain or subdomain’. (A **SUBDOMAIN** is a domain – i.e. a set of one or more times – whose ‘central orientation time’ (see 8.15) is not directly related to t_0 but is a situation time or other orientation time ‘deeper down’ in a temporal domain. For example, *He said that he had admitted that he was sick* involves a temporal domain (whose central orientation time is the situation time of *said*), which itself involves a subdomain (whose central orientation time is the situation time of *had admitted*), which itself involves a (not further expanded) subdomain whose central orientation time is the situation time of *was*. See the representation in Figure 8.5.)

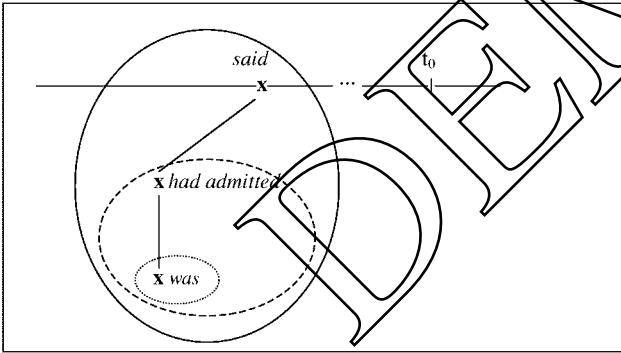

Figure 8.5. The tense structure of *He said that he had admitted that he was sick*.

Because there are many linguists who are not willing to accept the existence of a relative past tense, we will make a detour here to argue the case for it. (No fewer than ten arguments are presented here, the most cogent of which is argument 2. If the reader is convinced by this argument, s/he need not bother to scrutinize the further pieces of evidence.)

8.23 Argument 1: similarity between past and post-present domains

Let us start by adducing an argument that is suggestive rather than conclusive.

The view that the sentence *John felt unhappy when he was alone* contains both an absolute past tense form (*felt*) and a relative one (*was*) is corroborated by the fact that we clearly distinguish an absolute tense form (*will be*) and a form indicating T-simultaneity (*is*) in its post-present counterpart: *John will be unhappy when he {is / *will be} alone*.

8.23.1 Absolute preterites are not formally distinguishable from relative ones. However, tense forms used to establish a post-present domain (i. e. future tense forms or futurish forms – see 2.15) are formally distinguishable from tense forms used to express T-simultaneity with the central orientation time of a post-present domain, since (as we will see in 9.20.1) the latter are present tense forms. This suggests that we can identify the past tense form of a given clause by considering the corresponding post-present version of the clause. For example:

John was unhappy when he *was* alone.

John will be unhappy when he {*is* / **will be*} alone.

The second example shows that *is* is the only correct post-present counterpart of the form *was* in the first example. Since the future tense form *will be* is an absolute tense form, while the present tense in the *when*-clause expresses T-simultaneity with the central orientation time of the post-present domain,¹⁰ it seems intuitive to conclude that in the first example too, the head clause uses an absolute tense form and the time clause uses a tense form expressing T-simultaneity. If this conclusion is warranted, the possibility of using a ‘backshifted’ present tense form (i. e. a relative past tense form) in clauses expressing T-simultaneity with a situation time that is posterior to a past orientation time (rather than posterior to t_0) can be used as a simple and effective test to distinguish between relative and absolute past tense forms: the ‘backshifted’ version of the second example is [*I knew that*] *John would be unhappy when he {was / *would be} alone*.

10. This is a slight simplification. As we will see in 13.3–7, a present tense form in a *when*-clause does express T-simultaneity, but with an implicit orientation time rather than with the situation time of the head clause. However, the latter two times are interpreted as \mathbb{W} -simultaneous with each other.

This test is corroborated by the fact that it makes the correct predictions in cases in which the relevant T-relation is T-anteriority rather than T-simultaneity:

John expects that he will feel lonely when Mary {*has left* / **will have left*}.

John expected that he would feel lonely when Mary {*had left* / **would have left*}.

Compare also:

[The thought of his case never left him now. He had often considered whether it would not be better to draw up a written defence and hand it in to the Court.] In this defence he *would give* a short account of his life, and when he *came* to an event of any importance he *would explain* for what reasons he *had acted* as he *did*, intimate whether he *approved* or *condemned* his way of action in retrospect, and adduce grounds for the condemnation or approval. (TTR) (*The past tense forms came, did, approved and condemned are all relative tense forms expressing T-simultaneity with the situation time of their head clause. Note that intimate is short for would intimate.)*

(...) In this defence he *will give* a short account of his life, and when he {*comes* / **will come*} to an event of any importance he *will explain* for what reasons he *has acted* as he *has*, intimate whether he *approves* or *condemns* his way of action in retrospect, and adduce grounds for the condemnation or approval. (*The forms comes, has acted, has, approves and condemns all express a T-relation in a post-present domain. The present tense forms all express T-simultaneity with the situation time of their head clause.*)

8.23.2 This test rests on the assumption that the possibilities and restrictions in connection with the use of absolute and relative tense forms in particular types of clauses are the same in a past domain as they are in a post-present one. Though the above examples all corroborate this assumption, we have not yet adduced any really conclusive evidence that the assumption is correct. The test must therefore provisionally be treated as tentative.

8.24 Argument 2: past tenses whose situation time is W-posterior to t_0

Unlike the first argument, this argument is a cogent one.

In a sentence like *Mary told me on the phone last night that at the dinner party tomorrow she would suddenly say that she felt sick*, the past tense form *felt* refers to a situation which lies in the post-present (i. e. which is W-posterior to t_0). This observation demonstrates the inadequacy of the assumption that there is only one past tense

in English, which is used to locate a situation time prior to t_0 . However, the observation is naturally explained on the assumption that *felt* is a relative past tense form expressing T-simultaneity. This constitutes very strong evidence in favour of a theory which assumes the existence of a relative past tense (next to an absolute one), which expresses T-simultaneity in a past domain, irrespective of the W-location of the binding time relative to t_0 .

8.24.1 We have argued that the tense structure (= semantics) of the two kinds of past tense are quite different from each other: the semantics of the absolute preterite is ‘The situation time establishes a past domain’, while that of the relative preterite is ‘The situation time is represented as T-simultaneous with a binding orientation time belonging to a past domain or subdomain (or to a ‘pseudo-past subdomain’ – see 9.9.1 and 9.18.1)’. Since it is not the existence of the absolute preterite that is subject to debate, but the existence of the relative preterite, what we need to show is that there are preterite forms that unequivocally express the tense structure typical of the relative preterite. In our opinion, the italicized tense forms of the following examples fulfil this requirement – see Figure 8.6:

[A few weeks ago he told us about what he planned to do.] When he *was* fifty-five he would retire. [He would move to some place in the south and ...].

[Yesterday the Prime Minister repeated that] if the party *lost* next week’s elections, this would not induce it to change its views on nuclear energy.

Until a moment ago I thought that at tomorrow’s meeting of the board he would argue that it *was* necessary to sell the company. [But he’s just assured me that he isn’t going to do that.]

Mary told me on the phone last night that at the dinner party tomorrow she would suddenly say that she *felt* sick.

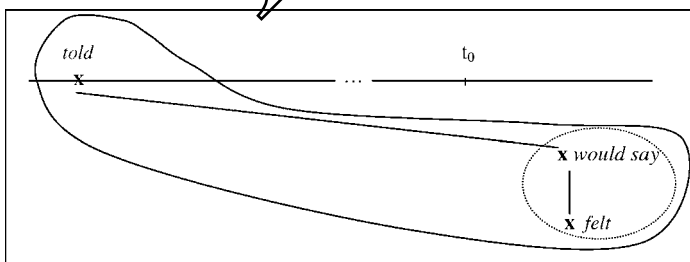

Figure 8.6. The tense structure of *Mary told me on the phone last night that at the dinner party tomorrow she would suddenly say that she felt sick.*

In these examples, the situations described by *was* [*fifty-five*], *lost*, *was* [*necessary*] and *felt* [*sick*] are interpreted as W-posterior to t_0 (because of the temporal indications in the relevant clauses), but this W-posteriority relation is not expressed by the past tense forms. This means three things. First, the italicized preterites cannot be analysed as absolute tense forms in any tense theory, because the absolute preterite,¹¹ which is the only kind of (nonmodal) preterite recognized by most tense theories, locates its situation time anterior to t_0 and is therefore semantically incompatible with an interpretation in which the situation in question lies completely in the post-present. Secondly, in the above examples, the italicized preterites not only fail to represent their situation time as T-anterior to t_0 , they fail to represent it as T-anterior to *anything*. (This means that T-anteriority does not form part of their meaning.) Thirdly, although the past tense forms themselves do not express the W-posteriority relation, they are not incompatible with it. This is in keeping with our analysis of these forms as being relative preterite forms: these tense forms merely represent their situation time as T-simultaneous (= coinciding) with a situation time belonging to a past domain. (The conditional tense represents that T-binding situation time as T-posterior to the central orientation time of the past domain.) Thus, in the third example *was* [*necessary*] represents its situation time as T-simultaneous with the situation time of *would argue*, which is a situation time belonging to the set of situation times constituting the temporal domain established by *thought*. It should be kept in mind that a tense form representing its situation time as T-posterior to the central orientation time of a past domain does not say anything about the W-relation between the relevant situation and t_0 : as is clear from *He said he would do it {yesterday / now / tomorrow}*, the situation referred to by the conditional tense (which represents its situation time as T-posterior to an orientation time in a past domain) may be interpreted as W-anterior, W-simultaneous or W-posterior to t_0 . Obviously, the same is true of any situation whose situation time is represented as T-simultaneous (= coinciding) with the situation time of a situation referred to in the conditional tense, as the following example illustrates:

He said he would do it when *he had* time. [So he may already have done it, or he may be doing it right now, or he may be going to do it tomorrow. I don't know which.]

In this example, *had* is another instance of a past tense form which cannot possibly be analysed as an absolute preterite, nor as a past tense representing its situation time as T-anterior to an orientation time other than t_0 , but which fully satisfies our definition of 'relative past tense form' (expressing T-simulta-

11. As noted in 1.14, we use 'preterite' to refer to forms like *walked*, *said*, *went*, etc. Other forms involving the past tense morpheme (such as *had walked*, *would walk*, *would have walked*) are not preterite forms.

neity in a past domain). More generally, as is shown by Figure 8.6, a past domain can contain one or more subdomains which are W-interpreted as lying in the post-present. A past tense expressing T-simultaneity in such a subdomain cannot be analysed as an absolute past tense.

The following are some further examples in which the situation time of a clause in the relative past tense is interpreted as W-posterior to t_0 :

[He told me yesterday that exactly 17 days from now he would tell Mary that] he *was inviting* her to lunch because it *was* his birthday.

["What was it he told you yesterday?" – "He said that, inevitably, the time would come when] he *was* fed up with working in a factory [and would look out for a better job."]

[He said he would read the article tomorrow while] he *was* in the dentist's waiting-room.

Here again, the italicized past tense forms not only do not mean 'past relative to t_0 ' (as they would do if they were absolute preterites), but do not mean 'past relative to (any kind of) orientation time'. The temporal relation they express is that of T-simultaneity with a situation time belonging to a past temporal domain (but interpreted as W-posterior to t_0).

8.24.2 The above data, which are naturally explained if one assumes the existence of a relative past tense in English (and hence the existence of temporal domains), cannot possibly be accounted for by an analysis that assumes that there is only one past tense, expressing that the situation time is past relative to t_0 . This argument in favour of the existence of a relative preterite is so cogent that it should be sufficient on its own to discard any analysis denying the existence of a relative past tense in English.

8.24.3 All the examples given in 8.24.1, and in fact in all the other arguments that will be presented below, are instances of 'represented speech', i. e. indirect reported speech or free indirect speech (see 8.25.1). This is because represented speech forms the only context in which the use of the conditional tense (to express T-posteriority) is natural. Expressing T-posteriority is tantamount to making a prediction or expressing an expectation, and this can only be done in an **INTENSIONAL (OPAQUE)**¹² context like represented speech.¹³ (A similar

12. An opaque context (or 'intensional context') is one in which the reference is not to the real world but to an alternative (nonfactual) world. Such a context is created by (amongst other things) 'intensional verbs' ('verbs of propositional attitude') like *want*, *expect*, *believe*, *think*, *imagine*, etc. Clauses that form part of an intensional context receive an 'opaque' ('de dicto') interpretation, i. e. their truth is not evaluated in relation to the real world but in relation to the alternative world referred to.

Clauses belonging to a nonintensional context receive a 'transparent' ('de re') interpretation, i. e. their truth is evaluated in relation to the real world. It is typical of such an interpretation that the truth value of the clause is not affected when a referring

remark can be made in connection with the future tense: reference to the post-present by itself creates opacity, i. e. a post-present domain is by definition an opaque domain. Thus, in [*If you do that,*] *you will regret for ever that you have done it*, the ‘doing it’ is not factual in the speaker’s t_0 -world (= the actual world): it is only factual in the post-present intensional domain, i. e. in a not-yet-factual alternative world.)

However, the fact that the data are restricted to cases in which T-posteriority is expressed does not in any way affect the strength of our argument. As pointed out at the beginning of 8.24.1, all that is necessary to prove the existence of the relative preterite in English is to adduce examples of preterites that cannot possibly be analysed as absolute preterites, and a number of such examples have been given here.

8.24.4 It should also be noted that the examples given in 8.24.1 all have nonpast counterparts in which the future tense is used instead of the conditional tense in the head clause and in which the present tense is used instead of the relative past tense in the subclause:

[He has told us about what he plans to do.] When he *is* fifty-five he will retire. [He will move to some place in the south and ...].

I will read the article tomorrow while I *am* in the dentist’s waiting-room.

[He says that, inevitably,] the time will come when he *is* fed up with working in a factory [and will look out for a better job.]

Exactly 17 days from now I will tell Mary that I *am* *inviting* her to lunch because it *is* my birthday.

There can be no doubt that the italicized present tense forms in these examples express T-simultaneity in a post-present domain: these forms cannot be interpreted as locating their situation time at t_0 . Since these sentences with the future tense in the head clause and the present tense in the subclause are the nonpast counterparts of examples involving the conditional tense in the head

expression in the clause is replaced by an ‘identical’ expression (i. e. by an expression with the same referent). Thus, since in the real world *the capital of France* and *Paris* have the same referent, we can replace the former by the latter in *The capital of France has ten million inhabitants* without altering the truth value of the sentence.

In sentences that receive an opaque interpretation, the replacement of a term by an ‘identical’ expression may affect the truth value: the sentence *Bill thinks that Paris is the capital of Spain* may be true even if *Bill thinks that the capital of France is the capital of Spain* is not true.

13. We are disregarding here the special use of *would* in the sense of *was to*, as in *Ten years later Tom {would / was to} be the richest man in town* – see 9.6.7. (This is the only use in which *would* is interpreted as referring to a past fact rather than as merely making a prediction.)

clause and the past tense in the subclause, it stands to reason that in both cases the tense in the subclause should be analysed as a tense expressing T-simultaneity (coincidence) with a situation time that is T-posterior (to t_0 or to a past orientation time, respectively).

8.25 Argument 3: tense use in represented speech

Distinguishing between an absolute and a relative past tense explains why some past tense forms are ‘backshifted’ in past represented speech while others are not. For example, the sentence *Ian addressed the girl who was sitting behind the largest desk* can be reported as [*Jim said yesterday that*] *Ian had addressed the girl who was sitting behind the largest desk*. This illustrates the (quite logical) fact that an absolute past tense can be ‘backshifted’ in past represented speech, whereas a relative past tense remains unaffected (because the T-simultaneity relation which it expresses remains unaffected).

8.25.1 This argument concerns the adaptation of tense forms in indirect reported speech and in free indirect speech. For ease of reference, we will subsume these two possibilities of indirect speech under the heading of **REPRESENTED SPEECH** (where *speech* should be interpreted as meaning ‘speech or thought’). Since we will only be concerned with the kind of represented speech in which the representation is located in the past, the term **PAST REPRESENTED SPEECH** will be used in the present section.

8.25.2 In past represented speech, the tense forms from direct speech are traditionally said to be **BACKSHIFTED**:

“*I am at home.*” → I said I *was* at home.

“*I will be at home.*” → I said I *would be* at home.

“*I have been at home.*” → I said that I *had been* at home.

However, this rule, known as ‘sequence of tenses’, does not automatically apply when the presumed original utterance is in the past tense. Consider the following stretches of direct speech:

(1) “I told Bill that Jane was angry with Jim.”

(2) “I told Bill that Jane was furious when Jim refused to take her out.”

Out of context, sentence (1) will normally be taken to mean that the two situations were simultaneous, and this meaning can only be reported as (3) or (4):

(3) Jill said that she had told Bill that Jane was angry with Jim.

(4) Jill said that she told Bill that Jane was angry with Jim.

The following are not ‘correct’ past represented speech versions of (1) if the two situations in (1) are taken to be simultaneous:¹⁴

- (5) Jill said that she told Bill that Jane had been angry with Jim.
- (6) Jill said that she had told Bill that Jane had been angry with Jim.

Both (5) and (6) are reports of *I told Bill that Jane had been angry with Jim*. By contrast, sentence (2) only allows the following reading:¹⁵

‘I told Bill [at t_2] that Jane was furious [at t_1] when Jim refused [at t_1] to take her out.’ (t_1 is anterior to t_2)

The following are possible past represented speech versions of (2) – see 8.25.3 for further comment:

- (7) Jill said that she (had) told Bill that Jane *had been* furious when Jim *refused* to take her out.
- (8) Jill said that she (had) told Bill that Jane *was* furious when Jim *refused* to take her out.
- (9) Jill said that she (had) told Bill that Jane *had been* furious when Jim *had refused* to take her out.

However, the following sentence is not a correct past represented speech version of (2):

- (10) Jill said that she had told Bill that Jane *was* furious when Jim *had refused* to take her out. (*Unlike (2), this report represents Jim’s refusal as anterior to Jane’s being furious. It is therefore a report of I told Bill that Jane was furious when Jim had refused to take her out.*)

8.25.3 The data provided by (3)–(10) cannot be accounted for in a systematic way (i. e. without ad hoc stipulations) by the sequence of tenses rule if the latter is seen as a purely formal operation, which applies automatically in past represented speech. However, they are naturally explained in our analysis, which treats the **BACKSHIFTING** rule as the semantically-driven adaptation of

14. By ‘correct’ represented speech version we mean a version which does justice to the temporal relation(s) expressed in the original utterance. If the original speaker says that two situations are simultaneous, then a report of this speaker’s utterance cannot be a genuine report if it represents the original speaker as having said that the two situations are *sequential*. So if one thinks that the original speech is *John knew that Jim was abroad*, and this is interpreted as meaning that Jim’s being abroad was simultaneous to John’s knowing it, then this simply cannot (except by a liar) be reported by *Betty said that John knew that Jim had been abroad*, because the temporal relations between the situations are different in this sentence. Either a sentence is a report or it is not, and if it is a report then it obviously has to convey the same situations in the same temporal order.

15. We are ignoring the (unlikely) interpretation on which the *when*-clause specifies the time of the head clause situation.

tense forms which naturally takes place when an utterance is reported in the form of past represented speech. This analysis hinges on the following claims:

- (a) A situation time that is ‘originally’ (i. e. in the original direct speech utterance) T-related to t_0 (and thus establishes a domain of its own), is now (i. e. in past represented speech) T-related to the central orientation time of a past domain (which, in (3)–(4) and (7)–(10), is the situation time of *said*), which means that the tense which locates the situation time in time no longer establishes a domain but merely expresses a T-relation in one.
- (b) It follows that a tense form which originally represents its situation time as the central orientation time of a past domain, such as *told* in (1)–(2), is now replaced by a tense form expressing a T-relation in a (new) past domain. This is because the situation time is now T-bound by the central orientation time – which is the situation time of *said* in (3)–(4) and (7)–(10) – rather than being directly related to t_0 (by an absolute tense form). The relative tense form in question expresses T-anteriority (i. e. it is a past perfect form) because the original past tense form also expresses T-anteriority (but then to t_0 rather than to a past orientation time).
- (c) Out of context, when a complement *that*-clause in the past tense depending on a head clause in the past tense is homogeneous, it must as a rule be taken to express T-simultaneity. This is indeed the way the *that*-clause is interpreted in (1) [*I told Bill that Jane was angry with Jim*]: Jane’s being angry is W-simultaneous with my telling Bill about it.

For a good understanding of this point, it is necessary to draw attention to a number of things:

- Firstly, the generalization made in the first sentence of (c) obviously does not apply if the past tense form in the *that*-clause is the past counterpart of a ‘futuristic form’ – see 2.9 – as in *Mary said that Bill was coming over when school broke up the next week*.
- Secondly, the reason why the generalization applies only if the *that*-clause is homogeneous is that T-simultaneity means coincidence (see 2.17). If the situation time of a durative situation is represented as T-simultaneous with a punctual situation time, it is represented as punctual. As explained in 2.17, this is only possible if the durative situation clause (whose situation time is T-bound and punctual) is a ‘homogeneous’ clause. (If it is heterogeneous, the situation time can only be the time of the full situation.) Thus, the situation time of the *that*-clause of *Mary said that Bill walked to town* cannot be T-simultaneous with the situation time of *said*, but that changes when the *that*-clause is made homogeneous by the use of the progressive form: in *Mary said that Bill was walking to town* the walking can (and out of context is) interpreted as simultaneous with the situation time of *said*.

- Thirdly, if a *that*-clause is itself the head clause of an adverbial *when*-clause, its situation time must be interpreted as W-anterior to the situation time of the matrix clause (see 2.17 and 8.26.1). Thus, in (2) [*I told Bill that Jane was furious when Jim refused to take her out*] the situation of Jane being furious is interpreted as W-anterior to that referred to by *I told Bill*. In our terminology, this means that *was* is now an absolute past tense form ‘shifting the domain’. That is, the temporal domain established by *told* in *I told Bill* remains unexpanded, because the past tense form *was* in *Jane was furious* establishes another (W-anterior) past domain which also comprises the situation time of the *when*-clause. (The reason why the preterite in a *that*-clause supporting a *when*-clause cannot be analysed as a relative preterite expressing T-simultaneity will be explained in 8.26.1.)
- (d) In section 9.29 we will see that some types of clauses (such as adverbial *when*-clauses) under certain conditions allow ‘indirect binding’, i. e. the situation time in question is not T-bound by the situation time of its head clause, but by the situation time of a higher clause. The most typical pattern is that realized in *He said that when he had seen the house he had immediately fallen in love with it*, which is an alternative to *He said that when he saw the house he had immediately fallen in love with it*. Whereas *saw* is an example of ‘normal’ (= ‘direct’) binding, because it represents the situation time of the *when*-clause as T-simultaneous with the situation time (*had fallen*) of its head clause, *had seen* is an example of indirect binding: it represents the situation time of the *when*-clause as T-anterior to the situation time of *said*. This is possible because it is pragmatically clear that the situation time of *had seen* must anyhow be interpreted as W-simultaneous with the situation time of *had fallen*.
- (e) Indirect binding is never possible in complement clauses depending on a verb of communication (*says, tell, hear ...*): we cannot interpret *Jill admitted that she had said that Ian had been angry* as equivalent to *Jill admitted that she had said that Ian was angry*.¹⁶ (However, the rule is not so strict

16. This impossibility of indirect binding in past represented speech accords with the impossibility of using the future tense in similar examples referring to the post-present:

- (i) (*direct reported speech*) Next time I meet him I will say to him: “Some day I will ask you if you are hungry.”
 (ii) (*indirect reported speech*) Next time I meet him I will tell him that some day I will ask him if he {*is* / **will be*} hungry.

The report in (ii) must do justice to the original temporal relations. This means that the absolute form *will ask* from (i) becomes the relative tense form *will ask* (expressing T-posteriority to the future situation time of *will talk*, which is treated as a ‘pseudo- t_0 ’—see 9.17.1 and 9.22.1) and that the relative present tense form *are* from (i) remains the relative present tense form *are*, because the T-relation it expresses, viz. T-simultaneity, remains unchanged. Using *will be* instead would be an instance of indirect binding, which is ungrammatical in complement clauses.

if the ‘reporting verb’ is a cognition verb (e.g. *realize*, *be aware*, *feel*, *know*... – see 9.23.3.)

The above principles explain the data provided by (3)–(10):

- (a) Sentence (1) [*I told Bill that Jane was angry with Jim*] can be reported as (3) [*Jill said that she had told Bill that Jane was angry with Jim*] because it is normal for an absolute preterite (*told*) to be ‘backshifted’ in past represented speech (because what is originally anterior to t_0 is now anterior to the situation time of *said*) and because it is equally normal for a relative preterite (*was*) to be retained (because the relation of T-simultaneity is not affected by the reporting and because indirect binding is not allowed in complement clauses depending on *said*). Sentence (1) can also be reported as (4) [*Jill said that she told Bill that Jane was angry with Jim*] because the absolute preterite *told* can anyhow only be interpreted as establishing a W-anterior domain (and hence as interpretationally equivalent to *had told*) because, as pointed out in 8.25.3, the situation time of a durative bounded (and hence nonhomogeneous) subclause (*told*) cannot be represented as T-simultaneous with the virtually punctual situation time of its head clause (*said*).
- (b) Sentence (1) [*I told Bill that Jane was angry with Jim*] cannot be (faithfully) reported as (5) [*Jill said that she told Bill that Jane had been angry with Jim*] or (6) [*Jill said that she had told Bill that Jane had been angry with Jim*] because the substitution of *had been* for *was* changes the T-simultaneity relation expressed by *was* in (1) into a T-anteriority relation. That is, (5) and (6) are both reports of *I told Bill that Jane had been angry with Jim* rather than reports of (1). (The use of *had been* in (6) cannot be analysed as an instance of indirect binding, because indirect binding is not grammatical in a *that*-clause depending on a head clause with *said* as verb – see principle (c) above.)
- (c) Sentence (2) [*I told Bill that Jane was furious when Jim refused to take her out*] can be reported as (7) [*Jill said that she (had) told Bill that Jane had been furious when Jim refused to take her out*] because this report does justice to the temporal relations expressed in (or inferrable from) the reported clause. *Had told* represents its situation time as T-anterior to the situation time of *said*, in the same way as *told* in (2) represents its situation time as anterior to t_0 . *Told* is also fine, because it can be interpreted as establishing a past domain that is W-anterior to that of *said*. The situation time of *had been furious* is represented as T-anterior to that of (*had*) *told*, which is in keeping with the fact that in (2) the situation time of *was furious* is interpreted as W-anterior to the situation time of *told*. The past tense *refused* from (2) is retained in (7) because the T-relation to be expressed is the same in the two sentences, viz. T-simultaneity.

- (d) Sentence (2) [*I told Bill that Jane was furious when Jim refused to take her out*] can also be reported as (8) [*Jill said that she (had) told Bill that Jane was furious when Jim refused to take her out*] because this version too does justice to all the temporal relations expressed in (or inferable from) (2). The situation time of *(had) told* is interpreted as W-anterior to that of *said*, which is in keeping with the fact that *told* in (2) represents its situation time as anterior to t_0 . Because of the presence of the *when*-clause (which is to be interpreted as modifying *Jane was furious*), the situation time of *was furious* cannot be interpreted as T-simultaneous with that of *(had) told*. This means that *was* in (8) must be an absolute past tense creating a new domain, which (for reasons explained in 8.25.3) can only be interpreted as W-anterior to the domain established by *said*. Finally, the situation time of *refused* is represented as T-simultaneous with that of *was furious*, just as it is in (2).
- (e) Sentence (2) [*I told Bill that Jane was furious when Jim refused to take her out*] can also be reported as (9) [*Jill said that she (had) told Bill that Jane had been furious when Jim had refused to take her out*] because a *when*-clause that is interpreted in terms of W-simultaneity can be bound indirectly (*had refused*) rather than directly (*refused*).
- (f) Sentence (2) [*I told Bill that Jane was furious when Jim refused to take her out*] cannot be reported as (10) [*Jill said that she had told Bill that Jane was furious when Jim had refused to take her out*] because *had refused* cannot be an instance of indirect binding (accompanied by a W-simultaneity interpretation) if its head clause is not in the past perfect too. (This restriction is explained in 13.10.1–2.) The form *had refused* in (10) can therefore only be interpreted as expressing T-anteriority. As a result, (10) does not accurately represent all the temporal relations expressed in the original utterance, since *refused* expresses T-simultaneity in (2). In other words, (10) is not a report of (2) but rather of *I told Bill that Jane was furious when Jim had refused to take her out*.
In sum, the data provided by (5)–(10) are all naturally accounted for in our theory.

8.25.4 As noted before, at least some of these data cannot be accounted for by a theory that holds that ‘sequence of tenses’ is a mechanical (automatic, purely formal) rule in past represented speech. Consider the following, in which the (b) sentences are meant to be the indirect reported versions of the (a) sentences:

- (a) I *was* in Greece at the time. (*absolute past tense*)
 (b) Jane said she *had been* in Greece at the time.
 (a) Millie complained that she *wasn't feeling* well. (*relative past tense*)
 (b) John told us that Millie had complained that she {*wasn't* / **hadn't been*} *feeling* well.

These examples show that in past represented speech an absolute preterite can be backshifted whereas a relative one cannot. It is only a theory that distinguishes between absolute and relative preterites that can account for this fact.

8.25.5 This also refutes any analysis which claims that in past represented speech both the head clause and the *that*-clause simply locate their situations in the past and are therefore both absolute past tenses (in our terminology). Like our analysis, such an analysis holds that the report must do justice to the original utterance, hence that two situations that are W-simultaneous in the original utterance must be reported in such a way that they can be interpreted as W-simultaneous. However, unlike our analysis, such an analysis assumes that the way to do that is to use the past tense in both the clauses of the report. According to this analysis, the two past tenses in *Bill once told me his right foot had only four toes* simply locate their situations in the past and the two situations are automatically interpreted as W-simultaneous because *My right foot has only four toes* represents the situation referred to as simultaneous with t_0 and a faithful report has to do justice to this temporal relation. In this analysis both the past tense forms in *Bill once told me his right foot had only four toes* are absolute tense forms.

This analysis cannot explain all the data provided by (3)–(10):

- (a) The analysis does not explain why the unmarked report of *My right foot has only four toes* is *Bill once told me that his right foot had only four toes* rather than *Bill once told me that his right foot has only four toes*. If *My right foot has only four toes* is true at some time before t_0 , then (if Bill is still alive) it must also be true at t_0 . We would therefore expect the present tense to be more natural than the past tense. That this is not the case follows from the fact that a shift of domain from the past to the present is subject to restrictions, whereas it is always possible to expand a past domain created by an intensional verb like *said* or *thought*. This becomes even clearer if *My right foot has only four toes* is an erroneous utterance or thought: we can say *Bill {imagined / dreamed} that his right foot had only four toes*, but hardly ^{??}*Bill {imagined / dreamed} that his right foot has only four toes*.
- (b) A heterogeneous (= nonhomogeneous – see 1.36) situation cannot be located at t_0 , because its situation time coincides with the time of the full situation and one cannot locate a durative situation at (= as coinciding with) a point of time. This requirement, that the situation time located at t_0 must be punctual, follows from the semantics of the present tense: it represents the situation time as T-simultaneous with t_0 , not as W-simultaneous with t_0 . (W-simultaneity is a question of interpreting the W-relation between t_0 and the time of the full situation.) In past represented speech we notice exactly the same requirement of T-simultaneity between the *that*-

clause situation time and the situation time of *said*. A heterogeneous situation cannot be located at the situation time of *said*, because you cannot locate a durative situation at (= as coinciding with) a time which is considered as punctual, or at any rate as shorter than the time of the situation which is located at it. Our analysis therefore predicts the unacceptability of *He said he wrote a long letter* on the simultaneity reading, while the other analysis does not. If both past tenses are absolute tenses, it should be possible for the two situations (domains) to be interpreted as W-simultaneous with (= overlapping) one another, unless the theory contains a special interpretive principle blocking this interpretation. Our theory does not contain such a special (ad hoc?) interpretive principle and does not need one.

In other words, the kind of simultaneity that is relevant to the use and understanding of past represented speech sentences is coincidence (T-simultaneity), not overlap (W-simultaneity). This accords with the claim that the past tense in the *that*-clause is a relative past tense, but not with the claim that it is an absolute past tense whose situation is interpreted as W-simultaneous with the situation of the head clause.

- (c) As we will see in 9.9–12, the tenses used to express T-relations in a past domain can under certain conditions also be used to express T-relations in a pre-present domain, even if the present perfect is given a ‘co-extensive’ T-interpretation (i. e. the situation time is co-extensive with the pre-present and therefore leads up to t_0 – see 5.2.2). The following examples of pre-present represented speech (or thought) come from section 9.12:

[I watched Oprah today and George Michael was on there and I enjoyed his interview.] I have known for some time that he *was* gay [but you know he is still sexy]. (www) (*T-simultaneity*)

["You don't think it's on the small side?" – "It looks fine to me." – "I've been thinking lately it *was* rather small." (CP) (*T-simultaneity*)

I have known for some time that she *was* in great pain, [but unfortunately the only thing I could and can do is pray that God reveals his plan for her and be ...] (www) (*T-simultaneity*)

I have known for some time that she *would* not last forever, [but her death still comes as a shock]. (www) (*T-posteriority*)

[In fact, terrorism experts say that] for years their worst fear has been that a suicide bomber *would* hit inside US borders. (www) (*T-posteriority*)

It is clear that the italicized past tenses in the first three examples cannot be analysed as absolute past tenses, because they do not represent the situation they refer to as T-bygone, and certainly not as temporally disconnected from the present. On the other hand, analysing them as relative pasts accords not

only with the simultaneity interpretation which they receive but also with the observation that when a pre-present domain is expanded, it is always expanded as if it were a past domain. (Abundant evidence for the existence of this type of shift of temporal perspective will be adduced in 9.9–12.)

8.26 Argument 4: the incompatibility of a punctual adverbial with a relative preterite

The claim that there are two types of past tense in English, an absolute and a relative one, is supported by the fact that an absolute past tense form is compatible with an unanchored punctual time-specifying adverbial (i.e. an adverbial of the type *at 5 o'clock*), whereas a relative past tense form is not.

8.26.1 Observe the following:

(said at 5 o'clock) John is here {now / at present / today / at this very moment / *at five o'clock}. (The acceptability judgement on 'at five o'clock' assumes that the present tense form has its basic meaning and refers to a single situation rather than being a historic present or referring to a present habit or characteristic. Note also that the relevant difference between *at this very moment* and *at five o'clock* is that the former expresses an Adv-time which is anchored to t_0 while the latter does not.)

This example shows that when a situation time is represented as T-simultaneous (= coinciding) with t_0 , its temporal location cannot also be specified by a punctual unanchored time-specifying adverbial like *at five o'clock*. The only seeming exception is when the time-specifying adverbial does not specify a punctual Adv-time containing the situation time in terms of coincidence but belongs to the proposition describing the situation whose situation time is located at t_0 , as in the following:

(said at 5 o'clock) [You always claim that John is never here at five o'clock. But now you can see for yourself:] John is here at five o'clock.

Examples like these, in which *at five o'clock* does not function as a time-specifying adverbial but forms part of the untensed proposition, will be disregarded in what follows because they are irrelevant to the argument to be presented. So will sentences in which the present tense is a historic present and sentences that express a present characteristic or habit – see the comment added to the first example.

The reason why, at five o'clock, we cannot say **I am here at five o'clock* is that the present tense represents its situation time as T-simultaneous (i.e.

coinciding) with t_0 . This means that the situation time receives its temporal specification from the location at t_0 , which is the strongest possible kind of temporal specification, since t_0 is by definition ‘given’: in sentences with an unanchored time-specifying adverbial, the situation time derives its temporal specification exclusively from the adverbial, because the Adv-time ‘contains’ the situation time (in terms of coincidence or inclusion – see 2.23.1). A situation time cannot derive its temporal specification from two different mechanisms at once, even if the times they refer to coincide with one another.

In sum, a sentence whose situation time is represented as T-simultaneous (= coinciding) with t_0 cannot contain an unanchored punctual time-specifying adverbial specifying a time with which the situation time coincides. Something similar happens when a past tense is used. Consider:

- (11) I was still thirsty at five o'clock.
 (12) At five o'clock Jim whispered that he was still thirsty.
 (13) *At five o'clock Jim whispered that he was still thirsty at five o'clock. (*The two time-specifying adverbials at five o'clock are meant to be read as specifying the same time.*)
 (14) (At five o'clock) Jim whispered that he was still thirsty at three o'clock.

In (11), the absolute past tense form *was* locates its situation time in the past time-sphere. The precise location of this situation time in the past is specified by *at five o'clock*. In (12), *was [thirsty]* is a relative past tense form. It represents its situation time as T-simultaneous (= coinciding) with the situation time of the head clause and in so doing derives its temporal specification from the latter, which itself derives its temporal specification from *at five o'clock*. As shown by the ungrammaticality of (13), we cannot add *at five o'clock* to the *that*-clause of (12). If we add this, the *that*-clause can no longer derive its temporal specification from the T-relation with the situation time of the head clause. As noted above, a situation time cannot derive its temporal specification from two different times at once, even if these times happen to coincide with one another. This explains the unacceptability of (13). Things are different in (14), where *at three o'clock* refers to a different time from the time of the whispering. In our terminology, this means that *was [thirsty]* must now be read as an absolute tense form establishing a domain of its own. (The different adverbials make it clear that the central orientation time of the domain in question is interpreted as W-anterior to the situation time of the head clause, but this relation is not expressed by the tense forms: the absolute preterites *whispered* and *was [thirsty]* T-relate their situation times directly to t_0 .) The difference between (11) and (14) on the one hand and (12) and (13) on the other shows that an absolute past tense form is compatible with an unanchored

punctual time-specifying adverbial, whereas a relative past tense is not.¹⁷ This is a cogent syntactic argument in favour of the claim that a distinction should be made between T-absolute and T-relative past tense forms in English.

It should be noted that the restriction observed in (13) is quite similar to that observed in **John is here at five o'clock*. What we claim in connection with the relative past tense is therefore based on a more general principle which also governs the use of unanchored time-specifying adverbials in present tense sentences referring to a single situation.

It might be argued that the above argument fails because the problem with (13) [**At five o'clock Jim whispered that he was still thirsty at five o'clock*] is simply redundancy. However, redundancy may lead to reduced acceptability but not to ungrammaticality, unless the redundancy is a question of reduplicating a constituent within a single syntactic slot (function). Compare:

**On his head he was wearing a bowler hat on his head. (This is ungrammatical because the locative adverbial on his head is reduplicated, so that there are two identical constituents fulfilling the same syntactic function. An alternative syntactic analysis, e.g. that the second on his head forms part of the noun phrase a bowler hat on his head, is not available: in He was wearing a bowler hat on his head the constituent on his head can only be analysed as a locative adverbial, not as a post-modifier to the noun head bowler hat. This is clear from the fact that What he was wearing on his head was a bowler hat is a quite normal thing to say, while the following is not: *What he was wearing was a bowler hat on his head.)*

**²John told the girl standing next to him that he liked the girl standing next to him. (This is far less acceptable than John told the girl standing next to him that he liked her. The repetition of the girl standing next to him makes for redundancy, which drastically reduces the acceptability of the sentence. However, there is no way one can say that the sentence is syntactically or/and semantically ungrammatical.)*

**At five o'clock Jim whispered that he was still thirsty at five o'clock. (If the two time-specifying adverbials at five o'clock are meant to be read as specifying the same time, this sentence is simply ungrammatical, not just relatively unacceptable because of redundancy. Note also that it differs from the first of these three examples in that at five o'clock is not reduplicated: the two time-specifying adverbials have a syntactic function in different clauses.)*

8.26.2 There is another observation supporting the claim that an absolute past tense form is compatible with an unanchored punctual time-specifying adverbial, whereas a relative past tense form is not. It concerns unanchored punctual time-specifying adverbials that are added to the description of a dura-

17. The only exception is when the adverbial in the subclause is a pro-form for the adverbial in the head clause, as in *At five o'clock John said that he was thirsty {then / at that time}*. Such sentences, which anyhow sound awkward because the addition of the pro-form is completely redundant, are disregarded here. They do not form any counterevidence to the argument that has been offered.

time bounded situation. As noted in 2.30.2, this is only possible if there is a suitable inchoative (inchoative) or terminative reading. Compare:

At seven o'clock he was eating a three-course dinner. (*This sentence, in which was eating is an absolute tense form, is fine on the interpretation that the situation time coincided with the punctual Adv-time, because the progressive form represents the telic situation as nonbounded and homogeneous, which means that the situation time can be a punctual portion of the time of the full situation and can therefore be represented as coinciding with the punctual Adv-time denoted by at seven o'clock.*)

At seven o'clock he ate a three-course dinner. (*This sentence is ungrammatical if it is to express that the situation time coincided with the punctual Adv-time, because the nonprogressive form of a telic verb phrase represents the durative situation as bounded (and therefore as heterogeneous), which means that the situation time is also the time of the full situation, which is durative and therefore cannot coincide with a punctual Adv-time. However, when such a sentence is uttered by a cooperative speaker, a cooperative hearer will look for a suitable reading and assume a partly inchoative interpretation: 'He ate a three-course dinner and started doing so at seven o'clock'.*)

John came to the station at four. (*The most suitable interpretation here is a partly terminative one: 'John came to the station and arrived there at four'.*)

In order to see whether we can get the same inchoative or terminative reading in clauses using a relative tense it suffices to consider the past represented speech versions of the previous two examples.

John said that at seven o'clock he ate a three-course dinner. (*The only possible interpretation of the that-clause is a partly inchoative reading. However, the beginning of the eating cannot be interpreted as T-simultaneous with the situation time of said. The sentence only allows the reading in which the eating precedes the saying, i. e. the reading that is to be expected if ate is an absolute past tense form.*)

John said he came to the station at four. (*The most suitable interpretation here is a partly terminative one: 'John came to the station and arrived there at four'. However, John's arrival at the station cannot be interpreted as T-simultaneous with the situation time of said. The sentence only allows the reading in which came is an absolute tense form establishing a past domain which is interpreted as W-anterior to the past domain established by said.*)

In sum, the combination of an unanchored punctual time-specifying adverbial and the description of a durative bounded situation can trigger a partly inchoative or terminative reading in complement clauses, but only if the past tense that they use is the absolute past tense. There is thus a constraint on combining a punctual unanchored time-specifying adverbial with the relative past tense, while there is no such constraint where the absolute past tense is concerned. This further corroborates our claim that there are two types of past tense in English.

8.27 Argument 5: a relative past tense form cannot be replaced by *used to*

In a sentence referring to a past habit, an absolute past tense form can be replaced by *used to* (which expresses T-anteriority to some orientation time), whereas a relative past tense form cannot.

8.27.1 A scrutiny of examples with the auxiliary *used to* reveals that its temporal meaning is: ‘The situation time is represented as T-anterior to some orientation time’. The orientation time in question may be t_0 , as in *Terry used to be a nuisance*, or a past orientation time, as in *Terry said that as a child he used to be a nuisance*, or a post-present orientation time which is treated as if it were t_0 when another situation time is T-related to it, as in the following example:

[Teach your child to cook healthy food. When he grows up and is cooking for himself,] he will remember the things he *used to make* in his childhood [and will feed himself well]. (www)

In this example, *used to* locates the situation time of *make* in a ‘pseudo-past’ period, i. e. in a period which is past with respect to the time of the remembering – see 9.18.1. (In other words, *used to* represents the making as T-anterior to the situation time of *will remember*, which is the central orientation time of the post-present domain and is therefore treated as if it were t_0 when another situation time is T-related to it – see 9.17.)

It follows from the temporal meaning of *used to* (viz. ‘The situation time is represented as T-anterior to an orientation time’) that, if the reference is to a habit lying in the (real) past, ‘*used to* + verb’ can alternate either with an absolute past tense (expressing T-anteriority to t_0) or with a past perfect (expressing T-anteriority to an orientation time in a past domain):

[When I was a child] I {was / used to be} afraid of spiders.

Chris said that she {had played / used to play} tennis until three years ago.

In cases where the past perfect can alternate with an absolute past tense establishing a W-anterior domain (e. g. *He said he {left / had left} early that morning*), *used to* can alternate with the past tense as well as with the past perfect:

[He said that when he was a child] he {had been / was / used to be} afraid of spiders. (*Had been* expresses T-anteriority in the past domain established by *said*; *was* and *used to be* create a past domain of their own, which is interpreted as W-anterior to the domain established by *said*.)

On the other hand, it follows from its meaning that *used to* cannot alternate with a tense form representing its situation time as T-simultaneous (= coinciding) with t_0 or with a past, pre-present or post-present orientation time. In the following sentences it is each time unacceptable, at least on a simultaneity reading:

Now he {is / *used to be} afraid of frogs. (*reference to a present habit*)

I saw that he {was / *used to be} afraid of frogs. (*reference to a past habit that is represented as T-simultaneous with the past situation time of saw*)

I've often heard him say that he {was / *used to be} afraid of frogs. (*reference to a habit that is represented as T-simultaneous with the pre-present situation time of have heard*)

[If you teach him to cook as a child] he will tell other people later how he {cooks / *used to cook}. (*reference to a post-present habit that is represented as T-simultaneous with the post-present situation time of will tell*)

In conclusion, in a sentence referring to a habit, *used to* can alternate with a tense form expressing T-anteriority to t_0 (= an absolute past tense) or T-anteriority to another orientation time (e.g. a past perfect), but not with a tense form representing its situation time as T-simultaneous (= coinciding) with t_0 (= a present tense) or as T-simultaneous with another orientation time (e.g. a relative past tense).

8.27.2 We interpret the data offered in the previous subsection as meaning that *used to* cannot express T-simultaneity. One might object to this, saying that all that has been shown is that *used to* cannot express W-simultaneity, or that a W-simultaneity interpretation blocks the use of *used to*. This objection would involve the claim that we do not need the notion of T-simultaneity to explain the data, and that all past tense forms are absolute tense forms. It is up to us to refute this analysis.

It is not difficult to show that a W-simultaneity interpretation does not block the use of *used to*. In a subclause, *used to* can alternate with a past tense form establishing a domain of its own which is to be interpreted as W-simultaneous with the head clause domain, provided the verb forms of the two clauses express T-anteriority to the same orientation time. Compare:

Sheila *visited* her grandmother regularly and she also *gave* her flowers. (*Both past tenses represent their situation time as T-anterior to t_0 . In doing so they create two separate past domains, which can be interpreted as W-simultaneous with each other. Since both clauses can refer to a habit, the clauses can be interpreted as referring to W-simultaneous past habits.*)

Sheila *used to visit* her grandmother regularly and she also *used to give* her flowers. (*The two clauses again establish separate past domains, which can be pragmatically interpreted as W-simultaneous with each other. Both clauses express T-anteriority to*

t_0 . Another interpretation – for example, the habit expressed in the second clause is interpreted as anterior to the habit expressed in the first clause – is completely ruled out.)

Similarly, *used to* can alternate with a past perfect form effecting ‘indirect binding’ (see 9.28.1), provided the situation time in question is interpreted as anterior to the same orientation time as also binds the situation time of the head clause:

[I admitted that] when I *had been* in front of the camera or microphone I *had been* very nervous. (Both past perfect forms express T-anteriority to the situation time of *admitted*. Their situation times are interpreted as W-simultaneous with each other, which means that the *when*-clause is bound indirectly.)

[I admitted that] when I *used to be* in front of the camera or microphone I *used to be* very nervous. (Both *used to*-forms express T-anteriority to the situation time of *admitted*. Their situation times are interpreted as W-simultaneous with each other.)

In sum, the data in connection with *used to* referred to in 8.27.1 cannot be explained by the assumption that a W-simultaneity interpretation blocks the use of *used to*.

8.27.3 In the previous sections the following principle has been illustrated:

Take a complex sentence in which both the head clause and the subclause express a past habit and use an absolute preterite form (so that two different past domains are established). Suppose further that the subclause domain is to be interpreted as W-simultaneous with the head clause domain, as in *In those days Bill walked to work because his wife needed the car*. In that case we can replace the the past tense form of the subclause (as well as that of the head clause) by a form with *used to* without changing the temporal relations: in *In those days Bill {walked / used to walk} to work because his wife used to need the car*, the two situations are again T-anterior to t_0 and are again interpreted as W-simultaneous with each other. However, if the subclause uses a relative past tense form, we cannot replace that form by a form with *used to* because this would change the T-simultaneity relation expressed by the relative past tense form into a T-anteriority relation.

It follows that if sentence (15) below established two independent past domains which were interpreted as W-simultaneous with each other, it should be possible for the sentence to alternate with (16):

(15) My father often said that he was afraid of mice. (*The intended reading is that on which the two situations, which are both T-anterior to t_0 , are interpreted as simultaneous.*)

(16) My father used to say that he used to be afraid of mice.

Actually, (16) cannot be interpreted as having the same meaning as (15). It can only be interpreted as equivalent to *My father always said that he had been afraid of mice*. This strongly supports our claim that (on the intended interpretation) *was afraid* in (15) is not an absolute preterite form establishing a W-

simultaneous domain but is a relative preterite form expressing T-simultaneity. (Evidently, a tense form expressing T-simultaneity cannot alternate with (and be equivalent to) a *used to*-form expressing T-anteriority.) The crux of this argument is that the impossibility of replacing (15) with (16) proves that it is not W-simultaneity that blocks the use of *used to* but T-simultaneity. The use of *used to* is not blocked in the examples in 8.27.2, which illustrate W-simultaneity, but it is blocked in (16), because *was* in (15) expresses T-simultaneity.

8.27.4 In sum, in a *that*-clause referring to a past habit, an absolute preterite can be replaced by a *used to*-form, whereas a relative preterite cannot. The following examples further illustrate this:

Millie believed that her son {didn't smoke / didn't use to smoke} when he was younger. (*Because of the presence of the when-clause, the situation of not smoking must be interpreted as anterior to Millie's belief – see 8.26.1. This means that didn't smoke must be an absolute preterite establishing a domain that is interpreted as W-anterior to the domain established by believed. Such an absolute preterite, expressing T-anteriority to t_0 , can be replaced by a used to-form on a habitual interpretation.*)

Millie believed that her son {didn't smoke / #didn't use to smoke}. (*For lack of a context triggering another interpretation, the habitual situation of not smoking is interpreted as simultaneous with Millie's belief. If, on this interpretation, didn't smoke were an absolute preterite establishing a domain that was interpreted as W-simultaneous with the domain established by believed, it would be interchangeable with didn't use to smoke, because both forms would express T-anteriority to t_0 . The fact that didn't use to smoke (which expresses T-anteriority to t_0) cannot replace didn't smoke (on the intended reading)¹⁸ can only mean that didn't smoke does not express T-anteriority to t_0 . In other words, didn't smoke cannot be an absolute preterite. Our analysis, which treats it as a relative preterite (expressing no other relation than T-simultaneity) is in keeping with this conclusion and also provides a natural explanation for the data.*)

8.28 Argument 6: the use of the preterite rather than the conditional tense

The existence of a relative past tense (expressing T-simultaneity with an orientation time in a past domain) accounts for the obligatory use of the past tense (rather than the conditional tense) in the adverbial time clause of a sentence like *John decided that*

18. It is this fact – that *didn't smoke* cannot be replaced with *didn't use to smoke* – that is indicated by the symbol # in the example.

*he would wait until his wife {arrived / *would arrive}*. If we assume that the meaning of *until* includes an ‘implicit orientation time’ – *until* means ‘until the time that’ – the use of the past tense is explained naturally: it represents the situation time of John’s wife’s arrival as T-simultaneous with the implicit orientation time.

8.28.1 The concept of relative past tense is also necessary to account for the obligatory use of the preterite in the adverbial time clauses of examples like the following:

Maud knew that John would leave before Mary {arrived / *would arrive}.

As noted in 14.4.2, the *before*-clause in this example is interpreted as ‘not-yet-factual at the binding time’, more specifically as not-yet-factual at the situation time of the head clause: what Maud knew was that Mary would not yet have arrived when John left. The same applies to the *until*-clause in the following example:

Maud expected that John would wait until Mary {arrived / *would arrive} [but she couldn’t know that John would be waiting in vain because Mary wouldn’t make it to the meeting-place that day.]. (*The until-clause has a similar ‘not-yet-factual at the head clause-situation time’ interpretation*)

The obligatory use of the past tense in such time clauses is generally looked upon as puzzling. It seems illogical that (unlike many other languages) English does not allow the use of the conditional tense (which represents a situation time as T-posterior to an orientation time in a past domain) to refer to a situation time which must actually be interpreted as W-posterior to an orientation time in a past domain. However, these data do not really present a problem if one knows that the temporal conjunctions *before*, *until*, *after*, *since* and *when* resemble the phrasal conjunction *by the time that* in that they are interpreted as ‘{before / until / after / since / at} the time that’ (see 8.2.1). Diachronically, the present-day conjunctions *before*, *until*, *after*, and *since* have actually developed from prepositional phrases of this kind. The fact that we must use *arrived* rather than *would arrive* in the above examples shows that, in an intensional context, the situation time of a *before / until*-clause has to be represented as T-simultaneous with the orientation time that is implicit in the semantics of the conjunction (and which is explicit in the conjunction *by the time that*). A comparison of the following sentences renders it easier to see this constraint:

John left before Mary arrived.

John decided he would wait until his wife {arrived / *would arrive}.

The first example is interpreted as meaning that both situations actualized in the order indicated by *before*. Because of the factuality of the two situations,

the two preterites are analysed as absolute preterites in our theory. (As explained in 14.5.1, not all *before*-clauses use a relative tense. Those that represent a situation as a past fact use the absolute past tense.) The implication that Mary had not yet arrived when John left is an entailment but does not alter the fact that the two situations are represented as factual.

In the second example, *decided* creates an intensional world in which the situation of John's wife's arrival is expected to actualize. The form *arrived* cannot be an absolute past tense here because the speaker does not represent the arrival as a past fact: it is quite possible that John's wife did not actually show up. In other words, by using an absolute past tense a speaker always represents a situation as factual from his point of view, i. e. from the temporal standpoint of t_0 . Such a reading, which is given to both past tense forms in *John left before Mary arrived*, is a 'transparent' ('de re') interpretation. By contrast, in *John decided he would wait until his wife arrived, arrived* receives an 'opaque' ('de dicto') reading. The arrival only forms part of John's intensional world, not of the speaker's transparent world. In this world, the arrival is not-yet-factual at the time when John decided to wait. In sum, *arrived* is now a relative tense form receiving a 'not-yet-factual at the binding time' interpretation but no factual interpretation. (Unlike English, Germanic languages like Dutch or German use the conditional tense to express this not-yet-factual interpretation. In archaic English, *until his wife should arrive* could be used similarly instead of *until his wife arrived*. The following is an authentic example from the Bible:

His lord was angry, and delivered him to the tormentors, until he *should pay* all that was due to him.

8.28.2 What we learn from the impossibility of using *would arrive* in the second example [*John decided to wait until his wife arrived*] is that the situation time of an *until*-clause cannot be bound indirectly (by means of the use of the conditional tense) by the situation time which also binds the situation time of the head clause of the *until*-clause: the situation time of the arrival cannot be represented as T-posterior to the situation time of *decided*. The only possibility is for the situation time of the *until*-clause to be bound directly by the orientation time which is implicit in the meaning of *until* (and which is lexicalized as *the time* in the paraphrase 'until the time that'). Since the relation in question is T-simultaneity – 'until the time that his wife arrived' means 'until the time of his wife's arrival' – a relative past tense form must be used for this. (Remember that the relative past tense is the only tense that can be used to express T-simultaneity with an orientation time in a past domain.) That the past tense in question cannot be an absolute past tense is furthermore clear from the fact that an absolute preterite can only express one T-relation, viz. T-

anteriority to t_0 ,¹⁹ and from the fact that the orientation time that is implicit in *until*, as well as the situation time that is represented as T-simultaneous with it, can actually be W-posterior to t_0 :

Yesterday evening John decided he would wait in the hotel until his wife *arrived* today. [She has not arrived yet, but she will in a couple of hours.]

8.28.3 It is worth noting that the principle prohibiting the use of *would arrive* in *John decided he would wait until his wife {arrived / *would arrive}* also underlies the obligatory use of the present tense (as ‘pseudo-absolute’ tense expressing T-simultaneity – see 9.17) in the post-present counterparts of these examples and in similar sentences with a *before*-clause:

John has decided he will wait until his wife {*arrives* / **will arrive*}.

John will wait until his wife {*arrives* / **will arrive*}.

John will leave before Mary {*arrives* / **will arrive*}.

The present tense is used because *before* / *until* mean ‘before / until the time that’ and the tense of the time clauses has to express T-simultaneity with this implicit orientation time. Using the absolute tense form *will arrive* is not allowed: an adverbial *before* / *until*-clause cannot establish a post-present domain of its own. There is a clear parallelism between the ungrammaticality of *will arrive* here and the ungrammaticality of *would arrive* in *John decided he would wait until his wife {arrived / *would arrive}*. In both cases the situation time of the time clause can only be T-related to the orientation time which is implicit in the meaning of the conjunction. Using *will arrive* or *would arrive* would T-relate it to another orientation time. (In the case of *will arrive* the situation time would be T-related directly to t_0 .)

8.29 Argument 7: ambiguity or vagueness?

John said that Mary was ill allows a reading in which Mary was ill at the time of John’s utterance and one in which Mary was ill at some time preceding John’s utterance. Our claim that these two interpretations are a matter of ambiguity (tense structure) and not vagueness (W-interpretation) is confirmed by Lakoff’s well-known test to distinguish between ambiguity and vagueness.

19. As in all the arguments given here in support of the notion of relative past tense, we are disregarding special uses of past tense forms, as in *He was leaving the next day*, *If you did that tomorrow ...*, *If only I was a girl!*, etc. By ‘absolute past tense form’ we always mean a tense form that locates a situation time in the past time-sphere and in doing so represents it as T-anterior to t_0 .

8.29.1 The above distinction between T-simultaneity and W-simultaneity is a distinction between semantic meaning and W-interpretation. (The former is exclusively a question of semantics, whereas the latter is a question of pragmatics as well as semantics: the interpretation of a clause depends not only on the semantics of the construction used and the lexical meaning of the constituents but also on pragmatic factors, such as the (linguistic and extralinguistic) context in which the clause is used, our pragmatic knowledge of the world, and the generally accepted principles of conversation.) The distinction between T-simultaneity and W-simultaneity is therefore related to the distinction between (semantic) ambiguity and (pragmatic) vagueness. A sentence like *John said that Mary was ill* clearly allows two W-interpretations: (a) Mary was ill at the time of John's utterance, and (b) Mary was ill at some time preceding John's utterance. (Out of context, interpretation (a) is the normal one; reading (b) can be brought out, for example, by the addition of a time adverbial, as in [*John said that*] *Mary was ill [when the plane landed]*.) Now, there are only two theoretical ways of explaining the fact that there can be two W-interpretations. The first is to say that on either reading *was* is an absolute past tense form, i. e. that like *said*, *was* expresses no more than that its situation time lies in the past time-sphere. The two readings of the sentence then follow from the fact that the two situation times may or may not be interpreted as W-simultaneous with each other: the intended reading will be clear from the context. This explanation is based on the notion of pragmatic vagueness, not semantic ambiguity. The second explanation relies on the claim that *was* is semantically ambiguous between an absolute past tense form and a relative past tense form. Because of the different semantics of these two tenses – they express different temporal structures – this explanation is based on the notion of semantic ambiguity, not pragmatic vagueness.

8.29.2 We can show that the semantic explanation is the correct one by using a well-known test for ambiguity. The rationale of this test is as follows. Take a sentence which yields two interpretations. Add a clause expressing similarity and involving a verbal pro-form, for example *and so {did / was} Bill*. If the two interpretations of the initial sentence are a matter of ambiguity, the clause with the pro-form will have to receive the same interpretation as the sentence to which it is added. If this is not the case, i. e. if the initial sentence and the added clause allow a different interpretation, there is vagueness but not ambiguity. For example:

John likes Bill more than Mary, and so does Peter.

The sentence *John likes Bill more than Mary* is syntactically (and therefore also semantically) ambiguous between two meanings:

John likes Bill more than he likes Mary.

John likes Bill more than Mary likes Bill.

As predicted, the added clause in *John likes Bill more than Mary, and so does Peter* must receive the same reading as the first clause. That is, of the following four readings, only the first two are possible interpretations of the sentence:

John likes Bill more than he likes Mary, and Peter also likes Bill more than he likes Mary.

John likes Bill more than Mary likes Bill, and Peter also likes Bill more than Mary likes Bill.

John likes Bill more than he likes Mary, and Peter also likes Bill more than Mary likes Bill.

John likes Bill more than Mary likes Bill, and Peter also likes Bill more than he likes Mary.

When applying this test to *John said that Mary was ill*, we find that the double interpretation of this sentence is due to semantic ambiguity:

John said Mary was ill, and so did Bill.

Because John and Bill may or may not have spoken at the same time, the following are the possible interpretations of this sentence:

John said [at t_1] that Mary was ill [at t_1], and Bill also said [at t_1] that Mary was ill [at t_1]. (*In this case John and Bill spoke at the same time.*)

John said [at t_1] that Mary was ill [at t_1], and Bill said [at t_2] that Mary was ill [at t_2]. (*In this case John and Bill spoke at different times.*)

John said Mary had been ill [at some earlier time], and Bill also said that Mary had been ill [at the earlier time John had in mind].

John said Mary had been ill [at some earlier time], and Bill also said that Mary had been ill [at some earlier time different from the earlier time which John had in mind]. (*Because and so did Bill expresses similarity, this reading is less likely than the previous one.*)

The sentence *John said Mary was ill, and so did Bill* does not yield the following readings:

*John said [at t_1] that Mary was ill [at t_1], and Bill also said [at t_1 or at t_2] that Mary had been ill [at some time earlier than either t_1 or t_2].

*John said [at t_1] that Mary had been ill [at some time earlier than t_1], and Bill also said [at t_1] that Mary was ill [at t_1].

*John said [at t_1] that Mary had been ill [at some time earlier than t_1], and Bill also said [at t_2] that Mary was ill [at t_2].

These sentences are actually ungrammatical because *also* requires that the two parts should have similar meanings, which they do not.

The above data accord with the view that the two readings of *Mary was ill* in *John said that Mary was ill* result from semantic ambiguity: the form *was*

is ambiguous between two meanings. Readings resulting from vagueness are not subject to the restriction observed above. This is clear from the following:

Bill was as ill as John was.

In this example (which also expresses similarity) both verb forms are absolute past tense forms. Because both forms thus relate their situation time directly to t_0 , the temporal relation between the two situation times remains vague (unspecified): we do not know from *Bill was as ill as John was* whether Bill was ill while, before or after John was ill. It is therefore predictable that the test shows *was* to be vague rather than ambiguous between two temporal readings:

Bill was as ill as John was, and so was Mary.

Nothing whatsoever is implied here concerning the relative times of the three illnesses. Whichever of the three interpretations (viz. Bill was ill {while / before / after} John was) we assign to the first part, all three interpretations (viz. 'Mary was ill {while / before / after} John was') remain possible in the second (= added) part.

8.29.3 The test for semantic ambiguity *vs* vagueness that we have used here is due to Lakoff (1970). It has been argued in the literature that there are sentence types in which this test is not reliable. However the kind of sentence to which we have applied the test is not one of the problematic cases. The fact that the test works well in cases of indirect speech is further illustrated by the following:

John will tell the chairman that Mary *was* too ill to attend the meeting.

This sentence is semantically two-way ambiguous in that Mary's illness may be taken to be T-anterior either to t_0 or to the post-present time of John's speaking (i.e. the 'pseudo- t_0 ' – see 9.17.1). In the following sentences the reading to be selected is each time determined by the context:

[Mary couldn't attend yesterday's meeting because she was ill. When I see him this afternoon] I will tell the chairman that Mary *was* too ill to attend the meeting. (*Mary's illness is anterior to t_0 . This means that was is an absolute preterite.*)

[If Mary becomes ill, she won't be able to attend Saturday's meeting. In that case I will speak to the chairman after the meeting.] I will tell him that Mary *was* too ill to attend the meeting. (*Mary's illness is anterior to the pseudo- t_0 but posterior to t_0 . This means that was is a 'pseudo-absolute' tense form (see 9.17.1–3) which actually functions as a relative tense expressing T-anteriority to the central situation time of the post-present domain.*)

If we build a sentence similar to *John said Mary was ill, and so did Bill*, we get the following:

John will tell the chairman that Mary *was* too ill to attend the meeting, and so will Bill.

Of the four theoretically possible interpretations, only the first two are acceptable:

John will tell the chairman that Mary was too ill to attend the meeting [at a time anterior to t_0], and Bill will also tell the chairman that Mary was too ill to attend the meeting [at a time anterior to t_0].

John will tell the chairman [at t_1] that Mary was too ill to attend the meeting [at a time anterior to t_1 but posterior to t_0], and Bill will also tell the chairman [at t_1 or at t_2] that Mary was too ill to attend the meeting [at a time anterior to t_1 or t_2 but posterior to t_0].

*John will tell the chairman [at t_1] that Mary was too ill to attend the meeting [at a time anterior to t_0], and Bill will also tell the chairman [at t_1 or at t_2] that Mary was too ill to attend the meeting [at a time anterior to t_1 or t_2 but posterior to t_0].

*John will tell the chairman [at t_1] that Mary was too ill to attend the meeting [at a time anterior to t_1 but posterior to t_0], and Bill will also tell the chairman that Mary was too ill to attend the meeting [at a time anterior to t_0].

Here too, the test works well. In this case it proves that there is a semantic difference between an absolute preterite (meaning ‘the situation time is past relative to t_0 ’) and a ‘pseudo-absolute’ preterite (meaning ‘the situation time is past relative to a post-present pseudo- t_0 ’).

8.30 Argument 8: choosing between the progressive and the nonprogressive form

In *John said that he was writing a book*, the use of the progressive form is compulsory if we want to express the idea that at the time of his utterance John was engaged in the (telic) situation of writing a book. In the same way as we cannot say **I write a book*, we cannot say **John said that he wrote a book* (on the relevant interpretation). This can only be explained if we posit the existence of a relative past tense meaning ‘The situation time is T-simultaneous (= strictly coinciding) with an orientation time in a past domain’. Since the time of saying (which functions as T-binding time) is (nearly) punctual, we need to represent the much longer situation of writing a book as homogeneous (by using the progressive), so that the full situation can be conceived of as consisting of representative subparts, one of which has the same restricted duration and temporal location as John’s utterance and can therefore function as the time of the predicated situation.

8.30.1 Barring special uses of the present tense (as in historical speech, summaries, etc., where there is a ‘shift of temporal perspective’ from the past to

the present – see the discussion of the ‘Special Present Time-sphere System’ in 3.2–10), we cannot use a nonprogressive present tense form to locate a single durative dynamic situation at t_0 :

I am writing a book.

*I write a book. (*grammatical only in special uses*)

This constraint follows naturally from the following principles:

- (a) t_0 is linguistically conceived of as a point: it has no duration.
- (b) The present tense represents the situation time as coinciding with t_0 .
- (c) It follows from (a) and (b) that the situation time of a present tense clause has to be punctual.
- (d) If the full situation is durative, its situation time can only be conceived of as punctual if the situation is homogeneous, e. g. because it is a state (for example, a habit) or if it is represented as homogeneous by the use of the progressive form. This is not the case in **I write a book*, which is bounded and therefore nonhomogeneous – see 1.45. A nonhomogeneous sentence can only refer to the complete situation (i. e. the situation time is also the time of the full situation). Needless to say, it is pragmatically impossible for such a durative situation to coincide with a point.

Note that this explanation is based on temporal as well as aspectual and pragmatic factors. The notions progressive, homogeneous and durative are a question of (grammatical or ontological) aspect – see 1.20 and 1.33.1. The temporal factor in this explanation lies in the fact that it defines ‘locating a situation time at t_0 ’ as ‘representing the situation time as T-simultaneous (= coinciding) with t_0 ’.

8.30.2 The restriction on **I write a book* also applies to *I wrote a book* in past represented speech, but it does not render the sentence ungrammatical because there is another interpretation of *I wrote a book* on which the sentence is acceptable. Compare:

John said that he *was writing* a book.

John said that he *wrote* a book.

The first sentence is fine because *was writing* represents its situation as homogeneous, which means that the situation time can be a proper subpart of the time of the full situation, so that the situation time can be T-simultaneous (coinciding) with the nearly punctual situation time of *said*. The sentence *John said that he wrote a book* does not satisfy these conditions: *wrote* represents the durative *that*-clause situation as bounded (= nonhomogeneous), so that *wrote* cannot be interpreted as expressing T-simultaneity: a durative nonhomogeneous situation cannot coincide with a nearly punctual time (*said*). However,

John said that he wrote a book is not unacceptable because it allows another interpretation: *wrote* can be interpreted as creating a domain of its own, which is pragmatically interpreted as W-anterior to that established by *said*. (In other words, *wrote* is interpreted as equivalent to *had written*.)

The relevant part of this argument is that, in the same way as **I write a book* cannot locate its situation time at t_0 , *he wrote a book* cannot locate its situation time at the situation time of *said* (at least in Standard British English). Since ‘locate the situation time at time X’ in both cases means ‘represent the situation time as T-simultaneous (= coinciding) with time X’, this comes down to saying that the situation time of a durative bounded (= nonhomogeneous) situation (which is a durative situation time, since if the situation is bounded, the situation time coincides with the time of the full situation – see 8.1.4–5) cannot be represented as T-simultaneous with an orientation time which is conceived of as punctual. (If one does not want to treat *said* as referring to a punctual situation, the restriction is that the situation time of a durative bounded situation cannot be represented as T-simultaneous with an orientation time which is conceived of as having a much shorter duration than the T-bound situation time). The reason why *John said that he was writing a book* is not ungrammatical is that the situation time of *was writing* can be a punctual portion of the full situation, because the progressive form represents the durative full situation as homogeneous.

The above data are perfectly in keeping with our claim that *was writing* in *John said that he was writing a book* is a relative past tense form, whose temporal semantics is ‘The situation time is T-simultaneous (= coinciding) with an orientation time in a past domain’. As far as we can see, the data cannot be explained by any analysis which denies the existence of a relative past tense (with this semantics) in English.

8.31 Argument 9: T-simultaneity is a unidirectional relation

In a theory adopting the existence of a relative past tense meaning ‘the situation time is T-simultaneous (= strictly coinciding) with a past orientation time’, we can nicely explain why the subclause in a sentence like *John knew that I wrote a book* cannot be interpreted in terms of T-simultaneity (i. e. as using a relative tense). If *wrote* were a relative past tense form, the bounded situation of my writing a book would have to derive its temporal specification from the nonbounded situation time of John knowing it, which is pragmatically impossible.

The following is another example in which the *that*-clause cannot be interpreted in terms of simultaneity:

John knew that I wrote a book.

This sentence too can only be interpreted in terms of sequence: my writing of the book was completed before John knew about it. This leads to (at least) the following conclusions. Firstly, *wrote* cannot be a relative past tense form. If it were, it would express T-simultaneity, so that a W-simultaneity interpretation would be possible (and in fact obligatory). Secondly, there must be a reason why *wrote* cannot be interpreted as expressing T-simultaneity. This time the explanation cannot be that it is impossible to represent a durative situation time as coinciding with a much shorter orientation time (*as in John said that he wrote a book*), for the situation referred to by *knew* is not bounded, which means that it can in principle have any duration and that it is homogeneous. Theoretically, a durative bounded situation can coincide with a durative homogeneous situation or with a durative subpart of it. So, what is it that rules out the simultaneity interpretation of *wrote* in *John knew that I wrote a book*?

The explanation we suggest is based on the observation (made in 8.17.2) that T-simultaneity is a unidirectional relation: the bound situation time is represented as coinciding with the binding situation time, not the other way round. This is illustrated by the following examples:

At 3.17 a.m. John said that Bill was not in his room. (*On the default reading of this sentence, the time of the predicated situation (= the situation time) of the that-clause is taken to coincide with 3.17 p.m. This is because this situation time derives its temporal specification from the T-simultaneity relation (expressed by was) with the situation time of the head clause, which coincides with the punctual Adv-time indicated by at 3.17 a.m. The sentence does not say anything about whether or not Bill was also absent from his room at any other time, though it is pragmatically unlikely that the absence was confined to just a point in time.*)

John said that Bill was not in his room at 3.17 a.m. (*The intended reading is that in which at 3.17 a.m. specifies the time of Bill's not being in his room rather than the time of John's reporting this. The precise temporal location of the situation time of the that-clause is indicated by at 3.17 a.m. If T-simultaneity meant that the T-binding situation time derived its temporal specification from the coincidence relation with the T-bound situation time, this sentence should be acceptable on the reading 'At 3.17 a.m. John said that Bill was not in his room (at that time)'. Actually, if at 3.17 a.m. specifies the time of Bill's being in his room, the sentence can only mean 'At some time later than 3.17 a.m. John said that Bill was not in his room at 3.17 a.m.'*)

The claim that the T-simultaneity relation expressed by a relative tense is unidirectional leads to the following conclusions. First, in *John knew that I wrote a book*, the T-binding situation time (*knew*) cannot derive its temporal specification from the T-bound situation time (*wrote*). Secondly, *wrote* cannot derive its temporal specification from a T-simultaneity relation with *knew*, because it

is obvious that a bounded situation (*wrote a book*) cannot derive its temporal specification from a nonbounded one. For lack of specification of boundaries, the situation of knowing something can in principle go on indefinitely. This renders it impossible to represent a bounded situation time as temporally coinciding with it, i. e. to use the relative past tense.²⁰

In sum, our theory nicely accounts for the fact that the *that*-clause of *John knew that I wrote a book* cannot be interpreted in terms of simultaneity. The notion of past relative tense plays a crucial part in this explanation. The fact that *I wrote a book* is bounded also plays a part, but it is unable to explain the obligatory interpretation of *wrote* by itself (as might be claimed by supporters of the idea that the past tense form has a single core meaning, namely ‘anteriority to t_0 ’). The above explanation not only refers to boundedness but also to the idea of temporally representing a situation time as coinciding (= T-simultaneous) with the binding orientation time. The latter element has nothing to do with boundedness but has everything to do with the definition of a relative tense as expressing T-simultaneity.

8.32 Argument 10: the Dutch test

English and Dutch are cognate languages. In Dutch, the absolute and the relative past tenses are clearly distinct, since only an absolute preterite form can be replaced by the present perfect. Thus, to use an English gloss, we find Dutch sentences like *Yesterday he {admitted / has admitted} that his father {was / *has been} dead*. This difference

20. Note that the reverse mechanism is possible: if the binding situation time is bounded and the bound situation time is not, the relation of coincidence imposes temporal boundaries on the bound situation time. For example:

(i) He repeated three times that John was in the kitchen.

The head clause is bounded here by the presence of *three times*. (Specification of the number of times that a situation is repeated induces a bounded-repetitive reading.) The clause *John was in the kitchen* does not by itself represent its situation as bounded. However, as explained in 8.17, the relation of coincidence expressed by the relative preterite *was* entails that the situation time of the *that*-clause is just that part of the full situation (possibly all of it) that is strictly simultaneous with the situation time of the head clause. In other words, (i) makes a statement only about that part of the *that*-clause situation that coincides with the situation time of the head clause. It does not tell us anything about the length of time actually taken up by the complete situation. This means that the boundedness of the head clause imposes boundaries, not on the time of the full situation referred to in the *that*-clause but on the latter’s situation time. In other words, by imposing boundaries, the head clause picks out a subinterval from the time of the full situation, and it is this subinterval that is interpreted as being the situation time of the *that*-clause.

in substitutability – the absolute past tense in the head clause can be replaced by the present perfect, while this substitutability does not exist for the relative past tense in the subclause – shows that Dutch has two past tenses, an absolute one and a relative one. Given the fact that Dutch and English are cognate languages, this suggests that it is quite possible that in English, too, there are two distinct past tenses.

Dutch is a Germanic language which is cognate to English, and whose tense system resembles that of English in many respects. One basic difference, however, is that unlike English, Dutch can use the present perfect to represent a situation as holding at a definite past time:

Ik *heb* Jan gisteren gezien.

(‘I *have seen* John yesterday’)

Verleden jaar *is* het project *mislukt* doordat Jan niet *heeft willen* meewerken.

(‘Last year the project *has failed* because John *has refused* to co-operate’)

However, a present perfect can replace a past tense form only when the latter is an absolute tense form²¹. Dutch does not normally allow the use of the present perfect as a relative tense expressing T-simultaneity. Compare:

Gisteren *gaf* hij *toe* dat zijn vader dood *was*.

(‘Yesterday he *admitted* that his father *was* dead’)

Gisteren *heeft* hij *toegegeven* dat zijn vader dood *was*.

(‘Yesterday he *has admitted* that his father *was* dead’)

*Gisteren *gaf* hij *toe* dat zijn vader dood *is geweest*. (*nonsensical because is geweest does not allow a simultaneity reading*)

(‘Yesterday he *admitted* that his father *has been* dead’)

*Gisteren *heeft* hij *toegegeven* dat zijn vader dood *is geweest*. (*idem*)

(‘Yesterday he *has admitted* that his father *has been* dead’)

It appears that of the (English) preterites only the absolute one can be rendered by a Dutch present perfect. This means that to refer to the past, Dutch can either use the absolute past tense or (under certain conditions) the present perfect. But to expand a past domain established by either of these tenses, only the past tense can be used. This leads to the conclusion that Dutch has both an absolute past tense and a relative one, only the former of which can alternate with the present perfect. This proves the existence of the relative past

21. This is the same situation as in Latin, where both the ‘perfectum’ (e.g. *amavi*) and the ‘imperfectum’ (e.g. *amabam*) can be used for absolute past time reference, but only the latter can also function as a relative past tense expressing simultaneity.

tense in Dutch. Though Dutch of course is not English, this at least suggests that English too may make use of two different past tenses. Moreover, this provides us with a possible test to say if a given past tense form in English is an absolute or a relative form: if it can translate as a present perfect in Dutch, it seems safe to say that it is an absolute tense form. Otherwise it is probably a relative past tense form.

DEMO

IV. Theoretical conclusions from these arguments

The above arguments not only confirm the existence of the relative past tense as a tense in its own right (i. e. semantically different from the absolute past tense) but also lead to some further theoretical conclusions. These will be briefly gone into in the next sections.

8.33 Theoretical conclusion 1

The existence of two distinct meanings (an absolute and a relative temporal meaning) corresponding with a single form (the past tense) is not a case of a single past tense being ambiguous, but of two different tenses having the same formal expression (i. e. being homophonous).

We have adduced a number of arguments supporting the claim that the absolute and relative readings which can be given to past tense forms are not always pragmatically or contextually induced interpretations, but sometimes correspond with distinct semantic (temporal) structures. There are in principle two ways in which this conclusion can be accommodated. One possibility is to assume that English has two past tenses, viz. an absolute and a relative one, which happen to correspond to the same grammatical form (i. e. an absolute past tense form is homophonous with a relative one). (On this assumption, a past tense *form* can under certain conditions be ambiguous between two meanings (absolute *vs* relative), as in *John said that Bill was hungry*. This is in keeping with what was argued in Argument 7 in section 8.29.) The other is to assume that there is only one past tense in English, which is ambiguous, i. e. which can express two different temporal meanings. At first sight it might seem that it is not easy to choose between these two possibilities. We are faced with the same kind of problem as when a single phonological form (e. g. *gay*) corresponds with two distinct meanings: is this a case of two different words being homophonous or an instance of a single word being ambiguous?

However, the analysis assuming two homophonous past tenses is preferable to the analysis in terms of a single ambiguous past tense, because the latter runs counter to the principle (defended in 2.7) that each tense has a single invariant semantic (= tense-structural) meaning. Since a tense is an abstract concept, viz. the correlation of a temporal meaning with a grammatical form, it is unsound from a theoretical point of view to entertain the idea of one

ambiguous past tense, especially if the meanings involved are so distinct that they may be compatible with contradictory readings. (As shown in 8.24, the absolute tense is not compatible with the W-reading ‘situation time after t_0 ’, whereas the relative tense is: *He said he would do it when he had time, which is tomorrow.*) A second point in favour of treating the relative past tense as a tense in its own right is that it has a temporal meaning that is quite similar to that of the past perfect and the conditional tense. The latter two express the temporal structures ‘The situation time is T-anterior to an orientation time in a past domain’ and ‘The situation time is T-posterior to an orientation time in a past domain’, respectively – see 9.1.1 and 9.5.1. Since the relative past expresses ‘The situation time is T-simultaneous with an orientation time in a past domain’, it has the same right to be treated as a tense of its own as the past perfect and the conditional tense. (By ‘tense of its own’ we mean ‘tense with a semantic meaning not shared by any other tense’.) Moreover, given the fact that simultaneity is the unmarked one of the three relations that can be expressed by tenses (see section 8.34 below), it appears illogical to assume that there is a tense expressing T-anteriority to an orientation time in a past domain and a tense expressing T-posteriority to an orientation time in a past domain, but no tense expressing T-simultaneity to an orientation time in a past domain.

8.34 Theoretical conclusion 2

What is ‘past’ about the meaning of the past tense morpheme used in both absolute and relative preterite forms is the idea that the situation time belongs to a past domain.

The ‘past’ aspect of meaning conveyed by the past tense morpheme (which the two past tenses have in common) is neither ‘The situation time is T-anterior to t_0 ’ nor ‘The binding orientation time is T-anterior to t_0 ’. It is ‘The situation time belongs to a past domain’. This is what both past tenses have in common. It follows that the semantics of the relative past tense is not ‘The situation time is T-simultaneous with an orientation time that is past relative to t_0 ’ but rather ‘The situation time is T-simultaneous with some orientation time in a past domain’ (where ‘past domain’ is defined as ‘domain whose central orientation time is past relative to t_0 ’ – see 2.15.3). This accounts for the observation that the relative past tense is the only tense that can express T-simultaneity in a past domain, which means that it is used to this effect irrespective of the location of the binding orientation time in the domain, i. e. regardless of whether the binding orientation time is the central orientation time, or another orientation time T-anterior, T-simultaneous or T-posterior to the central orientation time, or another orientation time T-related to such a noncentral orientation time, etc.

The past aspect of meaning conveyed by the past tense morpheme of a relative past tense form implies no more than that the situation time (and hence also the orientation time binding it) belongs to a past domain. It does not imply anything concerning the actual W-location of either orientation time relative to t_0 . As was shown in 8.24, both the binding orientation time and the T-simultaneous bound situation time can be interpreted as W-posterior to t_0 , as in the past domain referred to by *He told me yesterday that at the meeting tomorrow he would say that he felt faint and needed to leave the room [and that would give him a chance to open the back door for me].*

8.35 Theoretical conclusion 3

The past tense morpheme in all the relative past time-sphere tenses (the relative past tense, the past perfect the conditional tense and the conditional perfect) conveys the meaning ‘The binding orientation time forms part of a past domain’.

What has just been said about the relative past tense in fact also applies to the other relative past time-sphere tenses. It is generally accepted in the linguistic literature that the past perfect expresses ‘T-anteriority to a ‘past orientation time’ and that the conditional tense expresses ‘T-posteriority to a ‘past orientation time’’. In each case ‘past orientation time’ is assumed to mean ‘orientation time that is past relative to t_0 ’, and the past tense morpheme is assumed to express this notion.²² In other words, the meaning of the past tense morpheme in past perfect and conditional tense forms is taken to be ‘The binding orientation time is past relative to t_0 ’. In actual fact, however, the meaning of the past tense morpheme is ‘The binding orientation time forms part of a past domain’. It follows from this that the bound situation time must also form part of the past domain in question. A T-bound situation time must by definition belong to the same domain as the T-binding situation time: T-binding (i. e. the use of a relative tense) is a domain-internal phenomenon. This is clear from the following example, where the conditional tense form *would make* and the past perfect form *had written* are used in spite of the fact that the context makes it clear that both situation times are to be interpreted as W-posterior to t_0 .

[When I saw him last week, he told us what he planned to do. When he was fifty-five he would retire. He would then have the operation that the doctors say he will

22. The past tense morpheme forms part of the formal expression of any past time-sphere tense. Thus, any past perfect form involves the elements PAST, *have* and *-en* (with PAST + *have* lexicalizing as *had*). (PAST means ‘past tense morpheme’.)

quite soon need. When he was sixty, he would have his autobiography written by a journalist.) But he *would make* the world believe that he *had written* it himself when he was in hospital.

Similar examples can be adduced with the conditional tense in the *that*-clause:

[Last week he told me that] at next week's meeting he *would inform* the board that he *would retire* at the end of the year.

Both clauses in the conditional tense refer to situations which, because of the time adverbials, are W-interpreted as lying in the post-present. However, the situation times of both tense forms form part of the past domain established by *told*. The situation time of *would retire* is T-bound by the situation time of *would inform*, which is itself T-bound by the situation time of *told*. The three situation times thus belong to the same past domain, but the situations referred to in the conditional tense are interpreted as W-posterior to t_0 . This means that *would retire* does not express the meaning 'The situation time is T-posterior to a past orientation time (= an orientation time anterior to t_0)', as is generally assumed to be the meaning of the conditional tense. Rather, it expresses 'The situation time is T-posterior to an orientation time in a past domain'. Because it expresses no more than this, the situation referred to by the clause in the conditional tense may be W-anterior, W-simultaneous or W-posterior to t_0 (as is also clear from *He said he would do it {yesterday / today / tomorrow}*).

8.36 Theoretical conclusion 4

There is a parallelism between the system of tenses with a past tense morpheme and the system of tenses with a present tense morpheme, in that all the tenses belonging to the former system express that 'The situation time is located in a domain lying in the past time-sphere' and all the tenses belonging to the latter system express that 'The situation time is located in a domain lying in the present time-sphere domain' and in that the tense expressing T-simultaneity is the unmarked one of all the tenses in either system.

We have reached the conclusion that the meaning expressed by the past tense morpheme of a relative past tense form is 'The situation time and the orientation time binding it belong to a past domain',²³ where a past domain is defined

23. At least, this is the meaning of the past tense morpheme in the basic use of the relative past time-sphere tenses. Apart from this, there are metaphorical (shift of perspective) uses. For example, as noted in 9.9.1, the past tense can express simultaneity with a pre-present binding orientation time which is treated as if it were a past one (e.g. *He has told me that he wasn't feeling well*).

as ‘a domain whose central orientation time is past with respect to t_0 ’ – a definition which does not imply anything about the W-relation between t_0 and the T-bound situation times inside the domain. This definition of the temporal meaning of the past tense morpheme applies to any tense that shows past tense morphology. The difference between the relative past, the past perfect and the conditional tense resides in the other aspects of meaning they have besides this element of past meaning: they also express an (each time different) T-relation between their situation time and the binding orientation time in the past domain. In the case of the past perfect and the conditional tense, this aspect of meaning is overtly expressed by the lexical morphemes *have ... -en* and *will*, respectively. In the case of the relative past, it is not overtly expressed because T-simultaneity is the unmarked domain-internal relation. (T-simultaneity forms are unmarked in two respects: they are formally less complex than the verb forms expressing T-anteriority or T-posteriority, and they are semantically unmarked in that they are the forms that are chosen when the use of a marked form seems unnecessary, i. e. they represent the ‘default category’.²⁴)

The claim that the basic meaning of the past tense morpheme is ‘The situation time is located in a past domain’ applies to the absolute past tense as well as to the relative preterite. It follows that a single semantic (= tense-structural) meaning can be ascribed to the past tense morpheme: the past morpheme makes it clear that the situation time of the situation referred to belongs to a domain whose central orientation time is located in the past time-sphere. (Note that we are speaking about the past *morpheme*, not about the past *tense*. The forms *walked*, *had walked*, *would walk* and *would have walked* all involve the past morpheme.)

The meaning of present tense morphology can be similarly defined as ‘The situation time lies in a present time-sphere domain’. That is, whenever a form involving the present morpheme is used, the situation time belongs to a domain that is established in the present time-sphere.²⁵ It follows that the forms of the various tenses can receive a perfectly compositional analysis along the follow-

24. An illustration of the latter use is the use of the italicized tense forms in the following examples:

- (i) If Bill *received* a letter, he wrote a reply the very same day.
- (ii) If Bill *goes out*, he will put out the lights.

In examples like these the *if*-clause expresses ‘sloppy simultaneity’ (see 13.11), i. e. it uses a T-simultaneity form (viz. a relative past form – see 8.12) in spite of the fact that its situation is actually W-anterior or W-posterior to the head clause situation.

25. The reverse is not necessarily true: a present time-sphere domain can sometimes contain a situation time that is referred to by a tense form with past morphology. Consider, for example, *worked* in *He has always said that he worked in a factory* or in [*If you employ me now and fire me next week*] *I’ll at least be able to say that I worked for you [when I was nineteen]*. These (different) uses of the past tense in present time-sphere domains are explained in 9.9 and 9.18, respectively.

ing lines. (PAST and PRESENT stand for past and present morphology. PAST expresses that the situation time belongs to a domain whose central orientation time is past relative to t_0 . PRESENT means that the situation time belongs to a domain whose central orientation time lies in the pre-present, present or post-present time-zone of the present time-sphere.)

(a) Past time-sphere tenses

Absolute past tense: verb stem + PAST

Relative tenses:

Relative past tense: verb stem + PAST

Past perfect: [*have* + PAST] + V-en

Conditional tense: [*will* + PAST] + verb stem

Conditional perfect: [*will* + PAST] + *have* V-en

(b) Present time-sphere tenses

Present tense: verb stem + PRESENT

Present perfect: [*have* + PRESENT] + V-en

Future tense: [*will* + PRESENT] + verb stem

Future perfect: [*will* + PRESENT] + *have* V-en

8.37 Theoretical conclusion 5

Although each tense has a single invariant temporal meaning, it is possible to encounter metaphorical extensions of this meaning (e. g. in the case of a shift of temporal perspective).

We have defended the claim that each tense should be assigned a single invariant temporal meaning. However, this does not rule out the possibility of a metaphorical extension of this meaning. Both absolute and relative tenses allow of some metaphorical uses (which, however, are restricted in number and well-defined). As far as absolute tenses are concerned, these are the uses which we refer to as ‘shifts of temporal perspective’. Some examples of this have already been referred to:

Last week I’m *sitting* on that bench over there, watching the traffic, when suddenly two cars *collide* in front of me. (*historic present*)

[Things this morning were going smoothly until I grabbed my coffee and went out to the porch to feed the miscellaneous farm cats and smoke (...).] So there I *am*, waking up slowly and I *hear* this scratchy-scratchy-scratchy sound next to the porch. (www) (*historic present*)

The colonel *{is leaving / leaves}* tomorrow. (*present tense with reference to post-present actualization, i. e. used as a ‘futuristic form’ – see 2.9.1*)

The colonel went to bed early because he *{was leaving / left}* early the next day. (*past tense used to express posteriority, which is the past counterpart of the present tense as futuristic form*)

I *{hear / am informed / understand}* that he is going to resign. (*present tense with reference to pre-present actualization*)

Other instances of a shift of temporal perspective will be discussed below. In order to take such metaphorical uses into account, it is not necessary to adapt the formulations of the meanings of past and present tense morphology given in 8.36 and repeated here:

PAST locates a situation time in a domain which lies in the past time-sphere

PRESENT locates a situation time in a domain which lies in the present time-sphere

The fact that a situation located (i. e. T-located) in the present time-sphere is sometimes interpreted (i. e. W-interpreted) as lying in the past (e. g. in the historic present) is irrelevant to this.

8.38 Theoretical conclusion 6

The meaning of the past tense morpheme allows for the possibility that a conditional tense form is W-interpreted as referring to a situation that is posterior to t_0 . This proves that reference to temporal domains (established by absolute tenses and expanded by relative ones) is central to any viable tense theory.

The above conclusion about the meaning of the past tense morpheme is important for two reasons. First, unlike an analysis of the conditional tense which is based on the claim that the past morpheme expresses that the situation time is T-anterior to t_0 , it allows for the possibility that a situation referred to by a clause in the conditional tense may be W-posterior to t_0 . Secondly, it proves that we cannot build an adequate theory of tense without reference to temporal domains. Since temporal domains are established and expanded by tenses, it follows that we cannot do without the distinction between absolute and relative tenses. The former are necessary to establish domains (by relating their situation time directly to t_0), while the latter are necessary to express T-relations in these domains.

8.39 Theoretical conclusion 7

If there are two homophonous past tenses, they should differ in their distribution – something which we will show to be true in chapter 9.

The distinction between two homophonous past tenses naturally raises the question of their distribution. In section 8.19 it was argued that the relative past tense is not used in syntactically independent clauses. However, the picture is not so clear as regards subclauses. There are some types that use the absolute past tense, some that use the relative past tense, and some other types that can use either of them. We will go into this in various sections of chapter 9.

DEMO

V. The principle of unmarked temporal interpretation

8.40 Introduction

When there is a shift of domain within the same absolute zone (as in *She felt bored. It was raining and everybody else was sleeping*), the tense forms themselves do not express the temporal relation between the domains – see 8.21.1. It follows that such a shift of domain is only pragmatically acceptable if the temporal order of the situations is either irrelevant or recoverable in some other way, e.g. from the use of time adverbials, from the order in which the situations are reported, from the linguistic context, from pragmatic knowledge (i.e. the extralinguistic context and our general knowledge of the world) or from the bounded or nonbounded aspectual character of the various clauses. It is the role of (non)boundedness that is discussed in the following subsections.

8.41 The ‘Principle of Unmarked Temporal Interpretation’

8.41.1 The role of (non)boundedness is summarized in the following ‘**PRINCIPLE OF UNMARKED TEMPORAL INTERPRETATION**’:

In a sequence of unembedded clauses where each clause establishes a domain of its own within the same absolute zone and where there is no adverbial, contextual or pragmatic indication of temporal order, the unmarked temporal W-interpretation is as follows:

- (a) when the situations are represented as bounded, they are interpreted as following each other in the order in which they are reported;
- (b) when the situations are nonbounded (i.e. not represented as bounded), they are interpreted as W-simultaneous with each other;
- (c) when one situation is represented as bounded and the other as nonbounded, the bounded situation is interpreted as temporally included in the nonbounded one.

Before we have a closer look at these claims, it is worth stressing the following point in order to rule out any misunderstanding. The Principle of Unmarked Temporal Interpretation (abbreviation: PUTI) holds only for sequences of clauses that satisfy the following two requirements: (a) each clause in the sequence establishes a domain of its own within one and the same absolute time-zone; (b) the temporal order of the situations is neither indicated by an adverbial nor recoverable from contextual information or from pragmatic knowledge. In order to ensure that we are dealing with domain-establishing clauses we will illustrate each claim not only with examples in the past tense but also with examples that refer to the post-present. (As we have seen, the difference

between absolute and relative tense forms is not always clear when we refer to the past, since a preterite form can be either a relative or an absolute tense form. The difference is, however, clear when the reference is to the post-present, because the tense form used to express T-simultaneity in a post-present domain (viz. the present tense) is different from the tense form used to establish the domain (viz. the future tense) – see 10.1–2. This means that we can assume as working hypothesis that the past tense clauses create a new domain if the corresponding clauses referring to the post-present use the future tense.)

8.41.2 The Principle of Unmarked Temporal Interpretation involves the following claims:

- (a) The unmarked interpretation of a sequence of bounded clauses (which each establish a domain of their own in the same absolute zone) is in terms of what we may call ‘**ICONIC SEQUENCING**’: the situations are interpreted as following each other in the order in which they are reported. For example:

John *went* to the door and *knocked* three times. The door *opened* slowly.

John *will go* to the door and (*will*) *knock* three times. The door *will open* slowly.

In sentences like these, the situations tend to be interpreted as following each other directly, unless such an interpretation is pragmatically impossible or unlikely.²⁶ This is the case in examples like

He *moved* to London and *found* a job there as a teacher. He *courted* a girl called Mary and *married* her.

Perhaps he *will move* to London and (*will*) *find* a job there as a teacher. And perhaps he *will court* a girl and (*will*) *marry* her.

In sentences like these, the situations need not follow each other directly. There may be long intervals of time between them.

The tendency to interpret a sequence of bounded clauses in terms of succession is just a tendency, not a strict rule. When the clauses have different subjects and there is no contextual or pragmatic reason for adopting the succession interpretation, any of the three temporal readings is in principle available. A sentence like *Bill studied chemistry and John studied mathematics* tells us nothing about the temporal order in which these two situations actualized.

We may wonder, then, why it is that a sequence of bounded clauses is sometimes interpreted in terms of succession, as in the first two examples below, and sometimes allows any temporal order interpretation, as in the last two examples:

26. In other words, the fact that the immediate succession reading is favoured is due to a conversational implicature, which can be cancelled.

The man *went* to the door, *opened* it and *shouted* something.

The man *will go* to the door, (he *will*) *open* it and (he *will*) *shout* something.

["Did any of them marry?"] – "Yes, Bill *married* Tina, and John *married* some Italian girl."

["Will any of them marry?"] – "Yes, Bill *will marry* Tina, and John *will marry* some Italian girl."

There appear to be two factors that are conducive to a succession interpretation. The first is pragmatic knowledge. We know that going to the door must take place prior to opening it. The second is the kind of text or discourse that the sequence of L-bounded clauses is part of. If this is a story that progresses in time, then each bounded clause that is added will normally be interpreted as carrying the action forward. That is, each new situation will be interpreted as following the situation of the previous clause. The first two of the above examples appear to be part of such a story with a linear temporal structure. The answers in the last two examples are not, and therefore need not be interpreted in terms of succession.

- (b) The second claim made in the Principle of Unmarked Temporal Interpretation presented in 8.41.1 is that in a sequence of (unembedded) L-non-bounded clauses the unmarked interpretation is for the situations to be interpreted as \mathbb{W} -simultaneous.²⁷

John *stood* by the window. Mary *was* in the kitchen.

The man *seemed* reliable. He *worked* in a bank.

John *carried* the suitcase. Bill *pushed* the cart.

He *enjoyed* and *admired* the scenery of the Lake District.

John *will stand* by the window. Mary *will be* in the kitchen.

In ten years' time the man *will seem* reliable. He *will work* in a bank.

John *will carry* the suitcase. Bill *will push* the cart.

[When he is older] he *will enjoy* and (*will*) *admire* the scenery of the Lake District.

In cases like these all the verb forms establish \mathbb{W} -simultaneous domains.

As we have seen, L-nonbounded situations are represented as homogeneous, which means that there is no particular reference to an initial or terminal point. For this reason, nonbounded situations may in principle go on indefinitely. This explains why the two nonbounded situations referred to in each of the above examples are not normally interpreted as preceding or following each other. There is simply no reason why one of them should be interpreted as beginning only after, or as terminating before, the other situation. This is true even if the

27. Remember that we are dealing with unembedded domain-establishing clauses that do not contain an adverbial indicating the temporal order of the situations.

clauses form part of a story. Nonbounded clauses (not containing a time adverbial) do not normally carry the action forward. They have a 'BACKGROUNDING' rather than a 'FOREGROUNDING' function. (In a narrative text, the 'foreground' is the linguistic material which charts the progress of the narrative through time, while the 'background' consists of durative and descriptive material which serves to elaborate on the foreground.)

There is one exception to this rule. Nonbounded clauses do carry the action forward if they are interpreted inceptively (inchoatively) and therefore suggest that the situation in question did not obtain earlier. This is the case, for example, in the following, where the inceptive reading is induced by the presence of *suddenly*:

[We were sitting in the dining-room.] Suddenly there *was* a loud noise in the street.

- (c) The third claim made in the Principle of Unmarked Temporal Interpretation set out in 8.41.1 is that, when one of the two situations is L-bounded whereas the other is not, the unmarked interpretation is for the bounded situation to be included in the nonbounded one. (This is a kind of W-simultaneity relation.)

Mary *was* in the drawing-room. Suddenly Bill *came in*.

John *went* out of the room. He *was feeling* very tired.

Mary *will be* in the drawing-room. Suddenly Bill *will come in*.

John *will go* out of the room. He *will be feeling* very tired.

The reason why the nonbounded clauses are here interpreted as W-simultaneous with the bounded ones is again that they represent backgrounded information.

Here too, nonbounded clauses that are interpreted inceptively form an exception to the rule. In each of the following examples the nonbounded clause pushes the action forward because its situation is not interpreted as holding at the time of the situation referred to in the preceding clause:

[There was a loud explosion.] Suddenly all kinds of things *were flying* through the air.

[After a while the car left the main street and turned into a side street.] Shops, restaurants and beautiful houses *were gone* at once. [We only saw small grimy houses] and then suddenly we *were* outside the town.

[This time her lover threw her out of his house.] There she *was*, in the middle of the narrow street, with a strange man staring at her curiously.

[Bill asked where the children were.] Mabel *looked* anxiously at the playground.

[The next thing I knew,] she *was taking* off her clothes. [I ran out of the room in panic.]

8.41.3 It should be stressed that the Principle of Unmarked Temporal Interpretation set out in 8.41.1 stipulates only what is the unmarked temporal W-interpretation of sequences of unembedded clauses. As noted before, the unmarked interpretation may easily be ruled out by pragmatic factors. This is clear from examples like the following:

John *was* in the kitchen. Suddenly Bill *came in*.

John *was* in the kitchen. Suddenly he *went out* into the yard.

In both cases we have a combination of an nonbounded clause and a bounded one. But whereas the first example yields the unmarked inclusion interpretation, the second can only be interpreted in terms of sequence. This is because of pragmatic considerations: the W-simultaneity interpretation is ruled out by the simple fact that John could not be in two different places at the same time. In the following sequences (in which both sentences are bounded) the second sentence is interpreted as referring to the same action as the first, so that there is an interpretation in terms of W-simultaneity rather than in terms of temporal progression:

Yes, I *fired* the gun. I *shot* the old devil through the head. [It was legitimate self-defence. I had no choice.]

We *threw* a party last night and most of our friends *got drunk*.

8.41.4 Up to now we have identified three possible types of temporal W-relation in sequences consisting of two unembedded domain-establishing clauses (A and B): (a) situation B follows situation A; (b) the two situations coincide; (c) situation B includes situation A, or vice versa. However, there are still other (marked) possibilities, in which the Principle of Unmarked Temporal Interpretation set out in 8.41.1 is not observed. (Remember that we have stressed that the principle is merely a tendency, based on implicatures, not a strict rule.)

- (a) The situation of the second clause may sometimes be interpreted as W-anterior to that of the first clause, irrespective of the (non)bounded nature of the two clauses:

My grandfather *died* at the age of 89. He *was* a very healthy man, who *had* a long walk every day. (*The first clause is L-bounded, whereas the second and third are L-nonbounded. Instead of the unmarked reading, in which the first situation is included in the second and third, we get the interpretation in which the situation of the second and third clauses are W-anterior to the situation referred to in the first clause.*)

Yesterday afternoon my neighbour *was arrested*. He *stabbed* his wife in the back. (*The two L-bounded situations are not interpreted in terms of 'iconic sequencing'. The second is interpreted as W-anterior to the first.*)

Such a shift of domain (in the second clause) is only allowed if the corresponding unmarked interpretation is pragmatically impossible. For this reason it is relatively rare. To represent a situation as anterior to the situation of the previous clause we normally use a relative tense (as in *John could not take a taxi. He had gambled away all his money.*) or add a time adverbial signalling anteriority.

- (b) In sequences consisting of more than two unembedded clauses, we may sometimes find a mixture of the three possibilities referred to in the Principle of Unmarked Temporal Interpretation set out in 8.41.1:

We *made* a long journey through Italy. We *visited* Rome and Venice, and afterwards we *went* to Naples.

We *will make* a long journey through Italy. We *will visit* Rome and Venice, and afterwards we *will go* to Naples.

In each of these examples the two clauses in the second sentence establish domains of their own (with *afterwards* indicating the temporal order between them), but the situations they refer to are interpreted as W-simultaneous with that of the very first sentence. This is what typically happens when a clause referring to a situation with a complex structure is followed by several clauses describing subsituations.

- (c) In some sequences of more than two unembedded clauses the temporal order of the situations is open to interpretation (and is in fact irrelevant):

[In that year several of John's relatives had an accident.] Betty *fell* from the stairs. Bill *drove* into a lorry, and aunt Mildred *got knocked over* by a motorcycle.

[Next year several of John's relatives will have an accident.] Betty *will fall* from the stairs. Bill *will drive* into a lorry, and Aunt Mildred *will get knocked over* by a motorcycle.

Here the various domains established by the clauses following the introductory sentence are presented as an unordered set. This is also the case in examples like the following:

["What did you do this morning?"] – "Betty *did* the washing-up, I *fixed* the car, and John *planted* the tulips."

["What will you do this morning?"] – "Betty *will do* the washing-up, I *will fix* the car, and John *will plant* the tulips."

8.41.5 In 8.41.2–4 we have identified all the kinds of W-relations that are logically possible between situations that are not bound to each other by the tense forms, i. e. which are allowed by absolute tense forms. In order to pick out the possibility that is intended by the speaker, the hearer can often be guided by (a) his pragmatic knowledge of the world, (b) the information provided by temporal adverbs (if any), and (c) the nature of the text or discourse

containing the sequence, which may or may not be a story with a linear temporal structure. In the absence of these factors the interpretation of the temporal order of the situations will be in accordance with the 'Principle of Unmarked Temporal Interpretation' presented in 8.41.1.

DEMO

VI. Summary of chapter 8

8.42 Terminology

8.42.1 We started out this chapter with a review of some terms and concepts that had already been introduced in previous chapters, especially in chapter 2: **time of the full situation** *vs* **situation time** (= **time of the predicated situation**), only the latter of which is located in time by the tense form used; **homogeneous** (= **L-nonbounded**) situations (for which every subpart is representative of the whole situation) *vs* **nonhomogeneous** (= **L-bounded**) situations (for which the situation as a whole is different from any subpart of it); several types of **orientation time**, which is a time (possibly a **situation time**) with respect to which another orientation time (usually a situation time) is represented by a tense form as either **T-simultaneous** (coinciding), **T-anterior** or **T-posterior**; similar temporal relations not expressed by tense forms (referred to as **W-relations**); the use of **absolute tenses** to locate a situation time in any of the four **absolute zones** (i. e. portions of the time line defined relative to t_0) — either in the past zone (coinciding with the past **time-sphere**) or in any of the three present time-sphere zones (the pre-present, the present or the post-present zone); the use of **relative tenses** to relate a situation to (i. e. make it **temporally subordinated** to or **T-bound** by) an orientation time other than t_0 and thereby **expand a temporal domain** set up by an absolute tense form.

8.42.2 The one orientation time that is not T-bound by any other in a domain is the **central orientation time**. The absolute zone in which it is located determines the overall temporal nature of the domain. Thus, in (*He said*) *he would do it tomorrow*, the situation time referred to by *would do* forms part of a past domain, established by the past tense form in *He said* (or, in the absence of such a past tense head clause, by an unspecified central orientation time located in the past zone). There is a certain correlation between temporal subordination and **syntactic subordination**: for one, the use of a relative tense to express T-simultaneity is excluded in a syntactically independent clause; for another, the use of an absolute tense is excluded in some types of subclauses.

If a situation time is represented as **T-simultaneous** with another situation time, the exact duration and temporal location of the T-bound situation time (= **time of the predicated situation**) is unidirectionally determined by the binding situation time. Thus, in *I noticed at once that Jim was ill*, the situation time expressed by [*Jim*] *was* [*ill*] strictly coincides with the time of me noticing it, which is merely a point (rather than a durative interval) in the past time-sphere. Of course, the full situation time of Jim being ill will be extralinguistically interpreted as much longer than, and as properly including, the time of me noticing it and may possibly even include t_0 , which shows that **W-simultaneity** is a concept quite different from T-simultaneity.

Sometimes the speaker does not use a relative tense form (expanding an already established domain) but instead uses an absolute tense form, causing a **shift of domain**, either within the same time-zone or from one time-zone to another. When the shift of domain is within the same zone, the hearer may draw clues as to the temporal ordering of the situation times from such sources as the presence of temporal adverbials, the order of appearance of the clauses, the linguistic and extralinguistic context, his pragmatic knowledge of the world or, as will be summarized below in 8.45, the (non)boundedness of the situations referred to.

We speak of a **shift of temporal perspective** when a situation intended to be interpreted as located in one absolute zone is referred to by a tense form that is characteristic of another zone, as when the present tense is used with reference to the post-present zone (e.g. *They're leaving soon*), to the past zone (e.g. *Napoleon strikes back*) or to the pre-present zone (e.g. *I hear John has been promoted*).

8.43 Evidence for the existence of two past tenses

There are two tenses in English that make use of the same past tense morphology but which differ in meaning: the absolute past tense means 'The situation time is located in the past time-sphere', whereas the relative past tense means 'The situation time is T-simultaneous with an orientation time in a past domain (or in a past or pseudo-past subdomain)'. We have adduced ten arguments for this claim. These are briefly summarized here. Needless to say, the reader can only properly evaluate their validity by examining their full discussion in part IV of this chapter.

8.43.1 The view that the sentence *John felt unhappy when he was alone* contains both an absolute past tense form (*felt*) and a relative one (*was*) is corroborated by the fact that we clearly distinguish an absolute tense form (*will be*) and a form indicating T-simultaneity (*is*) in its post-present counterpart: *John will be unhappy when he {is / *will be} alone*.

8.43.2 In a sentence like *Mary told me on the phone last night that at the dinner party tomorrow she would suddenly say that she felt sick*, the past tense form *felt* refers to a situation which lies in the post-present. This kind of sentence demonstrates the inadequacy of the assumption that there is only one past tense in English, which is used to locate a situation time prior to t_0 . By contrast, this use of the past tense is naturally explained in a theory which assumes the existence of a relative past tense (next to an absolute one), which expresses T-simultaneity in a past domain, irrespective of the W-location of the binding time relative to t_0 .

8.43.3 Distinguishing between absolute and relative past tenses explains why some past tense forms are ‘backshifted’ in past represented speech while others are not. Consider:

“I was in Greece at the time.” → Jane said she *had been* in Greece at the time. (*The original absolute past tense form was is ‘backshifted’.*)

“Millie complained that she wasn’t feeling well.” → John told us that Millie *had complained* that she {*wasn’t* / #*hadn’t been*} feeling well. (*The original relative past tense form wasn’t feeling cannot be ‘backshifted’ without triggering an unwanted anteriority reading.*)

8.43.4 The claim that there are two types of past tense in English, an absolute and a relative one, is supported by the fact that an absolute past tense form is compatible with an unanchored punctual time-specifying adverbial (i. e. an adverbial of the type *at X o’clock*), whereas a relative past tense form is not:

I was still thirsty at five o’clock. (*was is an absolute past tense form*)

Jim whispered that he *was* still thirsty. (*On the unmarked interpretation, was is a relative past tense form expressing T-simultaneity.*)

Jim whispered that he *was* still thirsty at five o’clock. (*Was cannot be interpreted as expressing T-simultaneity. It is an absolute tense form, locating its situation time at a time which is interpreted as preceding the time of the whispering.*)

8.43.5 In a sentence referring to a past habit, an absolute past tense form can be replaced by *used to* (which expresses T-anteriority to some orientation time), whereas a relative past tense form cannot:

As a child I {*was* / *used to be*} afraid of spiders. (*Was is an absolute past tense form expressing T-anteriority to *to*.*)

I saw with my own eyes that he {*was* / **used to be*} afraid of spiders. (*Was is a relative past tense form expressing T-simultaneity with the past situation time of saw.*)

8.43.6 The existence of a relative past tense (expressing T-simultaneity with an orientation time in a past domain) accounts for the obligatory use of the past tense (rather than the conditional tense) in the adverbial time clause of a sentence like the following:

John decided that he would wait until his wife {*arrived* / **would arrive*}.

If we assume that the meaning of *until* includes an implicit orientation time – *until* means ‘until the time that’ – the use of the past tense is explained naturally: it represents the situation time of John’s wife’s arrival as T-simultaneous with the implicit orientation time.

8.43.7 *John said that Mary was ill* allows a reading in which Mary was ill at the time of John’s utterance and one in which Mary was ill at some time

preceding John's utterance. Our claim that these two interpretations are a matter of ambiguity (tense structure) and not vagueness (W-interpretation) is confirmed by Lakoff's well-known test to distinguish between ambiguity and vagueness.

8.43.8 In *John said that he was writing a book*, the use of the progressive form is compulsory if we want to express the idea that at the time of his utterance John was engaged in the (telic) situation of writing a book. In the same way as we cannot say **I write a book*, we cannot say **John said that he wrote a book* (on the relevant interpretation). This can only be explained if we posit the existence of a relative past tense meaning 'The situation time is T-simultaneous (= strictly coinciding) with an orientation time in a past domain'. Since the time of saying (which functions as T-binding time) is (nearly) punctual, we need to represent the much longer situation of writing a book as homogeneous (by using the progressive), so that the full situation can be conceived of as consisting of representative subparts, one of which has the same restricted duration and temporal location as John's utterance and can therefore function as the time of the predicated situation.

8.43.9 In a theory adopting the existence of a relative past tense meaning 'the situation time is T-simultaneous (= strictly coinciding) with a past orientation time', we can nicely explain why the subclause in a sentence like *John knew that I wrote a book* cannot be interpreted in terms of T-simultaneity (i. e. as using a relative tense). If *wrote* were a relative past tense form, the bounded situation of my writing a book would have to derive its temporal specification from the nonbounded situation time of John knowing it, which is pragmatically impossible.

8.43.10 English and Dutch are cognate languages. In Dutch, the absolute and the relative past tenses are clearly distinct, since only an absolute preterite form can be replaced by the present perfect. Thus, to use an English gloss, we find Dutch sentences like *Yesterday he {admitted / has admitted} that his father {was / *has been} dead*. This difference in substitutability – the absolute past tense in the head clause can be replaced by the present perfect, while this substitutability does not exist for the relative past tense in the subclause – shows that Dutch has two past tenses, an absolute one and a relative one. This suggests that it is quite possible that in English, too, there are two distinct past tenses.

8.44 Further theoretical conclusions

From the ten arguments summarized above, we have drawn seven theoretical conclusions, which are summarized here very succinctly. Firstly, the existence of two distinct meanings (an absolute and a relative temporal meaning) corre-

sponding with a single form (the past tense) is not a case of one past tense being ambiguous but of two different tenses having the same formal expression (i. e. being homophonous). Secondly, what is ‘past’ about the meaning of the past tense morpheme used in both absolute and relative preterite forms is the idea that the situation time belongs to a past domain. Thirdly, the past tense morpheme in all the relative past time-sphere tenses (the relative past tense, the past perfect and the conditional tense and the conditional perfect) conveys the meaning ‘The binding orientation time forms part of a past domain’. Fourthly, there is a parallelism between the system of tenses with a past tense morpheme and the system of tenses with a present tense morpheme, in that all the tenses belonging to the former system express that the situation time is located in a domain lying in the past time-sphere and all the tenses belonging to the latter system express that the situation time is located in a domain lying in the present time-sphere domain, and in that the tense expressing T-simultaneity is the unmarked one of all the tenses in either system. Fifthly, although each tense has a single invariant temporal meaning, it is possible to encounter metaphorical extensions of this meaning (e. g. in the case of a shift of temporal perspective). Sixthly, the meaning of the past tense morpheme allows for the possibility that a conditional tense form is W-interpreted as referring to a situation that is posterior to t_0 . This proves that reference to temporal domains (established by absolute tenses and expanded by relative ones) is central to any viable tense theory. Seventhly, if there are two homophonous past tenses, they should differ in their distribution – something which we will show to be true in chapter 9.

8.45 The role of (non)boundedness in the unmarked temporal interpretation of situations

When there is a shift of domain within the same absolute zone, the temporal order of the situations (if relevant at all) may be recovered from a variety of clues. One clue that was discussed in some detail in part V is the bounded or nonbounded nature of the situations as represented by the various (unembedded) clauses using an absolute tense form. This has led to the formulation of the **Principle of Unmarked Temporal Interpretation**, summarized as follows:

In the absence of any adverbial, contextual or pragmatic indication of temporal order,

- (a) a sequence of bounded clauses will tend to be interpreted in terms of **iconic sequencing**: situations follow each other in the order in which they are reported (e. g. *John went to the door and knocked three times. The door opened slowly*);
- (b) a sequence of nonbounded clauses will tend to be interpreted as W-simultaneous to each other (e. g. *John stood by the window. Mary was in the kitchen*);

- (c) a sequence of two clauses in which one clause is bounded whereas the other is not will tend to be interpreted in terms of inclusion: the bounded situation is included in the nonbounded one (e. g. *John went out of the room. He was feeling very tired*).

DEMO

DEMO

9. Temporal subordination in the various time-zones

I.	Temporal subordination in a past time-sphere domain	444
A.	The expression of T-anteriority in a past domain	444
9.1	The past perfect	444
9.2	Further remarks	446
B.	The expression of T-simultaneity in a past domain	448
9.3	The relative past tense	448
9.4	Theoretical remark	449
C.	The expression of T-posteriority in a past domain	450
9.5	The conditional tense	450
9.6	The past versions of futurish forms	451
D.	The T-relation expressed by the conditional perfect tense	457
9.7	The conditional perfect tense	457
II.	Temporal relations in a pre-present domain	459
9.8	The relevance of the W-interpretation of the present perfect clause	459
9.9	T-relations in a domain established by an indefinite perfect	460
9.10	T-relations on an up-to-now reading of the head clause	474
9.11	Shifting the domain after a continuative perfect	478
9.12	Temporal subordination after a continuative perfect	483
9.13	Pre-present domains and use of tenses: summary	484
III.	Present domains	485
9.14	Head clauses referring to a nonrepetitive present situation	485
9.15	Head clauses referring to a present repetitive hypersituation	487
IV.	T-relations in a post-present domain	488
A.	Definition of 'post-present domain'	488
9.16	What counts as a post-present domain?	488
B.	T-relations in a post-present domain	488
9.17	Expanding a post-present domain	488
C.	Expressing T-anteriority in a post-present domain	491
9.18	The past tense expressing T-anteriority in a post-present domain	491
9.19	The present perfect expressing T-anteriority in a post-present domain	493
D.	The expression of T-simultaneity in a post-present domain	494
9.20	Coincidence with the central orientation time of a post-present domain	494
9.21	T-simultaneity with an orientation time coinciding with the central orientation time	498
E.	The expression of T-posteriority in a post-present domain	499
9.22	T-posteriority in a post-present domain	499
9.23	The theoretical status of pseudo-absolute tense forms	501
9.24	Subdomains and recursivity	502

9.25	Relating a situation time to the situation time of a future perfect	503
F.	The explanatory force of this analysis of tenses in post-present domains	504
9.26	Observation 1	505
9.27	Observation 2	507
V.	Direct and indirect binding	516
9.28	Definitions	516
9.29	The distribution of direct and indirect binding	519
VI.	Summary	523
9.30	The expression of T-relations in a past domain	523
9.31	The expression of T-relations in a pre-present domain	524
9.32	The expression of T-relations to a present orientation time	525
9.33	The expression of T-relations in a post-present domain	526
9.34	Direct and indirect binding	527

DEMO

Abstract

In chapters 3–7 we have seen how temporal domains can be established in each of the four absolute time-zones by the use of the preterite, the present perfect, the present tense and the future tense, respectively. In this chapter we investigate which tenses can or must be used to ‘expand’ such a temporal domain. For example, in *I’ve told you before that I had cancer*, the present perfect form *have told* establishes a pre-present domain, which is expanded by the use of the past tense *had*, which represents my having cancer as T-simultaneous with the pre-present time of my speaking to you.

In part I (= sections 9.1–7) we examine the expansion of temporal domains that are established by a preterite form. It is shown that the past perfect, the relative preterite and the conditional tense are used to express T-anteriority, T-simultaneity and T-posteriority, respectively, irrespective of whether the binding time is the central orientation time of the domain or a situation time that is itself temporally subordinated. An example like *He said he would beat up any customer who did not pay for the drinks they had ordered* illustrates this: *would beat up*, *didn’t pay* and *had ordered* express T-posteriority, T-simultaneity and T-anteriority, respectively, to an each time different binding time in the past domain established by *said*.

Part II (= sections 9.8–13) deals with pre-present domains. It is shown that the only way to expand a pre-present domain involves a ‘shift of temporal perspective’: the pre-present central orientation time is treated as if it were a past time, so that the tenses used to T-relate a situation time to it are the same as are used in past domains. For example: *He has often told me that he would beat up any customer who did not pay for the drinks they had ordered*. However, it is shown that a pre-present domain can be expanded this way only if the central orientation time lies completely before t_0 . When the present perfect receives a ‘continuative’ reading or a ‘re-

gency’ interpretation, the subclause that is added normally uses an absolute tense, which shifts the domain: *You’ve known for some time that I have cancer*.

In part III (= sections 9.14–15) it is explained that a present domain cannot be expanded, because the central situation time is located at t_0 . Any relation to this central time is a relation to t_0 , i.e. an ‘absolute relation’, expressed by a verb form creating a new domain.

Part IV (= sections 9.16–25) explains that when a post-present domain is expanded, there is again a shift of temporal perspective: the central situation time is treated as if it were t_0 , so that the tense forms used to T-relate a situation time to this ‘pseudo- t_0 ’ are ‘pseudo-absolute’ tense forms. Thus, in *If you kill him tonight you will regret for the rest of your life that you murdered him in front of his children*, the form *murdered* locates the killing anterior to the time of the regretting. The form *murdered* creates a ‘pseudo-past’ subdomain within the over-all post-present domain. This subdomain can be expanded as if it were a real past domain. Part IV also discusses the theoretical status of pseudo-absolute tense forms, the recursivity of the rules governing the tense system (which can establish domains as well as subdomains) and the analysis of temporal domains established by a future perfect. Part IV is closed off with the discussion of two particular test cases which nicely illustrate the explanatory force of the proposed analysis.

Finally, part V (= sections 9.28–29) is concerned with the difference between ‘direct’ and ‘indirect binding’. In the former case a subclause is T-bound by its own head clause (as in *When he first visited the house, he had noticed the strange smell in the kitchen*); there is indirect binding if a subclause is not bound by the situation time of its own head clause, but by the situation time of the syntactically higher clause binding its head clause (as in *When he had first visited the house, he had noticed the strange smell in the kitchen*.)

I. Temporal subordination in a past time-sphere domain

Each kind of domain (whether past, pre-present, present or post-present) has its own system to express the (domain-internal) T-relations that form part of the process of temporal subordination. The purpose of Part I (= sections 9.1–7) is to investigate the system of relative tenses expanding a past time-sphere domain.

A. The expression of T-anteriority in a past domain

9.1 The past perfect

T-anteriority in a past domain is expressed by means of the past perfect, irrespective of whether the binding time is the central orientation time or another orientation time within that past domain.

In order to represent a situation time as T-anterior to another time in a past domain, the past perfect is used. This is the case, irrespective of whether the binding time is the ‘central orientation time’ (see 8.15) of the past domain or another orientation time located in that domain.

Maud left her husband after he had wrongly claimed that he had seen with his own eyes how Maud had made advances to a young man she had run across in the street. (*Only had claimed T-relates its situation time to the central orientation time, which is the situation time of left. Each of the other past perfect forms T-relates its situation time to the situation time of its head clause, which each time uses the past perfect.*)

He thought I had been living there for some time. (*The central orientation time is the binding orientation time.*)

She said that she would tell Mary that John had said that he had done it all by himself. (*The situation time of had done is bound by the situation time of had said, which is itself bound by the situation time of would tell, which is itself bound by the central orientation time, i. e. the situation time of said.*)

The tense structure of the last example is represented by Figure 9.1.

9.1.1 The past perfect can express the same types of T-anteriority as are expressed by the absolute past tense and the present perfect. Thus, when the past perfect represents the situation time as past with respect to the binding orientation time, it resembles the absolute past tense (which represents the situation time as past with respect to t_0).

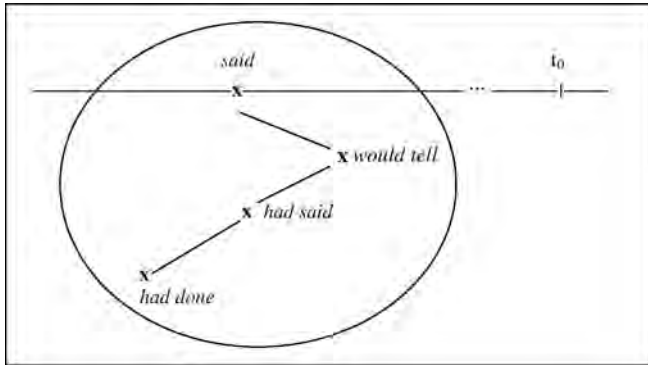

Figure 9.1. The tense structure of *She said that she would tell Mary that John had said that he had done it all by himself.*

[Two weeks ago fire destroyed the cottage] that I *had sold* a couple of months before. (Compare with: '[Fire has destroyed the cottage that] I sold a couple of months ago'.)

When it locates its situation time in a period leading up to a past orientation time, the past perfect resembles the present perfect (which locates its situation time in a period leading up to t_0). Like a present perfect clause, the clause in the past perfect may then receive either the T-reading 'situation time completely before orientation time' (which leads to the 'indefinite' W-reading) or the T-reading 'situation time co-extensive with the period leading up to the orientation time' (which leads either to a continuative past perfect W-reading or to an 'up-to-then' W-reading, which is the past counterpart of an 'up-to-now' W-reading – see 5.4).

[We could easily have entered the temple because] someone *had just unlocked* the door. (*past perfect with indefinite interpretation implicating a resultant state*)

[When I found the medal in the gutter,] it *had* apparently *been lying* there for some time. (*past perfect with continuative interpretation: compare with The medal has been lying here for some time.*)

[When he came back, I asked him] what he had been doing. (*nonquantificational constitution reading*)

[When I lit the cigarette I realized that] that was the tenth cigarette I *had smoked* that day. (*quantificational constitution reading*)

See chapter 5 for a discussion of the various T-readings ('before now' and 'co-extensive') and W-readings ('indefinite', 'up-to-now' and 'continuative') of clauses in the present perfect.

9.2 Further remarks

9.2.1 It should be remembered that the temporal relation which exists between two situations in the real world is not necessarily expressed by the verb forms of the clauses reporting these situations. (In other words, there may be W-relations that are not expressed as T-relations – see 2.16.1). This explains why sentences of the type *In May I spoke to the boy whose father had died in the February bomb attack* can alternate with sentences like *In May I spoke to the boy whose father died in the February bomb attack*. Both sentences receive the same temporal W-interpretation but they differ in the T-relations that they express. In the former case *had died* temporally subordinates the situation time of the subclause to the situation time of the head clause: *had died* is a relative tense form expressing T-anteriority in a past domain. However, there is no temporal subordination when the preterite is used: *died* is an absolute preterite establishing a new domain (i. e. ‘shifting the domain’ – see 8.21.1).

This kind of shift of domain is quite common in *after*-clauses and in clauses functioning as the head clause of a *before*-clause, because the temporal relation between the head clause situation and the subclause situation is sufficiently clear from the semantics of the temporal conjunction:

He retired soon after he {*turned* / *had turned*} sixty.

After the board {*had met* / *met*} the company called a press conference.

Some students {*had left* / *left*} before the lecture ended. (*There is a slight difference of interpretation between had left and left: only the former implicates the resultant state ‘some students were no longer present’ – see 5.37.*)

The wounded pedestrian {*had died* / *died*} before the ambulance arrived. (*similar*)

It should be noted, however, that (in Standard Br. E.) there are two cases in which the past tense cannot alternate with a past perfect:

- (a) The past tense cannot alternate with a past perfect which receives a ‘co-extensive’ (see 5.2) T-reading (i. e. the situation time leads up to the binding time but does not include it):

She first came to visit me after I {*had been* / **was*} living in Hurford for 15 years. (*continuative W-reading*)

He divorced his wife after they {*had been* / **were*} married for 30 years. (*idem*)

I {*had been* / **was*} living in Hurford for 15 years before she paid me a visit. (*idem*)

There is one exception: the past tense can alternate with the past perfect (on a co-extensive T-reading) in a head clause combining with a *before*-clause that is a ‘**NARRATIVE TIME CLAUSE**’, i. e. a time clause which does not specify an Adv-time but ‘pushes forward the action’. (For more details on ‘narrative’ time clauses, see 13.1.2 and 14.11.4.)

I {*lived / had lived*} in Hurford for 15 years before I found out that it was built on the remains of a Roman fortress.

They {*had been / were*} married for 30 years before they suddenly decided to divorce.

- (b) The past tense cannot alternate with the past perfect either in nonbounded (homogeneous) Adv-time-clauses when there is no adverbial, contextual or pragmatic indication that the clause should not be interpreted in terms of W-simultaneity:

He said that he *had been* in love with her (when he was young). (*The that-clause is interpreted in terms of anteriority.*)

He said that he *was* in love with her when he was young. (*The that-clause is still interpreted in terms of anteriority.*)

He said that he *was* in love with her. (*Out of context, the that-clause is not interpreted in terms of anteriority. Therefore, this sentence cannot substitute for He said that he had been in love with her.*)

9.2.2 Apart from the past perfect, there is another tense that would seem to express T-anteriority in a past domain, viz. the conditional perfect (*would have V-en*). However, the conditional perfect does more than just express T-anteriority. It also makes it clear that the binding orientation time to which the situation time is T-anterior is itself T-posterior to another orientation time in the past domain. The conditional perfect thus expresses a complex T-relation, which means that it does not belong to the set of 'pure' relative tenses (which express a single T-relation) but relates to another part of the system – see 9.7.

9.2.3 A sentence involving a *since*-clause that refers to a period leading up to some past orientation time normally makes use of the past perfect in both head clause and *since*-clause.

[He whispered that] he *had been waiting* for this moment ever since he *had seen* her walk past his window three years before.

[Herman looked at the bottle of pills.] He *had been thinking* of suicide more and more since he *had been living* in Bournemouth.

However, the past tense may be found in the head clause of a *since*-cleft, i. e. in a specificational sentence of the form 'it was + measure phrase + *since*-clause' (see 5.21.1). In that case the sentence always forms part of a stretch of free indirect speech.

[The lioness looked at us with greedy eyes.] It *was* probably days since she had last had a decent meal. (*expresses the narrator's thoughts*)

It *was* a long time since I had stopped drinking alcohol.

In such examples the past perfect can also be used in the head clause, though it sometimes sounds rather cumbersome.

Another possible exception concerns the *since*-clause. If the situation it refers to does not continue up to the binding orientation time, the past perfect can be replaced by the past tense.

The tree had grown a lot since it {had been / *was*} planted.

John had been confused since he {had met / *met*} Jill.

John had been confused since he {had known / **knew*} Jill. (*The situation of John knowing Jill continues up to the binding orientation time.*)

[Reichel laughed, a bit flustered.] Gates had been sending her e-mail and love letters since he *met* her the previous April. (www)

[The following day I was back at work, which was the way] it had been since I *found out* that I had developed cancer. (www)

[I drove across the San Fernando Valley to pick her up. I was happy to do this because] I hadn't seen much of Jan since she *met* Beefheart at a party the month before. (www)

B. The expression of T-simultaneity in a past domain

9.3 The relative past tense

T-simultaneity in a past domain is expressed by means of the relative past tense, irrespective of whether the binding time is the central orientation time or another orientation time in that past domain.

9.3.1 In order to represent a situation time as T-simultaneous with an orientation time in a past domain we use the relative past tense (preterite), irrespective of whether the binding orientation time is the central orientation time or another orientation time in the domain. (In other words, the relative past is the only tense that can express T-simultaneity in a past domain or 'subdomain' – see 2.50.)

He said that he *was feeling* hungry.

He promised he would do it when he *had* time.

He said he had panicked when the milk *boiled over*.

The tense structure of the latter sentence is represented in Figure 9.2.

9.3.2 Since the only condition for the use of a relative past tense is that the binding orientation time must form part of a past domain, and since a past

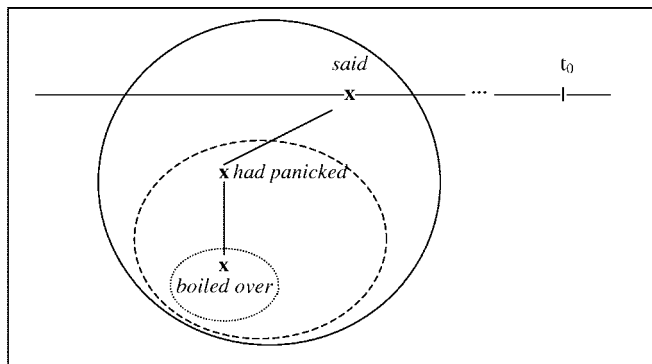

Figure 9.2. The tense structure of *He said he had panicked when the milk boiled over.*

domain has been defined as a domain whose central orientation time is located in the past time-sphere, the situation referred to by a relative tense form does not need to be W-anterior to t_0 . For example, a relative past tense can represent its situation time as T-simultaneous with the time of a situation which is W-interpreted as following t_0 . (In that case the time of the situation referred to in the relative past tense must also be W-interpreted as lying in the post-present. This follows from the fact that the relative past tense expresses T-simultaneity, i. e. strict coincidence – see 2.17.1.)

Yesterday John announced that he would retire from business when he *was* sixty, [which is in two years' time.]

In this example, the situation time of *would retire*, as well as the situation time of *was sixty* (which is T-simultaneous with the former) must be understood as W-posterior to t_0 because of what is said in the final relative clause.

9.4 Theoretical remark

The grammaticality of *was* in the above example is very important from a theoretical point of view, because it furnishes definitive evidence that English has two past tenses – see also 8.23–32. The semantics of the absolute past tense is: 'The situation time is located in the past time-sphere, where it forms the central orientation time of a past domain; it lies completely before t_0 and is felt to be disconnected from the present'. The semantics of the relative past is: 'The situation time is represented as T-simultaneous with an orientation time belonging to a past domain or subdomain (or to a pseudo-past subdomain – see 9.18); its location relative to t_0 is not T-expressed'. Since the past tense form *was* in the example in 9.3.2 does not T-locate its situation time before t_0 , but rather represents it as coinciding with the binding situation time

of a situation which is represented (by *which is in two years' time*) as lying entirely in the post-present, *was* cannot possibly be analysed as an absolute past tense form.

C. The expression of T-posteriority in a past domain

T-posteriority in a past domain is expressed by means of the conditional tense (i. e. '{*would / should*} + present infinitive') or by means of the past tense of a 'futurish form', irrespective of whether the binding time is the central orientation time or another orientation time within that past domain. The choice of a form to express T-posteriority depends on the precise meaning which is to be expressed.

9.5 The conditional tense

9.5.1 The unmarked tense form to express T-posteriority to an orientation time that forms part of a past domain is the conditional tense, i. e. '*would* + infinitive'. (The term 'conditional' for the tense which is formally represented by '*would* + infinitive' is not ideal, since the use of *would* as a tense auxiliary, to express 'future-from-the-past', is quite separate from its use as a marker of conditional meaning in the head clause of a conditional sentence. However, the term is the one that has traditionally been used, and so we adopt it here for convenience. We will, however, make a point of referring to 'the conditional tense' rather than to 'the conditional' as a reminder that the function of '*would* + infinitive' as a tense form is to locate situation times in time rather than to convey conditional meaning.)

Note that it is immaterial to the use of the conditional tense whether the binding orientation time is the central orientation time of the domain or another orientation time in the past domain (i. e. the central orientation time of a subdomain inside the past domain).

I thought you *would help* me.

John said that Bill thought you *would help* me.

He had promised that he *would* henceforth *behave* himself.

She predicted that Bill *would* soon *tell* me when he *would make* his decision.

She said that he had promised that he *would* soon *tell* her when he *would make* his decision.

The tense structure of the latter sentence is represented by Figure 9.3.

9.5.2 Because the conditional tense expresses no more than that the situation time is T-posterior to an orientation time in a past domain, it leaves vague

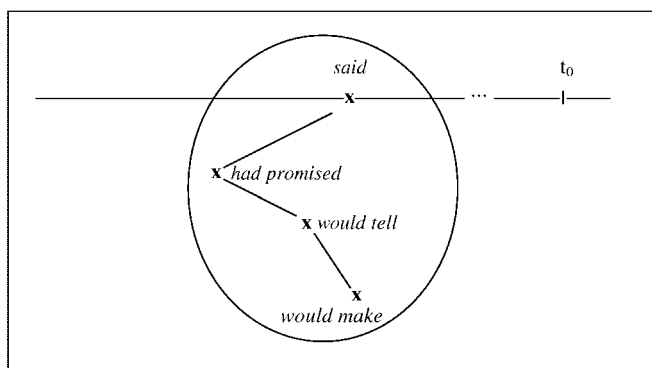

Figure 9.3. The tense structure of *She said that he had promised that he would soon tell her when he would make his decision.*

whether the situation time is W-anterior, W-simultaneous or W-posterior to t_0 – see also 9.6.9. Thus, we don't know from *Ruben said he would pray for her* whether Ruben has already prayed for her, is praying for her right now, or will perhaps do so in the future.

9.5.3 In the same way as *shall* is still possible as an alternative to *will* in the future tense (see section 7.5.1), *should* can replace *would* after a first person subject. It is usually considered as more formal than *would*.

I realized I {*would* / *should*} have to stay there for another three weeks.

9.6 The past versions of futurish forms

It was pointed out in section 2.9 that not only future tense forms but also some 'futurish' verb forms can be used to represent a situation time as T-posterior to t_0 (i. e. to establish a post-present domain). In the same way, T-posteriority to an orientation time in a past domain can be expressed not only by the conditional tense but also by the past tense of these futurish forms. Since each of these forms has its own connotation(s) (see 7.7–16), the main problem for a nonnative speaker who wants to express T-posteriority in a past domain is to choose the particular form that is most suitable to express the desired connotation. In other words, there are contexts in which it is not suitable to use the conditional tense and there are contexts in which it is not suitable to use the past tense of one or other futurish form. The following rules (or tendencies) can be pointed out.

9.6.1 In past represented speech (as defined in 8.25.1) we can use all the past tense versions of the future and futurish verb forms and auxiliaries that can T-

locate a situation time in the post-present (with their own typical aspects of meaning – see 7.7–16).

The librarian did not notice that the pile of books *was about to fall over*.

Everybody could see that there *was going to be* a storm. (*The posterior situation was predictable at the past time of the head clause situation.*)

You might have told us in advance you *were coming*. (*arranged future-from-the-past*)

It was announced that the Prime Minister *was to visit* Australia in spring. (*The posterior situation depends on an official decision.*)

He did not know what his father *would say*.

I sensed that he *was on the point of doing* something stupid. (*immediate future*)

Our coach told us their goalkeeper was injured and *would not be playing*. (*'matter of course' meaning: given the circumstances, it was only natural that the goalkeeper would not be playing.*)

I hoped the train I was waiting for {*wouldn't be / wasn't*} late again. (*Compare with 9.22.2 below.*)

I realized I would have to hurry because my train *left* at 5.12 p.m.

9.6.2 If we delete the head clauses of these examples, the result is a stretch of 'FREE INDIRECT SPEECH', where someone's words or thoughts are reported without there being an introductory verb of saying or thinking. As far as the use of tenses is concerned, free indirect speech is just like indirect reported speech, except that informal English will sometimes use *was going to* where less informal English uses *would*.

[The girl was trembling with fear.] The burglar {*wouldn't have / wasn't going to have*} any hesitation about killing her [if he spotted her in her hiding-place].

[I was still running 6:20 miles, but I was struggling and breathing hard.] It *wasn't going to be* long before I started to crash. (www)

A condition for this use of *was/were going to* is that the speaker assumes someone's point of view (located at the past narrative 'now'), from which the situation referred to with the help of *was/were going to* is predictable. This explains why the use of *were going to* is odd in the first of the following examples, but not in the second:

[The procession had now begun to climb the hill.] Soon they {*would reach / ?were going to reach*} the little church at the top.

[The procession had now begun to climb the hill.] Soon they {*would reach / were going to reach*} the little church at the top [and discover that the famous statue was missing].

In the second example, the last clause is easily interpreted as representing the anticipation of an onlooker watching the procession, and this encourages an

interpretation of *were going to reach* as the prediction made by that onlooker at the time that the procession begins to climb the hill. In the first example, there is no clear indication of such an extra, past, point of view, and the example is thus interpreted as involving only one ‘viewer’, namely the narrator located at speech time.¹ (Incidentally, the same restriction applies to epistemic modals.)

In free indirect speech, *was going to* can also have its straightforward meaning ‘it was predictable that X would happen’. This use is similarly restricted. It needs not only a past point of view from which the situation is predictable but also a *perceiver* at that point of view. For example:

The vase *was always going to get broken*, with so many people brushing past it.

So many things get turned into exercise videos and classes it *wasn't going to be* long before it happened with ballet. (www)

It *was always going to get* a bit rough as everybody was jostling for position, [but, luckily, I had the horse to get me through.] (www)

9.6.3 If the speaker wants to express that a situation which did not yet hold at the past orientation time was at that time intended, predictable or expected to happen later, he will normally use *was/were going to*. This parallels the use of the present tense of *be going to* for predictable post-present situations (see 7.10).

I was looking for my racket because I {*was going to* / **would*} play tennis at ten o'clock.

He told me confidentially that he {*was going to* / #*would*} leave the firm. (*Would is fine if it has volitional meaning or if there is an implicit condition, but not with exactly the same meaning as was going to*)

Anxiously, he looked at the clouds. There {*was going to be* / **would be*} a storm within minutes.

Was going to is certainly the normal form if the reference is to a past intention that was never fulfilled (see also 7.9.4).

I {*was going to* / **would*} pay you a visit this afternoon, [but I have to attend an emergency meeting of the board.]

You {*were going to* / **would*} give me your hairdresser's telephone number. (*used as a reminder*)

To T-represent the posterior situation as absolutely pre-determined by circumstances that already exist at the binding orientation time, we use a nonpro-

1. The extra point of view could be the past point of view of the current narrator. For example, the second example could continue *I knew I had to do something fast* and could be nonfictional, but there would still be at least two points of view: the point of view of the person who is *now* the narrator but who then was someone located at the time of the procession, and the point of view of the person who is now the narrator, located at speech time.

gressive past tense form. This is the past counterpart of a nonprogressive present tense form which refers to post-present actualization (see 3.8) and is used in a similar way.

[We would have to hurry.] The last train *left* at 11.46. (*Compare with We will have to hurry. The last train leaves at 11.46.*)

[There was no time to waste.] It was already two o'clock in the morning and the regiment *attacked* at dawn. [He must get this message to them within the next two hours.]

9.6.4 When an 'arranged-future-in-the-past' (or rather 'arranged-future-from-the-past', as it is a future relative to the time of a past arrangement) concerns a personal arrangement, we normally use the progressive form of the past tense. This parallels the use of the present progressive for arranged post-present situations.

[Mary and Bill were stuffing a goose.] They *were having* guests that evening.

[There was no point in inviting the Robinsons, as] they *were leaving* the day before the party.

[The man was very nervous.] He *was getting* married that morning.

[I didn't call him up to tell him the news because] I *was going* to his office the next day.

This use of the progressive past is possible even if the context makes it clear that the action planned was not actually performed.

He *was leaving* the country in June, [but his accident has made this impossible.]

However, this idea of unreality is more frequently expressed by *was going to*. The latter is the only past futurish form that can implicate nonactualization by itself – see 3.8:

["Have you mended the fence yet?"] – "I *was going to* do it yesterday."

Here, the use of *was going to* implicates that the speaker did not mend the fence. If he did mend it, the speaker is expected to say *Yes, I have* or something like *I did yesterday*. This follows from the Gricean Maxim of Relation (relevance): other things being equal, the present is more relevant than the past. The speaker should not represent the mending of the fence as a past intention if he can represent it as something that has become a fact at t_0 . Like any conversational implicature, this implicature of 'unfulfilled intention' can be cancelled by the context without creating semantic contradiction:

A: "Have you mended the fence yet?"

B: "I *was going to* do it yesterday."

A: "And did you do it yesterday?"

B: "Yes."

Although speaker B is clearly being uncooperative in his first response, he cannot actually be said to contradict himself with his second response.

9.6.5 Parallel to the use of the present tense of *be to* for official arrangements regarding the future (see 7.15), the past tense of *be to* can be used to refer to a past official arrangement concerning the actualization of a posterior situation:

[There were a lot of plainclothes policemen in the hotel] where the conference *was to take* place.

[In the afternoon the Princess left for New Zealand,] where she *was to join* her husband.

9.6.6 Both *would* and *was to* can be used to represent a situation that is posterior to a past orientation time as a past fact (rather than as something that was expected at the past binding orientation time). That is, *was to* and *would* can express that a situation which did not actualize before or at the past binding orientation time did actualize later (but still in the past).

[In that year they moved to Heathfield,] where they *{were to / would}* spend the most difficult years of their lives.

Ten years later, Percy *{would / was to}* be the most popular actor in London.

[Soon after that war ended,] another one *{would / was to}* begin.

[He entered Parliament at the age of 31.] Five years later he *{would / was to}* be the youngest Prime Minister the country had ever had.

Neither form is common in this function in spoken English. Both are formal and typical of narrative style.² The following are authentic examples:

[J. P., as he was fondly referred to by those who knew him well, first came to this University as an instructor in pomology.] Later he *was to be* professor of plant physiology and plant physiologist in the Agriculture Experiment Station. (www)

[Lorena Rosalee Encinas was born on September 4, 1922, in Nogales, Arizona. (...)] Nearly two years later, she *would have* a little brother, named Louis Jesus, to whom she *would be* completely devoted. She *would protect* him all her life, even at the expense of her own freedom. (www)

Later he *was to be* famous and honoured through the Caribbean; he *was to be* a hero of the people. [But when I first met him he was still a struggling masseur.] (www)

[It was not Harriet Jacob's nature to give up without a fight.] Born into slavery, Harriet Jacobs *would thwart* repeated sexual advancements made by her master for years, then run away to the North. She *would later publish* an account of her anguished life in her autobiography, *Incidents in the Life of a Slave Girl*. (www)

9.6.7 There is a special use of *was to* and *was going to* in conditional *if*-clauses depending on a head clause in the past tense. The auxiliaries represent

2. This use of *would* is more common in Am. E. texts than in Br. E. ones.

the possible posterior actualization of the *if*-clause situation as a goal envisaged at some past orientation time. (See 7.11 for the description of a parallel use of *is to* and *is going to*.)

I knew I had to work hard if I {was to / was going to} keep my job.

The conditional clause here refers to a goal envisaged at some past orientation time. (In formal registers, *was to* is more likely than *was going to* and in informal registers *was going to* is more likely than *was to*). The following are some attested examples:

Tass news agency said Mr Aziz was told that if Iraq *was to* avoid the worst, it must now openly declare and show by its actions that it was pulling out and freeing hostages. (www)

[After making the decision to run she realized] there was a lot of work to do if she *was going to succeed* at being elected the County Surveyor. (www)

Mr Lee said that if China *was to* play a role in South-East Asia it would have to establish its business credibility. (www)

[She had nothing but the clothes on her back,] if she *was going to make it* in New York, she was going to need every bit of Providence that came her way. (www)

[Mam was frail and George, who was now her main support, moved his house from 40 Plasterton Gardens in Cardiff to a bungalow in King George V Drive, overlooking Heath Park, where he continues to live.] This was necessary if Mam *was to* continue the active life, which was the only kind she knew. [The stairs of the old house defeated her.] (www)

[The only problem was that they didn't have the lightbulbs, the truck to take them there or any of the other logistics required to make it happen] – and they needed to leave in 48 hours if they *were going to get* there on time! (www)

Sir Bert said on Tuesday that there would have to be a 'considerable improvement' if England *were to* win the European Championship in a year's time. (www)

9.6.8 From a tense-structural point of view, the past tense of futurish tense forms discussed in 9.6.1–6 resembles the conditional tense in that it expresses no temporal information other than that the bound situation time is T-posterior to a binding orientation time forming part of a past domain (i. e. a domain whose central orientation time is located in the past time-sphere – see 8.36). (The fact that *I was going to ring you* and *He was about to do something stupid* implicate nonactualization does not alter this: the speaker anyhow has the time of (potential) actualization in mind, and this time (= the situation time of the situation denoted by the infinitive phrase) is posterior to the binding orientation time in a past domain.) These forms expressing T-posteriority therefore do not express the actual W-relation between its situation time and t_0 . This W-relation can therefore be indicated by a time-specifying adverbial:

He told me (yesterday) that William {*would / was going to*} be there {later that day / now / tomorrow}.

D. The T-relation expressed by the conditional perfect tense

9.7 The conditional perfect tense

In its purely temporal (nonmodal) use, the conditional perfect tense expresses a **COMPLEX T-RELATION** in a past domain: it represents its situation time as anterior to an orientation time which is itself posterior to some orientation time in a past domain.

Bill promised that he *would have finished* by the end of the day.

The finishing is interpreted as W-anterior to the end of the day, which is W-posterior to the time when Bill made his promise. The conditional tense combines anteriority and posteriority in one two-part T-relation: the finishing is directly related to the promising, but by means of a complex T-relation. The point where the T-relation ‘bends’ is the end of the day. See Figure 9.4.

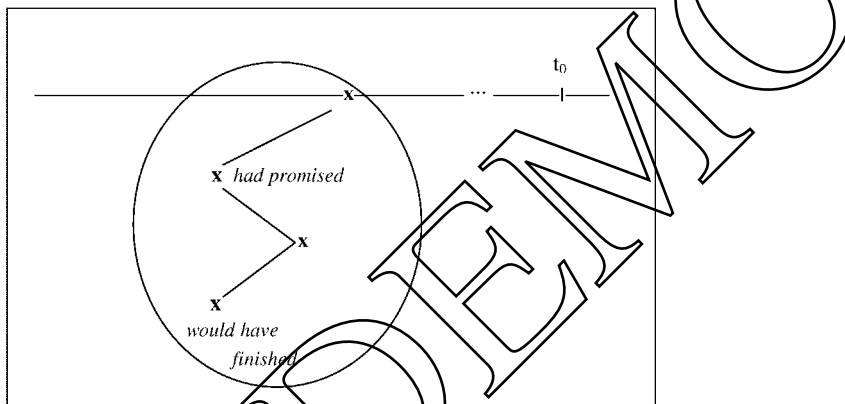

Figure 9.4. The tense structure of *Bill had promised that he would have finished (by the end of the day)*.

The following are similar to the above example:

[I knew that I should try and see the manager at 4 p.m. at the latest, because] at 5 p.m. he would have left. (*At 5 p.m. specifies the ‘bending point’ to which the manager’s leaving is anterior.*)

[I knew that the manager would no longer be available at 6 p.m. because] he *would have left* at 5 p.m. (*On the most plausible interpretation, at 5 p.m. specifies the situation time, i.e. the time of the manager’s leaving.*)

The manager *would have left* at 5 p.m. (*ambiguous: at 5 p.m. may specify either the situation time (= ‘5 p.m. would be the time when he left’) or the orientation*

time to which the situation time is anterior (= 'At 5 p.m. the manager would already have left'); in the later case the bending point is not made explicit in the sentence but must be retrieved from the context.)

[You've hardly done anything since yesterday.] I thought you *would have finished* by now. (www)

DEMO

II. Temporal relations in a pre-present domain

A pre-present domain can only be expanded if the pre-present situation can be re-interpreted as if it were a past situation. In subclauses this will generally prove to be impossible if the full situation of the head clause is interpreted as continuative and unusual if the situation time is interpreted as recent (i. e. close to t_0 , as in the ‘hot news’ use of the indefinite perfect).

If a pre-present domain is expanded (by relative tenses), it is always expanded as if it were a past domain. This means that we use the past perfect to express T-anteriority, the relative past tense to express T-simultaneity and the conditional tense (or the past tense of a ‘futurish form’ like *be going to*) to express T-posteriority.

9.8 The relevance of the W-interpretation of the present perfect clause

9.8.1 A pre-present domain is a temporal domain that is established by a present perfect tense form which locates its situation time in the pre-present zone of the present time-sphere. This situation time functions as central orientation time of the pre-present domain that is established. The pre-present zone, which is one of the four absolute zones, is a period conceived of as starting before t_0 and leading up to t_0 (without including t_0). The period in question may be an Adv-time (i. e. a period specified by a time-specifying adverbial like *since then*) or an unspecified mentally conceived period. As we have seen in 5.2, the semantics of the present perfect is: ‘The situation time is located in the pre-present’. However, the situation time can, according to context, be interpreted either as lying entirely before t_0 (in which case we get an ‘indefinite perfect interpretation’, e. g. *I have already met him*) or as filling the entire pre-present period (i. e. as leading up to t_0). In the former case (i. e. when the situation time lies entirely before t_0), the full situation is interpreted as also lying entirely before t_0 . In the latter case (i. e. when the situation time is co-extensive with the pre-present) there are two possibilities as to the W-relation between the situation time and the time of the full situation: (a) the two can coincide, in which case they fill the entire pre-present but do not include t_0 (= the ‘up-to-now reading’, e. g. *Where have you been?*), or (b) the time of the full situation may be interpreted as longer than the situation time, so that it includes t_0 (= the ‘continuative reading’, e. g. *He’s known that for years*).

There are thus three possibilities as to the W-location of the full situation relative to t_0 . For convenience we transfer the names of these three readings of

a sentence in the present perfect to the tense form itself and speak of the ‘indefinite perfect’, the ‘up-to-now perfect’ and the ‘continuative perfect’. However, it was stressed in 5.4.6 that these three labels actually refer to W-interpretations (of clauses) which are not due to the perfect tense alone.

In sum, we distinguish between three temporal W-interpretations of present perfect clauses, all of which fit in with the same tense structure, viz. ‘The pre-present zone contains the situation time’. (‘Contain’ can mean either ‘include’ or ‘coincide with’ – see 2.16.2 and 2.21.1.) When the situation time is included in the pre-present, it does not lead up to t_0 , and we get an indefinite interpretation. When the situation time is co-extensive with the pre-present, it does lead up to t_0 (without including it) and we get either an up-to-now reading or a continuative reading (depending on the nonverbal part of the clause or its context). Because of the fundamental difference between these temporal interpretations, the domains which they establish are not expanded in the same way. It is therefore necessary to treat the readings separately.

9.8.2 The following are the general conclusions we will arrive at below:

- (a) If a pre-present domain is expanded (by relative tenses), it is always expanded as if it were a past domain. This means that we use the past perfect to express T-anteriority, the relative past tense to express T-simultaneity and the conditional tense (or the past tense of a ‘futurish form’ like *be going to*) to express T-posteriority.
- (b) A pre-present domain can only be expanded if the pre-present situation can be re-interpreted as if it were a past situation. In subclauses this will generally prove to be impossible if the full situation of the head clause is interpreted as continuative and unusual if the situation time is interpreted as recent (i. e. close to t_0 , as in the ‘hot news’ – see 5.14 – use of the indefinite perfect).

9.9 T-relations in a domain established by an indefinite perfect

A domain established by an indefinite perfect can be expanded if the situation referred to is not recent, i. e. if the ‘bygone-ness’ of the situation is more salient than its closeness to t_0 . When an indefinite perfect domain is expanded, it is treated exactly like a past domain. Each situation time that is inserted into this ‘pseudo-past’ domain functions as the central orientation time of a ‘pseudo-past subdomain’. For example: *Have you ever told anyone that you felt guilty when you had kissed Gordon?* (*Have told* establishes a pre-present domain, which is treated as a pseudo-past domain. *Felt* expresses

T-simultaneity with the situation time of *have told* and establishes a pseudo-past subdomain. *Had kissed* expresses T-anteriority in that subdomain.)

9.9.1 As noted in 4.7.3, an indefinite present perfect is normally only used to introduce a ‘bygone’ situation into the discourse (i. e. to establish a domain in the pre-present zone), not to go on speaking about it after this has happened. In order to do that we normally switch to the past tense. When this switch happens in a subclause, as in *I have occasionally thought that I was going mad*, we notice a shift of perspective: the pre-present domain is expanded as if it were a past domain. As a matter of fact, this is the only way in which a pre-present domain can be expanded: the tenses used to expand a pre-present domain are always the same as are used to express T-relations in a past domain. In other words, the central orientation time of an expanded pre-present domain is treated as if it were the central orientation time of a past domain. This is further illustrated by the following example:

On one occasion I’ve even drawn the curtains across a window through which a journalist *was peeping*.

The present perfect in the head clause locates its situation time (which is taken to be the time of the full situation – see 5.4.1) at some indefinite time within the pre-present zone. (As is criterial of an indefinite perfect reading, the situation time is interpreted as lying completely before *to*.) The relative clause introduces another situation time into the pre-present domain, but in doing so creates a ‘pseudo-past subdomain’. In other words, there is a ‘shift of temporal perspective’ (see 8.22): the pre-present domain is treated as if it were a past one. This means that the tense used to express T-simultaneity in the relative clause is the relative past tense. The tense structure of the above example can therefore be represented as in Figure 9.5. (The vertical dashed line in this figure represents the shift of temporal perspective; the dotted line indicates the **PSEUDO-PAST SUBDOMAIN**.)

9.9.2 It is very important to remember in any discussion about the expansion of pre-present domains that a pre-present domain established by a present perfect does not always have to be expanded and in fact often cannot be – see 9.9.6 below. The only point made in 9.9.1, therefore, is that *if* a pre-present domain is expanded, it is expanded as if it were a past domain.

9.9.3 The following are further examples illustrating the shift of temporal perspective which takes place when an indefinite pre-present domain is expanded. (As noted before, ‘indefinite pre-present domain’ is short for ‘pre-

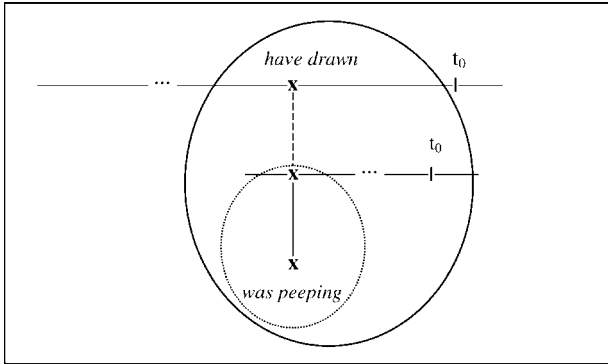

Figure 9.5. The tense structure of *On one occasion I've even drawn the curtains across a window through which a journalist was peeping.*

present temporal domain whose central orientation time is the situation time of a present perfect tense form in a clause receiving an indefinite interpretation'.)

Has it happened that your proposals *were rejected* even though you *knew* you *were* right? (*The three preterite forms express T-simultaneity.*)

Has he ever promised that he *would help* you? (*T-posteriority*)

Once or twice I have torn up a manuscript on which I *had been working* for months [because I was dissatisfied with it]. (*T-anteriority*)

In the past two years I've been told at least a dozen times that he *would soon have left* [but he is still here]. (*The conditional perfect expresses a 'complex relation' combining T-posteriority and T-anteriority.*)

When have you most felt that you *had lost* touch with God? (www) (*T-anteriority*)

In many of the examples both clauses refer to repetitive hypersituations consisting of a number of subsituations. In such cases, each subsituation of the hypersituation of the subclause is interpreted as W-simultaneous with one of the subsituations forming the hypersituation referred to in the head clause. Since the pre-present domain is expanded as if it were a past domain, the subclause uses the relative past tense to express this W-simultaneity as T-simultaneity:

His lawyer has visited him in prison as often as he *wanted* to.

I have sometimes rung him up when I *was feeling* lonely.

[Long interested in ragtime,] he has often felt frustrated when his limited technique *prevented* him from playing the music as he *heard* it in his inner ear. (www)

[Even though it is a malleable material,] I have often had it break while I *was bending* it for its intended use: reinforcement in concrete work. (www)

The following examples are similar, except for the fact that the tense of the subclause expresses T-anteriority or T-posteriority:

But all in all, I have sometimes chosen to ride home when my taillight *had quit*, [equipped only with a large amber rear reflector and pedal reflectors.] (www)

Pepe has often driven before when he *had forgotten* to take his medicine [and there has been no problem as long as the drive is short.] (www)

Fiorina has never assumed that HP's size *would guarantee* its position in the market place. [She has pushed relentlessly for new and different products.] (www)

Bank of America, which hasn't made a major acquisition in four years, has frequently pushed aside speculation that it *would* soon *buy* another company. (www)

9.9.4 A pre-present domain established by an indefinite perfect is not normally expanded as if it were a past domain if the pre-present situation receives a recency interpretation. Thus in the following sentence, which is used to express 'hot news', the pre-present domain cannot be expanded:

[Listen to this!] John has just said that he {*was* afraid of mice / *had seen* a ghost / *would become* famous}.

The normal interpretation of *was* [*afraid*] is not as a relative past tense form expressing T-simultaneity to the head clause situation time, but as an absolute preterite referring to a situation which is interpreted as W-anterior to the head clause situation. *Had seen* is a relative tense, but it is unlikely to be interpreted as expressing T-anteriority to the situation time of *has said*. Rather, *had said* is naturally interpreted as expressing T-anteriority to an unspecified orientation time that is W-anterior to the situation time of *has said*. As to *would become*, this can hardly be interpreted as expressing T-posteriority to the head clause situation time or to an unspecified orientation time and so is not readily interpretable.

By contrast, in the following examples the head clause does not receive a recency interpretation, so that the pre-present domain is expanded (as if it were a past domain):

Never before has John declared that he {*was* afraid of mice / *had seen* a ghost / *would become* famous}. (*The italicized forms are relative tense forms expressing T-simultaneity, T-anteriority and T-posteriority respectively.*)

When have you most felt that you *had lost* touch with God? (www) (*T-anteriority*)

When have you felt like your entire existence *was swallowed* by something you either *looked into* or *listened to*? (www) (*T-simultaneity*)

In sum, a pre-present domain established by an indefinite perfect can only be expanded (as if it were a past domain) if there is not a hot news reading or another kind of recency interpretation – see 9.9.8 below for more details. The reading that best allows it is the 'experiential' reading (see 5.13). This is clear from the above examples and from a comparison of the following sentences:

[Have you heard the news?] Senator Harris *has promised* that he {will / *would} help us! (*indefinite perfect; 'hot news' reading*)

Has he ever *promised* that he {will / would} help you? (*indefinite perfect; experiential reading*)

[I seem to remember that] she *has told* me once that she {[?]has / had} quarrelled with her husband. (*indefinite perfect; experiential reading*) (*Compare with She has just told me that she {has / [?]had} quarrelled with her husband, where the word just makes the use of the past perfect less likely.*)

9.9.5 When a pre-present domain is expanded, the speaker relates the situation time of the subclause to the pre-present situation time of the head clause. It follows that no T-relation is expressed between the bound situation time and t_0 . Because of this, there are in principle several possible interpretations as far as the W-relation between the bound situation time and t_0 is concerned:

Once or twice I have told her what I *was looking for*. (*The bound situation time is interpreted as W-anterior to t_0 .*)

Has he ever promised that he *would be* here now? (*The bound situation time is interpreted as W-simultaneous with t_0 , while it is represented as T-posterior to the situation time of the head-clause.*)

He has never promised that he *would give* us everything now, [but he will provide for our daily needs and more than that too.] (www) (*idem*)

Has Beckham ever categorically stated that he *would transfer* next year? (*The bound situation time is interpreted as W-posterior to t_0 .*)

Has the landlord ever promised that he *would have had* the roof repaired by Christmas day? (*The bound situation time is W-anterior to an orientation time (Christmas day) which is T-posterior to another orientation time (the time of promising) which is T-anterior to t_0 . It follows that the W-relation between the bound situation time and t_0 can vary according to the temporal relation between t_0 and Christmas day: the bound situation time may be interpreted as W-anterior, W-simultaneous, or W-posterior to t_0 .)*

[Then one day he found himself in a "home" where several "little people" were institutionalized. "There was nothing wrong with them," says Rappaport. "They weren't ill. They were there just because they were little. It had a chilling effect on me. I've never forgotten it."] Never in his 35 years *has* anyone ever *suggested* that Rappaport *would end* like the lost people of his (...) tale, [shunted away because of their dwarfism.] (www)

9.9.6 Instead of expanding the pre-present domain, the tense form of the subclause may under certain conditions also 'shift the domain', i. e. use an absolute tense to create a new temporal domain in one of the four absolute time-zones.

When the new temporal domain is also a pre-present one, the two pre-present domains are often interpreted as W-simultaneous with each other. In

that case there is no difference of temporal interpretation between the use of the present perfect in the subclause and the use of the relative past tense (which expresses T-simultaneity):

When have you most felt that you *have lost* touch with God? (*Have lost* is interpreted as an indefinite perfect creating a pre-present domain which is interpreted as W-simultaneous with the pre-present domain established by *have felt*. The claim that the simultaneity relation between *have felt* and *have lost* is a W-simultaneity relation is demonstrated by the fact that it is not a relation of strict coincidence: the situation of feeling may be properly included in the state of having lost touch.)

[“Money is something to everybody.” – “Is it?”] When have you found that I have taken any account of it? (= ‘When have you found me to be taking any account of it?’ *Have taken* is an absolute tense form, but its situation time is likely to be interpreted as W-simultaneous with that of *have found*.)

I’ve sometimes called him up when I {*felt* / *have felt*} lonely. (*felt* = temporal subordination; *have felt* = shift of domain)

My pets have never failed me when I {*needed* / *have needed*} a friend. (*similar*)

I have often wanted to ask him for advice, to have him by my side when I *have struggled*, or when I *needed* a hug. (www) (*The fact that the speaker chooses freely between the present perfect and the past tense indicates that he does not interpret them differently.*)

Of course, there are also cases in which, for pragmatic reasons, the pre-present domain established by the subclause is not interpreted as W-simultaneous with that established by the head clause:

The doctor has already confirmed that Bill *has sprained* his ankle. (*The situation time of has sprained is interpreted as W-anterior to that of has confirmed.*)

When *have* you felt that others *have taken* advantage of your good nature on the job? [What did you do about the situation?] (www) (*Have taken* is an absolute tense form; its situation time is interpreted as W-anterior to that of *have felt*.)

The interpretation is certainly not in terms of W-simultaneity if the subclause shifts the domain to another absolute time-zone:

Have you ever considered the possibility that Kennedy *was murdered* by the FBI? (*absolute past tense, establishing a past domain which is interpreted as W-anterior to the pre-present domain established by have considered*)

I have always been told that Keats *died* in Italy. (*idem*)

When has Bush ever said that he *will use* nuclear pre-emption? (www) (*W-posteriority*)

At no time has he ever denied that he *will be* a part of Damian’s life. (www) (*idem*)

No one has ever seriously considered that Secretariat’s world record for the mile and a half distance of the Belmont Stakes *is* in danger, nor has anyone ever considered

that it *will be* in the future. (www) (*Is* and *will be* establish a present domain and a post-present domain, respectively.)

I haven't met anybody yet who {*was* / *is*} not interested in money. (There is a clear difference of meaning between the two tense forms. If the speaker uses *was*, which expresses T-simultaneity in the domain established by *have met*, he refers to anybody he has ever met, whether they are still living or dead. By using *is* he limits the reference to those that are still living at t_0 , i. e. to those who can still be interested in money at t_0 .)

Sheila has often told me that she {*loved* / *loves*} me. (There is a meaning difference, because the situation time of *loved* may not include t_0 whereas the situation time of *loves* coincides with t_0 . The use of *loved* therefore suggests that the speaker has no confidence at all that Sheila still does love him.)

Because of the difference in meaning between the relative past tense (expressing T-simultaneity with the central orientation time of the pre-present domain) and the present tense (locating the situation time of the subclause at t_0), there are many cases in which only one of the two is quite suitable:

It *has* often *struck* me when I'm being *quizzed* (before people know my reasons) [that however bad it feels for me, it would be infinitely worse if I had a drink.] (www) (*When I was being quizzed* would be possible but highly unlikely: the speaker is talking about something that forms part of his current life, not about individual past situations.)

Until now, this has often meant that a student – to be bullied digitally – *needed* to be sitting at a computer connected to high-speed or a telephone line. (www) (*Needs* is probably unacceptable here.)

The credibility of women with disabilities *has* often *been questioned* when they report sexual assault, [particularly in the case of ...] (*Reported* is not impossible, but it would provoke a strong shift of temporal focus: it would put more focus on the individual past occasions rather than just characterizing the sort of situation in which the women's credibility is questioned.)

It *has* often *been said* that they *were* too similar and destined to become enemies. (*Are* could not replace *were* without a drastic change of temporal interpretation, because *were* and *are* refer to time-zones that are incompatible with each other – THEN versus NOW.)

9.9.7 In repetitive sentences like the following, the subclause uses an absolute present tense rather than a present perfect establishing a W-simultaneous domain:

The result has often been that, after escaping the dangers of the widest seas, and the most violent storms, they *wreck* their ship in harbour. (www)

The result has often been that health care providers *opt* for the cheapest patients, [those who are not sick at all or suffering only from minor ailments.] (www)

The result has sometimes been that we *have* all the numbers, [but little indication of what those numbers are trying to tell us or why.] (www)

[We sometimes include “feed the band” in our terms.] This has sometimes meant that we *get* a cheese roll each. [We’ve only twice been included in the champagne.] (www)

The last example seems to be a blending of (the more or less generic sentence) *This sometimes means that we get a cheese roll each* and *This has sometimes meant that we have got a cheese roll each*. (In 9.9.11 we will observe something similar in connection with sentences like *But whenever I’ve looked at the job board the job asks for experience*, which seems to be a blending of *Whenever I’ve looked at the job board the job has asked for experience* and *Whenever I look at the job board the job asks for experience*.) The speaker wants to talk at the same time about what he believes is habitually the case and what has habitually been the case and is thus evidence for his assertion about the habitual present. In other words, one clause locates its situation in the pre-present and the other locates its situation in the present, and the listener is expected to make sense of these temporally unconnected T-locations, using the repetitiveness of the first clause as a guide to make the double interpretation outlined above.

It should be noted that a present tense form, which locates its situation at t_0 , is only possible as an alternative to a present perfect (which creates a pre-present domain that is interpreted as W-simultaneous with the pre-present domain of the head clause). In cases like the following, where a contrast is expressed between the present and the past, only the relative past tense (expressing T-simultaneity in the head clause domain) can be used:

Our quick response to immediate needs and crises has sometimes meant that we *didn’t have*, or make, the time to take advantage of the technologies that can help our work. [Today, we’re using computers, the Internet, and the media both to get our message out and to organize our work internally.] (www)

9.9.8 As noted in 9.9.4, a shift of domain is much more likely than the use of a relative tense when the indefinite perfect receives a recency reading. Compare the following:

[Approach strangers with a meaningful question rather than something as mundane as “How are you doing?”.] Questions such as “Have you found what you *are looking for*?” will start your conversation off better. (www) (*The past tense form were looking could be used here, but not as a relative past tense expressing T-simultaneity in the pre-present domain established by have found. It would be interpreted as establishing a past domain of its own, interpreted as W-anterior to the pre-present domain, and would therefore imply that the addressee is no longer looking for whatever it was that he was looking for.*)

[Of all the times that Bill has claimed to have sprained his ankle,] the doctor has only once confirmed that he {*had* / **has*} indeed *sprained* his ankle. (*no recency interpretation*)

[Listen to this!] The teacher has just said that Bill {has / #had} sprained his ankle. (Out of context, *had sprained* is unacceptable, because it cannot be interpreted as a T-anteriority form expanding the domain. This follows from the fact that *has just said* can only receive a recency (more specifically, 'hot news') interpretation. (However, *had sprained* is all right if the context provides a past orientation time which is W-anterior to the teacher's confirmation and to which the spraining of the ankle is represented as T-anterior.)

Figure 9.6 represents the tense structure of the last example (with *has sprained*).

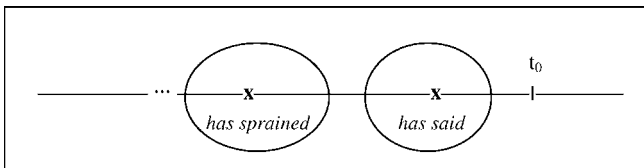

Figure 9.6. The tense structure of *The teacher has just said that Bill has sprained his ankle*.

When a subclause depending on a head clause with an indefinite present perfect form could in principle use a relative tense but uses an absolute tense form (which creates a new domain and thus effects a shift of domain), it means that the speaker wishes to represent a W-relation of some kind (temporal and/or logical) between the subclause situation and t_0 . For example:

The janitor has just said that he *has locked* the front door. (The subclause uses an indefinite perfect; the W-relation between its situation and the present is of a logical rather than temporal nature: reporting the janitor's locking the front door in the present perfect implicates current relevance, more particularly resultativeness: the front door is locked now.)

I haven't met anybody yet who *is not interested* in money. (As noted earlier in this section, if the speaker used *was*, he would be referring to anybody he has ever met, whether they are still living or dead. By using *is* he limits the reference to those that are still living, i. e. to those who can still be interested in money at t_0 .)

There *have been* times in my life when I *felt* depressed, and then I *have found* that good friends *are* invaluable. (This example illustrates both temporal subordination and domain shifting. The form *have been* establishes a pre-present domain and the preterite form *felt* expresses T-simultaneity within this domain. Then there is a shift to a new pre-present domain, established by *have found*, which, because of *then*, is interpreted as W-simultaneous with the domain established by *have been*. This domain is not further expanded, for *are*, which is interpreted generically, again shifts the domain, this time to the present zone.)

It goes without saying that when the tense in the subclause shifts the domain (i. e. creates a temporal domain of its own), no T-relation is expressed between

the situation time of the subclause and the situation time of the head clause: the situation time of the subclause is directly related to t_0 . This is in keeping with the principle that only past time-sphere tenses can be used to express T-relations in a domain established by an indefinite present perfect.

9.9.9 When the head clause contains *just*, the situation referred to is automatically recent. Because of this, temporal subordination is less likely in the subclause. However, the influence of recency may conflict with factors promoting temporal subordination. For example, in represented speech the speaker may prefer to apply temporal subordination because he does not want to assume responsibility for what he reports, i. e. because he wants the subclause to be interpreted ‘opaquely’, i. e. from the point of view of the reporting speaker, rather than ‘transparently’, i. e. from his own point of view (see 8.24.3):

“The army has just said they *would release* Daw Aung San Suu Kyi, [but we do not know when,” he said, adding that he had no specific information about the release.] (www)

Pyeongyang, however, has just said it *would not be going back* to multilateral negotiations on its nuclear program, stating that it wants to boost its nuclear potential in response to a US “hostile” attitude. (www)

In the following example *would not do* could not be replaced by *will not do* because the ‘it’ in question has already been done at t_0 .

[“Therefore, this Board will not make a finding about the adequacy of nearby intersections *or other elements* related to the adequacy of public facilities.” (Emphasis added.) Nevertheless,] it immediately did that which it has just said it *would not do*, [by bootstrapping specific traffic safety matters under the general provisions of the Code.] (www)

In the following example, *would lend* cannot be replaced with *will lend* because the context suggests that there may not be any lending in the post-present:

[Not only do I feel like an unemployed wastrel (which I’m not really, my first shift at Sports Soccer is on Wednesday), but I also feel like a money-driven little bitch.] My dad (Jim) has just said he *would lend* me some money for rent [because he has offered a million times, but then after saying it was fine he said “but then at Christmas I sent you the money for a train ticket to come and see us and you didn’t.”] (www)

However, there are also examples in which the conditional tense form could easily be replaced by the future tense:

President Mubarek of Egypt has just said he *would allow* opposition candidates to run in their upcoming election. (www)

GM has just said it *would add* a 7.5-liter V12 to its powertrain lineup. (www)

[In a less than clever vein, I left the hose connected to the faucet. Yes, yes, I know. There’s a little warning on the flange that says “Remove hose during freezing

weather or pipe may burst ...". I've learned my lesson and] the insurance company guy has just said they *would cover* everything, including a stay in a nice hotel. [Sadly, you will be paying for my stupidity, by ever so slightly increased rates.] (www)

[The heat just got turned up a notch.] Marissa from The Hotrod Store has just said she *would be* there on Saturday to race so grudge matches. (www)

Kodak has just said they *would be issuing* a new version in the fall. (www)

The use of the conditional tense with *just* is no doubt related to the fact that many (especially Am. E.) speakers consider *just* as possibly referring to a past time, witness the fact that they use 'X just *said* that ...' next to (or instead of) 'X *has just said* that ...'.

9.9.10 In 9.11 we will see that a pre-present domain established by a present perfect clause receiving a continuative interpretation cannot normally be expanded:

Ever since I was a soldier I have known that I {*am* / **was*} reluctant to follow orders that I {*do* / **did*} not find sensible.

A similar restriction applies when the pre-present domain is established by an indefinite perfect which is interpreted inchoatively, so that the focus is on the continuative state resulting from it (see 5.26.2):

I have been suspended from work while investigations into alleged misconduct *are taking* place. [What should I do?] (www) (*are taking* cannot be replaced with *were taking*)

But in France, four men sent back from Cuba have been remanded in custody while they *are investigated* for possible links to terrorist organisations. (www) (**were investigated*)

9.9.11 Up to now we have only considered examples in which the head clause establishes a pre-present domain and in which the subclause either expands this domain (as if it were a past domain) or shifts the domain. In this subsection we will discuss examples in which it is the other way round: the pre-present domain is established by the subclause. In these examples the subclause typically refers to a repetitive hypersituation. The head clause typically refers to a homogeneous background situation and shifts the domain by using the absolute past tense, the present perfect or the present tense:

Everything I've ever *done was* wrong.

Every time I've *met* him, he's *been* so polite and a really nice person to talk to. (www)

Every time we've *tried* [this restaurant] it's either closed or the wait *is* too long. (www)

Let us have a closer look at these three possibilities of tense choice.

- (a) The past tense in examples like *Everything I've ever done was wrong* is an absolute past tense creating a W-simultaneous domain. (This is in keeping with the fact that this past tense can be 'backshifted' in past represented speech: *He said that everything he'd ever done had been wrong* – see 8.25 for this 'indirect speech test'). The following further illustrate this possibility:

Whenever I've been there, I *felt* like I was wandering through a friend's house looking at their art collection. (www) (*This resembles I've been there several times and each time I felt like I was wandering through a friend's house looking at their art collection, which itself resembles The president has had talks with the protesters. She told them that their cause was a just one in that the present perfect is used to introduce a situation and the past tense is used to give more information about it* – see 8.25.3.)

Every time I've met him he *was* quite the gentleman. (www)

Since then, whenever I've seen him, he *was* always the same loving, friendly person always giving that grin and a hug. (www)

[I've never had a serious problem though, but] whenever I've been there, I *was* cool to them and they *were* cool to me. (www)

Every time I've seen him he *was* alone.

In such examples the subclause establishing the pre-present domain is typically a clause referring to a repetitive hypersituation and functioning as (or like) a temporal clause. This clause always precedes the head clause. It is only because the pre-present domain is established first that the domain established by the past tense in the head clause can be interpreted as W-simultaneous with the pre-present domain.

- (b) When the head clause (supporting the subclause which is in the present perfect and refers to a repetitive hypersituation) uses the present tense, it also receives a repetitive interpretation and therefore establishes a number of W-simultaneous present domains:

But whenever I've looked at the job board the job *asks* for experience. (www) (*Has asked is also possible.*)

This sentence seems to be a blending of *Whenever I've looked at the job board the job has asked for experience* and *Whenever I look at the job board the job asks for experience*. (Not surprisingly) the speaker wants to talk at the same time about what he believes is habitually the case and what has habitually been the case and is thus evidence for his assertion about the habitual present. In other words, the head clause locates its situation in the present and the subclause locates its situation in the pre-present, and the listener is expected to

make sense of these temporally unconnected T-locations, using the repetitive adverbial as a guide to make the double interpretation.

The following are similar:

And every time I've met him he *impresses* me more – [he is so unassuming and modest for one who has accomplished so much]. (www)

Whenever I've been really upset and crying, most of my cats *look* startled and at a loss, [because they're not really used to it]. (www)

[The food here is always fabulous,] everything I've ever tried *is* always superbly spiced and flavoured and sooo fresh! (www)

- (c) When the head clause (supporting the subclause which is in the present perfect and refers to a repetitive hypersituation) uses the present perfect, it establishes a pre-present domain of its own and also receives a repetitive interpretation. In that case there are in principle two possible readings. The first is that the two pre-present domains are W-simultaneous with each other, in the sense that each subsituation constituting the repetitive hypersituation of the head clause is W-simultaneous with a subsituation constituting the repetitive hypersituation of the subclause).

Whenever I've been in trouble, Tim *has helped* me out.

Every time I've asked for a salary increase my boss *has threatened* to fire me.

Every time I've met him, he's *been* so polite and a really nice person to talk to. (www)

The second possible reading is that the head clause domain is interpreted as W-anterior to the subclause domain. Consider:

Every time I've met him he's *been* drunk.

Whenever I've seen John he's *been* ill.

How many times *has* John *been* ill when you *have seen* him?

In these examples the two clauses establish pre-present domains which may be interpreted as W-simultaneous with each other. However, there is also another possible interpretation, in which each of the situation times of the subsituations making up the repetitive hypersituation referred to in the temporal subclause is treated as if it were t_0 and in which the situation times implied by the head clause lie in the 'pseudo-pre-present' periods leading up to these 'pseudo- t_0 's'.³ For example, *Whenever I've seen John he has been ill* can be interpreted as meaning 'Every time I have seen John he had been ill in the period leading up to my seeing him'. This interpretation can be brought out by the addition of *just* to the head clause: *Whenever I've seen John he has just been ill*.

3. This is a case of shift of temporal perspective which we have not yet referred to.

In sum, it is possible for the repetitive time clause to use a present perfect implying a number of 'pseudo-pre-present' periods and for the repetitive head clause to represent the times of the subsituations referred to as holding within or throughout these pseudo-pre-present periods. This possibility is in principle available irrespective of the W-reading (i. e. indefinite, continuative or up-to-now) which the head clause in the present perfect receives. Thus, the example *Has John been ill when you have seen him?* can be altered in various ways which each bring out one of the three interpretations:

Has John ever been ill for some time when you have seen him? (*On the most obvious interpretation of the head clause, the sentence is interpreted as: 'You have seen John a number of times. Has it ever happened that he had been ill for some time (and still was) then?'. This means that each illness was continuing into an orientation time in the pre-present period.*)

Has John ever just been ill when you have seen him? (*indefinite interpretation of has John been ill: 'You have seen John a number of times. Has it ever happened that he had been ill just before you saw him (but no longer was (when you saw him)?'*)

On each occasion when you have seen John, how many times has he been ill since your previous visit? (*quantificational constitution interpretation of has John been ill: 'You have seen John a number of times. On each of those occasions, how many times had he been ill in the period following your previous visit and leading up your seeing him?'*)

As a further example, consider the following:

Every time I've seen Gilda in the last few weeks she has been playing football.

This sentence presupposes that I have seen Gilda several times in the past two weeks and says that on each of these occasions it would have been true (at the time) to say 'Gilda has been playing football' or to say 'Gilda is playing football'. In other words, the sentence is ambiguous between (a) 'At the time of my seeing Gilda it has each time been true to say that she has ('just' or otherwise) been playing football', and (b) 'At the time of my seeing Gilda it has each time been true to say that she was playing football'.⁴ The form *has been playing* in the former of these paraphrases receives the same interpretation as it does in isolation, except for the fact that the relevant pre-present period is not a time span leading up to t_0 but a time span reaching up to the times referred to by *every time I've seen Gilda* (which are interpreted as being indefinite times in a period up to t_0). Similarly, the form *is playing* in the second

4. Not surprisingly, the two readings above can also be expressed by sentences in which there is no shift of domain but the pre-present domain established by the Adv-time-clause is expanded (as if it were a past domain – see 9.9) by the tense forms in the head clause:

Every time I have seen Gilda she *had just been playing* football. (*T-anteriority*)

Every time I have met Gilda she *was playing* football. (*T-simultaneity*)

paraphrase locates its situation time at the various pseudo-present times in the period up to now rather than at the real t_0 .

Sentences like this differ from nonrepetitive indefinite perfect sentences in that they involve an intermediate type of ‘BASIC ORIENTATION TIME’ (see 10.4.1)⁵ – that is, an intermediate orientation time functioning as if it were t_0 – in their temporal structure. Whereas *I have seen Gilda* locates its situation time in a period leading up to t_0 , *every time I have seen Gilda* implies that there are a number of situation times in a period leading up to an (each time different) ‘basic orientation time’ and that the various basic orientation times are themselves indefinite intervals in an implicit period up to t_0 .⁶

Needless to say, the present perfect cannot realize the above kind of temporal schema in a nonrepetitive sentence. *When I have seen John, he has been ill* is only grammatical if *when* means ‘whenever’ or ‘every time that’. If *when* is to be read as ‘on the particular occasion when’, the sentence that must be used instead is *When I saw John, he was ill* or *When I saw John, he had been ill (for some time)*.

9.10 T-relations on an up-to-now reading of the head clause

If the pre-present domain is established by an up-to-now perfect (in which case the situation time fills the entire pre-present but does not include t_0), there are in principle two possibilities in the subclause: temporal subordination (involving a shift of temporal perspective to the past zone) or a shift of domain. The former possibility can only occur when the speaker can discern enough ‘bygone-ness’ in the up-to-now situation expressed in the head clause to expand the pre-present domain as if it were a past domain. The latter possibility occurs when the up-to-now situation is given a recency interpretation.

5. In 10.4.1, ‘basic orientation time’ is defined as follows: “The basic orientation time (represented as ‘orientation time₁’) is that orientation time in the structure of the tense from which the temporal relations expressed by the tense begin to be computed. In most cases orientation time₁ is t_0 , but there are cases in which it is a post-present binding orientation time (i. e. a pseudo- t_0).”

6. The use of an intermediate orientation time functioning as if it were t_0 is also exemplified by present perfect sentences of a different kind:

He has been going to invite me for months (but he has not done so yet).

Here again the implication is that there have been several occasions in the pre-present when a proposition was applicable whose default interpretation is that it is applicable at t_0 , viz. the tensed proposition ‘He is going to invite me’. That is, the sentence is interpreted as ‘For months he has been intending to invite me.’

9.10.1 On an up-to-now reading the terminal point of the full situation lies close to t_0 . This means that an up-to-now reading can easily be treated as a recency reading, in which case the pre-present domain established by the head clause is not expanded (as if it were a past domain) but the subclause shifts the domain (i. e. establishes a new domain). On the other hand, expanding an up-to-now pre-present domain is also possible provided one can discern enough ‘pastness’ (‘bygone-ness’) in the up-to-now situation to treat the pre-present domain as if it were a past one. This means that in many cases both a shift of domain and temporal subordination are possible in the subclause. (However, restrictions may be imposed by the type of subclause or by pragmatic factors.)

9.10.2 In complement clauses there is generally a slight preference for shifting the domain if the head clause situation is not a repetitive hypersituation. However, temporal subordination is also grammatical:

[You want to know what I’ve just been doing?] I’ve been teaching your son how he {*can / could*} open a lock with a hairpin.”

["At last you're back. What have you been doing?"] – “I’ve been explaining to your children why you {*have / had*} forbidden them to play in the park.”

["Ah, there you are. What have you been doing?"] – “I’ve been telling your children that they {*will / would*} have to clean the kitchen tomorrow.”

9.10.3 When the pre-present situation is repetitive (and receives an up-to-now reading) both temporal subordination (i. e. expanding the domain as if it were a past one) and the use of an absolute tense (shifting the domain) are in principle equally possible in a complement clause. This is because some of the subsituations of the repetitive hypersituation are divorced from t_0 while the last one is not: the former can be treated as if they were past situations, whereas the last subsituation is treated as recent.

If the first option is chosen (i. e. the subclause is temporally subordinated), the speaker is primarily concerned with the non-recent subsituations. In most of the examples that we have found, temporal subordination is actually obligatory because (as is clear from the context) it would be false to represent the subclause situation as actualizing at t_0 :

I’ve been telling myself that I *wasn’t* ready yet, [but honestly I’ve been afraid to fail if I even started trying!] (www) (*Am not will not be used because the implication would be that I AM* actually ready.)

[Homecoming isn’t just for queens anymore. Eight young men are vying for the noble title of homecoming king, an honor that has never before been bestowed in Dade County.] “For the last three years the girls and the boys on student council have been saying that it *wasn’t* fair, [that there should be boys too,” said Donna Street, a coordinator of the homecoming committee. “When Mr. Hall came it was one of the things they asked.” New principal Fred Hall granted the students’ wish and a homecoming committee was formed.] (www) (*Isn’t fair cannot be used because the unfair situation no longer holds at t_0 .*)

[I caught up with Roger Penske track-side at the Chicago Speedway one week after the announced merger agreement of Detroit Diesel and a subsidiary of Daimler Chrysler AG. “What changed?” I asked. “We’ve gone back and forth on this and I’ve been saying that I *wasn’t* interested,” [replied Penske. “But at the end of the day, I looked at the overall perspective and all the consolidations that are going on.”] (www)

["You don't think it's on the small side?" — "It looks fine to me."] — "I've been thinking lately it *was* rather small." (CP)

["Prime Minister, you've been arguing against these cuts for many months now. When did you change your mind?" — "I guess I came to the conclusion a week or so ago after a lot of thought and listening to a lot of people that I'd plainly made a mistake as far as the level of sensitivity and concern is.] I know that I've been saying that it *wasn't* necessary, [I accept that and I'm not going to try and deny what I've previously said."] (www)

In the following examples, in which the subclause expresses T-posteriority, temporal subordination is again the only option because the subclause situation cannot be truly represented as T-anterior or T-posterior to t_0 :

Since November I have been thinking that I *had used up* all my vacation time. [Today I found out I still have SEVEN days left.] (www) (The assertion I have used up all my vacation time is false at t_0 .)

[I thought that I had sent it out but instead I had hit 'postpone'.] This whole time I have been thinking that I *had posted* to the listserve with plenty of time. (www)

[New York Yankees owner George Steinbrenner said Thursday that efforts to block the city from building a baseball stadium in Manhattan may force him to move the team out of New York. In response to Steinbrenner's accusations, Vallone accused the Yankees owner of meddling in the city's budget process.] (...) "George Steinbrenner has been saying that he *wasn't going to talk* about the future of Yankee Stadium until after the season was over," Vallone said. (www) (The assertion I'm not going to talk about the future of Yankee Stadium until after the season is over would be false at t_0 .)

[Representative Jo Ann Emerson recently announced Dec. 13 as the day traffic is anticipated to cross the new Bill Emerson Memorial Bridge. "We couldn't be more excited about this," said MoDOT District Engineer Scott Meyer.] "We've been telling the public the bridge *would be opened* by the end of the year [and we are very pleased to finally have an anticipated date for the bridge completion.]" (www)

In sum, if the subclause (depending on a head clause using an 'up-to-now present perfect' and describing a repetitive hypersituation) is temporally subordinated, the speaker is primarily (or exclusively) concerned with the subsituations that are past with respect to t_0 . If that is not the case, he will normally shift the domain to another time-zone rather than apply temporal subordination:

We've been telling the public the bridge *will be opened* by the end of the year [but they want a precise date].

Naturally, the more recent the subsituations are, the less likely they are to be treated as past. This explains that when the head clause contains *just*, the complement clause preferably shifts the domain:

I've just been telling him that he {is doing / has been doing / will do} well to stay a bachelor.

He has just been telling us that he {*doesn't like* / #*hasn't liked* / ²*didn't like*} mushrooms. (*The reference in the subclause is to a permanent habit, which still exists at t₀. The use of hasn't liked is not suitable to express this meaning because hasn't liked is naturally interpreted as an indefinite perfect, i. e. it yields an interpretation in which 'his' not liking mushrooms is represented as completely over at t₀. Didn't like is not very acceptable as a relative past tense form because of the recency reading induced by just.)*

9.10.4 In subclauses other than complement clauses, the same two possibilities – temporal subordination versus shift of domain – are in principle available, but here too everything depends on the degree of 'pastness' that the speaker can attribute to (part of) the up-to-now situation referred to in the head clause.

What have you been doing while I {*have been* / *was*} away? (*The past tense expands the domain; the present perfect establishes a simultaneous up-to-now domain.*)

Here the past tense dislocates the *while*-clause situation from t₀, so that the situation inquired about, which coincides with the *while*-clause situation, is also seen as dislocated from t₀, which means that the temporal relations do not have to start from t₀ but may start from the situation time of the head clause. The following are similar examples.

[You have a black eye and your clothes are torn!] You have been fighting with one of the boys you {*were* / *have been*} *playing* with, haven't you?

[Ah, there you are!] What have you been doing while I {*have been doing* / *was doing*} the washing-up?

The following are attested examples using the past tense:

["What have you been doing while I *was* away?" [he asked, crossing the room to look at a new kakemono on the wall.] (www)

What have you been doing while you *were* unemployed? (www)

[We knew that God who saved us alive would ask one day ask "And where have you been and] what have you been doing while your people *were thrown* into the burning hell and I *kept* you alive?" (www)

[Where have you been and] what have you been doing while I *stayed* at home and *made* money? (www)

Oh, Max, what have you been making while I *was* asleep? (www)

What have you been doing while you *were* incarcerated? (www)

If the speaker wants to emphasize that the *while*-clause situation is still ongoing at t_0 , he will use the present tense in the *while* clause:

[Where have you been and] what have you been doing while I *stay* at home and *make* money? (= 'I *stay* at home and *make* money, and *what have you been doing so far while I do that?*')

What have you been drinking while you *watch* the Discovery Channel? (www)

[Please talk about your experience.] What have you been doing while you're here [and what's it meant to you?] (www)

So what has Apple been doing while the Microsoft train *gains* speed? (www)

9.10.5 In the previous subsections of section 9.10 (which deals with the use of tenses in subclauses depending on a head clause with an up-to-now reading), we have only considered head clauses with an unmarked up-to-now reading or with a nonquantificational constitution reading (viz. the *what*-questions). The same rules in principle apply to sentences whose head clause receives a quantificational constitution reading. The following example may suffice:

This is the third time you have refused to give him something he {really *needed* / *has* really *needed* / really *needs*}. (*Needed* expresses T-simultaneity with the substitutions making up the hypersituation of the head clause; *has needed* establishes a W-simultaneous pre-present domain; *needs* establishes a present domain.)

9.11 Shifting the domain after a continuative perfect

If the pre-present domain is established by a 'continuative perfect' (which is the case when the time of the full situation is taken to include t_0), shifting the domain is the rule, though there are exceptions in which the domain is expanded as if it were a past domain (see 9.12).

9.11.1 When a present perfect clause receives a continuative interpretation, the situation time leads up to t_0 (without including it) but the time of the full situation is taken to include t_0 . If a new clause is to be temporally subordinated to such a clause, the T-relation expressed by the tense form of the new clause must normally start from t_0 . This is because t_0 is the most basic time in the tense system, and because it is difficult for the speaker to be concerned at the same time with the present part of the full situation and a part of it which is completely over. (Expanding a pre-present domain as if it were a past one implies that the speaker treats the binding time as a past time.)

In sum, when the head clause in the present perfect is given a continuative interpretation, the default case is for the subclause to use an absolute tense, which ‘shifts the domain’, i. e. establishes a new domain. (There are very few exceptions to this rule. They will be examined in section 9.12.) So an important point to be made right from the beginning is that when we talk of ‘T-relations on a continuative reading’, we are not thinking of temporal subordination (T-relations in a pre-present domain) but of ‘absolute T-relations’, i. e. T-relations that start from t_0 and are only realized when there is a shift of domain. The same point is made in the section on present domains. There we write the following:

A situation that is to be temporally related to a present situation time is, effectively, temporally related to t_0 . That is, a T-relation to a present orientation time has to start from t_0 . Logically, however, any T-relation that starts from t_0 is an ‘absolute deictic relation’: any tense form relating its situation time to t_0 is an absolute tense form, which creates a temporal domain of its own. This means that it is not possible to express a T-relation with the central orientation time of a present domain by means of a finite verb form: a present domain cannot be expanded by the use of relative tense forms. In each of the following examples, the subclauses use absolute tense forms, thus shifting the domain.

The following sentences illustrate the use of an absolute tense in a subclause depending on a head clause receiving a continuative perfect interpretation:

Since then I’ve felt I *was* wrong to insult the teacher in public. (*absolute past tense*)

For three years now we’ve noticed that the house *has needed* repairs.

I’ve always known that Jim *is* very intelligent.

For a long time now Sam has believed that he *will become* famous one day.

9.11.2 On a continuative interpretation, the time of the full situation starts at some point before t_0 and leads up to and includes t_0 . A full situation that is **W-anterior** to such a continuative situation necessarily lies wholly before t_0 . To refer to it, the speaker can make use of the two absolute tenses that T-locate the time of a situation wholly before t_0 , namely the absolute past tense, which locates the situation in the past time-sphere, or the present perfect on an indefinite reading, which locates the situation (as lying wholly before t_0) in the pre-present zone. In both cases, of course, the choice of tense effects a shift of domain in the subclause.

It is important to remember that when the speaker uses an absolute tense, no temporal relation is actually expressed between the situation referred to and any other situation referred to in the discourse. Thus the speaker of the first example below is simply saying that Jim has passed all his exams and that the speaker has known about this since last week. What tells us to locate the passing of the exams temporally prior to the knowing is the fact that one

cannot know about the actualization of a bounded situation until the situation has actualized completely.

I have known since last week that Jim *has passed* all his exams. (*indefinite present perfect*)

I have known for some time that it *was* not Bill who stole the money. (*absolute past tense*)

Ever since I talked to him I have felt that he *has shown* me the right path. (*indefinite present perfect*)

I have known for some time that he *died* in 1900 [but I just recently found the specific date and place]. (www) (*absolute past tense*)

Figure 9.7 represents the tense structure of the first example. (The dotted arrow represents the time of the full situation.)

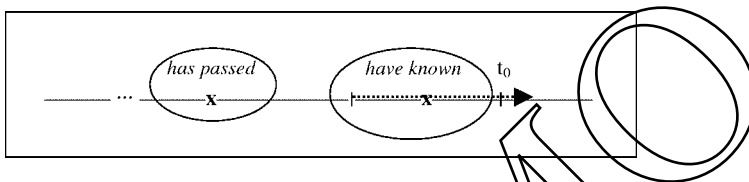

Figure 9.7. The tense structure of *I have known for some time that Jim has passed all his exams.*

9.11.3 If the full situation of the new clause, which shifts the domain, is intended to be interpreted as ~~W-simultaneous~~ with the continuative situation located in the pre-present domain, there are two possibilities as to the absolute tense that can be used.

- (a) If the speaker wants the subclause to be interpreted continuatively (like the head clause), he will again use a continuative present perfect:

We've been having trouble with the neighbours ever since we've *been living* here.
I've known for many years now that John *has been handicapped* since he was born.

- (b) If the speaker wants the subclause situation to be interpreted as having at least one point in common with the head clause situation (which is the definition of W-simultaneity – see 2.18.2), he can use either a present perfect or the present tense. The present perfect is possible as long as it is not interpreted as an indefinite perfect which locates its situation time entirely before the full situation of the head clause (as in Figure 9.7). The present tense is only possible under certain conditions – e. g. the situation has to be homogeneous (see below).

The sheriff has known for some time that Big John {*has been* / **is*} in town since last week. (Since last week requires the present perfect.)

[I've been looking for John for days now and] all this time you have known that he *is* away for two weeks without telling me!

Since then I've realized that my son *{has been / is}* out of control. (*There is W-simultaneity, i. e. overlap, as long as has been is not interpreted as actualizing at a time which precedes the beginning of the situation referred to by have realized.*)

[He whooped me one time when I was 15] so ever since then I've known he's a really tough player. (www)

[You know, ever since we have been working on this project,] I've had the strangest feeling that someone *{is / has been}* *checking* on us.

That the present tense can be used to refer to a situation that is meant to be interpreted as W-simultaneous with a situation leading up to and including t_0 follows from the fact that, unlike T-simultaneity, W-simultaneity requires no more than that the two situations have at least one point in common – see 2.18.2. This means that it is sufficient that both the times of the full situations are interpreted as including t_0 . The present perfect will especially be used if the speaker wants to explicitly represent the situation as starting in the past and continuing into the present; if this is not the case, the present tense is more natural. In both cases the tense establishes a new domain (which is interpreted as W-simultaneous with that established by the tense in the head clause). The use of the present tense is only possible if the situation (and the clause representing it – see 1.36.4) is homogeneous, because only in that case can the situation that is located at (i. e. represented as coinciding with) t_0 be interpreted as starting before t_0 . (This is the same restriction as excludes the simultaneity reading of *wrote a book* in *He said that he wrote a book* – see 8.25.5).

The following examples (in which the subclause is each time a complement clause) further illustrate all this:

I have suspected for some time that he *{is seeing / has been seeing}* another woman. (*The subclause is homogeneous because it is L-nonbounded as a result of the use of the progressive form.*)

I have suspected for months that he *{*is / has been}* abroad since then. (*The present perfect has to be used because since then explicitly refers to a pre-present period.*)

I have suspected for months that he *{is / #has been}* abroad. (*Has been does not receive a W-simultaneity reading here because in the absence of a duration adverbial the clause receives an indefinite rather than a continuative interpretation – see 5.4.7.*)

For how long have I been telling you that he *{loves / #has loved}* another girl? (*For lack of an adverbial referring to a period up to now in the that-clause, he has loved another girl receives an indefinite rather than a continuative interpretation.*)

I have known for some time that he *is* HIV, [but am very shocked and saddened about his declining health]. (www)

Since then I have felt *I've been living* on borrowed time. (*www*) (*Both perfects are continuative.*)

["You're scaring me now." – "I'm sorry." Hyzenthlay gasped] "But I have been having the distinct feeling that someone *has been watching us*. (*www*) (*id.*)

The following are examples in which the subclause is not a complement clause:

We have been staying in this house while the owners *{have been / are}* abroad for a few months.

Kerry has been out of the spotlight during the time when Bush *is facing* negative momentum. (*www*)

I've been reading loads of novels while I *{have been / am}* stuck in bed with this broken leg.

[Owners of lost pets have had trouble finding their pets because] so many shelters have been open only during the time that owners *are* at work. (*www*)

However, of the two tenses only the present perfect can be used if the full situation of the subclause is to be interpreted as coinciding with the full situation of the head clause:

Ever since this morning I have been scrubbing floors while you *{have been lolling / *are lolling}* around the house.

The house has been deserted all the time I *{have been / *am}* away.

Have all these things been lying in here while the door *{has been / *is}* open? [Suppose they had been stolen.]

9.11.4 If the situation time of a new clause which shifts the domain is **W-posterior** to the situation time of a continuative pre-present domain, it has to be located in the post-present zone by means of the future tense or a futurish form. This follows from the fact that, since a continuative interpretation means that the time of the factual full situation reaches up to and includes t_0 , only situations that are W-posterior to t_0 can be interpreted as W-posterior to the continuative full situation. A future tense form or futurish form locates the situation time of the situation which is W-posterior to t_0 in the post-present, thus establishing a post-present temporal domain. (As explained in 2.9.1, a post-present domain can be created by an absolute future tense form – with *shall* or *will* – or by the present tense of *be going to*, *be to*, *be about to*, or by a present tense effecting a shift of temporal perspective from the present to the post-present, as in *I'm leaving in a minute.*) The following examples illustrate this shift of domain from the pre-present to the post-present:

I have known for some time that he *{is going to / will / is about to}* leave the country.

Since when has it been clear that Steve's injury is still bad and that his substitute *will be playing* instead?

For a couple of days it's been public knowledge that the general manager *is going* to Peru at the end of the month.

The fear has been that the introduction of the passes *will* further *dissuade* French film-goers from going to small cinemas. (www)

9.12 Temporal subordination after a continuative perfect

It was noted in 9.11.1 that a pre-present domain established by a 'continuative perfect' cannot normally be expanded (as if it were a past domain) because the full situation is taken to include t_0 . If a new clause is to be temporally subordinated to such a clause, the T-relation expressed by the tense form of the new clause must normally start from t_0 . This is because t_0 is the most basic time in the tense system, and because it is difficult for the speaker to be concerned at the same time with the present part of the full situation and a part of it which is treated as over. (Expanding a pre-present domain as if it were a past one implies that the speaker treats the binding time as completely over.) Still, we have found some examples that form an exception to this rule. It is typical of them that the head clause situation is each time a repetitive hypersituation, consisting of a number of subsituations and gaps between them:

I've been told from childhood that I *was* a bastard. (*continuative interpretation of the head clause; no instance of telling need include t_0 . What actualizes at t_0 may be a gap*)

For years now, Tunica County officials have been saying they *would provide* amenities to make Tunica a destination, rather than just a weekend getaway. (www)

They have been saying they *would tear* all this trash down for almost ten years. [I will be happy when it finally disappears.] (www)

In these examples the fact that nearly all the subsituations of the continuative hypersituation precede t_0 apparently renders it possible to treat the hypersituation as if it were a past situation.

There are also examples with *have known* in the head clause, in which case the head clause situation is not a repetitive hypersituation. In that case temporal subordination means that there is a (not necessarily very important) focus on the part of the situation that precedes t_0 . Thus in the first example below, the speaker's choice of past tense might be influenced by a desire to make it clear that he is not 'behind the times', i. e. that not only is he aware that George Michael is gay, but he has been aware of it for as long as most people.⁷

7. Another possibility is that in cases like these the choice of the past tense over the present tense might just be random, given how little difference there often seems to be between the two in interpretive effects.

[I watched Oprah today and George Michael was on there and I enjoyed his interview.] I have known for some time that he *was* gay [but you know he is still sexy]. (www) (*T-simultaneity*)

I have known for some time that she *was* in great pain, [but unfortunately the only thing I could and can do is pray that God reveals his plan for her.] (www) (*T-simultaneity*)

I have known for some time that she *would* not *last* long, [but the news that she has died still comes as a shock]. (*T-posteriority*)

[We plan to place a culvert and put dirt and plant grass over it.] We have known from the beginning that we *would need* to add fill dirt to bring the lot up. (www) (*T-posteriority*)

[The loss has been very depressing.] Though we have known for some time that things *had taken* a turn for the worse, it is still hard to believe he is gone. (www) (*T-anteriority*)

Williams and BMW have known since the end of July that Montoya *had signed* to drive for McLaren in 2005. (www) (*T-anteriority*)

9.13 Pre-present domains and use of tenses: summary

The following chart summarizes the main findings of Part II (= sections 9.8–12):

Kind of W-interpretation	Temporal subordination (= shift of perspective to past zone)	Shift of domain
indefinite	possible on a non-recency reading	possible
up-to-now	possible	possible
continuative	only very exceptionally possible	as a rule obligatory

III. Present domains

9.14 Head clauses referring to a nonrepetitive present situation

Expressing a temporal relation to the time of a nonrepetitive situation located in the present zone is tantamount to relating a situation time to t_0 . Since expressing a temporal relation to t_0 is done by means of an absolute tense form, this means that a new domain is created, i. e. that there is a shift of domain. In other words, temporal subordination to a present situation time by means of a relative tense form is not possible.

9.14.1 A situation that is to be temporally related to a present situation time is, effectively, temporally related to t_0 . That is, a T-relation to a present orientation time has to start from t_0 . Logically, however, any T-relation that starts from t_0 is an ‘absolute deictic relation’: any tense form relating its situation time to t_0 is an absolute tense form, which creates a temporal domain of its own. This means that it is not possible to express a T-relation with the central orientation time of a present domain by means of a finite verb form: a present domain cannot be expanded by the use of relative tense forms.⁸ In each of the following examples, the subclauses use absolute tense forms, thus shifting the domain:

I am just explaining that I {*did* it last night / *have* already *done* it / *will* do it tomorrow}.

Why don't you admit you {*will* leave / *are* leaving / *are* going to leave} the country next week?

You know that I *have not been* able to do it because I *have been* too busy. (*The two present perfect forms establish two separate pre-present domains, which are pragmatically interpreted as W-simultaneous with each other.*)

It seems that she *is working* on a project.

I am just saying that I *believe* that John *is lying* to us about what he *intends* to do.

In the latter two examples, none of the present tense forms is a relative tense form expressing T-simultaneity. All of them are absolute tense forms, representing their situation time as the central orientation time of a present domain.

8. However, things are different when a nonfinite verb form is used, as in *He seems to have been ill*. As noted in 2.5, a nonfinite verb form cannot establish a domain; it expresses no more than a single temporal relation with a contextually given orientation time (which is usually the situation time of the head clause or t_0). In the above example the perfect infinitive thus expresses anteriority in the present domain.

However, this does not mean that the simultaneity relation which we understand there to be between the situation of the subclause and the situation time of the head clause is a question of pragmatic W-interpretation, as it is in *When they had visited the house they had been accompanied by a real estate agent* (= ‘indirect binding’ – see 9.29). In *He says he is ill* simultaneity is expressed linguistically, not by the use of a relative tense in the subclause, but by the use of two absolute tenses which both represent their situation time as coinciding with t_0 . As noted in 2.18.2, two intervals are interpreted as W-simultaneous if they have at least one point in common. This means that (except in the ‘Special Present Time-sphere System – see 3.2–11) all the situations referred to in the present tense are taken to be W-simultaneous with each other. In *I know he is ill* we therefore have W-simultaneity rather than T-simultaneity (which is a domain-internal relation), but this W-simultaneity reading is not caused by contextual or pragmatic factors: it follows from the fact that the two situation times are T-located at the same time.

9.14.2 The question whether the present tense can or cannot express T-simultaneity in a present domain may seem to be an academic question, since T-simultaneity has been defined in terms of coincidence. Whether we consider *is lying* in *I believe he is lying* as a relative tense expressing T-simultaneity or as an absolute tense establishing a new present domain, the temporal structure would each time seem to be the same: the situation time of *is lying* is T-represented as coinciding with t_0 . However, this is not really the case. If the present tense of *is lying* is a relative tense expressing T-simultaneity, the temporal structure is such that the situation time of *is lying* is represented as T-simultaneous with that of *believe*, whereas if the present tense of *is lying* is an absolute tense, the temporal structure is such that the situation time of *is lying* is represented as coinciding with t_0 . The fact that in the latter case the situation time of *believe* also coincides with t_0 does not alter the fact that the latter case is tense-structurally different from the former, and also differs from it in that in the former (hypothetical) case, where the present tense is a relative tense, the temporal structure explicitly privileges the relationship between *believe* and *is lying*, conveying, presumably, something about the semantics of the sentence that the accidental – albeit unavoidable – W-simultaneity of the two situations (referred to by absolute present tense forms) does not. As far as we can see, there is no such extra semantic element that would lead us to believe that the present tense can express a T-relation with a situation time which is located at t_0 .

9.15 Head clauses referring to a present repetitive hypersituation

Consider:

[Whenever he comes here] he *talks* about what he {*did* the night before / *has been doing* that day / *has* already *done* for me}.

[Each time he talks to me] he says I *have* a lovely face.

[Whenever I meet him] he *tells* me that he {*will* never *forget* my mother's kindness to him / *is leaving* to join the Foreign Legion any day now}.

It appears from these examples that the situation time of every subsituation (forming part of a repetitive habit that is located at t_0) is itself also treated as t_0 (see the discussion of 'basic orientation time' in 9.9.11), so that the normal absolute tense forms (present, present perfect, past and future tenses, plus futuristic forms) are used to express temporal relations with this situation time.

DEMO

IV. T-relations in a post-present domain

A. Definition of ‘post-present domain’

9.16 What counts as a post-present domain?

A post-present domain is a temporal domain whose central orientation time lies in the post-present. Such a domain can be established *directly* by the use of the future tense or by a futurish (see 2.9.1) verb form (e.g. *He’s going to leave; I’m leaving tonight*). It may also be established *indirectly* by constructions which do not have a future or futurish tense form but which nevertheless imply future time reference (more specifically, future actualization), such as imperatives or certain verbs whose semantics is future-oriented, like *expect* or *intend*, or a temporal conjunction like *until*. This possibility is illustrated by the following examples. (As we will see in 9.20, the relative tense forms expressing T-simultaneity in a post-present domain are present tense forms. In the examples below, the presence of a form with such an interpretation (*leaves*) proves that the relevant situation time belongs to a post-present domain.)

[Tell him] to arrest the man when he *leaves* his house.

[I expect him] to be arrested when he *leaves* his house.

[Promise me] not to try and stop him when he *leaves* his house.

I am waiting until she *leaves*. (*Leaves* expresses T-simultaneity with the orientation time that is implicit in the meaning of *until* (‘until the time that’). This implicit time is taken to be a post-present time because *until* expresses the W-posteriority relation between the implicit time and t_0 .)

B. T-relations in a post-present domain

9.17 Expanding a post-present domain

T-relations in a post-present domain are expressed by tenses resulting from a shift of perspective. The speaker treats the post-present central orientation time as if it were t_0 and uses a ‘pseudo-absolute’ tense form to T-relate another situation time to this ‘pseudo- t_0 ’, thus locating it in any of the four possible ‘pseudo-absolute zones’ (e.g. the ‘pseudo-past zone’, the ‘pseudo-pre-present zone’, etc.). The pseudo-absolute tenses are the same as are used to express T-anteriority, T-simultaneity or T-posteriority to the real t_0 , namely the absolute past tense or the present perfect, the present tense and the future tense (or a futurish present tense form), respectively. Thus, in *Who will look*

after you when Brad and Sybil have left?, the present perfect form *have left* expresses T-anteriority to the post-present pseudo- t_0 .

The ‘pseudo-absolute subdomains’ created by the pseudo-absolute tenses can be further expanded in exactly the same way as genuine absolute domains can be expanded.

9.17.1 When a post-present domain is expanded, there is a shift of temporal perspective: the central orientation time of the post-present domain is treated as if it were t_0 . This creates all sorts of possibilities, for t_0 is the time from which the four absolute zones are defined. Since the central orientation time of a post-present domain is a ‘PSEUDO- t_0 ’, it is a point from which four different PSEUDO-ABSOLUTE ZONES are defined – see Figure 9.8 – and the systems of expressing domain-internal T-relations in these pseudo-absolute zones are exactly the same as those observed above in connection with the (genuine) absolute zones.⁹

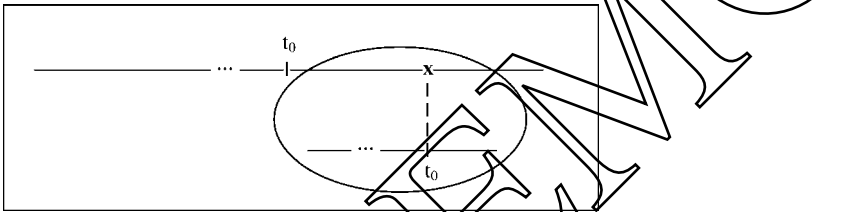

Figure 9.8. The basic tense structure of an expanded post-present domain.

9.17.2 The shift of perspective turning the post-present central orientation time into a pseudo- t_0 applies recursively. This means that it also applies to any orientation time that is T-simultaneous with, or T-posterior to, the central orientation time or another pseudo- t_0 . This is clear from the use of the italicized and underlined forms in the following examples. The italicized present tense forms express T-simultaneity, which means that their binding orientation time is treated as a pseudo- t_0 . The underlined future tense forms or futurish

9. Naturally, this does not mean that a pseudo-absolute present domain (i. e. a post-present domain) can be expanded exactly like a true present domain. In 9.14 it was argued that a genuine present domain cannot be expanded by a relative tense form because its central orientation time coincides with t_0 : any relation starting from t_0 is an ‘absolute relation’ resulting in a shift of domain. By contrast, a post-present domain can be expanded by the use of pseudo-absolute tense forms creating pseudo-absolute subdomains – see 9.17.3.

forms express T-posteriority to the central orientation time or to another pseudo- t_0 and therefore function as pseudo- t_0 's themselves.

[If I get caught by the police] I will tell them that they're *making* a mistake. (*The present tense T-locates the situation of making a mistake simultaneous with the situation of telling. The present tense is used because the situation time of will tell is treated as a pseudo- t_0 .*)

[If I get caught by the police] I will tell them that my solicitor will prove to them that they're *making* a mistake. (*The future tense of will prove T-locates the proving posterior to the pseudo- t_0 set up by will tell, and the present tense of are making (*a mistake*) locates the mistake-making simultaneous to the pseudo- t_0 set up by will prove.*)

What I'll tell them is that, if I ever *get* seriously ill, I will tell the board at once that I'm going to resign because I *feel* incapable of continuing my work as general manager.

This (recursive) mechanism will be discussed in more detail in 9.20–22.

9.17.3 It needs stressing that the relations expressed by the underlined and italicized verb forms in the above examples are T-relations expanding a domain. The fact that the same verb forms can also express a relation to t_0 (when they are used as absolute tense forms) is irrelevant to this. Relations to t_0 are not T-relations expanding a domain. There is, indeed, an essential difference between t_0 and a post-present orientation time treated as a pseudo- t_0 . As explained in 9.14.1, any relation starting from t_0 is an 'absolute deictic relation'. The same is not true of relations starting from a post-present orientation time functioning as 'pseudo- t_0 '. Such relations are expressed by **PSEUDO-ABSOLUTE TENSES**. These create a pseudo-past or pseudo-pre-present subdomain, which can be expanded just like a 'real' past or pre-present domain.

In sum, there exists a set of tenses that are used to express T-relations in a post-present domain. Because the central post-present orientation time is treated as a pseudo- t_0 , these tenses are 'pseudo-absolute' tenses. That is, they have the same form as the absolute tenses but they express a domain-internal T-relation rather than establishing a new domain. For example:

[If you shoot him] I will tell the police that you *murdered* him.

The use of the past tense form *murdered* here does not effect a shift of domain because it does not relate the situation of the subclause to (the real) t_0 . It relates it to a post-present orientation time which is treated as if it were t_0 . In other words, because the binding orientation time is a pseudo- t_0 , the past tense is used as a pseudo-absolute tense, whose function is to express a T-relation in a post-present domain, viz. T-anteriority (in the sense of: 'The situation time is located in a pseudo-past zone which is defined relative to a pseudo- t_0 '). Pseudo-absolute tense forms function like relative tenses: they express a T-relation inside an already established domain. In doing so they establish a **PSEUDO-ABSOLUTE SUBDOMAIN** within the post-present domain.

This is not to say, however, that a pseudo-absolute past tense is a ‘relative past tense’ – see also 9.23 below. As noted in 8.24.1, a relative past tense expresses T-simultaneity in a past domain, a ‘past subdomain’ (see 9.3.1) or a ‘pseudo-past subdomain’ (see 9.18). A pseudo-absolute past tense differs from this in that it expresses T-anteriority (rather than T-simultaneity) in a post-present (rather than past) domain and in that it expresses this relation only to a specific sort of orientation time, viz. a pseudo- t_0 . For these reasons, a ‘pseudo-absolute’ past tense is to be distinguished from a ‘relative’ past tense, although it does express a T-relation in a domain. In fact, ‘pseudo-absolute’ is a concept that is not on a par with ‘absolute’ and ‘relative’. There are absolute tenses and there are relative tenses, but, strictly speaking, there are no pseudo-absolute tenses. When we speak of ‘pseudo-absolute’ we are referring to a particular (special, because resulting from a shift of perspective) *use* of a tense which is basically used as an absolute tense but now fulfils the function of a relative tense, i. e. a tense expressing a T-relation in a domain. (This discussion is resumed in 9.23.)

C. Expressing T-anteriority in a post-present domain

A situation time that is anterior to t_0 is located either in the past time-sphere or in the pre-present zone. In the same way, a situation time that is to be interpreted as anterior to the central orientation time of a post-present domain is located either in the *pseudo-past time sphere* or in the *pseudo-pre-present zone* (both of which are defined relative to the pseudo- t_0). This means that we will use either the preterite or the present perfect.

9.18 The past tense expressing T-anteriority in a post-present domain

9.18.1 We use the preterite if we want to locate the situation time at a time which we view as past with respect to, and as disconnected from, the post-present pseudo- t_0 , i. e. if we want to locate the situation time in a **PSEUDO-PAST SUBDOMAIN**.

Sooner or later the police will find out that you *were staying* here today, and not in Glasgow.

(*spoken in 2006*) From 2012 onwards, any employees that *didn't work* hard enough during the preceding year will earn less during the following year.

At the end of the concert, I will find someone who *enjoyed* the performance and someone who *didn't enjoy* it and record an interview with each of them.

9.18.2 Note that it is irrelevant whether the pseudo-past situation time precedes, includes, or follows (the real) t_0 . The W-relation between the situation time and t_0 is not expressed by the tense form: the past tense only expresses the T-relation between the situation time and the pseudo- t_0 . Thus, in the following examples, the situation of the subclause is interpreted as W-anterior, W-simultaneous and W-posterior to t_0 , respectively:

This will make the police believe that he *was killed* yesterday.

This will make the police believe that you *were staying* here today, and not in London.

This will make the police believe that he *was killed* several hours later than he will actually be killed.

9.18.3 The pseudo-past situation time can itself serve as binding orientation time for other situation times that are introduced into the pseudo-past subdomain. The latter situation times are then referred to by means of the tense system that is used to express T-relations in a genuine past domain:

[If we kill him tomorrow night,] the police will think that he was killed when he *came* home after he *had attended* the meeting at his club. They will believe that he was murdered because he *had found out* where the heroin *would be handed over*.

In this example the post-present domains established by *will think* and *will believe* each contain a pseudo-past subdomain, which is expanded as if it were a true past domain. See Figure 9.9, which represents the tense structure of the first sentence in the above example. As is clear from this structure, *was killed* is the form establishing the pseudo-past subdomain and *came* is a normal relative preterite expressing T-simultaneity in that subdomain.

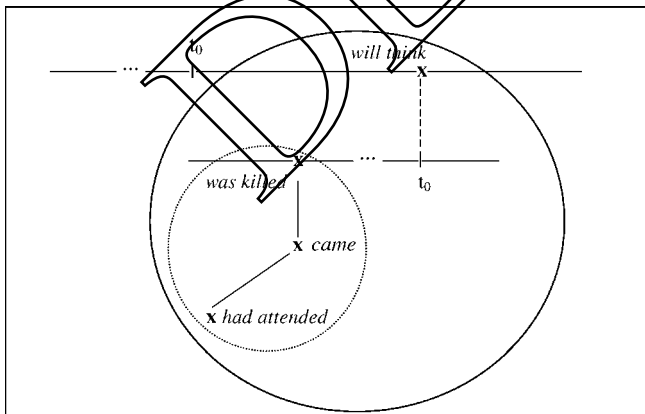

Figure 9.9. The tense structure of [If we kill him tonight,] the police will think that he was killed when he came home after he had attended the meeting at his club.

9.18.4 A pseudo-past subdomain can also be created by the future perfect. As we will see in section 9.25, the future perfect locates its situation time either in the pseudo-pre-present or in the pseudo-past. In the latter case, when another situation time is temporally subordinated to the central orientation time of the **PSEUDO-PAST SUBDOMAIN** (i. e. to the situation time of the future perfect), the tenses effecting this binding are in accordance with the rules described in the previous subsection. In other words, the pseudo-past subdomain created by the future perfect is expanded as if it were a true past domain:

[If you only arrive at the party after midnight, we will not see each other any more, because] I will have left when Susan *left* [and she has to be home before midnight].

However, the subdomain created by a future perfect is more often interpreted as a **PSEUDO-PRE-PRESENT SUBDOMAIN**. If such a subdomain is expanded, it is expanded in exactly the same way as a true pre-present domain is expanded, i. e. as if it were a past domain:

[Send a telegram saying that she is dangerously ill. Then, by the time we send the second telegram saying that she is dead,] he will have been warned that the situation *was* serious [and the news won't come as quite such a shock]. (*Will have been warned* both establishes a post-present domain and locates its situation time (the time of the warning) in a pseudo-pre-present subdomain forming part of that post-present domain. The pseudo-pre-present subdomain in question is developed as if it were a past domain by means of *was*, which expresses T-simultaneity.)

For further discussion, see section 9.25

9.19 The present perfect expressing T₁-anteriority in a post-present domain

9.19.1 When a situation time is located in a period leading up to (and not felt to be divorced from) the pseudo- t_0 (= the central orientation time of the post-present domain), this period is treated as if it were the pre-present zone. Naturally, it is the present perfect that is used to locate a situation time in such a **PSEUDO-PRE-PRESENT ZONE**:

From next month onwards, any bread that *has not been sold* by the end of the day will be given to the orphanage.

Who will look after you when Brad and Sybil *have left*?

[Don't try to fool him.] He will soon find out that you *have been leading* him up the garden path.

In these examples the present perfect is used as a pseudo-absolute tense.

9.19.2 The pseudo-pre-present situation time may serve as binding time for other situation times that are introduced into the post-present domain. The

latter situation times are then referred to by means of the tense system that is typical of the pre-present zone. For example, if the present perfect is of the 'indefinite' type, its situation time will be treated as if it were a past orientation time (see 9.9). This means that the pseudo-pre-present subdomain created by the present perfect within the post-present domain will be treated as if it were a past domain:

The police will certainly ask you whether anyone *has* ever *told* you that they *had been bitten* by your dog, [and you will not be able to say 'no' because I'm telling you now that I've been bitten by it]. (*Has told* establishes a pseudo-pre-present subdomain which is developed as if it were a past domain, witness the use of *had been bitten* to express T-anteriority.)

[If ever you want to use Tina's car, don't ask Tom if you can do so but ask her directly.] Otherwise Tom will tell everybody that you *have told* him that you *wanted* to use Tina's car but *were* afraid to ask her directly. (*Have asked* establishes a pseudo-pre-present subdomain, in which the relative past tense forms *wanted* and *were* express T-simultaneity.)

Notice, however, that not all pseudo-pre-present subdomains can be expanded as if they were past domains. Sometimes they cannot be expanded at all, so that the speaker can only create a new subdomain (interpreted as W-simultaneous with the existing one):

[If he doesn't come at Christmas either] it will be exactly three years since we *have been told* how he {*is* / **was*} *doing*. (*We cannot use was doing* to express T-simultaneity in the pseudo-pre-present domain established by *have been told*. This is because of the continuative interpretation: 'Next Christmas the not-telling-us-how-he-is-doing will have been actualizing for exactly three years' – see 5.21.1.)

In 9.9.6–10 we have observed that there are similar constraints on developing (genuine) pre-present domains.

D. The expression of T-simultaneity in a post-present domain

9.20 Coincidence with the central orientation time of a post-present domain

9.20.1 Since the central orientation time of a post-present domain functions as a pseudo- t_0 , it is the present tense that is used to represent another situation time as coinciding with it:

He will steal the diamonds while his accomplice *diverts* the guard's attention.

If the weather *is* fine tomorrow, father will say that it *is* time for a picnic.

[If you leave the country] the police will never find out where you *are*.

The tense structure of (the relevant part of) the last example is represented by Figure 9.10. (Note that the present tense form *are* is used here as a pseudo-absolute tense form. Its function is to represent its situation time as coinciding with the post-present pseudo- t_0 .)

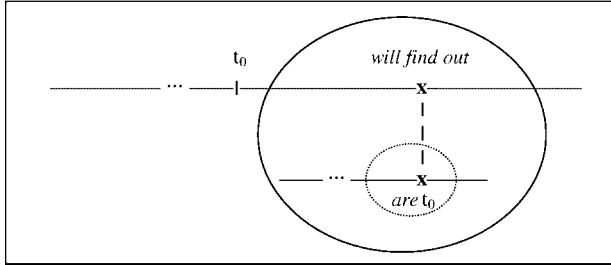

Figure 9.10. The tense structure of *The police will never find out where you are.*

9.20.2 Because the default meaning of the present tense is that it locates a situation time at t_0 (rather than at a post-present pseudo- t_0), this pseudo-absolute use of the present tense may cause ambiguity if there is no context making it clear that the reference is to the post-present. This applies specifically to subclauses that easily allow a shift of domain.

The police will find out where you are. (*Where you are* is ambiguous between ‘where you are now’ and ‘where you will be then’.)

[If you leave the country] the police will find out where you are. (*The conditional clause makes it clear that where you are must be interpreted as having post-present time reference, i.e. as meaning ‘where you will be at the time when the police will find out about your whereabouts’.*)

[You should try to order from several suppliers, because] you will never know who is the cheapest [unless you try them]. (*ambiguous*)

9.20.3 This use of the present tense as pseudo-absolute tense is restricted to some kinds of subclause (e.g. complement clauses, conditional clauses expressing an ‘open condition’, restrictive relative clauses). In independent clauses and in some types of subclause (e.g. nonrestrictive relative clauses) reference to the post-present requires the use of an absolute tense form creating a new post-present domain, which, because of the context or pragmatics, is interpreted as W-simultaneous with the existing post-present domain. Hence the difference between the following:

Next time you will be met by a man who *is wearing* a red tie. (*Is wearing* is a pseudo-absolute present tense representing its situation time as coinciding with the situation time of *will be met*. This representation in terms of coincidence is possible

because the full situation of wearing a tie is represented as homogeneous by the progressive form – see 2.12.2.)

Next time you will be met by a man. He *will be wearing* a red tie. (*Will be wearing* is a future tense form establishing a post-present domain which is interpreted as W-simultaneous with that established by the first clause.)

The tense distribution of the two forms – the future tense as absolute tense and the present tense as pseudo-absolute tense – will be examined in detail in chapter 10. (This distribution has nothing to do with the present tense per se, but everything with the context in which it is used.)

A present tense form locating a situation time in a post-present domain sometimes expresses ‘sloppy simultaneity’. This means that the bound situation time and the binding time are not really simultaneous, but are (for a rhetorical purpose) represented as simultaneous with each other. For example: *I will turn off the central heating when I go out.*

9.20.4 The use of a tense form representing a bound situation time as T-simultaneous with a binding situation time as a rule requires that the situations of the two clauses be W-simultaneous (i.e. either coincide or overlap – see 2.18.2). This is the case in the examples given in 9.20.1–3. However, there is only ‘SLOPPY SIMULTANEITY’ between the situations in sentences like the following:

When John *comes* home, I will tell him about the accident.

[Be careful in your speech tonight.] The newspapers will print everything you *say*.

If Mary *dies*, John will come into a fortune.

Each of these examples refers to two situations which do not coincide or overlap but follow each other. Still, the tense used in the subordinate clause is each time the tense that is typically used to express T-simultaneity, not T-anteriority. T-anteriority would be expressed as follows:

When John *has come* home, I will tell him about the accident.

The newspapers will print everything that you *have said*.

If (by the end of the year) Mary *has died*, John will come into a fortune.

It appears, then, that present tense forms whose basic meaning is to express T-simultaneity with a post-present situation time can sometimes be used in cases where there is no real W-simultaneity between the two situations. Such present tense forms express SLOPPY SIMULTANEITY. In these cases the speaker disregards

the fact that the two situations do not really overlap but concentrates on the fact that they follow each other closely and that there is some logical relation between them. The use of a tense form whose basic function is the expression of T-simultaneity then means that the speaker treats the two situations as belonging to the same ‘occasion’ and hence as falling within the same time interval.¹⁰ Another clear illustration of such a use is provided by examples like the following, where the relevant verb form is a form whose basic meaning is the expression of simultaneity, viz. a present participle:

Opening the drawer, he took out an old photo of a man in uniform.

Raising the lid of the well, she pointed to the green water.

The locomotive jumped the rails, narrowly *missing* a couple of trees near the railway.

In these examples, the situation referred to in the present participle clause either precedes (in the first two examples) or follows (in the third example) the head clause situation.

The fact that verb forms expressing T-simultaneity can be used in a sloppy way illustrates the fact that T-simultaneity is the unmarked relation of the three that can be expressed by verb forms. This is especially clear in conditional sentences referring to the post-present, where the expression of a temporal relation between the two clauses is less important than the expression of the logical link (‘if p, then q’). In such conditional sentences the *if*-clause is therefore likely to use a tense form expressing T-anteriority only if it contains a time adverbial like *by 5 o’clock* (as in *I will punish you if you haven’t finished by 5 o’clock*). Otherwise, it normally involves a tense form expressing simultaneity. This may even be the case when the two clauses contain adverbials referring to different times, as in *If John doesn’t do it today, I will do it myself tomorrow*. In such a sentence the speaker represents the two situations as if simultaneous if he is just thinking of them as two post-present situations that are logically connected with each other.¹¹ It is only when he wants to draw explicit attention to the fact that one situation is over before the other takes place that he selects the verb form expressing anteriority (*If John hasn’t done it today, I will do it myself tomorrow*).

10. In fact, this also holds for the absolute use of the present tense, which represents a situation as T-simultaneous (= coinciding) with t_0 . Leech (1971: 3) points out that the ‘instantaneous’ use of the present tense does not require that the situation be strictly simultaneous with t_0 . A sentence like *Now I open the envelope* may be uttered seconds before the action takes place. As Leech points out, “it is subjective rather than objective simultaneity that is conveyed”.

11. The fact that conditional sentences represent the contents of the two clauses as simultaneous is also apparent from the fact that the head clause can be introduced by *then* (e.g. *If John doesn’t do it, then I’ll have to do it myself tomorrow*). This use of *then* may not be purely temporal, but it is reminiscent of the temporal meaning of the adverb, which is ‘at that time’, i.e. ‘at the time referred to in the *if*-clause’.

9.21 T-simultaneity with an orientation time coinciding with the central orientation time

A time that is T-simultaneous with a pseudo- t_0 , or with another time that is T-simultaneous with a pseudo- t_0 , also functions as a pseudo- t_0 .

When a situation time is represented as coinciding with a pseudo- t_0 (i.e. the central orientation time of a post-present domain), that situation time can be the binding orientation time for another situation time. In that case the relation of T-simultaneity (coincidence) is also expressed by the present tense. This means that not only the central orientation time of a post-present domain but also any situation time that is represented as T-simultaneous with it is treated as a pseudo- t_0 . If such a pseudo- t_0 binds another situation time, the latter will therefore be referred to by one of the four pseudo-absolute tenses. In the following examples the tense forms referring to the bound situation time are italicized, whereas the binding situation times (which are also bound pseudo- t_0 s because they are each represented as coinciding with another pseudo- t_0) are underlined:

- I'll give a fiver to anyone I meet while I *am* there and who says he is glad to meet me.
- They will find out that Jack thinks that he *was born* in London.
- [If we don't hide this letter from Gladys] she will go and tell everybody that she knows why Tim *has been fired*.
- [Do not inform Jack, or] he will tell the police that he knows that a murder *will be committed*.

The tense structure of (the relevant part of) the last example is represented by Figure 9.11.

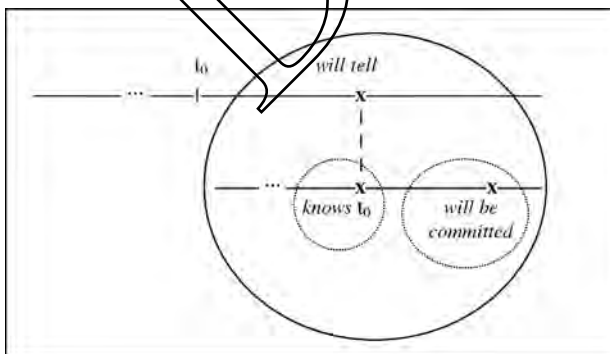

Figure 9.11. The tense structure of [Do not inform Jack, or] he will tell the police that he knows that a murder will be committed.

E. The expression of T-posteriority in a post-present domain

9.22 T-posteriority in a post-present domain

To represent a situation time as T-posterior to t_0 we use the future tense or a futurish form. This means that the situation time in question is represented as a pseudo- t_0 functioning as the central orientation time of a pseudo-post-present subdomain.

Predictably, to represent a situation time as T-posterior to the central orientation time, or to any other pseudo- t_0 in the post-present domain, we use the same tense as is used to represent a situation time as T-posterior to (the real) t_0 , viz. the future tense (or one of the ‘futurish’(see 2.9) verb forms). This tense form is then used as a pseudo-absolute tense form, which locates its situation time in the ‘pseudo-post-present’ and in doing so creates a ‘pseudo-post-present subdomain’ within the post-present domain.

He will swear that he *will* never *tell* her the ugly truth.

[When I’m throwing my own party next month] I’ll be able to tell you whether there {*will* / *is going to*} be a display of fireworks after the speeches, [but this time I don’t know].

In the same way as a situation time that is posterior to t_0 is treated as if it were t_0 , any situation time that is represented as T-posterior to such a pseudo- t_0 is also treated as a pseudo- t_0 when another situation time is related to it. This means that the latter situation time is located in one of the four pseudo-absolute zones:

She will think that John *will* tell the others {that he *was* here tonight / that he *has not told* them the truth yet / that he *is* dissatisfied with their behaviour / that he *will tell* them the truth later}.

Figure 9.12 represents the tense structure of this sentence when *will tell* is used in the final clause.

This use of the future tense to establish a pseudo- t_0 can repeat itself indefinitely. Any situation time that is T-posterior to a pseudo- t_0 functions as a pseudo- t_0 itself. This can produce structures with multiple pseudo- t_0 ’s, such as the following (in which each pseudo- t_0 is underlined):

Shirley will think that John will find out that Ted will tell Susan {that he *was* here tonight / that he *has not told* her the truth yet / that he *is* dissatisfied with her behaviour / that he will tell her the truth later}.

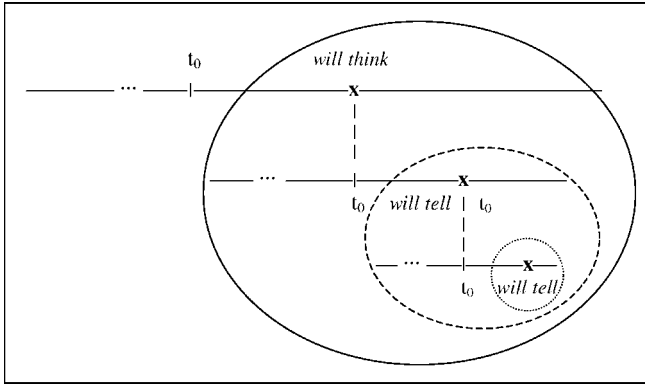

Figure 9.12. The tense structure of *She will think that John will tell the others that he will tell them the truth later.*

9.22.1 Examples can be found in which the post-present domain is **ESTABLISHED INDIRECTLY** by a tense form expressing a T-relation within the domain:

Yesterday Sheila said she would be abroad when our wedding *takes* place.

In this example the situation times of *said* and *would be* are located in a past domain, while the situation time of *takes* is located in a post-present domain. The latter is not established ‘directly’ (i.e. by a future tense or futurish verb form whose situation time is the central orientation time of a post-present domain) but by the use of a form representing its situation time as coinciding with the unspecified central orientation time of the domain. This is possible because the situation time of *would be abroad* is meant to be interpreted as W-posterior to t_0 , so that *would be abroad* evokes ‘will be abroad’.

The use of the present tense in examples like the following can probably be explained in a similar way.

I don’t care if he *{is / *will be}* exhausted tomorrow.

As noted in 10.7.1, the future tense cannot be used in clauses expressing an open condition (i.e. a condition which may or may not be fulfilled in the future: *I will be sad if she {doesn’t get / *won’t get} that job*). The same rule appears to be at work in *I don’t care if he {is / *will be} exhausted tomorrow*. Here the post-present domain is established indirectly by *is*, which represents the being exhausted as T-simultaneous with a central orientation time which is specified only by virtue of being ‘contained’ in the Adv-time indicated by *tomorrow*.

It is possible that the same analysis is also applicable to sentences like the following, in which the present tense can be used as an alternative to the future tense:

I hope our train *{isn't / won't be}* late again today.

I bet I *{get / will get}* there before him.

However, it is equally possible that the use of the present tense here represents a 'shift of temporal perspective' similar to what we observe in *It doesn't matter what we do* – see 10.6.2.

9.23 The theoretical status of pseudo-absolute tense forms

9.23.1 It has been shown that, in a post-present domain, any T-relation between a bound situation time and the binding post-present pseudo- t_0 is expressed by exactly the same tense as T-relates a situation time to the real t_0 . The only difference is that in the latter case the tenses are absolute tenses establishing domains, whereas in the former case they are pseudo-absolute tenses establishing (pseudo-absolute) subdomains. Because in doing so they express a T-relation in a post-present domain, we might feel tempted to say that these pseudo-absolute tenses are relative tenses, but it would not be correct to do so. That is, it would be mistaken to conclude that next to the absolute present tense there is a relative present tense, and similarly, that there are two different present perfect tenses and two different post-present tenses.

Pseudo-absolute tenses result from applying a 'shift of perspective', i. e. from locating a situation time in an absolute time zone that is different from the one in which it would naturally be located. Treating a post-present situation time as if it were t_0 is similar to treating a past situation time as if it were present, as in the historic present, or to treating a pre-present situation time as if it were present, as in *I hear you have been promoted*, or as treating the central orientation time of a domain established by an indefinite present perfect as if it were a past orientation time when the domain is expanded, as in *I've never told you before that you were very talented*. In each case a situation time is treated as if it were a situation time belonging to a different absolute time-zone from the one that it would naturally be located in. This is done by a marked choice of tense, i. e. by a tense which is not used with its basic meaning but in a metaphorical way. In the same way the use of a pseudo-absolute tense to expand a post-present domain is a metaphorical use of an absolute tense. By contrast, there is usually nothing metaphorical about the use of relative tenses, i. e. the past perfect, the relative past tense, the conditional tense and the conditional perfect tense. (The latter are used metaphorically only if they are used to expand a pre-present domain as if it were a past one.)

It follows that speaking of 'pseudo-absolute tenses' is really a sloppy way of speaking of 'the pseudo-absolute use of tenses whose basic use is absolute'. For example, there is only one present perfect tense, but it has two uses because it can locate a situation time either in the pre-present zone, which leads up to

t_0 , or in a pseudo-pre-present period leading up to a post-present pseudo- t_0 . By contrast, as far as past tense forms are concerned, there are two past tenses, the absolute one and the relative one. (See the elaborate defence of this claim in 8.23–32.) The relative past tense is used in one sense only, viz. to express the idea that the time of the situation referred to is T-simultaneous with a binding time which forms part of a past (or pseudo-past) domain or subdomain – see 2.44. The absolute past tense has two uses: in its basic (nonmetaphorical) use it locates a situation time in the past relative to t_0 , while in its metaphorical use it locates a situation time in the past relative to a post-present pseudo- t_0 . These different uses are illustrated by the following sentences:

He *didn't have* the time to do it. (*unmarked use of the absolute past tense*)

[If he doesn't do it] his explanation will be that he *didn't have* the time to do it. (*pseudo-absolute use, i. e. metaphorical use of the absolute past tense*)

He realized he *didn't have* the time to do it. (*unmarked use of the relative past tense expressing T-simultaneity*)

[If he doesn't do it] his explanation will be that (when he made his promise, he didn't realize that he *didn't have* the time to do it. (*relative past tense expressing T-simultaneity in a pseudo-past subdomain inside a post-present domain*)

9.23.2 The use of the present tense as pseudo-absolute tense is not based on the same kind of metaphor as we observe in *I'm leaving tomorrow*, where the present tense is also used to make it clear that the post-present situation time is treated as if it coincided with t_0 (see 2.20). In the case of the pseudo-absolute use of the present tense (e.g. [If you go there] *you will have to tell the security man why you want to be there*) there is clearly a shifted deictic centre relative to which the present tense locates a situation as 'present'. In *I'm leaving tomorrow* the present tense can be seen as locating the situation time at t_0 in order to be understood as 'arranged at t_0 '. These are two different metaphorical uses, and it is therefore not surprising that they can be combined, as in *He will say that he's leaving the next day*. (See 10.2.3 for further explanation.)

9.24 Subdomains and recursivity

It should be clear from the previous sections that some of the rules involved in the English tense system apply recursively. This is true, for example, of the rules for expanding a past domain. Once a past domain has been established, a relative tense that expresses a relation in this domain can be said to create a subdomain within the past domain. Any situation time introduced into a past domain is therefore potentially the central orientation time of a past subdomain, which is developed in exactly the same way as the over-all domain. This accounts for the fact (noted in 8.34) that the relative tense used for expressing

a particular T-relation in a past domain is always the same, irrespective of the location of the binding orientation time in the domain. For example:

John said that Bill had told him that he would resign if he did not get his way.

As shown in Figure 9.13, each of the tense forms here creates a past domain or subdomain. Each of the temporal relations in the domain is a relation between the central orientation time of a subdomain and the central orientation time of the (sub)domain into which it is temporally embedded.

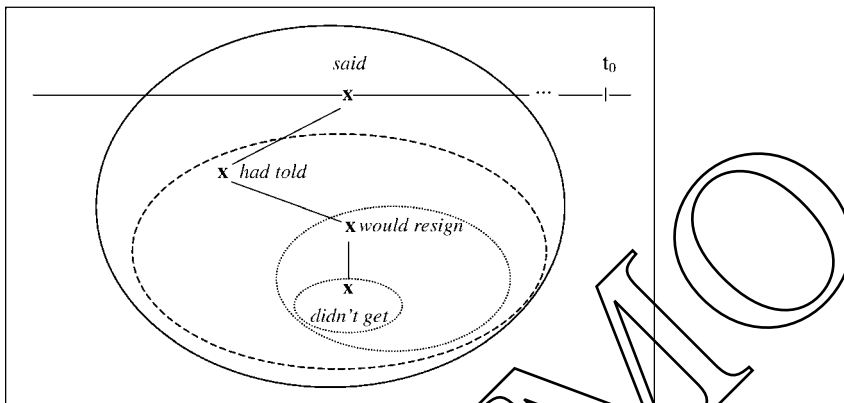

Figure 9.13. The tense structure of *John said that Bill had told him that he would resign if he did not get his way.*

There is also **RECURSIVITY** in post-present domains. The rule stipulating that the central orientation time of a post-present domain is treated as if it were t_0 applies recursively in the sense that an orientation time represented as coinciding with or posterior to that pseudo- t_0 is also treated as a pseudo- t_0 , and that the same is true of any other orientation time represented as T-simultaneous with or posterior to a pseudo- t_0 – see Figure 9.11 in section 9.21.

9.25 Relating a situation time to the situation time of a future perfect

As noted in 2.47, the future perfect is an ‘absolute-relative’ tense because it establishes a post-present domain and at the same time expresses anteriority in it. The anteriority in question is similar to either the anteriority to t_0 expressed by the absolute past tense or the anteriority to t_0 expressed by the present perfect. Compare:

John *left* at five.

[John will no longer be there at six because] he *will have left* at five.

John *has* already *left*.

By then John *will* already *have left*.

In the same way as *left* in *John left at five* establishes a past domain, *will have left* in the second example creates a pseudo-past subdomain in a post-present domain. And in the same way as *has left* in *John has already left* establishes a pre-present domain, *will have left* in the last example creates a pseudo-pre-present subdomain in a post-present domain.

Pseudo-past and pseudo-pre-present subdomains are expanded in exactly the same ways as true past and pre-present domains – see 9.18 and 19.19. This is clear from a comparison of the sentences in the following pairs:

- (a) Tim gave a fiver to whoever {*had paid / paid / would be paying*} a visit to his mother in hospital today. (*The head clause establishes a past domain.*)
- (b) [By tonight John will be broke.] He will have given a fiver to whoever {*had paid / paid / would be paying*} a visit to his mother in hospital today. (*The head clause establishes a pseudo-past subdomain.*)
- (a) Has the mayor ever been able to claim that he {*had helped / was helping / would help*} us? (*The head clause establishes an indefinite pre-present domain which is expanded as if it were a past domain.*)
- (b) I doubt that by the end of his office the mayor will ever have been able to claim that he {*had helped / was helping / would help*} us. (*The head clause establishes an indefinite pseudo-pre-present subdomain which is expanded as if it were a past domain.*)
- (a) Tom's father has known for some time that Jane and Tom *are* married. (*The head clause establishes a continuative pre-present domain; the that-clause establishes a present domain of its own.*)
- (b) [Once Jane and Tom are married and have gone off to Angola, we'll let Tom's father know that they are married.] By the time they come back, he'll have known for several months that they are married, [and with luck he'll have got used to the idea]. (*The head clause establishes a continuative pseudo-pre-present subdomain; the that-clause establishes another, W-simultaneous, subdomain.*)

F. The explanatory force of this analysis of tenses in post-present domains

Our analysis of the English tense system in post-present temporal domains offers a natural explanation for some tense phenomena which might seem puzzling at first sight.

9.26 Observation 1

9.26.1 The model of the English tense system that we have presented, and which hinges on the notion of temporal domain, neatly accounts for an interesting difference that we may observe between (1) and (2):

- (1a) John *had left* at 5 p.m.
- (1b) John *had left* when Bill *arrived*.
- (2a) John *will have left* at 5 p.m.
- (2b) John *will have left* when Bill *arrives*.
- (2c) [According to the plan, John will no longer be there at midnight. He will have left much earlier.] More specifically, he *will have left* when Bill *arrived*.

Sentence (1a) is ambiguous between two readings, which we can paraphrase as ‘It was the case that John had left – he left at 5 o’clock’ and ‘At 5 p.m. it was the case that John had already left’. (The latter interpretation is strongly invited if we give *at 5 p.m.* initial position in (1a), or when we insert *already* into *had left*.) Sentence (1b) is ambiguous in exactly the same way. (Compare *John was no longer there at five, because he had left when Bill arrived at four* with *John had already left when Bill arrived*.) Sentence (2a) is ambiguous too: *at 5 p.m.* again indicates (i. e. ‘contains’ – see 2.23.1)¹² either the situation time of John’s leaving or the orientation time to which that situation time is T-anterior. However, when we replace *at 5 p.m.* by a *when*-clause, as in (2b–c), we see that we cannot use the same tense form for both readings. If the *when*-clause is to indicate the time to which the situation time of John’s leaving is anterior, it must use the present tense (*arrives*). If it is to indicate the situation time of John’s leaving, it must use the past tense (*arrived*).

The theory that has been presented accounts for this difference between (1b) and (2b–c). In (1b) both situation times are located within the same past domain. The past perfect *had left* represents John’s leaving as T-anterior to some orientation time in that domain. *Arrived* can only be a relative preterite, since a shift of domain within the same absolute time-zone does not occur in adverbial *when*-clauses (except in two well-defined cases – see 13.15–16). Since the relative past tense can be used to express T-simultaneity with any orientation time in the past domain, it is not clear from the relative past form *arrived* whether Bill’s arrival is to be interpreted as T-simultaneous with the situation time of the head clause (i. e. the time of John’s leaving) or as T-simultaneous with the orientation time to which John’s leaving is anterior.

12. Since the Adv-time indicated by *at 5 p.m.* is punctual, ‘contains’ must be read as ‘coincides with’ – see 2.23.

Hence the ambiguity of (1b). In (2b–c) there is no such ambiguity because the reference is now to a pseudo-past subdomain within a post-present domain. In a post-present domain different verb forms are used to express T-simultaneity. To express T-simultaneity with the central orientation time (or with another pseudo- t_0) the present tense is used. This is the case in (2b) (= ‘When Bill arrives, John will already have left’), which uses *arrives* – see Figure 9.14.¹³ To express T-simultaneity with the central orientation time of a pseudo-past subdomain we use the relative past tense. This is the case in (2c), which uses *arrived* – see Figure 9.15. So, both the ambiguity of (1b) and the nonambiguity of (2b–c) are predictable from the theory.

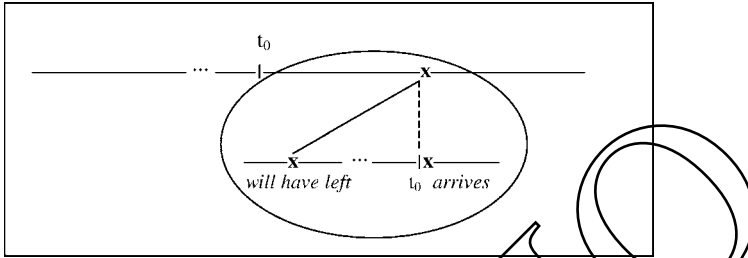

Figure 9.14. The temporal structure of *John will have left when Bill arrives*.

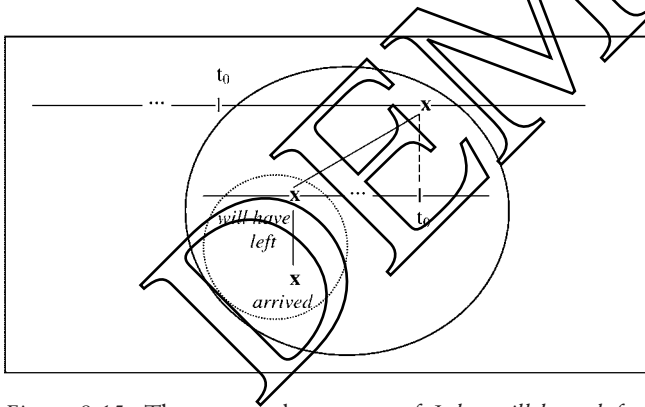

Figure 9.15. The temporal structure of *John will have left when Bill arrived*.

9.26.2 The above explanation also accounts for the different tense forms in the following:

I will thank you to wipe your feet when you *enter* the house. (A *to*-infinitive following *thank* refers to a posterior situation. The situation time of ‘to wipe your feet’ is

13. Figures 9.14 and 9.15 are simplified in that the complex temporal structure of *when* (explained in chapter 13) is disregarded.

therefore interpreted as a pseudo- t_0 , so that the *when*-clause uses the present tense to express coincidence.)

I will now thank you for wiping your feet when you *entered* the house. (Because *thank* is followed by *for*, the situation time of *wiping your feet* is interpreted as anterior to the time of the thanking, which is the central orientation time of a post-present domain and is therefore a pseudo- t_0 . The time of the wiping is therefore treated as a pseudo-past orientation time. *Entered* expresses T-simultaneity in the pseudo-past subdomain that is established in this way.)

[If you don't stand by him now,] he will never forget your abandoning him when he needed you.

9.27 Observation 2

9.27.1 In 9.18–19 it was shown how the past perfect can be used to represent its situation time as T-anterior to a pseudo-past or pseudo-pre-present orientation time which is T-anterior to the central orientation time (= pseudo- t_0) of a post-present domain. For example:

- (3a) [If you use the cover-story that you've come to check the lift as your way of getting into the building, how will you later explain the fact that you were still there six hours later?] The police will want to know why you didn't leave when you *had done* your work. (The situation time referred to by *didn't leave* is a pseudo-past orientation time; *had done* expresses T-anteriority to it.)
- (3b) [If you keep beating her she might go to the police, and then] the police will ask the neighbours if they have ever noticed that she *had been beaten up*. (The situation time referred to by *have noticed* is a pseudo-pre-present orientation time; *had done* expresses T-anteriority to it.)

However, examples can be found in which the past perfect is used (seemingly similarly) without there being any mention of a pseudo-past binding orientation time:

- (4a) [If you join our club,] you will know a lot about people that you *had* never dreamed of meeting before.
- (4b) [If a local pressure group can achieve results, the interest may gather momentum.] Individuals who *had* never considered taking part in public debate will be attracted to the success of certain ventures. (SEU)

What is intriguing is not only that the past perfect is used in these sentences, but also that it cannot be used in other, seemingly similar, sentences:

- (5a) If you peep through this hole in the curtain, you will see the audience that {*have* / **had*} come to watch the play.
- (5b) [Don't tell that joke to everyone you talk with this afternoon or you will not be able to use it during your public appearance tonight.] I will not have you telling a joke which you {*have* / **had*} already told several times.

If our analysis of the past perfect in (3a–b) is correct, we must assume that in (4a–b) the time of the situation described in the past perfect is each time located T-anterior to a pseudo-past orientation time which remains ‘unspecified’, i. e. it is neither a situation time nor an orientation time specified by a time-specifying adverbial nor an orientation time that is implicit in the semantics of a temporal conjunction – see 2.14. Moreover, we will have to explain why there is apparently no such unspecified pseudo-past orientation time in the tense structure of (5a–b).

9.27.2 The analysis we propose involves the following claims:

- (a) The past perfect forms in (3a–b) are instances of ‘the past version of a present perfect’. This means that these past perfect forms imply the existence of a period leading up to (but not including) a pseudo-past orientation time. (See the definition of ‘pre-present’ in 2.35.) The pseudo-past orientation time in question remains unspecified.
- (b) The past perfect forms in (4a–b) are instances of the past version of an *indefinite* present perfect. No examples can be found in which the past perfect receives a ‘continuative’ reading or an ‘up-to-now’ reading. (This is in keeping with the use of *before* and *never* in (4a–b), which trigger an indefinite perfect reading.)
- (c) When a durative situation has never actualized in a period up to t_0 but is actualizing at t_0 , the speaker can choose between the present perfect and the past perfect to refer to it:

I have never dreamed of meeting these people before. (before = ‘before t_0 ’)

I had never dreamed of meeting these people before. (before = ‘before I started meeting these people a short time ago’)

Sentence (4b) is fine because a durative full situation whose situation time is located at t_0 (and hence represented as punctual – see 3.1.1) must actually have started before t_0 . This means that the initial point of the full situation is anterior to t_0 and can therefore be treated as a past orientation time to which another situation time can be represented as T-anterior by the use of the past perfect.

- (d) In the same way, when a durative situation has never actualized in a period leading up to a post-present pseudo- t_0 but is actualizing at that post-present time, the speaker can choose between the present perfect and the past perfect to refer to it:

[If you join our club,] you will know a lot about people that you *have* never dreamed of meeting before. (before = ‘before the pseudo- t_0 , i. e. before the time of your knowing about these people’)

[If you join our club,] you will know a lot about people that you *had* never dreamed of meeting before. (*before* = ‘before the time when you will know a lot about these people as a result of meeting them’)

The second example is grammatical because a durative situation (viz. knowing a lot about people) whose situation time is located at a pseudo- t_0 (and hence represented as punctual – see 3.1.1) must actually have started before that pseudo- t_0 . This means that the initial point of the full situation is anterior to the pseudo- t_0 and can therefore be treated as a pseudo-past orientation time to which a situation time can be represented as T-anterior by the use of the past perfect.

(e) Because the past perfect requires that the initial point of the post-present situation function as a pseudo-past orientation time, i. e. as an orientation time that is past with respect to (and hence treated as disconnected from) the pseudo- t_0 , the past perfect is only possible if there is no link (other than the temporal one) between the situation referred to by the past perfect and the pseudo-past binding orientation time. This means that it is the present perfect that has to be used if the speaker is to express a resultative link between the anterior situation and what is the case at the pseudo-past binding orientation time.

The analysis outlined in (a)–(e) appears to account for the examples in (4). In (4a) [*If you join our club, you will know a lot about people that you had never dreamed of meeting before*], the situation of never dreaming of meeting certain people is represented as anterior to the beginning of the situation of knowing a lot about them, but there is no causative or resultative link between these two situations. In (4b) [*Individuals who had never considered taking part in public debate will be attracted to the success of certain ventures*], the situation of never considering taking part in public debate is represented as anterior to the beginning of the new situation (viz. the situation of people feeling attracted to the success of certain ventures) but does not have any bearing on the latter. Instead there is a sense of contrast between the two situations. (As a matter of fact, in each of (4a–b) there is a contrast between the situation referred to in the future tense and the situation referred to in the past perfect. Thus, in (4a) the post-present situation of knowing a lot about certain people is contrasted with the anterior situation of never having met those people before.)

However, things are different in (5). In (5a) [*If you peep through this hole in the curtain, you will see the audience that {have / *had} come to watch the play*], there is a resultative link between the anterior situation and the pseudo- t_0 at which the seeing is located: we interpret (5a) as ‘If you peep through this hole in the curtain, you will see the audience that are here to watch the play as a result of having come to watch the play.’ This resultative link means that the coming must be represented as anterior to the seeing and not as anterior

to a time which is treated as past with respect to the seeing. In other words, the condition for the use of the past perfect referred to in (e) is not satisfied. The past perfect would effectively represent the coming to see the play as anterior to the beginning of the seeing and represent the latter as past with respect to the rest of the situation of seeing. This divorcing of the coming and the seeing is not possible if there is to be a resultative link between the two. This is in keeping with the fact that the future situation of ‘seeing the audience that are here to watch the play’ does not contrast with the earlier situation of people having come to watch the play.

It should be noted, however, that the past perfect must be used if (5a) is modified in such a way that the idea of present result (viz. ‘the audience are hear to watch the play’) is cancelled:

If you peep through this hole in the curtain, you will see the audience that *{*have / had} come* to see the play talking among themselves and paying no attention to the actors.

In this context, the resultative idea ‘they are here to see the play’ is no longer valid at the time of *will see*. It is clear that the audience are not watching the play and have forgotten about their initial intention of doing so. The use of *had come to see the play* is therefore normal, both the coming to see the play and the resultant state of being in the theatre to see the play are anterior to (in the sense of ‘completely over at’) the post-present time of seeing the audience talking among themselves and paying no attention to the actors. It is therefore impossible to use the present perfect *have come to see the play* with its concomitant implication of ‘they are here to see the play’. This accords with the fact that there is a clear contrast between this anterior state and what is actually happening at the time referred to by *will see*.

Sentence (5b) (repeated here) can be accounted for in a similar way:

(5b) [Don’t tell that joke to everyone you talk with this afternoon or you will not be able to use it during your public appearance tonight.] I will not have you telling a joke which you *{have / *had}* already *told* several times.

Again we have to use the present perfect (*has told*) because the relative clause implies a resultative link between the anterior repeated telling of the joke and what is the case at the time of the pseudo- t_0 at which tonight’s telling is located: the intended interpretation is ‘I will not have you telling a joke which people will already be familiar with as a result of your having told it several times before.’ The past perfect cannot express this meaning, for it would represent the past telling as anterior to the beginning of the post-present telling, while treating that beginning as past with respect to the post-present telling itself. This intervening past orientation time excludes the possibility of a resultative interpretation.

The use of the past perfect in (4a–b) versus the use of the present perfect in (5a–b) is accompanied by further differences between the two types of sentences. To begin with, in (4a–b) the head clause in the future tense is each time positive while the relative clause in the past perfect is each time negative. It follows that there can be a contrast in interpretation between the future actualization of the head clause situation and the nonactualization of the same kind of situation in a period leading up to the beginning of that future actualization. In (5a–b) both clauses are positive, so that there is no sense of contrast between actualization and earlier nonactualization.

Secondly, the tenses in (4a–b) and (5a–b) reveal a difference of ‘**TEMPORAL FOCUS**’ (see 11.1.1). In both (4a–b) and (5a–b) the speaker makes a prediction and in doing so expresses his own point of view concerning the future. The fact that in (5a–b) he focuses on (i. e. is primarily concerned with) the post-present time of the resultant state expressed by the present perfect form is in keeping with this: the time focused on is the same time as the time about which a prediction is made. The only point of view that is taken in these sentences is therefore that of the speaker. In (4a–b), by contrast, the past perfect reveals a temporal focus on the pseudo-past orientation time to which the situation referred to in the past perfect is anterior. This means that, apart from expressing his own point of view about the post-present (by making a prediction), the speaker also assumes the temporal standpoint, and hence the point of view (see 11.3.2), of the person(s) participating in the post-present situation. Thus, in (4a) [*If you join our club, you will know a lot about people that you had never dreamed of meeting before*] the speaker expresses not only his own point of view (in that he makes a prediction) but also the viewpoint of an imagined ‘having-joined-the-club addressee’ potentially saying *I hadn’t dreamed of meeting these people before (= before I met them after joining the club)*. (Of course, this does not mean that the speaker actually attributes such a thought or utterance to the club-joiner; it just means that the speaker predicts that this thought could be entertained in the world envisaged from the point of view that the club-joiner would have in the predicted post-present world.)

9.27.3 Let us now have a look at the following examples:

- (6a) In future he will never again speak about a subject that he {*has* / **had*} not studied in detail.
- (6b) In future he will always speak about a subject that he {*has* / **had*} studied in detail.
- (6c) In future he will (always) speak about a subject that he {*has* / *had*} never spoken about before.
- (6d) In future he will never again speak about a subject that he {*has* / *?had*} never spoken about before.

In (6a–b) the present perfect (*has studied*) has to be used because there is a resultative link to be communicated: the intended readings are as follows:

‘He will never again speak about a subject that he is not familiar with as a result of having studied it in detail.’

‘He will always speak about a subject that he knows well as a result of having studied it in detail.’

In (6c) both the present perfect (*has spoken*) and the past perfect (*had spoken*) are in principle possible because there are two interpretations that make sense, viz. the following:

(6′) ‘He will always speak about a subject that is new because it will (each time) be the case that he has not spoken about it yet.’

(6″) ‘He will take up the habit of speaking about a subject that he had not spoken about (before taking up the habit in question).’

The former interpretation requires the present perfect form *has spoken* in (6c) and implies that there are various subjects that will be treated.¹⁴ Interpretation (6c″) is conveyed by the past perfect *had spoken*. On this reading, the situation time of the situation of not speaking about the subject is located before the beginning of the post-present habitual situation. The implication now is that it is the same subject that will be treated on the various future occasions of speaking. It follows that the resultative idea ‘Each instance of speaking will concern a new subject’ is absent here.

In (6d) the former type of interpretation (viz. ‘He will never again speak about a subject that is new’) makes sense, but the latter kind of interpretation (‘He will never again take up the habit of speaking about a subject that he had never spoken about (before taking up the habit)’) is more complex and apparently more difficult to process and contextualize. Hence the lower acceptability of the past perfect.

9.27.4 One of the corner-stones of the above analysis is the observation that in order to relate a situation time to the central orientation time of a post-present domain we use the same tenses as we use to relate a situation time to t_0 . This means that the use of the present perfect *vs* the past perfect in the above examples should not be affected if we replace the future tense in the head clause by the present tense. This prediction appears to be borne out, as we see when we consider the examples in (7), which are quite similar to the

14. In this case the post-present situation is of the repetitive (or habitual) kind. It consists of a number of subsituations, each of which can be described in terms of ‘He will speak about a subject that is new because he has not spoken about it before’. (Semantically this is similar to what we observe in *Each time he speaks about a subject in future, he will not have spoken about it before.*)

examples given so far, except that the head clause refers to the present, and not to the post-present:

- (7a) Thanks to this club I now know a lot about people that I {*had* / **have*} never dreamed of meeting before.
- (7b) [Our local pressure group is achieving results and the interest is gathering momentum.] Individuals who {*had* / **have*} never considered taking part in public debate are now being attracted to the success of certain ventures.
- (7c) Through this hole in the curtain you can see the audience that {*have* / **had*} come to see the play. (*The past perfect is unacceptable because there is to be a resultative link.*)
- (7d) He is again telling that joke which he {*has* / **had*} already told several times. (*idem*)
- (7e) He never speaks about a subject that he {*has* / **had*} not studied in detail. (*idem*)
- (7f) He always speaks about a subject that he {*has* / **had*} studied in detail.
- (7g) This year he (always) lectures on a subject that he {*has* / *had*} never spoken about before.
- (7h) This year he never lectures on a subject that he {*has* / **had*} never spoken about before.

These sentences (and their interpretations) run completely parallel to what we have observed in connection with the examples in (2)–(6). For example, in (7g) (which runs parallel to (6c)), the present perfect yields reading (7g'), while the past perfect yields reading (7g''). These interpretations resemble (6c') and (6c'') in that the former implies that the subjects treated are each time different, whereas the latter implies that the speaker each time deals with the same subject.

- (7g') 'This year he always lectures on a subject that is new because it is (each time) the case that he has not lectured on it yet.'
- (7g'') 'This year he has taken up the habit of lecturing on a subject that he had not lectured on (before taking up the habit in question).'

Similarly, in (7h) the present perfect suggests the interpretation 'This year he never lectures on a subject that is new', whereas the past perfect suggests the (somewhat less accessible and less plausible) interpretation 'This year he never takes up the habit of lecturing on a subject that he had never lectured on (before taking up the habit)'.

The following are attested examples similar to the ones in (7) combining a past perfect with a present tense:

- (*stage direction*) The procession music, which *had been allowed* to fade out, *is brought up* by the opening of the study door. (JUMP) (*This is to be read as 'At this*

point, the music which had, prior to the interval immediately preceding now, which was without music, been allowed to fade out, comes gradually back.' This implies that it is not until the music comes back 'up' that we realize that there has been an interval with no music, precisely because the music faded out rather than being cut off in an intrusive way, and we have been absorbed in the drama and not noticed its absence.)

Food for the party is now *being cooked* in the English style – after team manager Walter Winterbottom *had gone* into the hotel kitchen to instruct the chef. (TCIE) (*This can only make sense if read as 'Food for the party is now being cooked in the English style. They began doing so after team manager Walter Winterbottom had gone into the hotel kitchen to instruct the chef.'*)

9.27.5 It should be clear, then, that the possibility of using a past perfect in a subclause depending on a head clause locating its situation time in the present or post-present depends on the possibility of treating the beginning of the present or post-present situation as a time that is past with respect to the rest of the situation. We have observed that this possibility is excluded if there is a resultative link between the two situations. This does not mean, however, that it is always available when there is not such a link. In fact, when there is no link of result (or, more generally, relevance) between the two situations we often have to use the past tense or present perfect to refer to the anterior situation because 'anteriority to t_0 or to a pseudo- t_0 ' is unmarked with respect to 'anteriority to an unspecified orientation time that is anterior to t_0 or to a pseudo- t_0 '. The latter option is only selected if there is some positive reason to do so.

He is now reading the book that I {*gave / have given / *had given*} him.

He will be reading the book that I {*gave / have given / *had given*} him.

The clearest examples in which the past perfect is used are those in which the past tense will not be used because the conditions for using a perfect form are satisfied, and in which the perfect form in question cannot be a present perfect because the meaning of this tense is incompatible with the context. Compare:

(8a) His popularity *is* so immense that some people who {*had / *have*} never *been* to the opera now go regularly, just to hear him sing.

(8b) His popularity *is* so immense that I predict that some people who {*had / have*} never *been* to the opera will go regularly, just to hear him sing.

In both cases a perfect form is called for because *never* is interpreted as 'never in a time span leading up to [some orientation time]'. As noted in connection with the present perfect, it is typically one of the perfect tenses that is used to locate a situation time in such a time span. If we use the present perfect, the situation time is located in a time span that leads up to t_0 (as in *I have never been to the opera*). In (8a) this use of the present tense is unacceptable because

the meaning of *have never been to the opera* clashes with the statement that the people in question now go to listen to 'him' *regularly* in a short period, which implies that these people have already been to the opera. In (8b), on the other hand, the present perfect is not impossible because we can interpret *never* as 'never up to t_0 ', which does not clash with the idea of a future habit. However, the present perfect is not possible if *never* is to be interpreted as 'never up to then'.

It follows that a past perfect of this kind will never receive a continuative interpretation: in this reading the situation continues into the relevant orientation time rather than coming to an end at the (past) time when the situation holding at the relevant orientation time began to hold. Compare:

People who *have lived* in London for many years will regularly attend these meetings.

People who *had lived* in London for many years will regularly attend these meetings.

In the former example, *have lived* receives a continuative interpretation: the people in question will still be living in London when they attend the meetings. In the second example, by contrast, *had lived* is interpreted as an indefinite past perfect: the people in question will no longer be living in London at the time when they attend the meetings.

9.27.6 In conclusion, we can say that an explanation has been offered for the observation that a subclause depending on a head clause in the present or future tense may sometimes use the past perfect instead of the present perfect. The explanation is that the past perfect functions as an instruction to look for a suitable past orientation time, to which the situation time can be interpreted as being anterior. If the head clause refers to the present or the post-present and there is no contextually given past orientation time, it is the beginning of the head-clause situation that is interpreted as being the past or pseudo-past orientation time in question. (Self-evidently this is only possible if the head clause situation has a certain duration, so that its beginning can be seen as past with respect to the rest of the situation. In many cases it is of the habitual kind.)

V. Direct and indirect binding

9.28 Definitions

When a subclause is temporally subordinated to its own head clause, we speak of ‘direct binding’. When a subclause is not T-bound by its own head clause but by a syntactically higher clause which T-binds that head clause, we speak of ‘indirect binding’. Indirect binding is subject to severe constraints.

9.28.1 In section 8.21.1 it was pointed out that, when two clauses follow each other, the situation time of the second clause may or may not be bound by (i. e. temporally subordinated to) the situation time of the first clause. If its situation time is not bound by it, it is related to t_0 , which means that the tense form used establishes a new temporal domain. The two possibilities (binding or shifting the domain) are illustrated by the following sentences:

The woman has told her friends once or twice that she *was* afraid to go home because her husband *would* perhaps *be* drunk and *knock* her about. (*All the subclause situation times are temporally subordinated.*)

John has been expelled from the club because he *has behaved* badly. (*shift of domain*)

When the situation time is T-bound in a past domain, there are sometimes two possibilities as to the choice of binding time. Compare the following, in which the past perfect forms in the head clauses are the past counterparts of the present perfects in the head clauses of the preceding examples:

[The police knew that] the girl *had told* her friends once or twice that she *was* afraid to go home because her husband *would* perhaps *be* drunk and *knock* her about.

[Mary knew that] John *had been expelled* from the club because he *had behaved* badly.

The first of these examples illustrates what we will call **DIRECT BINDING**: the situation time of each subclause is temporally subordinated to the situation time of its own head clause (= syntactically superordinate clause). This means that the situation time of *she was afraid* is represented as T-simultaneous with the situation time of the first *that*-clause (whose verb is *had told*), which is itself represented as T-anterior to the situation time of the matrix clause (= the highest clause in the syntactic tree structure, which in this case is the clause establishing the domain). The fact that the situation of the second *that*-clause (= the being afraid) is also interpreted as W-anterior to that of the matrix clause is not expressed by its tense form (*was afraid*). In the second example,

temporal subordination happens differently: here not only the situation time of the *that*-clause but also the situation time of the (more deeply embedded) *because*-clause is represented as T-anterior to the situation time of the matrix clause. There is therefore no expression of the T-relation between the situation times of the two subclauses. This means that only the *that*-clause is bound directly (i. e. bound by its own head clause). The *because*-clause is **BOUND INDIRECTLY** (i. e. its situation time is temporally subordinated to the situation time of a clause which is not its own head clause). This kind of tense structure is shown by Figure 9.16. (The wavy line represents the W-simultaneity relation that is not linguistically expressed.)

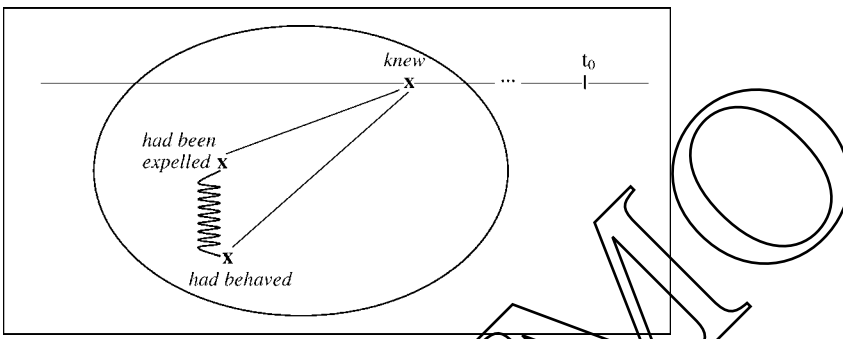

Figure 9.16. The tense structure of *Mary knew that John had been expelled from the club because he had behaved badly.*

9.28.2 As appears from the following examples, there are constraints on both direct and indirect binding:

- (9a) We expected that Elsie would still be in bed when we {*arrived* / **would arrive*}. (*W-posterior reading; only direct binding is possible: the binding orientation time has to be the situation time of would be, not that of expected.*)
- (9b) We hoped that the kidnappers would release the girl after the ransom {*had been paid* / **would have been paid*}. (*Only direct binding is allowed: the binding situation time has to be the situation time of would release, not the situation time of hoped.*)¹⁵
- (10a) [She was determined to buy the house.] She had fallen in love with it the moment she *saw* it. (*W-simultaneous reading; saw effects direct binding.*)

15. Remember that the conditional tense expresses one T-relation, which is, however, 'complex' in that it combines the idea 'The situation time is anterior to an orientation time' and 'That orientation time is posterior to another orientation time in a past domain' (see 9.7).

- (10b) [She was determined to buy the house.] The moment she *had seen* it she had fallen in love with it. (*W-simultaneous reading; had seen effects indirect binding.*)
- (11a) I promised that some day I would tell the news to John, who {*would be / #was*} interested to hear it. (*W-posterior reading; only indirect binding is possible on the intended interpretation.*)
- (11b) What we hoped was that the next day we would be freed by the police, who {*would have been / *had been*} notified by then. (*Only indirect binding is allowed: the binding situation time has to be the situation time of hoped, not the situation time of would be freed.*)
- (12a) Many years before, she had given the money to someone who *needed* it more than she *did*. (*W-simultaneous readings; direct binding*)
- (12b) Many years before, she had given the money to someone who *had needed* it more than she *had done*. (*W-simultaneous readings; indirect binding*)

What we notice is that whereas the adverbial time clauses of (9a–b) must be bound directly, those in (10) may be bound either directly, as in (10a), or indirectly, as in (10b). The nonrestrictive relative clauses in (11) must be bound indirectly, while the restrictive relative clause in (12) allows the two possibilities. This means that the speaker cannot always choose freely between direct and indirect binding: the choice depends in the first place on the kind of clause that is used to describe the bound situation.

It is also worth noting that the sentences in (9), (11) and (12) are the exact past time-sphere counterparts of the following sentences, which locate the situation times in the present time-sphere:

- (13a) We expect that Elsie will still be in bed when we {*arrive / *will arrive*}. (*W-simultaneous reading; direct binding is obligatory; shifting the domain by using the future tense is ungrammatical.*)
- (13b) We hope that the kidnappers will release the girl after the ransom {*has been paid / *will have been paid*}. (*W-anterior reading; direct binding is obligatory; shifting the domain by using the future perfect tense is ungrammatical.*)
- (14a) I promise that some day I will tell the news to John, who {*will be / *is*} interested to hear it. (*W-simultaneous reading; shifting the domain by using the future tense is obligatory; direct binding is ungrammatical.*)
- (14b) What we hope is that tomorrow we will be freed by the police, who {*will have been / *have been*} notified by then. (*W-simultaneous reading; shifting the domain by using the future tense is obligatory; direct binding is ungrammatical.*)
- (15a) By the end of this week she will have given the money to someone who *needed* it more than she *did*. (*W-simultaneous readings; direct binding*)
- (15b) By the end of this week she will have given the money to someone who *will have needed* it more than she *will*. (*W-simultaneous readings; the future perfect forms create post-present domains of their own.*)

As is clear from the comments added to (9)–(15), these examples do not show that the system of tenses for direct *vs* indirect binding in a past domain parallels the system of tenses for direct *vs* indirect binding in a post-present domain. What they do show is the following. Firstly, there is a perfect parallelism between past and post-present domains as far as direct binding is concerned: the forms expressing direct binding in a past domain are the past counterparts of the forms expressing direct binding in a post-present domain. Secondly, there is a perfect parallelism between indirect binding in a past domain and the use of the future tense or future perfect to establish a post-present domain. In other words, direct and indirect binding in a past domain parallel the use of the ‘PSEUDO-T₀-System’ and the ‘ABSOLUTE FUTURE SYSTEM’, respectively, when the reference is to the post-present – see 10.1 and 10.2.

9.28.3 Up to now we have only given examples of indirect binding in a past domain. The phenomenon is obviously not to be observed in present domains, which do not allow binding at all: any relation to t_0 is expressed by an absolute tense (see 9.14). In pre-present domains, indirect binding can be observed only when the pre-present domain is expanded as if it were a past one, as in the following example:

Have you ever treated a woman who had broken an ankle as she {*had stepped / stepped*} out of her car? (*Had stepped* relates its situation time to the situation time of *have treated* rather than to the situation time of *had broken*; in doing so it effects indirect binding. For direct binding we use *stepped*, which represents the situation of stepping out of the car as T-simultaneous with the situation of breaking an ankle. With *had stepped*, the latter two situations are interpreted as W-simultaneous without being represented as T-simultaneous with each other.)

The following examples illustrate direct and indirect binding (respectively) in a subdomain of a post-present domain:

Some day you will announce that Blackwell will publish a book of yours that *has taken* you three years to write. (*direct binding: has taken* is a pseudo-absolute tense form which represents the writing as T-anterior to the situation time of *will publish*.)

Some day you will announce that Blackwell will publish a book of yours, which *will have taken* you years to write. (*indirect binding: will have taken* is a pseudo-absolute-relative tense form which T-relates the writing to the situation time of *will announce* rather than to the situation time of *will publish*.)¹⁶

16. Like the conditional tense (see the previous footnote), the future perfect expresses one T-relation, which is, however, ‘absolute-relative’ in that it combines the idea ‘The situation time is anterior to an orientation time’ (= the relative part) and ‘That orientation time is posterior to t_0 ’ (= the absolute part) – see 2.47.

9.29 The distribution of direct and indirect binding

9.29.1 As noted in 9.28.2, the past counterpart of the choice between the present tense expressing T-simultaneity in a post-present domain (on the one hand) and the future tense or future perfect establishing a post-present domain (on the other) is the choice between the relative past tense (expressing T-simultaneity), on the one hand, and the conditional tense or conditional perfect (effecting indirect binding), on the other. It follows that the distribution of the tenses in the latter option will be the same as the distribution of the tenses in the former option. This was already illustrated in section 9.28.2, where we noted the complete parallelism between (9) and (11)–(12) on the one hand and (13)–(15) (respectively) on the other. (The distribution of the tenses in (14)–(15) will be discussed in more detail in chapter 10.)

9.29.2 As far as the past perfect expressing indirect binding in a past domain is concerned, we notice first of all that it is used in the same clause types as those which use a verb form establishing a post-present domain (rather than expressing T-simultaneity in such a domain) and make use of indirect binding by means of *would* or *would have* rather than of direct binding in a past domain by means of the relative past tense. This is the case in independent clauses and in such subclauses as result clauses, nonrestrictive relative clauses, (*al*)*though*-clauses, clauses expressing a ‘closed’ condition, etc. (see 10.8):

[She was let in by the janitor.] The latter had closed the door and *had had to* get out of his bed when she rang the bell.¹⁷ (*independent clause*)

The house in question, which he *had visited* the day before, had instantly pleased him. (*nonrestrictive relative clause*)

He boasted that he *had never been* afraid in his life, though he *had found* himself in a lot of dangerous situations. (*though-clause*)

If, as you say, he *had never worked* in his life, he had never earned any money. [So, how had he managed to survive?] (*clause expressing a closed condition*)

She said that the previous summer she had been to Italy for a brief visit to a friend who had been spending her holidays in Sienna. (*In a restrictive relative clause like this, direct binding by means of the relative past tense (was spending) is also possible.*)

9.29.3 However, there are two extra uses of the past perfect for indirect binding. Firstly, indirect binding can be found in adverbial time clauses introduced by a conjunction whose unmarked interpretation is that of W-simultaneity, viz.

17. If we used *had to* instead of *had had to*, we would be using an absolute past tense form (creating a new past domain) rather than a relative past tense form. This would mean that the relevant situation time would not be bound at all, neither directly nor indirectly.

while, when and *as*.¹⁸ Thus, in the following examples the past perfect expresses indirect binding, while the past tense expresses direct binding (T-simultaneity):

The police said the man had waited in the car while the others {*had robbed / robbed*} the bank. Penelope had been biting her nails while she {*had been waiting / was waiting*}.

He had considered, as he {*had walked / walked*} back to the hotel, what he should do next.

As he {*had walked / walked*} back to the hotel, he had considered what he should do next.

Secondly, in ‘past represented speech’ (see 8.25.1) examples can be found in which the past perfect expresses indirect binding in the complement clause of cognition verb (verb of thinking):

[Every time that Nick’s name was brought up, she relived the moment that she had woken up beside Aj, relived the second that] she had known that she *had been pregnant* [and re-cried all of the tears that she had shed when she realized what she must do.] (www)

I had known that she *had been* sick for some time but put off calling her. (www)

[He couldn’t bear to tell me that] the whole village had known that he *had been carrying on* with a local teacher. (www) (*The context makes it clear that this is to be understood as equivalent to ... the whole village had known that he was carrying on with a local teacher, in which was carrying on expresses T-simultaneity and is therefore an instance of direct binding.*)

[In an interview with a Los Angeles TV station, she said that] she had been aware that her mother *had been* at her bedside. (www) (from an article on a girl who has woken from a coma) (*Had been at her bedside is naturally interpreted as W-simultaneous with had been aware: while her mother was at her bedside she was conscious of the fact of her being there. The reading in which she was aware of her mother’s having been at her bedside at some earlier time is possible but less plausible.*)

[As reported by Wednesday’s Los Angeles Times, Nasso’s attorney said that] he had been aware that Seagal *had been talking* to a federal grand jury. (www) (*The W-simultaneity reading is at least a possible one.*)

[Recently I stopped in at the workplace of a consumer so that we could discuss some mutual concerns.] I had known that she *had been having* some difficulty with her eyesight, [but I hadn’t realized the extent of it until I walked into her darkened office. Light bothers her, and she wears different pairs of dark glasses for different

18. In the same way as adverbial time clauses do not normally allow the future tense (see 10.3.2), they do not normally allow indirect binding by means of the conditional or conditional perfect. Still, occasional exceptions can be found:

(i) ... so I suggested she should come down the week-end after Christmas while the family *would still be* there. (FFFP)

situations.] (www) (*Had been having* refers to a situation that is W-simultaneous with that of *had known*. A W-anteriority interpretation would be very odd since it is evident from the context that the difficulty continues and there is no indication that the speaker thought at some time that the difficulty had ceased prior to the knowing.)

In the above examples, the reporting verb is each time a cognition verb (*know, feel, be aware*). We have not found any examples with indirect binding in a *that*-clause depending on a verb of communication (*say, tell, hear ...*). This is in keeping with the fact that the italicized past perfects in the following examples can only be interpreted in terms of W-anteriority:

[Nasso's attorney said that] he had {told / informed} his colleague that Seagal *had been talking* to a federal grand jury.

I had heard that she *had been* sick for some time [but had put off calling her].

The use of *was having*, rather than *had been having*, in the following example is in keeping with the above observation:

[Recently I stopped in at the workplace of a consumer so that we could discuss some mutual concerns.] I had {heard / been told} that she {*was having* / #*had been having*} some difficulty with her eyesight, [but I hadn't realized the extent of it until I walked into her darkened office. Light bothers her, and she wears different pairs of dark glasses for different situations.] (*Had been having* is not ungrammatical here, but it receives a 'co-extensive interpretation' – see §2.2 – in which the situation time leads up to the time of the speaker's learning about the difficulty. However, this interpretation is hardly reconcilable with the context that follows.)

DRAFT

VI. Summary

9.30 The expression of T-relations in a past domain

9.30.1 T-anteriority in a past domain is expressed by means of the past perfect, irrespective of whether the binding time is the central orientation time or another orientation time within that past domain.

She said that John *had told* her that he *had done* it all by himself. (*The past perfect form had told represents its situation time as T-anterior to the central orientation time, namely the situation time of said, while had done represents its situation time as T-anterior to another orientation time, namely the situation time of had told.*)

There are some grammatical environments, subject to further conditions, in which the absolute past tense alternates with the past perfect, in which case the inferred anteriority relation is a matter of W-interpretation rather than T-representation. Of particular note are *after*-clauses, *head*-clauses of a *before*-clause, and *since*-constructions:

He retired soon after he {*turned* / *had turned*} sixty.

Some students {*had left* / *left*} before the lecture ended.

The tree had grown a lot since it {*had been* / *was*} planted.

9.30.2 T-simultaneity in a past domain is expressed by means of the relative past tense, irrespective of whether the binding time is the central orientation time or another orientation time in that past domain.

Were you there when John *announced* that he would retire from business when he *was* sixty, [which is in two years' time:] (*The past tense form announced represents its situation time as T-simultaneous with the central orientation time, namely the situation time of were, while was represents its situation time as T-simultaneous with another orientation time, namely the situation time of would retire. As we argued in chapter 8, the fact that this latter orientation time happens to lie after t_0 is important theoretically, since it demonstrates the need for positing the existence of the relative past tense, distinct from the absolute past tense.*)

9.30.3 T-posteriority in a past domain is expressed by means of the conditional tense (i. e. '{*would* / *should*} + present infinitive') or by means of the past tense of a 'futurish form', irrespective of whether the binding time is the central orientation time or another orientation time within that past domain. The choice of a form to express T-posteriority depends on the precise meaning which is to be expressed.

He promised that he *would* soon *tell* her when he *would* *make* his decision. (*The conditional tense form would tell represents its situation time as T-posterior to the*

central orientation time, namely the situation time of promised, while would make represents its situation time as T-posterior to another orientation time, namely the situation time of would tell.)

[Anxiously, he looked at the clouds.] There *was going to be* a storm within minutes. (Free indirect speech; the situation is not only posterior to but also predictable at a past orientation time)

He told me he *was leaving* the next day.

9.30.4 The ‘complex temporal relation’ of anteriority to an orientation time which is itself posterior to some other orientation time in a past domain is expressed by means of the conditional perfect tense (‘{*would / should*} + perfect infinitive’), irrespective of whether this latter orientation time is the central orientation time or yet another orientation time within the past domain.

Bill (had) promised that he *would have finished* by the end of the day. (The conditional perfect tense form would have finished represents its situation time as T-anterior to an orientation time, which is interpreted here as being the time indicated by the end of the day, and this orientation time is represented by the same tense form as T-posterior to another orientation time, namely the time of the promising. This latter time is the central orientation time if the tense form is promised; it is an orientation time which is represented as itself T-anterior to an implicit central orientation time if the tense form is had promised.)

9.31 The expression of T-relations in a pre-present domain

9.31.1 If the pre-present domain is established by an indefinite perfect (which is the case when the pre-present situation time, as well as the time of the full situation, is interpreted as lying completely before t_0 rather than as leading up to it), it can be expanded as if it were a past domain. This means that there is a shift of temporal perspective: the pre-present central orientation time is treated as if it were a past orientation time, to which other situation times can be T-related by means of the same tenses as are used in past domains. For example:

The former prime minister has never admitted that he *had misled* the public when he *promised* he *would create* a modern welfare state.

A pre-present domain is not normally expanded by means of such a shift of perspective if the pre-present situation receives a recency (e.g. a ‘hot news’) interpretation. In that case, the speaker usually shifts the domain by using an absolute tense in the added subclause:

Hey guys, I’ve just been told that the boss {*will / ??would*} come round this afternoon.

9.31.2 If the pre-present domain is established by an up-to-now perfect (which is the case when the situation time fills the entire pre-present but does not include t_0), there are in principle two possibilities in the subclause: temporal subordination (involving a shift of temporal perspective to the past zone) or a shift of domain. The former possibility can only occur when the speaker can discern enough ‘pastness’ in the up-to-now situation expressed in the head clause to expand the pre-present domain as if it were a past domain. The latter possibility occurs when the up-to-now situation is given a recency interpretation. For example:

For all these years, I have been wrongly thinking that I {was doing / had been doing / would do} well to stay a bachelor. (*shift of temporal perspective from the pre-present zone to the past zone*)

I’ve just been telling him that he {is doing / has been doing / will do} well to stay a bachelor. (*shift of domain*)

9.31.3 If the pre-present domain is established by a continuative perfect (which is the case when the time of the full situation includes t_0), shifting the domain is the rule, with only few exceptions:

I’ve known since last week that Jim {has passed all his exams / is seriously ill / will marry next year}. (... {#had passed all his exams / #was seriously ill / #would marry next year} are possible if the situation times of the complement clauses are T-related to an unspecified past orientation time belonging to the complement clause situation, not if they are directly T-related to the pre-present situation time of the head clause.)

[I watched Oprah today and George Michael was on there and I enjoyed his interview.] I have known for some time that he *was* gay [but you know he is still sexy]. (www) (*pragmatically motivated exception – see 9.12*)

9.32 The expression of T-relations to a present orientation time

Expressing a temporal relation to the time of a situation located in the present zone is tantamount to relating a situation time to t_0 . Since expressing a temporal relation to t_0 is done by means of an absolute tense form, this means that a new domain is created, i. e., that there is a shift of domain. In other words, temporal subordination to a present situation time by means of a relative tense form is not possible:

I know you {are lying / have already lied before / will lie again}. (*Each tense in the subclause establishes a new domain.*)

9.33 The expression of T-relations in a post-present domain

9.33.1 T-relations in a post-present domain are expressed by tenses resulting from a shift of perspective. The speaker treats the post-present central orientation time as if it were t_0 and uses a **pseudo-absolute tense** form to T-relate another situation time to this **pseudo- t_0** , thus locating it in any of the four possible **pseudo-absolute zones** (e. g. the ‘pseudo-past zone’, the ‘pseudo-pre-present zone’, etc.). The pseudo-absolute tenses are the same as are used to express T-anteriority, T-simultaneity or T-posteriority to the real t_0 , namely the absolute past tense or the present perfect, the present tense and the future tense (or a futurish present tense form), respectively. For example:

The police will find out that you *were staying* here today, and not in London. (T-anteriority to a post-present pseudo- t_0)

Who will look after you when Brad and Sybil *have left*? (T-anteriority to a post-present pseudo- t_0)

[If you leave the country] the police will never find out where you *are*. (T-simultaneity with a post-present pseudo- t_0 ; T-simultaneity with a post-present pseudo- t_0 can be of the ‘sloppy’ kind, as in When John comes home, I will tell him about the accident.)

He will swear that he *will never tell* her the ugly truth. (T-posteriority to a post-present pseudo- t_0)

9.33.2 The pseudo-absolute subdomains created by the pseudo-absolute tenses can be further expanded in exactly the same way as genuine absolute domains can be expanded. For example:

[If they ask me to have my personal opinion,] I will simply say that the former prime minister has never admitted that he *had misled* the public when he *promised* he *would create* a modern welfare state. (The present perfect tense form has admitted creates a pseudo-pre-present subdomain, in which T-relations can be expressed by means of the same tenses as are used to expand a real pre-present domain. This is done by treating the pseudo-pre-present time of orientation as if it were a past time of orientation – see. 9.31.1)

The same goes for the pseudo-past or pseudo-pre-present subdomain established by the anteriority part of the future perfect. For example:

[Of course, the former prime minister has now still an important political role to play, but I am sure that even on his death bed] he will not have admitted once in his entire life that he *had misled* the public when he *promised* he *would create* a modern welfare state.

9.34 Direct and indirect binding

9.34.1 When a subclause is temporally subordinated to its own head clause, we speak of ‘**direct binding**’. When a subclause is not T-bound by its own head clause but by a syntactically higher clause which T-binds that head clause, we speak of ‘**indirect binding**’. Compare:

[The police knew that] the girl *had told* her friends once or twice that she *was* afraid to go home ... (*The situation time of the clause with was is bound directly by situation time of the clause with had told*)

[Mary knew that] John *had been expelled* from the club because he *had behaved* badly. (*The situation time of the clause with had behaved is bound indirectly by the situation time of the clause with knew*.)

9.34.2 There is a parallelism between the choice between direct and indirect binding in a past domain and the use of the ‘**PSEUDO-T₀-SYSTEM**’ and the ‘**ABSOLUTE FUTURE SYSTEM**’, respectively, in a post-present domain – see also chapter 10). Compare the first three sentences of the following set (with the last three:

We expected that Elsie would still be in bed when we {*arrived* / **would arrive*}. (*Direct binding is obligatory.*)

I promised I would tell the news to John, who {**was* / *would be*} interested to hear it. (*Indirect binding is obligatory.*)

She had been to London for a brief visit to a niece of hers who {*was staying* / *had been staying*} at the Savoy. (*Direct and indirect binding are both allowed.*)

We expect that Elsie will still be in bed when we {*arrive* / **will arrive*}. (*The Pseudo-t₀ System is obligatory.*)

I promise I will tell the news to John, who {**is* / *will be*} pleased to hear it. (*The Absolute Future System is obligatory.*)

She has been to London for a brief visit to a niece of hers who {*is staying* / *has been staying*} at the Savoy. (*Both the Pseudo-t₀ System and the Absolute Future System are allowed.*)

DEMO

10. Two tense systems with post-present reference

I.	Introduction	531
10.1	The Absolute Future System	531
10.2	The Pseudo- t_0 -System	533
10.3	Outline of the distribution of the two systems	535
II.	Theoretical analysis of the Absolute Future System and the Pseudo- t_0 -System	537
10.4	Characteristics of the two systems	537
10.5	Summary of part II	547
III.	Factors determining the choice between the two systems	548
10.6	Subclauses that allow either system	548
10.7	Subclauses which as a rule use the Pseudo- t_0 -System to refer to the post-present	559
10.8	Subclauses which cannot use the Pseudo- t_0 -System	566
IV.	Further remarks	568
V.	Summary	570

D E M O

Abstract

This chapter deals with two systems of tenses that can be used to refer to situations in a post-present domain. These two systems are referred to as the ‘Absolute Future System’ and the ‘Pseudo- t_0 -System’. The Absolute Future System consists of tenses that establish a post-present domain, most notably the future tense (used as an absolute tense) and the present tense of ‘futuristic’ forms (e.g. *I’m leaving tomorrow*). The Pseudo- t_0 -System is made up of tenses that express temporal relations within an already established post-present domain. Thus, in *I will be home before it is dark*, the head clause establishes a post-present domain using a tense form

that is part of the Absolute Future System, whereas the subclause expresses simultaneity within this domain using a tense form belonging to the Pseudo- t_0 -System.

Part I (= sections 10.1–3) introduces each system in turn and ends with a brief overview of their distribution. A fuller discussion of clauses that either allow, require or exclude a system is to be found in part III (= sections 10.6–8).

Meanwhile, part II is devoted to the more theoretical characteristics of each post-present tense system.

A summary of chapter 10 is given in part IV.

DEMO

I. Introduction

There are two systems of tenses that can be used to talk about post-present situations: the Absolute Future System and the Pseudo- t_0 -System. The basic difference between them is that tenses from the former relate the situation time to t_0 , whereas tenses from the latter relate it to a post-present orientation time which is treated as if it were t_0 . From this it follows that an Absolute Future System form creates a post-present domain, whereas the Pseudo- t_0 -System expresses a relation in an already existing domain.

10.1 The Absolute Future System

10.1.1 The **ABSOLUTE FUTURE SYSTEM** (called *Future Perspective System* in Declerck's earlier work)¹ is the system of verb forms that can be used to establish a post-present domain. This system comprises the future tense (in its absolute rather than pseudo-absolute use), the (absolute) present tense of the 'futurish' verbs *be going to*, *be to*, etc. (see 2.9.1), and the 'absolute-relative' tense forms (i. e. the future perfect and the forms built with *will be going to* and *will have been going to*).

As absolute tense forms, the future tense forms and the futurish verb forms represent the situation time of the situation referred to as the central orientation time of a post-present domain. The **ABSOLUTE RELATIVE TENSE** forms also establish a post-present domain but represent the time of their situation as either T-anterior or T-posterior to the central orientation time of the domain in question. That is, they establish a post-present domain and at the same time express a T-relation in it. For example:

By the end of the week I *will have written* about 100 pages. (*The situation time is T-anterior to the central orientation time of the post-present domain, which is not a situation time but an otherwise unspecified orientation time contained in the Adv-time indicated by the time adverbial.*)

[Don't call at his house at seven.] He *will be going to leave* then. [He has to catch the 7.32 train.] (*The situation time is T-posterior to the central orientation time of the post-present domain.*)

[If you have not paid me back by the end of this month] you *will have been going to pay* me back for exactly six months. (*The situation time is T-posterior to an*

1. The term 'Future Perspective System' was actually a misnomer, because (as will become clear below) the forms it contains imply that the speaker looks at the future from a present perspective: these forms establish a post-present domain.

unspecified orientation time which is T-anterior to the central orientation time of the post-present domain. The head clause is interpreted as 'For exactly six months you will have had the intention of paying me back'.)

10.1.2 An absolute-relative tense differs from a purely absolute one in that it relates its situation time to an orientation time in a post-present domain and not to t_0 . It therefore fails to make explicit the temporal W-relation that holds between the situation time in question and t_0 , and can therefore be used irrespective of whether the situation time lies before, at, or after t_0 :

[If there is a strike the day after tomorrow,] we'll have worked in vain {yesterday / today / tomorrow}.²

10.1.3 In the same way as absolute tense forms can be used as pseudo-absolute forms when they expand a post-present domain (see 9.17.3), the future perfect can be used as a 'pseudo-absolute-relative' tense rather than as an 'absolute-relative' one. This is the case when the origin of the Tposteriority relation is not t_0 but a post-present pseudo- t_0 , as in the following:

He will say that he *will have finished* before 5 o'clock.

The tense structure of this sentence is represented by Figure 10.1.

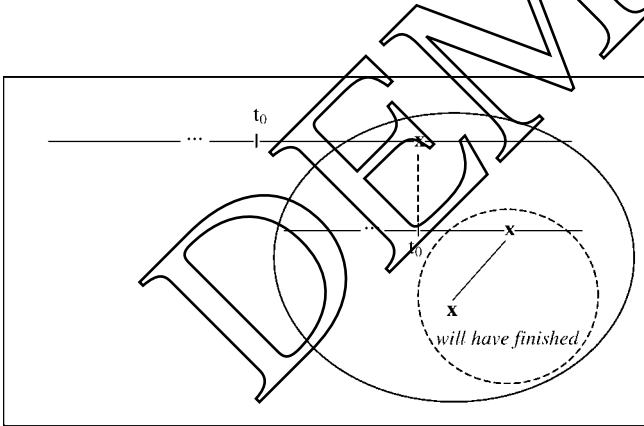

Figure 10.1. The tense structure of *He will say that he will have finished before 5 o'clock*.

2. Imagine the following setting for this sentence: yesterday it was Saturday, but the workers of a particular firm worked all the same because they were behind schedule and wanted to catch up. Today, however, they hear on the radio that there may be a strike the day after tomorrow in one of their supply companies. If the strike goes through, they will soon be unable to continue working and will be behind schedule again. Under these circumstances, one of the workers might utter this sentence.

10.2 The Pseudo- t_0 -System

10.2.1 It has been explained in 9.17.1 that once a post-present domain has been established and we want to incorporate a situation time into it, we treat the central orientation time of the post-present domain as if it were a present orientation time, i. e. as if it coincided with t_0 . This means that in order to T-relate a situation time to this ‘PSEUDO- t_0 ’ we use one of the same tenses as we use to T-relate a situation time to t_0 . That is, the tenses used to expand a post-present domain are not formally distinguishable from the absolute tenses. This is clear from examples like the following:

[If we dump his body in Soho after we have killed him] the police will think that he *was killed* there.

Next Friday his excuse for being late will probably be that he *has been sitting* in a traffic jam caused by the Pope’s visit.

[When you arrive in Tokyo] you will find that it *is* already dark.

[If I make up my mind to resign] you will be the first to hear when exactly I *will do* so.

In each of these examples the head clause establishes a post-present domain and the situation time of the complement clause is incorporated into it. Since the speaker treats the central orientation time as if it were t_0 , he uses a ‘PSEUDO-ABSOLUTE’ tense form in the subclause. That is, the tenses used to relate a situation time to the central orientation time of a post-present domain are the preterite or the present perfect for T-anteriority, the present tense for T-simultaneity and the future tense for T-posteriority. In what follows we will call this system of tenses used to express a T-relation in a post-present domain the **PSEUDO- t_0 -SYSTEM**. (This replaces the term ‘Present Perspective System’, which we used in earlier publications.)³ The label ‘Pseudo- t_0 -System’ captures the fact that this system is based on a shift of perspective: the post-present binding orientation time is treated as if it were t_0 . In other words, the speaker views the bound situation times from the perspective of a post-present pseudo- t_0 .

The Pseudo- t_0 -System comprises not only pseudo-absolute tenses functioning as relative tenses establishing a subdomain within the post-present domain but also true relative tenses (like the past perfect) expanding a pseudo-past or pseudo-pre-present subdomain in a post-present domain.

3. The term ‘Present Perspective System’ was a misnomer, because it wrongly suggests that Pseudo- t_0 -System forms imply that the speaker looks at a situation from his present perspective, i. e. from t_0 . In actual fact, he views them from the perspective of a post-present pseudo- t_0 .

10.2.2 The Pseudo- t_0 -System can be defined as the system of tenses used to expand a post-present domain, i. e. used to express a T-relation in an already established post-present domain. Under ‘Pseudo- t_0 -System tenses’ we therefore subsume not only pseudo-absolute tenses functioning as relative tenses *establishing* a subdomain within the post-present domain but also true (genuine) relative tenses (like the past perfect) *expanding* a pseudo-past or pseudo-pre-present subdomain within the post-present domain. The pseudo-absolute tenses relate their situation time to a pseudo- t_0 in the post-present domain. (As shown in 9.21–22, the binding orientation time is a pseudo- t_0 when it is the central orientation time, or an orientation time that is T-simultaneous or T-posterior to the central orientation time, or an orientation time that is T-simultaneous or T-posterior to an orientation time which is T-simultaneous or T-posterior to the central orientation time, etc.) Pseudo- t_0 -System forms that expand a pseudo-past or pseudo-present subdomain are not pseudo-absolute forms. Consider:

After the interview they will check whether what you *told* them (at the interview) *was* true.

In this example, the form *told* is a pseudo-absolute tense form representing its situation time as T-anterior to the central orientation time (= pseudo- t_0). This *told* creates a pseudo-past subdomain which is developed as if it were a genuine (true) past domain. The relative past tense form *was* expresses T-simultaneity within this subdomain. Since both past tense forms express a relation in the post-present domain, both of them are used as Pseudo- t_0 -System forms. However, only the first of them is a pseudo-absolute tense form. All this should be clear from Figure 10.2.

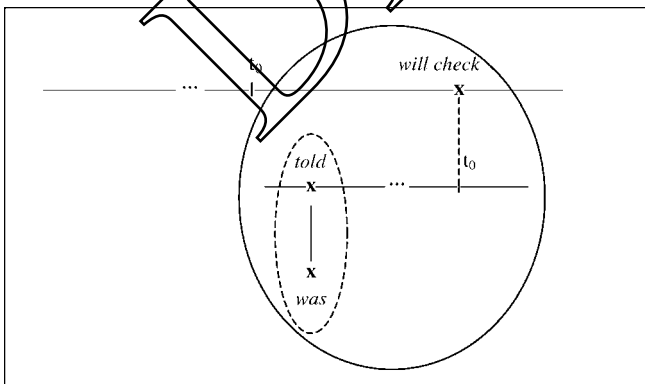

Figure 10.2. The tense structure of *After the interview they will check whether what you told them (at the interview) was true.*

In sentences like *I'm leaving tomorrow*, the present tense form is not a Pseudo- t_0 -System form but represents a shift of perspective from the post-present to the present.

10.2.3 Pseudo- t_0 -System forms should be distinguished carefully from another use of the present tense with future time reference, viz. that illustrated by sentences like the following:

I'm leaving tomorrow.

Next year Christmas falls on a Wednesday.

This use of the present tense is also the result of a shift of perspective: a post-present situation is treated as if it were a present one. However, this use is clearly different from the use of the present tense in the Pseudo- t_0 -System. For one thing, the shift of perspective which occurs here has a semantic effect which is absent if the present tense is a Pseudo- t_0 -System form: in the above examples the post-present situation is represented as 'pre-determined' at t_0 , i. e. as depending on a present arrangement, programme, plan, etc. (see 3.8–9). For another, this use of the present tense is mainly found in clauses that are syntactically independent, whereas the Pseudo- t_0 -System cannot be used in that type of clause at all (see below). Moreover, this use of the present tense can be found in head clauses supporting a subordinate clause using the Pseudo- t_0 -System:

We're having a picnic tomorrow, if it does not rain. (Does is a Pseudo- t_0 -System form.)

This means that the present tense in its 'arranged future' use resembles the future tense of the Absolute Future System in that it creates a post-present domain. Such a present tense form is thus a 'futurish' tense form. By contrast, a Pseudo- t_0 -System form is generally unable to establish a post-present domain (except in an indirect way – see 9.16 and 9.22.1). It consists of forms that are used to express a T-relation within a post-present domain already established by another clause.

10.3 Outline of the distribution of the two systems

10.3.1 We will conclude these introductory remarks with a brief note on the different distributions of the two systems. As noted above, one of the basic distributional differences between the Absolute Future System and the Pseudo- t_0 -System is that only the former can be used in syntactically independent clauses. This is clear from the following examples:

- (1) (Whatever happens, it will be no use asking him for details.) He will say that he *has not seen* anything, *has not heard* anything, and that he *does not know* anything at all.
- (2) (Whatever happens, it will be no use asking him for details.) He *will not have seen* anything, he *will not have heard* anything, and he *will not know* anything at all.
- (3) (Whatever happens, it will be no use asking him for details.) #He *has not seen* anything, *has not heard* anything, and he *does not know* anything at all.

In (1) we have an instance of indirect reported speech, with Pseudo- t_0 -System forms in the *that*-clauses. In (2)–(3) the reporting clause *he will say* has been dropped, so that we have ‘free indirect speech’, i. e. the reported clauses are syntactically independent. Example (2) shows that the result is impeccable if we use Absolute Future System forms, whereas (3) shows that the result is bad (since we get an incoherent piece of discourse) if we try using Pseudo- t_0 -System forms: the present perfect forms in (3) are not interpreted as Pseudo- t_0 -System forms at all, but rather as absolute tense forms (representing their situations as anterior to t_0).

10.3.2 Subordinate clauses fall into three groups as regards the choice between the Pseudo- t_0 -System and the Absolute Future System. In some of them (e. g. nonrestrictive relative clauses) the Absolute Future System is obligatory; others (e. g. adverbial time clauses) require the Pseudo- t_0 -System, whereas still others (e. g. restrictive relative clauses) allow either system. For example:

The meeting will be declared open by John, who {*will also explain* / **also explains*} its main purpose.

The meeting will no doubt come to an end before it {*is* / **will be*} 11 p.m.

[The shopkeeper will leave] when/after he {*has* / **will have*} locked up.

At the airport you will be met by a man who {*is wearing* / *will be wearing*} a red jacket.

[I predict that some day John will be arrested] because he {*is* / *will be*} speeding.

If John {*is* / #*will be*} in trouble, I will help him. (*is* expresses an ‘open condition’, *will be* a ‘closed’ one; the latter interpretation requires a preceding context – see 10.6.8 below)

See sections 10.6–8 for a fuller discussion of the distribution of the two systems.

II. Theoretical analysis of the Absolute Future System and the Pseudo- t_0 -System

The basic difference between the Absolute Future System and the Pseudo- t_0 -System is that tense forms from the former relate the situation time to t_0 , whereas tense forms from the Pseudo- t_0 -System relate the situation time to a post-present ‘basic orientation time’. From this it follows that an Absolute Future System form creates a post-present domain (which is at the same time a temporal domain and an intensional one), whereas the Pseudo- t_0 -System expresses a relation in an already existing domain. This means that the temporal specification effected by an Absolute Future System form is independent of the surrounding linguistic context, whereas that effected by a Pseudo- t_0 -System form is not. A Pseudo- t_0 -System form requires a linguistic context providing the necessary post-present basic orientation time. The use of the Pseudo- t_0 -System in a subclause is then a sign that the situations referred to in the subclause and the head clause are closely related to each other, not only temporally but also logically: the subclause is fully integrated into the head clause, and the two situations are presented as forming an interpretive unit.

10.4 Characteristics of the two systems

10.4.1 Before going into the characteristics of the two systems it is necessary to point out that the basic function of a tense is to express a temporal structure which has the form of a chain of T-relations between orientation times. This chain, which may involve one or more T-relations, relates the situation time to a ‘basic orientation time’, either directly or via one or more intermediate orientation times. (As noted in 2.14, the time of the predicated situation (= the situation time) is treated as an orientation time because the time of another situation can be related to it.) The **BASIC ORIENTATION TIME** is that orientation time in the structure of the tense from which the temporal relations expressed by the tense begin to be computed. In most cases the basic orientation time is t_0 , but there are cases in which it is a post-present binding orientation time (i. e. a pseudo- t_0). Compare:

(4a) He has done it.

(4b) [If he does it] he will have to admit to his wife that he *has done* it.

In both (4a) and (4b) the present perfect form *has done* locates the situation time before the basic orientation time. In (4a) the basic orientation time is t_0 ; in (4b) it is a post-present situation time (the time of admitting), which is treated as if it were t_0 . This means that the two present perfect forms realize

the same temporal structure (viz. ‘situation time anterior to basic orientation time’), with the difference that the basic orientation time is t_0 in (4a) and a post-present ‘pseudo- t_0 ’ in (4b). (Note that in (4b) the basic orientation time is interpreted as W-posterior to t_0 , but that this relation is not signalled by the tense form *has done* itself: it is inferred from the use of the future tense in the head clause and (especially) from the presence of the clause *if he does it*, which refers to the post-present.)

The following sentences involving a future tense form are similar to (4a–b):

(5a) He will do it.

(5b) [If he decides to do it] he will have to admit to his wife that he *will do it*.

Needless to say, *will do* is used as an Absolute Future System form in (5a) and as a Pseudo- t_0 -System form in (5b): in (5a) the situation referred to by *He will do it* is located posterior to t_0 ; in (5b) the situation referred to by *he will do it* is located posterior to the orientation time established by *will have to admit*. The essential difference between the two systems is therefore the different nature of the basic orientation time: in the Absolute Future System it is t_0 , in the Pseudo- t_0 -System it is a post-present orientation time referred to in the context. (Since the post-present orientation time is treated as if it were t_0 , the tense used to represent the situation time as T-posterior to the pseudo- t_0 is the same as the tense used to represent the situation time as T-posterior to t_0 , viz. the future tense.)

10.4.2 One consequence of the different nature of the basic orientation time is that the temporal specification effected by an Absolute Future System form is independent of the surrounding linguistic context, whereas that effected by a Pseudo- t_0 -System form is not. A Pseudo- t_0 -System form requires a linguistic context providing a post-present orientation time serving as basic orientation time for the Pseudo- t_0 -System form. In other words, for a subclause to use the Pseudo- t_0 -System, it is necessary that the head clause establishes a post-present domain. However, it should be remembered that this need not be done in an explicit way, i. e. by the use of an Absolute Future System form. As noted in 9.16, a post-present domain can also be established implicitly by the use of an imperative, an infinitive or another form implying post-present actualization:

Do it when the others {have left / *will have left}.

I hope to do it when the others {have left / *will have left}.

What is necessary for the use of a Pseudo- t_0 -System form is that there is a post-present time available to function as basic orientation time. This time must be a situation time, but it need not be indicated by a tensed form.

10.4.3 It has been mentioned above that in subclauses we may find either the Absolute Future System or the Pseudo- t_0 -System (though in any given subclause only one of the two systems may be available – see sections 10.6–8 regarding

the distribution of the two systems). In a complex sentence with an Absolute Future System form in the head clause, we sometimes find the Absolute Future System in the subclause and sometimes the Pseudo- t_0 -System. When a subclause uses the Absolute Future System (as in *I will join you, whereas Tom will stay at home*), the temporal relation between the situation time of the head clause and that of the subclause is not expressed by the tense forms: independently of one another, each of the two Absolute Future System forms relates its situation time to t_0 and in doing so establishes a post-present domain. (These two domains may be pragmatically interpreted as W-simultaneous with each other, but this relation is not expressed by the tense forms.) By contrast, if the subclause uses the Pseudo- t_0 -System (as in *I will ask him tomorrow what date it is*), the tense form of the subclause locates the situation time of the subclause in the temporal domain created by the Absolute Future System form in the head clause.

10.4.4 It follows that when the Absolute Future System is used in both clauses, the speaker makes two independent predictions: there are, as it were, two speech acts (see also 10.6.4). When the Pseudo- t_0 -System is used in the subclause, the speaker makes a single (but complex) prediction: he presents the contents of the two clauses as forming a unit. The use of the Pseudo- t_0 -System, which implies that the situation time of the head clause and the situation time of the subclause are located in the same domain, is therefore a sign that the two situations must be interpreted as related to each other. This relation may be purely temporal, but in most cases it is also a logical one: if there is no logical relation between two situations, there is as a rule no reason to relate them temporally to each other. The logical link may even be stronger than the temporal one. For example, in conditional clauses expressing an 'open' condition (e.g. *I'll be happy if she comes*), the use of Pseudo- t_0 -System forms (in this case: *comes*) is conventionalized as a means of expressing a logical relationship rather than a purely temporal one: the logical relation is expressed as if it were a temporal one – see 9.20.4 and 10.7.1 below.⁴

10.4.5 In the preceding three subsections, some basic differences have been pointed out between the Absolute Future System and the Pseudo- t_0 -System. We will now indicate some further differences following from these.

Because the Pseudo- t_0 -System is a way of expressing the temporal and logical relation between the subclause situation and the head clause situation, it

4. Though the basic meaning of any tense is to express one or more temporal relations, there are many uses of tense forms that are metaphorical extensions of this. For example, the preterite, whose basic meaning is 'remoteness in time' (i. e. location in the past time-sphere) is conventionally used to express other forms of remoteness, e.g. remoteness from reality, as in *I wish I knew the answer*. Expressing a logical link as if it were a temporal one is also a kind of metaphorical use of a tense.

implies that the subclause is necessary for a correct interpretation of the head clause. The fact that the head clause and the subclause are thus presented as one **INTERPRETIVE UNIT** means that it is not only the case that the subclause is dependent for its interpretation on the head clause (which is obvious, since the subclause is both syntactically and temporally subordinated to the head clause), but that it is also the case that the head clause depends for (at least part of) its interpretation on the subclause. It is no coincidence that the types of subclause in which the Pseudo- t_0 -System must or can be used show this close interpretive relationship between the two clauses. The following are some typical examples:

- (a) Conditional clauses expressing an open condition require the use of the Pseudo- t_0 -System (see 10.7.1 below). In this type of *if ... then ...* sentence the logical dependence of the head clause on the subclause is obvious.

I'll be disappointed if she *doesn't show up*.

- (b) Adverbial time clauses also require the use of the Pseudo- t_0 -System rather than the Absolute Future System (see 10.7.2 below). In this case the temporal interpretation of the head clause partly depends on the subclause in that the latter specifies the Adv-time which 'contains' the situation time of the head clause.

Will you be here when the Gibsons *arrive*?

- (c) Concessive subclauses introduced by a *wh*-word in *-ever* normally use the Pseudo- t_0 -System if they have a conditional connotation (see 10.7.6):

Whoever *comes* to see me, tell them I'm not at home.

- (d) Restrictive relative clauses tend to use the Pseudo- t_0 -System, but not if the form in question could be mistaken for an Absolute Future System form (which yields a different interpretation) – see 10.6.8:

I'll report this to the first policeman I *see*.

There'll be a medal for every competitor who *reaches* the finish.

Restrictive relative clauses are essential to the interpretation of the head clause in that the identification of the referent of the antecedent NP depends on it.

- (e) Nominal clauses similarly tend to use the Pseudo- t_0 -System, but not if the form in question could be mistaken for an Absolute Future System form (with a different meaning) – see 10.6.3:

[Don't steal that money or] it will soon be common knowledge that it *is* in your possession. (*dependent statement*)

Sleep on it and tell me tomorrow whether you still *want* to leave. (*dependent question*)

Next time you should tell me what you *think*. (*nominal relative clause functioning as object clause*)

A nominal clause helps to determine the interpretation of the head clause because it functions as one of the essential arguments of the predicate.

It is clear, then, that the use of the Pseudo- t_0 -System is a sign that the subclause is fully integrated in the head clause, both syntactically and semantically. (However, full integration is not a sufficient condition. In all types of subclause that allow the use of the Absolute Future System a co-operative speaker will have to use the latter system if the corresponding Pseudo- t_0 -System form would be mistaken for an absolute tense form. For example, in *John won't come because he is out of town*, the present tense is naturally understood as referring to the present (and not as a Pseudo- t_0 -System form). Future time reference therefore requires the use of an Absolute Future System form: *John won't come because he will be out of town.*)

Because a post-present situation is 'not-yet-factual' at t_0 , a post-present temporal domain is at the same time an 'intensional domain'.

10.4.6 For obvious reasons, a situation that is located in the post-present is still 'not-yet-factual at t_0 ' (see 7.4). A clause with an Absolute Future System form makes a prediction rather than expressing a fact. This means that the semantics of an Absolute Future System form implies the modal element of not-yet-factuality-at- t_0 next to its basic temporal meaning of establishing a post-present domain.

As a result of this modal element, a temporal domain created by an Absolute Future System form is a kind of **INTENSIONAL DOMAIN**: the propositions expressed by the clauses whose situation times are incorporated into the post-present temporal domain are interpreted in terms of a post-present possible world which is not the actual t_0 -world but a world of expectation which exists in the mind of the speaker. In other words, any subclause that is incorporated into a post-present domain by means of a Pseudo- t_0 -System form is interpreted '**OPAQUELY**' (i. e. from the point of view of the pseudo- t_0), whereas a subclause that uses the Absolute Future System is interpreted '**TRANSPARENTLY**' (i. e. from the point of view of the speaker at t_0). As we have seen in 10.4.4, this means that a subclause with a Pseudo- t_0 -System form is interpreted as part of the prediction made in the head clause, whereas a subclause with an Absolute Future System form is interpreted as an independent prediction made at t_0 . In many cases this distinction is a subtle one and there is hardly any difference between the two interpretations. For example, though it seems intuitively clear that the following examples are interpreted as indicated within brackets, it seems difficult to gauge what is the difference in communicative effect between them or to imagine contexts in which only one of them could be used.

John will be elected because he gets more votes than Tom. (= 'I predict: "John will be elected because he gets more votes than Tom".')

John will be elected because he will get more votes than Tom. (= 'I predict that John will get more votes than Tom and [I predict] that John will be elected because of that.')

⁵

Clause-order reversal confirms that there is a difference between these two sentences:

^{??}Because he gets more votes than Tom, John will be elected. (*The because-clause no longer forms part of the prediction, so that there is no ground for using the Pseudo-t₀-System.*)

Because he will get more votes than Tom, John will be elected. (*The order of the clauses is irrelevant, because both make a prediction of their own.*)

Unlike the former set of examples, there are cases in which the distinction between the two systems is very important, viz. when there is some compelling reason for the subclause and the head clause to be interpreted in terms of the same intensional domain. If there is such a requirement, the Absolute Future System is predictably ruled out from the subclause. There are at least two types of subclause in which this is the case.

- (a) The first type consists of object clauses depending on an intensional (= world-creating) verb such as a verb of saying or thinking, in other words, clauses forming part of a stretch of represented speech or thought. In represented speech and thought, the object clause has to be interpreted opaquely (if the report is to be a genuine report), which means that the contents of the reported clause must be interpreted as belonging to the intensional domain created by the intensional (reporting) verb in the head clause. Since an intensional domain functions as a temporal domain, it follows that these object clauses must use the Pseudo-t₀-System if the head clause uses the Absolute Future System. (The same is true of their subclauses if these are also to be interpreted opaquely.) The following examples illustrate this. (The # sign is used to indicate that an Absolute Future System form cannot replace a Pseudo-t₀-System form, or vice versa, without a change of meaning. This does not imply that the form in question is ungrammatical.)

[I can't give you my umbrella.] My wife will wonder what I {*have done* / #*will have done*} with it.

[If I give you my ring] I will have to explain to my wife why I {*am not wearing* / #*will not be wearing*} it any more.

5. Note that this interpretation is not the same as that in which the *because*-clause gives the reason for uttering the head clause. The latter interpretation requires a break (marked by a comma) before *because*.

In these examples *will* creates an intensional domain (a future ‘possible world’) of which the intensional domain created by *wonder* or *explain* is a subdomain. Since the dependent question must belong to this subdomain, it must be represented as belonging to the domain created by *will*. This necessitates using the Pseudo- t_0 -System.

In this context we can draw attention to the difference between the following examples:

The Prime Minister will be informed when the man *is arrested*. (*The when-clause is an adverbial clause. The form is arrested expresses T-simultaneity in the post-present intensional domain.*)

The Prime Minister will be told when the man *will be arrested*. (*The when-clause functions as object clause. The form will be arrested is not an Absolute Future System form but a Pseudo- t_0 -System form expressing T-posteriority to the central orientation time of the post-present intensional domain.*)

- (b) The second type of subclause requiring the use of the Pseudo- t_0 -System because it forms part of an intensional domain is the conditional clause of an open conditional. Open conditionals refer to a future possible world in which the actualization of the *if*-clause situation entails (or at least enables) the actualization of the head clause situation. This possible world is an intensional domain, and hence a temporal domain, and both situation times must belong to it. This explains why the Pseudo- t_0 -System is the rule in the subclause:

If it {*doesn't rain* / **won't rain*} tomorrow, we will have a picnic.

Because their tense structure starts from a different basic orientation time, an Absolute Future System form represents the contents of its clause as either asserted or presupposed at t_0 , whereas a Pseudo- t_0 -System form represents the contents of its clause as asserted or presupposed at the post-present orientation time to which the situation time is temporally subordinated.

10.4.7 In this subsection we continue exploring the meaning differences between the Absolute Future System and the Pseudo- t_0 -System.

Because of the difference of ‘basic orientation time’ (see 10.4.1), the contents of an Absolute Future System-clause are represented as either asserted or presupposed at t_0 , whereas those of a Pseudo- t_0 -System clause are represented as asserted or presupposed at the post-present orientation time to which the situation time is temporally subordinated. Let us examine this in more detail in the next paragraphs.

The prediction made in an Absolute Future System-clause is a tensed proposition which is presented at t_0 as true. That is, a (cooperative) speaker making a prediction implies that he believes (or at least assumes) that his prediction will turn out to be true. This means that the content of the Absolute Future System-clause is either asserted or presupposed at t_0 . When used in isolation, the clause *John will come* asserts that the tensed proposition ‘John will come’ is true at t_0 . In a suitable context, the same clause may constitute a presupposition, as in *It is around five p.m. that John will come*, which is a ‘SPECIFICATIONAL’ (see 5.20.1) sentence in which *at five o’clock* specifies the value satisfying the presupposed variable ‘the t at which John will come’. In some types of subclause (such as nonrestrictive relative clauses) the proposition is always asserted, whereas in others (such as restrictive relative clauses) it is automatically presupposed. (For example, in *The man who will be here tomorrow will fix it*, the tensed proposition ‘a man will be here tomorrow’ is presupposed to be true at t_0 .)

When the Pseudo- t_0 -System is used, the tensed proposition is not presented (= asserted or presupposed) as true at t_0 . If the Pseudo- t_0 -System proposition is expressed in an object clause depending on a reporting verb, it is asserted as true in the mind of the reported speaker at the post-present basic orientation time. Thus, in *Next time she will say that the boy is feeling sick* the proposition ‘The boy is feeling sick’ is interpreted as asserted by the reported speaker (‘she’) at the post-present basic orientation time.⁶ The proposition in question is therefore interpreted opaquely, i.e. as true in the post-present intensional domain. In other types of subclause using the Pseudo- t_0 -System, the proposition is not asserted but supposed or presupposed in the post-present domain. This is the case, for example, in open conditional clauses, adverbial time clauses and restrictive relative clauses using the Pseudo- t_0 -System:

If John comes, I will tell her. (*The if-clause proposition is supposed to be true in the post-present intensional domain.*)

I will tell him everything when he comes. (*The when-clause proposition is presupposed to be true in the post-present intensional domain.*)

Pupils who are late tomorrow will be punished. (*The relative clause proposition is supposed to be true in the post-present intensional domain.*)

At first sight there would seem to be little pragmatic difference between presenting the proposition of a clause in the future tense as true at t_0 and presenting the proposition of a clause using the present tense (as Pseudo- t_0 -System tense)

6. The same is true of sentences like the following, in which there is no reported speaker, but there still is a ‘perceiving entity’ at the post-present basic orientation time, from whose perspective (point of view) the proposition of the subclause is evaluated:

[Take his temperature every two hours.] A temperature of over 38 degrees will indicate that the crisis *is approaching*.

as true at a post-present basic orientation time. In clefts, for example, the *that*-clause may be represented as presupposed at t_0 or as presupposed at the post-present basic orientation time without this leading to a clear difference of interpretation:

[Next year we shall see another America's Cup contest.] This time it will be Australia who *will be making* her first challenge. (LOB)

Next year it will be Australia who *is making* her first challenge.

However, there are also contexts in which only one of the two systems is suitable. Consider the following examples:

(6) The man who {*will solve / is going to solve / will be solving*} this problem will receive a reward.

(7) The man who *solves* this problem will receive a reward.

In (6) the speaker presupposes that the tensed proposition 'A man is going to solve this problem' is true at t_0 . This means that the relative clause has the connotation of a 'CLOSED CONDITION' (i. e. a condition which is assumed to be, or to be going to be, fulfilled), so that (6) can be paraphrased as follows:

(6') I assume that a (specific or nonspecific) man {*will solve / is going to solve / will be solving*} this problem. That man will receive a reward.

By contrast, in (7) (in which *solves* is to be interpreted as a Pseudo- t_0 -System form and not as referring to a present habit) the speaker merely presupposes that the tensed proposition 'A man is going to solve this problem' is *possibly* true at t_0 . This means that the relative clause has the connotation of an 'OPEN CONDITION' (i. e. a condition which is assumed to be one that may or may not be fulfilled), so that (7) can be paraphrased as follows:

(7') I assume that it is possible that a (specific or nonspecific) man will solve this problem. If a man does, he will receive a reward.

The tense choice in the following sentence is in keeping with this explanation:

The man who {*will be solving / *solves*} this problem will be 47 years old tomorrow.

This sentence is fine with a future tense form in the relative clause because the tensed proposition 'X will be 47 years old tomorrow' expressed in the head clause presupposes the future existence of X, which is compatible with a closed condition reading of the relative clause. However, the same presupposition is incompatible with an open condition reading of the relative clause, which implies that X may or may not turn out to exist in the future. Since the Pseudo- t_0 -System form *solves* assigns to the relative clause the connotation of an open condition, it is unacceptable in this sentence.

The above examples show that the difference between the idea 'Absolute Future System-proposition presupposed at t_0 ' and 'Pseudo- t_0 -System proposi-

tion presupposed at post-present basic orientation time' may have a clear effect on the interpretation of the sentence. In clauses with a conditional interpretation it generally corresponds to the distinction between an open condition and a closed one. (We will return to this in 10.6.8 below.)

Of the two systems, only the Pseudo- t_0 -System can be used to suggest that the contents of the clause represent how the situation will be evaluated at the future basic orientation time rather than how it is evaluated by the speaker at t_0 .

10.4.8 Another difference between the Absolute Future System and the Pseudo- t_0 -System is that only the latter can be used to suggest that the contents of the clause in question represent how the situation will be evaluated at the future basic orientation time rather than how it is evaluated by the speaker at t_0 . Consider:

You will all be arrested because John *will do* something stupid. (*The relevant interpretation is 'I predict that John will do something stupid and that you will all be arrested because of that'.*)

You will all be arrested because John *does* something stupid.

Out of context, both are equally appropriate, but only the version with the Pseudo- t_0 -System form can be used to create the impression that the situation is represented as it will be experienced and evaluated by some 'experiencing entity' located at the future basic orientation time:

[The scheme is no good because you cannot rely on John. I am sure he will bungle it. You will see.] you will all be arrested because he *does* something stupid. (*Here you refers to the 'experiencing entities at the basic orientation time'.*)

Conversely, the Absolute Future System may be chosen in order to put the 'temporal focus' on a post-present orientation time and in doing so represent the situation referred to as it will be evaluated in the future.

10.4.9 As pointed out in 2.8.3, the speaker sometimes uses the future tense to put the 'TEMPORAL FOCUS' on a post-present orientation time and in doing so represents the situation as it will be evaluated in the future. For example:

That thing rustling in the bushes over there *will* no doubt *be* a chipmunk: [let's wait till it comes out.] (Lakoff 1970:839)

President Bush *will not have been* the only President to defend this policy.

The use of *will be* in the first example (where *is* would also be possible) means that the speaker puts the temporal focus on the future moment when he and the hearer will see the animal come out and will observe that it is a chipmunk. Similarly, the use of *will have been* rather than *has been* in the second example creates the idea of a future time of evaluation: ‘as history will show’. This special interpretation, which is triggered by the use of the Absolute Future System in head clauses, can be achieved by the use of the Pseudo- t_0 -System in subclauses. In subclauses that in principle allow either the Absolute Future System or the Pseudo- t_0 -System, the Pseudo- t_0 -System may be used to suggest that it is the situation time of the head clause that is the time of evaluation. Consider again:

[The scheme is no good because you cannot rely on John. I am sure he will bungle it. You will see:] you will all be arrested because he *does* something stupid.

The situation of John doing something stupid is represented here as it will be experienced at the post-present basic orientation time.

10.5 Summary of part II

Summarizing part II, we can say that the basic difference between the Absolute Future System and the Pseudo- t_0 -System is the different choice of ‘basic orientation time’ (see 10.4.1): t_0 versus a post-present orientation time. This difference in turn entails the following:

- (a) An Absolute Future System form creates a post-present temporal domain, which functions as an intensional domain. The Pseudo- t_0 -System expresses a relation in an already existing intensional domain (except on the rare occasions when it is used to establish a post-present domain in an indirect way – see 9.16 and 9.22.1).
- (b) The temporal specification effected by an Absolute Future System form is not dependent on the linguistic context, whereas that effected by a Pseudo- t_0 -System form is. A Pseudo- t_0 -System form requires a linguistic context providing a post-present orientation time serving as basic orientation time for the Pseudo- t_0 -System form.
- (c) The use of the Pseudo- t_0 -System is a sign that the situations of the subclause and the head clause are closely related to each other, not only temporally but also logically. The subclause is fully integrated within the head clause, and the two situations are presented as forming an interpretive unit.

III. Factors determining the choice between the two systems

In this section we will explore the reasons which may induce the speaker to relate the situation time of a subclause to a future basic orientation time rather than to t_0 . In doing so we will make a distinction between subclauses that in principle allow either system, subclauses that require the Pseudo- t_0 -System and subclauses in which the Pseudo- t_0 -System cannot be used.

The text should be read with the continual proviso that we are only talking about subclauses whose head clause have future time reference. Thus when one reads that ‘The Pseudo- t_0 -System must be used in *if*-clauses expressing an open condition’ or ‘Restrictive relative clauses invariably use the Absolute Future System when their antecedent is in nonrestrictive apposition’, one has to mentally add ‘when the head clause has future time-reference’.

In section III we discuss the typical cases of subclauses requiring either of the two systems as well as those that are compatible with both. As regards the latter, we will point out the main factors that are relevant to the distribution of the two tense systems:

- (a) Generally speaking, the subclauses that allow or require the use of the Pseudo- t_0 -System belong to one of the following types: subclauses functioning as subject or object of the predicate of the head clause (with the exception of those discussed in 10.4.6), restrictive relative clauses, and subclauses functioning as adverbials that are fully integrated into the head clause.
- (b) The categories of subclause in which the Pseudo- t_0 -System has to be used express or connote some kind of open condition for the actualization of the head clause situation.

Apart from these, there are a lot of minor factors which also play a role.

10.6 Subclauses that allow either system

10.6.1 Typical examples of subclauses that in principle allow either the Pseudo- t_0 -System or the Absolute Future System are restrictive relative clauses, *because*-clauses, subclauses of comparison, the *wh*-clauses of clefts, resultative *that*-clauses following the degree adverb or manner adverb *so*, *that*-clauses depending on the noun *time* if the noun phrase does not function as an adverbial, and clauses introduced by a *wh*-word ending in *-ever*. In complement clauses (i. e. dependent statements or questions), the rule is that only the Pseudo- t_0 -System is possible. However, in very special cases, where the report-

ing verb does not have full semantics, we may find the Absolute Future System as an alternative to the Pseudo- t_0 -System.

The following pairs of sentences illustrate the two possibilities for each of these types of subclause. The (a) example each time uses the Absolute Future System, while the (b) example uses the Pseudo- t_0 -System. (Note that there is no suggestion that the two systems can always be used interchangeably: these examples just illustrate the claim that either system is possible in the relevant type of subclause.)

- (a) [He got a good fat job and we congratulate him on his good luck. We hope that] he will execute it in a manner that *will entitle* him to credit. (BR) (*restrictive relative clause*)
- (b) [There is still one glittering prize to be grasped.] The man who *captures* it will go down in history as one of the greatest of mortals. (LOB) (*id.*)
- (a) Then it will make us think about unity because we *will be using* church in disunity. (SEU) (*because-clause*) (*The sentence should not be interpreted as a kind of cleft.*)
- (b) If we hide his shoes he will panic because he *cannot find* them. (*id.*)
- (a) [If you take the train and I take the bus], I will probably travel faster than you *will*. (*subclause of comparison*)
- (b) [If you take the train and I take the bus], I will probably travel faster than you *do*. (*id.*)
- (a) [If love, loyalty and courage count for anything,] it won't be Violet's marriage that *will break up*. (LOB) (*that-clause of a cleft*)
- (b) [And he's made it abundantly clear to Steven that] if the two don't work together, it won't be Dave who's *shown* the door. (www) (*wh-clause of a cleft*)
- (a) You and your tarantula will be so happy that you will end up wanting more tarantulas. (www) (*resultative that-clause following the degree adverb so: so = 'to such an extent'*)
- (b) Men will be so frightened that they *cry out* for the mountains and rocks to fall upon them. (www) (*id.*)⁷
- (a) All sprinkler heads will be so constructed that they *will not project* above ground level where located. (www) (*resultative that-clause following the manner adverb so: so = 'in such a manner'*)
- (b) The case study will be so constructed that no advanced use of techniques *is required*. (www) (*id.*)
- (a) For some, it will be the first time they *will have been* back since graduation, [so they may find a few changes have occurred over the years!] (www) (*that-clause*)

7. It should be noted, though, that this is the only clear example with the Pseudo- t_0 -System that we have found. When *so* is a degree adverb meaning 'to such an extent', the *that*-clause is apparently normally followed by the Absolute Future System.

depending on the noun *time*, which does not form part of a semi-conjunction like *by the time that*)

- (b) For some, it will be the first time they *have been* back since graduation. (*id.*)
- (a) [A relaxing holiday with easy day walks amidst the nature, fields and man-managed landscape with chateaus, Baroque churches, vineyards and tree alleys.] We will find a varied wildlife wherever we *will be*. (*www*) (*clause introduced by wh ... ever*)
- (b) He will go wherever I go. (*id.*)
- (a) What the next move *will be* only time, of course, will tell. (BR) (*complement clause: dependent question*)
- (b) [We can charge what we like.] The public will decide whether or not it *pays*. (LOB) (*id.*)
- (a) The man who enjoys his work and approaches it creatively will find that the techniques, the competency and the professional polish *will come* to him automatically. (LOB) (*complement clause: dependent statement*)
- (b) [The negro is Mr Robert Weaver of New York.] One of his tasks will be to see there *is* no racial discrimination in Government and State housing projects. (LOB) (*id.*)

In subclauses of these types the choice between the Absolute Future System and the Pseudo- t_0 -System is often not entirely free. In the following subsections we explore some reasons why the speaker may decide against using one of them.

Because a Pseudo- t_0 -System form depends for its future time interpretation on the head clause, the Pseudo- t_0 -System cannot be used if the head clause does not establish a post-present domain.

10.6.2 As pointed out in 10.4.2–3, a Pseudo- t_0 -System form depends for its future time interpretation on the head clause, and thus the Pseudo- t_0 -System cannot be used if the head clause does not establish a post-present domain (either explicitly or implicitly):

He is worried because he *{will be asked / *is asked}* for an explanation tonight.

The following would seem to be exceptions to this rule:

It doesn't matter much who we *hire* for this job.

I don't care what you *do* with these animals [as long as you keep them out of my house].

It is a fact that the use of the present tense is normal in noun clauses depending on expressions like *it doesn't matter*, *I don't care*, *I don't mind*, *it's not impor-*

tant, etc. However, because the head clause does not establish a post-present domain, the present tense is not a Pseudo- t_0 -System form here. It is an instance of another type of shift of temporal perspective: the post-present situation time of the noun clause is treated as if it coincided with t_0 .⁸ The possibility of using the present tense after *it doesn't matter*, etc. is limited to 'nonhomogeneous' (see 1.45) clauses: the subclause can be interpreted as having future time reference in *It doesn't matter what he tells her* but not in *It doesn't matter what he's telling her*. The fact that the nonprogressive present cannot be understood as referring to the present no doubt helps to explain why it can be used to refer to the post-present in this context.

The use of the Pseudo- t_0 -System will be avoided in cases where the relevant Pseudo- t_0 -System form would be naturally misinterpreted as an absolute tense form.

10.6.3 A co-operative speaker will not use the Pseudo- t_0 -System when the relevant Pseudo- t_0 -System form would not be interpreted as a Pseudo- t_0 -System form but rather as an absolute tense form. Compare the following (in which the *because*-clause should not be interpreted as specifying the reason why the speaker utters the head clause):

The boy will no doubt be caught because he {*steals / will steal*} some money.

The boy will no doubt be caught because he {*is using / will be using*} the wrong ink.

In the first sentence, *steals* is clearly a Pseudo- t_0 -System form, because we use *is stealing* rather than *steals* to locate a (nonhabitual) situation in the present. However, the present tense form *is using* in the second example is naturally interpreted as referring to the present. (Generally speaking, a present tense form will naturally invite this interpretation if it is a stative, progressive or passive form, in other words, if the situation is represented as homogeneous.) A co-operative speaker will therefore avoid using *is using* as Pseudo- t_0 -System form in this *because*-clause. If future time reference is intended, he will use the Absolute Future System form *will be using* instead. The following examples further illustrates this principle:

Bruce will be very busy tomorrow because his shop assistants *will be* absent. (Are *would suggest that they are already absent at t_0 .*)

Bruce will be very busy tomorrow because his shop assistants *will have* left. (Have *left would suggest that they have already left.*)

8. This is basically the same mechanism as in examples like *I'm leaving tomorrow* or *I'm 24 tomorrow*, only it is not applied for the same reason, viz. to represent the post-present situation as pre-determined at t_0 (see 7.16).

Similarly:

[I'll get there faster] than you {*do / will*}.

[When your father comes back, he will not understand] what {*is / will be*} going on.

[The papers will no doubt report everything] that {*is / will be*} said.

In examples like these the future tense (= Absolute Future System) is used in order to avoid ambiguity, since the present tense may either locate its situation time at t_0 (= absolute tense) or express T-simultaneity (= Pseudo- t_0 -System).

As is clear from the examples, it is the fact that there is no formal differentiation between the absolute use of the present tense and its use as a Pseudo- t_0 -System form that normally induces the speaker to use the Absolute Future System whenever the Pseudo- t_0 -System might cause confusion.

The principle that Pseudo- t_0 -System forms should not be used if they could be misunderstood is a strong pragmatic principle (based on the Gricean Maxims) which tends to overrule any other considerations in subclauses where the speaker can in principle choose between the Absolute Future System and the Pseudo- t_0 -System. The use of the Absolute Future System in nominal clauses (such as dependent statements or questions) is always due to this principle, since the Pseudo- t_0 -System is the unmarked (or, sometimes, only possible) system in this type of subclause:

[If you steal that money,] I will tell everyone that you ~~*are*~~ / #*will be* the thief.

[If you steal that money,] I will tell everyone what you ~~*have done*~~ / #*will have done*.

[When your father comes back, he will not understand] what {*is / will be*} going on. (*is is ambiguous*)

In *because*-clauses, the choice of system depends on whether the *because*-clause is 'actualization-explaining', 'utterance-explaining' or 'evidential'.

10.6.4 In *because*-clauses, the choice of system depends on the discourse function of the clause. In general, we can distinguish between three functional types:

- (a) **ACTUALIZATION-EXPLAINING BECAUSE-CLAUSES** have a content-level function: they express the reason for, or the cause of, the actualization of the head clause situation:

He was killed because he knew too much.

- (b) **UTTERANCE-EXPLAINING BECAUSE-CLAUSES** function at the speech-act level: they explain why the speaker makes the speech act (i. e. assertion, question, instruction, etc.) that he makes by uttering the head clause:

You'd better hurry up, because there's going to be a storm.

- (c) **EVIDENTIAL BECAUSE-CLAUSES** function at the cognitive (epistemic) level: they explain the basis on which the speaker comes to the conclusion that the head clause proposition is true.

There must be someone in the house, because there is a light on on the second floor.

When the reference is to the post-present, the distribution of the Absolute Future System and the Pseudo- t_0 -System is as follows:

- (a) Actualization-explaining *because*-clauses normally use the Pseudo- t_0 -System:

[If I tell you about him] he will perhaps kill you because you {*know* / #*will know*} too much.

The reason for this is that the *because*-clause here forms an interpretive unit with the head clause and is syntactically fully integrated into it. (This syntactic integration is confirmed, among other things, by the fact that the *because*-clause can be the highlighted constituent of a cleft: *It will be because you know too much that he kills you.*)

The following examples further illustrate the use of the Pseudo- t_0 -System in actualization-explaining *because*-clauses:

[Twenty years in the future, the same young person who today happily zips around town by bike, bus, or subway will be at the wheel of a minivan or something similar, hauling kids, dog and groceries.] It won't happen because he *has changed* his views on urban planning. It *will* happen because he *is* 20 years older. (www)

Things will change because he *makes* a conscious decision to change. (www) (= '*I predict that his making a decision to change will cause things to change.*')

- (b) Utterance-explaining *because*-clauses as a rule use the Absolute Future System:

[If it starts snowing heavily] you will do well to store some food, because your house {*will* perhaps *be* / #*is* perhaps} cut off from the village.

The reason for using the Absolute Future System here is that the head clause and the *because*-clause represent two independent speech acts. In other words, they do not form a single interpretive unit, and the *because*-clause is syntactically not fully integrated into the head clause: 'If it starts snowing heavily, you will do well to store some food. I'm telling you this because your house will perhaps be cut off from the village'.

The following example further illustrates the use of the Absolute Future System in utterance-explaining *because*-clauses:

Don't bring her here, because Mum *will be* very upset and Dad *will be* furious. (www)

- (c) Evidential *because*-clauses as a rule use the Absolute Future System if they depend on a head clause establishing a post-present domain:

Things will change, because he *will make* a conscious decision to change. (= ‘*The reason why I’ve come to the conclusion that things will change is that (in my opinion) he will make a conscious decision to change.*’)

The following examples further illustrate the use of the Absolute Future System in evidential *because*-clauses:

Hopkins will be out of his habitat in this fight, because he *will be forced* to be the aggressor. (www)

[Our deficit this year is \$1,200,000.] Next year the results *will be* somewhat better, because the economical climate *will have improved*. (www)

John will be caught, because he *will set off* the alarm.

10.6.5 If the Pseudo- t_0 -System is a possible option, it may be selected because the speaker wants to make clear through the choice of his tense form that the subclause must be interpreted opaquely rather than transparently. The following example (repeated here) is an illustration of this:

[The scheme is no good because you cannot rely on John. I am sure he will bungle it. You will see:] you will all be arrested because he *does* something stupid.

The Pseudo- t_0 -System form *does* represents the situation as it will be experienced by a participant in the head clause situation at the future basic orientation time.

Subclauses that allow the Pseudo- t_0 -System will as a rule use it if they are to be interpreted as belonging to the same intensional domain as the head clause.

10.6.6 Subclauses that allow the Pseudo- t_0 -System will as a rule use it if they are to be interpreted as belonging to the same intensional domain as the head clause. As we have seen in 10.4.6, this is the case in subclauses that spell out the propositional content of a verb of saying or thinking:

[If you do that] John will {allege / think} tomorrow that it *is* Friday, [although it will only be Thursday].

The Absolute Future System form *will be* cannot be used in the *that*-clause because this clause must be interpreted opaquely. (It is, however, used in the *although*-clause, which is interpreted transparently.)

In this connection it should be noted that there are ‘strong’ and ‘weak’ intensional verbs. **STRONG INTENSIONAL VERBS** are verbs like *imagine*, *wonder*, etc. whose object clauses virtually have to be interpreted opaquely (i. e. as

belonging to the intensional domain (possible world) that they create.) **WEAK INTENSIONAL VERBS** (e.g. *see, say*) more easily allow a transparent interpretation of their object clauses. When a weak intensional verb is used as the 'reporting verb' in the head clause of 'past represented speech' – see 8.25.1 – we can, under certain conditions, find absolute present time-sphere tenses instead of the relative tenses typical of a past domain: compare *John wondered whether you {were / ??are} a policeman* with *John asked me whether you {were / are} a policeman*.

Subclauses that allow the Pseudo- t_0 -System tend to use it if they are syntactically subordinated to a subclause whose verb is a Pseudo- t_0 -System form.

10.6.7 Subclauses that allow the Pseudo- t_0 -System will preferably use it if they are syntactically subordinated to a subclause whose verb is a Pseudo- t_0 -System form. Compare the sentences in the following pairs.

- (a) Their future will depend on how good their training here *{has been / ?will have been}*.
- (b) If their future *turns out* to depend on how good their training here *{has been / *will have been}*, their attitude towards us will change.
- (a) The religious group will forswear all proselytizing on the project it *{proposes / will propose}*.
- (b) No religious group, he declared in an interview, will receive Peace Corps funds unless it *forswears* all proselytizing on the project it *proposes*. (BR) (*Will propose cannot be used here.*)

The reason for this persistent use of Pseudo- t_0 -System forms is probably the complex syntactic structure: one subclause is embedded into another. Because of this, the temporal interpretation (i.e. the mental reconstruction of the temporal relations) would be difficult if the temporal relations did not run parallel to the syntactic relations. (The use of the Absolute Future System in a subclause means that the subclause is syntactically subordinated but not temporally subordinated.)

If both systems are possible, the Pseudo- t_0 -System will be selected if the clause is to have the connotation of an open condition. However, restrictive relative clauses with a conditional connotation use the Absolute Future System if they themselves contain or imply a conditional *if*-clause.

10.6.8 In subclauses that allow the use of the Pseudo- t_0 -System, the speaker will as a rule use this system if he wants the subclause to have the connotation of an open condition. This use of the Pseudo- t_0 -System is especially common in restrictive relative clauses:

This Sunday's sessions – including the free dinner – will be open to anyone who *makes* reservations. (BR)

[There is still one glittering prize to be grasped.] The man who *captures* it will go down in history as one of the greatest of mortals. (LOB)

The use of the Absolute Future System in subclauses like these would suggest that the speaker is treating the condition as closed at t_0 , i. e. that he takes the future actualization of the subclause situation for granted. Compare:

The people that *protest* will be arrested. (*Pseudo- t_0 -System*)

The people that *are going to protest* will be arrested. (*Absolute Future System*)

The first sentence implies that the speaker reckons with the possibility of people protesting and being arrested because of this. The second implies that the speaker assumes there will be protesters. In other words, the conditional connotation is that of an open condition in the former example and of a closed one in the latter – see 10.6.8 above.

However, restrictive relative clauses with a conditional connotation use the Absolute Future System if they themselves contain or imply a conditional *if*-clause:

I'm not going to do anything that *will possibly upset* him. (= 'I'm not going to do anything if it will possibly upset him if I do it.')

This constraint fits in with the rule that we use the Absolute Future System rather than the Pseudo- t_0 -System in *if*-clauses functioning as head clause for another *if*-clause (whether overtly present or implied): *We won't do it if it will upset him (if we do it)*. As pointed out in 10.8 below, the Absolute Future System has to be used in *if it will upset him* because (syntactically and semantically) this clause does not have a head clause establishing a post-present domain: the whole conditional means 'We won't do it if [if we do it it will upset him]'. That is, the clause *it will upset him* is not directly subordinate to *we won't do it*. It is a head clause rather than a conditional clause, even though it is preceded by *if*.

Restrictive relative clauses depending on a temporal noun can use either system, except if the noun forms part of a temporal adverbial or conjunction.

10.6.9 Restrictive relative clauses depending on a temporal noun (which does not form part of a temporal adverbial or conjunction – see below) may in principle use either the Absolute Future System or the Pseudo- t_0 -System:

We will live to see the day when China *{will be / is}* an economic superpower.

The day will come, in midsummer, when you *find* your plants becoming “leggy”.
(BR)

But the day will come when you’ll *remember* what I tell you now. (LOB)

There is little difference between the use of the future tense and the use of the present tense here. However, the choice of the Pseudo- t_0 -System or the Absolute Future System can lead to slight differences of emphasis. By using the Pseudo- t_0 -System, the speaker can encourage the hearer to take the point of view of someone located at the future time of the head clause situation from which the temporal location of the situation time of the subclause is calculated, rather than have the hearer view the situation as a future one with which he, located at t_0 , has no affinity.

As noted in 10.7.3, restrictive relative clauses with a temporal noun as antecedent require the Pseudo- t_0 -System when the antecedent forms part of a phrase functioning like a temporal conjunction:

By the time the police *{arrive / *will arrive}* it will be too late.

[And remember, the clutch is not a gradual affair like the one on a car.] The instant you *{engage / *will engage}* it the machine will rush away, with or without you.
(LOB)

You must stop the engine the moment (that) it *{begins / *will begin}* to make a strange noise.

The subclauses of such examples have the same function as adverbial time clauses, which require the use of the Pseudo- t_0 -System (see 10.7.2 below).

In a *that*-clause depending on the noun *time* either the Pseudo- t_0 -System or the Absolute Future System can be used, provided the phrase involving *time* does not function as an adverbial.

10.6.10 If the head clause refers to the post-present, both the Pseudo- t_0 -System and the Absolute Future System can be used in a *that*-clause depending on the noun *time*, provided the noun phrase does not function as an adverbial (and does not form part of a prepositional phrase functioning as an adverbial):

This will be the first time I *will have participated* in an online INSET [and whilst looking forward to it I am still finding it a little bit scary]. (www)

Will this be the first time that you *have used* media as a springboard to launch a discussion? (www)

This expedition will be the first time I *will have skied* all the way to the North Pole. (www)

This will be the first time Hitmen Fans *will have* the chance to see the new team on home ice. (www)

This will be the first time I *will not be* part of the 4 × 400 m relay for nine years. [I'm gutted.] (www)

These Olympics will be the first time pedorthists *are* members of the paramedical team. (www)

[We have had external members on many of our other committees, but] this will be the first time they *will participate* on policy making. (www)

[The first HTS coils designed for the common-coil magnet will be tested using NbTi coils to provide a 6 T background field.] Since this will be the first time HTS coils *are operated* in this environment, [many basic measurements will have to be made to characterize their performance.] (www)

While the present perfect and the future perfect locate the situation time in a period leading up to the relevant future orientation time, the present tense represents the situation time as simultaneous with the future orientation time and the future tense locates the situation time in a period which stretches from the future orientation time onwards into the future. This means that in an example like the following the present perfect and the future perfect emphasize the earlier part of the series of situations referred to, whereas the present tense and the future tense stress the last part:

This expedition will be the third time I {*have reached* / *will have reached* / *reach* / *will reach*} the North Pole

Note, however, that in the pattern illustrated by the examples above the sub-clause cannot use the Pseudo- t_0 -System if the head clause does not refer to the future. This is in keeping with what is said in 10.6.2.

[He is coming here next week.] It is only the second time he {*will have come* / **has come*} here since 1980.

[I will have to stand in for him a couple of times.] Today is the first time I {*will do so* / **do so*}.

10.6.11 Apart from the principles pointed out in the preceding subsections of 10.6, there are a number of factors which promote the use of the Pseudo- t_0 -System in restrictive relative clauses by seeing to it that there is a high degree of integration of the relative clause into the head clause. For example:

- (a) The Pseudo- t_0 -System is strongly preferred in nominal (headless) relative clauses:⁹

He will always give you what you *need*.

I will always go where you *go*.

The menu's content will depend on what you *have installed*.

Your final pension will depend on what you *have paid in* and how it *has grown* over the period.¹⁰

- (b) The Pseudo- t_0 -System is the rule if the antecedent is a cataphoric demonstrative or a cataphoric 'light' NP (i. e. an NP with little semantic content) which depends for its reference on the relative clause:

The best places will be snapped up by those who *come* early.

I will ask the people I *meet* for some food.

- (c) The Pseudo- t_0 -System is the rule if the antecedent is or contains an indefinite pronoun / determiner or a superlative:

Tomorrow Jane will be here, and she will get you anything you *want*.

Miss Bantin will be there in person ready to give her friendly advice to all who *care* to take advantage of her visit to the Capitol. (JOB)

10.7 Subclauses which as a rule use the Pseudo- t_0 -System

There are a number of types of subclause in which future time reference requires the use of the Pseudo- t_0 -System, e. g. conditional clauses expressing an open condition, adverbial time clauses, concessive clauses with a conditional connotation, subclauses of proportion and subclauses of manner that are fully integrated into the head clause. In the various subsections we have a closer look at these cases and observe that what they have in common is the meaning or connotation of an open condition.

10.7.1 The Pseudo- t_0 -System has to be used in *if*-clauses expressing an 'OPEN CONDITION' (i. e. a condition that is seen as one that may or may not be fulfilled in the future), because the subclause and the head clause then form a single

9. Those introduced by a *wh*-word in – *ever* even require the Pseudo- t_0 -System if they have a conditional connotation – see 10.7.6.

10. A Google search for *will depend on what you (will) have V-ed* yielded several hundred examples with the Pseudo- t_0 -System and three with the Absolute Future System. The following is one of the latter:

The searchable data for each recruiter will always depend on what you *will have allowed* him to see. (www)

temporal domain, representing a single intensional domain (= possible world). They do so because the head clause situation is dependent on the subclause situation, which means that the head clause must be interpreted within the possible world created by the *if*-clause. (The two clauses form part of the same 'scenario', which is treated as a possible world.)

The use of the Pseudo- t_0 -System in open conditionals is not so much a logical requirement as something that has come to be conventionalized in English. In many European languages both the Absolute Future System and the Pseudo- t_0 -System can be used in open conditionals. For example, in Dutch it is possible to say

Als we te laat *zullen komen*, zullen we gestraft worden.
'If we will be late, we will be punished'

as a (less usual) alternative to

Als we te laat *komen*, zullen we gestraft worden.
'If we are late, we will be punished'

In the former case, the two situation times are located in different temporal domains, which are interpreted as 'sloppily W-simultaneous', i. e. as following each other closely in time. This way of locating the situations in time fails to represent the close logical relationship between them. (This presents no problem because the logical relation is anyhow expressed by *if ... (then) ...*) In English, however, it has become conventional to signal the logical link by locating the two situation times in the same temporal (and intensional) domain. In this way English is able to distinguish between open and closed conditionals (see 10.6.8 above).

The reason behind the conventionalization may well be that the contents of an *if*-clause expressing an open condition are not asserted at t_0 but presupposed in the future possible world. In English, the Absolute Future System is used exclusively for predictions, i. e. to present a proposition in the future tense as true at t_0 . A proposition expressing an open condition is true only in the possible world created by *if*. The use of the Absolute Future System would wrongly represent it as a prediction, i. e. as a proposition which is presented as true at t_0 . (That the Absolute Future System can be used in Dutch is a sign that Dutch does not use the Absolute Future System for predictions only. It can also use it to create the intensional domain of an open condition, and this domain can then be interpreted as coinciding with the domain that is independently established by the head clause.)

The result of the conventionalization in English is that open conditionals using the Pseudo- t_0 -System primarily express the logical 'if p, then q' relationship. This means that the speaker is less concerned with the temporal relation than with the conditional one, and this explains why most open conditionals

referring to the post-present use the present tense as Pseudo- t_0 -System form in the subclause, even if the subclause situation is W-anterior to the head clause situation (e.g. *You will be punished if you do that*). The present tense is selected simply because it is the unmarked Pseudo- t_0 -System form: it is the form basically expressing T-simultaneity. (Of the three temporal relations that can be expressed by tense forms, simultaneity is the unmarked one.) When used this way, the present tense is an instance of what we have called ‘**SLOPPY SIMULTANEITY**’ (see 9.20.4). This term refers to the phenomenon that a tense form which is normally used to express T-simultaneity may be used in cases where the relevant situations are not (and are not conceived of as) W-simultaneous.

The clearest example of this sloppy simultaneity use of the present tense is when the two clauses contain distinct temporal adverbials, as in *If he does not do it tomorrow, I will do it myself next week*. Here the sole reason for using the present tense in the *if*-clause is that the two clauses are conceived of as belonging to one and the same intensional domain, viz. the possible world corresponding to the open condition. Because the speaker is concerned with the logical relation ‘if p, then q’ rather than with the exact temporal relation between the two situations, he typically uses the unmarked Pseudo- t_0 -System form (viz. the one expressing T-simultaneity), except in the rare cases where a more precise indication of the temporal relation is required or preferred (as in *If you haven’t left by tomorrow ...*). That this convention persists when distinct time expressions are associated with the descriptions of the two situations should not come as a surprise, for it is precisely in the cases where the temporal relation between the situations is signalled by time adverbials that it is least necessary for this relation to be expressed by the tense form of the conditional clause.

In adverbial time clauses we cannot use the Absolute Future System, except in some uses of *before*-clauses.

10.7.2 The Absolute Future System cannot normally be used in adverbial time clauses:

- I will leave before John {is / *will be} back.
- I will leave when John {has arrived / *will have arrived}.
- I will stay here until John {arrives / *will arrive}.

It has been noted in 2.14 (and will be argued in 13.3 and 14.2.1) that the situation time of such an adverbial time clause is temporally subordinated, not to the situation time of the head clause but to an ‘**IMPLICIT ORIENTATION TIME**’

in the semantic structure of the temporal conjunction. We interpret *before*, *when*, *until*, etc. as ‘before the time that’, ‘at the time that’, ‘until the time that’, etc. (Diachronically speaking, most temporal conjunctions have actually developed from such a prepositional phrase.) The word *time* in these paraphrases refers to the implicit ‘ANCHOR TIME’ to which the situation time of the subclause is temporally subordinated. Thus, in *I will leave before John is back*, the situation time of the subclause must not be related to t_0 (by the use of *will be* as an Absolute Future System form), nor to the situation time of the head clause (by the use of *will be* as a Pseudo- t_0 -System form), but must be temporally subordinated to the Anchor time that is implicit in *before*. (This Anchor time is posterior to the situation time of the head clause, but this relation is expressed by the conjunction only, not by the tense form – see Figure 10.3.) In *I will leave before John is back*, the situation time of the subclause is represented as T-simultaneous with the implicit orientation time: *before John is back* is interpreted as ‘before the time that / when John is back’.

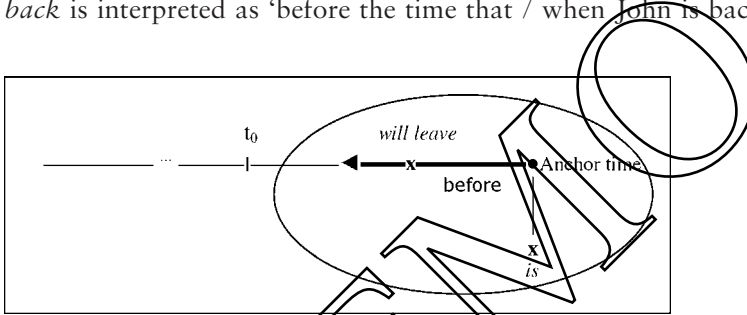

Figure 10.3. The temporal structure of *I will leave before John is back*.

The obligatory use of the Pseudo- t_0 -System in adverbial time clauses is again a convention typical of English and not shared by many other European languages. For example, the Dutch counterpart of *I will leave when John has arrived* may use either the Pseudo- t_0 -System or the Absolute Future System (but with a preference for the former):

Ik zal vertrekken wanneer Jan {aangekomen is / zal aangekomen zijn}.
 ‘I will leave when John {has arrived / will have arrived}.’

If the Absolute Future System is used, the temporal relation between the situation time of the subclause and the situation time of the head clause is expressed only by the conjunction, not by the tense forms (both of which relate their situation time to t_0).

In English, there appear to be only few cases in which the Absolute Future System can be used in an adverbial time clause. All of them concern *before*-clauses and will be dealt with in 14.5.2. In the present section we will restrict ourselves to pointing out two of them, just to illustrate the possibility.

One case in which the Absolute Future System is used in a *before*-clause is illustrated by the following:

You will need to register as a user of the Discussion Groups before you *will be* able to post any messages to the discussion. (www)

[If you have not gotten any updates from the FTP site for your system before,] you will most likely need to upgrade the *rpm* package before you *will be* able to confirm or install the new RPMs. (www)

Please note that students who fail the OS proficiency exam or the EE-450 placement exam twice will be required to take the corresponding undergraduate course (and receive a grade of B or better) before they *will be given* permission to take CSCI-551. (www)

I think those creating tablet PCs need a “killer app” to run on these units before they *will be* useful. (www)

In these examples the temporal relation between the two situations seems to be less important than the logical relation: the head clause expresses a condition for the actualization of the *before*-clause situation. Semantically, the *before*-clause is the head clause of the ‘if p, then q’ conditional. This probably explains why the *before*-clause can use the Absolute Future System typically found in head clauses.

The second case we will draw attention to here is illustrated by the following:

[In his preliminary report (...) sir Hugh Cairns stresses that] several years must elapse before he *will know* whether the improvements (...) are permanent. (TCIE)

It is just a matter of time before the trainee schools *will disappear* altogether from the scene. (LOB)

[I think my blog will continue to remain what it is – trivial! I think] there is still some time left before *it will be done* with blogging for good. (www)

In this type of sentence the head clause does not describe a situation whose time is specified by the time clause but indicates the distance between t_0 and a post-present orientation time identified by the subclause. The possibility of using the future tense in the subclause can be traced back to the fact that the head clause does not explicitly establish a post-present domain. On the other hand, the head clause can be interpreted as doing so implicitly, and this entails that the Pseudo- t_0 -System can also be used (and is in fact often the more natural choice):

[Looking at the bottom row in the table below, it appears that] we have some time before we *reach* the critical halfway point for oil production. (www)

[In the North, Sinn Féin ministers are sitting in Stormont, and] it is a matter of time before the party *enters* into coalition government in the South. (www)

There is still some time left before these measures *begin* to be used. (www)

A final note to be made in connection with adverbial time clauses is that (apart from the exceptions just referred to) they do not allow the (temporal) use of *will* at all, i. e. *will* is ungrammatical not only as an Absolute Future System form but also as a Pseudo- t_0 -System form. The Pseudo- t_0 -System form expressing posteriority must be formed with the help of a futurish form like *be going to*:

I promise I will put on my goggles when pieces of metal {*are going to fly about* / **will fly about* / **will be flying about*}.

She will go back to her mother's when she {*is going to* / *is about to* / **will*} have the baby.

The reason why *will* cannot be used must have to do with the fact that posteriority in adverbial time clauses is always equivalent to the 'PROSPECTIVE' meaning (i. e. futurity with present orientation) which in English is typically expressed by *be going to*. (See 7.3.2, where it was explained that the basic meaning of *is going to* is that the post-present situation has its roots in the present.)

10.7.3 As noted in 10.6.10, restrictive relative clauses depending on a temporal noun require the Pseudo- t_0 -System when the temporal noun forms part of a phrase functioning like a temporal conjunction:

By the time the fire brigade {*arrive* / **will arrive*} it will be too late.

[And remember, the clutch is not a gradual affair like the one on a car.] The instant you {*engage* / **will engage*}, the machine will rush away, with or without you. (LOB)

You must stop the engine the moment (that) it {*begins* / **will begin*} to make a strange noise.

The subclasses of such examples have the same function as adverbial time clauses, which require the use of the Pseudo- t_0 -System (see 10.7.2).

10.7.4 *That*-clauses depending on the noun *time* use the Pseudo- t_0 -System in adverbials of frequency (if the head clause uses the Absolute Future System):

[Read the story aloud.] The computer will stop you each time it {*has failed* / *fails* / **will have failed* / **will fail*} to understand something you have said.

This will force UNP to ask you if you want to remove the routine UNP found on the file each time it *has recognized* some program's work. (www) (*Recognizes is fine too, but not will have recognized or will recognize.*)

You will be notified each time you *have accrued* 60 minutes of CME credit time. (www) (**will have accrued*)

Each time you *accrue* an additional 100 miles, a posting will be made to your Mileage Plus account. (www)

10.7.5 *Wh*-clauses with a conditional connotation also use the Pseudo- t_0 -System for future time reference:

Saddam's ministers said the U.S. will attack regardless of whether Iraq *allows* UN weapons inspectors to return. (www)

[However, the displacement of the cylinder can be converted to cubic centimetres.]
The compression ratio arrived at with the formula will be the same regardless of whether cubic inches or cubic centimetres *are used*. (BR)

10.7.6 Concessive subclauses introduced by a *wh*-word in *-ever* normally use the Pseudo- t_0 -System if they have a conditional connotation (and, as usual, if the head clause has future time reference):¹¹

[Playing staff is to be reduced from 26 to about 18, because] whatever the Football Combination *decide* Millwall will not field reserve teams on Saturdays next season. (LOB) (*??will decide*)

However the money {*is shared* / *??will be shared*}, some people will be dissatisfied.

The subclauses in these examples function as adverbials that combine a concessive aspect of meaning with a conditional one. Thus *whatever the F. C. decide* means 'if decision A is made, and if decision B is made, and also if decision C is made, etc.'. As a matter of fact, concessive clauses have a conditional connotation (and therefore use the Pseudo- t_0 -System) when they do not refer to the actualization of a single situation but imply the actualization of one of several alternative situations. Concessive clauses that do not satisfy this condition for a conditional connotation use the Absolute Future System to refer to post-present actualization:

The posting of the code will not cause any immediate and catastrophic loss of money to the DVD media creators, whatever they *will crow* in the media. (www) (*The meaning is purely concessive: 'even though they will crow something in the media, whatever that may be.'*)

10.7.7 The Pseudo- t_0 -System is also the rule in subclauses of proportion:

The sooner the job {*is finished* / *??will be finished*}, the better.

The more people we {*tell* / *??will tell*} about it, the more difficult it will be to keep it secret.

11. The following are some exceptional examples in which the Absolute Future System is used. (The Pseudo- t_0 System could be used too.)

The leaders of their union – whoever they *will be* at that time – will join the chorus of mainstream labour leaders in deploring privatization. (www)

[The level of supervision needs to be related to the level of responsibility you give them.] Whatever they *will be doing*, you will get better results out of them if you give them some early support. (www)

Here again the conditional connotation appears to be the reason for the choice of the Pseudo- t_0 -System. We can paraphrase *The more people we tell, the more difficult it will be to keep it secret* as follows: 'If we tell X number of people, it will be X amount difficult to keep it secret, and if we tell X+1 number of people, it will be X+1 amount difficult to keep it secret'.

10.7.8 Subclauses of manner that are fully integrated into the head clause also use the Pseudo- t_0 -System:

I hope that next time you will do as I {say / ²will say}.

Here again there is a conditional connotation: 'I hope that if I tell you to do something, you will do it'.

10.8 Subclauses which cannot use the Pseudo- t_0 -System

The Pseudo- t_0 -System is not used at all in subclauses such as adversative clauses, comment clauses, nonrestrictive relative clauses, concessive subclauses introduced by (*al*)*though*, subclauses of reason introduced by *for*, and in some types of conditional subclauses. The following give an example of each. (The # sign indicates the unsuitability of a Pseudo- t_0 -System form rather than ungrammaticality.)

- (8a) I'll be in London tomorrow, {*whereas / while*} Bill {*will be / #is*} at home. (*adversative subclause*)
- (8b) As you {*will see / #see*}, he will not come tomorrow. (*comment clause*)
- (8c) I will give it to Tom, who {*will be / #is*} glad to get it. (*nonrestrictive relative clause*)
- (8d) We had better put off discussing this matter until next week, when we *will have* more information. (*when-clause used as nonrestrictive relative clause: when = 'at which time'*)¹²
- (8e) I will accept the invitation, although I {*will not enjoy / #do not enjoy*} the concert.
- (8f) You will notice very few changes in the person that you see, for I will be the person that I always have been. (www) (*The for-clause is like an 'evidential' because-clause – see 10.6.4 above: it expresses the speaker's justification for thinking what's expressed in the first clause.*)
- (8g) If, as you say, Bill *will be coming* here himself next week, I will not need to send him a letter. (*conditional clause expressing a closed condition*)

12. The Absolute Future System is obligatory in nonrestrictive relative time clauses. This means that the *when*-clause of sentences like *I will repair the car tomorrow, when I have more time* is not a relative clause but an adverbial one (which is used in apposition to *tomorrow*).

(8h) If, as you say, this decision {*will upset* / #*upsets*} her, I will consider changing it. (*idem*)

(8i) We won't do it if it *will upset* him (if we do it). (*See comment below.*)

In (8a–f) there is a rather loose syntactic and semantic relation between the two clauses.¹³ The subclause has a large measure of syntactic independence and is not integrated into the head clause semantically, as the latter can be fully interpreted without reference to the subclause. What is expressed in the subclause is the speaker's comment on the head clause situation. This comment is made at t_0 , not at the post-present situation time of the head clause, and it is meant to be interpreted transparently. This explains the obligatory use of the Absolute Future System.

In (8g–h) the Absolute Future System must be used in the conditional clause because this clause expresses a 'closed' condition rather than an open one. That is, the future fulfilment of the condition is assumed to be certain at t_0 . The following is another instance of such a (typically echoic) 'closed' conditional:

If you *will not be* in receipt of a scholarship or Award or if the Award *will be* inadequate to meet full fees and expenses of your course and your maintenance, please state how you propose to meet those fees and expenses. (*www*)

Finally, sentence (8i) [*We won't do it if it will upset him (if we do it)*] shows that the Absolute Future System is also the rule in *if*-clauses that serve as head clause for another *if*-clause (whether overtly present or implied). In this type of conditional, whose logical structure is 'if [if *q*, then *p*], then *q*', we have to use the Absolute Future System in what looks like a conditional clause but is really the head clause of another conditional – see also 10.6.8 above. The reason why the Absolute Future System form *will upset* has to be used is that (syntactically and semantically) this clause does not have a head clause establishing a post-present domain: the whole conditional means 'We won't do it if [if we do it it will upset him]'. That is, the clause *it will upset him* is not directly subordinate to *we won't do it*. It is a head clause rather than a conditional clause, even though it is preceded by *if*. The following is a similar example:

If it'll *make* you feel any better, I'll buy you a drink. (= 'I'll buy you a drink if it'll make you feel any better if I buy you a drink.')

13. The fact that the subclauses of (8a–f) are not syntactically integrated into their head clauses appears from a number of observations. For example, they cannot be the focus of negation, questioning or clefting, and they are not mopped up in the reference of pro-forms like *do so* or *and so* / *neither*.

IV. Further remarks

10.9.1 One remark that can be added to the above conclusions is that the distinction between the Absolute Future System and the Pseudo- t_0 -System for reference to the post-present runs perfectly parallel to the distinction between the conditional tense (or *was going to* + verb) and the preterite for reference to a time that is W -posterior to a past orientation time. Compare:

- (a) I *will punish* him if he $\{is / *will\}$ late.
- (b) [I told him] I *would punish* him if he $\{was / *would\}$ late.
- (a) John $\{will\}$ be / $\#is\}$ happy to hear that, whereas his wife $\{will\}$ be / $\#is\}$ upset.
- (b) [I expected that] John $\{would\}$ be / $\#was\}$ happy to hear that, whereas his wife $\{would\}$ be / $\#was\}$ upset.

This parallelism between the distribution of the Absolute Future System *vs* the Pseudo- t_0 -System and that of the conditional tense *vs* the preterite extends to conditionals that have a **TENTATIVE** or **COUNTERFACTUAL** meaning.¹⁴ (In this type, past time-sphere tenses are used to express remoteness from reality rather than reference to past time.) We have seen that we cannot use *will* in open conditionals, unless the *if*-clause itself functions as head clause for another (overt or implicit) *if*-clause. In the same way we cannot use *would* in tentative and counterfactual *if*-clauses, unless the clause in question itself supports an *if*-clause:

- (a) It would upset her if that $\{happened / *would\}$ happen.
- (b) If, as you say, that man $\{would\}$ be / $\#was\}$ able to open our safe (if he had the right instruments), we should consider buying another, more sophisticated one.

The reason for this perfect correlation between the expression of T -posteriority in the present and past time-spheres may well be that it is both simpler and more economical to use parallel systems in the two time-spheres than to work with a different set of rules in each time-sphere.

10.9.2 In this chapter we have been mainly concerned with the use of the present tense versus that of the future tense in subclauses referring to the post-present. However, this distinction is just one instance of the more general distinction between the Pseudo- t_0 -System and the Absolute Future System, and we

14. A conditional has a tentative meaning if it refers to a possible world which is assumed by the speaker to be unlikely to be (or become) the actual world (e.g. *You would be punished if you did that*). A conditional is counterfactual if it refers to a possible world which is assumed by the speaker to be different from (incompatible with) the actual t_0 -world (e.g. *My life would be easier if I had a car*).

could have referred to other tenses to illustrate the different distributions of these systems. Consider, for example, the following:

[If we dump his body in Soho,] the police *will think* that he *was killed* there after he *had been* unable to pay his gambling debts.

In this sentence the Absolute Future System form *will think* indicates the central orientation time of a post-present domain and *was killed* is a Pseudo- t_0 -System form representing its situation time as lying in the past of this central orientation time. Since the situation of being killed is thus treated as if it were a past one (i. e. it is represented as past relative to the central orientation time which is treated as if it were t_0), the past perfect (*had been*) is used to represent a situation as T-anterior to it. This form too is a Pseudo- t_0 -System form, as it incorporates its situation time in the post-present domain. As a matter of fact, because the domain is created by *will think*, which is a ‘**STRONG INTENSIONAL VERB**’ (see 10.6.6), the use of Pseudo- t_0 -System forms in the subclauses is obligatory. The sentence becomes ungrammatical if we replace the Pseudo- t_0 -System forms *was killed* and *had been* by the Absolute Future System forms *will have been killed* and *will have been*:

[If we dump his body in Soho,] the police will think that he {*was killed* / **will have been killed*} there after he {*had been* / **will have been*} unable to pay his gambling debts.

Examples like these make it clear that the use of the present tense *vs* the future tense for post-present time reference should not be investigated in isolation. It is just one instance of the more general distinction between the Pseudo- t_0 -System and the Absolute Future System.

10.9.3 It should be noted, finally, that the past counterparts of the Pseudo- t_0 -System and the Absolute Future System show the same distribution as the Pseudo- t_0 -System and the Absolute Future System, respectively:

- (a) If John {*arrives* / **will arrive*} tomorrow, I {*will fetch* / **fetch*} him from the station.
- (b) [I said that] if John {*arrived* / **would arrive*} the next day, I {*would fetch* / **fetched*} him from the station.
- (a) You {*will live* / **live*} to see the day when China {*is* / *will be*} an economic superpower.
- (b) [I predicted that] they {*would live* / **lived*} to see the day when China {*was* / *would be*} an economic superpower.

See also the discussion of direct and indirect binding in 9.28–29.

V. Summary

10.10.1 The basic difference between the Absolute Future System and the Pseudo- t_0 -System is that absolute tense forms relate the situation time to t_0 , whereas tense forms from the Pseudo- t_0 -System relate it to a post-present 'basic orientation time'. From this it follows that an Absolute Future System form creates a post-present domain (which is at the same time a temporal domain and an intensional one), whereas the Pseudo- t_0 -System expresses a relation in an already existing domain. This means that the temporal specification effected by an Absolute Future System form is independent of the surrounding linguistic context, whereas that effected by a Pseudo- t_0 -System form is not. A Pseudo- t_0 -System form requires a linguistic context providing the necessary post-present basic orientation time. The use of the Pseudo- t_0 -System in a subclause is then a sign that the situations referred to in the subclause and the head clause are closely related to each other, not only temporally but also logically: the subclause is fully integrated into the head clause, and the two situations are presented as forming an interpretive unit.

10.10.2 We have discussed the typical cases of subclauses requiring either of the two systems as well as those that are compatible with both, and we have pointed out some factors that are relevant to the distribution of the two tense systems:

- (a) Generally speaking, the subclauses that allow or require the use of the Pseudo- t_0 -System belong to one of the following types: subclauses functioning as subject or object of the predicate of the head clause (with the exception of those discussed in 10.4.6), restrictive relative clauses, and subclauses functioning as adverbials that are fully integrated in the head clause (i.e. functioning as 'adjuncts' rather than 'disjuncts' (Quirk et al. 1985: 1071).
- (b) The categories of subclause in which the Pseudo- t_0 -System has to be used express or connote some kind of open condition for the actualization of the head clause situation.

11. Tense choice determined by temporal focus

11.1	Definition of 'temporal focus'	573
11.2	The unmarked or marked choice of temporal focus	576
11.3	The manipulation of temporal focus for a specific purpose	581
11.4	Summary	585

DEMO

Abstract

In this chapter we examine the phenomenon of ‘temporal focus’. When a speaker locates a situation time using an absolute tense, there are cases in which the full situation including the situation time extends (or is conceived of as extending) over more than one time-zone, and in these cases there is a choice as to the time-zone in which the predicated situation is located. There are two conflicting influences on the choice of temporal focus when using absolute tenses: the salience of the present moment in those cases in which it is included in the time of the full situation, and the temporal focus of the surrounding discourse. When there is a clear conflict between one of these influences and the choice of time-zone (= choice of temporal focus) made by the speaker, we talk of ‘marked temporal focus’. We

speak of a ‘shift of temporal focus’ when the discourse switches from focus on one time-zone to focus on another. A shift of temporal focus from the present to the past may call up a past point of view from which a situation was observed and, often, evaluated. This is often exploited in narrative. Such a shift of temporal focus from the present to the past may also imply nonapplicability at speech time. (Thus *I was going to help you tomorrow* differs from *I am going to help you tomorrow* in that it suggests that my past intention is no longer valid.) In the case of relative tenses, temporal focus involves not just a question of location in a particular time-zone but also a question of whether the focus is on the situation time or on the orientation time to which it is temporally subordinated.

DEMO

11.1 Definition of 'temporal focus'

The 'temporal focus' of a speaker is the time on which, through a particular tense choice, he focuses in the use of any given clause. In connection with absolute tenses, temporal focus can be defined as the phenomenon that the speaker draws attention to a particular kind of time – past, pre-present, present or post-present – by locating a situation time in the corresponding 'absolute time-zone'. This means that temporal focus is recoverable from the tense alone.

11.1.1 A tense form always establishes a 'situation time' (i.e. the time of a 'predicated situation' – see 2.12) and locates it in a particular 'absolute time-zone' (see 2.37) or, if it is a 'relative tense' (see 2.15.3), in a 'temporal domain' (see 2.15) whose 'central orientation time' (8.15) is located in a particular time-zone. The choice of tense reflects the choice of time that the speaker wishes to focus his attention on. This is most easily illustrated with absolute tense forms: when using the present tense the speaker focuses on the time with which the situation time coincides, viz. t_0 . When using the absolute past tense he focuses on the past time-zone in which the situation time is located. Hence the difference between *is* and *was* in *He is no longer the brilliant scientist that he was*.

It is when the 'full situation' (see 2.12) encompasses both the past and the present time-zones that the notion of temporal focus seems most pertinent. As will be explained below, the difference between *The man who left just now is a sales representative* and *The man who left just now was a sales representative* is a question of **TEMPORAL FOCUS**: using *is*, the speaker just says what is the current profession of the man who left just now; by using *was*, the speaker focuses on a given past time, which in this context will naturally be the time when the addressee saw the man leave and perhaps wondered who he was.

11.1.2 Focusing on a time at which a situation time is located requires that the time in question be somehow identifiable to the hearer or reader. This is normally the case if there is a time-specifying adverbial, because the speaker's temporal focus is then narrowed down to the Adv-time which 'contains' (= includes or coincides with – see 2.23.1) the situation time in question. This explains the difference between the following:

The milk *is* sour. (*focus on t_0 , which is by definition identifiable*)

The milk *was* sour. (*This is not fully interpretable in isolation. We need to know what time the speaker is focusing on.*)

The milk *was* sour when I opened the bottle. (*This is fully interpretable because the time-specifying adverbial narrows down the speaker's focus to a definite past time.*)

The word ‘definite’ in the comment to the last example may mean either ‘REFERENTIAL’ or ‘ATTRIBUTIVE’ in Donnellan’s (1966) sense. That is, it is not necessary that the time of opening the bottle is definite in the sense that the speaker knows (and assumes the hearer to know) when exactly it was that the bottle was opened (= the referential reading). It is sufficient that the speaker knows (and assumes that the hearer knows) that the bottle was opened, hence that there exists a time when the bottle was opened, even if they do not know the exact temporal location of that time (= the ‘attributive’ reading). The latter reading is sufficient because the message that the speaker wants to convey is that the milk was already sour in the unopened bottle. The question when exactly the bottle was opened is quite immaterial to this.

The time focussed on by the speaker can be recoverable not only from a time-specifying adverbial but also from the context. Compare:

The paint was white. (*not fully interpretable in isolation*)

[I asked John about the colour of the paint.] It was white. (*The situation time is interpreted as W-simultaneous with the time when I questioned John.*)

The latter example can be modified so that the second clause refers to the present:

[I asked John about the colour of the paint.] It is white.

In this case the **SHIFT OF TEMPORAL DOMAIN** (see 8.21) implies a **SHIFT OF TEMPORAL FOCUS** from the past to the present.

In the case of relative tenses, temporal focus is also reflected in the tense chosen. However, a relative tense involves (at least) two orientation times: the situation time and the time of orientation by which the situation time is bound in a relation of simultaneity, anteriority or posteriority. The temporal focus may be on the situation time or the binding time, so that (except when the relation between the two is T-simultaneity), we rely on adverbials and other contextual factors as well as tense to ascertain more exactly where the temporal focus is located.

11.1.3 In the previous section, only examples with an ‘absolute tense’ (see 2.41) were given. In connection with absolute tenses, ‘temporal focus’ can be defined as the phenomenon that the speaker draws attention to a particular kind of time – past, pre-present, present or post-present – by locating a situation time in the corresponding ‘absolute zone’ (see 2.37). The choice of temporal focus is thus revealed by the choice of absolute tense. For a full temporal

interpretation of the clause, the time focused on needs to be identifiable in some way. This may be through the use of a time-specifying adverbial or through interpreting the situation time as standing in a particular 'W-relation' (see 2.16.1) to a situation time that is present in the context, or through making use of other information that is pragmatically available (such as our general knowledge of the world). However, the latter elements do not create the temporal focus: they just help to identify what time exactly is focused on. *It is the use of a tense form that creates a temporal focus*: the very fact that the speaker uses a tense means that he has a particular absolute time-zone in mind, in which he locates the situation time.

11.1.4 In connection with 'relative tenses' (see 2.15.3), 'temporal focus' can again be defined as the phenomenon that the speaker draws attention to a particular time by choosing a particular tense. For a full temporal interpretation of the clause, the time focused on again needs to be identifiable in some way. This may be through the use of a time-specifying adverbial or through representing the situation time as standing in a particular 'T-relation' (see 2.16.1) to the binding orientation time. In the latter case there are two possibilities. Relative tenses representing their situation time as T-anterior or T-posterior to a binding orientation time in principle allow the temporal focus to be placed either on the binding orientation time or on the bound situation time. (In the case of relative tenses expressing T-simultaneity the difference between the two possibilities is neutralized, because the bound situation time then coincides with the binding orientation time – see 2.17.) The following examples illustrate this double possibility:

["Did you see John?"] – "No, he *had* already left when I arrived around ten o'clock." (*The temporal focus is on the time to which John's leaving is T-anterior. It is this time (viz. the time of my arrival) that is indicated by the when-clause.*)

[John was no longer there when I arrived, because] he *had* left earlier, together with Linsey. (*The temporal focus is on the bound situation time, i. e. on the time of John's leaving. This time is specified by a time-specifying adverbial (earlier), while the time of my arrival is not.*)

At five p.m. John was going to leave. (*The temporal focus is on the binding situation time, i. e. on the time when it was the case that John intended leaving. It is this time that is specified by the time-specifying adverbial. Would leave cannot substitute for was going to leave.*)

[She said that] John was going to leave at five p.m. (*The temporal focus may still be on the binding situation time, but it is more likely to be on the bound situation time. That is, the unmarked reading is that on which at five p.m. specifies the time of John's leaving. It is only on this reading that would leave can substitute for was going to leave.*)

11.2 The unmarked or marked choice of temporal focus

We can talk of ‘marked’ and ‘unmarked’ temporal focus when the speaker has a choice as to which tense to use to refer to a situation. As far as absolute tenses go, this amounts to a choice as to the time-zone in which the situation is located, that is, a choice as to the relation between the situation time and t_0 . There are two major factors in deciding on tense choice when a choice exists between two or more absolute tenses. On the one hand, if the discourse is ‘about’ a particular time-zone – if other situations in the surrounding discourse are located in a particular zone – then, all other things being equal, the unmarked choice for a situation which is to be introduced into the discourse is location in the same time-zone. On the other hand, if the time of the full situation includes t_0 but also extends into one or more other time-zones, then, all other things being equal, it is more relevant to represent the situation as located at t_0 . When the time of the full situation does extend over the present time-zone and some other time-zone(s), then, these two influences on tense choice for absolute tenses compete. For example, if Meg is staying in my house now and will still be here for the next few days, then out of context, it is more informative to tell an addressee *Meg is here* than to tell the addressee *Meg will be here*. However, if I am talking about events that will take place in my home tomorrow (for example “*We’re going to have a barbecue*”) it is more informative to say “*Meg will be here*” than “*Meg is here*”.

11.2.1 Needless to say, the choice of temporal focus can only be ‘**MARKED**’ if there is an ‘**UNMARKED**’ alternative, i. e. if the situation can be located in time by more than one tense. This is not the case in examples like the following:

My father *died* in 1998.

That man believes that the world *will perish* at the next full moon.

However, more than one temporal focus is possible when the reference is to a situation which lies completely before t_0 : compare *I have already locked up* (= focus on the pre-present) with *I locked up at seven* (= focus on a past time). If the reference is to a durative ‘homogeneous’ (see 1.45) situation including t_0 , there is no restriction on the choice of focus. Thus, when Greg is currently spending a two-week holiday at my home, all four absolute tenses can be used to focus on different parts of that two-week period:

I can’t accompany you to the railway station now because Greg *is* here.

Greg *has been* here for almost a week now.

Jenny paid us a visit two days ago because Greg *was* here. [She was eager to see him.]

The reason Maud has invited herself to tomorrow’s party is that Greg *will be* here. [She wants to see him at all costs.]

The different tenses here refer to different times within the period of Greg staying at my house. As appears from the following, the choice of tense form expressing a particular focus is constrained by the time referred to in the context (as well as by the speaker's and hearer's knowledge of the fact that Greg is currently staying at my home):

- (1) I can't accompany you to the railway station now because Greg {*is* / #*was* / #*has been* / #*will be*} here. (*The # sign means 'unacceptable on the intended interpretation', which comes down to 'unacceptable in the given context'.*)
- (2) Jenny paid us a visit two days ago because Greg {*is* / *was* / #*has been* / #*will be*} here. [She was eager to see him.]
- (3) The reason Maud has invited herself to tomorrow's party is that Greg {*is* / #*was* / #*has been* / *will be*} here. [She wants to see him at all costs.]

There appear to be two conflicting tendencies at work here. One follows from the privileged temporal status of t_0 , which is the pivot time of the whole tense system. This privileged status renders it possible for the present tense to be used in each of the above examples. Since the present tense means 'The situation time coincides with t_0 ' (see 3.1.1), and since, other things being equal, statements about the present are more relevant than statements about some other time, there is a natural tendency to use the present tense to talk about situations that include t_0 . In this sense the present tense is the unmarked tense. However, the 'other things being equal' condition is not satisfied in (2) and (3), because the reference to Greg's 'being here' is made in a context dealing with a past or post-present time. This means that, in this sense, the present tense is the marked choice because it 'shifts the focus' from the time referred to in the context to t_0 . In this sense, the unmarked forms in (2) and (3) are *was* and *will be*, respectively: they are the unmarked forms in the sense that they fit in with the context, i.e. with 'what the discourse is currently about'. This tendency too can be traced back to the Gricean Maxim of relevance: in a context about the past (or post-present), a statement about the past (or post-present) is more relevant than a statement about another time. This implies that, in a context dealing with the past, a statement about the past might be more readily interpretable than a statement about the present.

Of the two conflicting tendencies, the former appears to be the stronger in (2) and (especially) in (3): *is* sounds more natural than *was* in (2), and definitely more natural than *will be* in (3), which actually implicates that Greg is not yet here at t_0 . However, that implicature can easily be blocked, for example, by the addition of *still*:

- (3') The reason Maud has invited herself to tomorrow's party is that Greg {*is* / *will still be*} here. [She wants to see him at all costs.]

11.2.2 Let us illustrate the effects of the conflicting tendencies with the help of another example. Since the present tense means 'The situation time coincides

with t_0 , and since (other things being equal) statements about the present are more relevant than statements about some other time, it is normal for us – at least in sentences used out of context – to use the present tense to talk about any situation that includes t_0 . Thus, since it is presently the case that the Eiffel Tower is in Paris, this fact will normally be reported in the present tense: *The Eiffel Tower is in Paris*. Out of context, sentences like *The Eiffel Tower was in Paris*, *The Eiffel Tower has been in Paris* or *The Eiffel Tower will be in Paris* are odd, because they reveal a **MARKED FOCUS** on a time other than t_0 , while such a time is neither specified nor inferrable from the sentences in isolation. The use of *was*, *has been* or *will be* can only be interpreted as meaning that the speaker is consciously focusing on an absolute time-zone other than the present, hence that the statement *The Eiffel Tower is in Paris* cannot be appropriately uttered because it is not true at t_0 . This is why *The Eiffel Tower {was / has been / will be} in Paris* wrongly suggest that the Eiffel Tower is not in Paris now.

However, there is no such suggestion in the following sentence:

My grandfather insisted on going to Paris because the Eiffel Tower *was* there. [He wanted to paint it.]

Because the relevant clause forms part of a past context, the past tense is the unmarked form here. This is in keeping with the above observation that there is a tendency to choose the tense which fits in with what the current discourse is about. The other tendency, viz. that the present tense is preferred when the full situation includes t_0 , is the weaker tendency here, probably because the fact that the Eiffel Tower still exists in Paris is irrelevant to the message the speaker wants to convey. In other words, in this example the time of my grandfather's past visit to Paris is more relevant than t_0 .

When it comes to relative tenses, markedness has to do, not with the choice of where the situation is located relative to t_0 , but rather with the choice of where it is located relative to the binding time. Just as, in the case of absolute tenses, simultaneity with t_0 – i. e. location in the present – is the unmarked option where it is possible (albeit with the competing factor of the temporal location of the current discourse), so in the case of relative tenses, T-simultaneity with the situation time of the head clause is the unmarked option where it is possible. In some cases, though, there may be a choice between expressing simultaneity with the head clause situation time and expressing a different relation to a different time, to which the situation time is indirectly bound.

11.2.3 In 11.2.1–2 we have only discussed sentences that use an absolute tense form. However, the two tendencies observed in connection with these have their counterparts in clauses that use a relative tense form.

There is a natural tendency to use a tense form expressing T-simultaneity if the bound situation time (= time of the predicated situation) is to be interpreted as W-simultaneous with the binding orientation time. This follows from the fact that, other things being equal, T-simultaneity is the unmarked T-relation – see 9.20.4). Thus, the sentence

Bill told his children yesterday that the Eiffel Tower *was* in Paris.

is fully acceptable because it rightly states that, when Bill told his children about it yesterday, the Eiffel Tower was in Paris.¹ However, the following examples, in which the complement clauses locate their situation times respectively anterior and posterior to the time of the telling, are pragmatically unacceptable because they wrongly suggest that the Eiffel Tower was not in Paris when Bill told his children about it:

Bill told his children yesterday that the Eiffel Tower *had been* in Paris.

Bill told his children yesterday that the Eiffel Tower *would be* in Paris.

Still, the tendency to use a relative past tense (expressing T-simultaneity) if there is W-simultaneity in the actual world may, under certain conditions, be overruled by the tendency to use a tense that is in keeping with the situation time's temporal W-relation to the central orientation time of the past domain:

Bill told me that Greg had stayed at his house for two weeks and that his daughter had been quite unmanageable because she ~~was~~ *had been* infatuated with Greg.

The use of *had been* [*infatuated*] is an example of 'indirect binding' (see 9.28.1), which is only possible in some types of subclause. The speaker focuses on the relation of W-anteriority of the situation referred to by *had been* [*infatuated*] to the situation referred to by *told* rather than on the relation of W-simultaneity of the situation referred to by *had been* [*infatuated*] with the situation referred to by *had been* [*unmanageable*]. (Focus on the latter relation would be expressed by the relative past tense form *was* [*infatuated*].)

11.2.4 As a further illustration, consider the following sentences:

The author of this book *is* my nephew.

The author of this book *was* my nephew.

When used in isolation, the second sentence suggests that the referent of the subject NP is no longer the speaker's nephew. The temporal focus expressed is therefore unmarked only if the person in question is indeed no longer the

1. Since not only the head clause situation but also t_0 is included in the subclause's full situation, the speaker may also say *Bill told his children yesterday that the Eiffel Tower is in Paris*. In that case there is a shift of domain from the past to the present zone.

speaker's nephew, for example because he has died. On the other hand, there are contexts in which *X was my nephew* is the unmarked version even though the person in question is still the speaker's nephew at t_0 . Thus, when my secretary comes into my office just as a visitor is leaving it, I am more likely to say *That was my nephew* than *That is my nephew* to inform her of the identity of the person who has just left. This preference follows from the fact that the past tense is the unmarked tense in a past situational context. In this example, it is natural for the speaker to place the temporal focus on the moment when the secretary saw my nephew and perhaps wondered who he was.

11.2.5 The following example further illustrates how the past tense can express an unmarked temporal focus:

- (4) ["Let's rehearse the concerto we are playing tonight." – "We can't do that here! Don't you remember that notice on the receptionist's desk that *stated* that no musical instruments *could* be played in the hotel rooms?"]

If the second speaker had said

- (5) Don't you remember that notice on the receptionist's desk that *states* that no musical instruments *can* be played in the hotel rooms?

he would have placed the temporal focus on t_0 (the time of his utterance). Instead, he has preferred to put the temporal focus on the time when he and the addressee checked in at the hotel and read the notice on the receptionist's desk. In this way the situations are located in the past time-sphere rather than in the present one, and this is the unmarked tense choice in the given context.

Example (4) illustrates the possibility of an unmarked past temporal focus in clauses that are not bound (\neq temporally subordinated). The following is an example in a clause whose situation time is bound:

- (6) [After we had unpacked, Bill suggested that we should rehearse the concerto we were playing that evening. I pointed out that we could not do that there, as] there *had been* a notice on the receptionist's desk which *had stated* that no musical instruments *could* be played in the hotel rooms.

In the same way as the preterite *stated* in (4) locates the situation (which still holds at t_0) at some time before t_0 , *had stated* in (6) represents its situation as T-anterior to the relevant binding orientation time (= the situation time of *pointed out*). (The same is true of *had been*, so that had stated is an instance of 'indirect binding' – see 9.28.) In the given context (in which the speaker is clearly concerned with the past), the T-anteriority form *had been* represents the unmarked choice of temporal focus.

11.3 The manipulation of temporal focus for a specific purpose

A shift of temporal focus from the present to the past can result in an implicature of nonapplicability at t_0 . For example, when the verb form used expresses posteriority, a shift of temporal focus to the past suggests that what was foreseen at some past time is no longer foreseen: *I was going to go to Cuba this summer* is naturally understood as implying ‘but I am no longer going to do so’. (Given the salience of the present moment, there is an assumption that if an intention is still valid it will be located in the present. The use of the past form of *be going to* locates the intention in the past and implicates that the intention is no longer valid.)

11.3.1 One of the possibilities inherent in the English tense system is that the speaker may sometimes ‘SHIFT THE TEMPORAL FOCUS’ from the present to the past in order to suggest that a situation no longer holds (or may no longer hold) at t_0 . The following observations illustrate this. As pointed out in 7.10, we can use the present tense of *be going to* to refer to an arrangement about the post-present that is valid at t_0 :

The shop *is going to* be closed tomorrow. (*The decision to close the shop must have been taken before t_0 , but the tense form does not refer to that time. The speaker just informs the hearer of the present existence of the decision.*)

However, the speaker can also say:

The shop *was going to* be closed tomorrow.

Out of context, this sentence strongly suggests that the decision made in the past is suspended at t_0 . The speaker now uses *was going to*, which expresses T-posteriority in a past domain (see 9.6.3). However, as is clear from *tomorrow*, the actualization of the situation is to be interpreted as W-posterior to t_0 . Other things being equal, statements about the post-present are more easily linked to t_0 than to a past time. By using *was going to* instead of *is going to*, the speaker adopts a marked temporal focus: he relates the post-present situation (of the shop being closed) to the past time when the decision was made rather than to the present time at which the decision should normally be valid. The only reason why it could be relevant for him to do so is that his belief in the present validity of the decision is suspended at t_0 . By using *was going to* the speaker not only avoids having to commit himself to a positive assertion concerning the post-present actualization of the situation referred to but also suggests that he cannot represent the arrangement as currently existing. This produces the implicature that the decision is no longer valid at t_0 .

It is important to see that what we observe in such sentences is a shift of temporal focus, not a shift of temporal perspective. A shift of perspective would mean that the past tense was understood as referring to a situation which actually belonged to a nonpast zone. This is not what we observe here. What we observe is that the focus is placed on the pastness of the decision rather than on its present relevance.

A shift of temporal focus from the present to the past (i. e. the use of a past tense when the present tense is possible in terms of pure reference) can invoke a past point of view (which may belong to the speaker at some past time or to some other person). For example, a passenger in a car may say to the driver *There was a beautiful farm just back there*, meaning ‘we’ve just passed a beautiful farm’. Clearly the farm is still in the same place, but the passenger, by referring only to that part of the full situation of the farm’s being there which is located in the past (presumably at the time of the car’s passing it), invokes his point of view when he saw it. (If, instead, he said *There is a beautiful farm just back there*, he would no longer be simply referring to his experience of the farm but would be implying that the existence of the farm has some current relevance as yet unexplained.)

11.3.2 Perhaps the main reason for shifting the temporal focus from the present to the past is that the speaker wishes to represent a situation which encompasses both present and past from the past **POINT OF VIEW** of someone else. (As is well-known, a hearer or reader more easily identifies and empathizes with someone (such as a character in a story) if the events are told from that person’s point of view.) Compare, for example, the following sets of examples:

- (7) The hill *is* very steep.
 The capital *lies* in the middle of the forest.
 The man only *speaks* Russian.
- (8) They had difficulty in climbing, for the hill *was* very steep.
 They were brought to the capital, which *lay* in the middle of the forest.
 The police found they couldn’t interview the man yesterday because he only *spoke* Russian.

In the sentences in (7) the speaker assumes a present temporal focus. He locates the situation times at t_0 and in doing so represents the situations from his own temporal standpoint. In the sentences in (8), in contrast, the fact that the speaker prefers to use a past tense means that he wants to assume the temporal standpoint (and hence the narrative point of view) of the relevant participants

in the events: he wants to express that it was *they* who observed *then* and *there* that the situation referred to in the subclause was actualizing. (Note that the past tense forms do not represent a shift of focus or a marked focus: in a past tense context, using the past tense represents the unmarked choice of focus.)

The same comment also applies to *You will have difficulty in climbing, for the hill will be very steep*, where the choice of *will be* reveals that the speaker wants to represent the steepness of the hill from the future point of view of the climbing addressee.

11.3.3 That the speaker is sometimes free to choose a particular temporal focus is further illustrated by sentences like the following, which involve a modal auxiliary or semi-auxiliary:

(9) The man *had to be lying*. What he told us *could not be* the truth.

(10) The man *must have been lying*. What he told us *cannot have been* the truth.

Each of the clauses in these examples expresses a conclusion which is presented as the only possible interpretation or explanation of some situation. In (9), this conclusion is represented as one that was arrived at in the past and concerned a situation that was then actualizing; the speaker therefore assumes the temporal standpoint of the person drawing the conclusion, i. e. he locates the time of the situation of drawing a conclusion in the past (cf. *had to, could not*) and represents the time of the situation that is being interpreted (evaluated) as simultaneous with this (cf. *be lying, be the truth*). In other words, the clauses in (9) are instances of 'FREE INDIRECT SPEECH' (see 9.6.2). In (10), in contrast, the speaker expresses his own present conviction that a situation must have held in the past; he therefore locates the conclusion in the present zone (cf. *must, cannot*) and represents the situation interpreted as anterior to it (cf. *have been lying, have been the truth*). In other words, in both examples the temporal focus resides with what we might call the 'EVALUATION TIME' (i. e. the time when the inference is made), but this time is a past interval in (9) and a present one in (10). This means that the speaker has a choice of possibilities: he can put the temporal focus on his own t_0 , in which case *must have been lying* and *cannot have been [the truth]* express what he himself considers to be true at t_0 , or he can shift the focus to the past time of evaluation, in which case *had to be lying* and *could not be [the truth]* express the point of view of the experiencing consciousness (which may be the speaker himself) drawing these conclusions in the past.

11.3.4 There is a similar difference between a past focus (past evaluation of a situation that was then actualizing) and a present focus (present evaluation of a past situation) in pairs like the following:

- (a) He {*seemed / appeared / happened*} to be a reliable worker.
- (b) He {*seems / appears / happens*} to have been a reliable worker.
- (a) What Gordon did *was* warn the headmaster.
- (b) What Gordon did *is* warn the headmaster.
- (a) It *was* Bill who made the news public.
- (b) It *is* Bill who made the news public.
- (a) It *was* {true / a fact} that the population was starving.
- (b) It *is* {true / a fact} that the population was starving.
- (a) It *was* {interesting / puzzling} that the dogs did not bark.
- (b) It *is* {interesting / puzzling} that the dogs did not bark.

In each of the (b) examples the speaker uses the present tense in the head clause to express his own current evaluation of the subclause situation. In the (a) examples he uses the preterite to express how the subclause situation was appreciated in the past. The function of the tense of the head clause is thus to place the temporal focus on the time that is to be interpreted as the time at which the subclause situation is evaluated. (If the sentences were not used in isolation, these contrasts between present and past would have to be seen as a contrast between a tense-pattern that would represent unmarked temporal focus if the temporal focus were already on the present and one that would represent unmarked temporal focus if the temporal focus were already on the past.)

11.3.5 Examples involving an alternation of a present focus and a post-present focus are also available:

- (a) It *is* John who *will be* appointed.
- (b) It *will be* John who *is* appointed.
- (a) It *is* a fact that these weapons *will soon be* obsolete.
- (b) For a rapidly growing majority of people, it *will soon be* a fact that if they can't find you on the Internet, you *don't exist*. (www)

In the (b) sentences, the head clause refers to a post-present evaluation time. The subclauses refer to situations that will be evaluated at those times and which are therefore simultaneous with these times. (Since the head clause establishes a post-present domain, the subclause uses the present tense to express T-simultaneity — see 9.20.1.) In the (a) examples, the head clause expresses that the relevant evaluation time is the present. (Since the head clause does not establish a post-present domain, the subclause has to do so.) These (a) sentences therefore express a present conclusion concerning the post-present actualization of the situation referred to in the subclause.

In the following example the situation to be evaluated is represented as T-anterior to the post-present evaluation time:²

If there is a strike tomorrow, we'll *have worked* in vain yesterday.

This sentence involves a shift of temporal focus entailing a marked focus because the conclusion expressed in the head clause, which is actually reached at t_0 , is represented as a post-present conclusion. That is, the situation time of the head clause situation is represented as T-anterior to a post-present orientation time, although it could also have been expressed as anterior to t_0 . (In the latter case the sentence would have been *If there is a strike tomorrow, we worked in vain yesterday*.) This kind of shift of temporal focus from t_0 to some post-present evaluation time is also illustrated by the following examples:

[Sadly, on this issue, he was simply out of his depth. ...] He *will not have been* the first commentator on events several thousand miles away to have been misled. (www)

[Boots' decision to drop its UK media agency OMD UK as a consequence of lumping all its marketing services requirements into WPP, prompted a senior source at the client to admit "they sacked the wrong agency".] The source *will not have been* the first senior marketer to express private frustration at being pressured into changing shops because of international considerations. (www)

11.4 Summary

11.4.1 The temporal focus of a speaker is the time on which, through a particular tense choice, he focuses in the use of any given clause. In connection with absolute tenses, **temporal focus** can be defined as the phenomenon that the speaker draws attention to a particular kind of time – past, pre-present, present or post-present – by locating a situation time in the corresponding 'absolute zone'. This means that temporal focus is recoverable from the tense alone. In the case of relative tenses, temporal focus is also reflected in the tense chosen. However, a relative tense involves (at least) two orientation times: the situation time and the time of orientation by which the situation time is bound in a relation of simultaneity, anteriority or posteriority. The temporal focus may be on the situation time or the binding time, so that (except when the

2. Imagine the following setting for this sentence: Yesterday it was Saturday, but the workers of a particular firm worked all the same because they were behind schedule and wanted to catch up. Today, however, they hear on the radio that there may be a strike tomorrow in one of their supply companies. If the strike goes through, they will soon be unable to continue working and will be behind schedule again. Under these circumstances, one of the workers might remark *If there's a strike tomorrow, we'll have worked in vain yesterday*.

relation between the two is T-simultaneity), we rely on adverbials and other contextual factors as well as tense to ascertain more exactly where the temporal focus is located.

11.4.2 We can talk of **marked** and **unmarked temporal focus** when the speaker has a choice as to which tense to use to refer to a situation. As far as absolute tenses go, this amounts to a choice as to the time-zone in which the situation is located, that is, a choice as to the relation between the situation time and t_0 . There are two major factors in deciding on tense choice when a choice exists between two or more absolute tenses. On the one hand, if the discourse is ‘about’ a particular time-zone – if other situations in the surrounding discourse are located in a particular zone – then, all other things being equal, the unmarked choice for a situation which is to be introduced into the discourse is location in the same time-zone. On the other hand, if the time of the full situation includes t_0 but also extends into one or more other time-zones, then, all other things being equal, it is more relevant to represent the situation as located at t_0 . When the time of the full situation does extend over the present time-zone and some other time-zone(s), then, these two influences on tense choice for absolute tenses compete. For example, if Meg is staying in my house now and will still be here for the next few days, then out of context, it is more informative to tell an addressee *Meg is here* than to tell the addressee *Meg will be here*. However, if I am talking about events that will take place in my home tomorrow (for example “*We’re going to have a barbecue*”) it is more informative to say “*Meg will be here*” than “*Meg is here*”.

11.4.3 When it comes to relative tenses, markedness has to do, not with the choice of where the situation is located relative to t_0 , but rather with the choice of where it is located relative to the binding time. Just as, in the case of absolute tenses, simultaneity with t_0 – i.e. location in the present – is the unmarked option where it is possible (albeit with the competing factor of the temporal location of the current discourse), so in the case of relative tenses, T-simultaneity with the situation time of the head clause is the unmarked option where it is possible. In some cases, though, there may be a choice between expressing simultaneity with the head clause situation time and expressing a different relation to a different time, to which the situation time is indirectly bound.

11.4.4 A shift of temporal focus from the present to the past (i.e. the use of a past tense when the present tense is possible in terms of pure reference) invokes a past **point of view** (which may belong to the speaker at some past time or to some other person). For example, a passenger in a car may say to the driver *There was a beautiful farm just back there*, meaning ‘we’ve just passed a beautiful farm’. Clearly the farm is still in the same place, but the passenger, by referring only to that part of the full situation of the farm’s being

there which is located in the past (presumably at the time of the car's passing it), invokes his point of view when he saw it. (If, instead, he said *There is a beautiful farm just back there*, he would no longer be simply referring to his experience of the farm but would be implying that the existence of the farm has some current relevance as yet unexplained.)

11.4.5 This shifting of the temporal focus from the present to the past can, however, result in an **implicature of nonapplicability** at t_0 . For example, when the verb form used expresses posteriority, a shift of temporal focus to the past suggests that what was foreseen at some past time is no longer foreseen: *I was going to go to Cuba this summer* is naturally understood as implying 'but I am no longer going to do so'. (Given the salience of the present moment, there is an assumption that if an intention is still valid it will be located in the present. The use of the past form of *be going to* locates the intention in the past and implicates that the intention is no longer valid.)

11.4.6 The fact that a shift of temporal focus from the present to the past calls up a past point of view is also used in narrative to present the observation and/or an evaluation of past situations as belonging to some person located at the time of actualization of the situations: the addressee sees past situations from the **point of view** of a narrated character (who may be the current speaker as he was at a past time, or may be someone else). This is most evident in **free indirect speech**. For example, a modal judgement about a past situation may be presented as taking place at the past time of the situation (thus giving the point of view of a represented character or the narrator 'then') or it may be represented as taking place in the present (thus giving the point of view of the narrator 'now'). Compare: *The goblins were advancing. There had to be at least a thousand of them* and *The goblins were advancing. There must have been at least a thousand of them*. Here, the epistemic necessity of the goblins numbering at least a thousand exists both at the past time at which the narrative events take place and at the present time of narration. The past tense form *had (to be)* places the addressee at the viewpoint of someone experiencing the advance of the goblins. The present tense *must (have been)* simply gives the rather more prosaic 'after the event' evaluation of the narrator.

11.4.7 As well as a shift of temporal focus from the present to the past, it is possible, in certain sentence types, to have a shift of temporal focus from the present to the future when the full situation observed or evaluated is (or can be conceived as being) in the future as well as the present. This explains why a speaker can choose between *It will be your sister who wins the first prize* and *It is your sister who will win the first prize*. The speaker focusses on the post-present in the head clause of the first example and on the present in the head clause of the second.

DEMO

12. Preterite vs present perfect in clauses with temporal adverbials

I.	Relevant classes of temporal adverbials	591
12.1	Deictic <i>vs</i> nondeictic time-specifying adverbials	591
12.2	Single-zone adverbials, multi-zone adverbials and zone-independent adverbials	593
12.3	Homogeneous <i>vs</i> heterogeneous time-specifying adverbials	594
12.4	(Non)inclusive heterogeneous time-specifying adverbials	595
II.	Temporal adverbials and the choice between past tense and present perfect	596
12.5	Nondeictic adverbials	596
12.6	Past-zone adverbials	598
12.7	Noninclusive heterogeneous pre-present-zone adverbials	599
12.8	Noninclusive homogeneous pre-present-zone adverbials	601
12.9	Inclusive pre-present-zone adverbials	602
12.10	Multi-zone time-specifying adverbials	603
12.11	<i>Since</i> -adverbials	605
12.12	<i>For</i> -adverbials	611
12.13	<i>Until</i> -adverbials	616
12.14	<i>Before</i> -adverbials	619
12.15	The present perfect with adverbials referring to the present	620
12.16	Tense choice with actualization adverbials	622
12.17	Tense choice with adverbials indicating a recent indefinite bygone time	623
12.18	Tense choice with <i>once</i>	626
III.	Summary	629
12.19	Types of temporal adverbials	629
12.20	Tense choice with temporal adverbials	629

Abstract

In this chapter we explore the ways in which the presence of a temporal adverbial in a clause interacts with the choice between the (absolute) past tense and the present perfect. (In chapter 6 we have already discussed the contrast between these two tenses in clauses without a time-specifying adverbial.)

In part I (= sections 12.1–4) we identify the relevant types of time-specifying adverbials: (a) deictic versus nondeictic adverbials; (b) single-zone adverbials, multi-zone adverbials and zone-

independent adverbials; (c) homogeneous versus heterogeneous adverbials; and (d) inclusive versus noninclusive heterogeneous adverbials.

In part I (= sections 12.5–18) we address the compatibility of these various types of time-specifying adverbials with the past tense and the present perfect. For example, we address the question whether *just (now)* combines with the past tense or with the present perfect (or with both).

A summary of chapter 12 is given in part III.

DEMO

I. Relevant classes of temporal adverbials

Temporal adverbials can be categorized as ‘deictic’ (e.g. *yesterday*, *the day before*) or ‘nondeictic’ (e.g. *at some time or other*, *at five o’clock*) depending on whether or not they are related to a temporal ‘anchor’. The former can be further categorized as either ‘absolute deictics’ (e.g. *yesterday*) or ‘relative deictics’ (e.g. *the day before*) depending on whether the temporal anchor is t_0 or another time, and as either ‘single-zone’ adverbials (e.g. *yesterday*) or ‘multi-zone’ adverbials (e.g. *today*) depending on whether they refer to only one absolute time-zone (e.g. the past zone) or to a time span which includes the present zone plus the post-present and the pre-present or the past. Nondeictic adverbials are automatically ‘zone-independent’.

Temporal adverbials can also be categorized as ‘homogeneous’ (e.g. *in 1983*) or ‘heterogeneous’ (e.g. *from 1983 to 1986*) depending on whether or not they can refer to the time interval (Adv-time) in its entirety as well as to any subpart of it. Within the latter class, we can formally distinguish between ‘inclusive’ adverbials, introduced by *(with)in*, and ‘noninclusive’ ones.

12.1 Deictic vs nondeictic time-specifying adverbials

12.1.1 Time-specifying adverbials, including the ‘bifunctional adverbials’ (which specify both duration and time – see 2.22.3), are either **DEICTIC (ANCHORED)** or **NONDEICTIC (UNANCHORED)**. Only in the former case is the Adv-time related to a given ‘**TEMPORAL ANCHOR**’.

I heard that name yesterday. (*deictic: yesterday means ‘the day before t_0 ’. The temporal anchor is t_0 ’*)

I had heard that name the day before. (*deictic: the day before means ‘the day before some orientation time’. The temporal anchor is not t_0 but a given past orientation time.*)

I’ve heard that name at some time or other. (*nondeictic: the Adv-time specified by at some time or other is not linked to a given temporal anchor.*)

He often {gets up / got up} at five o’clock. (*nondeictic Adv-time: at five o’clock is naturally understood as belonging to particular days, but the days in question are not anchored to a given orientation time.*)

Depending on whether the temporal anchor is t_0 or another time, a deictic time-specifying adverbial is an ‘absolute deictic’ or a ‘relative deictic’ expression.

12.1.2 A deictic time-specifying adverbial is an **ABSOLUTE DEICTIC** if the Adv-time that it indicates is anchored to t_0 ; otherwise it is a **RELATIVE DEICTIC**.

Examples of absolute deictic time-specifying adverbials are: *today, this morning, tomorrow, tonight, yesterday, three weeks ago*, etc. Adv-times which have t_0 as (expressed or inferred) endpoint are also absolute deictics: *since last week, until now*, etc. Examples of relative deictic time-specifying adverbials are: *the same day, that morning, the next day, the day before, two days earlier*, etc. An Adv-time that is anchored to a time which is itself anchored to t_0 can be referred to as an **RELATIVE-ABSOLUTE DEICTIC**. Compare:

The letter I posted *yesterday* hasn't arrived. (*absolute deictic Adv-time*)

The letter I posted *the day before yesterday* hasn't arrived. (*relative-absolute deictic Adv-time*)

The letter she had posted *two days earlier* hadn't arrived. (*relative deictic Adv-time*)

There are also adverbials that can be used as either absolute or relative deictics:

This has never happened {*in the past / so far*}, and will never happen again in the future. (*used as absolute deictics*)

This had never happened {*in the past / so far*}, and would never happen again in the future. (*used as relative deictics*)

He {will / would} tell her everything *in three days' time*. (*absolute deictic when combining with will, relative deictic when combining with would*)

12.1.3 Deictic time-specifying adverbials like *yesterday* or *in those days* are 'definite' referring expressions, i.e. the speaker assumes (or pretends) that the referent time is identifiable to the hearer, or that the hearer is at least familiar with the referring expression (which is then 'attributive' in the sense of Donnellan (1966) – see 11.1.2.) In other words, the use of such a deictic time-specifying adverbial is assumed to be sufficient for the hearer to know or infer the temporal location of both the 'anchor' and the Adv-time that is anchored to it.

Deictic expressions like *just, some time ago, recently, a long time ago*, etc. are less definite: while the anchoring time is still assumed to be identifiable, the temporal location of the Adv-time is less so, because the temporal distance between the anchoring time and the anchored Adv-time is not specified in a very precise way. These adverbials represent a category of adverbials that are neither (fully) definite nor (fully) indefinite.

As to nondeictic time-specifying adverbials, some refer in a definite way, whereas others do not. Compare:

I met him *at some time or other*. (*indefinite nondeictic Adv-time*)

I met him *in 2002*. (*definite nondeictic Adv-time*)

12.1.4 A definite nondeictic time-specifying adverbial has fixed time reference. That is, its temporal referent remains the same irrespective of the context in which the adverbial is used. Compare:

I met her *on the day that Bryan was buried*. (*definite nondeictic Adv-time with fixed time reference*)

Our son was born *in 2003*. (*definite nondeictic Adv-time with fixed time reference*)

One day he got seriously hurt in an accident. (*indefinite nondeictic Adv-time with (necessarily) non-fixed time reference*)

12.2 Single-zone adverbials, multi-zone adverbials and zone-independent adverbials

12.2.1 **SINGLE-ZONE ADVERBIALS** are deictic adverbials which refer to only one ‘absolute zone’ (see 2.37). For example, ‘past-zone adverbials’ specify a bygone Adv-time which can only be interpreted as disconnected from the present time-sphere (e. g. *yesterday, last week, in 1983*) and which are therefore incompatible with the present perfect:

My aunt {died / *has died} {yesterday / last week / in 1983}.

‘Pre-present-zone adverbials’ specify a period up to t_0 (e. g. *so far, since then*) and can therefore combine with the present perfect but not with the past tense:

Since then we have been left completely in the dark.

Up until now we have collected £ 543.

Similarly, *right now* is a ‘present-zone adverbial’, and *tomorrow* is a ‘post-present-zone adverbial’.

12.2.2 **MULTI-ZONE ADVERBIALS** are deictic adverbials which specify a time span which includes the present zone ($= t_0$) as well as the post-present and the pre-present or the past, e. g. *today*. Such adverbials are compatible with various absolute tenses, depending on the zone that receives the temporal focus.

John *is* in London today. (*temporal focus on the present*)

John *has been* in London today. (*temporal focus on the pre-present part of today*)

John *was* in London today. (*temporal focus on a past time in the course of today*)

John *will be* in London today. (*temporal focus on a post-present time in the course of today*)

Needless to say, multi-zone time-specifying adverbials are always homogeneous. (See the discussion of *I had a copious breakfast today* in 2.38.2.)

12.2.3 **ZONE-INDEPENDENT ADVERBIALS** specify a time which is not linked up with one particular zone, e. g. *at five o'clock*. Such adverbials are compatible with various absolute tenses, depending on the zone that receives the temporal focus.

He left at five o'clock.

I will leave at five o'clock.

I'm still in bed at five o'clock.

It goes without saying that a zone-independent adverbial is nondeictic in itself, but can only be meaningfully used if the tense of the sentence and the context in which it is used identify the absolute zone and the implicit Adv-time in relation to which it should be interpreted.

12.3 Homogeneous vs heterogeneous time-specifying adverbials

Within the class of time-specifying adverbials we can also distinguish between 'homogeneous' and 'heterogeneous' (or 'nonhomogeneous') time-specifying adverbials. In other words, Adv-times may be (represented and / or interpreted as) homogeneous or heterogeneous.¹ A **HOMOGENEOUS ADV-TIME** is a durative time interval that is understood as being the same all the way through. Such a homogeneous Adv-time is **DISSECTIVE**. This means that any part of the Adv-time can be referred to by the same adverbial as refers to the Adv-time as a whole. In other words, it is criterial of a homogeneous time-specifying adverbial that the adverbial establishing the Adv-time can also be used to refer to any portion of the time span in question. For example, the adverbial *in 1983* can be used not only to refer to the complete time span which began on 1 January 1983 and ended on 31 December 1983 but also to talk about any day in that period:

In 1983 he still lived in Paris.

My father died in an accident in 1983.

In the former sentence, *in 1983* may well refer to the twelve-month period as a whole; in the latter we can only interpret it as referring to a particular day in that period.

By contrast, a time-specifying adverbial is **HETEROGENEOUS** (i.e. represents an Adv-time as heterogeneous) if it can only refer to the Adv-time as a whole, not to any smaller portion of it. For example:

From 1983 to 1986 I lived in Paris.

*My father died in an accident *from 1983 to 1986*.

1. Since the property of being homogeneous or heterogeneous is a property of the Adv-time determined by the nature of the time adverbial describing it, the labels 'homogeneous' and 'heterogeneous' will be applied both to the Adv-time and to the adverbial denoting it. This is similar to the practice (introduced in 1.44) of speaking of (non)-bounded situations as well as (non)bounded clauses.

I watched TV *all afternoon*.

*Bill arrived *all afternoon*.

12.4 (Non)inclusive heterogeneous time-specifying adverbials

12.4.1 Within the class of heterogeneous time-specifying adverbials, which can only indicate a period as a whole, there is a formal distinction between prepositional phrases introduced by *within* or *in* (in the sense of *within*) and other adverbials. As noted in 1.46.1, (*with*)*in*-adverbials, which we can refer to as **INCLUSIVE ADVERBIALS**, can only be added to a clause with a ‘telic VP’ (see 1.39). Compare:

I have received three threatening letters. (receive three letters is a telic VP)

I have received three threatening letters {*in* / *within*} the last four weeks (*inclusive adverbial*)

I have been working very hard. (work hard is an atelic VP)

*I have been working very hard {*in* / *within*} the last four weeks. (*inclusive adverbial*)

I have been working very hard *for* the last four weeks. (*noninclusive adverbial*)

12.4.2 Not every temporal adverbial introduced by *in* is an inclusive adverbial. Time-specifying adverbials like *in the past*, *in 1999*, etc. are not inclusive. Neither is *in a few days* in *I'm leaving in a few days*. We can only speak of an inclusive meaning if the *in*-adverbial measures the duration of the period containing the time(s) of actualization of the situation(s) referred to and (at the same time) measures either the length (duration) of one bounded situation or the number of subsituations making up a bounded repetitive hypersituation:

I met him twice in a few days. (*inclusive*)

I'll see him in a week. (*noninclusive because in a week does not measure the duration of a bounded situation*)

I've visited him three times in one week. (*inclusive*)

He wrote that novel in less than two weeks. (*inclusive*)

I've written several novels in the past. (*not inclusive because in the past does not measure the length of the repetitive hypersituation*)

II. Temporal adverbials and the choice between past tense and present perfect

Now that several types of temporal adverbials have been identified, we can examine which types are (in)compatible with either the present perfect or the past tense. It should be clear that in doing so we will not be concerned with the relative past tense. A relative past tense form is generally incompatible with a time-specifying adverbial because it implies that the temporal location of the situation time is to be inferred from the relation of T-simultaneity (= coincidence) with the binding time (see 8.17.2). As noted in 8.26.1, a situation time cannot derive its temporal specification from two different mechanisms – the use of a tense form expressing coincidence and the presence of a time-specifying adverbial – at once, even if the times they refer to coincide with one another. Hence the difference of interpretation between *Jim whispered that he was still thirsty* (where *was* is naturally interpreted as expressing simultaneity) and *Jim whispered that he was still thirsty at three o'clock* (where Jim's being thirsty can only be interpreted as anterior to his whispering, which means that *was* is now an absolute tense form).

12.5 Nondeictic adverbials

Nondeictic adverbials, by virtue of being unanchored, are compatible both with the past tense (e.g. *I got up at two a.m.*) and with the present perfect (on an indefinite, often repetitive reading, e.g. [*You don't believe I've ever got up at two a.m.? I can assure you.*] *I HAVE got up at two a.m. [Several times.]*).

In 12.1.1, a nondeictic Adv-time-adverbial has been defined as an adverbial specifying an Adv-time which is not related to a temporal 'anchor' and which is therefore automatically 'zone-independent', as in the following examples:

He got up at five o'clock. (*nondeictic Adv-time: at five o'clock is naturally understood as belonging to a particular day, but the day in question is not anchored to a given orientation time.*)

I've heard that name *at some time or other*. (*nondeictic: the Adv-time specified by at some time or other is not linked to a given temporal anchor.*)

Nondeictic time-specifying adverbials never specify a period including t_0 because an interpretation involving reference to t_0 is automatically a deictic interpretation. However, this does not mean that nondeictic time-specifying adverbials cannot combine with a present perfect. In fact, it follows from their being

unanchored that they can combine with any tense (except the present tense), because they do not help to specify the temporal location of the situation time.

[I think] I've met him *at some time or other*.

[You don't believe] I've ever got up *at two a.m.*? [I can assure you,] I HAVE got up *at two a.m.* [Several times.]

The present perfect is possible in these sentences because the situation times are clearly conceived of as lying within a period leading up to t_0 . (In both examples this period is likely to be the speaker's lifetime.) What is uppermost in the speaker's mind is not the *time when* a *specific* situation actualized but the *fact that* a particular *kind* of situation has actualized (once or several times) in a period up to t_0 . To see this better, compare:

(1) John left the office at five o'clock.

(2) ["John has never left the office at five o'clock." – "That's not true!" John HAS left the office at five o'clock. [Many times. I saw him.]]

In (1), *at five o'clock* indicates a deictic (anchored) time interval because it is interpreted in relation to a particular time (day) that is assumed to be identifiable from the context or is 'given' by virtue of its including t_0 . In (2), in contrast, *at five o'clock* is not a deictic indication of time because it is not interpreted in relation to a particular day referred to in the context or any other given time. Whereas (1) states that five o'clock was the time when John left the office on a particular day, (2) states that the situation of John leaving the office at five o'clock has actualized at least once in the pre-present (i. e. within an unspecified period leading up to t_0). In other words, whereas (1) locates the semelfactive situation of John's leaving the office at a particular past time, (2) expresses that the situation of John leaving the office at five has actualized on at least one (unspecified, indefinite) day in a period up to t_0 . In (2) the adverbial *at five o'clock* thus belongs to the description of the situation itself, whereas in (1) it denotes the past Adv-time specifying (i. e. 'containing' – see 2.23.1) the situation time of the situation.

This semantic difference between (1) and (2) has a syntactic correlate in the fact that *at five o'clock* is a necessary adverbial adjunct in (2) whereas it is an optional one in (1) (unless it is the only constituent there that expresses new information). This appears from the fact that *at five o'clock* can be fronted in (1) but not in (2):

At five o'clock John left the office.

*At five o'clock John HAS left the office.

When present perfect sentences of the kind exemplified by (2) are used without a context such as given in (2), they usually involve a repetitive time adverbial:

John has often gone swimming *at six o'clock in the morning*.

Many a time, passengers have been terrified *when their plane began to lose height*.

I have occasionally left *before Tom (did)*.

However, the sense of repetition does not come exclusively from the adverbial. Even if the latter is dropped (in which case *have* normally receives the nuclear accent because the sentence contradicts a claim to the contrary), there is a sense of (at least potential) repetition. The following sentences suggest paraphrases like 'It has happened on occasion that ...' or 'It has happened at least once that ...':

John **HAS** gone swimming at six o'clock in the morning.

I **HAVE** left before Tom (did).

Passengers **HAVE** been terrified when their plane began to lose height.

It is precisely the lack of information concerning the temporal location of the situation time(s) that produces this potentially repetitive reading. Sentences like those above express no more than that, in a period up to now, there has been one or more instances of a situation of the type 'swimming at 6 a.m.', or 'leaving before Tom', etc. No information is given concerning the precise temporal location of these instances, nor about their frequency.

12.6 Past-zone adverbials

Past-zone adverbials are only compatible with the past tense, not with the present perfect (not even when there is a clear idea of present relevance or resultativeness). For example: [*I know what it means to be in the army.*] I {served / *have served} *during the Falklands war.*

12.6.1 A time-specifying adverbial specifying a time in the **PAST ZONE** (i. e. a bygone time which is seen as disconnected from the present time-sphere) can combine with the past tense, but not with the present perfect.

I {went / *have gone} to London yesterday.

(*speaking in the evening*) The plumber {came / *has come} this {morning / afternoon}.

A 'bifunctional adverbial' (which specifies both duration and time – see 2.22.3) may similarly be a past zone adverbial:

["When were you at university?"] – "We {were / *have been} at university from 1986 to 1990." (*Note that, because the adverbial provides the new information asked for, it is taken to specify the full period, so that the situation time is taken to be the*

time of the full situation. This reading is due to the Gricean Maxim of Quantity, which stipulates that all relevant information must be given. The relevant information (= the information asked for) is the time of the full situation.)

[“From 1986 to 1990 I was in India. What were you two doing during that time?”] – “We {*were* / **have been*} at UNIVERSITY from 1986 to 1990.” (Because the adverbial represents given information – the new information (= information asked for) being what the addressees did in that period – the Adv-time coincides with the situation time, but the situation time may be only part of the time of the full situation. The reply is perfectly true if the addressees attended university from 1985 to 1991.)

Note that *from 1986 to 1990* can easily be fronted in the second example (where it represents given information), but not in the first (where it represents new information).

12.6.2 Perhaps it needs stressing that the rule that the past tense has to be used with adverbials specifying a past Adv-time applies even if there is a clear idea of present relevance or resultativeness.

[I know what it means to be in the army.] I {*served* / **have served*} during the Gulf war.

“[Can we enter the building?]” – “Yes, the janitor {*has opened* the door / *opened* the door a minute ago / **has opened* the door a minute ago}.”

This illustrates the fundamental claim (made in section 2.3.1) that the basic meaning of a tense is to locate a situation in time in a particular way. The use of a tense is wholly determined by its semantics (= temporal structure), which has to fit in with the temporal information given by the time-specifying adverbial or by the context.

12.7 Noninclusive heterogeneous pre-present-zone adverbials

Noninclusive heterogeneous pre-present-zone adverbials normally combine with the present perfect only: I {**was* / *have been*} fascinated by insects from childhood.

12.7.1 When a noninclusive heterogeneous time-specifying adverbial indicates a **PRE-PRESENT ZONE** (i. e. a bygone period which leads up to t_0), it is as a rule the present perfect that is used:

From the beginning of May until now I have been ill. (*continuative reading*)

From the beginning of May until now I have been ill three times. (*‘quantificational constitution’ reading – see 5.4.7*)

At least a dozen accidents have happened here over the past four years. (*quantificational constitution reading*)

So far nothing much has been done about the problem. (*indefinite reading*)

12.7.2 It should be noted, however, that not every noninclusive heterogeneous adverbial that is used (or can be used) as a pre-present-zone adverbial allows any of the three W-readings. For example, some pre-present-zone adverbials (e.g. *from childhood*) are only compatible with a continuative reading. Compare:

I have been fascinated by insects from childhood. (*continuative reading*)

*I've been in France exactly six times from childhood. (*From childhood clashes with the quantificational constitution reading imposed by six times.*)

*I have seen a dragonfly from childhood. (*The continuative reading and an up-to-now reading are pragmatically excluded; from childhood does not allow an indefinite reading.*)

The reason why *from childhood* only allows a continuative reading is that it is a 'SITUATION-UNBOUNDING' adverbial. This means that it functions as a bifunctional duration adverbial referring to a period whose endpoint is explicitly left vague, which means that it precludes the situation from being represented as bounded. Obviously, a nonbounded pre-present situation cannot come to an end before t_0 .

12.7.3 *Since*-adverbials can be used as noninclusive heterogeneous pre-present-zone adverbials, as in *I've never seen him again since (then)*. Because *since* can be used in various ways (viz. as a preposition, adverb or conjunction) and because the choice of tenses is complex in sentences containing a *since*-clause, *since*-adverbials will be treated extensively in a separate section, viz. 12.11 below. For the moment we will restrict ourselves to saying that the present perfect is the unmarked tense in clauses containing a *since*-adverbial which identifies a period up to t_0 :

He [went to his study after dinner and] has been working ever since. (*continuative reading*)

[Four years ago he was on an airplane that had to make an emergency landing in a field.] He has not travelled by air since. (*indefinite reading*)

Since then he has travelled by train. (*continuative habit or indefinite single-situation reading*)

I've been in China no less than eleven times since 1996. (*constitution reading*)

12.7.4 The choice of tense – preterite versus present perfect – in clauses containing *until now* is discussed in 12.13.3–7 below.

12.8 Noninclusive homogeneous pre-present-zone adverbials

Noninclusive homogeneous pre-present-zone adverbials mostly (and those of the type *for the {past / last} two weeks* exclusively) combine with the present perfect, but the past tense is sometimes used, though not normally in Br. E., to imply a break between the past and the present.

This class consists of a limited number of adverbials, the most important of which are *in the past*, *just*, *lately*, *recently* and prepositional phrases of the type *for the {past / last} two weeks*. The latter combine with the present perfect only (at least if they indicate a period up to now),² while the former mostly combine with the present perfect, but the past tense can be used in order to focus on a period which is treated as a past (i. e. closed off) period in spite of its leading up to, or almost up to, t_0 . Since *recently*, *lately* and *just* are discussed in detail in 12.17 below, we will restrict ourselves here to illustrating this rule with examples of *in the past*. This adverbial normally collocates with the present perfect when it indicates an indefinite period-up-to-now:

Planning permission *has been given* in the past for the conversion of the two ward blocks into residential accommodation. (LOB)

Washington is today closer to Moscow than any city in Europe *has been* in the past. (LOB)

Trinidad, Australia and Canada might all be expected to make a greater contribution than they *have done* in the past. (LOB)

I *have* many times in the past *seen* squirrels in the woods across the railway, [but they have always been grey]. (LOB)

In the past few weeks there *has been* a prolonged discussion between Ministries as to whether the cuts should apply uniformly across the board. (LOB)

In fact such Yugoslav activity *has been* particularly *intensified* in the past year or so. (LOB)

Occasional examples in the past tense can be found, provided there is some kind of break between the past and the present:

Syndicalism (...) grew in the cities, not in the country areas, and *was* closely associated with anarchism in the past before the Falangists and Catholics made it 'respectable' in its current form of national verticalism. (LOB)

2. For example:

In other words, they should carry on as they *have been doing* for the last 10 years. (LOB)

The stores had been hit by the same strike wave that *has paralysed* the port of Takoradi for the past week. (LOB)

[There is, however, another factor which weighed perhaps more heavily with the Government's decision to introduce some form of control.] In the past the Governments of both India and Pakistan voluntarily *agreed* to maintain strict control over emigration to Britain. (LOB)

[In the meantime, the peasant derives many benefits from the management of the economy] – he is to a certain degree cushioned against the natural calamities which *made* life so difficult in the past. (LOB)

However, even if there is a sense of contrast between past and present, Br. E. normally uses the present perfect in combination with *in the past*:

Whilst the above arrangement together with correct condenser design *has been* largely *used* in the past, the tendency today is undoubtedly towards the use of adsorption of the impurities from one or more of the process streams. (LOB)

12.9 Inclusive pre-present-zone adverbials

Inclusive pre-present-zone adverbials can in principle combine with either the past tense or the present perfect; the choice of tense depends on the speaker's temporal focus.

12.9.1 'Inclusive' adverbials (i.e. prepositional phrases with *within* or *in* – see 1.46.1) can in principle indicate either a past interval or the pre-present zone, and can therefore collocate with either the past tense or the present perfect. The choice depends on the speaker's 'temporal focus' (see 11.1):

I {*have spoken* / *spoke*} with Tim three times within the last few days. (*This kind of example is not essentially different from I {*have spoken* / *spoke*} with Tim today – see 12.10.*)

["When did he disappear?"] – He {*disappeared* / **has disappeared*} within the last month. (*In this context, the temporal focus is on some indefinite past time in the period leading up to now.*)

Security awareness *has increased* significantly within the last year. (www)

Two volcanologists by the names of Maurice and Katia Krafft *died* in a volcanic explosion within the last five years. (www)

Within the last 3–4 decades masses of Bangladeshis *have migrated* to the United States. (www)

Within the past twenty-four hours brief battles *were fought* in the Vedeno district of Chechnya. (www)

12.9.2 Note that prepositional phrases with *in the last* may or may not be used as inclusive adverbials. If they are (and indicate a period leading up to t_0), they are used with the present perfect:

[Seven different Chinese agencies have been identified running operations inside Africa itself.] All *have been founded* in the last 18 months [and three sprang into life this year]. (LOB) (*in* means ‘within’)

The number of German film directors who *have made* first rate works in the last 25 years can be counted on the fingers of one hand. (LOB)

[But there is a steady falling out of smaller manufacturers;] a thousand *have gone* out of business in the last ten years. (LOB)

In the following examples, the adverbial with *in the last* indicates a period leading up to t_0 but does not have an inclusive meaning (because the situation referred to is not bounded – see 12.4.1 above). Because there is reference to a period up to t_0 , the present perfect is used:

It is only in the last few years that the Czechs *have begun* to publish the work of their classic polyphonists. (LOB)

In the last year or so road safety officials *have acclaimed* Chislehurst-Sidecup as an area free of accidents during the Bank Holiday weekends. (LOB)

Apart from the contention that American prestige *has suffered* abroad in the last few years, the President-elect has refrained from attacking the policies of his predecessor. (LOB)

[I would like to mention that, after the period of expansion of the group,] your Board *has* in the last year *concentrated* mainly on the consolidation of the group’s activities. (LOB)

Self-evidently, the past tense is used if the relevant period does not lead up to t_0 (but is over at t_0):

In the last section *it was pointed out* that the reliability of rejection or acceptance is a matter of choice. (LOB)

12.10 Multi-zone time-specifying adverbials

Multi-zone temporal adverbials can in principle combine with either the past tense or the present perfect; the choice of tense depends on the speaker’s temporal focus.

As noted in 12.2.2, multi-zone time-specifying adverbials like *today*, *this week*, *this month*, *this year*, *this century*, etc. are compatible with the present perfect as well as the past tense. The choice of tense depends on the speaker’s choice

of temporal focus. This means that the present perfect is the rule to represent the situation time as leading up to t_0 (i. e. to express a continuative meaning or an up-to-now reading) or to convey an indefinite reading (i. e. the situation time is the time of a bygone situation, but there is no actualization focus: the speaker is concerned with NOW rather than THEN; in most cases he focuses on a present result of the bygone situation, or on some other kind of current relevance.) The following illustrate these uses of the present perfect:

[On the upside, though, the butterflies are magnificent.] *We've seen* two this week that are new to us – [a Golden Piper flitting around our garden like a little independent veld fire, and a Dry-leaf Commodore on the leaf litter in Thuma Forest Reserve.] (www) (*The use of are makes it clear that the speaker is concerned with NOW rather than with THEN.*)

I've been working hard this month.

She's met him twice this week.

His financial situation *has not been* too bad this year.

And in fact you've *met* him this week. [Did you talk about the subject of PR at all?] (www)

MCI Communications Corp *has begun* service this week on the PacRim East fibre optic cable. (BNC)

In the following examples the past tense is used to express 'actualization focus' (see 4.7.1), i. e. the speaker is concerned with THEN rather than NOW. This means that the speaker is not concerned with the possible current relevance of the bygone situation.

I met a former schoolfriend of mine this week. (*The speaker focuses on the time of the meeting, which he considers as past, even though it belongs to a period leading up to now.*)

I *went* to the museum today, [but it was closed]. (*The speaker focuses on the past time of his going to the museum. The fact that this past time forms part of an adverbially indicated period including t_0 is irrelevant to the choice of tense.*)

As a further illustration, compare the following:

I {*have spoken* / *spoke*} with Tim today. (*Today specifies a homogeneous multi-zone Adv-time which includes t_0 . The indefinite perfect expresses that the situation of my speaking with Tim has actualized at some unspecified time in the course of today; the past tense implies that the speaker has a particular time in mind which he is treating as a past time even though it forms part of today.*)

I {*have spoken* / **spoke*} with Tim since yesterday. (*Since yesterday refers to the same period as today; it does not include any interval forming part of yesterday. However, unlike today, it is not a multi-zone time-specifying adverbial but a pre-present-zone time-specifying adverbial. This is why, unlike today, it cannot collocate with the past tense.*)

Incidentally, these two examples make it clear that what determines the possibility or impossibility of using the past tense with adverbials like *today* and *since yesterday* is the linguistic status of the adverbial – multi-zone *vs* pre-present – and not its reference in the actual world (in which both adverbials refer to the same time).

The following pair of examples further illustrate the choice between the past tense and the present perfect with multi-zone time-specifying adverbials:

Jim *took* the train to London this morning. (*This sentence implies either that the morning is over at t_0 or that this is not the case but the speaker is thinking of the past time when Jim took the train.*)

Jim's *taken* the train to London this morning. (*This sentence implies that the morning is not yet over at t_0 and that the speaker is not concerned with the past time when Jim took the train but rather with the present result or relevance of that action.*)

Consider also the following:

I *had* a copious breakfast today. (*Even though today indicates an Adv-time including t_0 , the past tense is used if the speaker focuses on the time of breakfast. This time can be conceptualized as a past time because today is a homogeneous multi-zone adverbial: any part of today, whether past, pre-present, present or future, can be referred to as 'today'.¹)*

I *had* a frugal breakfast this morning. (*Two readings: (a) this morning indicates a past period; (b) the morning is not yet over but the speaker expresses actualization focus on the past time of the breakfast.*)

I've already *had* breakfast this morning. (*It is still morning. The speaker expresses current relevance. The message may be 'I don't need to have breakfast any more', 'I'm not feeling hungry', etc.*)

12.11 *Since*-adverbials

If the adverb *since* or a prepositional phrase with *since* indicates a period up to t_0 , the clause in which it is used has to be in the present perfect: *I haven't seen him {since / since that night}*. If the *since*-adverbial is a *since*-clause indicating a period up to t_0 , the head clause uses the present perfect, whereas the *since*-clause uses the present perfect if the situation referred to leads up to t_0 and the past tense if the situation in question is a bygone situation: *I haven't seen him since I {have been living here / came to live here}*. A possible exception is a cleft of the type *It {is / has been} a long time since I {went / have gone} to a restaurant*. The use of the present perfect in the *since*-clause is then only possible if the situation in question could in principle have actualized several times in the pre-present period. Thus, the present perfect is ungrammatical in *It {is / has been} a long time since my wife {died / *has died}*.

There are some exceptional cases in which a head clause in the present tense can collocate with a *since*-construction (especially in a conversational style).

12.11.1 The word *since* can be used as an adverb, as a preposition and as a conjunction. In all three cases *since* refers to a period starting before and continuing up to some orientation time. If the orientation time in question is t_0 , the adverbial is a pre-present-zone adverbial, so that the present perfect has to be used.

[I met him at the races, but] I haven't seen him since. (*adverb: since* = 'since then')

I haven't seen him since yesterday. (*preposition*)

I haven't seen him since I met him at the races. (*conjunction introducing an adverbial time clause*)

12.11.2 For a good understanding, it is useful to add a few remarks on the use of *since* as an adverb and its use as a preposition.

(a) As an adverb, *since* is mainly used in **NONASSERTIVE CLAUSES** (i. e. clauses which are negative and / or interrogative in interpretation, but not necessarily in form). In **ASSERTIVE CLAUSES** (which are positive and not interrogative in meaning) we normally use either *since then* or (if the interpretation is continuative) *ever since*.

[He left three days ago, and] we haven't seen him since.

[She witnessed a terrible car accident three weeks ago.] I wonder if she's driven since.

He has travelled by train {since then / ?since}.

He [went to his study after dinner and] has been working {since then / ever since / ?since}.

Still, examples can be found with *since* used as an adverb in an assertive present perfect sentence receiving a continuative interpretation:

[It took me a year to get the divorce and] I have been happy since. (www)

I have been feeling better since, but still not 100 %. (www)

Moreover, the phrase *long since* can only be found in assertive contexts, because the measure phrase *long* provokes a t_0 -factual reading. (As noted in 14.6.13, measure phrases normally have this effect.)

[Fate has yet to determine in what category I shall win my Oscar, but] I *have long since* decided where I shall buy my dress. (www)

This example is interpreted as meaning both 'Since then I have decided where to buy my dress' and 'I made that decision a long time ago'. It does not mean

(contrary to what the phrase *long since* might suggest) ‘I have decided where to buy my dress + I made that decision long after the initial time of the *since*-period’.

- (b) When *since* is used as a preposition, it can be followed by a noun phrase, a temporal adverb, a *before*-phrase or a *before*-clause:

He has lived here since the war.

He hasn’t been at home since yesterday.

He has lived here since before the war.

He has lived here since {before / *when} the war started.³

The combination of *since* with *after* is rather unusual, but not impossible:

The French ministry emphasized that France has not authorized the sale of weapons, or even spare parts, to Iraq *since after* July 1990. (www)

After being freed, he immigrated to America and has lived in the US *since after* the war. (www)

Although Western films have been lensed in Vietnam *since after* the war, some have been turned away after an initial OK. (www)

- (c) When *since* is followed by a noun phrase or adverb, the latter has to indicate the starting-point of the Adv-time leading up to an orientation time, not the Adv-time as a whole. A prepositional phrase in which the NP refers to the whole of an Adv-time leading up to an orientation time has to be introduced by *for* or (under certain conditions) by *within* or *in*.

He has lived here since the war. (*implies that he started living here when the war began, was going on or ended*)

He has lived here {for / *since} 40 years.

He has been ill {for / *since} some time.

She hasn’t written to me since Christmas.

I haven’t seen him {for years / *since years / in years / *within years}. (*In years is only possible in negative sentences. Within can only be used with an NP specifying a more definite time, e.g. within the last two months.*)

I have seen him once {*for years / *since years / *in years / *within years}. (*The precise indication of the number of times that the situation has actualized is incompatible with an indefinite indication of an Adv-time-up-to-t₀.*)

3. The reason why the combination of *since* and a *when*-clause is excluded may be the following. *Since* means ‘since the time that’. *When* means ‘at (= simultaneous with) the time at which’. The combination *since when* would mean ‘since the time at the time at which’ (= ‘since the time simultaneous with the time at which’), which is redundant. There is no point in using *since when* if *when* does not add anything to the meaning of *since* on its own.

I have seen him once {*for / *since / in / within} the last four years. (*The precise indication of the number of times that the situation has actualized is compatible with the definite indication of an Adv-time-up-to- t_0 .*)

I haven't seen him {for / *since / in / within} the past year.

I have seen him twice {*for / *since / in / within} the past year.

12.11.3 When *since* is used as a conjunction and the *since*-clause indicates a period-up-to- t_0 , the use of the tenses is normally as follows. As a rule, we use the present perfect in the head clause, where it may receive an indefinite reading, an up-to-now reading or a continuative interpretation. In the *since*-clause, the past tense is used when the *since*-clause situation marks the beginning of the period leading up to now, and the present perfect is used when the *since*-clause situation lasts throughout the entire period-up-to- t_0 . (In the latter case the W-reading triggered by the present perfect in the *since*-clause is normally a continuative interpretation rather than an up-to-now reading.)

He has been worried since he *received* that threatening letter. (*continuative reading of the head clause; the since-clause situation forms the beginning of the period-up-to-now*)

Since she *was kidnapped*, the girl has been having nightmares. (*id.*)

We've only been to the zoo once since we *no longer had* a car. (*constitutive reading of the head clause; continuative reading of the since-clause*)

We haven't had problems with damp since we *installed* central heating. (*indefinite reading of the head clause*)

Since they *have had* a garden, they have grown all their vegetables themselves. (*Both clauses receive a continuative reading.*)

I haven't spoken English since we *moved* to Madrid. (*indefinite reading of the head clause*)

I haven't spoken English since we *have been (living)* in Madrid. (*indefinite reading of the head clause; continuative reading of the since-clause*)

We've been feeling better since we *'ve been taking* more exercise. (*Both clauses receive a continuative reading.*)

It is interesting to note that the present perfect can be used in *since*-clauses involving verbs like *start*, *begin*, *become*, which would seem to have an inchoative meaning and thus to refer to a situation that marks the beginning of the pre-present period only:

We've been feeling better since we {*started / have started*} taking more exercise.

We've found several similar cases since we {*began / have begun*} looking for them.

Since we *have begun* using 1STEP we have had fewer injuries. (www)

Since you *have started* your business, how many contracts have you completed and over what length of time? (www)

[Prior to that I did very little exercise.] Since I *have begun* exercising I have also tried to change my diet by cutting down on carbohydrates. (www)

Since I *have started* graduate school I have been focusing a lot on saving money. (www)

Since he *has begun* to narrow his focus career-wise, he has also begun to see that he will need a lot of math. (www)

The following are examples with other verbs marking the beginning of a period up to now:

[I just want to thank you so much for designing such a powerful tool in website design.] My business has boomed ever since I *have joined* the program. (www)

[I just have to put up with all the humiliations that fall on my head in this great country.] It's been difficult, too, since Anwar-saab *has become* insanely mad. (BNC)

Since Moo *has cancelled* the Paypal subscription plan for stores, we haven't heard anything else about making our payments. (www)

[She ends up talking about him, though, in the park.] Since Billy's *come around* that's all we've been talking about. (BNC)

Of course, this use of the present perfect is not possible with just any verb. For example, *Since I've written to the company they have been bombarding me with information* can only be interpreted with *have written* describing a continuative habit, which does not really make pragmatic sense, and *Since I've sent the coupon to the company they have been bombarding me with information* cannot really be interpreted at all. The verbs that do allow the use of the present perfect are verbs like *start, join, become*, etc. which allow the interpretation of the *since*-clause to be 'since the inception of the state that the referent of the subject NP is now in' (with 'state', of course, including habits). That is, there is a mixture of present perfect continuative meaning and inchoative meaning.

12.11.4 The present tense is more common than the present perfect in the head clause of sentences of the type '*it is* + NP denoting a period of time + *since*-clause':

It {is / has been} a good three weeks since I paid that bill.

It {is / has been} at least 10 years since those riots took place.

It {is / has been} a long time since we received a salary increase.

It *is* a good few years since I last saw this movie [but the memory lingers on]. (www)

It *has been* at least 6 years since we had a winter that rivalled this one for sheer cold and snow. (www)

There are a few things worth noting here:

- (a) In examples like these, the actualization of the *since*-clause situation marks the beginning of a period up to now. This means that a continuative read-

ing is ruled out. (In fact, a continuative reading requires the use of *that* rather than *since*:

It's a good two weeks {that / *since} I have known that;

Today it's three years {that / *since} I have been married to Sharon.)

- (b) Apart from the possible use of *is* in the head clause, the pattern illustrated by the above examples is special in that it allows the use of a (noncontinuative) present perfect in the *since*-clause. (Since the *since*-clause situation marks the beginning of a period up to now, we would normally expect that the past tense must be used.)
- (c) This use of the present perfect is only possible if the sentence does not contain an adverbial that is incompatible with the present perfect (e.g. *last*) and provided the situation referred to in the *since*-clause is viewed as repeatable (see 5.21.1):

It {is / has been} three weeks since I {~~received~~ / ~~have received~~} a bill. (*Receiving a bill is a repeatable situation. With have received the sentence means something like 'I haven't received a bill for three weeks'. In other words, there is no difference of meaning between It is three weeks since I have received a bill and It is three weeks that I have not received a bill.*)

It {is / has been} three weeks since I {~~received~~ / *~~have received~~} that bill. ('*Receiving that bill*' is not a repeatable situation.)

It {is / has been} three weeks since I {~~last received~~ / *~~have last received~~} a bill. (*The presence of last rules out the present perfect.*)

Though it is only six weeks ago since it ~~was~~ first *decided* to form a Rifle Club at Southwell, [so much energy has been thrown into the scheme that ...]. (www) (*The use of first rules out the present perfect.*)

It has been close to six months since he *has been* able to contribute fully to the operation. (www) (*Because the situation is repeatable, the interpretation is 'For nearly six months he has been unable to ...'.*)

[We are looking forward to it as] it is a good few years since we've *been* in Portugal. (www) (*similar*)

I have to say it is a long time since I *have heard* such total rubbish spoken about comets and Planet X. (www) (*similar*)

12.11.5 There are some exceptional cases in which a head clause in the present tense can collocate with a *since*-construction (especially in a conversational style):

- (a) The present tense can be found when the speaker focuses on the present continuation of a (permanent or temporary) habit whose beginning is specified by the *since*-construction.

[It was a daunting experience but a good boost for my learning process.] Since then I *am* a little more relaxed in front of the crowds. (www) (since then = ‘since and because of that experience’)

[I am by origin catholic but also went through the born-again stage with the Assembly of God for 2 years.] Since then I *am* back to being a catholic but with many different beliefs. (www) (*Compare*: {From that time onwards / For the last three years} I {*have been* / **am*} back to being a catholic.)

[I decided to give it a try and] since then I *don't take* any painkillers or inflammatory tablets. (www)

Ever since then, I *don't* just listen, I *hear*. (www)

[Dear Nikki, one year ago I had a hysterectomy and] ever since then I *don't want* sex very much. (www)

The following are examples with a *since*-clause:

I'm *feeling* much better since I {began / have begun} doing yoga exercises.

Since I have started doing Atkins I *have* terrible leg cramps. [How can I alleviate them?] (www)

There is no doubt that more people *are flying* into BUR than ever before since United has cancelled all direct flights from SFO to QNT. (www)

Since Switzerland has legalised “dope” Swiss banks, airlines, tunnels, roads and government offices *are* the unsafest places in the world. (www)

- (b) In examples like the following, *since then* only ostensibly collocates with the present tense. In fact, *since then* has been ‘raised’ from the subclause into the head clause in order to be fronted:

[He turned them around, and got them out of the relegation zone at the end of last season. In that sense he was certainly a success.] But since then he *doesn't seem* to have been able to take them forward. (www) (= ‘It seems that since then he hasn't been able to take them forward.’) (Note that the present tense is the default option here: Since then he hasn't seemed to be able to take them forward doesn't sound as good.)

Since then I (*don't*) *think* I have seen him here. (= ‘I (*don't*) think I have seen him here since then.’)

12.12 For-adverbials

A *for*-adverbial functioning as a pure duration adverbial is compatible both with the past tense and with the present perfect (e.g. I {*lived* / *have lived*} in London for three years). If it functions as a pure time-specifying adverbial or bifunctional adverbial

establishing a pre-present Adv-time, it is compatible with the present perfect but not with the past tense (e. g. I {**lived* / **was living* / *have been living*} *here for six months now*). In this section we also address the question which of the three temporal W-interpretations of the present perfect (indefinite, constitution, continuative) combines with which of the three uses of a *for*-adverbial.

12.12.1 A *for*-adverbial usually specifies no more than the duration of the full situation, i. e. it usually functions as a **PURE DURATION ADVERBIAL** (see 2.31.1). In this function it is compatible with any tense:

I {had worked / worked / would work / have worked / will work / will have worked} in that factory for three years.

In fact, it is only as a pure duration adverbial that a *for* phrase can combine with the past tense:

I lived in London for three years. (*For three years specifies the time of the full situation. Since the past tense represents the situation time as completely over at t_0 , and since the situation time here coincides with the time of the full situation, this sentence implies that I no longer live in London.*)

However, in combination with the present perfect, a *for*-adverbial can also function as a **BIFUNCTIONAL ADVERBIAL**, i. e. as an adverbial which at the same time specifies the duration of the **FACTUAL FULL SITUATION** (see 5.7) and establishes an Adv-time leading up to t_0 , i. e. a pre-present period. In addition, a *for*-adverbial can also be used as a pure **TIME-SPECIFYING ADVERBIAL**, doing no more than establishing a period up to t_0 . Compare:

“[I know Brighton well because] I have lived there for some time.” – “When was that?” – “From 2001 to 2003”. (*The present perfect clause receives an indefinite interpretation. This implies that the situation referred to has come to an end before t_0 and that for some time specifies the duration of the full situation.*)

I’ve been living here for six months now [and I like it]. (*The present perfect clause receives a continuative interpretation. This implies that for three years specifies the duration of the ‘factual full situation’, i. e. that portion of the full situation that leads up to t_0 . At the same time it establishes the relevant period up to t_0 .)*

“When did you last see him?” – “I haven’t seen him for a very long time.” (*The present perfect clause receives a constitution interpretation. This implies that for a very long time specifies the Adv-time that counts as period up to t_0 . Since no situation has actualized, for a very long time does not specify the duration of a full situation or of a factual full situation. In this case it is used as a pure time-specifying adverbial.*)

In sum, whereas a *for*-adverbial can only be a pure durational adverbial in clauses in the past tense, it may in principle be a pure duration adverbial, a

pure time-specifying adverbial or a combination of both (i.e. a bifunctional adverbial) in clauses in the present perfect. The question that remains to be answered is which of the three interpretations of the present perfect is compatible with which of the three uses of the *for*-adverbial. This question will be dealt with in the remaining subsections of 12.12.

12.12.2 On a continuative interpretation of a present perfect clause, the situation time fills the entire pre-present zone. This means that on that reading, a *for*-adverbial is a bifunctional adverbial, which indicates the length of the ‘factual full situation’ (see 5.7) as well as the length of the pre-present zone:

We have been using this kind of machine for three weeks. (*For three weeks* indicates the Adv-time leading up to t_0 as well as the length of the factual full situation, i.e. the full situation as it has actualized up to now. Nothing is said about the length of the ‘potential full situation’ – see 5.7.)

The interpretation of *for* as indicating a period up to t_0 can be enforced by the addition of *now* to the *for*-adverbial:

I’ve been waiting here for two hours now.

12.12.3 On an **UNMARKED UP-TO-NOW READING** (see 5.18) and on a **NONQUANTIFICATIONAL CONSTITUTION READING** (see 5.4.8), the situation time of a present perfect clause also fills the entire pre-present zone. Here too a *for*-adverbial will be interpreted as a bifunctional adverbial:

[The news that some of them are going to be made redundant has shocked the workers.] *We’ve been telling* them for years that this wouldn’t happen. (*unmarked up-to-now reading*)

What have you been doing for the last two hours? [*I’ve been looking* for you all over the place!] (*nonquantificational constitution reading*)

12.12.4 On a **QUANTIFICATIONAL CONSTITUTION READING** (see 5.19.1) of a present perfect clause, the situation time of the repetitive hypersituation also fills the entire pre-present zone. However, in this case a *for*-adverbial cannot be interpreted as a bifunctional adverbial. It can only be used in the following cases:

- (a) The *for*-adverbial can indicate the period-up-to-now, but only if the number of subsituations is zero. Otherwise we have to use (*with*)*in* instead.

I haven’t seen him for weeks. (*also possible: in weeks*) (*For weeks* is a time-specifying adverbial only.)

Seven people have been murdered in this area {in / within / *for} the last three months.

I’ve met him three times {in / *for} the last week.

- (b) If the number of subsituations is not zero, a *for*-adverbial can be used to specify the duration of the individual subsituations making up the repeti-

tive hypersituation or to specify the sum-total of the duration of the subsituations. In both cases it is used as a pure duration adverbial.

Since then I've visited him in prison for a short time three or four times. (*Each subsituation lasted a short time.*)

I've often been abroad for longer than two weeks since I have been a student. (*The for-adverbial indicates the duration of the various subsituations; the Adv-time-up-to-now is specified by the since-clause.*)

[He's often been ill in his life.] All in all he's been ill for a total of at least two years.

12.12.5 On an **INDEFINITE PERFECT INTERPRETATION**, a *for*-adverbial can only indicate the duration of the full situation(s):

I've recently spoken with her in hospital for nearly an hour [and I can assure you she's not dying yet].

[I've done a lot of jobs in my life.] I've been a factory-hand *for three years*, a freelance journalist *for nineteen months*, a postman *for two years*, [and God knows what other jobs I've done so far].

It follows that a *for*-adverbial also naturally combines with an **EXPERIENTIAL INDEFINITE PERFECT** (see 5.13) if the duration phrase is part of the description of the situation rather than an adverbial measuring the duration of the situation:

Have you ever worked in a factory *for at least a year* (not just as a student holiday job)? (*The experience being asked about is working-in-a-factory-for-at-least-a-year, not 'working in a factory'.*)

12.12.6 A clause using the present perfect and a *for*-adverbial may sometimes be ambiguous between a continuative and an indefinite interpretation. In the continuative interpretation, the *for* phrase indicates a period-up-to- t_0 as well as the duration of the situation time: the two time intervals coincide. In the indefinite interpretation, the *for*-phrase indicates the duration of the full situation, which is shorter than the length of the period up to t_0 .

If a present perfect is ambiguous in this way, the continuative interpretation is always the unmarked one. In fact, the indefinite interpretation requires a very specialized context (as detailed below the examples below). For example, the second example below requires a context in which it is relevant whether or not there has been a three-week period – specifically not a two-week or four-week period – of using 'this kind of machine'.

I have lived in London for three years. (*unmarked reading: I still live in London; out of context, the indefinite interpretation 'There has been a three-year period in my life during which I lived in London' will not be chosen, unless there is a heavy accent on have, in which case the sentence contradicts an explicit or implicit claim to the contrary.*)

We have used this kind of machine for three weeks. (*continuative or indefinite; the former interpretation will predominate if there is no indication to the contrary. The indefinite reading requires a contrastive accent on three.*)

I have helped him with his papers for two years. (*ambiguous; the continuative reading is the unmarked one*)

The indefinite interpretation of the last example is: ‘Somewhere in a period leading up to now there has been a two-year period when I helped him with his papers, but that period is over now.’ The markedness of this interpretation is clear from the fact that if we ask what question this sentence could be used to answer, then *Have you ever helped him with his papers for two years?* (meaning ‘Have you ever done a two-year stint of helping him with his papers?’, ‘Do you have experience of a two-year-helping-him-with-his-papers situation?’) is fine, but *Have you ever helped him with his papers?* is not. This means that the *for-Adv-time* does not form part of the new information provided by the answer and that the nuclear accent in *I have helped him with his papers for two years* tends to fall on *have*. If *I have helped him with his papers for two years* is nonetheless used as an answer to *Have you ever helped him with his papers?*, then it must be understood as a two-part answer: ‘Yes, I have helped him, I helped him for two years’.

In such a present perfect sentence with a *for*-adverbial, a continuative or indefinite reading may be promoted or enforced by one of the following factors:

- (a) The continuative interpretation is strongly promoted by the use of the progressive form:

We have been using this kind of machine for three weeks.

- (b) The continuative interpretation is enforced by the addition of *now* to the *for*-adverbial:

We have used this kind of machine for three weeks now.

- (c) The indefinite interpretation can be enforced by the context. This is the case, for example, when *We’ve lived in London for ten years* forms part of a piece of discourse like the following:

[We’ve lived in various European capitals so far.] We’ve lived in London for ten years, in Paris for seven years, in Berlin for three years and for a short while in Brussels.

Similarly, the unmarked continuative reading of *I have stayed in college for two months* is ruled out by the context in the following example:

Since I have been a student I have regularly stayed in college for two months without going home.

12.13 *Until*-adverbials

12.13.1 Prepositional phrases and adverbial clauses introduced by *until* (or *up to*, *till*, *up till*) can be used as pure duration adverbials (specifying the duration of the full situation). In that case the adverbial is compatible with various tenses.

I {had worked / worked / would work / have worked / will work / will have worked} until three in the morning.

12.13.2 The combination *not ... until X* is often used in the sense of 'as late as X', 'only at X'.

John didn't leave until midnight. (= 'John only left at midnight', 'John left as late as midnight', 'It was midnight before John left')

The boss wasn't in his office until noon. (*This is ambiguous between 'It is not true that the boss was in his office until noon' and 'It was noon before the boss was in his office'. On the former interpretation, not has wide scope over the whole sentence, on the latter it only has scope over until noon.*)

In such sentences, the *not ... until* adverbial answers the question *When?* rather than *How long?* This means that such a *not ... until* adverbial functions as a time-specifying adverbial (indicating a punctual time), not as a pure duration adverbial.

In the remainder of section 12.13, we will disregard this Adv-time use of *not ... until*.

12.13.3 An *until*-adverbial specifying a period up to a past orientation time is compatible with the past tense but is seldom used in combination with the present perfect. The present perfect is only possible if the period indicated by the *until*-adverbial is interpreted as an Adv-time-up-to- t_0 .

I {*stayed* / **have stayed*} with the body until the police came.

He *has stayed* with his wife's body until now.

Up till now I've *lodged* only one complaint against her.

It should be noted, however, that in negative sentences involving *until now*, *up to now*, *up till now*, etc., the past tense can be used to express a contrast between what was not the case before now but is the case now or is soon going to be the case:

[Hazardous waste experts know that certain bacteria can essentially eat toxic waste, reducing it to less noxious substances.] But until now they *didn't know* what mechanisms allowed these bacteria to devour chemicals. (www) (*contrast with the present: now they do know*)

[I have finally enabled permanent links for each post, which appear to be working fine, and provided you with the ability to leave comments.] Sorry I *didn't do* that until now. (www)

[That's true, but it can be easily fixed.] I *didn't do* that until now because I thought that ... (www)

The use of the past tense in the latter example means that the speaker treats his 'not doing that' as a past situation. This does not mean that he is actually doing it at t_0 . *Now* usually refers to an interval which is somewhat longer than the punctual t_0 . The sentence is therefore fine if the speaker has decided to 'do that' soon. What counts is that the speaker has mentally detached himself from the situation of 'not doing that', i. e. that he perceives this as a situation from the past.

In positive sentences involving *until now*, the present perfect can often be used as an alternative to the past tense. Compare:

We {*had / have had*} a small car until now, but yesterday we bought a people-carrier.

We *had* a small car until now. (*implies: but that has now changed or is now going to change*)

We *have had* a small car until now. (*This also implies that a situation is envisaged which entails that the situation that has held until now is no longer the case.*)

Similarly:

Until now I {*always shopped / have always shopped*} locally, {but now I mostly shop on-line / but I'm looking into the possibility of shopping on-line}.

Until now I {*always shopped / have always shopped*} locally. (*This suggests that the situation referred to is now over or is soon going to be over. This interpretation is due to the Gricean Maxim of Relevance: if the speaker is still shopping locally, he will normally say I always shop locally or I have always shopped locally. The addition of until now is only relevant if the situation has now changed or is now going to change.*)

We {*had / have had*} a small car until now, but yesterday we bought a people-carrier.

12.13.4 *Until now* is also compatible with a present perfect receiving a continuative interpretation:

Until now I {*have lived / have been living*} in the country. (*continuative interpretation: implies that I am still living in the country*)

The function of the *until*-adverbial here is that of a bifunctional adverbial. It specifies the period-up-to- t_0 throughout which the situation actualizes as well as the duration of the *factual* full situation. (It leaves open the possibility that the actualization will continue in the (as yet nonfactual) post-present, in other words that the *potential* full situation is longer than the actual one.)

12.13.5 *Until now* can also combine with the present perfect in sentences receiving a nonquantificational constitution reading or an unmarked up-to-now reading:

[There you are!] Where have you been until now?

Until now she has worked intermittently for various companies.

Until now I've lived in London, Paris, New York, Brussels and Berlin.

[Since 1888, the solo parts have been sung by professionals.] From then until now, these soloists *have* either already *had* international recognition or *have been* young soloists who have gone on to have very successful careers. (www)

12.13.6 On a quantificational constitution reading, *until now* does not specify the duration of the individual subsituations. It only indicates the Adv-time-up-to- t_0 . However, in this case *until now* is normally replaced with *up until now*, *up till now* or *up to now*:

{*Up until now* / *up till now* / *up to now* / [?]*until now*} I've met him three times.

12.13.7 The addition of *until now* to an indefinite perfect sentence as a rule results in ungrammaticality if the sentence is positive, not if it is negative:

I have already met her (*until now).

I know Pisa because I have visited it a couple of times (*until now).

I don't know Pisa because I've never visited it until now.

12.13.8 *Until*-adverbials other than *until now* (or one of its synonyms) cannot indicate an Adv-time-up-to- t_0 . It follows that they can only appear in a present perfect sentence on an indefinite interpretation, in which case they function as pure duration adverbials.

[Since I have been a student] I have always stayed in college until two days before Christmas.

Sentences which do not contain another adverbial (specifying the required period up to now) can only use an indefinite present perfect if they are used in a contradictive way. This implies that the *until*-adverbial does not represent new information and that the nuclear accent of the sentence falls on *have*:

I HAVE (already) worked until three in the morning.

This requires a suitable context, such as the following:

["You're a lazy bastard. You've never worked until three in the morning." – "That's not true!] I HAVE (already) worked until three in the morning. [Several times, in fact!]"

Here the new information is that, contrary to what has been claimed, the situation of the speaker working until eight in the evening *has* actualized in the past.

12.14 Before-adverbials

12.14.1 A *before*-adverbial is a time-specifying adverbial, not a pure duration adverbial or bifunctional adverbial. Depending on the temporal location of *X* in *before X*, it can combine with virtually any tense:

I {left / had left / would leave / would have left / will leave / will have left} before dark.

A *before*-adverbial can only combine with the present tense in habitual sentences, in sentences using the ‘**SPECIAL PRESENT TIME-SPHERE SYSTEM**’ – see 3.2–10):

I leave before dark every day. (*habitual present*)

That day they already meet in the cottage before midday. (*historic present*)

I'm leaving before dawn tomorrow. (*present tense used as a futurish form*)

The present perfect can combine with *before now* and with *before* if this is interpreted as ‘before t_0 ’.

I've seen that man {before now / before / *before breakfast this morning}.

If *X* in ‘before *X*’ is a time other than t_0 , the adverbial can combine with an indefinite present perfect, but only to convey an (at least potentially) repetitive reading in which the *before*-adverbial forms part of the description of the situation that is located in the pre-present – see 5.11.1:

You think I've never got up before 5 o'clock? I can assure you I *HAVE* got up before 5 o'clock. Many times.

[When I've requested that our positions be posted on certain web sites,] the advertisement period *has* sometimes closed before the webmaster has updated his/her list. (www)

[Difficulties have arisen under the current arrangements in so far as] the 21 day period *has* sometimes begun before the CAA has received all the information that it has needed to consider a planning application. (www)

12.14.2 A present perfect combining with *before (now)* can only yield an indefinite reading or a quantificational constitution reading.

I know you. We've met before, haven't we? (*indefinite reading*)

This kind of disease *has occurred* in our village only twice before. (*quantificational constitution reading*)

Have you been living in this house? (*continuative reading: we cannot add before on this reading*)

Have you ever heard this before? (*indefinite reading*)

How often have I told you this before? (*quantificational constitution reading*)

12.14.3 The idea ‘before t_0 ’ usually lexicalizes as *before* rather than as *before now*. This is in keeping with the fact that t_0 is by definition given.

12.14.4 The use of tenses in sentences involving a *before*-clause will be examined in detail in chapter 14.

12.15 The present perfect with adverbials referring to the present

With adverbials referring directly to the present (*at present, now, nowadays, these days*), it is sometimes possible to use the present perfect (but obviously not the past tense) when evaluating the present state of affairs resulting from a pre-present situation.

12.15.1 Needless to say, a past tense cannot co-occur with a time adverbial referring to the present. On the other hand, the present perfect can be used with *now* and/or *at present* in sentences evaluating the present state of affairs resulting from a pre-present situation. We can distinguish between four types. First, the sentence may contain a quantificational NP and ‘measure’ the progress which the situation starting before t_0 has made at t_0 . In this case *at present* can be used, but not *now*:

{At present / *now / up to now} only half of the goods have been sold. [We will have to make a special effort to sell the rest.]

{At present / *now / up to now} I’ve only met two of his four sisters.

In this type, the VP (e.g. *sell half of the goods*) is ‘telic’ (see 1.39), and so is the kind of situation represented by the VP minus the quantifier (e.g. *sell the goods*). It is the telicity of the latter VP that is relevant: the speaker expresses how far the situation (which develops towards an inherent terminal point) has developed at t_0 . (The quantifier *half of* indicates the result of this measuring.) The present perfect naturally receives a quantificational constitution reading.

The second type is similar, but now the VP is not telic and what is measured is the length of a situation that started before t_0 and still continues at t_0 . Both *now* and *at present* are acceptable.

At present we’ve been living here for three months. [That’s not a very long time.]

We’ve walked quite a long way now. [Isn’t it time we had a rest?]

I’ve been working for seven hours on end now.

Such sentences typically contain a pure duration adverbial or measure phrase. They naturally receive a continuative reading.

In the third type, the speaker sums up what is the latest state in the actualization of a chain of dynamic situations. The sentence is interpreted as ‘Now it is the case that X is the latest event’:

[He’s completely out of control. Last week he stole a bike.] Now he’s been arrested for dealing hash. (*indefinite interpretation*)

[He’s completely out of control. Last week he stole a bike.] Now he’s been dealing hash. (*nonquantificational constitution reading or unmarked up-to-now reading*)

In these examples, we cannot substitute *at present* for *now*.

In the fourth type, the speaker evaluates a given state of affairs. The sentence is interpreted as ‘Now X appears to be the case’ or, more generally, ‘The latest state of affairs is that state X holds as a result of the actualization of Y’.

It has become clear now that he is not to be trusted.

12.15.2 *Nowadays* can combine with the present perfect in the fourth of these meanings only:

{At present / *nowadays} I’ve only met two of his four sisters. (*interpretation 1*)

{At present / *nowadays} we’ve been living here for three months. (*interpretation 2*)

[He’s completely out of control. Last week he stole a bike.] {Now / *nowadays} he’s been arrested for dealing hash. (*interpretation 3*)

It has become unclear nowadays whether... (www) (*interpretation 4*)

Nowadays, food has become easier to prepare. (www) (*interpretation 4*)

12.15.3 In Standard English, *these days* usually combines with the present tense:

We’re caring more for our environment these days.

Young actors *have* a greater instinct these days for film than they do for the stage. (BNC)

These days Konitz plays everything from standards to samba. (BNC)

However, the present perfect is possible too on the resultant state reading (= the fourth interpretation pointed out in 12.15.1):⁴

These days we *have dealt* very satisfactorily with the problem. (BNC)

4. The following examples reveal another, American English, use, which does not belong to Standard British English (yet?). In this use, *these days* can combine with a present perfect yielding a continuative interpretation.

[Osama bin Laden had no comment.] He’s *been* awfully uncommunicative these days. (www)

Oh Well. I *haven’t gotten* much done these days. [I’ve just been letting everything pass me by recently.] (www)

We’ve *been* pretty honest these days, and all of us *have talked* about our own inadequacies and the inadequacies of our institutions. (www)

With women's magazines these days warts *have taken on* an entirely new dimension. (BNC)

[Keith would hit them. Or rather he wouldn't, but he would want to.] These days he *has decided* to be the sort of man who does not hit people. (BNC)

These days, I've actually *reached* the point where I'll just phone friends who e-mail me. [This makes no sense, of course.] (www)

I've not only *matured* these days and act more my age, [but also I've grown spiritually by leaps and bounds in recent months.] (www)

[I asked these right-wing Bushites:] "Is that the new tone in Washington and the character and dignity *we've been hearing* so much about these days?" (www)

12.16 Tense choice with actualization adverbials

'Actualization adverbials' (e. g. *already, always, not ... yet, ever, never, still*) referring to (non)actualization in a past period combine with the past tense. Those referring to (non)actualization in a period leading up to now combine with the present perfect, but in (especially spoken) Am. E. and to a lesser extent in colloquial Br. E., the past tense is often used as an alternative.

12.16.1 By **ACTUALIZATION ADVERBIALS** we mean such indefinite time expressions as *already, always, not ... yet, ever, never* and *still*, which do not inherently indicate a particular time but refer to (non)actualization in a particular period. They combine with the past tense if the period in question is a past one, i. e. is a period which precedes t_0 and is completely cut off from it, and with the present perfect if the period in question is a period leading up to now. In the latter case, a continuative reading is excluded.

The trees were already shedding their leaves. (*focus on the past time when the situation was in progress*)

I've never spoken to the President. (*The perfect receives either an indefinite reading – never = 'never in my life up to now' – or, in a context asking when or how often I have spoken to the President, a quantificational constitution reading.*)

Did you ever beat him? (*e. g. when both of you were still professional players*)

Have you ever beaten him? (*e. g. in your life*)

I have already paid the bill. (*indefinite perfect, with a resultativeness implicature*)

I have already been reading poetry. (*In spite of the progressive form, the only possible reading is noncontinuative: 'There has already been a period-before-now during which I was reading poetry.'*)

The opposition has not yet reacted to Mr Major's speech.

I have never heard such nonsense {in my life / before}.

I still haven't seen him. (*in a period up to t_0*)

(At the time) I still did not want to live in London.

12.16.2 With actualization adverbials implying a period up to t_0 , Am. E. often uses the past tense, especially in spoken language. In colloquial Br. E. too, the past tense is sometimes used with *always*, *ever*, and (less frequently) with *never*:

I already did that. (Am. E.) (*Br. E. uses I've already done that instead.*)⁵

I (have) always said he was not to be trusted.

Graham {has always been / always was} a brilliant scientist.

{Have you ever seen / Did you ever see} such a beauty?

[One day he pulled me apart in front of the staff.] I *never* felt so small in my life.

[I could hardly speak.] (www)

12.17 Tense choice with adverbials indicating a recent indefinite bygone time

Four adverbials that indicate a 'recent indefinite bygone time' (viz. *recently*, *just*, *this minute*, *lately*) can co-occur with an indefinite present perfect. However, there are cases in which the past tense can be used too. This use is investigated here for each of the four adverbials.

12.17.1 On an indefinite interpretation, the present perfect co-occurs with four adverbials that indicate a **RECENT INDEFINITE BYGONE TIME**, viz. *recently*, *just*, *this minute*, *lately*.

This telegram has just arrived.

I have this minute heard that the deal is off.

I have recently met him.

There haven't been any burglaries here lately.

However, there are cases in which the past tense can be used too. In the next subsections we investigate this use for each of the four adverbials.

5. The British National Corpus does contain a couple of examples, though, in which *already* combines with the past tense where the present perfect would normally be used: ["Perhaps we'd better think seriously about getting you away from here, after all." – "I ain't going," said Dolly.] "I already *told* you so." "Very useful advice. Shame I already *got* it from Cowley."

12.17.2 Br. E. normally uses the present perfect with *this minute*.⁶

I've this minute seen her in the street.

However, the past tense is occasionally found when the 'closeness to now' (recency) is sufficiently clear:

Excellent timing – I just this minute *stepped* into the garden [to be greeted by a frantic shrieking noise and noticed a Peregrine Falcon with an unfortunate starling in its talons]. (www)

I just this minute *telephoned* them [and thankfully, Sundays are fine for them, so – despite a little initial panic – it needn't disrupt my planned moving]. (www)

I only *heard* about it this minute.

[Well then. You haven't heard?] Sergeant Archer and his mates just *left* this minute; [I would have thought you'd have passed them in the hall.] (www)

12.17.3 *Recently* combines with the present perfect if it is interpreted as indicating a period leading up to now or when it functions as an adverbial specifying a 'recent indefinite bygone time'. It combines with the past tense if it functions as an indefinite specifier of a time which is treated as past.

They've recently bought a second car. (*Recently* indicates a 'recent indefinite bygone time', i. e. it is an indefinite specification of a bygone time in a period leading up to now. The present perfect receives an indefinite interpretation.)

They recently bought a second car. (*Recently* is used as an indefinite specification of a time which is treated as past. There is no clear difference of meaning between this example and the previous one.)

I {have recently seen / recently saw} a picture of him in the paper.

I haven't seen Jim recently. (*Recently* indicates a period leading up to now. What is said is that the situation of the speaker seeing Jim has not actualized in that pre-present period. The present perfect thus receives an indefinite interpretation.)

It's only recently that I've had time to read newspapers. (*Recently* indicates a period leading up to now. The present perfect receives a continuative interpretation.)

He has been considering changing his job recently. (*continuative*)

12.17.4 *Lately* is similar to *recently*, except that it does not combine with the past tense in Standard Br. E.

I haven't seen Jim lately. (*Lately* indicates a period leading up to now. What is said is that the situation of the speaker seeing Jim has not actualized in that pre-present period. The present perfect thus receives an indefinite interpretation.)

Have you been to the dentist lately? (*The speaker asks if a particular situation has actualized in a pre-present period. The present perfect receives an indefinite interpretation.*)

6. Of course, we disregard those cases in which *this minute* means 'right now':

You put that chain saw away this minute! (www)

He's only lately begun working here. (*Lately* is an indefinite specification of a bygone time in a period leading up to now. The present perfect receives an indefinite interpretation.)

The petrochemical market has lately started recovering [after having experienced a quite sharp recession in 1998.] (*similar*)

It's only lately that I've had time to read the newspaper. (*Lately* indicates a period leading up to now. The present perfect receives a continuative interpretation.)

She has lately been concentrating on writing and recording other genres of music. (*continuative*) (Examples like these sound rather old-fashioned. It is only with *only lately* that a continuative interpretation sounds quite natural, as in the preceding example.)

12.17.5 When it specifies a time lying immediately before t_0 , *just* usually combines with the present perfect in Br. E., but (under Am. E. influence) the past tense is also occasionally heard.

I *have just had* a long talk with the man at the centre of the crisis. (LOB)

She *has just made* her first record for Philips, called 'Kiss Me'. (LOB)

I just *met* a friend of yours, Andy Wilson.

12.17.6 With *just now*, the choice of tense depends on its interpretation, which is related to its accentuation pattern and position in the clause:

(a) *Just now* can be used as a synonym of temporal *just*. In that case *now* is accented while *just* is not, and *just now* follows the verb or takes final position in the clause. This kind of *just now* normally combines with the past tense rather than the present perfect:

I *heard* just now that the deal is off.

I {*found* / **have found*} the missing papers just now.

What was that you *were singing* just now?

Examples with the present perfect are extremely rare. The BNC only contains the following two:⁷

I *have said* just now they must try and stop this coming in because ...

Once you've got your objectives then you select those themes or ideas from what you've *done* just now to support that objective.

7. The following are www examples:

Martin Sixsmith was trying to approach it [= the question] from the point of view of the Civil Service and he, of course, as we *have heard just now* from Mr Baume, met a very vigorous specialist adviser who was prepared, on media matters, to put another case forward.

I've *been thinking just now* about how scared I was, even as a child, to fail to live up to others' standards.

I've *said* a prayer *just now* for you and your Bill. (...) Please take good care.

- (b) When *just now* means ‘only just’ (in the sense of ‘only a very short time ago’), *just* is more accented than *now* and *just now* is normally placed in pre-verb position, i. e. before the verb if there are no auxiliaries and otherwise after the first auxiliary. In this use, *just now* combines with the present perfect and not with the past tense.

I {*have just now heard* / **have heard just now*} that the deal is off. (*The emphasis is more strongly on recency.*)

I *have just now noticed* that every time I post on blogger, it always shows my previous post instead of the new one. (www)

July 27. *I've just now transferred* everything over to our brand new flat. (www)

Oh my god, *it has just now dawned* on me that I will be eighteen soon! (www)

I *have just now returned* from seeing the new E. T. Special Edition! (www)

- (c) *Just now* can also mean ‘right now’, with *now* referring to t_0 . In that case it combines with the present tense.

I'm busy just now. [Can't you come back tomorrow?]

“He's staying at my flat just now,” said Celia. (LOB)

No, Mr Martin, he's out just now. (LOB)

No doubt there will be many readers with new gardens who just now *are thinking* of making a vegetable garden for the first time. (LOB)

12.18 Tense choice with *once*

- (a) When the adverb *once* means ‘once upon a time’, it normally collocates with the preterite, not with the present perfect:

There *were* once three squaws. [One sat on a leopard skin. One sat on a doe skin. ...] (www) (*The present perfect cannot be used.*)

- (b) The past tense is also the rule when *once* means ‘in the past, but not now’:

TV sets are much cheaper now than they {*once were* / *were once* / **have once been*}.

Guns *were* once common in schools. [Until 1969, virtually every public high school in New York City had a shooting club.] (www)

“What Were Once Vices Are Now Habits” is my favourite Doobies album. (www)

- (c) *Once* can also mean ‘at a certain time’. Since it is a matter of conceptualization whether ‘at a certain time’ means ‘at a certain time in the past’ or ‘at a certain time in the pre-present’, both the past tense and the present perfect can then be found:

He {*once promised* / *has once promised*} to help me.

All grownups {*were once / have once been*} children – although few of them remember it.

It's amazing how things that *were* once important are no longer as important. [It can be a gradual change – or sometimes overnight.] (www)

By daylight the bower of Oak's newfound mistress (...) presented itself as a hoary building of the Jacobean stage of Classical Renaissance as regards its architecture, and of a proportion which tells at glance that, as is frequently the case, it *has once been* the manorial hall on a small estate. (BNC)

Peat is a soil-like material made up of partly rotted organic matter (things that *have once lived*). [It is still used in many composts.] (www)

- (d) When *once* is used in pre-verb position (i.e. after the first auxiliary or before the only verb form) and means 'there has been an occasion when ...', the present perfect is used:

[John is somebody who spies on his neighbours.] I've *once seen* him opening their dustbins and searching the contents.

[Don't be afraid to ask.] The chances are these people *have once been* in a similar situation themselves. (www)

I'm sure you *have once posted* something, then regretted it! [Think About it!] (www)

It pains me to say that I *have once booed* one of my team's players. (www)

All our members *have once been* in the same position, in fact that's why we started! (www)

- (e) The present perfect is used when the sentence with *once* can be paraphrased 'once X has happened, Y ...'

What we *have once enjoyed* we can never lose. (www) (= 'Once we have enjoyed something, we can never lose it.')

And if you *have once demonstrated* your skill at copying chairs, you can get on with meeting all the requests you will surely have from family and friends. (BNC)

Hence we find those who *have once quarrelled* carry themselves distantly, and are ever ready to break the truce. (www)

- (f) If *once* means 'one single time' (as against *twice, three times*, etc.) it may collocate with any tense, including the present perfect. In that case it does not normally fill the pre-verb position.

My late Uncle Harry *saw* the sea only once in his lifetime. (= 'only once in a past period')

I *have read* the book only once. (= 'only once in my life, which is a period leading up to now') (quantificational constitution reading)

I've *slept* here once only. (quantificational constitution reading)

[I don't think any of the others caused the injury.] I *have* once before heard of this happening to a Lionhead belonging to a friend of my son. (www)

- (g) *Once again* and *once more* can similarly combine with any tense, including the present perfect.

Relations *were* once more *worsening* between them.

We *had once again had* a busy year. (www)

Abbeyle and Sheffield *have* once again *shown* their commitment to developing world class facilities with this development. (www)

His tales of wedding plans *have* once again *focused* me on the event. (www)

All praise the mighty Wharf, for they *have* once again *tried* something new, exciting and may I say better. (www)

Relations *have* once more seriously *worsened* between Iraq and the UN Special Commission (UNSCOM) investigating Iraq's weapons-of-mass-destruction. (www)

DEMO

III. Summary

12.19 Types of temporal adverbials

12.19.1 Temporal adverbials can be categorized as **deictic** (e. g. *yesterday*, *the day before*) or **nondeictic** (e. g. *at some time or other*, *at five o'clock*) depending on whether or not they are related to a temporal 'anchor'. The former can be further categorized as either **absolute deictics** (e. g. *yesterday*) or **relative deictics** (e. g. *the day before*) depending on whether the temporal anchor is t_0 or another time, and as either **single-zone** adverbials (e. g. *yesterday*) or **multi-zone** adverbials (e. g. *today*) depending on whether they refer to only one absolute zone (e. g. the past zone) or to a time span which includes the present zone plus the post-present and the pre-present or the past. Nondeictic adverbials are automatically **zone-independent**.

12.19.2 Temporal adverbials can also be categorized as **homogeneous** (e. g. *in 1983*) or **heterogeneous** (e. g. *from 1983 to 1986*) depending on whether or not they can refer to the time interval (Adv-time) in its entirety as well as to any subpart of it. Within the latter class, we can formally distinguish between **inclusive** adverbials, introduced by (*with*)*in*, and **noninclusive** ones.

12.20 Tense choice with temporal adverbials

12.20.1 **Nondeictic adverbials**, by virtue of being unanchored, are compatible both with the past tense and with the present perfect (on an indefinite, often repetitive reading). Compare.

- (a) I got up *at two a.m.*
- (b) [You don't believe I've ever got up *at two a.m.*? I can assure you.] I **HAVE** got up *at two a.m.* [Several times.]
- (a) I worked *until three in the morning*.
- (b) ["You're a lazy bastard. You've never worked until three in the morning." – "That's not true!"] I **HAVE** (already) worked *until three in the morning*. [Several times, in fact!]"
- (a) I got up *before 5 o'clock*.
- (b) You think I've never got up *before 5 o'clock*? I can assure you I **HAVE** got up *before 5 o'clock*. Many times.

12.20.2 **Past-zone adverbials** are only compatible with the past tense, not with the present perfect (not even when there is a clear idea of present relevance or resultativeness):

I {stayed / *have stayed} with the body until the police came. (*Adv-time up to a past orientation time*)

[I know what it means to be in the army.] I {served / *have served} *during the Falklands war*.

12.20.3 **Noninclusive heterogeneous pre-present-zone adverbials** normally combine with the present perfect only:

I {*was / have been} fascinated by insects *from childhood*. (*continuative reading*)

At least a dozen accidents have happened here *over the past four years*. (*quantificational constitution reading*)

Nothing much has been done about it *over the last three years*. (*indefinite reading*)

12.20.4 **Noninclusive homogeneous pre-present-zone adverbials** mostly (and those of the type *for the {past / last} two weeks* exclusively) combine with the present perfect, but the past tense is sometimes used, though seldom in Br. E., to imply a break between the past and the present:

It has been highly successful *in the past* [and with your support this success will continue.] (www)

The profession of a doctor was respectable *in the past* [but today society has changed]. (www)

12.20.5 **Inclusive pre-present-zone adverbials** can in principle combine with either the past tense or the present perfect. The choice of tense depends on the speaker's temporal focus.

["When did he disappear?"] — He disappeared *within the last month*. (*focus on THEN*.)

Security awareness *has increased* significantly within the last year. (www) (*focus on NOW*)

12.20.6 **Multi-zone temporal adverbials** can in principle combine with either the past tense or the present perfect; the choice of tense depends on the speaker's temporal focus.

I've been working hard this month.

I *went* to the museum today, [but it was closed].

I {*have spoken* / *spoke*} with Tim today.

12.20.7 With **since-adverbials** the rules are as follows. If the adverb *since* or a prepositional phrase with *since* indicates a period up to t_0 , the clause in which it is used has to be in the present perfect: *I haven't seen him {since / since that night}*. If the *since*-adverbial is a *since*-clause indicating a period up to t_0 , the head clause uses the present perfect, whereas the *since*-clause uses the present perfect if the situation referred to leads up to t_0 and the past tense if

the situation in question is a bygone situation: *I haven't seen him since I {have been living here / came to live here}*. A possible exception is a cleft of the type *It {is / has been} a long time since I {went / have gone} to a restaurant*. The use of the present perfect in the *since*-clause is then only possible if the situation in question could in principle have actualized several times in the pre-present period. Thus, the present perfect is ungrammatical in *It {is / has been} a long time since my wife {died / *has died}*.

There are also some exceptional cases in which a head clause in the present tense can collocate with a *since*-construction, especially in a conversational style (see 12.11.5).

12.20.8 A **for-adverbial** functioning as a pure duration adverbial is compatible both with the past tense and with the present perfect. If it functions as a pure time-specifying adverbial or bifunctional adverbial establishing a pre-present Adv-time, it is compatible with the present perfect but not with the past tense:

- I {lived / have lived} in London *for three years*. (*pure duration adverbial*)
 ["When did you last see him?"] I {*didn't see / haven't seen} him *for three years*. (*pure time-specifying adverbial indicating a period up to now*)
 I {*lived / *was living / have been living} here *for six months now*. (*bifunctional adverbial indicating a period up to now*)

We have also addressed the question which of the three temporal interpretations of the present perfect (indefinite, constitutive, continuative) combines with which of the three uses of the *for*-adverbial (see 12.12.2–6).

12.20.9 In section 12.13 we have investigated the (in)compatibility of the preterite and the present perfect with various kinds of **until-adverbials**. We have shown, amongst other things, that *until now* is typically followed by a present perfect, in which case the indefinite, continuative and up-to-now W-readings are all available, subject to restrictions.

- Until now I {have lived / have been living} in the country. (*continuative interpretation*)
 Until now she has worked intermittently for various companies. (*up-to-now reading*)
 I don't know Pisa because I've never visited it until now. (*indefinite reading; requires a negative clause*)

However, to express a contrast with the present, the past tense is often used, especially in negative clauses (see 12.13.3):

- [I have finally enabled permanent links for each post, which appear to be working fine, and provided you with the ability to leave comments.] Sorry I *didn't* do that until now. (www)

12.20.10 With adverbials referring directly to the present (*at present, now, nowadays, these days*), it is sometimes possible to use the present perfect (but obviously not the past tense) when evaluating the present state of affairs resulting from a pre-present situation:

At present only half of the goods have been sold. [We will have to make a special effort to sell the rest.]

I've been working for seven hours on end *now*.

Nowadays, food has become easier to prepare.

These days we have dealt very satisfactorily with the problem.

12.20.11 **Actualization adverbials** (e.g. *already, always, not ... yet, ever, never, still*) referring to (non)actualization in a past period combine with the past tense. Those referring to (non)actualization in a period leading up to now combine with the present perfect, but in (especially spoken) Am. E. and to a lesser extent in colloquial Br. E., the past tense is often used as an alternative:

Did you ever beat him? (e.g. *when both of you were still professional players*)

Have you *ever* beaten him? (e.g. *in your life?*)

Graham {*always* was / has *always* been} a coward. (*was* is colloquial)

12.20.12 On an indefinite interpretation, the present perfect co-occurs with four adverbials that indicate a 'recent indefinite bygone time', viz. *recently, just, this minute, lately*. However, there are cases in which the past tense can be used too.

With *this minute* (in the sense of 'very recently') the present perfect is normally used in Br. E., although the past tense can be found when the idea of recency is sufficiently obvious:

I've *this minute* seen her in the street.

[Well then, You haven't heard?] Sergeant Archer and his mates just left *this minute*; [I would have thought you'd have passed them in the hall.] (www)

Recently and *lately* combine with the present perfect if they are understood as referring to a period leading up to now or as specifying a 'recent indefinite bygone time'. *Recently* can combine with the past tense when it specifies an indefinite time treated as closed off from now.

They've {*recently* / *lately*} bought a second car.

They *recently* bought a second car.

When *just* refers to a time lying immediately before t_0 it usually combines with the present perfect in Br. E., but the past tense is not uncommon. The alternative *just now* (with an accent on *now*) is normally used with the past tense. When *just now* (with a heavier accent on *just* than on *now*) means 'only just', it is used with the present perfect only.

I {*just met* / have *just met*} a friend of yours, Andy Wilson.

I {found / *have found} the missing papers *just now*.

I {**just now* heard / have *just now* heard} that the deal is off.

12.20.13 With **once**, either the past tense or the present perfect is used, depending on the meaning of this adverb. For example:

There {was *once* / *has *once* been} a butterfly who wished for a bride. (*'once upon a time'*)

TV sets are much cheaper now than they {*once* were / *have *once* been}. (*'in the past, but not now'*)

He {*once* promised / has *once* promised} to help me. (*'at a certain time {in the past / in the pre-present}'*)

I've *once* heard democracy described as controlled civil war. (www) (*'there has been an occasion when ...'*)

What we have *once* enjoyed we can never lose. (www) (*'once X has happened, Y'*)

DEMO

DEMO

13. Adverbial *when*-clauses and the use of tenses

I.	Introduction	637
13.1	Delineation of the subject	637
13.2	<i>When</i> -clauses as situation-time adverbials or as orientation-time adverbials	638
II.	The temporal structure of adverbial <i>when</i> -clauses	641
13.3	<i>When</i> -clauses and temporal structure	641
13.4	Combining <i>when</i> -clauses with other time-specifying adverbials	650
13.5	The relation between the situation time of the head clause and the Adv-time of the head clause	651
13.6	The definition of ‘simultaneity’ and ‘situation time’	654
III.	Configurations of temporal relations	655
13.7	Possible combinations of tenses in head clause and <i>when</i> -clause	655
13.8	Further remarks on the configurations	657
IV.	Direct and indirect binding in <i>when</i> -clauses	660
13.9	Definitions of direct and indirect binding in <i>when</i> -clauses	660
13.10	The use of indirect binding in <i>when</i> -clauses	660
V.	Pseudo-sloppy simultaneity	667
13.11	Definition of pseudo-sloppy simultaneity	667
13.12	Further remarks on pseudo-sloppy simultaneity	668
VI.	The expression of irrealis or tentativeness in <i>when</i> -clauses	673
13.13	Counterfactual <i>when</i> -clauses	673
13.14	Tentative <i>when</i> -clauses	674
VII.	Adverbial <i>when</i> -clauses using an absolute tense form	675
13.15	Summaries, etc.	675
13.16	Other cases in which the <i>when</i> -clause is in the future tense	675
13.17	Habitual-repetitive sentences	676
VIII.	<i>When</i> -clause and head clause referring to different times	680
13.18	Head clause referring to the past and <i>when</i> -clause referring to the present	680
13.19	Head clause referring to a past domain and <i>when</i> -clause referring to the post-present	681
13.20	Head clause referring to the pre-present and <i>when</i> -clause referring to the present	681
IX.	Summary	683

Abstract

In this chapter an analysis is presented of the temporal structure expressed by *when* and we examine the possibilities of tense choice in adverbial *when*-clauses and in the head clauses supporting them.

In part I (= sections 13.1–2) we define the use of *when*-clauses as ‘situation-time adverbials’ and as ‘orientation-time adverbials’.

Part II (= sections 13.3–6) is devoted to the temporal structure of *when*-clauses. It is shown that this structure consists of a ‘common Adv-time’ containing both an orientation time from the tense structure of the head clause (the ‘contained orientation time of the head clause’) and an orientation time from the tense structure of the *when*-clause (the ‘contained orientation time of the *when*-clause’). This temporal structure, which is the semantics of *when*, can therefore be paraphrased as ‘at a/the time at which’. It is also argued that the *when*-clause can specify either the situation time of the head clause or an orientation time which binds the situation time of the head clause in terms of T-anteriority or T-posteriority. (In other words, the *when*-clause can be used either as a situation-time adverbial or as an orientation-time adverbial.) In each case the *when*-clause uses a relative tense, which represents the situation time of the *when*-clause as T-anterior, T-simultaneous or T-posterior to the contained orientation time of the *when*-clause.

It follows that there are nine unmarked configurations of temporal relations, realising nine different temporal structures involving the common Adv-time expressed by *when*. These nine configurations are discussed in part III (= sections 13.7–8). They have in common that the situation time of the *when*-clause is bound by the contained orientation time of the *when*-clause, and can be considered as forming the set of unmarked options as far as tense choice is

concerned. As the examples show, all nine of them are compatible with reference to the past as well as with reference to the post-present.

Apart from the unmarked options, there are some marked uses of tenses in adverbial *when*-clauses. Under certain conditions the *when*-clause can use the past perfect (but not the conditional tense or conditional perfect) to effect ‘indirect binding’, i. e. to relate the situation time of the *when*-clause to an orientation time which is not the contained orientation time of the *when*-clause (and which is not t_0 either). This possibility is examined in part IV (= sections 13.9–10).

Part V (= sections 13.11–12) deals with sentences in which the two situations are not interpreted as W-simultaneous, although the *when*-clause uses a form expressing T-simultaneity, e. g. *When I receive his letter, I will write a reply at once*. It is shown that this is not a ‘sloppy W-simultaneity’ interpretation (due to a ‘sloppy’ use of tenses – see 9.20.4) but follows from the temporal structure of *when*, which does not require the two contained times of orientation to coincide. The phenomenon is therefore called ‘pseudo-sloppy simultaneity’.

There are also cases in which the *when*-clause uses the conditional tense or conditional perfect in order to express irrealis, i. e. in order to represent the actualization of the *when*-clause situation as imaginary or contrary to fact, or in order to express modal tentativeness. These cases are considered in part VI (= sections 13.13–14).

Part VII (= sections 13.15–17) treats some contexts in which the *when*-clause ‘shifts the domain’, while part VIII (= sections 13.18–20) considers some exceptional cases in which the *when*-clause and the head clause refer to different time-zones.

Part IX, finally, summarizes the chapter.

I. Introduction

13.1 Delineation of the subject

Adverbial *when*-clauses specify an Adv-time. Semantically and diachronically, they are ‘headless’ relative clauses, i. e. relative clauses whose relative pronoun ‘contains’ a covert antecedent. In the same way as *what he wanted* means ‘that which he wanted’, *when he came* means ‘then when he came’, which is equivalent to ‘at the time at which he came’.

‘Narrative’ *when*-clauses, which do not specify the time of the head clause situation but ‘push forward’ the action (e. g. *I had just gone to bed when the phone rang*) are not adverbial *when*-clauses and will therefore be disregarded.

13.1.1 *When*-clauses can be used in various ways (e. g. relative clauses, object clauses, adverbial clauses). In this chapter we will only be concerned with adverbial *when*-clauses. Like any other time-specifying adverbial, an adverbial *when*-clause specifies an Adv-time. This Adv-time is interpreted as punctual if the time of the full situation of the *when*-clause is punctual (as in *John arrived when I left*) and as durative if the time of the full situation of the *when*-clause is durative (as in *John arrived when I was in my study*).

Adverbial *when*-clauses deserve investigating in this book on tense for several reasons. They present one of the rare cases in which the tense form of the subclause is bound by a time of orientation other than the situation time of the head clause. This follows from the temporal structure of *when*, which, as we will see, means ‘at the time at which’. Moreover, a combination of a head clause and a *when*-clause realizes one of at least nine possible configurations of temporal relations. *When*-clauses allow a special type of ‘indirect binding’ and also allow other tense choices which cannot be found in most other types of subclause. In sum, they are interesting to the use of tenses in many respects.

13.1.2 Semantically and diachronically, *when*-clauses are **HEADLESS RELATIVE CLAUSES** (or **FREE RELATIVE CLAUSES**), i. e. relative clauses whose relative pronoun ‘contains’ a covert antecedent. In the same way as *what he wanted* means ‘that which he wanted’, *when he came* means ‘then when he came’, which is equivalent to ‘at the time at which he came’. The only difference is that ‘that which he wanted’ is an NP, while ‘at the time at which he came’ is a prepositional phrase functioning as a temporal adverbial. In other words, in the same way as *what he wanted* is commonly called a ‘nominal relative clause’, *when he came* can be referred to as an ‘adverbial relative clause’, at least as far as its syntactic function is concerned. As will be explained in more detail in 13.3, *when* has the internal tem-

poral structure ‘at the time at which’, in which ‘which’ represents an implicit orientation time which binds the situation time of the *when*-clause. (This explains, among other things, why adverbial *when*-clauses referring to the post-present use the ‘Pseudo- t_0 -System’ rather than the ‘Absolute Future System’ – see 10.1–2.)

For a good understanding of this chapter it is very important to keep this starting-point in mind: adverbial *when*-clauses are really restrictive relative clauses depending on a prepositional phrase (‘at the time’) or adverb (‘then’) functioning as Adv-time.

13.1.3 A type of *when*-clause which is perhaps not always easy to distinguish from the adverbial type is the ‘**NARRATIVE WHEN-CLAUSE**’, examples of which are to be found in the following sentences:

She had just picked up the revolver when movement *caught* her eyes. (www)

Yesterday evening I was sitting in the living-room, watching TV, when suddenly a policeman *came in*.

I was just having a chat with the vicar when he *was called away*.

We had hardly sat down to rest when the darkness *fell* upon us. (www)

Scarcely will the farmer finish ploughing when the seed planted *will be* ripe for harvest. (www)

I know Tom. Hardly will he have left the country when he *will* already *regret* his decision.

In examples like these it is the head clause situation that functions as time indication for the *when*-clause situation, rather than the other way round. In other words, the *when*-clause does not specify the time of the head clause situation but ‘pushes forward’ the action. This means that such a narrative *when*-clause does not create an Adv-time but establishes a temporal domain of its own. This explains why it uses an absolute tense form (e.g. a form from the Absolute Future System), as in the last two examples).

Since narrative *when*-clauses are not adverbial *when*-clauses (i.e. clauses indicating an Adv-time), we will disregard them in this chapter.¹

13.2 *When*-clauses as situation-time adverbials or as orientation-time adverbials

The *when*-clause can specify either the situation time of the head clause or an orientation time which binds the situation time of the head clause in terms of T-anteriority or T-posteriority. In other words, the *when*-clause can be used either as a situation-time

1. For a full treatment of narrative *when*-clauses, see Declerck (1997: 212–229).

adverbial or as an orientation-time adverbial. In both cases the time specified (contained) by the Adv-time will be called the ‘contained orientation time’.

13.2.1 It was noted in 2.24–5 that a time-specifying adverbial can function either as a ‘**SITUATION-TIME ADVERBIAL**’ or as an ‘**ORIENTATION-TIME ADVERBIAL**’. In the former case the Adv-time ‘contains’ (in terms of inclusion or coincidence) the situation time of the clause involving the time-specifying adverbial, as in *John left yesterday* or *John left at five*. We speak of an ‘orientation-time adverbial’ when the orientation time which the Adv-time contains is not the situation time but another orientation time in the tense structure of the clause, as in *At five o’clock John had already left the office*. (In this example the Adv-time contains the orientation time to which the situation time is T-anterior).² The relation ‘Adv-time contains situation time’ can be represented in the ways shown in Figure 13.1. The temporal structure of *At five o’clock John had already left the office*, in which the ‘contained orientation time’ (see 13.2.2) is not a situation time, can be represented as in Figure 13.2.

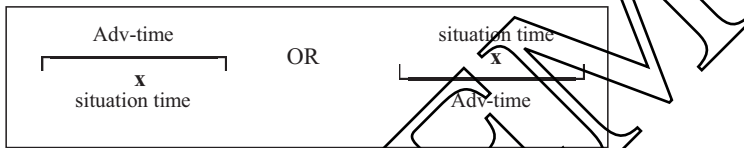

Figure 13.1. Representations of ‘Adv-time contains situation time’.

The conventions used in these figures and in the others that will be given below are as follows. An orientation time is represented by an *x*, irrespective of whether it is a situation time or not, and regardless of whether it is punctual or durative. The Adv-time is represented as in Figure 13.1, again irrespective of whether it is punctual or durative. This means that the representations in Figure 13.1 in fact cover four possibilities: (a) durative Adv-time including punctual situation time (e.g. *John left yesterday*); (b) durative Adv-time including durative situation time (e.g. *I wrote that letter yesterday*); (c) durative Adv-time coinciding with durative situation time (e.g. *Yesterday I was in London*

2. In some cases the Adv-time contains both the orientation time to which the situation time of the head clause is related and the situation time of the head clause itself. This is true, for example, of the Adv-time established by *yesterday* in *Yesterday John had already left the office at four o’clock*. For the sake of simplicity, such ‘multiple-orientation-time adverbials’ (see 2.26) will be disregarded here.

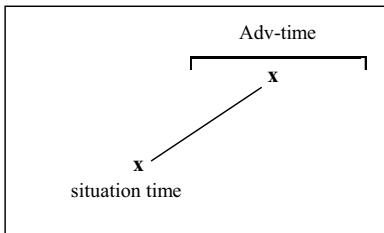

Figure 13.2. The temporal structure of *At five o'clock John had already left the office.*

all day); and (d) punctual Adv-time coinciding with punctual situation time. (e. g. *John left at five*).

13.2.2 For ease of reference we will call the orientation time that is specified by an Adv-time the ‘**CONTAINED ORIENTATION TIME**’. As explained in the previous section, the contained orientation time in the tense structure of the head clause is the situation time (of the head clause) if the *when*-clause is used as a situation-time adverbial and is another orientation time (binding the situation time of the head clause) if the *when*-clause functions as an orientation-time adverbial.

13.2.3 The following is an overview of some terms and meanings:

Adv-time: time specified by an adverbial

Contained orientation time: orientation time contained in the Adv-time, in terms of inclusion or coincidence

Situation-time adverbial: adverbial specifying an Adv-time whose contained orientation time is a situation time

Orientation-time adverbial: adverbial specifying an Adv-time whose contained orientation time is not a situation time but another (in this case ‘implicit’ – see 2.14) orientation time which binds a situation time

II. The temporal structure of adverbial *when*-clauses

13.3 *When*-clauses and temporal structure

The temporal structure expressed by *when* is that of a ‘common Adv-time’ containing both an orientation time from the tense structure of the head clause (the ‘contained orientation time of the head clause’) and an orientation time from the tense structure of the *when*-clause (the ‘contained orientation time of the *when*-clause’). This temporal structure, which is the semantics of *when*, can therefore be paraphrased as ‘at a/the time at which’.

13.3.1 Adverbial *when*-clauses differ from nonclausal time-specifying adverbials like *yesterday* or *some time earlier* in that they do not name an Adv-time directly but relate two orientation times (viz. the situation time of the *when*-clause and the contained orientation time) to each other. However, in doing so adverbial *when*-clauses do establish an Adv-time, and they therefore function either as situation-time adverbials or as orientation-time adverbials:

I left when John arrived. (*when*-clause as situation-time adverbial: the contained orientation time of the head clause is the situation time of the head clause)

When John arrived, I had already left. (*when*-clause as orientation-time adverbial: the situation time of the head clause is T-anterior to the contained orientation time)

I had left when John arrived. (*The sentence is ambiguous because the when-clause may be either an orientation-time adverbial – yielding the reading ‘When John arrived I had already left’ – and a situation-time adverbial – as in I was no longer there at four because I had left at the same time as John arrived, which was at three.*)

The temporal structure of such sentences is determined both by the tense forms and by the semantics of *when*. As we have seen, *when* can be paraphrased ‘at a/the time at which’. This follows from the fact that, although *when* is usually treated as a temporal conjunction, it is really a free (headless) relative adverb (see 13.1.2). In the same way as *what* in *I know what I like* means ‘that which’, *when* is semantically equivalent to ‘then when’ (with *then* as a cataphoric pronominal adverb depending for its interpretation on the modifying *when*-clause). It follows that a sentence like (1a) receives the same interpretation as (1b):

(1a) John left when Bill arrived.

(1b) John left at the time when Bill arrived.

The temporal structure of (1b) is fairly transparent. *At the time when Bill arrived* establishes an Adv-time which contains the situation time of the head clause (= the time of John's leaving). In the relative clause *when Bill arrived*, the relative *when* is a relative adverb and therefore also establishes an Adv-time, which 'contains' an orientation time from the tense structure of the relative clause. In this example, the contained orientation time of the *when*-clause is an implicit orientation time to which the situation time of the relative clause is T-simultaneous. This means that there are two Adv-times in the sentence: '[at the time] when Bill arrived' functions as Adv-time in the head clause, and *when* functions as Adv-time in the relative clause. Since one of the functions of a relative is to express coreferentiality between the antecedent and the *wh*-constituent of the relative clause, *when* identifies the two Adv-times with one another. Because (1a) [*John left when Bill arrived*] differs from (1b) only in that the antecedent is not overtly expressed but incorporated into the free (headless) relative, *when* has exactly the same function in (1a) as it has in (1b): it identifies the Adv-time of the head clause with the Adv-time of the *when*-clause. The result is that the meaning of (1a) can be paraphrased as follows: 'There is a time in the past at which Bill arrived, and that time is the time at which John left'.

Quite similar remarks can be made in connection with (2a), which is interpreted in the same way as (2b):

- (2a) John left when Bill had already arrived.
 (2b) John left at a time when Bill had (already) arrived.

(As shown in Figure 13.3 below,) in (2b), *at a time when Bill had already arrived* establishes an Adv-time which contains the situation time of the head clause (= the time of John's leaving). Let us call this situation time, which is the orientation time that is contained by the Adv-time established by the *when*-clause, 'orientation time_i'. In the relative clause *when Bill had already arrived*, the relative *when* is a relative adverb establishing an Adv-time, which contains an orientation time from the tense structure of the relative clause. In this example, the contained orientation time is an orientation time to which the situation time of the relative clause is T-anterior. Let us refer to this implicit contained orientation time as 'orientation time_{ii}'. There are, then, two Adv-times in (2b). First, '[at the time] when Bill had (already) arrived' functions as Adv-time in the head clause. Let us call this Adv-time₁. Second, *when* functions as Adv-time in the relative clause. Let us call this Adv-time₂. Because *when* is a headless relative and a relative expresses coreferentiality between the antecedent and the *wh*-constituent of the relative clause, *when* identifies the two Adv-times with one another. Since (2a) differs from (2b) only in that the antecedent is not overtly expressed but contained in the free relative, *when* has exactly the same function in (2b): it identifies the Adv-time₁ of the head clause with the

Adv-time₂ of the *when*-clause. The result is that the meaning of (2a) [*John left when Bill had already arrived*] can be paraphrased as follows: ‘There is a time in the past at which Bill had already arrived, and that time is the time at which John left’.

13.3.2 The above analysis implies that the following relations form part of the semantic structure of (2a–b):

- Adv-time₁ contains orientation time_i (= the situation time of the head clause)
- Adv-time₂ contains orientation time_{ii}
- The situation time of the *when*-clause is anterior to orientation time_{ii}
- Adv-time₁ = Adv-time₂

This can be represented as in Figure 13.3, in which the two parallel vertical lines represent the = sign. This figure can be further simplified to the representation given in Figure 13.4 (in which the symbols representing the containment relation of the Adv-times are fused into one more complex symbol):

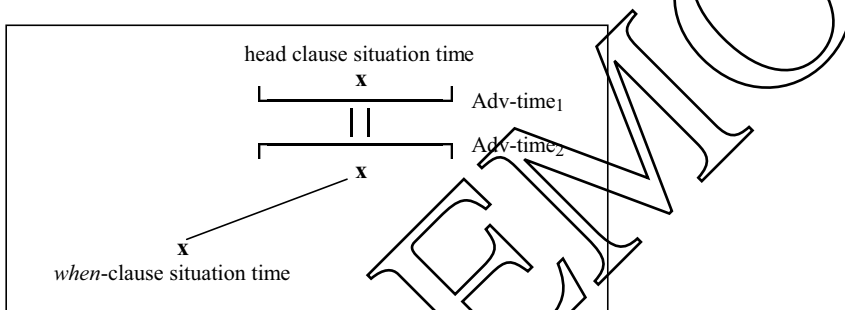

Figure 13.3. The temporal structure of *John left when Bill had already arrived*: representation 1.

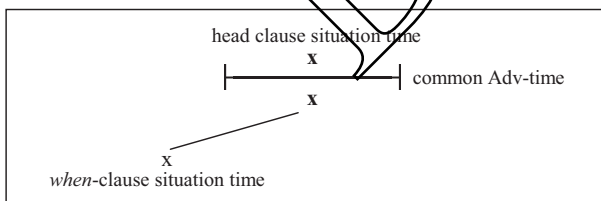

Figure 13.4. The temporal structure of *John left when Bill had already arrived*: representation 2.

13.3.3 For ease of reference, a further couple of terms will be introduced. We will speak of the ‘ADV-TIME OF THE HEAD CLAUSE’ and the ‘ADV-TIME OF THE

WHEN-CLAUSE. As we will see in 13.11, the interval of time referred to as ‘Adv-time of the head clause’ will normally be interpreted as the same interval as that referred to as ‘Adv-time of the *when*-clause’. When concentrating on the fact that these two Adv-times are identical, we will use the term ‘**COMMON ADV-TIME**’ to refer to either of them. In (2b), the common Adv-time is the time interval lexicalized by the antecedent (*a time*) of the relative clause. In (2a), the common Adv-time remains implicit, i. e. there is no NP naming the interval in question.

As noted in 2.23.1, the orientation time which is specified (i. e. contained) by an Adv-time will be called the ‘**CONTAINED ORIENTATION TIME**’. This may be either the situation time or another (nonlexicalized) orientation time to which the situation time is temporally related. Thus, in (2a) the Adv-time of the head clause contains the situation time of the head clause, whereas the Adv-time of the *when*-clause contains an implicit orientation time to which the situation time of the *when*-clause is T-anterior. Using the terminology introduced in 13.2 above, we can say that in (2a) [*John left when Bill had already arrived*] the *when*-clause as a whole functions as a situation-time adverbial with respect to the head clause, whereas *when* (meaning ‘at which time’) functions as orientation-time adverbial in the *when*-clause itself: the sentence is interpreted as ‘John left at time *t*, at which time Bill had already left’.

In *John died when he was in Spain* it is the situation time of the head clause that is the ‘**CONTAINED ORIENTATION TIME OF THE HEAD CLAUSE**’, i. e. the orientation time from the structure of the tense in the head clause that is contained by the common Adv-time. In *John had already left when Bill arrived* it is the orientation time to which the situation time of the head clause is anterior that is the contained orientation time of the head clause. Similarly, the ‘**CONTAINED ORIENTATION TIME OF THE WHEN-CLAUSE**’ is either the situation time of the *when*-clause (as in *John left when Bill arrived*) or another orientation time to which the situation time of the *when*-clause is T-related (as in *John left when Bill had already arrived*).

13.3.4 In sum, the semantic structure of *when* is as represented by Figure 13.5. (Because the contained orientation time of the head clause and the contained orientation time of the *when*-clause may both in principle be either durative or punctual, and because an Adv-time may either include the contained orientation time or coincide with it, this representation covers all possibilities: all three elements (contained orientation time of the head clause, contained orientation time of the *when*-clause and common Adv-time) may in principle be durative or punctual, so that the common Adv-time may either include both contained orientation times or coincide with them or include the one and coincide with the other.)

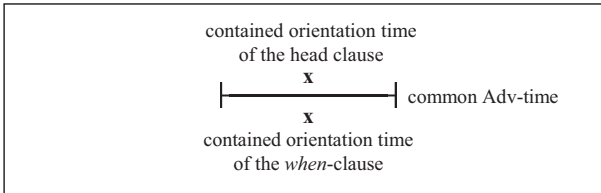

Figure 13.5. The semantic structure of *when*.

It should be clear that the above analysis accords perfectly with the fact that *when* is interpreted as ‘at a/the time at which’. It accounts for the presence of each constituent in this paraphrase: the first *at* expresses the containment relation between the Adv-time of the head clause and the contained orientation time of the head clause; the NP *the time* indicates the Adv-time of the head clause; the second *at* expresses the containment relation between the Adv-time of the *when*-clause and the contained orientation time of the *when*-clause; finally, the pronoun *which* indicates the Adv-time of the *when*-clause and, as a relative pronoun, identifies the Adv-time of the *when*-clause with the Adv-time of the head clause.

As will become clear when we discuss the temporal structures of *before* and *after* in chapter 14, there are no other temporal conjunctions whose temporal structure is anything like that represented by Figure 13.5. The reason is simply that *when* is not really a temporal conjunction at all, but is a headless relative. The temporal structure represented by Figure 13.5 can only be that of a headless relative. (This is clear from the original representation in Figure 13.3.)

13.3.5 The analysis also explains why adverbial *when*-clauses referring to the post-present use the present tense rather than the future tense:

John will leave when Bill ~~arrives~~ / *will arrive.

The temporal structure of this sentence is shown in Figure 13.6:

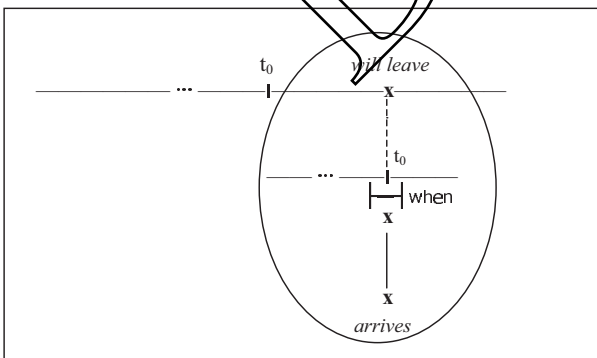

Figure 13.6. The tense structure of *John will leave when Bill arrives*.

As predicted by our theory (see 10.3), the head clause uses the future tense to establish a post-present domain, while the Adv-time-clause uses the present tense (as a form of the Pseudo- t_0 -System – see 10.2) to represent the situation time of the *when*-clause as T-simultaneous with the contained orientation time of the *when*-clause. In more detail:

- (a) The future tense form *will leave* locates the situation time of the head clause in the post-present.
- (b) Because it contains the situation time of the head clause, the common Adv-time – i. e. the element ‘time’ in the ‘at the time at which’ meaning of *when* – must also lie in the post-present.
- (c) Because the common Adv-time also contains the contained orientation time of the *when*-clause (i. e. the ‘at which [time]’ element in the meaning of *when*), the latter must also lie in the post-present.
- (d) The relation of coincidence between the situation time of the *when*-clause and the contained orientation time of the *when*-clause has to be expressed by the present tense (used as part of the Pseudo- t_0 -System). As noted in 10.2, the Pseudo- t_0 -System uses the present tense to represent a situation time as coinciding with a binding orientation time which is treated as a post-present ‘pseudo- t_0 ’. (The binding orientation time in question is the contained orientation time of the *when*-clause.)

13.3.6 The analysis presented here also explains why the use of a tense form expressing T-simultaneity in the *when*-clause does not automatically provoke an interpretation in which the situation time of the *when*-clause is taken to be simultaneous with the situation time of the head clause. Let us consider the sentence *John will leave when Bill arrives*, whose temporal structure contains the following relations:

- (a) There is a common Adv-time established by *when*. This contains both the contained orientation time of the head clause and the contained orientation time of the *when*-clause.
- (b) The contained orientation time of the head clause is the situation time of the head clause (*will leave*), which is punctual.
- (c) The contained orientation time of the *when*-clause is an implicit orientation time which binds the situation time of the *when*-clause in terms of T-simultaneity (coincidence).
- (d) Since the situation time of the *when*-clause is punctual and coincides with the contained orientation time of the *when*-clause, the latter is also punctual.
- (e) It follows that the two contained orientation times are punctual.

As we will see, if the two contained orientation times are punctual, the common Adv-time containing them is normally (i. e. by implicature) also conceived

of as punctual. The unmarked interpretation of *John will leave when Bill arrives* is therefore for the situation time of the head clause and the situation time of the *when*-clause to coincide. However, *John will leave when Bill arrives* will also turn out to be true if John's leaving takes place immediately after Bill's arrival. This follows from the fact that the implicature can be blocked or cancelled, in which case the common Adv-time may be durative even if the two situation times (and hence the two contained orientation times)³ are punctual. Strictly speaking, *John will leave when Bill arrives* expresses no more than that John's leaving and Bill's arrival will actualize within the common Adv-time: they need not actualize at exactly the same moment.

That the common Adv-time can be conceived of as durative follows from the absence of a temporal NP lexicalizing it: the length of the common Adv-time remains unspecified because there is no lexical item imposing boundaries on it. (When the Adv-time is lexicalized as *yesterday*, *last week*, *at five*, *in the afternoon*, etc., its boundaries are clear. But without lexicalization no boundaries are specified.) However, it will be pointed out below that there is an implicature saying that, failing an indication to the contrary, the common Adv-time should be conceived of as having the same length as the situation time of the *when*-clause. This explains why the unmarked interpretation of *John will leave when Bill arrives* is for the two situations to actualize simultaneously. If the situation time of the *when*-clause is punctual, the contained orientation time of the *when*-clause binding it in terms of T-simultaneity (coincidence) must also be punctual; if, moreover, the situation time of the head clause (which is the contained orientation time of the head clause contained in the common Adv-time) is also punctual, then the common Adv-time is by implicature also conceived of as punctual. It follows that in that case the situation time of the head clause is interpreted as coinciding with the situation time of the *when*-clause. However, there is also a marked interpretation, on which the common Adv-time is longer and the two situation times contained in it do not coincide. This reading can be triggered, for example, by a causal reading of the *when*-clause: if John will leave *because of* Bill's arrival, then he will leave *after* Bill's arrival (probably immediately after it).

13.3.7 The observation that the two situation times are not related to each other, except indirectly (i. e. both are contained in the common Adv-time, as in *John left when Bill left*, or are related to an implicit orientation time contained in the common Adv-time, as in *John left when Bill had already left*) thus accounts for the fact that *when*-clauses are sometimes interpreted in a way similar to conditional clauses that are interpreted in terms of 'SLOPPY W-

3. We use the word 'hence' because in the head clause it is the punctual situation time that functions as contained orientation time, whereas in the *when*-clause the punctual situation time is T-simultaneous (= coinciding) with the contained orientation time.

SIMULTANEITY' (see 9.20.4.), e.g. *You'll arrive at 8.35 if you take the 7.56 bus.* (*Take* is a form expressing T-simultaneity, but the two situations are not interpreted as W-simultaneous.) Consider examples like the following:

When John receives your letter, he will phone the police.

Here the *when*-clause uses a tense form expressing T-simultaneity in spite of the fact that the situation time of the *when*-clause is not really W-simultaneous with the situation time of the head clause. Of course, the fact that this is possible is not surprising once it is seen that the tense of the *when*-clause does not directly relate the situation time of the *when*-clause to the situation time of the head clause, but it probably does look special to those who are not aware of this because they are not aware of the fact that there are three covert constituents in the temporal structure of *when*, viz. the contained orientation time of the head clause, the contained orientation time of the *when*-clause and the common Adv-time containing both. The first two of these constituents are orientation times which are involved in the tense structure of the tense of the head clause and the *when*-clause, respectively. In sum, if (for convenience) we go on to use the term 'sloppy simultaneity' (which, in a sense, we can do because the situation time of the *when*-clause is not interpreted as T-simultaneous with the situation time of the head clause in spite of the fact that the *when*-clause uses a tense expressing T-simultaneity), then we have to be aware of the fact that the phenomenon has nothing to do with a special use of T-simultaneity tenses (as in the case of conditional clauses) but with the nonapplication of the implicature that the two orientation times contained in the common Adv-time should be interpreted as coinciding with each other. For this reason we will henceforth speak of **PSEUDO-SLOPPY SIMULTANEITY** where *when*-clauses are concerned.

The following examples further illustrate the possibility of *when*-clauses receiving a pseudo-sloppy simultaneity reading:

When John's car *crashes*, he will buy a new one.

When John *goes* on holiday he will give the key of his house to a neighbour.

The implicit common Adv-time here contains the situation time of the head clause and the implicit orientation time with which the situation time of the *when*-clause is T-simultaneous. For pragmatic reasons (viz. our knowledge of the actual world), these situations are not interpreted as W-simultaneous with each other. (Two times are W-simultaneous with each other if they have at least one point in common – see 8.18.) In the actual world, it is normal to buy a new car *after* the old one crashes but not *in the course* of its crashing.

As already noted, this analysis makes it clear that it is not the case that the tense form of the *when*-clause expresses sloppy simultaneity (as in the case of

open conditionals like *If John's car crashes, he will probably buy a new one*): the tense form of the *when*-clause expresses true T-simultaneity (= coincidence) between the situation time of the *when*-clause and the contained orientation time of the *when*-clause. In those cases where the common Adv-time includes the contained orientation time of the *when*-clause (which coincides with the situation time of the *when*-clause) and also includes the contained orientation time of the head clause (which is the situation time of the head clause if the *when*-clause is used as situation-time adverbial), the two contained orientation times may be located at different times within the common Adv-time. It follows that the situation time of the head clause does not need to be interpreted as actually coinciding with the situation time of the *when*-clause, in spite of the fact that the *when*-clause is used as a situation-time adverbial and uses a tense form expressing coincidence. Such a 'pseudo-sloppy simultaneity' reading is a marked reading, enforced by the context or by pragmatic considerations. The unmarked interpretation (if the *when*-clause is used as a situation-time adverbial and uses a tense form expressing T-simultaneity) is for the common Adv-time to coincide with the contained orientation time of the *when*-clause, and hence with the situation time of the *when*-clause (since the tense form of the *when*-clause represents the situation time of the *when*-clause as coinciding with the contained orientation time of the *when*-clause). Since the common Adv-time contains the situation time of the head clause, the latter is then automatically interpreted as W-simultaneous with (because contained in) the situation time of the *when*-clause. Out of context, *John left when Bill arrived* receives this unmarked interpretation. This is because the natural interpretation of 'at a time at which (time) Bill arrived, at that time John left' is that John's leaving occurred at the same time as Bill's arrival. However, the pseudo-sloppy simultaneity reading can be triggered by contextual or pragmatic considerations, for example, by the fact that it is common knowledge that John cannot stand Bill and always leaves the room immediately after Bill comes in.

13.3.8 Since the 'common Adv-time' is implicit, the speaker may in principle conceive it as having any length he likes. Still, it is clear that there must be pragmatic restrictions on the possibility of representing two non-simultaneous situations as falling within the same interval of time if the interval in question is not specified. In accordance with the Gricean Maxims, the hearer will interpret the interval as the shortest interval that is in keeping with the pragmatics of the sentence and its context. Thus, in the sentence *When John got up, he put on his best clothes*, the common Adv-time will be taken to be a subinterval of a particular morning (or day). It will not be interpreted as being, say, a particular week – an interpretation which would allow the possibility that the two situations actualized on different days. Moreover, an interpretation in terms of W-sequence (pseudo-sloppy simultaneity) will only be selected if the reading in which the situation time of the head clause is taken to be W-simulta-

neous with the situation time of the *when*-clause is ruled out, or rendered implausible, by the context or by pragmatic knowledge. As noted above, the unmarked interpretation is for the common Adv-time to coincide with the situation time of the *when*-clause, hence for the situation time of the head clause to be contained in the situation time of the *when*-clause.

13.3.9 A final piece of evidence in favour of the above analysis is that it offers a natural explanation of the fact that it sometimes seems irrelevant to the temporal interpretation which of the two situations is processed as head clause situation and which as *when*-clause situation. Compare:

Josephine Baker was 68 years old when she died.

Josephine Baker died when she was 68 years old.

Since in both cases both situation times are represented (directly or indirectly) as contained in a common Adv-time, there is no clear difference in temporal interpretation between these two sentences. Which of them will be used in a particular context will be determined by factors that have to do with the sentence's information structure (i. e. the distribution of given and new information) and communication structure (i. e. the choice of topic and comment), not by considerations that have to do with temporal interpretation.

13.4 Combining *when*-clauses with other time-specifying adverbials

13.4.1 If a clause contains several time adverbials, the various Adv-times are related in terms of containment. Thus, in *He left after lunch yesterday* the Adv-time established by *yesterday* includes the Adv-time established by *after lunch*, which itself functions as the Adv-time that contains the situation time. In sentences like this, one of the time adverbials may be a *when*-clause:

He left this morning when he had finished his homework.

The next day, when Hal returned from school, there was the bird in a wooden cage with bars in front. (LOB)

13.4.2 When the *when*-clause itself contains a time adverbial, the Adv-time established by the latter contains the Adv-time of the *when*-clause (expressed by *when*) in terms of inclusion or coincidence. (It follows that it also contains the contained orientation time of the head clause.)

He was merely 51 when he died in 1950. (*In 1950* establishes an Adv-time which includes 'the time when' he died.)

He seemed agitated when he left at 5.15 p.m. (*At 5.15 p.m.* establishes an Adv-time which coincides with 'the time when' he left.)

He was arrested when he tried to steal a car in 1931, but he had more success in 1933 when he tried again. (*This example shows that it is sometimes irrelevant whether the speaker uses a when-clause including a second time-specifying adverbial or a time-specifying adverbial accompanied by a when-clause as second time-specifying adverbial. In the latter case the situation time of the when-clause is contained in the first time-specifying adverbial rather than the other way round.*)

Because of this containment relation between the two Adv-times, it is not uncommon for the time adverbial to follow *when* immediately:

When, in late afternoon on the last day in June, he saw two people (...) walk toward the house, he quit work immediately and strode to his rifle. (BR)

When a *when*-clause combines with another time-specifying adverbial, the latter may itself be a *when*-clause:

[He maintains he cannot raise his arm.] When it was raised up quickly by a doctor when he wasn't expecting it, he let out such a scream that ... (LOB)

13.5 The relation between the situation time of the head clause and the Adv-time of the head clause

The *when*-clause can specify either the situation time of the head clause or an orientation time which binds the situation time of the head clause in terms of T-anteriority or T-posteriority. In other words, the *when*-clause can be used either as a situation-time adverbial or as an orientation-time adverbial. In both cases the *when*-clause uses a relative tense, which represents the situation time of the *when*-clause as T-anterior, T-simultaneous or T-posterior to the contained orientation time of the *when*-clause. This means that the situation time of the *when*-clause is never directly related to the situation time of the head clause: the situation time of the *when*-clause is T-related to the contained orientation time of the *when*-clause, which is contained by the common Adv-time. The function of *when* is to identify an orientation time in the tense structure of the head clause with an orientation time in the tense structure of the *when*-clause. (The two orientation times are identified with one another in the sense that both are contained in a common Adv-time.)

As we have seen, a *when*-clause does not relate the situation time of the *when*-clause directly to the situation time of the head clause. Rather, it relates the situation time of the *when*-clause to a contained orientation time of the *when*-clause, i. e. to an implicit orientation time that is contained by the 'common Adv-time' established by *when*. Since this common Adv-time also contains the

situation time of the head clause or an implicit orientation time binding the situation time of the head clause, the *when*-clause ultimately establishes an Adv-time for the head clause. We can therefore call it the ‘Adv-time of the head clause’. The Adv-time of the head clause may directly locate (specify) the time of the head clause situation, in which case the contained orientation time of the head clause is the situation time of the head clause, or it may locate another time which is part of the tense structure of the head-clause verb form. In that case the contained orientation time of the head clause is that other orientation time.⁴ In *John left when Bill arrived*, the Adv-time specifies the precise location of the situation time of the head clause in the past time-zone. In *John had left when Bill arrived*, the Adv-time specifies the precise location of the implicit contained orientation time of the head clause prior to which the situation time of the head clause is located. In other words, when a *when*-clause is used, the situation time of the head clause may be related to the Adv-time of the head clause in two different ways: either the situation time of the head clause is the orientation time that is located by the Adv-time (i. e. the contained orientation time of the head clause) or the situation time of the head clause is T-related to another orientation time functioning as contained orientation time of the head clause. In the former case the *when*-clause functions as a situation-time adverbial, in the latter as an orientation-time adverbial – see 2.24–25. In both cases the *when*-clause uses a relative tense, i. e. the tense T-relates the situation time of the *when*-clause to the contained orientation time of the *when*-clause. For example:

John left when he had finished his work. (= *John left at the time [at which time he had finished his work]*) (The *when*-clause is used as a situation-time adverbial; *had finished* represents the situation time of the *when*-clause as T-anterior to the contained orientation time of the *when*-clause – see Figure 13.4 in 13.3.2.)

John left when I was in the kitchen. (The *when*-clause is used as a situation-time adverbial; *was* represents the situation time of the *when*-clause as T-simultaneous with the contained orientation time of the *when*-clause – see Figure 13.7.)

[I lucked out in that] they had just come available when I was going to order them. (www) (The *when*-clause is used as a situation-time adverbial; *had come* represents the situation time of the head clause as T-anterior to the contained orientation time of the head clause; *was going to order* represents the situation time of the *when*-clause as T-posterior to the contained orientation time of the *when*-clause – see Figure 13.8.)

When I arrived, John was just going to leave. (The *when*-clause is used as an orientation-time adverbial; *arrived*, which is a relative preterite, represents the situation time of the *when*-clause as T-simultaneous with the contained orientation time of

4. In what follows we will disregard the possibility that the *when*-clause is a ‘multiple-orientation-time adverbial’ (see 2.26).

the *when*-clause; *was going to leave* represents the situation time of the head clause as T-posterior to the contained orientation time of the head clause – see Figure 13.9.)

The first of these sentences has the temporal structure represented by Figure 13.4. The other three have the temporal structures shown in Figures 13.7–9, respectively.

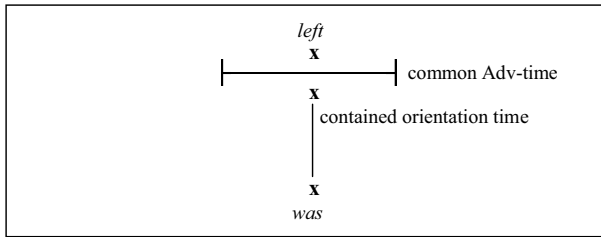

Figure 13.7. The temporal structure of *John left when I was in the kitchen.*

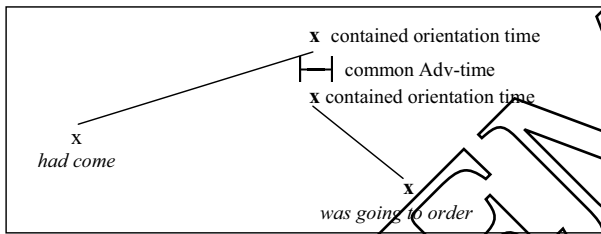

Figure 13.8. The temporal structure of *They had just come available when I was going to order them.*

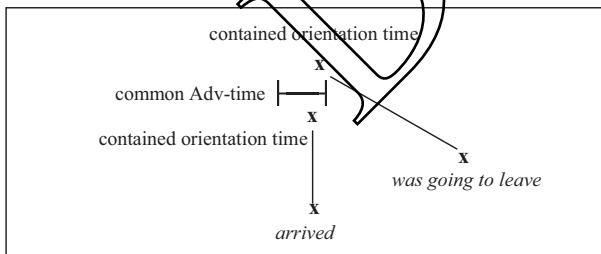

Figure 13.9. The temporal structure of *When I arrived, John was just going to leave.*

As is clear from these diagrams, the situation time of the *when*-clause is never directly related to the situation time of the head clause: the situation time of the *when*-clause is T-related to the contained orientation time of the *when*-

clause, which is contained by the common Adv-time.⁵ This leads to the conclusion that the tense form in an adverbial *when*-clause is always a relative tense form, and that the function of *when* is to identify an orientation time in the tense structure of the head clause with an orientation time in the tense structure of the *when*-clause. (The two orientation times are identified with one another in the sense that they are both contained in a common Adv-time.)

13.6 The definition of ‘simultaneity’ and ‘situation time’

T-simultaneity, as it is used here (and elsewhere in the book), is defined in terms of strict coincidence, not overlap – see also 2.17. This definition is possible because we distinguish between the situation time and the ‘time of the full situation’. The situation time is the time of the ‘predicated situation’, i. e. the time of that part of the full situation (possibly all of it) about which a statement is made – see 2.12–13. In *An hour ago John was in the kitchen*, the situation time is that portion of the time of the full situation that coincides with the time indicated by *an hour ago*. It is only this part that is referred to in the sentence and that is located in time by the tense form. The time of the full situation may be much longer – John may even still be in the kitchen at t_0 – but that is irrelevant to the definition of ‘situation time’.

It is also worth noting that this definition of ‘situation time’ is also compatible with the claim that an Adv-time always contains a contained orientation time, in terms of either inclusion or coincidence, hence that the contained orientation time in question cannot be longer than the Adv-time. In *John will still be in bed when I leave*, the *when*-clause situation is interpreted as punctual. That punctual situation time is represented as T-simultaneous (= coinciding) with the implicit contained orientation time of the *when*-clause. This means that the Adv-time of the *when*-clause (and hence the common Adv-time) are (by implicature) also interpreted as punctual. Since the contained orientation time of the head clause is contained in this punctual common Adv-time, it is also conceived of as punctual. Because in this example [*John will still be in bed when I leave*] the contained orientation time of the head clause is the situation time of the head clause (i. e. the *when*-clause functions as a situation-time adverbial), the situation time of the head clause is also conceived of as punctual. In sum, in *John will still be in bed when I leave*, the situation time of the head clause is not the time of the full situation but just that portion (point) of it that coincides with the situation time of the *when*-clause, which is punctual and is therefore also the time of the ‘full situation’ of the *when*-clause.

5. This is the rule when the situation time of the *when*-clause is bound directly. Apart from this, *when*-clauses sometimes also allow indirect binding (see 13.9–10). In that case too, the situation time of the *when*-clause is not directly related to the situation time of the head clause.

III. Configurations of temporal relations

13.7 Possible combinations of tenses in head clause and *when*-clause

Since an adverbial *when*-clause represents the situation time of the *when*-clause as T-anterior, T-simultaneous or T-posterior to the contained orientation time of the *when*-clause, and since an adverbial *when*-clause can be used either as situation-time adverbial or as orientation-time adverbial, there are nine unmarked configurations of temporal relations, realizing nine different temporal structures involving the common Ad-time expressed by *when*. These nine configurations, which have in common that the situation time of the *when*-clause is bound by the contained orientation time of the *when*-clause, can be considered as forming the set of unmarked options as far as tense choice is concerned. As the examples will show, all nine of them are compatible with reference to the past as well as with reference to the post-present.

Since the situation time of the *when*-clause may be related to the contained orientation time of the *when*-clause in terms of T-simultaneity, T-anteriority or T-posteriority, and since the *when*-clause can be used either as a situation-time adverbial or as an orientation-time adverbial, there are at least nine possible combinations of tense forms in the head clause and the *when*-clause. (Next to these, there are also configurations in which the situation time of the *when*-clause is bound indirectly – see 13.9–10. These will be disregarded in the present section.)

13.7.1 *Configuration 1*: the situation time of the head clause is the contained orientation time of the head clause, while the situation time of the *when*-clause is represented as T-simultaneous with the contained orientation time of the *when*-clause (see Figure 13.7):

- (3) When I arrived, Bill was still in his study.
- (4) The shops will probably still be closed when we arrive.

It should be noted that the analysis offered here involves the claim that the form *arrived* in (3) is a relative past tense form (representing the situation time of the *when*-clause as T-simultaneous with the contained orientation time of the *when*-clause) and not an absolute preterite (relating the situation time of the *when*-clause directly to t_0). In other words, (3) realizes the same kind of temporal structure as (4). As there is no doubt that in (4) *arrive* does not locate the arrival at t_0 but expresses T-simultaneity (coincidence) in the post-present domain established by *will be closed*, we can assume that in (4) *arrived* is

also a relative tense form. (Note, however, that this assumption has no drastic consequences: since T-simultaneity is defined in terms of coincidence, it is irrelevant to the interpretation of the *when*-clause whether the situation time of the *when*-clause is analysed as related to the contained orientation time of the *when*-clause in terms of T-simultaneity or as being the contained orientation time of the *when*-clause itself.)

13.7.2 *Configuration 2*: the situation time of the head clause is the contained orientation time of the head clause, while the situation time of the *when*-clause is represented as T-anterior to the contained orientation time of the *when*-clause (see Figure 13.4 in section 13.3.2). For example:

When John had finished eating I was still doing the washing-up.

When John has finished eating I will still be doing the washing-up.

13.7.3 *Configuration 3*: the situation time of the head clause is the contained orientation time of the head clause, while the situation time of the *when*-clause is represented as T-posterior to the contained orientation time of the *when*-clause. For example:

When Hamlet was going to kill Claudius the first time, he stopped himself, [because Claudius was in confession]. (www)

[I believe that] when there is going to be another attack, we will not get a warning. (www)

Note that *is going to be* in the second example is not an absolute tense form but a form from the Pseudo- t_0 -system. It represents the situation time of the *when*-clause as T-posterior to the contained orientation time of the *when*-clause and not as T-posterior to t_0 .

13.7.4 *Configuration 4*: the situation time of the head clause is represented as T-anterior to the contained orientation time of the head clause, while the situation time of the *when*-clause is represented as T-simultaneous with the contained orientation time of the *when*-clause. For example:

When I arrived, Bill had just left.

When we arrive, the gates will probably just have been closed.

13.7.5 *Configuration 5*: the situation time of the head clause is represented as T-posterior to the contained orientation time of the head clause, while the situation time of the *when*-clause is represented as T-simultaneous with the contained orientation time of the *when*-clause (see Figure 13.9 in section 13.5). For example:

[I knew that] when somebody left a message in my voice mail inbox, I was going to be informed about that by SMS. (adapted from www)

When we reach the shop, they will already be going to put up the shutters.

13.7.6 *Configuration 6*: the situation time of the head clause is represented as T-anterior to the contained orientation time of the head clause, while the situation time of the *when*-clause is represented as T-anterior to the contained orientation time of the *when*-clause. For example:

When John had finished eating, I had almost finished doing the washing-up.

When John has finished eating, I will almost have finished doing the washing-up.

13.7.7 *Configuration 7*: the situation time of the head clause is represented as T-posterior to the contained orientation time of the head clause, while the situation time of the *when*-clause is represented as T-anterior to the contained orientation time of the *when*-clause. For example:

When John had finished eating, he was going to clear the table [but his wife said he didn't have to].

When John has finished working in the garden, it will no doubt be going to rain. (= 'I expect that at the time that John has finished working in the garden it will look as if it is going to rain.')

13.7.8 *Configuration 8*: the situation time of the head clause is represented as T-anterior to the contained orientation time of the head clause, while the situation time of the *when*-clause is represented as T-posterior to the contained orientation time of the *when*-clause (cf. Figure 13.8 in section 13.5). For example:

[I lucked out in that] they had just come available when I was going to order them. (www)

?When the police were going to intervene, I had already deemed it wise to leave the pub. (= 'There was a time when the police were going to intervene. At that time I had already deemed it safe to leave the pub.')

When the police are finally going to question John, he will have disappeared.

13.7.9 *Configuration 9*: the situation time of the head clause is represented as T-posterior to the contained orientation time of the head clause, while the situation time of the *when*-clause is represented as T-posterior to the contained orientation time of the *when*-clause. For example:

?When the police were going to intervene, the rioters were clearly going to use violence. [In the end, however, both parties refrained from using violence.]

?When he is going to commit suicide, he will also be going to kill his wife and children.

13.8 Further remarks on the configurations

13.8.1 Although all of the above nine configurations are grammatically correct, some of them (especially those involving T-posteriority) may sound rather awkward. This is because we tend to use simpler structures wherever possible

and because, when the situation time of the head clause is T-anterior to the contained orientation time of the head clause, it is often more natural to use *by the time that* than to use *when*. Another thing worth noting is that in configurations 1–3, the *when*-clause is used as a situation-time adverbial. In configurations 4–9, it is used as an orientation-time adverbial.⁶

13.8.2 In the above examples, a form involving *be going to* is used in the *when*-clause whenever the situation time of the *when*-clause is to be represented as T-posterior to the contained orientation time of the *when*-clause (viz. in configurations 3, 8 and 9). The reason for this is that we cannot normally use *will* or *would* to represent this T-posteriority relation. We must use a form of *be going to*, or of a similar ‘futurish form’ (see 7.3) like *be about to*, *be on the point of*, etc. The same restriction applies to the head clause if the situation time of the head clause is to be represented as T-posterior to the contained orientation time of the head clause (viz. in configurations 5, 7 and 9). This means that it is a general rule that a tense form expressing T-posteriority in one of the above nine configurations must involve an auxiliary with ‘prospective’ (Jespersen 1932: 361–2) meaning, i. e. an auxiliary which is not so much used to make a prediction as to represent a future situation as anticipated, i. e. as having its roots in the present (see 7.3.2).⁷ The reason for this restriction is that in the relevant configurations it is not the situation time of the clause expressing T-posteriority (i. e. the situation time represented as T-posterior) that is the ‘contained orientation time’ contained in the common Adv-time but rather the time to which the situation time is represented as T-posterior, i. e. the time when the posterior situation is anticipated. This means that the posteriority is always of the prospective type. When a form with prospective meaning is used, an Adv-time can include the time of anticipation rather than the anticipated situation time. The same is not normally possible when *will* or *would* is used. Compare:

[I told her I would be in Hamburg in the first week of May and] she told me she {would / was going to} be in Prague then.

She often felt sick because she {was then going to have / *would then have} a baby.

-
6. The latter six configurations could be adapted in such a way that the common Adv-time contains not only the contained orientation time of the head clause to which the situation time of the head clause is T-related but also the situation time of the head clause itself. In that case the *when*-clause would be used as ‘multiple-orientation-time adverbial’ (see 2.26). This possibility need not be explicitly treated here because the use of tenses in the six resulting configurations is the same as in configurations 4–9.
7. Because of its prospective meaning, *be going to* differs from *will* in that it presupposes that all the necessary conditions for the actualization of the future situation are satisfied (see 7.12.1).

In the first example, *then* specifies the situation time of the T-posterior situation; this is possible irrespective of whether the verb form has prospective meaning or not. In the second example, by contrast, *then* specifies (contains) the orientation time to which the situation time is T-posterior. This configuration requires a prospective verb form. Since a *when*-clause specifies an Adv-time in the same way as *then* does, the same is true in configurations with a *when*-clause when the contained orientation time of the *when*-clause is the orientation time to which the relevant situation time is T-posterior.

13.8.3 There is a similar restriction on the tense forms expressing T-anteriority. In those configurations in which the situation time of the *when*-clause is represented as T-anterior to the contained orientation time of the *when*-clause, the *when*-clause has to use a perfect tense form. This requirement is not immediately clear when we consider sentences referring to the past (since the past perfect is the one tense to be used to express T-anteriority to a past orientation time), but it becomes evident when the head clause refers to the post-present:

If we do it this way, the police will never find out that it *{was done / has been done}*.

John will arrive when the others *{have left / *left}*.

Whereas in the first example both the past tense and the present perfect can be used to represent the situation time of the *that*-clause as T-anterior to the situation time of the head clause, only the present perfect can be used in the *when*-clause of the second sentence. The reason is that if the *when*-clause expresses T-anteriority, the time indicated by *at which* in the paraphrase *at the time at which* is not the time of the *when*-clause situation itself (i. e. the situation time of the *when*-clause) but a time when it is the case that the *when*-clause situation has already actualized. In order to express this idea of ‘time at which the *when*-clause situation has actualized’ we obviously need a perfect tense form.

IV. Direct and indirect binding in *when*-clauses

13.9 Definitions of direct and indirect binding in *when*-clauses

As far as adverbial *when*-clauses are concerned, direct binding (i. e. the unmarked way for the situation time of the *when*-clause to be bound) means that the situation time of the *when*-clause is bound by the contained orientation time of the *when*-clause. Any other form of binding is an instance of indirect binding.

As noted in 9.28.1, the situation time of a subclause is bound ‘directly’ if it is bound by the situation time of its head clause, and is bound ‘indirectly’ if it is bound by an orientation time represented in a clause higher than the head clause. The following sentences illustrate the two possibilities.

He promised he *would sign* any papers that *were put* before him.

He promised he *would speak* to Tom, who *would no doubt be able* to help me.

In the first example, both *would sign* and *were put* effect **DIRECT BINDING**: in both cases the relevant situation time is bound by the situation time of its own head clause. In the second example, *would speak* is also bound directly, but *would be able* is an instance of **INDIRECT BINDING**: the binding orientation time is not the situation time of the head clause (*he would speak to Tom*) but rather the situation time of the matrix clause (*he promised*).

In the case of adverbial *when*-clauses, direct binding has to be defined slightly differently, since in the nine configurations referred to in 13.7 the situation time of the *when*-clause is never directly T-related to the situation time of the head clause but is always bound by the contained orientation time of the *when*-clause. As far as adverbial *when*-clauses are concerned, direct binding (i. e. the unmarked way for the situation time of the *when*-clause to be bound) means that the situation time of the *when*-clause is bound by the contained orientation time of the *when*-clause. Any other form of binding is an instance of indirect binding.

13.10 The use of indirect binding in *when*-clauses

Only *when*-clauses in the past perfect can effect indirect binding. They can do so under strict conditions only.

13.10.1 Because indirect binding represents the marked option, it is subject to severe restrictions. In fact, there is only one form of indirect binding that is quite common in *when*-clauses, viz. that illustrated by examples like the following:

The house had been like this when he and Jean *had* first *come* here. (NMDT 68)

[He said] he had bought it when he *had been going to get* that salary increase [which in fact he never got].

When he *had turned* 18 he had already outsmarted almost every commander in the war games [and was still undefeated on the Balance Log in the training division]. (www)

When I *had turned* 13, I had already absorbed much of a foreign, American culture. (www)

In each of these examples, the *when*-clause situation is interpreted as W-simultaneous with the head clause situation. The unmarked way of expressing this reading would be by the use of a relative past tense form in the *when*-clause, i. e. by the realization of configuration 1 (in which the situation time of the *when*-clause is bound directly, more specifically, represented as T-simultaneous with the contained orientation time of the *when*-clause). The use of the past perfect in the *when*-clause means that the situation time of the *when*-clause is not bound by the contained orientation time of the *when*-clause but by the same past orientation time as also binds the situation time of the head clause. This form of indirect binding is represented by Figure 13.10. (Remember that the wavy line does not represent a T-relation but indicates the relation of W-simultaneity which is inferred in W-interpretation)

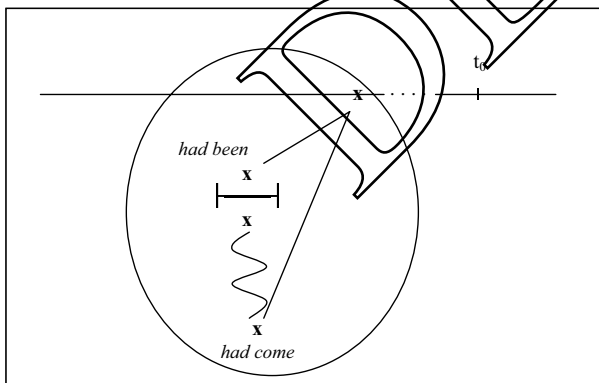

Figure 13.10. The temporal structure of *The house had been like this when he and Jean had first come here.*

A *when*-clause can only be bound indirectly (by the use of the past perfect) if it is used as a situation-time adverbial, i. e. if the *when*-clause specifies the time of the head clause situation itself, not another time to which the time of the head clause situation is T-anterior.

13.10.2 It is typical of examples like the ones given in the previous subsection that both the head clause and the *when*-clause use a past perfect (either a regular past perfect or a form involving *had been going to*). It might therefore seem as if the *when*-clause ‘copies’ the tense form of its head clause. However, the use of the past perfect in the head clause is not a sufficient condition for the use of the same tense in the *when*-clause. An additional condition is that the *when*-clause must be used as a situation-time adverbial. If the *when*-clause is used as an orientation-time adverbial, it cannot be bound indirectly. Compare:

The house had been dilapidated when he and Jean *had first seen* it.

He had already retired when he *{was / *had been}* sixty.

When I *{saw / *had seen}* you that day, we hadn’t met yet.

In all three examples the condition that the head clause must be in the past perfect is satisfied. However, it is only in the first example that the *when*-clause can be bound indirectly, because this is the only example in which the *when*-clause is used as a situation-time adverbial (i. e. the contained orientation time of the head clause is the situation time of the head clause). In the second and third examples, the *when*-clause is used as an orientation-time adverbial: as shown in Figure 13.11, the contained orientation time of the head clause is not the situation time of the head clause but a time to which the situation time of the head clause is T-anterior. Because of this, indirect binding is not allowed in these examples.

In sum, as a rule, the use of a past perfect in the head clause is not a sufficient condition for indirect binding (by means of the past perfect) in the *when*-clause. There is the additional condition that the *when*-clause must be used as a situation-time adverbial, i. e. that the *when*-clause specifies the time of the head clause situation itself, not another time to which the time of the head clause situation is T-anterior.⁸ This is clear when we compare Figure 13.10 with Figure 13.11, which represents the temporal structure realized by the *when*-clause and its head clause in *He had already retired when he was sixty*.

8. Still, the use of the past perfect in the *when*-clause would be unusual in sentences like the following, in which the verb of the *when*-clause is a pro-form: *Afterwards I was glad that I had left when I did*.

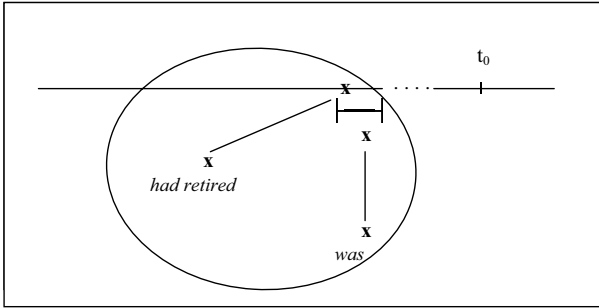

Figure 13.11. The temporal structure of *He says that he had already retired when he was sixty.*

13.10.3 This does not mean, however, that it is never possible for the two clauses to use the past perfect if the *when*-clause is used as an orientation-time adverbial. Consider the following:

[There was a little confusion as a friend asked me to buy a ticket for him. (oo), but] when I *had done so* he *had already reserved* a ticket for himself. (www)

In this example, the *when*-clause is used as an orientation-time adverbial (specifying a time prior to which the head clause situation has actualized). The situation time of the head clause is itself T-antecedent to the central orientation time of the past domain. (This is in keeping with the use of *already*.) Because the *when*-clause is not used as a situation-time adverbial, the *when*-clause situation is not interpreted as W-simultaneous with the head clause situation. This means that there is no indirect binding. The temporal structure of this example is shown in Figure 13.12.

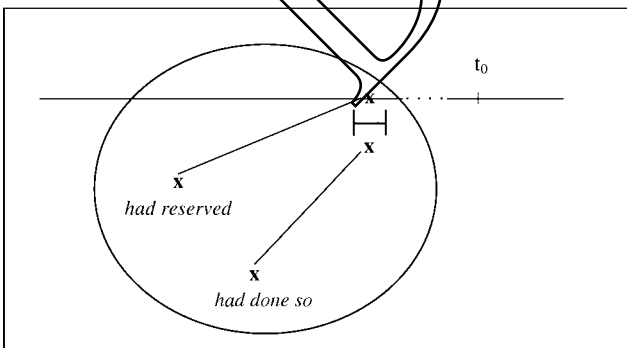

Figure 13.12. The temporal structure of *When I had done so he had already reserved a ticket for himself.*

This example, then, does not form an exception to the general rule that a *when*-clause can only be bound indirectly (by the use of the past perfect) if it is used as a situation-time adverbial. In this example the *when*-clause is used as an orientation time adverbial, and there is direct binding. The *when*-clause situation is interpreted (and represented) as anterior to the contained orientation time of the *when*-clause. This is unlike what happens in indirect binding, where the situation time of the *when*-clause is interpreted as W-simultaneous with the situation time of the head clause although it is not represented as T-simultaneous with it (because it is represented as T-anterior to the central orientation time of the domain).

13.10.4 In examples like the following, there seems to be ambiguity between indirect binding (as represented in Fig. 13.10) and direct binding (as represented in Fig. 13.12):

When he *had been* born, Mike *had* already *chosen* his name, [deciding to name him after his father, who had inspired him to become a policeman in the first place.] (www)

["Forgive me! And Adieu to you Master Rin," said John.] When John *had departed*, the sun *had* already *begun* its decline. (www)

13.10.5 If a *when*-clause uses the past perfect for indirect binding, the context has to make it clear that the situation time of the *when*-clause should be interpreted as W-simultaneous with the contained orientation time of the *when*-clause, and hence with the situation time of the head clause. The past perfect itself does not express this relation. If the form that effects indirect binding is built with *had been going to*, as in

He said he had bought it when he *had been going to get* that salary increase [which in fact he never got].

the situation time of the *when*-clause must be interpreted as posterior to the contained orientation time of the *when*-clause (see Fig. 13.13). This time the tense form does express this relation. The above sentence is an alternative to the following, which shows direct binding:

He said he had bought it when he *was going to get* that salary increase [which in fact he never got].

The difference between indirect binding (*had been going to*) and direct binding (*was going to*) here is that only in the former case does the tense form express a **COMPLEX T-RELATION** (see 9.7) which combines posteriority and anteriority. The binding time from which that T-relation starts is the situation time of *said*, which means that there is indirect binding.

13.10.6 An interesting observation is that when the *when*-clause is bound indirectly, the speaker sometimes deviates from the structure represented by

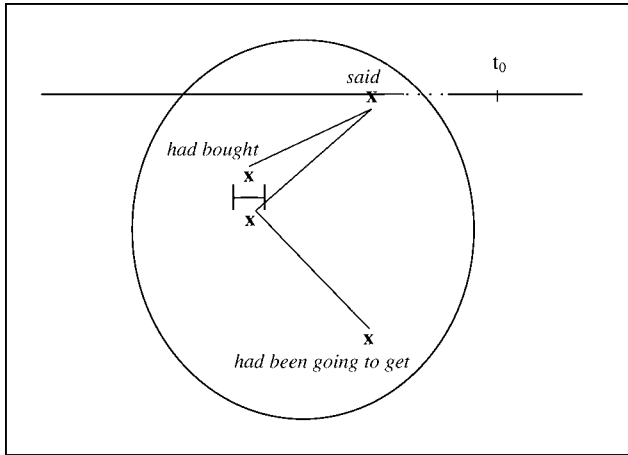

Figure 13.13. The temporal structure of *He said he had bought it when he had been going to get that salary increase.*

Figure 13.10 by using an absolute past tense form in the head clause instead of a past perfect. The following are some attested examples:

[Sheila (...) felt a cold shudder creeping along her spine.] She felt just as she *did* as a young girl when she *had* once *answered* the phone for her father. (LSW)

[From a locked drawer she took out a large German revolver. Basil had given it to her (...).] It *was* loaded when he *had brought* it to her [and was loaded now.] (FORG)

[But today she was genuinely concerned.] John *had been* sick twice during the night and *was lying* shivering and sweating when she *had called* him at 7.00 a.m. (LBW)

The same phenomenon can also be observed in restrictive relative clauses that form part of a time adverbial:

[Peter Moran looked, if not dirty, scruffy.] On each occasion Charles *had seen* him his hair *needed* a wash. (TSM)

It was on one of those evenings when Tim *had expressed* his envy of those who own their homes, that he *suggested* he too should buy a flat. (LOD) (*The context makes it clear that the suggestion was made during the discussion in which Tim expressed his envy and not after it, in other words, that the two situations were W-simultaneous.*)

What renders the use of an absolute past tense form in the head clause acceptable is the fact that for pragmatic reasons the situation time of the head clause can only be interpreted as W-simultaneous with the situation time of the *when*-clause. Since the tense form of the *when*-clause locates the situation time of the *when*-clause as T-anterior to a past orientation time, this means that the situation time of the head clause must also be interpreted as anterior to this

orientation time, irrespective of whether the tense form of the head clause expresses that anteriority (using a past perfect) or not (using an absolute past tense). In the latter case the use of the past tense in the head clause does not preclude indirect binding in the *when*-clause because the basic condition for indirect binding of the situation time of the *when*-clause is satisfied: the time adverbial functions as a situation-time adverbial, i. e. it locates (contains) the situation time of the head clause and not an orientation time binding the situation time of the head clause (see 2.24).

13.10.7 It should be noted, finally, that adverbial *when*-clauses normally allow indirect binding only if they use a tense form expressing T-anteriority. They do not allow indirect binding by means of the conditional tense or *was / were going to*:

He said he would help her when she {*was / *would be*} in trouble. (*Would be would relate the situation time of the when-clause to the situation time of the matrix (said), but that is not allowed in English. It is allowed, though, in cognate languages like Dutch and German.*)

He was going to resign when he {*was / *was going to be*} sixty.

The same is true if the posterior past subdomain is not established by a tense form expressing T-posteriority but by a context implying W-posteriority:

He promised to repair my bike when he {*came / *would come*} back from work.

However, in older English, indirect binding could be effected in *when*-clauses by means of the auxiliary *should*. Because the reference is to a posterior *when*-clause situation, i. e. to a situation whose actualization is still not factual at the time of the matrix situation, this *should* has a slight hypothetical connotation. Its use here therefore bears a certain similarity to its use in conditional clauses like *If someone should ask for me, tell them I'm away* (where the hypothetical meaning of *should* is much more pronounced). This does not alter the fact, though, that *should* effects indirect binding in the following examples.

Behind them they left a trail that *would break* Mr. Harrison's heart when he *should see* it. (AVON)

[But I never considered it as other than a transitory life. There was always a prophetic instinct, a low whisper in my ear, that] within no long period, and whenever a new change of custom *should be* essential to my good, change *would come*. (SCLRT)

[Hester (...) assured them, too, of her firm belief that,] at some brighter period, when the world *should have grown* ripe for it, in Heaven's own time, a new truth *would be revealed*, [in order to establish the whole relation between man and woman on a surer ground of mutual happiness.] (SCLRT)

V. Pseudo-sloppy simultaneity

13.11 Definition of pseudo-sloppy simultaneity

On a pseudo-sloppy simultaneity interpretation, the *when*-clause uses a tense which represents the situation time of the *when*-clause as simultaneous with the contained orientation time of the *when*-clause, but the situation time of the *when*-clause is actually interpreted as W-anterior or W-posterior to the situation time of the head clause. For example: *The business closed when the owner was murdered by robbers; When I leave the house I will turn on the burglar alarm.*

13.11.1 As noted in 13.3.6, when the tense form of a *when*-clause used as a situation-time adverbial expresses T-simultaneity, the situation time of the *when*-clause is normally interpreted as W-simultaneous with the situation time of the head clause because both situation times are ‘contained’ in the same common Adv-time. However, this W-simultaneity can be of the ‘PSEUDO-SLOPPY’ kind. As argued in 13.3.7, the possibility of a pseudo-sloppy simultaneity interpretation is due to the temporal structure of *when*, which is ‘The contained orientation time of the head clause is contained in a common Adv-time which also contains the contained orientation time of the *when*-clause’. This temporal structure does not require that the contained orientation time of the head clause should be W-simultaneous with the contained orientation time of the *when*-clause. All that is required is that the two should be conceived of as falling within the same interval (common Adv-time). When the *when*-clause is used as a situation-time adverbial and uses a tense form expressing T-simultaneity, the situation time of the *when*-clause coincides with the contained orientation time of the *when*-clause and the unmarked interpretation is for the common Adv-time also to coincide with the situation time of the *when*-clause. Since in that case the common Adv-time contains the situation time of the head clause, the situation time of the head clause is interpreted as W-simultaneous with (because contained in) the situation time of the *when*-clause. A pseudo-sloppy simultaneity interpretation is a deviation from this. It is a marked reading in which the common Adv-time does not coincide with the situation time of the *when*-clause but is a longer interval in which the contained orientation time of the head clause may be W-posterior or W-anterior to the contained orientation time of the *when*-clause.

13.11.2 On a pseudo-sloppy simultaneity interpretation, the *when*-clause uses a tense which represents the situation time of the *when*-clause as simultaneous with the contained orientation time of the *when*-clause, but the situation time

of the *when*-clause is actually interpreted as W-anterior or W-posterior to the situation time of the head clause:

The business closed when the owner *was murdered* by robbers. (WSJ)

When John *left* the house, he switched on the burglar alarm in the kitchen.

[‘I used to play rugger,’ said Armstrong.] ‘I missed it when I *gave it up*.’ (LOB)

Strictly speaking, it would seem to be more logical to use a verb form expressing T-anteriority or T-posteriority in such examples:

The business closed when the owner *had been murdered* by robbers.

When John *was going to leave* the house, he switched on the burglar alarm in the kitchen.

In most cases, however, the speaker will prefer to use the past tense, because T-simultaneity is the unmarked T-relation (see 3.5 and 8.34) and because the temporal relation between the situations is anyhow clear from the pragmatics of the sentence.⁹ The explicit use of a more complex tense form (i. e. the past perfect or a form expressing posteriority to a past orientation time) is usually unnecessary, unless the speaker wishes to emphasize the precise nature of the temporal relation (which is then asserted rather than merely inferred). Moreover, the use of *was going to leave* or *had left* adds an aspect of meaning. Whereas *was murdered* and *left* in the first pair of examples just represents their situations as past facts, *had been murdered* can also convey a resultative implicature, while *was going to leave* has ‘prospective’ meaning (see 10.7.2) and therefore actually fails to represent the situation as factual: in *When John was going to leave the house, he put on his boots*, the *when*-clause refers to the time when the *when*-clause situation was anticipated, but fails to represent the situation as actualizing. The past tense will therefore be preferred when the reference is to a situation that did actualize in the past.

13.12 Further remarks on pseudo-sloppy simultaneity

If the head clause situation is homogeneous, a pseudo-sloppy simultaneity interpretation comes down to a kind of inchoative reading of the head clause: *When the house burnt down, we lived at my mother’s until we found a new house.*

9. In some cases the sentence itself contains a word triggering a sequence interpretation:

- (i) When trading resumed yesterday, EBS shares *immediately* surged \$ 4. (WSJ)
- (ii) When First Interstate balked, (...) regulators *responded* by raising their recommendation to \$ 350 million. (WSJ)

If the head clause situation is interpreted as W-posterior to the *when*-clause situation (in spite of the *when*-clause using a T-simultaneity form), this posteriority relation can sometimes be expressed by the tense of the head clause: *When the war was over, few of the soldiers would return to find real peace.*

When-clauses that are interpreted in terms of pseudo-sloppy simultaneity often do not really specify an Adv-time but describe the occasion(s) on which the head clause situation actualizes: *When she received the letter, she answered it as soon as she could.* When the notion of ‘occasion(s)’ is stretched to that of ‘case(s)’, the *when*-clause becomes ‘case-specifying’ and hence ‘atemporal’: *Children are orphans when their parents are dead.*

13.12.1 If the head clause situation is a state or another type of ‘homogeneous’ (see 1.45) situation, a pseudo-sloppy simultaneity interpretation comes down to a kind of inchoative reading of the head clause.

When John broke his leg, he *used* the same crutches that his wife had used. (= ‘John used the same crutches as his wife had used, and he began doing so when / after he broke his leg.’)¹⁰

She *was* penniless when her firm went bankrupt. (= ‘At some time in the past she was penniless, and that situation came about when / after her firm went bankrupt.’)

These examples show that if the head clause situation is interpreted as following the *when*-clause situation, it may be nonbounded to the right as long as it is (interpreted as) bounded to the left. This stands to reason: a succession interpretation requires that one situation terminates before the other begins, i. e. that one situation (the one that is interpreted as actualizing first) is right-bounded whereas the other is left-bounded. Whether the situations are bounded or nonbounded at the other end is irrelevant.

13.12.2 If the head clause situation is interpreted as W-posterior to the *when*-clause situation (in spite of the *when*-clause using a T-simultaneity form), this posteriority relation can sometimes be expressed by the tense of the head clause. Consider:

- (5a) When the war was over, few of the soldiers *would return* to find real peace.
- (5b) When his third term came to an end, FDR *would be elected* a fourth time.
(www)

10. Note that this is the same kind of inchoative reading as we get in *At five o’clock John did his homework*, which means ‘John did his homework and started doing so at five’ rather than just ‘At five John started doing his homework’ (see 2.30.2).

In these examples, the head clause situation is not primarily represented as anticipated but rather as factual, i. e. as a situation that actualized in the past. This means that the situation is represented as ‘future in the past’ (rather than ‘future from the past’) by an omniscient narrator. This use of *would* is the same as that observed in sentences like the following, which are typical of a narrative style (see 9.6.7):

- (6a) [In trenches up to their knees in mud for weeks on end they endured unending barrages of bombs, shells and artillery fire in places like Ypres, Paschendale and the Somme.] Few *would return* to find real peace. (www)
- (6b) [People didn’t know at the time, but] FDR *would be elected* a fourth time. (Matthiessen 1983: 392)

The conditional tense form here represents its situation as factual, and could therefore be replaced with the past tense (albeit with loss of the posteriority sense). In (5a–b) too, the past tense could be used in the head clause. Another alternative to *would* is *was / were to*:

- (7) [At 24, Costello was sentenced to a year in prison for carrying a gun.] He *was not to return* to prison for the next 37 years. (www)

Examples like these are interesting because the head clause receives a factual interpretation in spite of the fact that the use of *would* or *was to* implies that the situation time of the head clause is not related to t_0 (by means of an absolute past tense) but is represented as T-posterior to some past orientation time. In (6)–(7), the binding orientation time is the situation time of the preceding clause. In (5a–b), which involve a *when*-clause, the situation time of the head clause is represented as T-posterior to the implicit contained orientation time of the head clause, which is interpreted as W-simultaneous with the implicit contained orientation time of the *when*-clause to which the situation time of the *when*-clause is represented as T-simultaneous. This means that the tense forms in these examples express configuration 5 (see 13.7.5), in which the situation time of the *when*-clause is T-simultaneous with the implicit contained orientation time of the *when*-clause and the situation time of the head clause is T-posterior to the implicit contained orientation time of the head clause. However, these examples differ from the illustrations of configuration 5 given in 13.7.5 in that the head clause uses *would* rather than *was going to*. As noted in 13.8.2, the head clause has to use *was going to* rather than *would* if it expresses what is anticipated at the time of the contained orientation time of the head clause (i. e. if the head clause has ‘prospective’ meaning). But it is clear from (5a–b) that the head clause has to use *would* (or *was to*) if the speaker wants to use a form expressing posteriority which is to be interpreted as having a factual rather than prospective meaning.

13.12.3 Another observation worth making is that *when*-clauses that are interpreted in terms of pseudo-sloppy simultaneity often do not really specify an

Adv-time but describe the occasion(s) on which the head clause situation actualizes:

He always switches off all the lights when he leaves his house.

When she received the letter, she answered it as soon as she could.

In such examples the ‘temporal’ *when*-clause describes the relevant occasion(s) rather than the precise time of the actualization of the head clause situation. The same thing is sometimes possible when the W-simultaneity relation which is taken to hold between the situation time of the head clause and the situation time of the *when*-clause is not of the ‘pseudo-sloppy’ kind:

He always votes Conservative when there is a general election.

In this country, when a man marries, the bride’s parents have to give him a dowry.

I got this as a present when I graduated.

That the primary function of the *when*-clauses is not to specify a time (Adv-time) not only answers our intuition but is also corroborated by the fact that in this case it is not irrelevant which situation is processed as head clause situation and which as *when*-clause situation. Compare:

- (a) Josephine Baker died when she was 68.
- (b) Josephine Baker was 68 when she died.
- (a) When she received the letter, she answered it as soon as she could.
- (b) *When she answered it as soon as she could, she received the letter.
- (a) He always votes Conservative when there is a general election.
- (b) When he (*always) votes Conservative, there is a general election.

As noted in 13.3.9, there is no clear difference in interpretation between the (a) and (b) sentences of the first pair, in which the *when*-clauses are purely time-specifying. However, there is a clear difference of interpretation between the (a) and (b) sentences of the second and third pairs. This is because the *when*-clause is now occasion-specifying rather than purely time-specifying.¹¹

13.12.4 When the notion of ‘occasion(s)’ is stretched to that of ‘case(s)’, the *when*-clause becomes ‘CASE-SPECIFYING’ and hence ‘ATEMPORAL’. Such *when*-

11. The same is true of **FOCALIZING WHEN-CLAUSES**, i. e. *when*-clauses which do not specify the time of the head clause situation (or a time to which the time of the head clause situation is related) but express the speaker’s focus on a time of evaluation or observation. In one subtype, the *when*-clause suggests the idea of a travelling observing consciousness (e. g. *When you travel to Washington, Boston, Chicago or New York, the same problems exist*), in another, the focalizing *when*-clause indicates the ‘epistemic time of evaluation’, i. e. the time when the conclusion is reached that the statement made in the head clause is true (e. g. *When you look at the economics, this company needs a Japanese and a European partner to make it work*).

clauses no longer refer to time at all but describe the case(s) in which the statement made in the head clause is true:

Children are orphans when their parents are dead.

When a man is tired of London, he is tired of life. (Samuel Johnson)

Atemporal *when*-clauses like these are sometimes called ‘**RESTRICTIVE WHEN-CLAUSES**’ because they restrict the cases in which the head-clause statement is true. In the above examples, the idea of a set of cases (to be restricted by the *when*-clause) results from the fact that the subject NP is used generically: a generic NP calls up the idea of an unspecified set, hence of a nonbounded number of entities (individuals). Since it is these entities that constitute the cases restricted by the *when*-clause, we can replace the *when*-clause by a restrictive relative clause without any apparent difference of meaning:

Children whose parents are dead are orphans.

A man who is tired of London is tired of life.

Here too, the generic subject NP calls up the idea of an indefinite (nonbounded) number of entities and hence of an indefinite number of cases (each entity being associated with one case). Whereas in the first pair of examples the atemporal *when*-clauses restrict the number of cases, and hence of entities, for which the head-clause statement is true, the relative clauses in the second pair of examples restrict the number of entities, and hence the number of cases, for which the head-clause statement is true. The result is that the *when*-clauses have much the same effect as the relative clauses.

13.12.5 Let us note, finally, that a pseudo-sloppy simultaneity reading of *when* requires that there should be some kind of logical relation (e.g. cause and effect) between the *when*-clause and the head clause. This explains why sentences like the following are odd:

?When my car broke down, there was a woman shot in Boston.

The restriction has to do with the Gricean Maxim of Relation (Relevance). The use of *when* (in configuration 1) means that the speaker locates the situation time of the *when*-clause and the situation time of the head clause within a common Adv-time. Obviously, the speaker must have some reason for doing this. In the unmarked case, the reason is that the two situation times are W-simultaneous. If this is not the case, the reason is that the speaker wants to express some kind of logical relation between the two situation times.

VI. The expression of irrealis or tentativeness in *when*-clauses

Under certain conditions, an adverbial *when*-clause can use the conditional perfect to represent its contents as ‘irrealis’, i. e. as counterfactual (unreal) or tentative.

13.13 Counterfactual *when*-clauses

In independent clauses it is possible to use the conditional perfect to refer to a **COUNTERFACTUAL** past situation, usually in a context referring to, or implying, an unfulfilled condition:

I would have welcomed more information on what they wanted us to do [if that had been possible].

This use of the conditional perfect is also possible in *when*-clauses:

Maddeningly, just when I *would have welcomed* full information on the books he was reading, he started to mention nothing beyond authors and titles, often in a shortened form. (GREEM)

["It is very kind of you to have asked me."] And then, when he *would have rung off*, she said, ["I suppose you have changed the flat a lot?"] (LOB)

[Ten years ago, the newspaper *El Espectador* (...) began warning of the rise of the drug mafias (...)] Then, when it *would have been* easier to resist them, nothing was done. (WSJ)

Sentences like these would appear to run counter to the widespread belief that *when*-clauses differ from *if*-clauses in that they are presupposed to be factual. The truth is that adverbial *when*-clauses presuppose actualization of the *when*-clause situation in some possible world, but not necessarily in the actual world. (The *when*-clause and the head clause must, however, always refer to the same possible world.) Sometimes the world in question involves situations which at some time or other are expected to actualize later. This is the case in sentences like the following:

John said he would commit suicide when a nuclear war broke out.

The speaker here refers to a world of expectation (existing in John's mind) in which the *when*-clause situation actualizes. He does not say anything about actualization of the *when*-clause situation in the real world. The first three examples differ from this in that instead of just voicing the subject's expectation, the speaker states explicitly (through the use of a counterfactual verb

form) that the anticipated *when*-clause situation did not actualize in the real world.

If the *when*-clause uses the conditional perfect, as in the first three examples, it refers to a counterfactual world. Like any other temporal *when*-clause, such a *when*-clause establishes an Adv-time, but the time indicated is now not a time of actualization but a time of nonactualization.

There is a similar use of the conditional tense, which can refer to the future and convey a counterfactual meaning, provided the verb is stative or progressive:

Make sure you don't pay for holidays that occur when an employee *would not otherwise be working*. (BR) (= '*... when an employee would not be working if he were not on holiday*')

13.14 Tentative *when*-clauses

Time-specifying *when*-clauses can also use a verb form which represents the actualization of the *when*-clause situation as 'TENTATIVE', i. e. as unlikely but not impossible. This is typically the case in *when*-clauses introduced by *whenever* and using *should*:

I have promised to stand in for him whenever his state of health *should render* it impossible for him to attend the monthly meeting of the Board.

This decided him to part with the boy, whenever he *should be found*. (GLME)

In examples like these, which sound rather archaic, the *when*-clause has a conditional connotation.

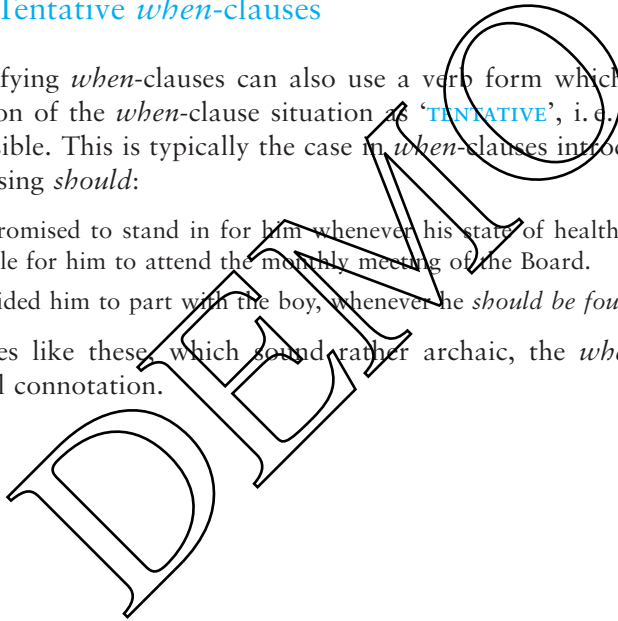

VII. Adverbial *when*-clauses using an absolute tense form

In the preceding sections we have discussed the nine configurations which can be considered as constituting the unmarked uses of relative tenses in *when*-clauses, as well as a couple of marked relative tense uses (viz. indirect binding and irrealis). In this section we will have a brief look at a number of marked cases in which the tense form of the *when*-clause is arguably an absolute tense form, i. e. a tense form which relates the situation time of the *when*-clause directly to t_0 .

13.15 The Special Present Time-sphere System

Situations that actualized in the past are normally described with the help of one of the past time-sphere tenses (viz. the past tense, the past perfect, the conditional tense or the conditional perfect). However, there are contexts in which the speaker conventionally uses the **SPECIAL PRESENT TIME-SPHERE SYSTEM** (see 3.2–9), i. e. the present tense, the present perfect, the future tense or the future perfect. It is typical of this use that the contained orientation time of the *when*-clause is represented as if it were t_0 . This means that the situation time of the *when*-clause is related to t_0 , hence that the *when*-clause uses an absolute tense. For example:

(summary) When they *arrive* at his house, John is already in bed.

(historic present) When Gordon *has shut* the door, Joan starts crying.

13.16 *When*-clauses in the future tense

13.16.1 If the head clause situation and the *when*-clause situation are to be interpreted as W-simultaneous post-present situations, the *when*-clause must as a rule use the present tense (as ‘Pseudo- t_0 -System’ (see 10.2.1) tense expressing T-simultaneity) rather than the absolute future tense. Still, in very formal or archaic texts, examples can be found in which the *when*-clause uses the future tense:

‘Thou shalt not kill.’ Except when it *shall come* to pass that thy trade-routes shall be endangered. (NICH)

13.16.2 Another exception to the rule that adverbial *when*-clauses do not use the absolute future tense is when the *when*-clause contains or implies a condition:

I think we have a right to use chemical weapons when doing so *will help* to save lives.

[He is one of those who think that] the US should use their atom bombs “whenever it *will defend* freedom or saves lives”.

In the first of these examples, the *when*-clause is interpreted as ‘when it will help to save lives if we do so’. There is a similar implicit condition in the second example. The use of the future tense in such *when*-clauses reminds us of the rule (discussed in 10.7.1) that conditional clauses that refer to the post-present and which contain or imply another clause expressing an open condition use the future tense (Absolute Future System) rather than the present tense (Pseudo-*t*₀-System):

This system of subsidies will be maintained if the farmers *will suffer* considerable losses if it is abolished.

We will not use these abbreviations if it *will result* in confusion (if we use them).

Pragmatically, the latter sentence is interpreted as ‘We will not use these abbreviations *if we are sure that* using them will result in confusion’. In the same way, *We have a right to use chemical weapons when doing so will help to save lives* is pragmatically interpreted as ‘We have a right to use chemical weapons *when we are sure that* using them will result in confusion’.

13.17 Habitual-repetitive sentences

13.17.1 An adverbial *when*-clause uses an absolute tense form if the sentence receives a habitual-repetitive interpretation:

He is never at home when I *need* him.

Why is water sprayed on orange trees when the temperature *is going to drop* to freezing? (www)

She always rubs her eyes when she *has just woken up*, and stretches, and has her eyes shut tight and makes funny grimaces. (www)

As noted before, a **HABIT** is a characteristic that exists over an extended period of time. In most cases a habit implies repetition: the characteristic in question is ascribed to the referent of the subject NP on the basis of the fact that there have been a number of instances. Such a habit can therefore be seen as a complex situation consisting of an unspecified number of subsituations. If the individual subsituations can be described in terms of a head clause and a *when*-clause, as in the above examples (where each subsituation is made up of a head clause situation and a *when*-clause situation, whose situation times are related to each other via a common Adv-time), then the complex situation as a whole

will be described in exactly the same terms. Which tense forms are used in doing this depends (a) on the time at which the habit is located, (b) on the relation between the situation time of the head clause and the contained orientation time of the head clause and (c) on the relation between the situation time of the *when*-clause and the contained orientation time of the *when*-clause. In the above examples the habit is said to hold at t_0 (although none of the subsituations (instances) making up the habit need actually take place at t_0). The present tense in the head clause is therefore an absolute tense, and so is the present tense in the *when*-clause, which also locates the habitual hypersituation consisting of instances of the *when*-clause situation at t_0 .

13.17.2 Instead of locating the habit at t_0 , we can also locate it in the pre-present. In that case the head clause uses the present perfect, while the *when*-clause can use either the past tense or the present perfect:

I have often been to Japan when the cherry trees *were* in bloom.

Payouts have sometimes risen most sharply when prices *were* already on their way down from cyclical peaks. (WSJ)

John has batted well when he *has played*. (HORN)

I've spent hours looking at things like this, when you've not *been* around. (PIN)

Whereas the past tense in the *when*-clauses of the first two examples is a relative past tense expressing T-simultaneity (see 9.9.1), the present perfect in the *when*-clauses of the latter two examples is an absolute tense form (see 9.9.6). In the latter sentences, the tense forms of both the head clause and the *when*-clause locate their situation times in the pre-present independently of one another, but the two situation times are interpreted as W-simultaneous. This kind of construction requires that both the head clause situation and the *when*-clause situation consist of an unspecified number of subsituations. The use of *when* means that each of the head clause subsituations is interpreted as W-simultaneous with one of the *when*-clause subsituations. In this way the over-all situations are also interpreted as W-simultaneous with each other, but this relation is not expressed by the tense forms. The tense forms of the two clauses relate the two over-all situations directly to t_0 .

13.17.3 When the *when*-clause uses the present perfect, the head clause occasionally uses the past tense:

When we *have suggested* changes, the people concerned *were* furious.

When I *have seen* him in the last two years, he *was* invariably accompanied by several girls.

When stocks *have been added* to the S&P 500 in the past, a flurry of buy orders often *forced* the exchanges to halt trading because of an imbalance. (WSJ)

In the past when I *have seen* anomalies like that, they *were caused* by conditions at the test site. (www)

This combination of a present perfect in the *when*-clause with a past tense in the head clause is only possible if the *when*-clause precedes the head clause. This is because the first clause introduces a (repetitive) situation as discourse topic while the second focuses on one aspect of that situation. This mechanism is the same as we have observed in connection with sentences like *I have tried using sleeping pills, but they didn't work* in 6.2.1, where the present perfect clause also has to precede the clause in the past tense. This restriction is also observed in sentences involving a restrictive relative clause and a head clause: here too the subclause may use the present perfect if it precedes the head clause in the past tense:

Everything *I have ever done* was wrong.

The one time that *I have ever been* in Paris *I stayed* at a dilapidated hotel.

In all the above sentences, the present perfect in the *when*-clause or relative clause is clearly an absolute tense form. The status of the past tense in the head clause is not so clear. One could argue that this is a relative past tense, representing the situation time of the head clause as T-simultaneous with the situation time of the *when*-clause. Conversely, it might be argued that the past tense form is an absolute tense form (which relates the situation time of the head clause directly to t_0). The latter analysis would imply that the fact that the two situation times are interpreted as W-simultaneous is not due to the tense forms but to the presence of *when* or to contextual and pragmatic factors.

It should be noted, finally, that when the situation time of the *when*-clause is repetitive, in which case we normally use *whenever* or *every time (that)* rather than *when*, sentences with a present perfect in both *when*-clause and head clause are often, but need not always be of the type illustrated by the first four examples in this subsection. In those examples, each of the subsituations making up the habit which is located in the pre-present is an instance of configuration 1 (in which the situation time of the *when*-clause is represented as T-simultaneous with the contained orientation time of the *when*-clause). However, when the present perfect is used in both clauses, each of the subsituations may also be an instance of configuration 4 (with the situation time of the head clause represented as T-anterior to the contained orientation time of the head clause):

Until now, whenever he's *come* here he's just *had* a quarrel with his wife.

It follows that a sentence like the following is ambiguous, because each instance of Bill's being in prison may be interpreted either as coinciding with or as preceding the relevant instance of the speaker seeing Bill (see also 9.9.11):

Whenever I've seen Bill he's been in prison.

In theory, the sentence *When I've seen Bill he's always been in prison* is equally ambiguous, but in practice it will normally be interpreted in terms of simultaneity. (For the anteriority reading we would say *When I've seen Bill he's always just been in prison.*)

DEMO

VIII. *When*-clause and head clause referring to different times

A clause obviously uses an absolute tense form if it locates its situation time in a different time-sphere from the head clause.

13.18 Head clause referring to the past and *when*-clause referring to the present

This kind of ‘mismatch’ of time-spheres is not normally possible in adverbial *when*-clauses. However, we might note in passing that such a mismatch can occur in *when*-clauses functioning as restrictive relative clauses forming part of a temporal adverbial. It may be due to the fact that the relative *when*-clause has generic meaning (i. e. expresses a universal truth) or to the fact that the *when*-clause refers to a habitual situation which holds not only at the time of the head clause situation but also at t_0 :

During the latter part of May and early in June the weather *was* unusually cold and wet, and growth *was checked* at a time when the quality teas of the year *are made*. (LOB)

I *had reached* the age when sexual questions *pester* the imagination ... (LOB)

There are also examples in which the relative *when*-clause refers to a single (nonhabitual and nongeneric) situation which is located at t_0 even though the head clause is in the past tense. The combination of a *when*-clause in the present tense with a head clause in the past tense is rendered possible by the fact that the *when*-clause situation covers a time span which contains not only the head clause situation but also t_0 :

[Word of Dag Hammarskjöld's death (...) has sent a shockwave around the globe. (...) He was the symbol of world peace, and] his tragic end *came* at a moment when peace *hangs* precariously. (BR)

The following is an example in which the present tense is similarly used in a *when*-clause that is an adverbial (rather than relative) *when*-clause:

[Do we want to go through this? Or can we ask you why] you *changed* your forecast just when it's about to be right? (WSJ)

13.19 Head clause referring to a past domain and *when*-clause referring to the post-present

In the following examples, the adverbial *when*-clause refers to the post-present, although the head clause uses a past time-sphere tense (incorporating the situation time of the head clause into a past domain):

[He added that (...)] child-care provisions would be part of the reconciliation bill when it *is sent* to the president. (WSJ)

[Last month Sir William Morgan (...)] said that] when existing orders *are completed* the company would stop making rolling stock for railways ... (LOB)

In these examples, the *when*-clause situation is W-simultaneous with a head clause situation that is itself represented as T-posterior to a past orientation time. In this type of sentence we would expect the *when*-clause to use a relative past tense form, and that is indeed the default choice, but the form that is actually used in these examples is a present tense form, i.e. a form from the Pseudo- t_0 -System which is used to represent its situation time as T-simultaneous with a post-present binding orientation time (and in doing so establishes a post-present way in an ‘indirect’ way – see 9.22.1). This is made possible by the fact that the situation time of the *when*-clause is W-posterior not only to the situation time of the head clause but also to t_0 .

Although examples like these resemble those in 13.18, they differ from those in that, unlike the relative *when*-clauses in 13.18, the adverbial *when*-clauses in the above examples cannot use an absolute tense form.

13.20 Head clause referring to the pre-present and *when*-clause referring to the present

When the head clause does not refer to a habitual-repetitive situation and uses a so-called ‘indefinite’ present perfect (see 5.4), it cannot support a *when*-clause:

I have seen him.

*I have seen him when he came in just now.

It is typical of an indefinite perfect interpretation that the exact location of the situation time in the pre-present must remain indefinite. Hence the impossibility of adding a *when*-clause indicating a specific time. However, it was noted in section 13.17 that a *when*-clause can be added if the head clause receives a habitual-repetitive interpretation. In that case the *when*-clause can use either the present perfect or the past tense:

John has batted well when he *has played*. (HORN)

I have often been in Japan when the cherry trees *were* in bloom.

However, apart from examples like these, we can also find examples in which the *when*-clause uses the present tense:

I've only ever met Mrs Cunliffe when she *comes* round collecting signatures for protest petitions. (MAR)

I tried to explain what has happened, unfailingly, whenever a significant body of Negroes *move* North. (BR)

In examples like these, the use of an absolute present tense in a *when*-clause depending on a head clause in the present perfect is made possible by the fact that the *when*-clause refers to a habitual-repetitive situation, instances of which are to be found not only in the pre-present but also in the present. What happens is that the speaker changes track between head clause and *when*-clause. He first wants to talk about his (lack of) experience, which means referring to the time-up-to-now and then he wants to talk about the presentness of the habit which produces that experience.

DEMO

IX. Summary

In this chapter on adverbial *when*-clauses we have presented an analysis of the temporal structure expressed by *when* and examined the possibilities of tense choice in adverbial *when*-clauses and in the head clauses supporting them. The following are the main conclusions we have arrived at:

- (a) The temporal structure expressed by *when* is that of a **common Adv-time** containing both an orientation time from the tense structure of the head clause (= the **contained orientation time of the head clause**) and an orientation time from the tense structure of the *when*-clause (= the **contained orientation time of the *when*-clause**). This temporal structure, which is the semantics of *when*, can therefore be paraphrased as ‘at a/the time at which’.
- (b) The *when*-clause can specify either the situation time of the head clause or an orientation time which binds the situation time of the head clause in terms of T-anteriority or T-posteriority. In other words, the *when*-clause can be used either as a **situation-time adverbial** or as an **orientation-time adverbial**.
- (c) In both cases the *when*-clause uses a relative tense, which represents the situation time of the *when*-clause as T-anterior, T-simultaneous or T-posterior to the contained orientation time of the *when*-clause.
- (d) It follows from (b)–(c) that there are **nine unmarked configurations** of temporal relations, realizing **nine different temporal structures** involving the common Adv-time expressed by *when*. These nine configurations, which have in common that the situation time of the *when*-clause is bound by the contained orientation time of the *when*-clause, can be considered as forming the set of unmarked options as far as tense choice is concerned. As the examples have shown, all nine of them are compatible with reference to the past as well as with reference to the post-present.¹²
- (e) Apart from the unmarked options, there are some marked uses of tenses in adverbial *when*-clauses. Under certain conditions the *when*-clause can use the past perfect (but not the conditional tense or the conditional perfect!) to effect **indirect binding**, i. e. to T-relate the situation time of the *when*-clause to an orientation time which is not the contained orientation time of the *when*-clause (and which is not t_0 either). There are also cases in which the *when*-clause uses the conditional tense or conditional perfect in order to express **irrealis**, i. e. in order to represent the actualization of

12. Like time-specifying adverbials such as *at five o'clock*, Adv-time-*when*-clauses are normally incompatible with reference to the present, except in special cases (summaries, habitual-repetitive sentences, etc.).

the *when*-clause situation as **counterfactual** or **tentative**. Finally, it is possible for the *when*-clause to **shift the domain** to the post-present, in which case a form from the **Pseudo- t_0 -System** has to be used. Since all these cases represent a marked tense choice, they are relatively uncommon and subject to severe restrictions.

DEMO

14. Adverbial *before*-clauses and *after*-clauses

I.	Adverbial <i>before</i> -clauses	657
A.	Introduction	657
14.1	Terminology	657
14.2	The temporal structure of <i>before</i>	657
14.3	Temporal structures involving a head clause and a <i>before</i> -clause	688
14.4	The nature of past tense forms in <i>before</i> -clauses	692
B.	The tense system if the <i>before</i> -clause is a situation-time adverbial	698
14.5	Absolute tense forms in both <i>before</i> -clause and head clause	699
14.6	Absolute tense in the head clause and relative tense in the <i>before</i> -clause	707
14.7	Relative tense in head clause and relative tense in <i>before</i> -clause	717
14.8	Relative tense in head clause and absolute tense in <i>before</i> -clause	721
14.9	Summary of section B	725
C.	The tense system if the <i>before</i> -clause is an orientation-time adverbial	727
14.10	Using a <i>before</i> -clause as orientation-time adverbial	727
D.	Factual, not-yet-factual and counterfactual <i>before</i> -clauses	729
14.11	Factual interpretations of <i>before</i> -clauses	729
14.12	Counterfactual <i>before</i> -clauses	735
14.13	Not-yet-factual <i>before</i> -clauses	736
E.	A comparison between <i>before</i> and <i>until</i>	738
14.14	The semantics of the conjunction <i>until</i>	738
14.15	The tenses used in head clause and <i>until</i> -clause	739
14.16	The semantics of <i>not...until</i>	740
II.	Adverbial <i>after</i> -clauses	742
14.17	The temporal structure of <i>after</i>	742
14.18	Temporal structures involving a head clause and an <i>after</i> -clause	745
14.19	The tense system if the <i>after</i> -clause functions as situation-time adverbial	747
14.20	The tense system if the <i>after</i> -clause functions as orientation-time adverbial	750
III.	Summary	754
14.21	Summary of the discussion of <i>before</i> -clauses	754
14.22	Summary of the discussion of <i>after</i> -clauses	756

Abstract

This chapter deals with the use of tenses in sentences consisting of a head clause and an adverbial time clause if the latter is introduced by *before* or *after*. *Until*-clauses are also included in the discussion.

Part I deals with *before*-clauses. We begin by explaining the temporal structure of *before*, which is interpreted as ‘before the time at which’. The implicit orientation time lexicalized as *the time* in this paraphrase is called the ‘Anchor time’. The *before*-clause establishes a durative Adv-time which contains the situation time of the head clause, or another orientation time from the tense structure of the head clause, in terms of inclusion or coincidence. The situation time of the *before*-clause can function as Anchor time or is T-related to the Anchor time by a relative tense form.

In section B of part I, we investigate the tenses that can be used in the head clause and the *before*-clause if the latter functions as a situation-time adverbial (i. e. if the situation time of the head clause is the orientation time that is contained in the Adv-time denoted by the *before*-clause). We come to the conclusion that there are several possible temporal configurations, the most important of which are illustrated by *John left before Bill arrived* (which represents both situations as past facts), *John had left before Bill arrived* (where the head clause receives a resultative reading) and *John left before Bill had arrived* (where the past perfect underscores the ‘not-yet-factual-at-t’ read-

ing of the *before*-clause, i. e. the idea that Bill had not (yet) arrived when John left).

In section C of part I, we examine the exceptional cases in which a *before*-clause functions as an orientation-time adverbial.

Section D of part I is concerned with the various factors (including the choice of tense) which can induce the *before*-clause to be interpreted as factual (as in *John left before Bill arrived*), counterfactual (as in *John died two weeks before he would have celebrated his 30th birthday*) or not-yet-factual-at-t (as in *John left before Bill had arrived*).

In section E of part I, a comparison is made between *before*-clauses and *until*-clauses.

Part II is devoted to *after*-clauses. We start by examining the temporal structure of *after*, which is interpreted as ‘after the time at which’. The implicit orientation time lexicalized as *the time* in this paraphrase is called the ‘Anchor time’. The *after*-clause establishes a durative Adv-time which contains the situation time of the head clause, or another orientation time from the tense structure of the head clause, in terms of inclusion or coincidence. The situation time of the *after*-clause can function as Anchor time or is T-related to the Anchor time by a relative tense form.

In the rest of Part II, the possible tense configurations are examined which can be realized in a sentence consisting of a head clause and an *after*-clause.

In Part III, the main findings of this chapter are summarized.

I. Adverbial *before*-clauses

A. Introduction

14.1 Terminology

The terminology that will be used here is largely the same as has been used in the discussion of adverbial *when*-clauses in chapter 13. The superordinate clause on which an adverbial *before*-clause syntactically depends will be called the **HEAD CLAUSE**. We will call the time of the ('predicated' – see 2.12.1) situation referred to in the head clause the **SITUATION TIME OF THE HEAD CLAUSE**. We will similarly speak of the **SITUATION TIME OF THE BEFORE-CLAUSE**. The function of an adverbial *before*-clause, and in fact of any time-specifying adverbial, is to create an **ADV-TIME**, i. e. to specify a (punctual or durative) interval which **contains** (in terms of inclusion or coincidence – see 2.23.1) either the situation time of the head clause (in which case the *before*-clause is a **SITUATION-TIME ADVERBIAL** – see 2.24) or another orientation time to which the situation time of the head clause is related by the tense form of the head clause (in which case the *before*-clause functions as an **ORIENTATION-TIME ADVERBIAL** – see 2.25). The orientation time (from the tense structure of the head clause) that is contained by the Adv-time will be called the **CONTAINED ORIENTATION TIME**.

14.2 The temporal structure of *before*

The temporal structure of the conjunction *before* is shown in Figure 14.1.

14.2.1 The conjunction *before* is semantically equivalent to 'before the time {that / at which}'. This is in keeping with the fact that the conjunction *before* has actually developed from a phrase of the form 'before the time that' or 'before then that' (variously realized in Old English as *toforan þam timan þe*, *foran to þam timan þe* and *toforan þam þe*). The sentence *John left before Bill arrived* can therefore be paraphrased 'John left at a time before the time {when / at which} John arrived'.¹ In this paraphrase, *a time before ...* refers to the Adv-time, *at* expresses the containment relation between this Adv-time

1. Since there is no semantic difference between 'X actualized before the time that Y actualized' and (the more unwieldy) 'X actualized at a time before the time that Y actualized', we treat the latter as a valid paraphrase of the former.

and the contained orientation time, and the second *time* refers to the terminal point of the Adv-time. Let us refer to the latter point as the ‘ANCHOR TIME’ of the *before*-clause. The temporal structure of the conjunction *before* can be represented as in Figure 14.1. (Remember that the contained orientation time is represented by an x irrespective of whether it is included in the Adv-time or coincides with it.)

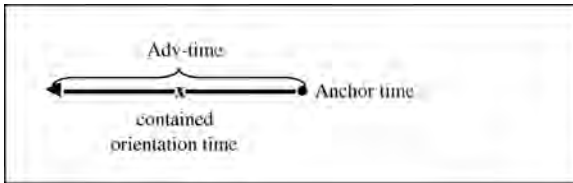

Figure 14.1. Representation of the temporal structure of *before*.

14.2.2 As is clear from Figure 14.1, the conjunction *before* establishes a durative Adv-time whose right boundary is an Anchor time (lexicalized as *the time* in the paraphrase ‘before the time that’). The Adv-time contains the contained orientation time (in terms of inclusion or coincidence). If there is inclusion, *before* means ‘at some time in the course of the period before’; if there is coincidence, *before* means ‘throughout the period before’. As we will see, the Anchor time may be either the situation time of the *before*-clause itself or another (implicit) orientation time to which the situation time of the *before*-clause is T-related. By contrast, the contained orientation time is nearly always the situation time of the head clause itself. (In this respect, *before*-clauses differ from *when*-clauses, which are more easily used as orientation-time adverbials.) For example:

John left *before* Bill arrived. (*The situation time of the head clause, i. e. the time of John’s leaving, is the contained orientation time, while the situation time of the before-clause is the Anchor time.*)

John will leave *before* Bill arrives. (*The situation time of the head clause is the contained orientation time, while the situation time of the before-clause is represented as T-simultaneous with the implicit Anchor time.*)

14.3 Temporal structures involving a head clause and a *before*-clause

14.3.1 It follows from the previous section that at least the following two temporal structures involving a head clause and a *before*-clause are possible. In both cases the *before*-clause functions as a situation-time adverbial.

- (a) Firstly, the situation time of the head clause may be contained in the Adv-time, while the situation time of the *before*-clause is T-related to an implicit Anchor time (by a relative tense form):

John *will leave* before the pub *closes*. (The situation time of the head clause is included in the Adv-time. The *before*-clause uses a ‘Pseudo- t_0 -System form’ – see 10.2 – to T-relate the situation time of the *before*-clause to the implicit Anchor time. The temporal structure of the sentence is shown in Figure 14.2.)

[I hoped that] the convict *would be treated* well before he *was executed*. (The situation time of the head clause coincides with the Adv-time. The *before*-clause uses the relative past – see 8.12 – to represent the situation time of the *before*-clause as T-simultaneous with the Anchor time. Because the past tense in the *before*-clause is not an absolute preterite, the situation referred to is not interpreted as t_0 -factual – see 14.4.2 below.)

He *left* long before I *had arrived*. (The situation time of the head clause is included in the Adv-time. The *before*-clause uses the past perfect to represent its situation time as T-anterior to the implicit Anchor time.)

John *will leave* before the pub *closes*. (The situation time of the head clause is included in the Adv-time. The situation time of the *before*-clause is represented as T-simultaneous with the Anchor time.)

[I expected that] he *would leave* before the pub *closed*. (The situation time of the head clause is the contained orientation time. The *before*-clause uses a ‘relative past tense’ to represent the situation time of the *before*-clause as T-simultaneous with the implicit Anchor time.)

John *would leave* before the pub *had closed*. (The situation time of the head clause is the contained orientation time. The situation time of the *before*-clause is represented as T-anterior to the implicit Anchor time.)

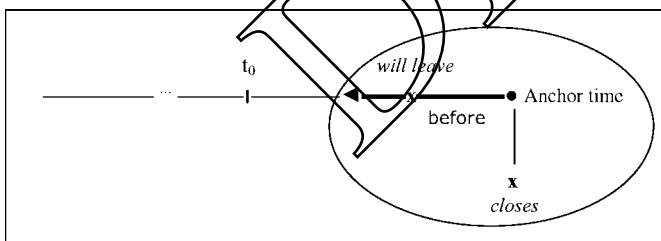

Figure 14.2. The temporal structure of *John will leave before the pub closes*.

In the above examples, the *before*-clause each time functions as a situation-time adverbial, i. e. it specifies an Adv-time which includes the situation time of the head clause. The situation time of the *before*-clause is each time temporally subordinated to (= bound by) the Anchor time by means of a relative tense.

(As to the head clause, it uses either an absolute or a relative tense form. This is not relevant to the present discussion.)

- (b) Secondly, the situation time of the head clause may be contained in the Adv-time (which therefore functions as a situation-time adverbial), while the situation time of the *before*-clause is the Anchor time. (This possibility corresponds exactly to the temporal structure presented in Figure 14.1.) For example:

The man *killed* his wife and children before he *shot* himself. (*The situation time of the head clause is included in the Adv-time. The situation time of the before-clause is the Anchor time, i. e. the terminal point of the Adv-time.*)

He *was* a well respected citizen before he *killed* his wife. (*Similar, except that the situation time of the head clause now coincides with the Adv-time. This is another form of 'being contained' in the Adv-time.*)

John *had left* before the pub *closed*.

14.3.2 There are also cases in which the *before*-clause functions as an orientation-time adverbial (i. e. the contained orientation time is not the situation time of the head clause but an implicit orientation time binding the situation time of the head clause). The following (not very likely) example illustrates nicely how the temporal structure may then look like:

- (1) [If the National Health Service is dismantled further] some people *will be about to die* before they *get* medical treatment.

This sentence realizes the structure represented by Figure 14.3.

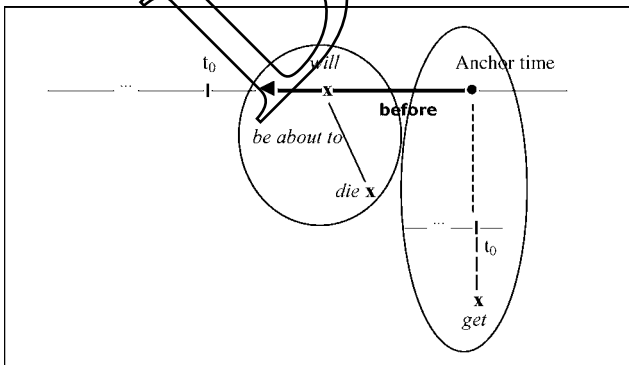

Figure 14.3. The temporal structure of *Some people will be about to die before they get medical treatment.*

Sentence (1) can be paraphrased as follows:

(1') In the period before the time when (= at which) they get medical treatment, it will be the case that some people are about to die.

Paraphrase (1') reveals the various temporal relations:

- (a) The time referred to by *it will be the case* is the contained orientation time of the head clause.
- (b) *In the period* indicates this containment relation.
- (c) *Before* expresses that the Adv-time is a time span that lies before (i.e. leads up to) an Anchor time. (This 'before' relation is expressed by the conjunction, not by either of the tense forms.)
- (d) The Anchor time is indicated by the second occurrence of *the time* in (1'). It remains implicit in (1).
- (e) The situation time of the *before*-clause is bound by the Anchor time in terms of T-simultaneity: the Pseudo- t_0 -System form *get* is used for this.
- (f) The string *it will be the case that some people are (about to die)* in the paraphrase reflects the fact that the verb form of the head clause of (1) (*will be about to die*) is an absolute-relative tense form: it both establishes a post-present domain and expresses posteriority in it:² the situation time of the head clause (i.e. the time of people dying) is represented as T-posterior to the implicit contained orientation time (which coincides with the Anchor time and is the central orientation time of a post-present domain).
- (g) The situation time of the head clause and the situation time of the *before*-clause are bound by different orientation times, which are the (implicit) 'central orientation times' (see 8.15) of two different post-present domains: the situation time of the head clause is bound by the implicit contained orientation time of the head clause, while the situation time of the *before*-clause is bound by the Anchor time.

The temporal structure of (1) is rather intricate, but in later sections we will discuss sentences like the following, whose temporal structures are equally, if not more, complex:

Before they had gone very far, Jill had already sprained her ankle.

Mother will have gone to bed before I have finished my homework.

2. *Be about to* can be used as a 'futurish' form expressing posteriority – see 2.9.1.

14.4 The nature of past tense forms in *before*-clauses

The situation time of the *before*-clause may be T-related to the Anchor time (= the terminal point of the Adv-time, lexicalized as *the time* in the paraphrase ‘before the time that’) or may be the Anchor time itself. In the former case the *before*-clause uses a relative tense form, in the latter it uses an absolute tense form. This section provides evidence for this claim.

In one of the arguments it is noted that *before*-clauses are ‘factual at t_0 ’ (or ‘ t_0 -factual’) if they represent their situation as actualizing in the past (e. g. *John left before Bill arrived*). However, when the *before*-clause forms part of an opaque (intensional) context, it is interpreted as ‘not-yet-factual at the binding time’ (or ‘not-yet-factual at t' ’), i. e. as not yet a fact at the time of the situation time of the head clause (e. g. *John wanted to leave before Bill arrived*).

14.4.1 In section 14.3.1 we have stated that the situation time of the *before*-clause may be T-related to the Anchor time (= the terminal point of the Adv-time, lexicalized as *the time* in the paraphrase ‘before the time that’) or may be the Anchor time itself. In the former case the *before*-clause uses a relative tense form, in the latter it uses an absolute tense form.

The claim that a *before*-clause can use a relative tense form is confirmed by examples like the following:

I will switch off the lights before I {leave / *will leave} the house. (*Pseudo- t_0 -System form expressing T-simultaneity with the Anchor time*)

[I hoped that] he would switch off the lights before he {left / *would leave} the house. (*Left is a relative past tense form expressing T-simultaneity with the Anchor time; would leave, which would effect ‘indirect binding’, is not grammatical.*)

At first sight it would not seem to be as easy to prove the claim that a *before*-clause can also use an absolute tense, because (for reasons explained in 10.7.2) an adverbial *before*-clause cannot normally use an Absolute Future System form:

He will leave before the pub {*will close / closes}.

However, there are some exceptions — see 14.5.2 below:

It will be a long time before that {will become / becomes} possible.

I think those creating tablet PCs need a “killer app” to run on these units before they will be useful. (www)

[Safe housing near campus is limited.] The best housing is reserved by local students weeks before you will arrive. (www)

Tell Steve hello for him! He will be seeing Steve again before I will on June 5th The Crossroads Guitar Festival. (www)

This shows that the use of an absolute tense in a *before*-clause is not a priori impossible.

As usual, the claim that a *before*-clauses can in principle use either a relative or an absolute tense form is difficult to corroborate when the verb form is in the past tense, because there is no formal difference between an absolute and a relative preterite form. In sections 14.4.2–5 we will review some evidence and apply it to the following example:

John left before Bill arrived.

We will argue that in examples like this both the head clause and the *before*-clause use an absolute tense form, i. e. that *John left before Bill arrived* has the temporal structure shown in Figure 14.4, which is determined both by the tenses and by the semantics of *before*. On the other hand, we will argue that *arrived* is a relative past tense form in *John wanted to leave before Bill arrived*.

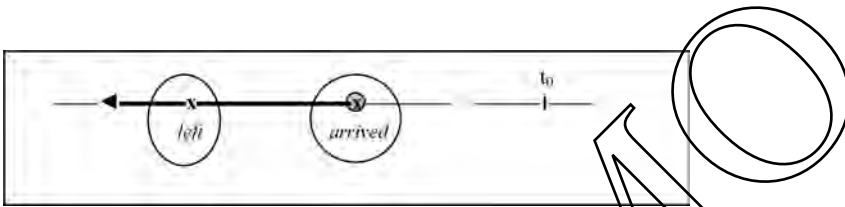

Figure 14.4. The temporal structure of *John left before Bill arrived*.

14.4.2 In a sentence like *John left before Bill arrived* not only the head clause situation but also the *before*-clause situation is represented (and interpreted) as ‘**FACTUAL AT t_0** ’ (or ‘ **t_0 -FACTUAL**’), i. e. as a situation which did actualize in the past. In this respect this sentence differs from *John wanted to leave before Bill arrived*, in which the *before*-clause situation is not represented as a past fact but as part of a past expectation which may or may not have been fulfilled before t_0 . In other words, in *John wanted to leave before Bill arrived*, the *before*-clause forms part of the **OPAQUE (INTENSIONAL)** context created by *want*.³ John’s leaving is therefore not represented as t_0 -factual but as something

3. As noted in 10.4.6, an opaque context (or ‘intensional context’) is one in which the reference is not to the real world but to an alternative (e. g. imaginary) world. Such a context is created by (amongst other things) ‘intensional verbs’ (‘verbs of propositional attitude’) like *want*, *expect*, *believe*, *think*, *imagine*, etc. Clauses that form part of an intensional context receive an ‘opaque’ (‘de dicto’) interpretation, i. e. their truth is not evaluated in relation to the real world but in relation to the alternative world referred to.

Clauses belonging to a nonintensional context receive a ‘transparent’ (‘de re’) interpretation, i. e. their truth is evaluated in relation to the real world. It is typical of such an interpretation that the truth value of the clause is not affected when a referring expression in the clause is replaced by an ‘identical’ expression (i. e. by an expression

which John wanted to happen later. Whether it did actually happen or not is not expressed by this sentence. The same is true of the *before*-clause situation (Bill's arrival), which is represented (by *before*) as posterior to John's leaving. Because of this posteriority relation, Bill's arrival is interpreted as '**NOT-YET-FACTUAL AT THE BINDING TIME**', i. e. as not yet a fact at the time of the situation time of the head clause (= the time of John's leaving). Note that we are not using the term 'not-yet-factual' in the sense of 'counterfactual' (which is the opposite of ' t_0 -factual' and means 'running counter to what is factual at t_0 '). Thus, *John wanted to leave before Bill arrived* does not imply that Bill did not arrive; it just fails to imply that he did. In what follows we will simplify 'not-yet-factual at the binding time' to '**NOT-YET-FACTUAL AT T**' or simply '**NOT-YET-FACTUAL**'.

Since it is inherent in the structure 'A before B' that B is not yet a fact at the time of A, one might expect that all sentences consisting of a head clause and a *before*-clause represent the situation time of the *before*-clause as not-yet-factual, and therefore (a fortiori) as not t_0 -factual. However, it is clear from *John left before Bill arrived* that not all *before*-clauses are not interpreted as t_0 -factual. This means that there is something in *John left before Bill arrived* that supplements the natural not-yet-factual interpretation of the *before*-clause with a t_0 -factual (= factual at t_0) interpretation: 'Bill had not yet arrived when John left, but he did arrive later.' Since the sentence is used out of context, the only element that can be responsible for this t_0 -factual interpretation is the fact that *arrived* is an absolute tense form. If a clause uses an absolute past tense form, it T-relates its situation to t_0 , not to the situation time of the head clause (nor to any other orientation time that is related to the situation time of the head clause). The use of the absolute preterite places the situation time of the *before*-clause on the time line, so that, in the absence of any indication to the contrary, it is interpreted as a past fact, i. e. as t_0 -factual.

In this context, it is useful to compare the following:

- (2a) John wanted to leave before Gordon arrived.
- (2b) John left before Gordon arrived.
- (2c) Mary {said / imagined / believed} that John had left before Gordon arrived.
- (2d) Mary {said / imagined / believed} that John left before Gordon arrived.

with the same referent). Thus, since in the real world *the capital of France* and *Paris* have the same referent, we can replace the former by the latter in *The capital of France has ten million inhabitants* without altering the truth value of the sentence.

In sentences that receive an opaque interpretation, the replacement of a term by an 'identical' expression may affect the truth value: the sentence *Bill thinks that Paris is the capital of Spain* may be true even if *Bill thinks that the capital of France is the capital of Spain* is not true.

In (2a), the *before*-clause forms part of the intensional domain (world) created by *wanted* and represents the time of its situation (Gordon's expected arrival) as T-simultaneous with the Anchor time that is implicit in *before* (= 'before the time at which'). In this way the *before*-clause situation is not directly related to t_0 . *Arrived* is therefore a relative preterite form. This, and the fact that the *before*-clause forms part of an intensional domain, entails that the *before*-clause situation (Gordon's arrival) is not represented as a past fact. Instead it is represented as a situation which, at the time of the head clause situation, was expected to actualize later. In sum, in (2a) *arrived* is a relative preterite, whose situation is not interpreted as a past fact.

When (2b) is used out of context, the *before*-clause does not form part of an intensional domain and is interpreted as t_0 -factual. This is in keeping with the claim that *arrived* is now an absolute preterite form, which means that it relates its situation time directly to t_0 .

Example (2c) is like (2a) in that both the *before*-clause and its head clause form part of the intensional domain created by the first clause (i. e. the matrix) and are therefore interpreted as not-yet-factual at t_0 . The fact that the situation time of the head clause is now represented as T-anterior to the central TO of the temporal domain does not alter this.

Sentence (2d) differs from (2c) only in that the speaker does not incorporate the situation times of the head clause and the *before*-clause into the temporal domain established by the matrix clause but has these two clauses shift the domain: both *left* and *arrived* are absolute tense forms. However, this does not produce a t_0 -factual (nonintensional, transparent) interpretation of these forms, because the head clause and the *before*-clause are anyhow not interpreted as t_0 -factual (= factual at t_0) because the head clause is syntactically dependent on the intensional verb of the matrix clause.⁴

We can draw the following conclusions from the above examples:

- (a) When it is within the scope of an intensional verb, a head clause is not interpreted as t_0 -factual (i. e. as being a past fact), irrespective of whether it uses a relative tense, such as *had left* in (2c), or an absolute tense, such as *left* in (2d).

4. In other words, in this sentence both *John left* and *Bill arrived* shift the domain (i. e. use the absolute past tense). But the t_0 -factual interpretation that is normally induced by the use of the absolute preterite is overridden by the fact that the *that*-clause depends on an intensional verb which refers to a world that is different from the speaker's t_0 -world. The not-yet-factual-at- t_0 reading thus persists in spite of the fact that the tense does not locate John's leaving and Bill's arrival in the temporal domain created by the intensional verb. In other words, the syntactic relation between the matrix and the *that*-clause anyhow imposes an intensional reading on the *that*-clause, even though the tense of the head clause does not.

- (b) If the head clause is not interpreted as t_0 -factual, neither is the *before*-clause depending on it.
- (c) When not used in an intensional context, a head clause and a *before*-clause in the past tense are interpreted as t_0 -factual. This is the case in (2b). A t_0 -factual interpretation implies that the situation referred to is T-related to the speaker's t_0 . This means that the past tense forms in (2b) are absolute preterites.
- (d) A preterite in a *before*-clause can in principle be either a relative preterite or an absolute one. In the former case the tense form itself does not trigger a t_0 -factual interpretation,⁵ whereas in the latter case it does, unless that interpretation is ruled out by the fact that the matrix clause creates an intensional domain, as in (2d).

14.4.3 It is not easy to find further direct evidence supporting the hypothesis that a *before*-clause in English can in principle use either a relative or an absolute preterite, because there is no formal difference between these tense forms. However, indirect evidence can be derived from a cognate language, viz. Dutch. In Dutch, the two meanings that we assign to the preterite forms in English (viz. t_0 -factual and not-yet-factual-at-t) can be distinguished on the basis of the fact that one of them can be expressed in an alternative way. Consider:

- (3a) Jan vertrok voordat Bill *toekwam*. ('John left before Bill arrived')
- (3b) Jan wou vertrekken voordat Bill *toekwam*. ('John wanted to leave before Bill arrived')
- (3c) Jan wou vertrekken voordat Bill *zou toekomen*. ('John wanted to leave before Bill would arrive')

Sentence (3a) is the exact Dutch equivalent of *John left before Bill arrived*, and (3b) is the exact equivalent of *John wanted to leave before Bill arrived*. However, the latter sentence can also be translated as (3c). The reason is that Dutch allows a form of indirect binding which is ungrammatical in English: the tense structure of a Dutch sentence with a *before*-clause may be such that the situation time of the *before*-clause is directly related to the situation time of the head clause (in terms of T-posteriority). Whereas in (3b) the preterite form *toekwam* represents the situation time of the *before*-clause as T-simultaneous with the implicit Anchor time, the conditional tense form *zou toekomen* in (3c) represents the situation time of the *before*-clause as T-posterior to the situation

5. Note, however, that a relative tense form is not incompatible with a factual interpretation which is triggered by the linguistic or extralinguistic context. For example:

["Did he write that letter when he was going to commit suicide?"] – "No, he wrote it long before he was going to commit suicide."

The *before*-clause in the reply sentence 'inherits' the factual interpretation of the *when*-clause in the question.

time of the head clause (= indirect binding). In neither case is the *before*-clause situation interpreted as t_0 -factual.

The Dutch data lend support to the claim that the past tense form *arrived* in *John wanted to leave before Bill arrived* is a relative tense form. Since indirect binding is an alternative to direct binding in Dutch, the fact that the past tense form *toekwam* in (3b) alternates with the conditional tense form *zou toekomen* in (3c) corroborates the view that the former is an instance of direct binding, i.e. a relative tense form. The claim that *toekwam* is not a relative past tense form in (3a) is then corroborated by the fact that the substitution of the relative tense form *zou toekomen* for *toekwam* is ungrammatical in this sentence: **Jan vertrok voordat Bill zou toekomen* ('John left before Bill would arrive').

In sum, the data from Dutch are consonant with the claim that an absolute preterite represents a *before*-clause situation as t_0 -factual, whereas a relative tense form (irrespective of whether it is a preterite or a conditional tense form) locates the *before*-clause situation in the temporal (and intensional) domain established by the head clause or the matrix clause, and in so doing fails to represent it as t_0 -factual.

14.4.4 The similarity between Dutch and English is actually stronger than has been suggested so far. Although, unlike Dutch, present-day English does not allow the use of the conditional tense in *before*-clauses that are not-yet-factual-at-t but not t_0 -factual, more or less archaic English does allow the use of *should* in such *before*-clauses. This use of *should* represents a form of indirect binding:

[I was railfanning in Lima this afternoon and took this shot of the signal bridge that guards the NS(NKP) diamond at Ford Park. I'm not sure how far back it dates, but I know it was there at least in the early '70s from photo's I've seen.] I wanted to take a picture before it *should* suddenly *disappear* like some other things recently. (www)

[It was all of 8 o'clock by now and I told of my plan.] I wanted to go to the cemetery before we *should leave* for the other half of our pilgrimage. (www) (*written in 1971, but quite possibly a bit pseudo-archaic*)

[When we came to understand what the gentleman meant we told him that we were very glad, for] we wanted to wake him up before he *should die* with such a misunderstanding of God's terms. (www)

[I now gained on him, so much so that when I first saw the ocean he was but one day's journey in advance, and] I hoped to intercept him before *he should reach* the beach. (www) (*from Mary Shelley's 'Frankenstein'*)

[... knowing in what good hands I left the cause, I came away on Monday,] trusting that many posts would not pass before I *should be followed* by such very letters as these. (www) (*from Jane Austen's 'Mansfield Park'*)

[Where is it to end? Suppose the Bowl were increased to even 125,000,] how many years would it be before we *should have* 150,000 seats demanded? (www)

14.4.5 Further evidence, again from Dutch, can be derived from what we have called the ‘Dutch test’ (see 8.32). This test relies on the observation that Dutch can sometimes use the present perfect where English has to use an absolute preterite, but cannot normally use the present perfect where English uses a relative preterite. If we apply this test to *John left before Bill arrived*, we see that it can be translated not only as (3a) but also as follows:⁶

Jan is vertrokken voordat ik ben aangekomen. (‘John has left before I have arrived’)

Since the Dutch present perfect cannot normally be used as a relative tense, we must conclude that the present perfect in the *before*-clause is an absolute tense form, i. e. a form which shifts the domain. Given the strong similarity between the English and Dutch tense systems (especially the fact that neither language uses the present perfect to express a relation in a past or pre-present domain), this corroborates our claim that the preterite in the English counterpart of the above example should also be analysed as an absolute tense form.

14.4.6 The above conclusion is also supported by the ‘represented speech test’ – see 8.25. Consider the following scrap of conversation:

- A. John is a doctor. And I think Bill is a doctor too.
 B. Yes. As a matter of fact Bill *was* a doctor before John *was* one.

B’s reply can be reported as

Mary said that Bill *had been* a doctor before John *had been* one.

The fact that both preterites of (B) can be ‘backshifted’ in represented speech proves that both preterites are absolute tense forms – see 8.25. (Note that *had been* cannot be an instance of indirect binding – see 9.29. *Before*-clauses do not allow indirect binding by means of a past perfect, because, unlike *when*, *before* rules out the possibility that, if both clauses use the past perfect, the *before*-clause situation is interpreted as W-simultaneous with the head clause situation.)

14.4.7 In sum, there appears to be sufficient evidence that a preterite form in a *before*-clause can be an absolute tense form, in which case the situation it refers to is represented as a past fact.

B. The tense system if the *before*-clause is a situation-time adverbial

As noted in 14.2.2, adverbial *before*-clauses are nearly always used as situation-time adverbials. An investigation of the possible tense combinations in the head

6. This does not mean that the two Dutch translations are interchangeable in any context. The two are subject to slightly different conditions of use, but this is irrelevant to the argument that is presented here.

clause and the *before*-clause is necessary because different tense patterns often entail different meanings (which have to do with different degrees and kinds of factuality). As will be made clear, adverbial *before*-clauses functioning as situation-time adverbials can appear in four major tense configurations (apart from some others mentioned further on). They are exemplified by the following sentences, all of which can be used to describe the same state of affairs, but all of which are interpreted differently:

Jim arrived before the others left.

Jim arrived before the others had left.

Jim had arrived before the others had left.

Jim had arrived before the others left.

The first sentence (with an absolute tense in both clauses) will be discussed in 14.5. The second (with an absolute tense in the head clause and a relative one in the *before*-clause) will be examined in 14.6. The third sentence (with a relative tense in both clauses) will be discussed in 14.7. The fourth example (with a relative tense in the head clause and an absolute one in the *before*-clause) will be investigated in 14.8. In all four sections, related tense patterns will be investigated too.

14.5 Absolute tense forms in both *before*-clause and head clause

14.5.1 It is possible for both the head clause and the *before*-clause to use the absolute past tense. In 14.4.2–6 we have adduced evidence that this tense structure is realized in sentences like *John left before Bill arrived*. This type of sentence is typically used when the speaker wants to express no more than that two situations actualized in a particular order ('A before B') in the past. The claim that both tense forms are absolute tense forms is in keeping with the fact that both situations are interpreted as t_0 -factual. The temporal structure of *John left before Bill arrived* is represented by Figure 14.4 in section 14.4.1.

14.5.2 As we have seen, it is not normally possible for a *before*-clause to use an 'Absolute Future System form' (see 10.1) establishing a post-present domain:

Bill will leave before the pub {closes / *will close}.

However, there are a few exceptions to this rule. These constitute further cases in which an absolute tense form is used in both the *before*-clause and the head clause.

(a) Firstly, there are situations involving a head clause and a *before*-clause in which the temporal relation between the two situations seems to be less

important than the logical relation: the head clause expresses a kind of (pre)condition for the actualization of the *before*-clause situation, and the *before*-clause is the head clause (expressing *q*) of what is semantically an ‘if *p*, then *q*’ conditional. In this case the use of the future tense in the *before*-clause is quite normal:

You will need to register as a user of the Discussion Groups before you *will be* able to post any messages to the discussion. (www) (= ‘{Unless you have registered / If you haven’t yet registered} as a user of the Discussion Groups, you will not be able to post any messages to the discussion.’)

[I may have to take a long term disability.] So I will have to get well before I *will* ever be ready for work. (www) (= ‘I won’t be ready for work as long as I haven’t got well.’; ‘Getting well is a precondition for being ready for work.’)

Financial aid awards are typically paid to you by checks and your US bank account will have to be established before you *will be* able to cash a check. (www)

Please note that students who fail the OS proficiency exam or the EE-450 placement exam twice will be required to take the corresponding undergraduate course (and receive a grade of B or better) before they *will be given* permission to take CSCI-551. (www)

I think those creating tablet PCs need a “killer app” to run on these units before they *will be* useful. (www)

- (b) A second case in which a *before*-clause can use the future tense is illustrated by the following.

It is just a matter of time before the trainee schools *will disappear* altogether from the scene. (LOB)

There is still an hour left before the others *will be* here.

[In his preliminary report (...) Sir Hugh Cairns stresses that] several years must elapse before he *will know* whether the improvements (...) are permanent. (TCIE)

In this type of sentence the head clause is in the present tense. It does not describe a situation whose time is specified by the *before*-clause referring to the post-present but indicates the distance between t_0 and a post-present orientation time identified by the *before*-clause. The possibility of using the future tense in the *before*-clause appears to have less to do with the fact that the *before*-clause is not really a time-specifying adverbial than with the fact that the head clause does not explicitly establish a post-present domain. This appears from the fact that if the head clause is interpreted as implicitly establishing a post-present domain, the *before*-clause can use the present tense (as Pseudo- t_0 -System form):

It is just a matter of time before the trainee schools *disappear* altogether from the scene.

There is still an hour left before the others *are* here.

[We, in the trade, feel that many people think that this is a new version of the whole Bible. It is, of course, only the New Testament:] it will be many years before the Old Testament, and the Apocrypha *are* available. (LOB)

[In his preliminary report (...) sir Hugh Cairns stresses that] several years must elapse before he *knows* whether the improvements (...) are permanent.

In many such examples, there is no clear difference of meaning between the present tense and the future tense. In some cases, however, the present tense suggests that the speaker feels certain that the *before*-clause situation will actualize. Thus, in the last example, there is an assumption that Sir Hugh will know something about the permanency of the improvements, whereas, if *will know* is used, Sir Hugh may never know anything about the improvements.

Even if the head clause explicitly establishes a post-present domain, the *before*-clause can still use the Absolute Future System instead of the Pseudo-*t*₀-System – see section (f) below:

It will be some time before the others {arrive / *will arrive*}.

[If they return they may try out for the rank again,] but it *will take* a week before they *will be allowed* to hold rank. (www)

When he calls the towing service, he is told it *will be* three hours before they *will arrive*. (www)

- (c) A third case in which a *before*-clause can (and this time has to) use the future tense is illustrated by the following:

[Safe housing near campus is limited.] The best housing is reserved by local students weeks before you *will arrive*. (www)

This is interpreted as ‘You will arrive at a date by which the best housing is (every year) already reserved by local students.’ The use of the future tense in the *before*-clause is again due to the fact that the *before*-clause has to express post-present time reference because the head clause does not explicitly establish a post-present domain. This time the head clause cannot be interpreted as doing so implicitly – it refers to a habitual present situation – so that the present tense (as Pseudo-*t*₀-System form) is not available as an alternative. The sentence

The best housing is reserved by local students weeks before you *arrive*.

invites a quite different interpretation, in which the *you* is impersonal and both verbs have habitual present meaning. It might also be acceptable if *arrive* expresses an ‘arranged future’ meaning (see 3.6) and in doing so establishes a post-present domain.

- (d) A fourth possibility for *will* to appear in a *before*-clause is when the latter is not really a time-specifying adverbial clause but expresses the same meaning as *than help her* does in *I’d rather die than help her*:

I'll die before I'll *help* her! (*This is a dramatic way of saying that the speaker is determined not to do what is mentioned in the before-clause.*)

As a matter of fact, in this type of *before*-clause the speaker can choose between 'will + infinitive' and the present tense (as Pseudo-t₀-System form):

She'll die before she'll *tell* you anything. (www)

She'll die before she *tells* you anything. (www)

I'll sink before I'll *surrender*. (www)

[Louisiana has one woman on death row, Antoinette Frank, and the warden says, no, he just couldn't execute a woman,] that he'll quit before he *does* that. (www)

[These rubies are worth a Sultan's treasury.] I'll die before I'll *put* them *back*. (www)

I'll die before I *use* 'they' as a singular pronoun. (www)

I'll emigrate before I'll *pay* more rent. (www)

I know his line: he'll die before he'll *take* advice. (www)

She'll die before she *gives* you any information. (www)

["Tell me your father's reply."] – "He'll see you burn before he'll *give* you anything!" (www)

However, it should be noted that if *will* is used, it is quite probably the modal auxiliary *will* expressing willingness rather than the future tense auxiliary *will*. Pieces of evidence supporting this are the fact that the *before*-clauses, though affirmative in form, all express a refusal and the fact that we have not found similar examples with *before I shall ...*:

- (e) Fifthly, examples can be found of *before*-clauses using *will* in code (i. e. *will* is a pro-form for a verb form mentioned before):

As to why I said I was going to be her matron of honor, I will be saying my vows before she *will*, so I will technically [sic] be married before she *will*. (www)

All of the eyes will be on Se Ri and whoever is leading, but I will be playing the holes before they *will* and I think that is a good thing. (www)

Tell Steve hello for him! He will be seeing Steve again before I *will* on June 5th The Crossroads Guitar Festival. (www)

In such examples *will* can be replaced by a Pseudo-t₀-form, viz. a present tense form of *do*.

I will be playing the holes before they *do*.

- (f) The future tense can easily be found (as an alternative to the present tense) in *before*-clauses depending on a head clause measuring the interval between t₀ and the post-present actualization of the *before*-clause situation:

[Once the cows are able to return home, Zeman said] it will be six months before they *will be* able to produce their normal milk supply. (www)

Generally, it will only take minutes before you *will receive* this email, [but delivery could be delayed by circumstances beyond our control]. (www)

[Researchers are developing a vaccine but] it will take some time before it *will be* ready for human use. (www)

[What this means for me is that] I will have until around September before I *will need* to find my own place. (www)

It will be another week before you *will be* able to return to full physical activity. (www)

In all these examples the Pseudo- t_0 -System can be used in the *before*-clause as an alternative to the Absolute Future System.

(g) The following is similar, except that the period measured does not start from t_0 .

He will be 46 years old before he *will be* eligible for parole. (www)

14.5.3 In 14.5.1 and 14.5.2 we have discussed the cases in which both the head clause and the *before*-clause use an absolute past tense or an absolute future tense, respectively. Let us now concentrate on the present perfect.

At first sight it would seem that there is no possibility of using the present perfect in both the head clause and the *before*-clause, because the presence of a time-specifying adverbial as a rule prevents the use of the present perfect in the head clause: we cannot normally use the present perfect to refer to a (single) bygone situation if the temporal location of that situation is specified by a time-specifying adverbial (such as an adverbial *before* clause). Thus, with reference to a single occasion, we cannot replace *Bill left before the match ended* by any of the following:

- *Bill has left before the match ended.
- *Bill has left before the match has ended.
- *Bill left before the match has ended.

However, there are some cases in which the present perfect *is* used both in the head clause and in the *before*-clause.

(a) A sentence like

Bill has left before John has arrived.

is fine if it means 'It has happened on occasion that Bill has left before John has arrived'. This is similar to the use of *I HAVE got up at three!* (discussed in 5.11.1), which is fine in contexts like the following:

["I got up at three this morning. You've never done that in your life." – "You're mistaken."] I HAVE got up at three. [Several times.]

As noted in 5.11.1, *at three* does not indicate an Adv-time which contains the situation time but belongs to the description of the situation itself: ‘The situation of getting up at 3 a.m. has actualized on occasion’.

- (b) *Bill has left before John has arrived* is also impeccable if it is the ‘Special Present Time-sphere System’ version of *Bill had left before John had arrived* (discussed in 14.7). As noted in 3.2–10, this substitution of present time-sphere tenses for past time-sphere tenses is possible in stretches of ‘historic present’, stage directions, summaries, captions, etc. The following are attested examples:

[As it passes from Her hands into mine the crystal again becomes water which, along with minerals and jewels, slip through my fingers and flow back into being the ocean. I bring my hand down to the surface and lift my fingers to my lips. I suck in the water and] before I *have finished* swallowing, it *has become* part of me, absorbed into my body as if ... (www) (*historic present*)

[We see a family with a seemingly over-protective mom.] Before *we’ve blinked*, big sis *has rebelled* and *left*, [bequeathing her record collection to little brother who’s only just found out he’s actually a year younger than he believed.] (www) (*from the summary of a film*)

[I remove as much as I can with a net, but] almost before I’ve turned around it *has reproduced* itself again in even greater quantities. (www) (*historic present*)

[The basic concept is so much more like the punch-line of a bad joke than the premise for a three act drama that I wasn’t at all sure what to expect from this play. In retrospect I suppose this is the point.] Before *we’ve even begun*, Manfredi *has taken* us out of the realm of what-we-take-seriously. [We are given no framework of normality by which to measure the comic, and grotesque, or the plain abnormal. There is nothing, in fact, to tell us what, and what not, to laugh at.] (www)

- (c) As noted in 9.15, absolute tenses are used to refer to subsituations that form part of a present repetitive habit. The following sentence uses the present perfect (as indefinite perfect) in both its clauses because each subsituation of the present habitual hypersituation is represented as belonging to a pre-present period:

As a rule the janitor *has unlocked* the front door before the first employees *have arrived*.

- (d) In 14.6.5 it will be noted that *before*-clauses can use a perfect tense to underline their ‘not-yet-factual’ meaning, i. e. to focus on the fact that the situation of the *before*-clause has not yet actualized when the situation of the head clause actualizes. We have already discussed some examples in 14.4.2, but these were examples with the past perfect in the *before*-clause. However, the same phenomenon can be observed in the present time-

sphere. In that case the message may be ‘X has already actualized, though Y is not actualizing yet’. This is expressed as ‘X *has Verb-ed before* Y {Verb-s / *is Verb-ing*}’:

(from a text about ‘England’s little rainforest’) But before anyone *has* a chance to protect it, one of deputy prime minister John Prescott’s new development quangoes *has bought* it and *received* outline planning permission to destroy the most important bit as part of the Thames Gateway expansion of London. (www)

In most cases, however, the message is ‘X has already actualized, though Y has not actualized yet’. This is expressed as ‘X *has Verb-ed before* Y *has Verb-ed*’. The reference may be to an individual occasion as well as to a habit. For example:

The Bush campaign also *has begun* defining Kerry before he *has defined* himself. (www)

[It really bothers me when people act as if] someone *has been proven* guilty before they’ve even *gone* to trial. (www)

However, even before it *has been released*, it *has* already *become* (as I write) a finalist for the Microsoft TechEd Europe 2004 (Amsterdam) Best of Show awards. (www)

[... oh and it’s proven that the Bible is true.] The Bible *has predicted* things way before they’ve ever *happened*. [Oh ya, it’s been proven – scientifically.] (www)

[She goes out of her way to anticipate what might be needed and] in almost every circumstance, before you’ve *asked*, Charles Ebb *has made* it happen. (www)

But even before Christmas *has arrived*, Cadbury *has begun* thinking about the key Easter period, [and it is already preparing the re-launch of its perennial UK favourite, the Cadbury’s Creme Egg.] (www)

[Naturally, it becomes difficult for the mystic to live in the world where his language is not understood, while he understands the language of all others.] Before we *have spoken* to the mystic he *has heard* us speak. Before we *have expressed* our thought he *has read* it. Before we *have expressed* our feeling he *has felt* it. [That is why a mystic can be in communication with another person better than one could ever imagine ...] (www)

Before we’ve *had* time to turn round he’s *given* himself carte blanche to come poking about in our cistern whenever he feels like it. (CRES)

Blessed is the one who *has won* the contest before it *has even begun*! (www)

14.5.4 In 14.5.1, 14.5.2 and 14.5.3 we have discussed the cases in which both the head clause and the *before*-clause use an absolute past tense, an absolute future tense or an absolute present perfect, respectively. Let us now concentrate on the present tense. A sentence in which both the head clause and the *before*-clause use the present tense (as absolute tense) can be grammatical in the ‘Special Present Time-sphere System’ (see 3.2–10), e. g. as a stage direction, in a summary or as an instance of the historic present:

Bill *waits* a couple of seconds before he *answers*.

Such a sentence is also grammatical on a habitual present interpretation:

When you ask him a question, Bill *waits* a couple of seconds before he *answers*.

We have not found any other kinds of sentence in which the head clause and the *before*-clause both use the present tense as absolute tense. Sentences like the following only ostensibly form another type:

I *am* just *checking* the oil before we *take off*.

In this case the present tense form in the *before*-clause is not an absolute tense form but a Pseudo- t_0 -System form. (If it were an absolute tense form, it would have to be an instance of a present tense representing an ‘arranged future’ – see 3.8–9 – but in that case the form *are taking off* would have to be possible too, which is not the case.) Even though there is a shift of domain here from a present domain to a post-present one, the *before*-clause cannot use the Absolute Future System (*will take off*): it has to use a present tense form (as Pseudo- t_0 -System form). This means that the situation time of the *before*-clause cannot be the central orientation time of the post-present domain but must be represented as T-simultaneous with the Anchor time, which functions as implicit central orientation time of the domain. (The interpretation of this Anchor time as lying in the post-present is due to the use of *before* in combination with a head clause in the present tense.)

14.5.5 In sections 14.5.1–4 we have checked whether it is possible for the head clause and the *before*-clause to use the same absolute tense. Using different absolute tenses as a rule appears to be impossible:

Gordon *left* before the Robinsons {*arrived* / **will arrive* / **arrive* / **have arrived*}.

There are only a couple of exceptions to this rule. One is when the sentence is used to express the not-yet-factual reading ‘[X has already actualized, though] Y is not actualizing yet’, as in *But before anyone has a chance to protect it, one of deputy prime minister John Prescott’s new development quangoes has bought it* – see 14.5.3. Another concerns the Special Present Time-sphere System:

Gordon *has left* before the Robinsons *arrive*. (only acceptable in the Special Present Time-sphere System if the *before*-clause is understood as referring to t_0 , or when the sentence means ‘it has happened on occasion ...’.)

14.5.6 In conclusion, apart from instances of the ‘Special Present Time-sphere System’, a couple of exceptional uses of the future tense in *before*-clauses referring to the post-present (see 14.5.2) and the use of the present perfect in not-yet-factual *before*-clauses (see 14.5.3), the only case in which both the *before*-clause and the head clause can use an absolute tense is when both use the

absolute preterite, as in *Bill arrived before I did*. In that case both situations referred to are represented as t_0 -factual. Neither clause uses a tense relating its situation time to the situation time of the other clause, because both establish a past domain of their own. However, the temporal W-relation between the situation times is indicated by *before* – see Figure 14.4 in section 14.4.1.

14.6 Absolute tense in the head clause and relative tense in the *before*-clause

14.6.1 In 14.5 we have discussed the possibilities of using an absolute tense in both the head clause and the *before*-clause in cases where the latter functions as a situation-time adverbial (i. e. if the *before*-clause establishes an Adv-time which contains the situation time of the head clause). In the present section we consider structures with a *before*-clause used as a situation-time adverbial in which the head clause uses an absolute tense while the *before*-clause uses a relative one.

14.6.2 Sometimes when the head clause uses an absolute tense, or is an infinitive clause forming part of a head clause using an absolute tense, the *before*-clause functioning as situation-time adverbial can show temporal subordination. There are two important conditions for this. First, the head clause has to form part of an intensional (opaque) context or establish one (for example, by the use of the future tense – see 8.24.3). Secondly, the situation time of the *before*-clause must be T-related to the implicit Anchor time and not to the situation time of the head clause. The following are some examples, which show that the relation between the situation time of the *before*-clause and the Anchor time may be that of T-simultaneity or T-anteriority, but hardly T-posteriority. (Note that the *before*-clause is meant to specify the time of the speaking, not the time of the wanting to speak.)

I wanted to speak to Mary before she *moved* into her new flat.

I wanted to speak to Mary before she *had moved* into her new flat.

?I wanted to speak to Mary before she *was going to move* into her new flat. (*This is hardly acceptable as a means of saying 'I wanted to speak to Mary before the time when she was going to move into her new flat'.*)

It should be noted that in none of these examples is the posteriority relation implied by *before* expressed by the tense form. Sentences in which the tense form does express this relation are ungrammatical:

*I wanted to speak to Mary before she *would move* into her new flat.

*I wanted to speak to Mary before she *would have moved* into her new flat.

*I wanted to speak to Mary before she *would be going to move* into her new flat.

These sentences are ungrammatical because the situation time of the *before*-clause is T-related to the situation time of the head clause rather than to the Anchor time. This kind of indirect binding is not allowed in *before*-clauses. (However, it is pointed out in 14.4.4 that, in archaic English, *should* can be found in the *before*-clause of such sentences. This is in keeping with our claim that in *I wanted to speak to Mary before she moved into her new flat* the form *moved* is a relative tense form, expressing simultaneity with the Anchor time, and not an absolute tense form.)

The following are similar examples in which the intensional domain is established by the future tense form in the head clause itself:

I will speak to Mary before she {*moves* / **will move*} into her new flat.

I will speak to Mary before she {*has moved* / **will have moved*} into her new flat.

I will speak to Mary before she {*is going to move* / **will be going to move*} into her new flat.

14.6.3 In *I wanted to speak to Mary before she had moved into her new flat* and *I will speak to Mary before she has moved into her new flat*, the reason why the speaker chooses to express T-anteriority in the *before*-clause is that he wants to refer to the resultant state produced by the *before*-clause situation rather than to the situation itself. In addition, the choice of a perfect tense form promotes a not-yet-factual reading (see 14.6.5 below).

In other sentences the reason for expressing T-anteriority may be that the speaker wants to convey a continuative reading of the *before*-clause, i. e. that he wants to represent the *before*-clause situation as continuing at (and possibly beyond) the Anchor time:

Mary wanted to move into the flat before she *had been* pregnant for longer than five months.

Mary will move into the flat before she *has been* pregnant for longer than five months.

Note that in examples like these, ‘before X’ means ‘before the Anchor time’, i. e. ‘before the temporal point when the *before*-clause situation has lasted for five months’, and not ‘before the beginning of the *before*-clause situation’.

14.6.4 The analysis (in terms of an implicit Anchor time) proposed here accords with the observation that in many cases we can substitute *by the time that* for *before* without changing the tenses. There is little difference of meaning between the following sentences:

Mary intends to be married before she moves into her new flat.

Mary intends to be married by the time she moves into her new flat.

In the phrase *by the time that*, the NP *the time* makes explicit the Anchor time which remains implicit when we use the conjunction *before* (= ‘before the time

that'). In the second example, the Pseudo- t_0 -System form *moves* clearly relates the situation time of the *that*-clause to *the time*, not to the situation time of the head clause. The fact that *before*-clauses use exactly the same verb form therefore confirms our hypothesis that the same temporal relation is expressed.

14.6.5 One of the consequences of relating the situation time of the *before*-clause to the implicit Anchor time (rather than using an absolute tense form) is that the *before*-clause situation is not represented as being a fact at t_0 . The only element of interpretation is that the *before*-clause situation is something which was (or is) expected to take place at some time later than the head clause situation, which means that the *before*-clause situation is represented as **NOT-YET-FACTUAL** (i. e. as 'still nonfactual at the situation time of the head clause' – see 14.4.2), i. e. that the *before*-clause situation has not yet actualized at the time of the head clause situation.

- (4a) Bill intends to go home before the play is over.
 (4b) I want to leave before the police {arrive / have arrived}.
 (4c) The thief will run away before the police {arrive / have arrived}.

In (4a–b) the head clause forms part of an intensional domain; in (4c) it creates the intensional domain itself by using the future tense (which creates an intensional world – see 8.24.3). In each case the *before*-clause locates its situation time in the temporal domain established by the head clause because it is to be interpreted as part of the intensional domain – see 10.4.6. It does so by relating the situation time of the *before*-clause to the Anchor time. In (4b) and (4c), *arrive* and *have arrived* express T-simultaneity and T-anteriority, respectively. In the latter case the speaker is more concerned with the state resulting from the arrival than with the arrival itself. The result is anyhow a not-yet-factual reading: 'A before B' is interpreted as 'A when not yet B'. Thus (4b) can be paraphrased as follows: 'I want to leave at a time when the police {do not arrive / have not arrived (= are not there)} yet'. The sense of not-yet-factuality is stronger when *have arrived* is used than when simultaneity is expressed. At least, while *I want to leave before the police arrive* strongly implies that I expect the police to arrive, *I want to leave before the police have arrived* tends to draw the hearer's attention away from this implication. That is, with dynamic verbs, expressing T-anteriority instead of T-simultaneity is a conventional device to abstract away from the expected actualization and bring not-yet-factuality into focus.

14.6.6 The not-yet-factual reading 'The *before*-clause situation is not yet a fact at the situation time of the head clause' can also be expressed in non-intensional contexts:

Mary recognized the visitor before he *had entered* the house.

Mary recognized the visitor before he *was* in the house.

[When the men started fighting] Bill hurriedly left the pub before the police *arrived*.

The first two examples receive the same interpretations (respectively) as the following:

Mary recognized the visitor, and when she did he had not yet entered the house.

Mary recognized the visitor, and when she did he was not yet in the house.

The third example is ambiguous between a t_0 -factual and a purely not-yet-factual reading of the *before*-clause. In the former case the speaker is taken to assert that the police arrived. In the latter case there is an implicit intensional domain, viz. a world of expectation, and the *before*-clause explains why Bill left *hurriedly*: he left in a hurry because he expected the police to arrive soon and wanted to have left before that. The use of *hurriedly* thus promotes the not-yet-factual interpretation: 'A before B' means 'A at a time when not yet B'. Whether A did or did not actualize after A is left vague, it is irrelevant to the truth of the sentence (on the purely not-yet-factual interpretation) whether the police actually arrived or not.

Because sentences like the above three leave it vague whether the situation of the not-yet-factual *before*-clause eventually actualized or not, they can occur in a context making it clear that the situation did not actualize at all, as in the first two examples below, or did eventually actualize, as in the third example:

I saw him before he *had seen* me. So I had time to conceal myself.

The letter was destroyed before I *had read* it.

He read the paper before I *had read* it. I did not read it until I was back from work.

In these examples it is the linguistic context that makes it clear whether the *before*-clause situation ever actualized or not. The purely not-yet-factual *before*-clause itself does not tell us anything about this. It just represents its situation time as T-anterior to the Anchor time, which is itself interpreted as W-posterior to the situation time of the head clause (because this is the contained orientation time included in the Adv-time and preceding the Anchor time). It follows that the *before*-clause situation is interpreted as still nonfactual at the situation time of the head clause.

14.6.7 Apart from the context, pragmatic knowledge can also induce a factual or counterfactual reading of the not-yet-factual *before*-clause. Thus, out of context, the not-yet-factual *before*-clause of the first example below is interpreted as counterfactual, whereas that of the second is not:

The sergeant removed the fuse before the bomb exploded.

The sergeant took off his helmet before the bomb exploded.

The interpretation of such sentences happens in accordance with the following pragmatic principle:

When both the head clause and the not-yet-factual *before*-clause are in the past tense, the *before*-clause is given a counterfactual interpretation if the head clause situation is represented as t_0 -factual and its actualization is seen as a necessary and sufficient condition to prevent the *before*-clause situation from actualizing.

In other words, *The sergeant removed the fuse before the bomb exploded* yields a counterfactual interpretation because the following conditional is pragmatically plausible:

If the sergeant had not removed the fuse, the bomb would have exploded (later).

By contrast, *The sergeant took off his helmet before the bomb exploded* does not yield a counterfactual interpretation because the following conditional is not plausible:

If the sergeant had not taken off his helmet, the bomb would have exploded (later).

The above pragmatic principle is only one of a pair. The second is the following:

A not-yet-factual adverbial *before*-clause in the past tense receives a t_0 -factual interpretation if the head clause situation is represented as t_0 -factual and its actualization is seen as a necessary and sufficient condition for the *before*-clause situation to actualize.

In accordance with this principle, the *before*-clauses in the following examples are interpreted as t_0 -factual:

We had to bribe the secretary before we were accepted as members of the club.

They had had to kill him before they could get at his money.

This type of sentence is special in that the head clause expresses necessity and does not allow the insertion of a measure phrase (e. g. *long*) before the *before*-clause. As a rule, t_0 -factual *before*-clauses do allow such an insertion – see 14.6.13. The fact that a measure phrase is not allowed here suggests that the *before*-clause is not primarily interpreted as a time adverbial but rather as a conditional clause. (This would mean that the idea of temporal precedence has been metaphorically extended to the idea of logical precedence: the head clause and the *before*-clause express something like condition and consequent, or cause and effect.)

14.6.8 When the *before*-clause represents its situation as nonstatic (= dynamic) and is interpreted as t_0 -counterfactual for pragmatic reasons (and not

because of the verb form) – see 14.6.7 – it can use a verb form expressing simultaneity or a verb form expressing anteriority:⁷

- (5a) The letter was destroyed before I *read* it.
 (5b) The letter was destroyed before I *had read* it.

Actually, there is a double difference of meaning between such sentences. To begin with, (5a) is only possible if it means ‘The letter was destroyed *as a precaution against my reading it*’. This aspect of interpretation is not conveyed by (5b), which has an extensional *before*-clause rather than an intensional one. The second meaning difference between (5a) and (5b) is brought out by the following paraphrases:

- (a’) The letter was destroyed before the time when it would have been the case that I read it (if it had not been destroyed).
 (b’) The letter was destroyed before the time when it would have been the case that I had (already) read it (if it had not been destroyed).

In other words, the destruction of the letter is located before the (imaginary) time of my reading it in (5a) and before the (equally imaginary) time of my already having read it in (5b). However, this difference of meaning is blurred by the fact that the *before*-clause situation is anyhow interpreted as counterfactual: if there is no actualization, then there is neither a time at which the situation actualizes nor a time at which it has already actualized. Still, there is a reason why even in this case the past perfect is often used instead of the preterite: the past tense by itself suggests a t_0 -factual reading, and it takes considerable processing effort on the part of the hearer to conclude that this t_0 -factual reading does not fit in with the context, which requires a t_0 -counterfactual reading. The past perfect, by contrast, brings the not-yet-factual reading into focus (see 14.6.5 above); it is a small step from ‘not-yet-factual at t' ’ to ‘not-yet-factual at t_0 ’, and an easy further step to ‘counterfactual at t_0 ’ if such a reading is imposed by the context.

14.6.9 When the *before*-clause uses a stative verb and is interpreted as t_0 -counterfactual for pragmatic reasons and not because of the verb form (because this is not a conditional perfect form), there is a difference of meaning between a verb form expressing T-simultaneity and one expressing T-anteriority. Whereas the first two of the following examples (with a nonstative verb) only show the two meaning differences discussed in the previous section (in connection with (5a–b)), the latter two clearly yield different not-yet-factual interpretations:

7. In this case the Adv-time-bounding orientation time is interpreted as the time when the *before*-clause situation would have actualized if it had not been prevented by the actualization of the head clause situation.

²The company closed down before John *finished* his apprenticeship. (*Unlike (5a), this sentence is questionable because its natural interpretation – ‘The company closed down as a precaution against John’s finishing his apprenticeship’ – is pragmatically unlikely.*)

The company closed down before John *had finished* his apprenticeship.

The company closed down before John *felt* at home in the job.

The company closed down before John *had* (ever) *felt* at home in the job. (*Had felt is interpreted as a ‘perfect of experience’ – see 5.16.1: the before-clause means ‘before John had ever had the experience of feeling at home in his job’.*)

This difference results from the fact that in a *before*-clause, the past perfect of a stative verb (e.g. *had felt*) can only receive a ‘perfect of experience’ reading (see 5.13.1), whereas the past perfect of a nonstative verb (e.g. *had finished*) invites a resultative reading.

14.6.10 When the context or our shared pragmatic knowledge of the world does not induce a t_0 -factual or t_0 -counterfactual interpretation, the interpretation of a *before*-clause with a nonstative VP will be as follows. Other things being equal, a past perfect will be interpreted as explicitly representing the situation as not-yet-factual, whereas a past tense will be interpreted as representing the situation as t_0 -factual. Thus, *John read the letter before I had read it* merely expresses that I had not (yet) read the letter when John read it; it does not say anything about whether or not I did read it afterwards. By contrast, *John read the letter before I read it* suggests that I did read the letter, but only after John had read it first.

In a post-present domain, there is a similar difference of interpretation between a present tense in the *before*-clause and a present perfect (of a nonstative verb): in *John will read the letter before Mary has read it*, the *before*-clause is interpreted as not-yet-factual, i.e. as expressing no more than that John will read the letter at a time when Mary has not read it yet. By contrast, *John will read the letter before Mary reads it* suggests that Mary too will read the letter, but only after John has done so. (This implicature can be overridden by the pragmatics of the context, as in *Mary will catch John before he hits the floor.*)

In sum, when the verb of the *before*-clause is nonstative and neither the context nor pragmatic knowledge induces a t_0 -factual or t_0 -counterfactual interpretation, the *before*-clause uses a tense form expressing T-simultaneity with the Anchor time to suggest a factual interpretation and a form expressing T-anteriority to emphasize the not-yet-factual interpretation without suggesting a factual or counterfactual reading.

When the anteriority form is used, the distance between the Anchor time (to which the situation time of the *before*-clause is represented as T-anterior) and the situation time of the *before*-clause is felt to be minimal: the Anchor time lies right after the terminal point of the situation of the *before*-clause.

Because of this, the Anchor time is felt to be the time when the state immediately resulting from the *before*-clause situation is holding. Thus, *John left before Bill had gone inside* is normally interpreted as ‘John left before Bill was inside’. However, apart from this ‘immediate result reading’, the sentence may also allow a ‘perfect of experience’ interpretation: ‘John left before Bill had ever been inside’. This is, however, not the unmarked interpretation. It comes to the fore only if a word like *ever* is added to the *before*-clause: *John went in before Bill had ever gone inside*.

14.6.11 Summarizing sections 14.6.5–10, we can say that (out of context) the intended reading of the *before*-clause determines the choice of tense (past tense or past perfect) in the *before*-clause in the following ways:

- (a) Only the past tense can suggest a t_0 -factual reading.
- (b) Only the past perfect can express the combination of a not-yet-factual reading and a perfect of experience reading.
- (c) The combination of a not-yet-factual reading and an immediate result reading can only be expressed by the past tense if the verb phrase is stative and by the past perfect if the verb phrase is nonstative (dynamic).

It follows that (out of context)⁸ a past tense in a *before*-clause automatically receives a t_0 -factual reading (under the conditions specified, i. e. when neither the context nor pragmatic knowledge enforces a particular reading) when the verb is nonstative, but not when it is stative.

14.6.12 The use of the past perfect in a nonstative *before*-clause does not trigger a not-yet-factual reading if *before* is immediately preceded by a negator:

[When I repulsed him he attempted to rape me.] I fought him off but *not before* he'd *stolen* my handbag and several articles of clothing. (WTBS)

He came to see me at five every day, but *never before* he'd *called* on his Mum first.

These examples show that, if the head clause is t_0 -factual, the use of *not before* or *never before* anyhow triggers a t_0 -factual reading of the *before*-clause. The reason is that *not before* and *never before* are interpreted as ‘only after’ and ‘always after’, respectively:

I fought him off, but {not before / only after} he'd stolen my handbag.

He came to see me at five every day, but {never before / always after} he'd called on his Mum first.

As pointed out in 14.19.1, *after*-clauses in the past perfect are always t_0 -factual if they depend on a t_0 -factual head clause.

8. The *before*-clause can never be interpreted as t_0 -factual if it forms part of an intensional context – see 14.4.2.

14.6.13 If the head clause is t_0 -factual, the addition of a measure phrase to the *before*-clause enforces a t_0 -factual interpretation of this clause, irrespective of whether it uses the past tense or the past perfect:

I read the letter *long* before Bill destroyed it.

I read the letter *long* before Bill had destroyed it.

In the latter example the measure phrase indicates the temporal distance between the situation time of the head clause and the implicit Anchor time to which the situation time of the *before*-clause is T-anterior. In both examples, the measure phrase *long* triggers a t_0 -factual interpretation of the *before*-clause (without cancelling the not-yet-factual reading, i. e. the idea that the *before*-clause situation was not yet factual at the time of the head clause situation). The t_0 -factual interpretation follows from the fact that it is difficult to measure the distance between a t_0 -factual situation and a situation which is not t_0 -factual but virtual. (See, however, the next section.)

14.6.14 The only case in which a measure phrase indicates the distance between a t_0 -factual situation and a virtual one is when the *before*-clause is t_0 -counterfactual. This meaning can only be expressed by the conditional perfect:

Max removed the fuse from the bomb thirty-seven seconds before it *would have exploded*.

We drove off the public car park a short time before an attendant *would have given* us a ticket.

With one year before he *would have graduated*, he left Transylvania, accepting an appointment at the Military Academy at West Point. (www)

Note that the conditional perfect is used here as a modal form (rather than as a tense form expressing temporal relations only). Its use is made possible by the fact that the *before*-clause implies a counterfactual condition:

Max removed the fuse from the bomb thirty-seven seconds before it would have exploded (if the fuse had not been removed).

We drove off the public car park a short time before an attendant checking the cars would have given us a ticket (if we had had left our car parked there).

Team members testified that from the initial indications of the fires being set, the Davidians had an estimated 20 to 25 minutes to safely exit the building before they *would have been overcome* by the smoke and heat. (www) (*implicit condition: 'if they had not left the building'*)

Like conditional *if*-clauses, temporal clauses can use the tense forms that are normally used in the head clause of a counterfactual conditional sentence if they are interpreted in terms of an overt or covert counterfactual condition.⁹

9. The following sentence illustrates this in connection with *if*-clauses: *If John would have succeeded [if he had tried], why should I not succeed?*

14.6.15 It should be clear from the preceding sections that if the *before*-clause (functioning as situation-time adverbial) uses the past perfect (which is a relative tense form) and the head clause uses the absolute past tense,¹⁰ there are three possibilities as far as the actualization of the *before*-clause situation is concerned.

- (a) Firstly, the *before*-clause situation, which is still nonfactual at the time of the head clause situation, may be interpreted as actualizing later.¹¹ In this case the head clause too must be t_0 -factual.

There was an explosion just before the fire started.

Because of its t_0 -factual interpretation, this type of *before*-clause can be preceded by a measure phrase (here, *just*).

- (b) Secondly, there are cases in which the *before*-clause situation does not actualize at all because its actualization is prevented by the actualization of the head clause situation. In this case the interpretation of the *before*-clause is t_0 -counterfactual. If the counterfactual reading is imposed by the pragmatics of the context, the *before*-clause can use either the past tense or the past perfect. If the counterfactual reading is not imposed by the pragmatics of the context, only the use of the conditional perfect can provoke the desired t_0 -counterfactual reading:

I took the milk off the fire before it *boiled over*. (t_0 -counterfactual for pragmatic reasons)

She burnt the letter before I *had read* it. (*idem*)

Bill resigned only a couple of days before we *would have fired* him.

Such sentences allow a measure phrase only if the *before*-clause uses the conditional perfect. (Conversely, the conditional perfect can only be used in this kind of sentence if there is a measure phrase.)¹² If the *before*-clause is in the condi-

10. Remember that in the present section – 14.6 – we are concerned with the possibilities of using an absolute tense in the head clause and a relative tense in the *before*-clause.

11. The fact that the *before*-clause situation is not yet a fact at the time that the head clause situation actualizes entails that even this kind of *before*-clause, whose situation is interpreted as actualizing later, allows the use of nonassertive words (negative polarity items):

He had to wait a long time before *anybody lifted a finger* to help him.

I had lived in the house for three years before I got acquainted with *any* of the neighbours. In examples like these, the use of nonassertive words stresses the idea that after the head clause situation actualized (or began to actualize) there was a long period during which the expected *before*-clause situation did not actualize.

12. We have found two examples in which there is no measure phrase:

President Bush thanked congress for shooting down the bill before HE **WOULD HAVE HAD TO VETO IT!!!** [Who do you really think is for the people?] (www)

I telephoned again early next morning before he *would have gone* to work. (BNC)

tional perfect, it functions like the head clause of a conditional sentence with a counterfactual conditional clause:

I drove my car out of the car-park five minutes before the attendant *would have given* me a fine. (*implicit condition: 'if I had left my car there'*)

- (c) Thirdly, it sometimes remains unclear whether or not the *before*-clause situation, which has not actualized yet at the time of the head clause situation, ever actualizes. In this case all that we know of the *before*-clause situation is that it is not-yet-factual at the time of the head clause situation. This type of *before*-clause does not allow the use of a measure phrase (e. g. *long*) in front of *before*.

I read the letter before Mary had read it.

Under this heading we must also mention the cases in which the head clause situation is performed in order to avoid something that is expected to be a consequence of the actualization of the *before*-clause situation, if that should become reality:¹³

Fred left the country before the capital fell into the hands of the guerrillas.

This sentence is ambiguous. The *before*-clause is read as *t₀* factual if the context shows that it is extensional, i. e. to be read from the current speaker's point of view. On the other hand, if the context shows that the *before*-clause is part of Fred's thinking at the time that he left the capital – i. e. if the *before*-clause is intensional and to be interpreted from a point of view that is not the current speaker's – then the sentence is vague as to whether the capital ever fell into the hands of the guerrillas, because it is future from a past point of view.

14.7 Relative tense in head clause and relative tense in *before*-clause

14.7.1 In 14.5 we have discussed the possibilities of using an absolute tense in both the head clause and the *before*-clause in sentences where the *before*-clause functions as a situation-time adverbial (i. e. if the *before*-clause establishes an Adv-time which contains the situation time of the head clause). In 14.6 we have examined structures with a *before*-clause (used as a situation-time adverbial) in which the head clause uses an absolute tense while the *before*-clause uses a relative one. In the present section we discuss sentences with a *before*-clause (used as a situation-time adverbial) in which both the head clause and the *before*-clause use a relative tense.

13. This kind of interpretation can be induced by the use of *any* in the *before*-clause:
I left before anybody came.

14.7.2 If a relative tense can be used in a *before*-clause functioning as situation-time adverbial and depending on a head clause with an absolute tense, as in the following (a) examples, a relative tense will also be possible in the *before*-clause of the corresponding sentence in which the head clause uses a relative tense, as in the following (b) examples:

- (6a) [I do not doubt that] I *will be* at home before it *begins* to rain.
 (6b) [I did not doubt that] I *would be* at home before it *began* to rain.
 (7a) [I feel sure] I *will be* at home before it *has started* to rain.
 (7b) [I felt sure] I *would be* at home before it *had started* to rain.
 (8a) [Bill is the first to know about the accident, because] he *has read* the paper before I *have read* it.
 (8b) [Bill was the first to know about the accident, because] he *had read* the paper before I *had read* it.
 (9a) [Bill was the first to know about the accident, because] he *read* the paper before I *had read* it.
 (9b) [Bill was the first to know about the accident, because] he *had read* the paper before I *had read* it.

As before, the *before*-clauses function as situation-time adverbials in these examples: the situation time of the head clause is contained in the Adv-time. The situation time of the *before*-clause is T-related to the implicit Anchor time. In (6b), the *before*-clause uses the preterite to express T-simultaneity, while in (7b) it uses the past perfect to express T-anteriority. In the latter case the speaker wants to refer to the state resulting from the situation rather than to the situation itself. In (8b) and (9b) the *before*-clause uses the past perfect to trigger an interpretation that is both not-yet-factual and not t_0 -factual. (If the preterite were used, it would be interpreted as an absolute preterite expressing a t_0 -factual meaning.) (Note that 'not t_0 -factual' here means that the situation may or may not actualize later. So it does not mean the same thing as t_0 -counterfactual.)

In each of the (b) examples, both clauses use a relative tense.¹⁴ The implications of the relative tense in these *before*-clauses are the same as those in the *before*-clauses of the corresponding (a) examples, which were discussed in 14.6. For example, the *before*-clause (which is by its very nature not-yet-factual at t)

14. There is no example with a relative past tense in the head clause because a head clause using a relative past tense form cannot normally support a *before*-clause referring to a not-yet-factual actualization. Compare:

I realized that he *recognized* me. (*The unmarked interpretation is for recognized to express simultaneity, i. e. to be a relative preterite.*)

I realized that he *recognized* me before he had recognized my friend. (*Recognized can hardly be interpreted as expressing T-simultaneity. Its normal interpretation is as an absolute preterite, establishing a past domain which is W-anterior to the domain established by realized.*)

is each time interpreted as t_0 -nonfactual (= as not t_0 -factual, as not referring to a situation that is treated as a past fact). In (6b) and (7b) this is due to the fact that the *before*-clause forms part of an intensional domain, whereas in (8b) and (9b) it is due to the use of the past perfect. (It is the past tense that would invite a t_0 -factual reading.) However, as shown by the examples discussed in 14.6, a t_0 -factual reading can be enforced (if the head clause is not intensional but t_0 -factual) by the presence of a measure phrase preceding the *before*-clause:

[Bill was the first to know about the accident, because] he had read the paper *long* before I had read it. (t_0 -factual reading of the *before*-clause)

However, a measure phrase does not induce a t_0 -factual reading if the head clause belongs to an intensional domain:

[I did not doubt that] I *would be* at home long before it *started* to rain. (No t_0 -factual reading of the *before*-clause because the head clause forms part of an intensional world. We cannot conclude from this sentence that the speaker actually got home nor that it actually started to rain long after he got home. A t_0 -factual interpretation requires that the situation is viewed from the speaker's t_0 , which is not the case if the clause describing the situation forms part of an intensional context.)

14.7.3 In some cases, both the head clause and the *before*-clause (functioning as a situation-time adverbial) use the past perfect. Let us go somewhat more fully into that possibility. Consider:

["John is a doctor. And I think Bill is a doctor too." – "Yes."] As a matter of fact Bill *was* a doctor before John *was* one."

Mary said that Bill *had been* a doctor before John *had been* a doctor.

We have already discussed the first example (in section 14.4.6) and come to the conclusion that both preterite forms are absolute tense forms. Because of this – see 8.25 – it is predictable that both can be 'backshifted' in represented speech and the second example shows that this prediction is borne out. Figures 14.5 and 14.6 represent the temporal structures of the two examples, respectively.

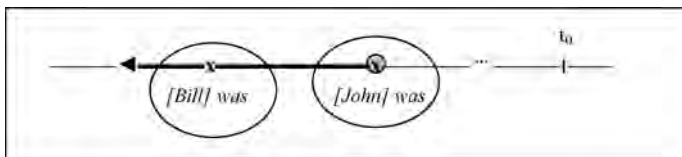

Figure 14.5. The temporal structure of *Bill was a doctor before John was one*.

The following is another example realizing the structure shown in Figure 14.6 (except that the central orientation time of the domain is now implicit):

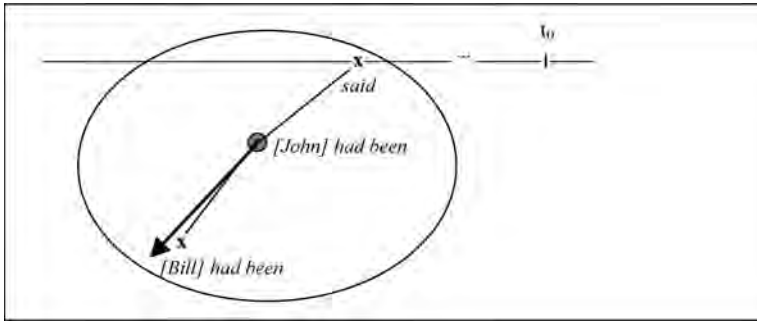

Figure 14.6. The temporal structure of *Mary said that Bill had been a doctor before John had been a doctor*.

Before he *had met* Barbara, Adam's sexual experience *had stopped* short at holding the sticky hands of convent girls in the cinema. (BM)

14.7.4 When the speaker uses the past perfect in the *before*-clause to underline the not-yet-factual reading, he may use an anteriority form in the head clause as a device to suggest that the head clause situation actualized earlier than might have been expected:

Before I had finished speaking, she *had already shut* the door in my face.

Instead of expressing 'Before the *before*-clause situation had actualized, the head clause situation did', the speaker expresses 'Before the *before*-clause situation had actualized, the head clause situation had already actualized'. In doing so he stresses that the head clause situation actualized sooner than might have been expected.

14.7.5 If the situation time of its head clause belongs to a past domain, a *before*-clause using the present tense as Pseudo- t_0 -System form indirectly establishes a post-present domain. This is only possible if the actualization of the *before*-clause situation is expected to be W-posterior to t_0 . In that case the *before*-clause can shift the domain to the post-present (more specifically, establish a post-present domain in an 'indirect' way – see 9.16):

Tina said that she would leave before Sol *returns*. (Comrie 1986: 296)

["Aren't the children too tiring for you? Isn't it time Carrie took them away?" – "Don't worry.] I asked Carrie just now if she would take them away before I *am* too tired [and said I'll give her a sign when I am]."

14.7.6 In the following examples, the two relative tenses are Pseudo- t_0 -System forms:

[For the moment he refuses every kind of treatment. I will be glad if] he *is* willing to go to hospital before he *is* half-dead.

I will be glad if my son *is* already *feeling* somewhat better before he *has attended* half of the prescribed therapy sessions.

[A patient admitted to hospital in pursuance of an application for admission for assessment may be detained for a period not exceeding 28 days beginning with the day on which he is admitted, but shall not be detained after the expiration of that period unless] before it *has expired* he *has become* liable to be detained by virtue of a subsequent application, order or direction under the following provisions of this Act. (www) (= '*unless he has become liable ... before it has expired*')

14.7.7 Another case in which both the head clause and the *before*-clause use a relative tense is illustrated by the following:

The thief *will have left* the building before the police {*arrive / have arrived*}.

This is special only in that the tense of the head clause is not a pure relative tense but an 'absolute-relative' one – see 2.47.

14.7.8 In section 14.5.2.(f), we have pointed out the existence of examples like the following:

It will be another week before you *will be* able to return to full physical activity. (www)

The past time-zone counterpart of such sentences uses two relative tense forms:

[People said that] without her humour and skill it *would have been* a long time before women *would have been given* the vote. (www)

14.7.9 A final case in which both clauses use a relative tense would seem to be exemplified by the following:

This hawk [had no chance of survival on its own, but] *would have suffered* for many days before death *would have come* from dehydration and starvation. (www)

It should be noted, however, that the conditional perfect is not used as a tense form here (expressing no more than temporal relations) but is used twice as a modal form expressing counterfactuality. This is not a type of sentence, then, in which both the head clause and the *before*-clause use a relative tense form.

14.8 Relative tense in head clause and absolute tense in *before*-clause

In 14.5 we have discussed the use of absolute tenses in both head clause and *before*-clause if the *before*-clause functions as a situation-time adverbial (i. e. if it establishes an Adv-time which contains the situation time of the head clause). In 14.6 and 14.7 we have considered structures of the type 'absolute tense in the head clause + relative tense in the *before*-clause' and 'relative tense in the

head clause + relative tense in the *before*-clause', respectively. In this section we will continue examining structures with a *before*-clause used as a situation-time adverbial, but this time we will focus on the cases in which the head clause uses a relative tense while the *before*-clause uses an absolute tense.

14.8.1 One kind of sentence which arguably combines a head clause in a relative tense and a *before*-clause (functioning as a situation-time adverbial) in an absolute tense is exemplified by sentences like *He had left before I arrived*, whose temporal structure could then be represented by Figure 14.7. On this analysis, the situation time of the head clause, which is T-anterior to the central orientation time of a past domain, is contained in the Adv-time established by *before*, whose Anchor time is the situation time of the *before*-clause, which functions as central orientation time of the domain. It follows that *arrived* is an absolute preterite form. (This is in keeping with what has been argued in 14.4.2–5.) This analysis correctly predicts that *before*-clause situation will be interpreted as t_0 -factual because the speaker locates it in the past by means of an absolute preterite. (The head clause situation is also interpreted as t_0 -factual, because what the speaker represents as anterior to a t_0 -factual situation is automatically also t_0 -factual.)

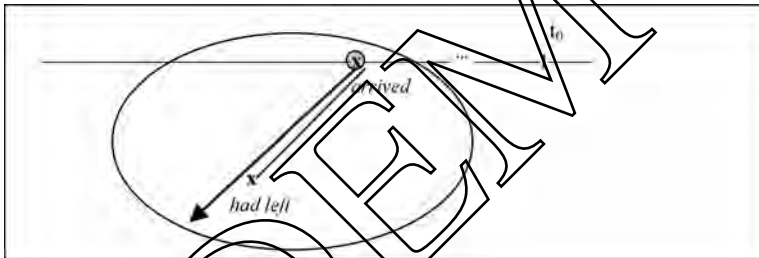

Figure 14.7. Temporal structure 1 of *He had left before I arrived*.

It should be noted, though, that *arrived* in *He had left before I arrived* can in theory also be analysed as a relative preterite, representing its situation time as T-simultaneous with the implicit Anchor time, which is interpreted as W-simultaneous with the (equally implicit) central orientation time of the past domain. This analysis is represented in Figure 14.8.

In what follows we will work with analysis 1. There is no clear evidence for or against either of the analyses, and which of them is assumed is irrelevant to interpretation, because T-simultaneity has been defined as strict coincidence (see 8.3), so that on both analyses the situation time of *arrived* coincides with the Anchor time. Because it is irrelevant to interpretation which of the two analyses we adopt, we may as well adopt the structurally simplest one, which is the analysis in which *arrived* is treated as an absolute preterite form.

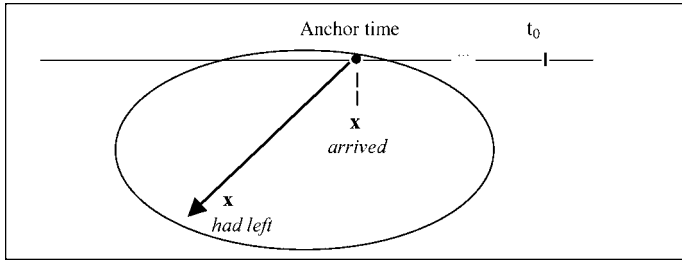

Figure 14.8. Temporal structure 2 of *He had left before I arrived*.

14.8.2 The analysis which we adopt is in keeping with the fact that the normal interpretation of *John had left before Bill arrived* is not (a) but (b):

- (a) At some time before Bill's arrival it was the case that John had [already] left.
- (b) At the time of Bill's arrival it was the case that John had [already] left.

There are two anteriority relations involved in (a): 'John's leaving was anterior to a time anterior to Bill's arrival'. The first anteriority relation is expressed by *had left*, the second by *before*. This complex temporal structure can be expressed in a grammatical sentence only if there are two adverbials measuring the length of the time spans corresponding with the two anteriority relations: *Three days before Bill arrived John had already left {a week earlier / for a week}*. As is clear from this paraphrase, the situation time of the head clause is T-anterior to the contained orientation time, which is interpreted as included in the Adv-time established by the *before*-clause. This implies that the *before*-clause is used as an orientation-time adverbial, the contained orientation time is not the situation time of the head clause but another orientation time to which the situation time of the head clause is T-anterior. Because the present section (viz. section 14) is concerned with *before*-clauses used as situation-time adverbials, we will not go into reading (a) any further here. It has been dealt with in section 14.10.3.

By contrast, there is only one anteriority relation expressed in (b), which paraphrases the normal interpretation of *John had left before Bill arrived*: 'John's leaving was anterior to Bill's arrival.' However, this anteriority relation is expressed twice, viz. both by *had left* and by *before*. This means that the contained orientation time (viz. the situation time of the head clause) is included in the Adv-time and, because it is punctual, does not reach up to the Anchor time. It follows that, as far as the temporal W-interpretation is concerned, there is little difference between (b) and the way we interpret the following:

John had left when Bill arrived. (= 'At the time of Bill's arrival, John had already left')

John left before Bill arrived. (= 'John left before the time of Bill's arrival')

The temporal structures of these sentences are represented in Figures 14.9 and 14.10.

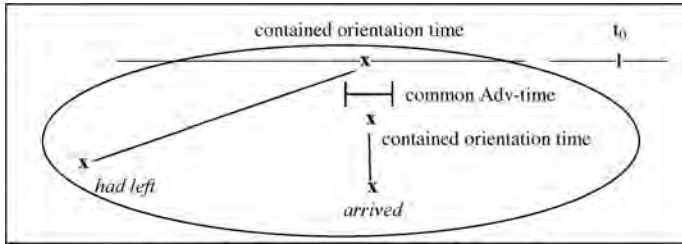

Figure 14.9. The temporal structure of *John had left when Bill arrived*.

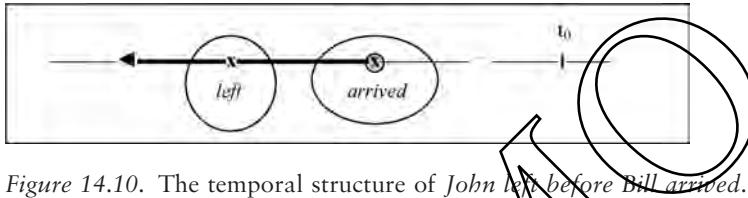

Figure 14.10. The temporal structure of *John left before Bill arrived*.

If we use *when* instead of *before*, the anteriority relation between John's leaving and Bill's arrival is expressed only once: by the past perfect *had left* in *John had left when Bill arrived*, and by *before* in *John left before Bill arrived*. The two constructions yield a slightly different interpretation. Whereas *John had left when Bill arrived* stresses the fact that John was no longer there when Bill arrived, *John left before Bill arrived* stresses the temporal order of the situations: 'A happened before B'. In other words, the use of the past perfect in *John had left when Bill arrived* suggests a resultative interpretation,¹⁵ whereas the use of *before* and two absolute past tense forms in *John left before Bill arrived* emphasizes the chronological order of the situations. When interpreted as 'At the time of Bill's arrival it was the case that John had (already) left', the sentence *John had left before Bill arrived* combines the past perfect of *John had left when Bill arrived* and the *before* of *John left before Bill arrived*. This has as a result that both aspects of meaning (resultativeness + emphasis on the

15. In examples like these, in which the W-anteriority relation is expressed twice, the past perfect may sometimes receive a continuative rather than resultative interpretation:

John had been in the house for several minutes before he heard someone approach.

In this case the use of the past perfect is obligatory in the head clause. The choice of *before* rather than *when* results in a certain emphasis on the idea of not-yet-factuality-at-t ('not yet B at A'), which might suggest that the *before*-clause situation actualized later than might have been expected.

chronological order) are present at the same time. As noted above, *John had left before Bill arrived* then arguably realizes the following temporal structure (= analysis 1) – see Figure 14.7 in section 14.8.1:

The situation time of the *before*-clause is the Anchor time and is the central orientation time of the past domain (established by *arrived*). The situation time of the head clause is the contained orientation time, and is represented (by *had left*) as T-anterior to the central orientation time.

14.8.3 When the reference is to the post-present, the *before*-clause has to use the Pseudo- t_0 -System. That is, the speaker has to use a construction in which the head clause indirectly establishes the post-present domain (by means of a future perfect, which represents the situation time of the head clause as anterior to the implicit central orientation time) and represent the situation time of the *before*-clause as T-simultaneous with the Anchor time (functioning as implicit central orientation time of the domain):

John {*will have left* / **has left*} before Bill {*arrives* / **will arrive*}. (*Has left* is meant to be read as a Pseudo- t_0 -System form.)

Gordon {*will have visited* / **has visited*} the cathedral before Bryan {*goes* / **will go*} to the town hall. (*similar*)

He *will have been living* there for a long time before everybody *accepts* him.

This is in keeping with the general rule that reference to the post-present in an adverbial time clause requires the use of the Pseudo- t_0 -System rather than the Absolute Future System – see 10.7.2.

14.9 Summary of section B

Sections 14.5–8 have made it clear that adverbial *before*-clauses functioning as situation-time adverbials basically allow three major tense configurations (apart from some others not repeated here). They are exemplified by the following sentences, which can all be used to describe the same state of affairs but are interpreted in subtly different ways:

Jim left before Bill arrived.

Jim left before Bill had arrived.

Jim had left before Bill arrived.

14.9.1 The first possibility is for the speaker to represent both situations as t_0 -factual by using two absolute past tense forms:

Jim *left* before Bill *arrived*.

In such sentences the speaker just reports that two situations actualized in a particular order. The head clause situation is not interpreted as continuative

and there is no resultative implication. The two absolute tense forms establish separate past domains. The temporal W-relation between the situation times is exclusively expressed by *before*. Both situations are interpreted as t_0 -factual, i. e. as past facts.

Because we cannot normally use the Absolute Future System in an adverbial *before*-clause, a similar use of two tense forms establishing separate domains is not possible if the reference is to the post-present:

Jim *will leave* before Bill {*leaves* / **will leave*}.

14.9.2 In the second possibility, illustrated by *Jim left before Bill had arrived*, the speaker represents the head clause situation as t_0 -factual (by using an absolute preterite) and represents the *before*-clause situation as not-yet-factual at the time of the head clause situation by using the past perfect. In doing so the speaker leaves it vague whether the *before*-clause situation eventually actualized (= became t_0 -factual) or not:

Jim left before Bill *had arrived*. (= 'Jim left; Bill *had not arrived* when Jim left')

The head clause is interpreted as t_0 -factual because it uses an absolute preterite. The situation time of the *before*-clause is represented as T-anterior to the Anchor time.

When the reference is to the post-present, the tense of the head clause also establishes the domain, but it is not interpreted as t_0 -factual, because the post-present is by definition not-yet-factual-at- t_0 .

Jim *will leave* before Bill *has arrived*. (*Has arrived* is a Pseudo- t_0 -System form expressing T-anteriority to the implicit Anchor time.)

14.9.3 The third possibility is for the speaker to represent the *before*-clause situation as t_0 -factual by means of the absolute past tense and to represent the head clause situation as t_0 -factual by representing its situation time as T-anterior to the central orientation time of the past domain:

Jim had left before Bill arrived.

He had been living there for many years before everyone accepted him.

When the reference is to the post-present, the head clause uses the future perfect to establish the domain and locate its situation time anterior to the central orientation time. The *before*-clause must represent its situation time as T-simultaneous with the implicit Anchor time, which is interpreted as coinciding with the central orientation time:

Jim will have left before Bill arrives. (*The before-clause uses the present tense as Pseudo- t_0 -System form. Its situation is expected to actualize but it is still nonfactual at t_0 .*)

He will have been living there for a long time before everybody accepts him. (*idem*)

C. The tense system if the *before*-clause is an orientation-time adverbial

14.10 Using a *before*-clause as orientation-time adverbial

14.10.1 A *before*-clause functions as an orientation-time adverbial when the Adv-time which it establishes specifies ('contains') an orientation time (from the tense structure of the head clause) other than the situation time of the head clause, in other words when the situation time of the head clause is not the contained orientation time but is represented as T-anterior or T-posterior to the contained orientation time.

14.10.2 As noted in 14.2.2, a *before*-clause can only exceptionally be used as an orientation-time adverbial. However, the following is an example in which the head clause represents its situation time as T-posterior to the contained orientation time:

[It is not only recently that John has been saying that he is going to retire.] He was already *going to retire* before he came to live here three years ago. (*free indirect speech*)

In this case the verb form expressing T-posteriority must be of the 'prospective' type: *was going to* is fine, but *would* is not. We have noted the same restriction on similar examples using a *when*-clause – see 13.8.2.

Reference to the post-present requires an absolute-relative form with *will be about to* (seldom: *will be going to*) in the head clause:

[I predict that] John *will already be about to go to bed* before we arrive at his house.

14.10.3 Consider also the following:

John had seen a doctor two days before he died.

Out of context, this sentence allows two interpretations. The default reading is that the situation time of the head clause is located two days before the situation time of the *before*-clause. This interpretation is much the same as that of *John saw a doctor two days before he died*. It implies that the W-anteriority relation 'The situation time of the head clause lies before the situation time of the *before*-clause' is expressed simultaneously by *before* and by the past perfect form *had been*. However, on this default reading, the *before*-clause is used as a situation-time adverbial rather than as an orientation-time adverbial. It is only on the secondary reading that the *before*-clause of the above example is taken to be an orientation-time adverbial: 'Two days before he died it was the case that John had already seen a doctor'. In fact, this reading only comes to the fore if the head clause involves *already* and/or follows the

before-clause. The function of the measure phrase is then to specify the distance between the contained orientation time of the head clause and the W-posterior Anchor time:

Two days before he died, John had (already) seen a doctor.

There are two anteriority relations involved here: 'John's seeing a doctor was anterior to a time anterior to his death'. The first anteriority relation is expressed by *had seen*, the second by *before*. This complex temporal structure can be made explicit by the use of adverbials measuring the length of the time spans corresponding with the two anteriority relations. Consider:

Two days before he died Bill had (already) seen a doctor a week earlier.

As is clear from this paraphrase, the situation time of the head clause is T-anterior to the contained orientation time: it lies a week before the latter. (The contained orientation time itself lies two days before the Anchor time, which is the time of Bill's death.) This means that the *before*-clause is used as an orientation-time adverbial: it does not contain the situation time of the head clause but another orientation time to which the situation time of the head clause is T-anterior.

Further examples:

Long before he had gone to a psychiatrist Bill had already attempted to commit suicide twice.

?*Long before he had gone to see a psychiatrist Bill was already going to commit suicide.*

Long before she was going to have her baby, Mary had already decided to put it up for adoption. (= on the interpretation 'Long before she was in labour ...')

The following are similar examples, but with reference to the post-present:

Two years before he is sixty-five Bill will already have been retired for exactly three months.

Two years before he is sixty-five Bill will already be going to retire.

In these examples, the head clause situation is T-anterior to an implicit orientation time contained in the Adv-time specified by the *before*-clause. That contained orientation time is said to lie two years before the implicit central orientation time of a post-present domain that is established by the absolute-relative tense form in the head clause (viz. *will have been retired* and *will be going to retire*). The situation time of the *before*-clause is represented as T-simultaneous with this implicit central orientation time by the Pseudo-t₀-System form *is*. The situation time of the head clause is represented as T-anterior or T-posterior to the implicit central orientation time.

D. Factual, not-yet-factual and counterfactual *before*-clauses

In sections 14.11 to 14.13 we review the factors (including the choice of tense) that induce a factual, counterfactual or not-yet-factual (respectively) reading of a *before*-clause.

In this section we will bring together in a systematic way the various observations about not-yet-factuality, factuality and counterfactuality that are scattered over the previous sections. We will also make some new observations.

14.11 Factual interpretations of *before*-clauses

14.11.1 In section 8.26.1 it was pointed out that a time-specifying adverbial cannot refer to t_0 on a single situation reading: **I am working at five o'clock* cannot be used to combine the ideas 'I am (now) working' and 'it's (now) 5 o'clock' in one clause. The same is true of **I am working before six o'clock*. Naturally, the restriction also applies to clauses functioning as time-specifying adverbials:

I am now working (*when it is 5 o'clock).

I am now working (*before it is 6 o'clock).

There are some exceptions to this rule, which we will point out first, so that they can be eliminated from the subsequent discussion that is based on the above rule.

- (a) Time-specifying adverbials can be used in sentences expressing a present habit:

I am always at work {at 5 o'clock / when it is 5 o'clock / before 5 o'clock / before it is 5 o'clock}.

She always checks the oil in the car before she sets off on a long journey.

- (b) Time-specifying adverbials can also combine with present tense forms that do not really refer to the present but form part of the 'Special Present Time-sphere System' (see 3.2–11), e. g. in historic speech, summaries, etc.

(*from the summary of a novel*) At eight p.m. John is still working, [though it's high time for him to go home.]

- (c) There is no problem either if the adverbial forms part of the description of the situation that is located at t_0 :

[You always say I'm never at work at 7 a.m. Well, I'm at work now, and it's precisely 7 a.m.] So I am working at 7 a.m. today.

See 5.11.1 for the discussion of a similar use of the present perfect with an adverbial like *at 7 p.m.*

- (d) The present tense can also combine with adverbial time clauses that have a nontemporal connotation.

["What are you doing?"] – "I'm cleaning the house after your friends have left."
(connotation: 'Your friends have made a mess of the house.')

["What are you doing?"] "You're watching TV when you should really be studying!" (contrastive connotation)

["What are you doing?"] – "I'm making up the beds before all the guests arrive."
(connotation: 'The imminent arrival of the guests gives me some extra work', or something similar)

How many foul balls can you hit before you are considered out? (www) (resultative connotation)

You're giving up before you've even tried! (BNC) (atemporal interpretation)

- (e) A head clause in the present tense can combine with a 'narrative' (see 13.1.3) *before*-clause. (As explained in 14.11.4, a narrative *before*-clause 'pushes forward the action' instead of establishing an Adv-time.)

[To have the house redecorated would be all right if it was our house,] but we are renting at the moment before we go back to Australia. (adapted from www)

However, barring the above exceptions (a)–(e), a *before*-clause cannot locate its situation time at t_0 . Barring the same exceptions, it cannot locate it in the pre-present either:

*I've been working before it is 5 o'clock (now). (continuative perfect reading)

*This painting has taken me three months before it is ready. (constitution reading)

Moreover, a *before*-clause in the present tense cannot combine with a head clause using an indefinite present perfect, because such a *before*-clause is a 'past-zone adverbial' and therefore incompatible with an indefinite perfect interpretation of the head clause (see 12.6.1):

I {saw / *have seen} him before he entered the church.

Furthermore, a *before*-clause that is to receive a factual (= t_0 -factual) interpretation cannot be located in a post-present domain, because the post-present is by definition not-yet-factual-at- t_0 .

It follows from all this that it is only in past domains that a *before*-clause can be interpreted as t_0 -factual. In what follows we will therefore only consider *before*-clauses combining with a head clause in one of the past time-sphere tenses.

14.11.2 We have argued that in examples like *He left the island before I arrived*, both *left* and *arrived* are absolute preterites, which each establish a

past domain of their own. The temporal relation between the two domains is only expressed by *before*. In the temporal structure created by *before*, the situation time of the head clause functions as the contained orientation time and the situation time of the *before*-clause functions as the Anchor time. See Figure 14.10 in section 14.8.2.

Since both clauses establish a past domain by the use of an absolute tense, they both represent their situation as t_0 -factual (= factual at t_0). In other words, this type of sentence is used to express that two situations actualized (became a fact) in the past and that they did so in a particular temporal order (indicated by *before* only). The same reading is invited if the head clause uses the past perfect, in which case the temporal order is expressed both by *before* and by the tense: *He had left the island before I arrived*. (Unlike the past tense, the past perfect can be chosen in order to convey that the anterior situation was somehow relevant at the past binding orientation time, e.g. because it produced a resultant state, or in order to express a continuative interpretation, as in *He had been living with Carrie for years before he found out she was a kleptomaniac*.)

14.11.3 Apart from the above types of factually interpreted temporal structures, there are a few special sentence structures in which the *before*-clause (in the past tense) is interpreted as t_0 -factual (at least, when the sentence is used out of context, as in the previous examples). One such structure is the type referred to in 14.6.7 above and illustrated by sentences like *We had to force the lock before we could open the door*. Here the factual interpretation results from the application of the following principle:

A *before*-clause in the past tense receives a t_0 -factual interpretation if the head clause situation is factual and its actualization is seen as a necessary and sufficient condition for the *before*-clause situation to actualize.

This type of sentence is special in that it does not allow the insertion of a measure phrase (e.g. *long*) before the *before*-clause. As a rule, factual *before*-clauses do allow such an insertion – see 14.6.13. The fact that a measure phrase is not allowed here may be a sign that the *before*-clause is not primarily interpreted as a time-specifying adverbial but that the sentence as a whole is read as a kind of conditional sentence. This would mean that the idea of temporal precedence has been metaphorically extended to the idea of logical precedence: the head clause and the *before*-clause express something like condition and consequent, or cause and effect. (This is also in keeping with the fact that in this pattern the head clause normally precedes the *before*-clause.)

14.11.4 A second special type in which a *before*-clause in the past tense can be interpreted as a t_0 -factual *before*-clause is when the *before*-clause is not a time-specifying adverbial but functions as a **NARRATIVE BEFORE-CLAUSE**. As

noted in 5.25.2, a ‘narrative’ time clause pushes forward the action instead of functioning as a time-specifying adverbial (establishing an Adv-time). Narrative *when*-clauses (e.g. *I was just going to leave when the telephone rang*) were discussed in section 13.1.3. The following are some examples of narrative *before*-clauses (which, just like narrative *when*-clauses, use an absolute tense form):

Instead of entering the house at once he *waited* some time before he *pushed* the key into the lock.¹⁶

[When they reached the porch] they both *stood* panting for a moment, before the old man *said*: “I’ll take off me boots.” (LOB)

He *was* hardly in the house before the storm *broke*.

I *was* just going to say that before you *went* “Pssst”. (BAXT)

We *had* hardly gotten into the Jacuzzi before we *were* in the bedroom. (www)

Her infidelity *had spanned* the late summer and most of the autumn before she *began* to realize that any affair was just as fraught with risk as marriage was. (SOA)

In the following example the speaker uses the past perfect instead of an absolute past tense:

He had only time to glimpse her face, before she *had gone up* the north aisle. (www)

By referring to the resultant state rather than to the action producing it, the speaker emphasizes the swiftness of ‘her’ completing the action of going up the north aisle.

It should be noted, however, that a narrative *before*-clause does not always have a t_0 -factual meaning when it follows *it would (not) be long* or *it was (not) going to be long*. If it does, it can use either the absolute past tense or the conditional tense (as an equivalent to factual *was / were to*, as in *Ten years later Bill {was to / would} be the richest man in town* – see 9.6.7). If it does not have a t_0 -factual meaning but merely refers to an anticipated situation (as in free indirect speech), it normally uses a relative past tense form:

[The transition from stage to gym may seem unlikely, but Louise Dench, a ballet teacher from Coventry, believes that it was inevitable. “Well it’s happened with boxing and salsa,] so many things get turned into exercise videos and classes *it wasn’t going to be long* before it *happened* with ballet. [I mean, it is one of the most demanding forms of exercise.”] (www) (*absolute preterite; t_0 -factual interpretation*)

[The family of three Sarus cranes had been flying for a long time now and the baby was definitely tired.] However, *it wasn’t going to be long* before they *would arrive* at the destination of their annual migration, Sultanpur National Park. [As they

16. Because a narrative *before*-clause is t_0 -factual, the form *pushed* is an absolute tense form. This is confirmed by the ‘represented speech test’ (see 8.25): *He said that instead of entering the house at once he had waited some time before he had pushed the key into the lock.*

passed over the crowded cities below, their sharp eyes hunted for signs of the soothing green reflections of the lake that greeted them every year. This year, it was not to be. There, before them, stood small pools of water instead.] (www) (*The t_0 -factual sentences following the before-clause confirm the t_0 -factuality of the before-clause.*)

[I was still running 6:20 miles, but I was struggling and breathing hard.] It *wasn't going to be* long before I started to crash. (www) (*anticipated situation; relative past tense; no t_0 -factual reading*)

14.11.5 Another type of factual *before*-clause is to be found in clefts whose head clause does no more than indicate (and highlight) the time of the *before*-clause situation:

(10a) It *was* 7 p.m. before he *arrived* in London.

(10b) It *was* the following holidays before they *fought* again. (TOCC)

In (10a-b), 7 p.m. and *the following holidays* indicate the time at which the *before*-clause situation actualized. That is, in each case the situation time of the head clause and the situation time of the *before*-clause are interpreted as simultaneous, so that *before* can be replaced by *when*:

(11a) It was 7 p.m. when he arrived in London.

(11b) It was the following holidays when they fought again.

However, (11a-b) are not quite synonymous with (10a-b). The following are better paraphrases of (10a-b):

(12a) It was not until 7 p.m. that he arrived in London.

(12b) It was not until the following holidays that they fought again.

Whereas (11a-b) just locate the *when*-clause situation at the time indicated by the head clause, (10a-b) and (11a-b) do more than this: they also stress the existence of an interval of time between a contextually given orientation time and the situation time of the subclause, as well as the nonactualization of the subclause situation during the interval in question. (The use of *by the time that* instead of *before* in (10a-b) would have roughly the same effect.) In (10a-b) the function of *before* is thus to bring out a W-posteriority ('later') relation which is expressed by no other constituent in the sentence (since the situation time of the head clause and the situation time of the *before*-clause are interpreted as simultaneous with each other).

Sentences like (10a-b) form a subtype of sentences with a 'narrative *before*-clause' (see 14.11.4): the *before*-clause pushes forward the action and the head clause merely gives temporal information about the location of the *before*-clause situation. It should also be noted that in the type of example under discussion the past tense can easily be replaced by the past perfect if the head clause also uses the past perfect: *It had been Tuesday before the police {intervened / had intervened}*. In that case the time of the intervention is repre-

sented as T-anterior to the same implicit past orientation time to which the situation time of the head clause is also T-anterior. In other words, *had intervened* is an instance of ‘indirect binding’ (see 9.28).

14.11.6 The *before*-clause is also t_0 -factual in clefts like the following, in which the head clause is negative and the highlighted constituent is not a temporal NP but a measure phrase which indicates the temporal distance between (the beginning of) the time of actualization of the *before*-clause situation and a preceding (contextually given) past orientation time:

It was not {long / *the following holidays} before they fought again.

It was not long before the child was playing with the other children.

Examples like these arguably form a kind of cleft construction. They alternate with examples like the following, which rather invite an analysis in terms of extraposition of the *before*-clause (which is the semantic subject):

[They began to groom him as Brown’s heir apparent.] It didn’t last long before Morrison was shifted back to outside linebacker. (www)

14.11.7 A variant of the construction *It wasn’t long before ...* is illustrated by the following, in which the *before*-clause is in the past perfect and is also interpreted as t_0 -factual:

[When we got to the spot there were 18 wild dogs and they were looking very hungry.] It was not long before they *had found* their prey and in their own inimitable style made short work of eating breakfast. (www)

[Then she put on her boots, which took her an hour’s walk at every stride,] and it was not long before she *had overtaken* them. (www)

[While early duels had been fought with knives and modern pistols,] it was not long before duelling *had become* a celebrated and highly ritualized practice. (www)

The use of the past perfect, which expresses anteriority to the implicit contained orientation time, means that *not long* measures the distance between the contextual orientation time and the end of the *before*-clause situation (rather than its beginning, as in the examples in 14.11.6).

14.11.8 *Before*-clauses in sentences of the types discussed in 14.11.5–7 are interpreted as t_0 -factual because they specify the distance between a given orientation time and the initial or terminal point of the situation time of the *before*-clause.¹⁷ This is especially clear when the *before*-clause uses the past perfect:

17. Compare: in section 14.6.13 we saw that the addition of a measure phrase (e.g. *long*) to *before* normally produces a factual interpretation.

It was a long time before all the cases *had been unpacked*.

[These laws were then ratified, although] it was a long time before custom *had obtained* the vigor and effect of law. (www)

[The stockpiling of treatment began and] it was a long time before enough *had been stored*. (www)

The past perfect situations are obviously interpreted as t_0 -factual. If we want to do no more than represent the *before*-clause situation as not-yet-factual (i. e. put emphasis on the fact that the unpacking was not yet a fact at the relevant situation time) we have to use the conditional perfect (usually in combination with the conditional tense in the head clause):

[John looked at the cases in despair.] It would still be a long time before all of them *would have been unpacked*.

If the distance measured is not between the contextually given past orientation time and the end of the *before*-clause situation but between the orientation time and the beginning of the situation of the *before*-clause, there are three possible tense combinations:

[Bill looked at the clock in despair. It was three-thirty. The car carrying his rescuers had left Inverness at two, so] it *was* still at least an hour before they *would arrive*.

[Bill looked at the clock in despair. It was three-thirty. The car carrying his rescuers had left Inverness at two, so] it *would still be* at least an hour before they *arrived*. (*Arrived is a relative past tense form.*)

[Bill looked at the clock in despair. It was three-thirty. The car carrying his rescuers had left Inverness at two, so] it *would still be* at least an hour before they *would arrive*. (*indirect binding*)

The following are some attested examples:

[There were no problems with that, but] there *was* still like an hour before the boat *would be leaving*, [so we walked around a bit, looked in the shops, ...] (www)

[It was well into dark and Murphy had deduced that] it *would be* still a few hours before someone in Four Corners *was* wise to Tanner's absence. (www)

It *would be* still more years, however, before we *would see* the Church of Finland come together in unity and commitment to make a disciple of their homeland. (www)

14.12 Counterfactual *before*-clauses

14.12.1 As noted in 14.6.6, a not-yet-factual *before*-clause can receive a t_0 -counterfactual interpretation from the pragmatics of the context. One possibility is that it is the context following the sentence with the *before*-clause that imposes a counterfactual reading, as in

I saw her before she had seen me. [So I quickly turned into a side street and managed to escape unseen.]

Another possibility is that the actualization of the *before*-clause situation is prevented by the actualization of the head clause situation:

She burnt the letter before I had read it.

In the latter case the past perfect in the nonstative *before*-clause could in principle be replaced by the past tense because the factual reading suggested by the past tense is anyhow pragmatically excluded. However, in sentences like the following the past tense is often judged unacceptable because it primarily suggests the nonsensical reading on which the *before*-clause situation did actualize:

The letter was destroyed before I {*had read* / [?]*read*} it.

Before we {*had gone* / [?]*went*} far the car broke down.

On the other hand, sentences like the following are quite common:

The car broke down before we *got* very far.

He died before I *could* tell him the news.

14.12.2 As noted in 14.6.14, a *before*-clause can receive a counterfactual reading from the use of the conditional perfect, provided *before* is preceded by a measure phrase:

He died the day before he *would have married* Eileen.

The measure phrase is necessary because it helps the hearer to identify the time when the counterfactual situation was expected to actualize. (This information cannot be conveyed by a time-specifying adverbial if the *before*-clause is in the conditional perfect: **He died before he would have married Eileen last Saturday*. This is in keeping with the fact that *He died the day before he would have married Eileen* means 'He died the day before the time at which he would have married Eileen'. It is not possible to insert *last Saturday* into the relative clause of this paraphrase either.)

14.13 Not-yet-factual *before*-clauses

14.13.1 In a sense all *before*-clauses are not-yet-factual because 'not yet B when A' logically follows from 'A before B'. In this trivial sense, t_0 -factual *before*-clauses and counterfactual *before*-clauses are also not-yet-factual. What we will be dealing with in this section are *before*-clauses that are not-yet-factual-at-t without also being t_0 -factual or t_0 -counterfactual.

14.13.2 In section 14.6.5 we have seen that there is a special tense we can use to represent the *before*-clause situation as not-yet-factual, viz. the past perfect.

In nonstative *before*-clauses this tense is used instead of the past tense, because the past tense implicates t_0 -factuality:

It is also worth noting that the t_0 -factual implicature of the past tense is a very strong one. Though it can be blocked by the context, it cannot be cancelled by an addition to the contrary. The following is unacceptable because it is interpreted as contradictory (and hence nonsensical):

*I left before John arrived, but he didn't arrive.

In Gricean terms, this means that the t_0 -factual sense of the past tense in the *before*-clause is a conventional implicature rather than a conversational one.

14.13.3 In 14.11.6 we have discussed the cleft-like construction *It was not long before they reached the capital*, in which the *before*-clause refers to a factual past situation. There is a similar, but this time existential construction-like, type of sentence in which the *before*-clause explicitly represents its situation as not-yet-factual:

[Adam yawned, and looked at the clock above the entrance to the North Library.]
There was still a long time to go before his books *would arrive*. (BM)

There's still a long time to go before the others *will be* here.

Note that the use of *would* and *will* in this type of *before*-clause is rather special. If both clauses of a sentence with a *before*-clause refer to the post-present (e.g. *I will leave before he arrives*), both situations are represented as expected (predicted) rather than as t_0 -factual. It follows that as a rule the head clause uses an absolute (= Absolute Future System) tense form to establish the post-present domain, while the *before*-clause uses a relative (= Pseudo- t_0 -System) form. The reason is that a prediction creates an opaque (intensional) context and that, as argued in 10.4.6, an intensional domain functions as a temporal domain: whatever situation is to be interpreted intensionally must normally be incorporated into the intensional domain, i.e. must be expressed by a relative tense form. In the case of post-present domains, this means that the subclause must as a rule use a Pseudo- t_0 -System form. In fact, the latter System is quite possible in examples like the above ones:

And there's a long time to go before the Federal election *is called*, so anything could happen. (www)

Because there is some time before this new methodology *is put* in place, [now is an opportune time to design a system that will ...]. (www)

Irrespective of which System is used, the head clause can also be in the future tense:

There *will be* some time before the others *will be* here.

[Since these standards were remanded to EPA by a federal court in May 1999,] there *will be* some time before the exact form of the standards *is known*. (www)

In sum, the following four constructions can all be used without a clear difference of meaning:

[It's five o'clock now.] There *will be* some time before the others *will be* here.

[It's five o'clock now.] There *will be* some time before the others *are* here.

[It's five o'clock now.] There *is* still some time before the others *will be* here.

[It's five o'clock now.] There *is* still some time before the others *are* here.

E. A comparison between *before* and *until*

Sections 14.14–16 are devoted to *until*-clauses, which show many similarities with adverbial *before*-clauses, but are 'bifunctional' (= indicating duration and time) rather than purely time-specifying.

Like *before*, *until* expresses (or at least implies) anteriority. The main difference between *before* and *until* is that *before*-clauses function as pure time-specifying adverbials whereas *until*-clauses function as 'bifunctional temporal adverbials' (see 2.22.3), i. e. they indicate duration as well as time. The other distinctions that can be made between the two types of clause follow from this basic difference.

14.14 The semantics of the conjunction *until*

14.14.1 *Until* is interpreted as 'until the time at which'. Diachronically, it has developed from an old English phrase 'until the time that' via Middle English *until that*. This means that there is an implicit orientation time (which, as in the case of *before*-clauses, we can refer to as the 'Anchor time') in its semantics. As in the case of *before*, this Anchor time is the final point of the Adv-time (= the period indicated by the *until*-clause). The basic difference between an *until*-clause and a *before*-clause is that while the latter is a pure time-specifying adverbial, an *until*-clause is a 'bifunctional adverbial' (see 2.22.3): it both establishes an Adv-time and indicates the duration of the full head clause situation. For example:

Jim stayed in the pub until Prudence came in.

The head clause situation is said to last till Prudence came in. The *until*-clause indicates an Adv-time which coincides with the situation time of the head clause. The situation time of the head clause coincides with the time of the full situation because the head clause situation is made bounded by the addition of

the *until*-clause, which specifies the end of the head clause situation. In sum, the *until*-clause is a duration adverbial because it specifies the length of the full head clause situation, and it is a time-specifying adverbial because it specifies an Adv-time which contains the situation time of the head clause in terms of coincidence. It is therefore a bifunctional adverbial. The Adv-time is a definite period because it is ‘anchored’ (see 12.1.1) by the fact that its endpoint is specified. This endpoint (= Anchor time) may be the situation time of the *until*-clause or another orientation time binding the situation time of the *until*-clause – see 14.15.2 below.

14.14.2 Because an *until*-clause is a bifunctional adverbial, the contained orientation time of the head clause coincides with the Adv-time. It follows that the situation time of the head clause must as a rule be the contained orientation time of the head clause. The only possible (but very marginal) exception is when the situation time of the head clause is represented as T-posterior to the contained orientation time by means of *be about to* or *be going to*:

Until John said everything was safe again, his men *were about to shoot* at anything that moved.

14.15 The tenses used in head clause and *until* clause

As far as tenses are concerned, *until*-clauses allow the following possibilities:

14.15.1 If the reference is to the past, both the head clause and the *until*-clause can create a domain of their own. This is not possible when the reference is to the post-present:

I *was* there until Bill *came* back.
*I *will be* there until John *will be* back.

In the former example, both verb forms are absolute tense forms. Both situations are therefore interpreted as t_0 -factual. See Figure 14.11.

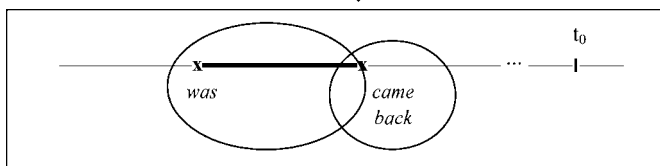

Figure 14.11. The temporal structure of *I was there until Bill came back*.

14.15.2 When the situation time of the head clause is interpreted as W-posterior to another orientation time, the *until*-clause forms part of an ‘intensional

domain' (see 10.4.6). In that case the situation time of the *until*-clause must be T-bound by the implicit Anchor time:

[Bill said] he would stay in the pub until Jill {*arrived* / **would arrive*}. (= 'He would stay in the pub until the time of Jill's arrival.')(The *until*-clause represents its situation time as T-simultaneous with the implicit Anchor time. It is not possible to effect indirect binding by representing the situation time of the *until*-clause as T-posterior to the situation time of the head clause.)

[Bill said] he would stay in the pub until Jill {*had arrived* / **would have arrived*}. (= 'He would stay in the pub until such time as Jill had already arrived.')(The *until*-clause represents its situation time as T-anterior to the implicit Anchor time. It is not possible to effect indirect binding by T-relating the situation time of the *until*-clause to the situation time of the head clause by using *would have arrived*.)

She intended to stay up until her husband {*came* / **would come* / *had come* / **would have come*} home.

The same system applies if the verb of the head clause itself evokes the idea of a W-posterior *until*-clause situation, as in the following example:

I was waiting until the others {*came* / **would come* / *had come* / **would have come*} home. (= 'I was waiting for the others to {*come* / *have come*} home.')

When the head clause refers to the post-present, it automatically creates an intensional domain. It is therefore predictable that the *until*-clause will use the Pseudo- t_0 -System to relate the situation time of the *until*-clause to the implicit Anchor time:

I will postpone the meeting until we {*have* / **will have* / *have received* / **will have received*} more information.

Please stay here until the doctor {*comes* / **will come*}.

When the head clause uses a verb like *wait*, it can refer to the present while the *until*-clause still refers to the post-present. In that case too, the *until*-clause uses the Pseudo- t_0 -System:

I am waiting until the others {*come* / **will come* / *have come* / **will have come*} home.

In examples like this, the central orientation time of the post-present domain is an 'implicit' (see 2.14) orientation time.

14.15.3 The choice between the past tense and the present perfect in the head clause of an *until*-clause has been dealt with in 12.13.

14.16 The semantics of *not ... until*

When the head clause is negative, there are in principle two possible interpretations of **NOT ... UNTIL**. The first is that the *until*-clause has its usual func-

tion of specifying both an Adv-time (containing the situation time of the head clause) and the duration of the full head clause situation:

[“For how long didn’t he speak to you?”] – “He didn’t speak to me until I addressed him myself.”

Here the reference is to a negative situation, viz. the situation of his not saying a word to me. Such a negative situation can be located in time with the help of an *until*-clause.

In many cases, however, the *not* in the head clause does not really negate the head clause, so that there is no reference to a negative head clause situation. Instead, *not* is directly combined with *until* in interpretation, and *not ... until* is interpreted as specifying a time which is seen as later than might have been expected:

Jim didn’t arrive until five.

The primary idea here is not ‘Jim’s not arriving lasted until five’ but rather ‘Jim only arrived at five’, or ‘It was as late as five when Jim arrived’. In this interpretation, the *until*-clause is not a bifunctional adverbial any more; it does not specify the duration of the full head clause situation but merely functions as a time-specifying adverbial. More specifically, it says at what time Jim arrived. The same is true if *until* is used as a conjunction rather than as a preposition:

I didn’t leave the office until I had replied to all my e-mails. (= ‘It was only after I had replied to all my e-mails that I left the office.’) (The situation time of the *until*-clause is represented as T-anterior to the Anchor time.)

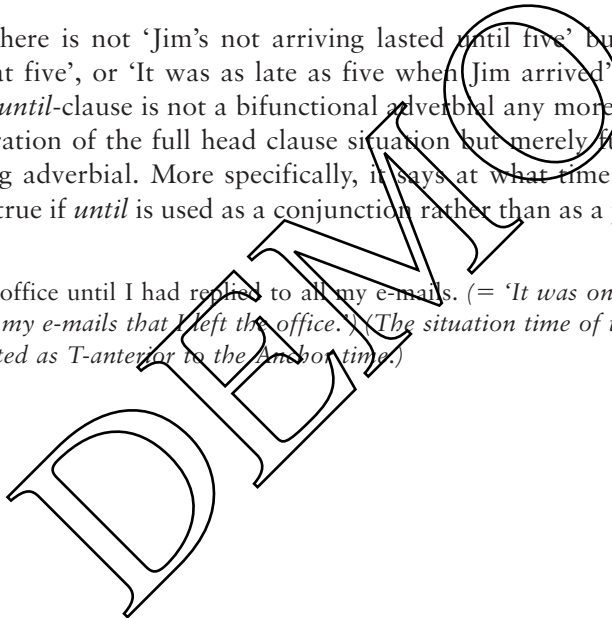

II. Adverbial *after*-clauses

The temporal structure of the conjunction *after* is represented by Figure 14.12.

14.17 The temporal structure of *after*

14.17.1 In the same way as *before* means ‘before the time when’, the conjunction *after* is semantically equivalent to ‘after the time {that / when / at which}’. This is in keeping with the fact that the conjunction *after* has actually developed from a phrase corresponding to the modern English phrases ‘after the time that’ or ‘after then that’. In the paraphrase ‘after the time {that / when / at which}’, the word *time* refers to the Anchor time, which is the *initial* point of the Adv-time. (When a *before*-clause is used, the Anchor time is the *terminal* point of the Adv-time.) The Adv-time, which is the period stretching from that initial point onwards, contains the ‘contained orientation time of the head clause’. The latter is either the situation time of the head clause or another orientation time which binds the situation time of the head clause. In sum, the temporal structure of *after* is as shown in Figure 14.12.

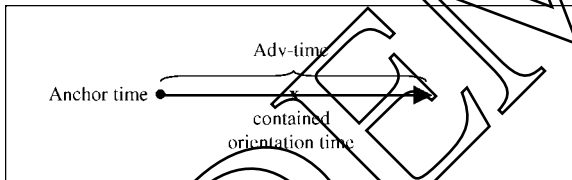

Figure 14.12. Representation of the temporal structure of *after*.

This structure is the mirror-image of the structure of *before* shown in Figure 14.1. Whereas a *before*-clause specifies an Adv-time leading up to an ‘Anchor time’ (which either is the situation time of the *before*-clause or binds the situation time of the *before*-clause), an adverbial *after*-clause specifies an Adv-time starting from an Anchor time onwards. The Anchor time is thus the initial point of the Adv-time. In the structure of the tense of the *after*-clause, the Anchor time is usually the situation time of the *after*-clause itself, but it may also be an implicit time binding that situation time. For example:

John left after I arrived. (*The Adv-time is a pragmatically restricted period stretching from the Anchor time onwards. The Anchor time is the situation time of the after-clause, i.e. the time of my arrival. The Adv-time contains the situation time of the head clause, i.e. the time of John’s leaving.*)

John left after I had arrived. (*The Adv-time is a pragmatically restricted period following the Anchor time, to which the situation time of the after-clause is represented as T-anterior. The Adv-time contains the situation time of the head clause.*)

[You can't rely on Bert. He's too volatile. Now he says this, now something else. Remember what he said last Christmas.] Hardly a week after he had promised us to stay, he was going to leave the country. (*The Adv-time is a pragmatically restricted period following the Anchor time, to which the situation time of the after-clause is represented as T-anterior. This Adv-time contains the implicit contained orientation time, to which the situation time of the head clause is T-posterior.*)

The temporal structure realized in the last example is shown in Figure 14.13.

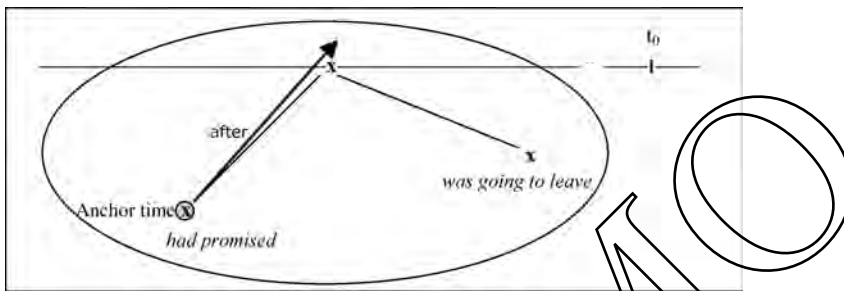

Figure 14.13. The temporal structure of *Hardly a week after he had promised us to stay, he was going to leave the country.*

The fact that *after* can involve an implicit Anchor time is best illustrated by examples like

Was that before or after the policemen had arrived?

This sentence is interpreted as ‘Was that before or after the time when (it was the case that) the policemen had arrived?’. This means that the situation time of the *before*-clause (= the time of the policemen’s arrival) is here represented as T-anterior to the Anchor time that is implicit in the conjunction *before* (and lexicalizes as *the time* in the paraphrase ‘before the time that’), while the situation time of the *after*-clause (= the time of the policemen’s arrival) is represented as T-anterior to the Anchor time that is implicit in the conjunction *after* (and lexicalizes as *the time* in the paraphrase ‘after the time that’). In both cases the situation time of the head clause is contained in the Adv-time.

When both the head clause and the *after*-clause refer to the post-present, the situation time of the *after*-clause is related to the implicit Anchor time by means of a Pseudo- t_0 -System form:

He will repair the sink after he {comes / *will come / has come / *will have come} home.

This means that, like *before*-clauses, adverbial *after*-clauses sometimes use relative tenses. However, as in the case of *before*-clauses (see *Bill left before I arrived* in 14.4.2–5), *after*-clauses can also establish a past temporal domain: *I arrived after Bill left*. In that case the Anchor time is the situation time of the *after*-clause.

14.17.2 In sum, we can say that the conjunction *after* establishes an Adv-time whose starting point is the ‘Anchor time’ which lexicalizes as *the time* in the paraphrase ‘after the time that’. This Anchor time may be either the situation time of the *after*-clause (as in *He left after I arrived*) or an implicit orientation time to which the situation time of the *after*-clause is temporally related (as in *He will leave after I have arrived*). The Adv-time contains the ‘contained orientation time’ (in terms of inclusion or coincidence). If there is inclusion, *after* is interpreted as ‘at some time in the course of the period after’. If there is coincidence, *after* means ‘throughout the period after’. The contained orientation time may be either the situation time of the head clause (as in *He left after I arrived*) or another orientation time temporally binding the situation time of the head clause (as in *He will repair the sink after he has come home*).

14.17.3 When the *after*-clause situation is durative, the Anchor time (i. e. the initial point of the Adv-time) is the terminal point of the durative *after*-clause situation. That is, ‘A after B’ is interpreted as ‘A after the terminal point of B’ rather than as ‘A after the initial point of B’:

After he had played with his brother, Tom turned on the TV-set. (*interpreted as ‘after he had stopped playing with his brother’*)

John went out to play (five minutes) after he had done his homework. (= ‘(five minutes) after he had finished doing his homework’)

Because of this ‘terminative’ interpretation of the *after*-clause, we cannot normally use the past progressive form in the *after*-clause, though the progressive form of the past perfect is possible. Compare:

After he {*played* / *had played* / **was playing* / *had been playing*} with his brother, Tom turned on the TV-set.

The forms *played* and *had played* are both good, because they refer to the situation as a whole. *Was playing* is ungrammatical because it refers to a time in the course (middle) of the situation of playing: this time cannot be the terminal point of the situation. On the other hand, *had been playing* is fine because of the T-anteriority relation: even though the progressive is used, ‘A anterior to B’ can only be understood as ‘B posterior (= after) situation A as a whole’, in other words, as ‘B after the terminal point of A’.

14.17.4 In sentences like the following, the temporal distance between the terminal point of the *after*-clause situation and the situation time of the head

clause (which is contained in the Adv-time) is indicated by the duration adverbial in the *after*-clause, which receives a ‘situation time co-extensive with the pre-present’ (see 5.2.2–3) interpretation:

He’s now opening the safe (for the first time) after it has been closed for over two months.

In the following example, the present perfect again represents the *after*-clause situation as extending throughout a pre-present period up until t_0 . That pre-present period is measured by *for twenty-two years*. The head clause situation is represented as lying in the post-present and as depending on a present decision.

Surely, you’re not going to fire him after he’s been your foreman for twenty-two years?!

The *after*-clause of the following example is similar, except that the past perfect represents the *after*-clause situation as leading up to a past orientation time, which is located two weeks before the situation time of the head clause (by the measure phrase *two weeks* in the head clause):

The Chancellor of the Exchequer resigned two weeks after he had been in office for exactly seven years.

14.18 Temporal structures involving a head clause and an *after*-clause

14.18.1 It follows from the previous section that at least the following temporal structures (configurations) involving a head clause and an adverbial *after*-clause are possible.

- (a) Firstly, the orientation time contained in the Adv-time may be the situation time of the head clause (which means that the adverbial is used as a situation-time adverbial), while the situation time of the *after*-clause is the Anchor time.

The man *shot* himself after he *killed* his wife and children. (*The situation time of the head clause is included in the Adv-time.*)

He *was* a well respected citizen after he *married* the judge’s daughter. (*The situation time of the head clause coincides with the Adv-time.*)

The past tense forms in these *after*-clauses are absolute tense forms. We will not go into the arguments supporting this claim here, because they are the same kind of arguments as those that were adduced in connection with the past tense of the *before*-clause in *He left before I arrived* in 14.4.2–5.

Like *before*-clauses, *after*-clauses can use the absolute past tense, but cannot use an Absolute Future System form (i. e. an absolute tense form establishing a post-present domain):

The man will shoot himself after he {kills / *will kill} his wife and children.

He will be a well respected citizen after he {marries / *will marry} Edith.

- (b) Secondly, the orientation time (from the tense structure of the head clause) that is contained in the Adv-time may be the situation time of the head clause itself (which means that the Adv-time is used as a situation-time adverbial), while the situation time of the *after*-clause is represented as T-anterior to the situation time of the head clause. In this case the anteriority relation between the two situation times is expressed twice: by the conjunction *after* and by the tense of the *after*-clause.

[I hoped that] my brother *would be treated* well after he *had been arrested*. (The time of the head clause situation, i. e. the treatment of my brother, coincides with the Adv-time: the speaker wants his brother to be treated well throughout the period following his arrest. The *after*-clause uses the past perfect form *had been arrested* to represent the situation time of the *after*-clause as T-anterior to the situation time of *would be treated*. See Figure 14.14.)

He left long after I *had arrived*.

Here too, the *after*-clause has to use a Pseudo- t_0 -System form when it refers to the post-present:

John will go home after the pub *has closed*. (The situation time of the head clause is included in the Adv-time. The *after*-clause uses a Pseudo- t_0 -System form to relate the situation time of the *after*-clause to the situation time of the head clause.)

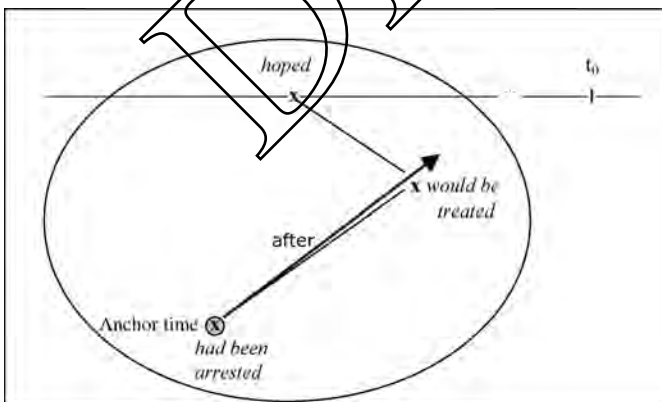

Figure 14.14. The temporal structure of *I hoped that my brother would be treated well after he had been arrested*.

It is worth noting that *after*-clauses do not usually use a T-posteriority form. Examples like the following are rather unintelligible and hardly acceptable:

??[The fact that] she left him shortly after he *was going to commit* suicide, [which, fortunately, we were able to prevent,] is an indication that she did not really love him.

- (c) Thirdly, the situation time of the head clause may be T-related to the contained orientation time (i. e. it is bound by an unspecified orientation time which is included in the Adv-time), while the situation time of the *after*-clause is the Anchor time. In this case the Adv-time functions as an orientation-time adverbial (since it does not contain the situation time of the head clause but rather the unspecified contained orientation time to which the situation time of the head clause is temporally related).

The man *had shot* himself after he *killed* his wife and children. (*The situation time of the head clause is T-anterior to the contained orientation time, which is contained in the Adv-time. The situation time of the after-clause is the Anchor time.*)

After he *killed* his wife and children the man *was going to commit* suicide. (*The situation time of the head clause is T-posterior to the contained orientation time, which is contained in the Adv-time. The situation time of the after-clause is the Anchor time.*)

- (d) Fourthly, the situation time of the head clause may be T-related to the contained orientation time, while the situation time of the *after*-clause is T-related to the Anchor time. Both clauses therefore use a relative tense form. In this case too the Adv-time functions as an orientation-time adverbial. Examples illustrating this can only be found in free indirect speech:

[What John says changes every few minutes.] Yesterday he *was suddenly going to become* a doctor after he *was going to become* an engineer. (= 'John first said he was going to be an engineer, but then suddenly said he was going to study medicine.')

A week after John *was going to commit* suicide, he *was no longer going to do so*. (*free indirect speech*)

14.19 The tense system if the *after*-clause functions as situation-time adverbial

14.19.1 When the two clauses refer to the past, there are three possibilities:

- (a) If the speaker just wants to represent two t_0 -factual past situations as actualizing in a particular temporal order ('A after B'), he can use an absolute past tense form in both of the clauses:

I *left* after John *arrived*, not vice versa.

John *bought* a gun after somebody *broke* into his house.

Cherry *threw* a party after she *passed* her exams.

This possibility of using the past tense in the *after*-clause is more frequently made use of in informal English than in more formal registers. Written texts generally prefer the past perfect in the *after*-clause.

- (b) The speaker will use the past perfect in the *after*-clause if he wants to represent the situation time of the *after*-clause as T-anterior to the situation time of the head clause.

I *left* after John *had arrived*.

John *bought* a gun after somebody *had broken* into his house.

Here we must also mention the cases in which the speaker wants the *after*-clause situation to be interpreted as an ‘up-to-now’ (see 5.3.2) situation or as a resultant state:

The old man died after he {*had been* / **was*} ill for a long time. (*up-to-now interpretation*)

We could only get in after John {*opened* / *had opened*} the door. (*resultant state interpretation*)

In all these examples the *after*-clause is interpreted as t_0 -factual. This is logical: what precedes a factual head clause situation must itself be factual.

- (c) If the head clause expresses T-posteriority in a past domain, the *after*-clause situation cannot be interpreted as t_0 -factual because it forms part of a prediction or expectation. In this case the *after*-clause can make use of two tenses. The less usual of the two is the relative past tense, which represents the situation time of the *after*-clause as T-simultaneous with the Anchor time which is implicit in the semantics of *after* (= ‘after the time that’):

[He had decided] he would do it after the others *left*.

He would do it after the others *left*. (*free indirect speech*)

The more common possibility is to use the past perfect, which expresses T-anteriority to the situation time of the head clause:

He would do it after the others *had left*. (*free indirect speech*)

It is worth noting that indirect binding by means of the conditional tense or the conditional perfect is not allowed:

*He would do it after the others {*would leave* / *would have left*}.

In this respect English differs from most other Germanic languages, where indirect binding is not impossible.

14.19.2 When the two clauses refer to the post-present (and, as before, the *after*-clause functions as situation-time adverbial), the possibilities are as follows:

- (a) If the speaker wants to express that he expects two post-present situations to actualize in a particular temporal order ('A after B'), he uses the future tense in the head clause and the present tense (as Pseudo- t_0 -System form) in the *after*-clause:

I will leave after John arrives, not vice versa.

[I expect that] John *will* only *buy* a gun after somebody *breaks* into his house.

Cherry *will throw* a party after she *passes* her exams.

In these examples, the present tense represents the situation time of the *after*-clause as T-simultaneous with the implicit Anchor time. That is, the situation orientation time of 'John arrives' in the first example is T-simultaneous with the implicit orientation time (lexicalized as *the time* in the paraphrase 'after the time that') in the semantic structure of *after*. The situation time of 'I will leave' is included in the Adv-time (= the *after*-period).

- (b) If he wants to represent the situation time of the *after*-clause as T-anterior to the situation time of the head clause, the speaker will normally use the present perfect (as Pseudo- t_0 -System tense) in the *after*-clause.

I will leave after John has arrived.

[I expect that] John *will buy* a gun only after somebody *has broken* into his house.

Examples in which the Pseudo- t_0 -System tense form expressing anteriority in the *after*-clause is a past tense are very hard to come by, but do exist:

[It might be hard to tell someone you have this problem but] you will feel better after you *did* it. (www)

[The plan is that] they will take the 6.36 train after they *robbed* the bank at 6.10. (*The past tense is required here because at 6.10 prevents the use of an (indefinite) present perfect form.*)

The past tense can also be found in *after*-clauses depending on a head clause in the future perfect:

[When you get to the half-way point, you'll be moving one spot every two weeks, since] half the people quitting will have started after you *did* [and won't affect ...] (www)

[You won't be anywhere outside,] however, your window will have frozen up after you *left* it open due to sub-tropical temperatures the previous day. (www)

Self-evidently, only the present perfect can be used if the *after*-clause situation is to be interpreted as an up-to-now situation or as a resultant state:

The old man will die after he *{has been / *was}* ill for a long time. (*up-to-now interpretation*)

We will only be able to get in after John *{*opened / has opened}* the door. (*resultant state interpretation*)

- (c) If the head clause establishes a post-present domain, the *after*-clause situation cannot be interpreted as t_0 -factual because it forms part of a prediction or expectation. In this case there are two tenses that can in principle be used in the *after*-clause. The less usual of the two is the present tense (as pseudo-absolute tense), which represents the situation time of the *after*-clause as T-simultaneous with the Anchor time which is implicit in the semantics of *after* (= ‘after the time that’):

I will do it after you *leave*.

The more common possibility is to use the present perfect, which expresses T-anteriority to the situation time of the head clause (which is the central orientation time of the post-present domain):

I will do it after you *have left*.

In this case, anteriority is expressed twice: once by *after* and once by the present perfect (as pseudo-absolute tense form).

It is worth noting that the *after*-clause cannot establish a domain of its own by using the future tense or the future perfect:

*I will do it after you *{will leave / will have left}*.

In this respect English again differs from most other Germanic languages, where the equivalent of an *after*-clause *can* create a post-present domain.

14.20 The tense system if the *after*-clause functions as orientation-time adverbial

Like other time-specifying adverbials, an *after*-clause may function not only as a situation-time adverbial but also as an orientation-time adverbial. In the latter case, the contained orientation time (i. e. the orientation time which is contained in the Adv-time) is not the situation time of the head clause but another orientation time to which the situation time of the head clause is T-related. In accordance with the definition of ‘containment’ (see 2.16.2), the contained orientation time can then either coincide with the Adv-time (i. e. ‘after X’ = ‘throughout the time following X’) or be included in the Adv-time (i. e. ‘after X’ = ‘at a time included in the interval following X’). In the latter case, the contained orientation time can in principle coincide with the Anchor time or be a durative portion of the Adv-time which starts from the Anchor

time onwards or be a point of the Adv-time that follows the Anchor time and is not adjacent to it. It follows that there are four theoretical possibilities in which the *after*-clause functions as orientation-time adverbial. (In all four cases the situation time of the head clause is T-related to the contained orientation time of the head clause.)

- A. The contained orientation time of the head clause may coincide with the Anchor time.
- B. The contained orientation time of the head clause may be W-posterior to the Anchor time.
- C. The contained orientation time of the head clause may be a portion of the Adv-time immediately following the Anchor time.
- D. The contained orientation time of the head clause may coincide with the entire Adv-time.

Let us see if these theoretical possibilities can indeed be realized in English.

14.20.1 Possibility A is realized in examples like the following:

After the war ended there *was going to be* a famine, [but the country received aid from abroad]. (*The situation time of the head clause [i.e. the time of the imminent famine] is T-posterior to the situation time of the after-clause [ended]. The latter functions as Anchor time. This means that the situation time of the war ended marks the time at which the interval functioning as Adv-time begins. In other words, the Adv-time is the period starting at the end of the war. See figure 14.15.*)

After the present conflict is over there *will soon be going to be* another one. [At that moment the UN will have to intervene at once to stop the imminent conflict from developing.] (*The situation time of the head clause is T-posterior to the Anchor time.*)

It does not appear possible to represent the situation time of the head clause as T-anterior to the Anchor time. A sentence like

John had been ill for a week *after* he fell into the water.

is interpreted as meaning that John's illness followed his fall into the water, not that it preceded that fall. (This is due to the semantics of *after*; there would be no problem if *before* were used.)

14.20.2 In possibility B, represented by Figure 14.16, the situation time of the head clause is T-related to a contained orientation time which is W-posterior to the Anchor time (or to the situation time of the *after*-clause coinciding with it). This is only possible if *after* is preceded by a measure phrase indicating the length of time separating the contained orientation time from the Anchor time. In the following examples the situation time of the head clause is T-posterior to the contained orientation time:

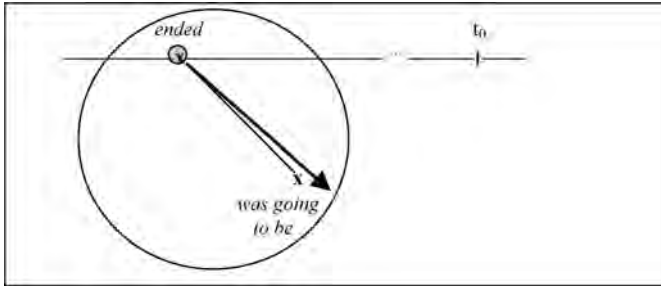

Figure 14.15. The temporal structure of *After the war ended there was going to be a famine.*

Shortly after the war ended there *was going to be* a famine, [but the country received aid from abroad].

A few months after the present conflict is over there *will be going to be* another one. [At that moment the UN will have to intervene at once to stop the imminent conflict from developing.]

The following is an example in which the situation time of the head clause is T-anterior (in the continuative sense) to the contained orientation time but the latter is nonetheless W-posterior to the Anchor time. This unique combination is made possible by the fact that the head clause contains an adverbial specifying the length of the continuative situation time of the head clause. Compare:

*After I got to know him, Bill *had been* in prison for exactly five years.

Three weeks after I got to know him, Bill *had been* in prison for exactly five years.

The temporal structure of the latter sentence is represented by Figure 14.16.

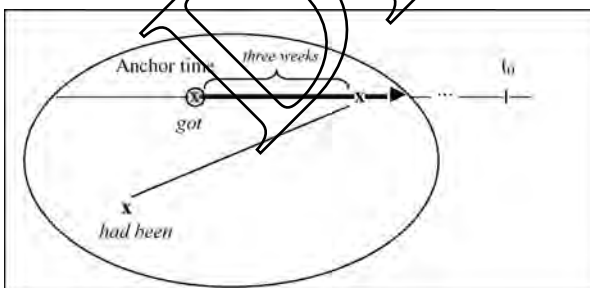

Figure 14.16. The temporal structure of *Three weeks after I got to know him, Bill had been in prison for exactly five years.*

14.20.3 In possibility C, the situation time of the head clause is T-related to a contained orientation time which is a portion of the Adv-time immediately

following the Anchor time. This possibility can only be realized in free indirect speech and requires the length of the portion in question to be indicated by an adverbial:

Immediately after she {*slept* with me / *had got* me into her bed} she *was going to help* me. [Oh yes. She would love to help. She was going to take the day off, and she was going to bring her tools round and we were going to get the job done in no time. But did she turn up? Of course not.]

It does not appear possible to represent the situation time of the head clause as T-anterior to the contained orientation time. A sentence like

John had been in bed for three weeks after he was in the water for several hours.

is interpreted as meaning that John's being in bed followed (rather than preceded) his being in the water. (This is again due to the semantics of *after*; there would be no problem if *before* were used.)

14.20.4 Possibility D is realized if the situation time of the head clause is T-posterior to a contained orientation time which coincides with the Adv-time. The following sentence is an example of this:

After he was stung by a bee, John would remain afraid of bees and wasps (for the rest of his life). (*After* is interpreted as 'throughout the period after'.)

The temporal structure of this sentence is represented by Figure 14.17.

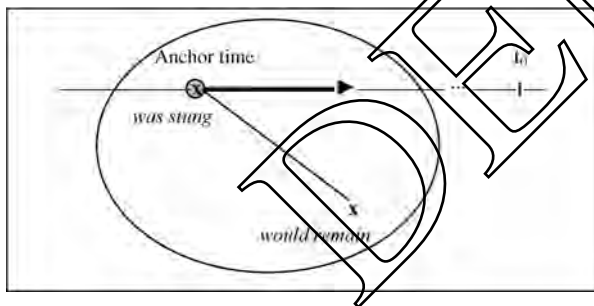

Figure 14.17. The temporal structure of *After he was stung by a bee, John would remain afraid of bees and wasps (for the rest of his life)*.

This possibility too does not allow the situation time of the head clause to be represented as T-anterior to the contained orientation time. A sentence like

John had remained an invalid after he got shot in the chest during the civil war.

is interpreted as meaning that John's being an invalid followed (rather than preceded) his being shot in the chest.

III. Summary

14.21 Summary of the discussion of *before*-clauses

14.21.1 The temporal structure of the conjunction *before* is represented in Figure 14.1 (repeated here).

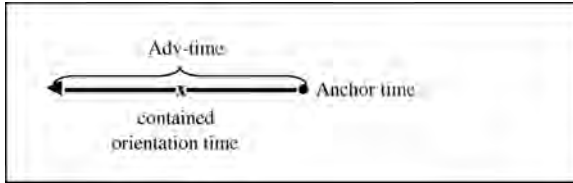

Figure 14.1. Representation of the temporal structure of *before*.

14.21.2 A *before*-clause is normally used as an orientation-time adverbial. The following is a summary of the main patterns and meanings which such a *before*-clause allows.

Adverbial *before*-clauses functioning as situation-time adverbials basically allow three major tense configurations (apart from others that have been discussed but will be ignored here). They are exemplified by the following sentences, which can be used to describe the same state of affairs:

- Jim left before Bill arrived.
- Jim left before Bill had arrived.
- Jim had left before Bill arrived.

(a) The first possibility is for the speaker to represent both situations as t_0 -factual by using two absolute past tense forms:

- Jim left before Bill arrived.

In such sentences the speaker just reports that two situations actualized in a particular order. The head clause situation is not interpreted as continuative and there is no resultative implication. The two absolute tense forms establish separate past domains. The temporal W-relation between the situation times is exclusively expressed by *before*. Both situations are interpreted as t_0 -factual, i. e. as past facts.

Because we cannot normally use the Absolute Future System in an adverbial *before*-clause, a similar use of two tense forms establishing separate domains is not possible if the reference is to the post-present:

- Jim will leave before Bill {leaves / *will leave}.

- (b) In the second possibility, illustrated by *Jim left before Bill had arrived*, the speaker represents the head clause situation as t_0 -factual (by using an absolute preterite) and represents the *before*-clause situation as not-yet-factual at the situation time of the head clause situation by using the past perfect. In doing so the speaker leaves it vague whether the *before*-clause situation eventually actualized (= became t_0 -factual) or not:

Jim left before Bill *had arrived*. (= 'Jim left; Bill had not arrived when Jim left')

The head clause is interpreted as t_0 -factual because it uses an absolute preterite. The situation time of the *before*-clause is represented as T-anterior to the Anchor time (= the terminal point of the *before*-period).

When the reference is to the post-present, the tense of the head clause also establishes the domain, but it is not interpreted as t_0 -factual, because the post-present is by definition not-yet-factual-at- t_0 .

Jim *will leave* before Bill *has arrived*. (*Has arrived* is a Pseudo- t_0 -System form expressing T-anteriority to the implicit Anchor time.)

- (c) The third possibility is for the speaker to represent the *before*-clause situation as t_0 -factual and to represent the head clause situation as t_0 -factual by representing its situation time as T-anterior to the central orientation time of the past domain:

Jim had left before Bill arrived.

He had been living there for many years before everyone accepted him.

When the reference is to the post-present, the head clause uses the future perfect to establish the domain and locate its situation time anterior to the central orientation time. The *before*-clause must represent its situation time as T-simultaneous with the implicit Anchor time, which is interpreted as coinciding with the central orientation time:

Jim will have left before Bill arrives. (*The before-clause uses the present tense as Pseudo- t_0 -System form. Its situation is expected to actualize but it is still nonfactual at t_0 .*)

He will have been living there for a long time before everybody accepts him. (*idem*)

14.21.3 In sections 14.11 to 14.13 we have discussed the factors (including the choice of tense) that induce a factual, counterfactual or not-yet-factual (respectively) reading of a *before*-clause.

14.21.4 The sections 14.14–16 have been devoted to *until*-clauses, which show many similarities with adverbial *before*-clauses, but are 'bifunctional' (= indicating duration and time) rather than purely time-specifying.

14.22 Summary of the discussion of *after*-clauses

14.22.1 The most common tense configurations in sentences consisting of a head clause and an *after*-clause referring to the past are illustrated by the following sentences:

John arrived after Mary left.

John arrived after Mary had left.

In *John arrived after Mary left*, the two situations are interpreted as t_0 -factual. This means that both preterite forms are absolute tense forms establishing two separate domains. The temporal W-relation between the two central orientation times is expressed by *after*.

In *John arrived after Mary had left*, there is only one past domain, established by *arrived*. Mary's leaving is represented as T-anterior to this central orientation time (*arrived*) by *had left*. That John's arrival followed Mary's leaving is also expressed by *after*. John's arrival is interpreted as t_0 -factual because *arrived* is an absolute past tense, and Mary's leaving is also interpreted as t_0 -factual because what precedes a t_0 -factual situation must also be t_0 -factual. The temporal structure of *John arrived after Mary had left* is represented by Figure 14.18.

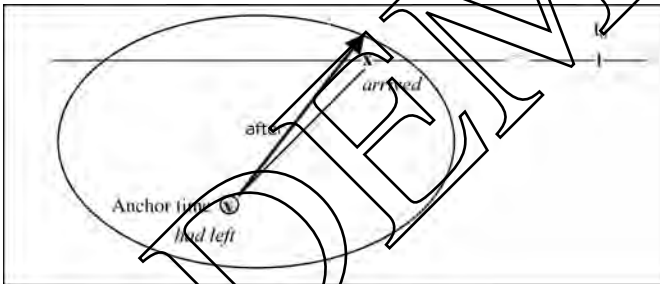

Figure 14.18. The temporal structure of *John arrived after Mary had left*.

When the reference is to the post-present, the corresponding sentences are the following:

John will arrive after Mary leaves.

John will arrive after Mary has left.

In both cases there is only one post-present domain, established by *will arrive*. The situation time of the *after*-clause is bound by the implicit Anchor time in terms of T-simultaneity (*leaves*) or, more frequently, T-anteriority (*has left*). In other words, only the head clause can use the Absolute Future System; the *after*-clause has to use the Pseudo- t_0 -System.

14.22.2 If the time of the head clause situation is represented as T-posterior to an orientation time in a past domain, the situation time of the *after*-clause cannot also be represented as T-posterior to the orientation time in question. Instead, the situation time of the *after*-clause must as a rule be represented as W-simultaneous with the implicit Anchor time:

[I knew that] John would leave the country after he {*graduated* / **would graduate*}.

This means that the situation time of the *after*-clause cannot be represented as T-posterior to the situation time of the matrix clause (to which the situation time of the head clause is T-posterior) by means of the conditional tense. Like other English adverbial time clauses, *after*-clauses do not allow this form of indirect binding. This restriction on using the conditional tense also applies to the conditional perfect:

[I knew that] John would leave the country after he {*had graduated* / **would have graduated*}.

In this case too the situation time of the *after*-clause must be T-related to the implicit Anchor time (which *after* represents as W-posterior to the situation time of the head clause).

In a similar way, an *after*-clause whose situation time is interpreted as W-posterior to the situation time of the head clause uses the Pseudo-t₀-System rather than the Absolute Future System:

John will leave the country after he {*graduates* / **will graduate* / *has graduated* / **will have graduated*}.

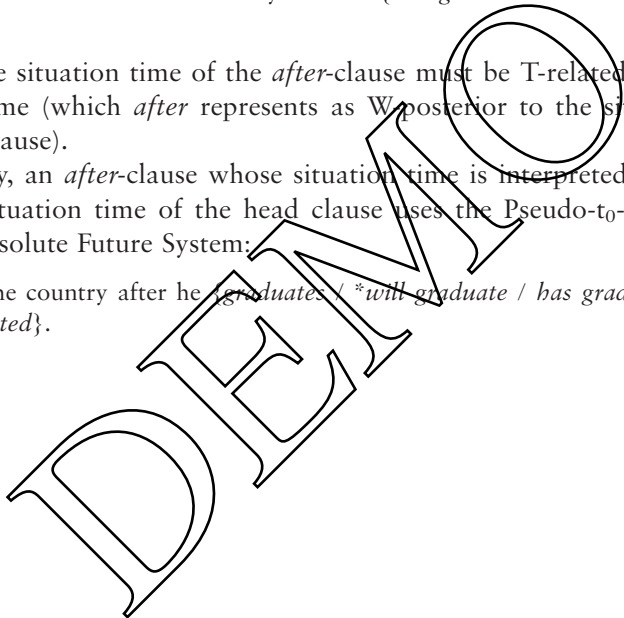

DEMO

Glossary

Notes:

- (a) The words underlined figure as separate entries in the glossary.
- (b) Hyphens have been disregarded in the alphabetic ordering. For example, 'situation-time adverbial' follows 'situation time' and precedes 'situation type'.

Absolute deictic time-specifying adverbial: time-specifying adverbial which indicates an Adv-time that is anchored to the temporal zero-point, e.g. *today, this morning, tomorrow, tonight, yesterday, three weeks ago, since last week, until now*, etc.

Absolute Future System: system of tense forms used to establish a (new) temporal domain in the post-present time-zone. This system comprises the future tense (in its use as an absolute tense rather than as a pseudo-absolute tense) (e.g. *I {will / shall} probably be there*), as well as other verb forms locating a situation time in the post-present (i.e. 'futurish' forms, as in *I'm going to do it*) and absolute-relative tenses such as the future perfect of the (nameless) tenses built with *will have been going to* or *will be going to*.

Absolute past tense (or absolute past or absolute preterite): past tense which creates a past domain. The semantics of this tense is: 'The situation time is located in the past time-sphere (which is defined relative to the temporal zero-point)'.

Absolute present tense: present tense used as an absolute tense (i.e. used to locate the situation time at the real temporal zero-point) rather than as a pseudo-absolute tense (locating the situation time at a pseudo-zero-point).

Absolute preterite: see absolute past tense.

Absolute relation: temporal relation between the temporal zero-point and some other time.

Absolute-relative tense: tense which combines the expression of the meaning of an absolute tense with the expression of a temporal relation in a temporal domain (see relative tense), in other words, a tense which both establishes a temporal domain and indicates a T-relation in it. A typical example is the future perfect (e.g. *I will have left*) which expresses two T-relations: 'The time of the situation is anterior to an implicit time of orientation' and 'the implicit time of orientation is posterior to the temporal zero-point'. Other absolute-

relative tenses are such (nameless) present time-sphere tenses as are built with *has been going to* or *will be going to* (and, at least theoretically, *has been going to have V-ed* and *will have been going to have V-ed*).

Absolute tense: tense expressing an absolute relation, i. e. which locates the time of a situation in one of the four absolute time-zones and in doing so relates it directly to the temporal zero-point. The preterite (e. g. *I did it*), the present perfect (e. g. *I have done it*), the present tense (e. g. *I'm doing it*) and the future tense (e. g. *I'll do it*) locate the situation time in the past, the pre-present, the present and the post-present, respectively.

Absolute time-zone: cover term for any of the four time-zones that are defined in direct relation to the temporal zero-point, namely the past time-zone, the pre-present time-zone, the present time-zone and the post-present time-zone. ('Time-zone' is a cover term for any of the four portions of the linguistic time line that together make up the two time-spheres. These four portions are the three parts of the present time-sphere (viz. the pre-present zone, the present zone and the post-present zone) plus the past time-sphere, which functions as a single zone. Since these four zones are defined in direct relation to the temporal zero-point, we call them 'absolute' time-zones.)

Absolute zone: see absolute time-zone.

Action: type of dynamic situation (or 'dynamic situation type') which actualizes under the control of an agent (e. g. *John dug a hole*).

Action verb: verb denoting an action, e. g. *walk, read, drink, look at, write, eat, abandon, ask, play*.

Actual world: possible world that is the real world, i. e. the world in which things are the way they are in the real world as we know it.

Actualization: noun related in its form and meaning to the verb actualize. It is the cover term used in this work for the performance of an action, the developing of a process, the holding of a state or the happening of an event. In all four cases we speak of the 'actualization' of the situation in question.

Actualization adverbial: indefinite time expression which does not inherently indicate a particular Adv-time but refers to the (non)actualization of a situation in a particular period, e. g. *already, always, not ... yet, ever, never, still, etc.*

Actualization aspect: linguistic category pertaining to whether the actualization of the situation referred to is or is not represented as bounded (i. e. as reaching an endpoint).

Actualization-explaining *because*-clause: clause which is introduced by the subordinating conjunction *because* and which expresses the reason for, or the

cause of, the actualization of the head clause situation. For example: [*He was killed*] *because he knew too much*.

Actualization focus: term used in the discussion of the past tense, more specifically in cases where the speaker is concerned with some aspect of the actualization of the bygone situation (e. g. when, where, how, etc. it actualized), rather than with its relevance to the present structure of the world, as is the case when the present perfect is used.

Actualize: verb used as cover term for the predicates that are typically associated with the four types of situation. If we wish to avoid having to specify whether a clause expresses the performance of an action, the happening of an event, the development of a process or the existence of a state, we say that the clause in question expresses the actualization of a situation. Contrary to common usage, the verb *actualize* is used intransitively (in a similar way to *happen*, but referring more generally to the actualization of any of the four types of situation).

Adjectival clause: subclause forming part of a noun phrase and modifying the noun head (e. g. [*The man*] *who lives next door* [*is looking at our house*]). An adjectival clause is always a relative clause or a participial clause.

Adverbial clause: subclause whose function is typically associated with that of an adverb or adverbial phrase (e. g. [*I'll help you*] *when I have time*).

Adv-time: abbreviation of 'adverbially indicated time'. Thus, in *We left at five*, the Adv-time is specified by the adverbial *at five*.

Adv-time adverbial: time-specifying adverbial, i. e. adverbial indicating an Adv-time.

Adv-time of the head clause: in a complex sentence, the adverbially indicated time 'containing' the situation time of the head clause (in terms of inclusion or coincidence). For example, the sentence *John left when Bill was in the kitchen* tells us that there was a time in the past at which Bill was in the kitchen, and that that time 'contained' the time at which John left.

Adv-time of the {when / before / after}-clause: in a complex sentence with a {*when / before / after*}-clause, the Adv-time containing the situation time of the time clause situation. For example, in *John left when Bill arrived*, the time of Bill's arrival is contained by the Adv-time specified by the word *when*, which is a headless relative that can be paraphrased as 'at the time when'.

Adv-time-relation: temporal relation between an Adv-time (= adverbially indicated time) and a situation time or other orientation time. Such a relation can only be one of 'containment', i. e. either coincidence or inclusion. Thus, if there

is an Adv-time relation between an Adv-time and a situation time, the Adv-time either coincides with the time of the (predicated) situation (as in *John left at five*) or includes that time (as in *John left yesterday*).

Adv-time-simultaneity: containment relation (i. e. proper inclusion or strict coincidence) between an Adv-time and a situation time or other orientation time. For example, in *John left {yesterday / at five}*, there is a relation of Adv-time-simultaneity between the Adv-time (indicated by *yesterday* or *at five*) and the situation time (= the time of John's leaving).

Agent: animate entity which performs or instigates a dynamic situation, i. e. which is responsible for the actualization of the situation because it does something that induces the situation to actualize.

Agentive: ontological feature of a situation-template (as expressed, for example, by the verb phrase *punched Bill on the nose*) which requires an agent for the actualization of the situation. The situation itself is then also said to be agentive (e. g. *John punched Bill on the nose*). An agentive situation need not involve intentionality, as when the agent does something accidentally, or under the influence of drugs, hypnosis, etc.

Aktionsart: (synonym of ontological aspect or lexical aspect): linguistic category pertaining to the way the lexical material in the verb phrase determines one or more inherent characteristics of a kind of situation (or, more correctly, a situation-template). For example, a verb phrase may represent a kind of situation as durative or punctual (compare, for example, *run* with *arrive*), as telic or atelic, as dynamic or static, etc.

Anchor time (or temporal anchor): the time to which an Adv-time is anchored, i. e. the time functioning as deictic source for the temporal relation expressed or implied by a deictic time-specifying adverbial. In the case of *today*, *yesterday*, *tomorrow*, etc. the Anchor time is the temporal zero-point. In the case of *that very same day*, *the next day*, *the day before*, etc. the Anchor time is not the temporal zero-point but a contextually given bygone or future time. In an *after*-clause or a *before*-clause, the Anchor time is the initial or terminal point, respectively, of the Adv-time indicated by the adverbial clause: the Anchor time is the point referred to by the second occurrence of the word *time* in 'at a time {after / before} the *time* at which', which is the semantic paraphrase of the conjunction.

Anchored time-specifying adverbial: see deictic time-specifying adverbial.

Anterior: adjective corresponding to the noun anteriority.

Anteriority: type of temporal relation. A given time A is anterior to a given time B if A either precedes B completely or starts before B and leads up to B

but without including it (or part of it). Anteriority is W-anteriority if A is interpreted as anterior to B in the possible world referred to. Anteriority is T-anteriority if it is expressed by a tense form. Thus, in *John was born in London and died in Glasgow*, the former situation is interpreted as W-anterior to the latter, but it is not represented as T-anterior to it: the two past tense forms merely locate the times of the two situations in the past. The same is true of *He said he got up early*. By contrast, in *He said he had got up early*, the time of the getting up early is not only interpreted as W-anterior to the time of the saying but is also represented as T-anterior to it by the use of the past perfect form *had got up*.

Argument: any of the constituents that a verb requires to be used grammatically in a normal finite clause: a subject, sometimes called the ‘external argument’ (because it does not belong to the predicate constituent), and possibly one or more ‘internal arguments’, usually called complements (e.g. a direct object).

Aspect: in this work we distinguish between ‘ontological aspect’ (or ‘lexical aspect’ or ‘Aktionsart’), ‘grammatical aspect’ and ‘actualization aspect’. Out of context, the unmarked interpretation of *aspect* is grammatical aspect.

Aspect auxiliary: the grammatical auxiliary *be*, which is used for building progressive verb forms. (Progressive aspect is the only kind of grammatical aspect that can be systematically expressed by verb forms in English.)

Aspectualizer: lexical verb like *begin, start, commence, quit, stop, finish, continue, go on*, etc., which is placed before a nonfinite clause and which expresses the situation described by this clause as beginning, ending or ongoing. Thus, go on is an aspectualizer in *Let’s go on working*.

Assertion (or statement): the illocutionary force of a declarative sentence. Sentences like *I love you* and *I don’t love you* ‘make an assertion’.

Assertive clause: A clause is assertive when the message (but not necessarily the form) of the clause is that of an affirmative assertion. Otherwise (i. e. when the message is negative and / or interrogative) the clause is nonassertive. Only nonassertive clauses can contain nonassertive items (‘negative polarity items’). A negative assertion like *I didn’t lift a finger to help him* is assertoric (= makes an assertion) but nonassertive – hence the use of the nonassertive item *lift a finger*.

Assertive item: word or phrase (often also called ‘positive polarity item’) which can normally only be used in an assertive clause, i. e. which cannot occur (except, sometimes, echoically) within the scope of a negator or question. For example, *already* is an assertive item: it can be used in positive (= affirmative) statements (e.g. *I have already met him*) and in interrogative clauses expecting

a positive reply (e.g. *Have you already seen him?*), but not in (nonechoic) negative statements (e.g. *I haven't met him {yet / *already}*), nor in interrogative clauses that do not expect a positive reply (e.g. *Have you seen him yet?*). Another example is 'far from + adjective': *He {is / *isn't} far from satisfied*).

Assertoric: A clause is assertoric if it realizes the illocutionary act of making an assertion. An assertoric clause is usually declarative, but there are cases in which an interrogative clause also makes an assertion: (a) if it expresses a rhetorical question, i. e. if the clause is interrogative in form but is interpreted as being declarative (e.g. *Need I say more?* on the interpretation 'Surely, I needn't say more.') and (b) if the interrogative clause expresses a 'yes / no-question' (= polar question) which is interpreted as an assertion followed by a question tag asking for confirmation, e.g. *Is he your leader, then?* Also assertoric are so-called declarative questions, i. e. sentences that have the syntactic form (word order) of a declarative sentence but are interpreted as asking a question, e.g. *You're his father?*

Atelic: ontological feature, the opposite of telic. Said of a situation-template (denoted by a verb phrase) which does not represent the kind of situation referred to as telic, i. e. as tending towards a natural point of completion beyond which the situation cannot continue. Thus, in *Betty ran*, the verb phrase ran is atelic (= not telic). We also apply the label to the kind of situation that is not represented as telic – thus, *running* is an 'atelic situation' – and, by further extension, to clauses containing an atelic verb phrase.

Atemporal when-clause: see case-specifying when-clause.

Attributive noun phrase: when used in Donnellan's (1966) sense, said of a noun phrase which has definite reference in the sense that the speaker assumes the hearer to be familiar with the expression (= NP) in question, but not with the identity of the referent of the phrase. For example, when a theft has been committed, the speaker can use the NP *the thief* even if he does not know who committed the theft and does not assume the hearer to know that either. In other words, Donnellan (1966) applies the label 'attributive' to a linguistic expression which is definite in the sense that it gives a description which both the speaker and the hearer are familiar with, but which is not sufficient for either to 'pick out' the referent from a set of potential referents.

Auxiliary: see auxiliary verb.

Auxiliary verb (or auxiliary): 'helper' verb, i. e. a verb which has the grammatical function of helping the speaker to build a complex verb form (e.g. *will* and *have* in *will have put*). Unlike a lexical verb (or 'full verb'), an auxiliary has little or no lexical meaning: it expresses either a grammatical notion (like 'passive', 'progressive', 'tense') or a modal idea (like necessity, possibility, permis-

sion, etc.) or it has no meaning at all and is used simply because an auxiliary is required in certain contexts. (This is true of the ‘periphrastic auxiliary’ do, as in “*I don’t like it. Do you?*” – “*Yes, I do.*”) Morphosyntactically, an auxiliary differs from a lexical verb in that it has the NICE-properties, i. e. it does not trigger do-support in clauses that are negative, interrogative, used in code or involving emphasis on the verb.

Background: in a narrative text, the linguistic material which refers to durative and descriptive situations and which provides subsidiary information about the foreground. (This material is then said to have a ‘backgrounding’ function. This means that it does not ‘push forward’ the story.)

Backshifting: (1) change of tense forms when there is a shift from a present time-sphere temporal domain to a past time-sphere temporal domain. For example, *Has he done it?* is ‘backshifted’ to *had he done it* in indirect reported speech after a verb in the past tense: *I wondered if he had done it*. The speaker can also use backshifting for various other reasons, e.g. for tentativeness: {*Will / would*} *you please help me?* However, the term is especially used in connection with past represented speech. In this book it refers to the phenomenon that a present time-sphere tense or an absolute past tense in the ‘original’ direct speech utterance seems to be adapted into, respectively, a corresponding past time-sphere tense or a past perfect as a natural result of the fact that the situation time which was ‘originally’ T-related to the temporal zero-point is now T-related to the central orientation time of a past domain. (Backshifting is thus a semantically motivated phenomenon, viz. the use of past time-sphere tenses in a past domain) rather than a purely formal operation.) Compare, for example, *The shop {is / will be / has been / will have been / was} closed* and *They said that the shop {was / would be / had been / would have been / had been} closed*. (2) See modal backshifting.

Basic orientation time: the time of orientation in the structure of a tense from which the temporal relations expressed by the tense begin to be computed. In most cases the basic orientation time is the temporal zero-point (t_0) (e.g. *He has done it*), but there are cases in which it is a post-present binding orientation time which is treated as if it were t_0 (e.g. [*If Jim does it*] *he will have to admit to his wife that he has done it*). In both examples, the present perfect form *has done* locates the time of the situation of Jim’s doing it before the basic orientation time. In the first example the basic orientation time is t_0 ; in the second it is a pseudo-zero-point, viz. the post-present situation time (= the time of admitting) which is treated as if it were t_0 . (See also Pseudo- t_0 -System.)

‘Before now’ interpretation: one of the two T-interpretations of the present perfect, namely ‘The situation time is included in the pre-present and covers a portion of the pre-present that is not adjacent to t_0 ’, as in *I’ve never seen*

that girl before. This T-interpretation corresponds to the inclusion sense of the containment relation (between the pre-present zone and the situation time) that is part of the core meaning of the present perfect.

Bifunctional temporal adverbial: temporal adverbial that functions at the same time as a time-specifying adverbial and as a duration adverbial. In other words, it specifies both the temporal location of the situation time and the length of the corresponding full situation, as in *I was there from six to eight*.

Binding (or temporal binding or temporal subordination): the phenomenon that a situation time is T-related to another situation time (or another orientation time) within a temporal domain. For example, in *Meg had seen Jill*, the situation time of *had seen* is bound by (or ‘temporally subordinated to’) an orientation time which is not explicitly referred to but forms part of a past temporal domain. (Strictly speaking, it is only situation times that can be bound, but by extension we can also apply the label to the situation itself. In this way we can say that in *Sue knew that Meg had seen Jill* the situation of knowing is the ‘binding situation’, while the situation of Meg seeing Jill is the ‘bound situation’.)

Binding orientation time: orientation time that serves as the starting point of a temporal relation expressed by a relative tense. Thus, in *Meg said that she had seen Jill*, the situation time of Meg’s speaking is a binding situation time because the time of her seeing Jill (= the ‘bound situation’) is represented as T-anterior to it by the past perfect tense.

Block (an implicature): prevent an implicature from arising. See implicate.

Bound: see bound situation time.

Bound situation time: situation time that is T-related to (or ‘temporally subordinated to’ or ‘temporally bound by’) an orientation time in a domain. Thus, in *Meg said that she had bought a bike*, the situation time of the situation of buying is bound by (more specifically: represented as T-anterior to) the situation time of the situation of Meg’s speaking (which is the ‘binding situation’).

Bounded: said of a particular instance of actualization of a situation, namely if the actualizing situation is either linguistically represented or W-interpreted as reaching a terminal point, i. e. as coming to an end. Thus, the clause *John read the letter* represents the situation of John reading the letter as having come to an end, unlike the clause *John was reading the letter*, which does not tell us whether John actually finished reading the letter or not. The term is also applied to clauses and sentences that represent (the actualization of) a situation as bounded.

Boundedness: the quality of being bounded.

Bounding constituent: constituent (of a clause) which adds the idea of a temporal right boundary, thus rendering the clause L-bounded, e.g. the object argument in *He read a poem*, the duration adverbial in *We worked for six hours* or the bifunctional temporal adverbial in *Jane was in her study from two to five*.

Bygone: preceding the temporal zero-point, i.e. located in the past zone or in the pre-present zone. For example, both *He did it* and *He has done it* represent the actualization of the situation referred to as bygone. We speak of a 'bygone situation' as well as of a 'bygone time'. A further distinction is made between 'T-bygone' (= linguistically represented as bygone by a tense) and 'W-bygone' (= what *is* bygone in the actual world but is not necessarily represented as bygone by a tense form).

Cancel (an implicature): deny that a suggested interpretation is correct. See implicate.

Case-specifying *when*-clause (or atemporal *when*-clause) *when*-clause which does not specify a time but describes the case(s) in which the head clause situation actualizes (i.e. the case(s) in which the head clause proposition is true). For example, *Children are orphans when their parents are dead*.

Central orientation time: the one orientation time in a temporal domain that is not T-bound by any other orientation time in the domain but is directly related to the temporal zero-point. In most cases the central orientation time is the situation time of the clause which establishes the domain by using an absolute tense (e.g. *knew* in *I knew that Tom hadn't seen the film yet and would want to go and see it*). When an absolute relative tense is used (e.g. *He will have left by tonight*) the central orientation time is the orientation time (here 'contained' in the post-present Adv-time specified by *tonight*) to which the situation time is temporally subordinated.

Central time of orientation: see central orientation time.

Clause: linguistic expression with a syntactic structure. A prototypical clause consists of a noun phrase functioning as subject and a verb phrase (and optionally some other constituents) functioning as predicate.

Cleft (or cleft construction, cleft sentence, *it*-cleft): specificational sentence of the form '*It* (or occasionally *this* or *that*) + *be* + focused constituent + *wh*-clause' in which the *wh*-clause expresses the variable to which a value (expressed by the focused constituent) is given, e.g. *It was JOHN who did it*. (This is interpreted as 'the x who did it was: John'.) Apart from a *wh*-clause, the variable may also be expressed by a *that*-clause (e.g. *It was John that did it*) or, provided the value is an indication of duration, a *since*-clause (e.g. *It's three weeks since he left*). In the latter case we speak of a since-cleft.

Cleft construction: see cleft.

Cleft sentence: see cleft.

Closed condition: a condition which the speaker assumes to be fulfilled in the actual world (e. g. *If, as you say, you can't accompany me tonight, [I'll have to look for someone else]*) or which he assumes to be going to be fulfilled in a future possible world (e. g. *If, as you say, he will come here himself tomorrow, [there is no point in phoning him now]*). Clauses expressing a closed condition are typically echoic.

Code: the use of an auxiliary as pro-form for an entire verb phrase (as in *John will not be sleeping, but I will*).

Co-extensive interpretation: one of the two T-interpretations of the present perfect, namely 'the situation time is co-extensive with the pre-present and therefore leads up to t_0 ', as in *I've been thinking about you*. This T-interpretation corresponds to the coincidence sense of the containment relation (between the pre-present zone and the situation time) that is part of the core meaning of the present perfect.

Coincidence: one form of containment relation (the other being inclusion). Coincidence may be the containment relation between the time of the full situation and a situation time which is strictly simultaneous with the former, as in *John left at five o'clock*. It may also be the containment relation between an Adv-time (= adverbially specified time) and a situation time, as in *John left at five o'clock*, or between an Adv-time and an orientation time to which the situation time is T-related, as in *At five o'clock John had already left*.

Common Adv-time: in a complex sentence involving a head clause and an adverbial when-clause, the Adv-time of the head clause is interpreted as coinciding with the Adv-time of the when-clause. (This coincidence relation is due to the semantics of *when*, which means 'at a / the time at which'.) The term 'common Adv-time' is used to refer to these two coinciding Adv-times.

Complement (or verb complement): a VP-internal argument of a verb, such as a direct object (e. g. [*I hit*] *him*), indirect object (e. g. [*I gave*] *him* [*a kite*]), subject complement (e. g. [*Bill is*] *ill*), object complement (e. g. [*We called him*] *a fool*), prepositional object (e. g. [*I looked*] *into the question* [*carefully*]).

Complement clause: clause functioning as complement of a verb, such as *that he was ill* in *He said that he was ill*.

Complex relation (or complex T-relation): temporal relation of the sort expressed by a complex relative tense. For example, the conditional perfect (*would have V-ed*) expresses T-anteriority to an orientation time which is itself

T-posterior to some other orientation time in a past domain. The combination of T-posteriority and T-anteriority is a ‘complex relation’.

Complex relative tense: tense expressing two or more temporal relations at once within the same temporal domain. Examples are the conditional perfect (e.g. *would have left*) and some nameless tenses with (very unusual) forms such as *would have been going to leave* or *would be going to have left*.

Complex sentence: sentence minimally consisting of one head clause and one subclause. A complex sentence may involve several subclauses, some of which function as head clauses supporting other subclauses. For example, in *John left after I had told him that his shirt was dirty*, the clause *after I had told him* is at the same time a subclause depending on *John left* (which is the ‘matrix’) and the head clause on which depends the subclause *that his shirt was dirty*.

Complex T-relation: see complex relation

Compound sentence: sentence consisting of two or more coordinate clauses (= clauses of equal rank), in other words, sentence in which none of the constituent clauses is syntactically subordinate to another, e.g. *I will trim the hedge and you will mow the lawn*.

Conditional: As a noun, this term is short for either ‘conditional sentence’ (i. e. a combination of a conditional clause and a head clause) or ‘conditional tense’.

Conditional perfect: see conditional perfect tense

Conditional perfect tense (or conditional perfect): complex relative tense whose forms are built by combining the auxiliary *would* with the perfect infinitive (*have V-ed*) of the main verb. The semantics of this tense is: ‘The situation time is T-anterior to an orientation time which is itself T-posterior to some orientation time in a past domain or in a past or pseudo-past subdomain.’ For example: [*Bill {promised / had promised}*] *that he would have finished the job by the end of the day*.

Conditional sentence: combination of a conditional clause and a head clause (e.g. *I won’t be sad if she dies*).

Conditional tense: relative tense whose tense forms are a combination of the auxiliary *would* and the present infinitive of the main verb. The semantics of this tense is: ‘The situation time is T-posterior to an orientation time that forms part of a past domain, (e.g. [*He promised*] *he would do it*), or of a past subdomain (e.g. [*He admitted that he had promised*] *he would do it*) or of a pseudo-past subdomain (e.g. [*Don’t always make promises. Sooner or later you will regret that you promised*] *you would do something*)’.

Conjugated verb (form): verb (form) showing conjugation. Synonym: finite verb (form).

Conjugation: the phenomenon that a lexical verb can be used in a number of different forms, expressing such notions as person, number (= singular or plural), tense and grammatical aspect, e.g. *work, works, worked, will work, has worked, is working*, etc.

Constituent negation (or **narrow scope negation**): i. e. negation which has only one constituent of the clause in its scope (e.g. *I told her nothing about it; It wasn't John who was responsible*).

Constitution reading (or **constitution interpretation**): particular type of up-to-now reading of a clause in the present perfect, namely that reading in which the speaker focuses on the situational constitution of the pre-present zone and not only on the temporal location of a situation in that zone. The speaker as it were looks back on the pre-present to 'measure' it (e.g. *Nearly a year has gone by since then*) or to see how this period has been filled 'situationwise' (e.g. *What have you been doing?; How many times have you met him in the past week?*).

Contain: verb indicating the temporal relation of containment that holds between the time of the full situation and the situation time or between an Adv-time (= time indicated by an adverbial like *yesterday*) and a situation time (or other binding time). The temporal relation in question may be one of (strict) coincidence or (proper) inclusion. Thus, in *At five o'clock I was jogging*, the Adv-time contains the situation time in terms of coincidence, and the time of the full situation is interpreted as including the (punctual) situation time. In *I was there from two to four o'clock* the Adv-time (indicated by a bounding bifunctional temporal adverbial) coincides with the situation time, and, because it is bounded, the time of the full situation also coincides with the situation time. In both these examples the Adv-time thus 'contains' the situation time in the sense that the two coincide with each other; in contrast, in *John left yesterday* the Adv-time 'contains' the situation time in terms of inclusion. (See also containment.)

Contained orientation time: orientation time that is specified (i. e. 'contained' in terms of either inclusion or coincidence) by an Adv-time. For example, in *John left yesterday*, the contained orientation time is the situation time, i. e. the time of John's leaving. In *At five o'clock John had already left the office*, the contained orientation time is not the situation time but another (nonlexicalized) orientation time to which the situation time is T-anterior. See also contained orientation time of the head clause.

Contained orientation time of the head clause: in a complex sentence with a {*when / after / before*}-clause, the contained orientation time of the head clause is that orientation time from the tense structure of the head clause that

is contained by the Adv-time established by the time clause. For example, in *John had already left when Bill arrived*, the contained orientation time of the head clause is the orientation time to which the situation time of the head clause is T-anterior.

Contained orientation time of the *when*-clause: in a complex sentence with a when-clause, the orientation time which is part of the tense structure in the when-clause and which is contained by the common Adv-time. This contained orientation time is either the situation time of the when-clause (as in *John left when Bill arrived*) or another orientation time to which the situation time of the when-clause is T-related (as in *John left when Bill had already arrived*).

Containment: (a) temporal relation between the time of the full situation and the situation time: the time of the full situation contains the situation time in terms of either inclusion or coincidence. In bounded clauses the time of the full situation coincides with the situation time (e.g. *Yesterday John ran two miles before breakfast*), whereas in nonbounded clauses it may either coincide with or include the situation time (e.g. [*“What was John doing from 5 to 5.30?”*] – [*“From 5 to 5.30 John was running his usual two miles before breakfast.”*]). (b) There is also a containment relation (again in terms of inclusion or coincidence) between an Adv-time (= adverbially specified time interval) and a contained orientation time.

Continuative interpretation (or continuative reading): one of three possible W-interpretations of a clause in the present perfect, namely that on which the full situation is taken not only to fill the entire pre-present (= period leading up to t_0) but also to extend beyond t_0 , so that the time of the full situation is taken to include the situation time (which coincides with the pre-present zone). Such a reading is realized, for example, in *Ian's been living in Lincoln since 1998*, which implies that Ian is still living in Lincoln.

Continuative perfect: present perfect tense form used in a clause receiving a continuative reading.

Continuous form: see progressive form.

Coordinate (*adj.*): said of two or more constituents of equal rank. For example, in a compound sentence like *John was angry and Mary was shocked*, the two clauses are ‘coordinate clauses’: the relation between them is one of ‘coordination’, not syntactic subordination.

Coordination: the phenomenon that a syntactic unit (construction) is formed which consists of coordinate constituents only.

Copula (or copular verb, linking verb): verb like *be*, *seem*, *become*, etc., which has to be followed by a subject complement (as in *John is {ill / a nerd}*) and which is incompatible with any other type of verb complement.

Copular verb: see copula.

Core meaning: the semantics of a tense, i. e. the tense structure expressed by the tense in question. For example, the core meaning of the present perfect is: 'The situation time is contained in the pre-present zone of the present time-sphere'. Given that containment can be defined in terms of either 'inclusion' or 'coincidence', there are two T-interpretations that are compatible with this core meaning: the 'before now' T-interpretation, which gives rise to the 'indefinite' W-interpretation (e. g. *I have seen that girl before*), and the co-extensive T-interpretation which gives rise either to an 'up-to-now' W-interpretation (e. g. *Where have you been?*) or to a 'continuative' W-interpretation (e. g. *I've been polishing this furniture for over an hour now*).

Counterfactual: contrary to fact; incompatible with the actual world and therefore belonging to a counterfactual world. The situation referred to in the counterfactual conditional clause *If John had been here ...* is a 'counterfactual situation'.

Counterfactual world: possible world which is assumed by the speaker to be incompatible with the actual world or with any future possible world which might (or might not) eventually become the actual world. For example, *If I were you ...* creates a counterfactual world; it refers to a situation which is incompatible with what is the actual world at any time.

Declarative question: sentence that combines the form (word order) of a declarative sentence with an interrogative meaning (e. g. *You're his father?*).

Declarative sentence (or statement): sentence which is not interrogative or imperative in form and makes an assertion rather than having the illocutionary force of another speech act (such as a question or imperative).

De dicto interpretation: see intensional interpretation.

Defective verb: verb which has only one or two forms, e. g. *must, ought to, can / could*.

Definite: said of a referring expression which is assumed by the speaker to be sufficient for the hearer to identify the referent. *Yesterday, in 1983, the day before*, etc. are definite time-specifying adverbials. *The man* is a definite noun phrase. Donnellan (1966) distinguishes between two kinds of definite noun phrases: attributive noun phrases and referential noun phrases.

Deictic adverbial: see deictic time-specifying adverbial.

Deictic time-specifying adverbial (or anchored time-specifying adverbial): time-specifying adverbial which relates the Adv-time which it specifies to an anchor time. For example: in *I heard that name yesterday*, the temporal anchor is the

temporal zero-point, since *yesterday* means ‘the day before t_0 ’. The anchor time may also be another time: see nondeictic time-specifying adverbial versus deictic time-specifying adverbial.

Denotation: meaning of a linguistic unit (a word, a phrase, a clause, etc.). The denotation of a verb (e.g. *walk*) is a simple situation-template; the denotation of a verb phrase (e.g. *walk to the church*) is an enriched situation-template, and the denotation of a clause is a situation. The denotation of a linguistic unit is to be distinguished from its reference (or referential meaning): in *John walked to the church*, the denotation of *walk to the church* is ‘go to the church on foot’, whereas the referential meaning of *John walked to the church* is the particular actualization of this kind of situation on a given past occasion. This particular actualization is the referent of the clause *John walked to the church*.

Denote: ‘mean’, in the specific sense of ‘have as its denotation’. See denotation.

Dependent clause: alternative term for subclause.

De re interpretation: see transparent interpretation.

Direct binding: the phenomenon that the situation time of a subclause is T-bound by the situation time of its own head clause. Consider the following example: [*The police knew that*] *the girl had told her friends once or twice that she was afraid to go home*. Here, the situation time of the second *that*-clause is represented as T-simultaneous with that of the first *that*-clause, whose situation time is itself represented as T-anterior to the situation time of the matrix clause. The fact that the situation time of the second *that*-clause is also W-anterior to the situation time of the matrix clause is not expressed by its tense form (*was afraid*).

Direct reported speech: reported speech in which the reported utterance or thought is not reported in the form of a subordinate clause (e.g. *He said that he was ill*) but is quoted as an independent sentence (as in *He said: ‘I am ill.’*).

Direct result: resultant state that inevitably comes about when the actualization of a situation is completed. For example, in *I’ve locked up the shop*, the completion of the action of locking up the shop automatically (and immediately) produces the state of the shop being locked up (even though this state is not likely to be a lasting one).

Discontinuation: the phenomenon that (the actualization of) a situation is no longer continuing at a given orientation time. See also implicature of discontinuation.

Dissective: typical characteristic of homogeneous clauses or homogeneous time adverbials. It means that any part of the referent of the clause or adverbial (i. e.

the actualization of a situation or an Adv-time, respectively) can be referred to by the same clause or adverbial that refers to the actualization or Adv-time as a whole.

Do-insertion: insertion of the periphrastic auxiliary *do* in clauses that require an auxiliary but would not contain one if there were no do-support.

Domain (or temporal domain): set of orientation times each of which is temporally related to another by means of a tense. At least one of these orientation times is a situation time (since any tense form locates a situation in time). A domain is normally established by an absolute tense form and expanded by one or more relative tense forms. The latter establish temporal subdomains. Thus, in *John said he had prayed*, the tense form *said* establishes a past domain and *had prayed* creates a subdomain within that domain.

Do-support: the phenomenon that in cases where an auxiliary is required the periphrastic auxiliary *do* is added to a lexical verb (except to *be*) because otherwise the clause would not contain an auxiliary. For example, because sentences like **I smoke not* or **Smoke you?* are ungrammatical, we have to apply do-insertion: *I don't smoke*, *Do you smoke?*.

Double pluperfect: the form '*had + perfect infinitive*', which is sometimes found instead of the past perfect in the conditional clause of a conditional sentence of the type illustrated by *I would have been happier if she had come*. For example: *Had he have lost his frame [it would have been all over for him]*.

Duration adverbial: nontechnical term for any temporal adverbial that specifies the length of a situation. In other words, a cover term for pure duration adverbials (e.g. *for a split second*, *for two hours*) and bifunctional temporal adverbials (e.g. *from six to eight*). (The latter specify both time and duration.)

Duration-quantifying constitution reading (or interpretation): particular type of constitution reading of a clause in the present perfect, which arises when the speaker is specifically concerned with the length of the pre-present zone and indicates this by a bounded sentence referring to a duration-specifying situation (e.g. *Nearly a year has gone by since then*).

Durative (or nonpunctual): ontological feature, the opposite of punctual. Said of a situation-template which is conceived of as having a certain duration. By extension, the term can also be applied to a verb phrase (e.g. *write a book*) denoting such a situation-template, as well as to a situation that is conceived of as having duration, even if this situation is in fact a durative hypersituation consisting of consecutive punctual subsituations (e.g. *Someone was knocking at the door*). The term *durative* is also applied to time-specifying adverbials that indicate a specific time which has some duration (e.g. *yesterday*) – see

durative time-specifying adverbial – and to nonpunctual duration adverbials (e. g. *for two hours*).

Durative situation verb: verb which denotes a durative situation-template.

Durative time-specifying adverbial: time-specifying adverbial which specifies an Adv-time that has some duration (e. g. *yesterday*).

Durative verb phrase: verb phrase which denotes a durative situation-template.

Dynamic (or nonstatic): ontological feature of some (punctual or durative) situation-templates. It means that the kind of situation referred to is not a state, and therefore involves change and requires an input of fresh energy to continue (e. g. walking). The term ‘dynamic’ is also applied to a verb phrase or predicate constituent lexicalizing a dynamic situation-template (e. g. *walked a mile*), as well as to the actualization of a dynamic situation (e. g. John’s walking a mile yesterday) and to a clause referring to such a concrete actualization (e. g. *John walked a mile yesterday*).

Effected NP: noun phrase referring to the entity that comes into existence as a result of an action (typically expressed by a verb of creation). For example, in *I’ve written a poem*, the direct object refers to an effected NP.

Egressive aspect (or terminative aspect): kind of grammatical aspect. A speaker expresses egressive aspect when he uses a special verb form to represent the actualization of a situation as ending. Since English lacks a special verb form to express egressive meaning, this aspect is not grammaticalized in English. (If we want to refer to the terminal part of a situation, we have to add an aspectualizer like *stop*, *finish*, *end*, *leave off*, etc. to the verb referring to the situation.)

Embedded clause: alternative term for subclause.

Enriched situation-template: what is denoted by a multi-word verb phrase (e. g. *walk to the church*). An enriched situation-template can be further enriched by elements that do not belong to the verb phrase proper but to the predicate constituent (e. g. *walk to the church merrily on Sundays*).

Epistemic: see epistemic modality.

Epistemic modality: modality having to do with the possible degrees of the speaker’s commitment to the truth of a proposition. For example, *This must be the answer!* expresses epistemic necessity, while *This cannot be the answer!* expresses epistemic impossibility (which can also, of course, be seen as a kind of epistemic necessity). Epistemic modality can be expressed by modal adverbs like *certainly*, *perhaps*, *possibly*, etc. or by auxiliaries like *must*, *should*, *ought to*, *will*, *can*, *could* and *need*. The representation of (the actualization of) a situation as factual, counterfactual or not-yet-factual also belongs to the realm of epistemic modality.

Event: type of dynamic situation (i. e. a dynamic situation type), e. g. bursting, exploding, falling off a ladder, snowing. An event differs from an action in that it does not actualize under the control of an agent but just happens. It differs from a process in that it is not evolving.

Event verb: verb denoting an event (e. g. *evolve, burst, take place, rain, occur, happen, break down, snow*).

Evidential *because*-clause: clause which is introduced by the subordinating conjunction *because* and which explains the basis on which the speaker comes to the conclusion that the head clause proposition is true. For example: [*There must be someone in the house*] *because there is a light on in one of the rooms*.

Evolving: ontological feature typical of processes (e. g. growing, getting dark, diminishing, deteriorating, etc.). This means that [+ evolving] is a feature of a situation-template which is at the same time dynamic, durative and non-agentive, and which is denoted by a verb phrase representing the kind of situation as gradually developing, i. e. as moving on a (usually implicit) scale. The term *evolving* can also be applied to the actualization of a process.

Expand (a domain): incorporate a new situation time into an existing temporal domain by using a relative tense form.

Expanded domain: temporal domain which comprises more than one situation time.

Experiential perfect: see perfect of experience.

Explanatory-resultative: said of a clause in the present perfect which receives an up-to-now reading and whose communicative function is to explain the origin of a present result. For example, [*Sorry I'm dirty.*] *I've been cleaning the cellar*. By extension the term is also applied to the tense itself. However, 'explanatory-resultative (present) perfect' is really short for 'clause in the present perfect having an explanatory-resultative function'.

Extensional interpretation: see transparent interpretation.

Factual: being, or having become a fact, in the actual world. Synonym of factual at t_0 .

Factual at t_0 (or t_0 -factual): said of a situation that has already actualized at the temporal zero-point (t_0) or is actualizing at t_0 . For example, *John left before Bill arrived* represents both situations as having actualized before t_0 and therefore as being past facts (i. e. as being 'factual at t_0 '). (By contrast, in *John wanted to leave before Bill arrived*, the *before*-clause is not interpreted as factual at t_0 because it refers to a situation which may or may not have actualized in the past: the situation of Bill's arrival was expected to actualize by John,

but it was not yet a fact at the time of the head clause situation and the speaker leaves it vague whether Bill eventually arrived or not.)

Factual full situation: In clauses in one of the perfect tenses with a continuative reading, this term refers to that part of the full situation that has actualized in a period leading up to the relevant orientation time (which is the temporal zero-point in the case of the present perfect). Thus, in *Meg has been talking to the elephant for an hour now*, the temporal adverbial specifies not only the length of the pre-present zone but also the duration of the situation time coinciding with that pre-present zone. The full situation may or may not include t_0 and extend into the post-present. If it does, it consists not only of a part that is factual at t_0 but also of a ‘potential’ present and post-present part. The part that is factual at t_0 is called the ‘factual full situation’. The entire situation, including both the t_0 -factual part and the potential part, is called the ‘potential full situation’.

Finite clause: clause whose verb form is a finite verb form.

Finite verb form: verb form that is marked for at least one of the grammatical categories tense, mood, person and number. For example, the finite verb form *works* is marked for tense (present), mood (indicative), person (third) and number (singular). (By contrast, a verb form that is an infinitive, gerund or participle is a nonfinite verb form.)

Focalizing *when*-clause: *when*-clause which does not specify the time of the head clause situation (or a time to which the time of the head clause situation is related) but expresses the speaker's temporal focus on a time of evaluation or observation. In one subtype, the *when*-clause suggests the idea of a travelling observing consciousness (e.g. *When you travel to Washington, Boston, Chicago or New York, the same problems exist*), in another, the focalizing *when*-clause indicates the ‘epistemic time of evaluation’, i.e. the time when the conclusion is reached that the statement made in the head clause is true (e.g. *When you look at the economics, this company needs a Japanese and a European partner to make it work*).

Foreground: in a narrative text, the linguistic material (sentences and clauses) which ‘pushes forward’ the story through time. (This material is said to have a ‘foregrounding’ function.) It is the foregrounding sentences and clauses of a story that form the ‘backbone’ of the story.

Foregrounding: see foreground.

Free indirect speech: type of represented speech in which an utterance or thought is represented in the form of an independent clause (which is not a quotation) rather than in the form of a subclause depending on a reporting

clause (as is the case in indirect reported speech sentences like [*He said*] *that he was ill and had to stay at home*). For example: [*He let me know that he couldn't come.*] *He was ill. He had to stay at home*. In free indirect speech, what is reported is more often a thought than an utterance: [*He took her threat seriously.*] *She would not hesitate to carry it out*. The report retains some typical characteristics of a direct speech clause. Thus, it can have the form of a direct question (i. e. with inversion) (e. g. [*The constable looked at me uncomprehendingly.*] *Why ever did I insist on being arrested?*), it can be followed by a question tag (e. g. *So, that was what they were going to do, was it?*), etc.

Free relative clause (or **headless relative clause**, **nominal relative clause**): relative clauses without an overt antecedent (= head), i. e. whose antecedent is incorporated into the relative pronoun itself. For example: *what he wanted* (which means 'that which he wanted'). Because there is no overt noun as antecedent, the relative clause itself functions syntactically like a noun phrase. Thus, in *What he wanted was unreasonable*, the free relative clause has the nominal function of subject. (This is why we can speak of 'nominal relative clause'.)

Full situation: the complete situation (referred to in a clause) as it actualizes in whatever possible world is being referred to. The full situation should be distinguished from the predicated situation. The latter is that part of the full situation (possibly all of it) about which a claim is made in the clause. As is clear from *Two minutes ago John was in the library* (which does not exclude that John is still there), it is the predicated situation rather than the full situation that is located in time by the use of a particular tense.

Full verb: see lexical verb.

Future: (a) As a noun, *future* can be short for 'future tense' or can be used as a nontechnical term meaning 'post-present zone'. (b) As an adjective, *future* is usually linked up with post-present time reference. For example, *future situation* means 'post-present situation', which is short for 'situation whose situation time is located in the post-present zone'. Similarly, when we speak of *future time reference*, we normally mean 'reference to a time lying in, or being coextensive with, the post-present time-zone'. Occasionally *future* indicates a relation of posteriority to an orientation time other than the temporal zero-point. For example, we can say that in *Ten years later Bill {was to / would} be the richest man in town*, the verb form *was to be* or *would be* expresses 'future in the past' or (more correctly) 'future from the past', i. e. future relative to a past orientation time.)

Future continuous: progressive form of the future tense.

Future perfect: see future perfect tense.

Future perfect tense (or future perfect): tense which is formed by combining the future tense auxiliary *will* (or *shall*) with a perfect infinitive. The future perfect is an absolute-relative tense, because it combines an ‘absolute relation’ with a relative one: *will* expresses T-posteriority to the zero-point, thus establishing a post-present domain, while *have V-ed* expresses T-anteriority to the pseudo-zero-point in this post-present domain. This anteriority is similar either to the relation of anteriority to t_0 expressed by the absolute past tense – compare *John left at five* with [*John will no longer be there at six because*] *he will have left at five* – or (more commonly) to the relation of anteriority to t_0 expressed by the present perfect – compare *John has already left* with *John will already have left (by then)*. Accordingly, the semantics of the future perfect is: ‘The situation time is located anterior to the central orientation time of a post-present domain.’ Since that central orientation time is treated as a pseudo-zero-point, this comes down to saying that a future perfect form creates either a pseudo-past subdomain or a pseudo-pre-present subdomain. In addition, the future perfect can also be used as a ‘pseudo-absolute-relative’ tense, as in [*He will say that*] *he will have finished before 5 o’clock*, where the origin of the T-posteriority relation expressed by *will* is not the (real) zero-point but a post-present pseudo- t_0 (viz. the situation time of *will say*).

Future tense: tense whose forms combine the present tense form of one of the auxiliaries *will* or *shall* (the latter in the first person only) and a present infinitive (e.g. *will come*). The basic use of the future tense is to locate a situation time in the post-present zone of the present time-sphere. However, in a post-present domain, it can also be used as a pseudo-absolute tense (e.g. [*I will say that*] *I will be absent the next day*).

Future tense auxiliary: the auxiliary *will* or *shall* (the latter in the first person only) when it helps to build a form of the future tense (as in *It will be cold tomorrow*) or of an absolute-relative tense like the future perfect (as in *He will have left by then*).

Futurish tense form: verbal expression which arguably combines future time reference with present time reference, more specifically, which links the post-present actualization of a situation to a particular kind of present state. Examples of futurish tense forms are the present progressive in *I’m leaving in a minute*, ‘*be going to* + present infinitive’ in *It’s going to rain*, and ‘*be to* + present infinitive’ in *The Queen is to leave for Canada tomorrow*. Like future tense forms, futurish tense forms establish a post-present temporal domain.

Futurish verb form: see futurish tense form.

Futurity: see posteriority.

Generic sentence: universal sentence that predicates a typical characteristic of a kind (species), e.g. *Horses do not eat meat*. The term is also sometimes

applied to habitual sentences that predicate a typical and permanent (nontemporary) characteristic of an individual (e.g. *Bill's cat chases dogs*).

Gerund: nonfinite verb form used in a gerund clause (e.g. [*I want to avoid her*] *getting [upset]*). See also present gerund and perfect gerund.

Gerund clause: nonfinite clause whose verb form is a gerund and which is typically used as a nominal clause, e.g. *being gay ... in By next week, you will write an essay on being gay {in antiquity / today / in the world of tomorrow}*. As this example shows, the situation time of *being gay* can be interpreted as anterior, simultaneous or posterior to the situation time of the situation referred to in the head clause.

Grammatical aspect: the use of a special grammatical form (more specifically: an inflectional suffix, an auxiliary or a combination of the two, as in the English progressive form) to express one of various meanings which have to do with how the speaker views the internal temporal structure of a situation.

Grammatical auxiliary: auxiliary with a purely grammatical function, e.g. the perfect tense auxiliary *have*.

Gricean Maxims: four principles of conversation, described by Grice (1975), which are conventionally observed by cooperative speakers and hearers, and which can trigger implicatures. See also Maxim of Quantity and Maxim of Relation.

Habit: situation that is characteristic of the referent of the subject noun phrase for an extended period of time (e.g. *John smokes*; *Bill mostly walks to work*). Because it is a characteristic, a habit is by definition a state. It does not necessarily involve repetition (e.g. *I used to be afraid of the dark*), but a habit is mostly a habitual-repetitive situation.

Habitual: being or expressing a habit. *John smokes* is a 'habitual sentence'. It refers to a 'habitual situation'. It has a 'habitual meaning (interpretation)', but is not an instance of habitual aspect because it does not contain a special verb form grammatically marking the situation as habitual. (The form *smokes* can also be used with a nonhabitual interpretation, e.g. in the historic present.)

Habitual aspect: kind of grammatical aspect characterized by the fact that the speaker uses a special verb form to represent a situation as a habit (i.e. as a situation which is characteristic of the referent of the subject NP over an extended period of time). (e.g. *She used to come and talk to him when she had finished working*).

Habitual-repetitive sentence: sentence referring to a habitual-repetitive situation.

Habitual-repetitive situation: habit involving repetition, i. e. habitual situation consisting of a number of similar or identical subsituations (e. g. *She comes to see me every night*). A habitual-repetitive situation is an example of a hyper-situation.

Habitual sentence: sentence interpreted as referring to a habitual situation.

Habitual situation: situation which is interpreted as being a habit, i. e. as being characteristic of the referent of the subject NP over a certain period, e. g. the situations referred to in *John smokes*, *We're eating outside while this spell of good weather lasts*, *His dog is black*. See also habitual-repetitive situation, permanent habit, temporary habit.

Head (of a phrase): see phrase.

Head clause: clause which forms part of a complex sentence and on which another clause (i. e. a 'subclause', 'subordinate clause', 'dependent clause', 'embedded clause') is syntactically dependent. In *John left after he had promised he would finish the report*, the matrix clause is *John left*. This clause is the head clause on which the subclause with *had promised* depends. The latter clause is itself the head clause of the subclause with *would finish*. As this example shows, a head clause (or 'superordinate clause') may or may not be the matrix of a complex sentence.

Headless relative clause (or free relative clause or nominal relative clause): relative clause whose relative pronoun 'contains' a covert antecedent. For example: *what he wanted* (which means 'that which he wanted'). For more information, see free relative clause.

Heterogeneous (or nonhomogeneous): (a) Ontological feature of a telic kind of situation: 'not homogeneous'. For example, the verb phrase *run three miles* denotes a telic situation-template; it refers to a kind of situation which is not interpreted as homogeneous (= the same all the way through); this means that the verb phrase is only applicable to the kind of situation as a whole: there is no part of the situation type referred to by *run three miles* that can also be referred to by this (nonprogressive) verb phrase; (b) On the level of the clause, 'heterogeneous' is a characteristic of the actualization of a concrete situation; *John is going to run three miles* is a 'heterogeneous clause' because it can only be used to refer to the post-present situation as a whole: there is no part of the future (actualization of the) situation that can be satisfactorily referred to by the same clause. As regards clauses and the actualizations they refer to, there is a perfect correlation between the features [+ heterogeneous] and [+ bounded]. *Sheila drank a glass of beer* refers to an actualization which is bounded, and therefore heterogeneous, so that we can speak either of a 'bounded sentence' or of a 'heterogeneous sentence'; (c) 'Heterogeneous' (or

‘nonhomogeneous’) can also be applied to the (actualization of) a situation: a bounded (or heterogeneous) clause refers to a bounded (or heterogeneous) situation; (d) The term ‘heterogeneous’ is also applied to an Adv-time and to the adverbial indicating it: a heterogeneous Adv-time adverbial can only refer to the Adv-time as a whole, not to any smaller portion of it (e.g. *from 1983 to 1986*). The Adv-time in question is then also said to be heterogeneous.

Historic present (or **historical present**): use of the present tense to locate the situation time of a bygone situation in the present in order to represent this situation vividly, as if it were actualizing here and now (e.g. *Last night I'm having a drink at the local pub. Suddenly this guy walks in and ...*).

Homogeneous: the opposite of ‘heterogeneous’. (a) On the level of the verb phrase, ‘homogeneous’ is an ontological feature of a durative situation-template: it means that a kind of situation is conceptualized as ‘the same all the way through’, i. e. as consisting of parts which are all of the same kind as the situation-template as a whole (e.g. *drink beer*). On this level, ‘homogeneous’ can be applied both to the kind of situation (which is then always atelic) and to the verb phrase denoting it. (b) On the level of clauses, ‘homogeneous’ is an inherent feature of nonbounded (actualizations of) situations. The sentence *She drank beer* can be called either a ‘homogeneous sentence’ or a ‘nonbounded sentence’. The actualization of the situation referred to, and by extension the situation itself, can also be called ‘nonbounded’ or ‘homogeneous’. A homogeneous clause can refer not only to (the actualization of) a situation as a whole but also to any representative part of it. Thus, if *John was walking* truly describes what John was doing between 2 o'clock and 4, it can also be used to describe what John was doing between 2 and 3, and between 2.30 and 3, etc. (c) In respect of Adv-times, homogeneity means that the Adv-time-adverbial can indicate not only the Adv-time as a whole but also portions of it. For example, *today* is a ‘homogeneous Adv-time-adverbial’ because any part of today, whether bygone, present or future, can be referred to as *today*. This explains why any of the absolute tenses is compatible with *today*: *I had no time for breakfast today, I haven't seen him yet today, I'm 21 today, I'm feeling queasy today, I will visit him today*.

Hot news reading (or **hot news interpretation**): a particular usage type (functional reading) of the indefinite perfect: the sentence in the present perfect is used to ‘announce’ a bygone situation, i. e. to present the bygone actualization of the situation in question as very recent and as having high current significance. For example: [*Have you heard?*] *Kim Clijsters has won the US Open!*

Hypersituation: repetitive situation, i. e. situation whose actualization involves the actualization of a number of similar subsituations, e.g. [*All the time I was speaking*] *John was nodding assent; She stabbed him six times with her penknife*.

Iconic sequencing: the unmarked interpretation of a sequence of two or more bounded clauses using an absolute tense form: the situations referred to are interpreted as actualizing in the temporal order in which they are referred to. Thus, the unmarked interpretation of *Bill hit John, who hit him* is that John hit Bill first, and then Bill hit John. (This unmarked interpretation can easily be overruled by the context, as in *Bill hit John, who hit him the day before*, or by pragmatic knowledge, as in *The policeman arrested John, who robbed the bank*).

Illocutionary force: the illocutionary force of an utterance is the intention of the speech act (e.g. promise, request, piece of advice, rebuke, etc.) performed by the speaker by making the utterance. For example, *Will you help me?*, *Shall I drive you there?* and *You will do as I say!* have the illocutionary force of a request, an offer of service and an instruction, respectively.

Imperfective aspect: cover term for inchoative, progressive or egressive aspect. Imperfective aspect is expressed by verb forms which do not refer to the actualization of a situation as a whole, but only to its beginning, middle or end. In English, progressive aspect is the only kind of imperfective aspect that is grammaticalized.

Imperfective meaning: meaning conveyed by a verb form expressing imperfective aspect.

Imperfective verb form: verb form which expresses imperfective aspect, i.e. which explicitly refers to only the beginning, middle or end of (the actualization of) a situation, not to the complete situation. For example, in *I was writing an essay [when Henry came in]* the progressive verb form *was writing* refers to the middle of the situation only (hence the possible paraphrase 'I was in the middle of writing an essay [when Henry came in].').

Implicate: to express an implicature, i.e. to suggest that something is the case unless there is a contextual or pragmatic indication to the contrary. For example, in clauses referring to a homogeneous situation the past tense implicates that the actualization of the situation referred to is over at the temporal zero-point. Thus, *Tim was very angry* suggests that Tim is no longer angry, but this implicature can be blocked or cancelled by the context: It is blocked (prevented from arising) by the presence of *already* in *Tim was already very angry yesterday*, and it is cancelled (explicitly denied) in *Tim was very angry – in fact he still is*.

Implicature: aspect of interpretation which does not follow from the semantic meaning of a word, constituent or construction but which either follows from contextual information or pragmatic knowledge of the world or results from the application of conversational principles, such as the Gricean Maxims. It is

typical of implicatures that they can be blocked or cancelled by the context – see implicate for examples.

Implicature of discontinuation: implicature attached to the use of the absolute past tense when the full situation is homogeneous and there is no linguistic or contextual indication that the situation time (= time of the predicated situation) is included in (and hence shorter than) the time of the full situation. The implicature says that under these conditions the situation time can be assumed to coincide with the time of the full situation and hence to be over at the zero-time. For example, *Meg swore a lot when she was younger* implicates that this is no longer the case. This implicature would be cancelled by the contextual addition of *and she still does*.

Implicit condition: condition that is not overtly expressed but is implicit in one of the constituents of the sentence, for example in a pro-form (e. g. [*I think we should go home now.*] *Otherwise it will be dark before we get home.* ('otherwise' = 'if we don't go')), or in a nominal (e. g. *THAT would be quite interesting.* ('that' = 'if that happened', etc.)).

Implicit orientation time: orientation time which is implicit in the semantics of a temporal conjunction. For example, in *By the time Bill had left the room it was too late to act*, the verb form *had left* represents the leaving as anterior to the implicit orientation time referred to by *the time* in the phrasal conjunction *by the time (that)*. Similarly, in *I wanted to be in the pub before Ted arrived*, the conjunction *before* means 'before the time at which' and arrived is a relative past tense form representing Ted's arrival as T-simultaneous with the implicit orientation time (lexicalized by *the time* in the paraphrase 'before the time at which').

Implicit pre-present: said of the length of the pre-present zone in the absence of a time-specifying adverbial or another contextual indication specifying this length. If it remains implicit, the pre-present zone is taken to be the shortest period that makes sense in the given context. Thus, in *Have you had breakfast yet?* the time span leading up to now will be interpreted as something like 'since you got up', not as, say, 'in the last few weeks'.

Inceptive aspect: see ingressive aspect.

Inchoative aspect: see ingressive aspect. See also partly inchoative interpretation.

Inclusion: 'Time A includes time B' means that B is shorter than A and falls within the boundaries of A. For example, in *I am his daughter*, the time of the full situation includes the temporal zero-point (time of speech). Inclusion is one form of the containment relation that exists not only between the time of

the full situation and the situation time but also between an Adv-time (= an adverbially specified time interval) and a situation time (or another orientation time). For example, in *Jim had already left before breakfast* the Adv-time indicated by *before breakfast* includes the (unspecified) orientation time to which the situation time (= the time of Jim's leaving) is represented as T-anterior. (Apart from inclusion, containment can in principle also mean coincidence. Thus, in *I left at five* the Adv-time contains the situation time in terms of coincidence: the time indicated by *at five* coincides with the time of my leaving.) What we call inclusion is often referred to as 'proper inclusion'.

Inclusive adverbial: see inclusive duration adverbial

Inclusive duration adverbial: adverbial measuring the duration of (the actualization of) a situation by answering the question *Within what time?*, e.g. [*He finished the work*] *in an hour*, [*Everything will be arranged*] *within the next five minutes*. Such an adverbial can be added to bounded clauses only, e.g. *I ran the marathon in less than two hours*; *Within the next five minutes I had served six clients*. (The same adverbials are not inclusive adverbials in clauses that receive an inchoative interpretation, as in *He was here in an hour*, which means 'It was an hour before he was here'.)

Inclusive reference: reference to a set which implies or implicates reference to all the members of the set. For example, in *I cleared away the glasses after the party*, the reference to the set of glasses is (by implicature) interpreted as reference to all the glasses of the relevant set.

Inclusiveness implicature: implicature that definite noun phrases should be interpreted as having inclusive reference, i. e. as referring to all the members of the set denoted by the definite noun phrase. Thus, *I've drunk the bottles of beer* implicates that I have drunk all the bottles of beer in question.

Incurable habit: typical behaviour that is (a) unpredictable in that it actualizes from time to time but not at set times, (b) unintentional (hence not controlled by an agent) and (c) usually interpreted by the speaker as annoying or disturbing. An incurable habit is typically expressed in a clause which combines a progressive verb form with an adverbial like *always*, *forever*, *perpetually*, *constantly*, etc. For example, the sentence *She's always imagining everybody is looking at her* refers to a habit which consists of a repetition of a kind of situation that is interpreted as lying beyond the control of the subject referent, in the sense that she cannot help thinking that everybody is looking at her (because it forms part of her nature to entertain such imaginary ideas).

Indefinite interpretation (or **indefinite reading**): one of three possible W-interpretations of a clause in the present perfect. On an indefinite interpretation, the situation time is located in the pre-present zone, and the time of the full

situation is taken to precede the temporal zero-point and to be non-adjacent to it. This reading is called ‘indefinite’ because it implies that the precise temporal location of the situation time remains indefinite: all that we know is that the situation time lies somewhere in the pre-present. For example: *Have you ever been to Togo?*; [*Nobody can enter the house, because*] *I have locked the door and hidden the key.*

Indefinite perfect: present perfect tense form used in a clause receiving an indefinite interpretation.

Indefinite reading: see indefinite interpretation.

Independent clause: clause that is used as a sentence or which is one of the coordinate clauses of a compound sentence or which functions as a head clause in a complex sentence (see also matrix). ‘Independent clause’ thus means ‘syntactically independent clause’, i. e. clause which is not a subclause.

Indirect binding: a special form of T-binding: the situation time of a subclause is T-bound by the situation time of a clause which is not the head clause on which the subclause in question syntactically depends but a clause higher up the syntactic tree. The situation of the subclause in question is then interpreted as W-simultaneous with the situation of its head clause, but the tense form of the subclause does not express T-simultaneity. For example: [*I remembered that*] *when I had first met him he had been wearing blue jeans*. Here, the situation times of *had met* and of *had been wearing* are interpreted as W-simultaneous with each other, but neither tense form expresses this relation: both situation times are represented as T-anterior to the situation time of *remembered*. Compare: direct binding.

Indirect reported speech: type of represented speech in which the reported utterance or thought is not quoted as an independent sentence (as in *He said: “I am ill.”*, which is an instance of direct reported speech) but is reported in the form of a subclause (e.g. *He said that he was ill*).

Indirect result: resultant state which is not a direct result (i. e. a resultant state that inevitably comes about when a situation is completed) but whose existence is implicated by a perfect tense form used in a particular kind of context. Consider, for example, the following piece of discourse: [*I’ve taken a lot of responsibility in my first job already.*] *I’ve taken the savings to the bank, I’ve dealt with difficult customers and I’ve locked up the shop*. Here, the present perfect tense forms implicate that I am considered a responsible employee, or that I have shown that I am a very capable employee, or something similar. These implicated present results are indirect results.

Indirect speech: see indirect reported speech, free indirect speech.

Infinitival clause (or **infinitive clause**): nonfinite clause whose verb form is an infinitive, e.g. *for you to come earlier* in *I was hoping for you to come earlier*.

Infinitive: see present infinitive and perfect infinitive. When we simply speak of ‘infinitive’, we normally have the present infinitive (i.e. the unmarked option) in mind.

Infinitive clause: see infinitival clause.

Ingressive aspect (or **inchoative aspect** or **inceptive aspect**): kind of grammatical aspect. Ingressive aspect means that the speaker uses a special verb form to represent the actualization of a situation as just beginning. This aspect is not grammaticalized in English: English does not have a special grammatical form to express ingressive meaning. It uses an aspectualizer like *begin* or *start* (inserted before the verb) instead.

Intensional domain: a nonfactual possible world established, for example, by a future tense form or by an intensional verb like *imagine*, *say*, *think*, *want*, etc. An intensional domain is a domain of interpretation which has its own presuppositions and truth conditions, in terms of which propositions can be evaluated and interpreted. An intensional domain always functions as a temporal domain. After a weak intensional verb (like *say*), the complement clause can optionally shift the domain (e.g. *He said that John and Shirley {were / are} not married*). This is not normally possible after a strong intensional verb (such as *imagine*, *fancy*, *dream*, *wonder*, etc.). [*Is that her?*] *I thought she {was / *is} taller*.

Intensional interpretation (or opaque interpretation): interpretation in terms of an intensional world. For example, in *John believes that Paris is the capital of Italy*, the *that*-clause is true in the intensional world of John’s belief, but not in (what the speaker knows to be) the actual world. That is, *Paris is the capital of Italy* is true on an intensional (opaque) interpretation, but not on a transparent one.

Intensional verb: verb (like *claim*, *believe*, *imagine*, etc.) creating an intensional domain. See also strong intensional verb and weak intensional verb.

Intensional world: possible world which is not the actual world (e.g. the world created by an *if*-clause). See also intensional domain.

Intentionality: the idea that an action is performed intentionally (consciously, deliberately). This feature is often included in the definition of agentivity, but not so in this book. (A sleep-walker opening a door is an agent, and so is someone opening a door under the influence of hypnosis, but in neither case is the agent in question acting intentionally.)

Intransitive verb: (a) Strictly speaking: a verb that can only take a subject argument, i.e. a verb which cannot be followed by a complement (e.g. *sit*);

(b) Informally, a verb that could take a complement but is used intransitively (i. e. without a complement), e. g. *eat* in *John was still eating when I left*.

Inversion: the phenomenon that the syntactic subject does not precede the verb form but follows the operator (i. e. the auxiliary or first of the auxiliaries). For example, there is a rule inversion in independent interrogative clauses that are not wh-questions. Compare *Has John left?* (with inversion) with *John has left* and *Who has left?* (without inversion). Inversion also occurs with *be* and *have*.

Inverted pseudo-cleft: pseudo-cleft in which the value constituent is processed as syntactic subject and the variable constituent as subject complement (e. g. *A BOOK was what he gave me*). See also specificational sentence.

Irrealis: referring to a counterfactual world.

Irregular verb (or strong verb): verb that does not form its past tense and / or past participle by the mere addition of a dental suffix (written as *-ed* or *-d*) to the stem of the verb (e. g. *blow – blew – blown; bring – brought – brought; creep – crept – crept; go – went – gone*).

It-cleft: cleft introduced by *it*. For example: *It was The Bard who wrote: "Let's kill all the lawyers"; It is with a profound sense of regret that I announce my resignation.*

Iterative aspect: see repetitive aspect.

Iterative verb: verb which represents a kind of situation as consisting of a rapid repetition of subsituations of the same kind, such as *hammer, twinkle, stutter, rattle, stammer*, etc. In other words: verb which has [+ iterative] as one of its ontological aspect features.

L-bounded: said of a bounded situation whose boundedness is a matter of linguistic representation (rather than of interpretation based on pragmatic inference). Also said of a clause or sentence representing a situation as bounded (i. e. as ending). For example: *Jim was in the library from two to four*. One case of L-boundedness is when a bounded meaning is produced by the combination of a telic verb phrase and a nonprogressive verb form, as in *I will write three letters (in the next half-hour)*: such a sentence is L-bounded.

Lexical aspect (or ontological aspect or Aktionsart): linguistic category pertaining to the way in which the lexical material in the verb phrase determines one or more inherent characteristics of a kind of situation (or, more correctly, a type of situation-template), for example, whether it is (conceived of and represented as) durative or punctual (compare, for example, *run* with *arrive*), telic or atelic, dynamic or static, etc.

Lexical meaning: semantic meaning of a word which has to do with the typical characteristics of the referents of the word in the actual world (or in whichever

possible world is being talked about). For example, the lexical verb *kill* has a lexical meaning because it refers to a specific type of situation which exists in the world as we know it. The auxiliary *have* in *They have left* does not have a lexical meaning but has a grammatical function: it is used to build a perfect tense form.

Lexical verb (or **full verb**): verb which differs from an auxiliary in that (a) it is not a defective verb, (b) it has a full lexical meaning and (c) with the exception of *be*, it requires do-support (i.e. the addition of *do*) in some types of questions, negative clauses, etc. (see NICE-properties). For example: *explode*, *play*, *melt*, *resemble*, etc.

Linking verb: see copula.

L-nonbounded: said of a nonbounded situation whose nonboundedness is a matter of linguistic representation (rather than of pragmatic inference). Also said of a clause or sentence failing to represent a situation as L-bounded.

Main clause: term sometimes used as an alternative to 'head clause' (= any clause on which another clause is syntactically dependent) and sometimes as an alternative to 'matrix' (= highest clause in the syntactic tree structure of a complex sentence). Because it is potentially ambiguous between these two meanings, the term 'main clause' is not used in this work. We use the unequivocal terms 'head clause' and 'matrix' instead.

Main verb: form of a lexical verb which is used in a verb form that also involves one or more auxiliaries (e.g. *walked* in *should have walked*, or *working* in *may have been working*).

Matrix: head clause which forms part of a complex sentence and is not a subclause of another head clause, e.g. the clause *John said* in *John said that he was thirsty because he had worked hard and that he badly needed a drink*. In other words, the matrix is the highest clause in the inverted tree structure representing the syntactic structure of a complex sentence.

Matrix clause: see matrix.

Maxim of Quantity: one of the Gricean Maxims. The most important claim of this Maxim is that a cooperative speaker should give the addressee all the information that is needed for a good understanding of the sentence(s) uttered. Because of this Maxim, a sentence like *Kill the hostages!* implicates (and will be understood as meaning) that *all* the hostages should be killed (otherwise the speaker should add an expression restricting the reference to the set of hostages, as in *Kill the oldest six of the hostages!*) – see inclusiveness implicature.

Maxim of Relation (or **Maxim of Relevance**): one of the Gricean Maxims. The most important claim of this Maxim is that a cooperative speaker should only

say things that are relevant to the current discourse. This is why in [*"I don't think John has a girl-friend."* – *"Well,] he took Sybil out three times last week,* the reply suggests (= implicates) that John does have a girl-friend, namely Sybil.

Maxim of Relevance: see Maxim of Relation.

Measure phrase: phrase 'measuring' a time interval, i. e. indicating the duration of the interval or making clear where its right boundary lies. The interval in question may be the time span taken up by the actualization of a situation. In the following examples, the measure phrases are underlined: *John walked three miles / Simon slept for four hours / Soames repaired all these cars this morning.*

Metalinguistic negation: wide scope negation used to reject the truth of the sentence as a whole, i. e. to contradict a statement or implicature to the contrary. For example: [*"The party was boring."*] – *"The party was NOT boring. [On the contrary, it was quite lively."].*

Modal backshifting: the substitution of the past perfect for the past tense in a *before*-clause in order to trigger a not-yet-factual meaning. For example, whereas *I saw him before he saw me* is roughly equivalent to 'He saw me after I saw him', *I saw him before he had seen me* is interpreted as 'He had not seen me yet when I saw him'.

Modality: semantic category comprising two types of meaning: (a) the representation of the speaker's assessment of the likelihood that a proposition is true (or that the situation referred to by a proposition actualizes), and (b) the representation of one of the factors affecting the (non)actualization of the situation referred to, such as (un)willingness, (im)possibility, (in)ability, obligation, necessity, advisability, permission, prohibition, volition, etc. Modality which has to do with the truth of the utterance is called epistemic modality. The other type is referred to as nonepistemic (or root) modality.

Momentary: (synonym of punctual): lasting for a very short moment only, having no observable duration.

Mood: grammatical (formal) category referring to the systematic use of lexical verb forms not preceded by a modal auxiliary to express particular kinds of modal meaning. English is generally considered to have three moods, viz. the indicative, the imperative and the subjunctive.

Multiple-orientation-time adverbial: time-specifying adverbial denoting an Adv-time which contains two or more orientation times (which are usually situation times). For example, in *Yesterday Sue left before Beth arrived*, the times of the two situations referred to are included in the Adv-time specified by *yesterday*, which is therefore a multiple-orientation-time adverbial.

Multi-zone time-specifying adverbial (or **multi-zone adverbial**): deictic time-specifying adverbial specifying a time span which includes more than one time-zone. For example, *today* indicates a period which includes the present zone (= t_0) as well as the post-present and the pre-present or the past, and is therefore compatible with any of the four absolute tenses: *He's doing it today, He finally did it today, He's done it today, He'll do it later today.*

Narrative before-clause: foregrounding before-clause. See narrative time clause.

Narrative time clause: time clause which does not specify an Adv-time (containing the situation time of the head clause) but 'pushes forward the action', i. e. forms part of the backbone (= foreground) of the story. A typical instance is a 'narrative *when*-clause', as in *We had just entered the building when there was a terrific explosion in the street*, where the head clause situation specifies the time of the *when*-clause situation rather than the other way round. The following is an example of a 'narrative *before*-clause': [*When he arrived at the house*] *he hesitated a moment before he rang the bell.*

Narrative when-clause: foregrounding when-clause. See narrative time clause.

Narrow scope negation: negation which has only one constituent of the clause in its scope (e. g. *JOHN was not responsible, [it was Fred!]*)

Narrow scope question: question which has only one constituent of the clause in its scope (e. g. *Who did you see?, Was it John who was responsible?*). Wh-questions always have narrow scope.

Necessary adverbial: adverbial that cannot be omitted without a drastic change of meaning or without creating an ungrammatical or nonsensical clause. In *I put the books on the table*, the prepositional phrase *on the table* is such a necessary adverbial. Like verb complements, necessary adverbials form part of the verb phrase of the clause.

Negative polarity item: see nonassertive item.

Neutral prediction: use of the future tense auxiliary *will* (or *shall*) in cases where the speaker merely predicts something or assumes that something is likely to happen, without representing the post-present (non)actualization of the situation as determined by present circumstances, such as the present volition or intention of the subject of the sentence or a present possibility, necessity, arrangement, etc. For example: *Tomorrow it will be rainy but warm.*

NICE-properties: morpho-syntactic characteristic of auxiliary verbs: unlike lexical verbs (except *be*), auxiliaries are used without do-support in clauses that are negative, interrogative, used in code or involving emphasis on the verb. ('NICE' is an acronym for 'negation, interrogative, code, emphasis'.) For

example, we say *He {doesn't work / *works not}*, but *He {hasn't worked / *doesn't have worked}*.

Nominal clause (or **noun clause**): subclause with a nominal function, i. e. a function typically associated with a noun phrase. For example: in [*I don't know*] *if I can believe that [because my sister denies it]*, the *if*-clause is a nominal clause because it functions as complement of the verb *know*.

Nonassertive clause: clause of which the message is not that of an affirmative assertion, i. e. the message is negative and / or interrogative. Only nonassertive clauses can contain nonassertive items ('negative polarity items'). Thus, a negative assertion like *I didn't lift a finger to help him* is assertoric but nonassertive – hence the use of the nonassertive item *lift a finger*.

Nonassertive item: word or expression (often also called 'negative polarity item') which can appear in nonassertive clauses only (e. g. *at all*).

Nonbounded: not represented as having boundaries. See nonbounded clause, nonbounded noun phrase, nonbounded situation, L-nonbounded, W-nonbounded.

Nonbounded clause: clause which does not represent the actualizing situation referred to as bounded. A nonbounded clause refers to a nonbounded situation and is by definition homogeneous.

Nonbounded noun phrase: noun phrase with nonbounded reference, i. e. noun phrase referring to a set or mass whose boundaries are unspecified (e. g. *bees*, *milk*). A nonbounded noun phrase has homogeneous reference: *bees* can indicate any set or subset of bees that contains at least two bees; any amount of a given amount of milk is milk.

Nonbounded situation: said of a particular instance of actualization of a situation. On the level of linguistic representation it means that the clause referring to the actualization of the situation does not represent it as bounded (= reaching a terminal point, coming to an end). On the level of interpretation, it means that the actualization is not interpreted as terminating. Sentences like *John was reading the letter* or *John drank whisky* do not involve reference to a terminal point, so that the actualizations referred to are not represented as bounded. However, it is possible that for pragmatic reasons the actualization of a situation which is not linguistically represented as bounded is *interpreted* as being over (and hence as bounded). If that is the case, the (actualization of) the situation is W-bounded, but still L-nonbounded (= not linguistically represented as bounded). A nonbounded clause is by definition homogeneous.

Nonboundedness: the quality of being nonbounded.

Nondeictic adverbial: shorthand for nondeictic time-specifying adverbial.

Nondeictic time-specifying adverbial (or **unanchored time-specifying adverbial**): time-specifying adverbial which does not relate the Adv-time to an anchor time. For example: in *I've heard that name at some time or other*, the Adv-time specified by *at some time or other* is not linked to a given temporal anchor.

Nondurative: see punctual.

Nonepistemic (or **root**) **modality**: type of modality that is not concerned with the truth of the utterance but either with the speaker's attitude towards the actualization of a situation (e.g. *You must pay me back now!*) or with other factors affecting the (non)actualization of the situation referred to, such as the presence or absence of willingness (e.g. *I won't help you if you don't pay me*), possibility (e.g. *Aerosols can explode*), ability (e.g. *John can swim*), etc.

Nonfactual world: a possible world which is not the actual world at a given time. A nonfactual world is either counterfactual (as in *If only I was younger!*), not-yet-factual (as in *I will leave tomorrow*) or purely hypothetical (as in *If he changed his mind ...* or *If he comes ...*).

Nonfinite clause: clause whose verb form is a nonfinite verb form. Gerund clauses, infinitival clauses and participial clauses are nonfinite clauses.

Nonfinite verb form: a verb form that is an infinitive, gerund or participle. Such a verb form is not finite because it is not marked for tense, mood, person or number.

Nonhomogeneous: see heterogeneous.

Noninclusive duration adverbial: duration adverbial answering the question *For how long?* (rather than *Within what time?*, as in the case of an inclusive duration adverbial), e.g. *for hours*, *all afternoon*. Such an adverbial can be added to nonbounded clauses only (disregarding a repetitive interpretation of bounded clauses), e.g. *I ran all afternoon* (*I ran* is a nonbounded clause); **I ran a mile for three days* (*I ran a mile* is a bounded clause).

Nonpast time-sphere: see present time-sphere.

Nonprogressive form: verb form which does not express progressive aspect and therefore does not consist of a form of *be* followed by the present participle. For example: *walked* in *John walked home*.

Nonprogressive meaning: the aspectual meaning that (the actualization of) the situation referred to is not viewed as ongoing (= in progress) at the relevant vantage time. Nonprogressive meaning is normally expressed by a nonprogressive verb form.

Nonprogressive past: nonprogressive form of the past tense.

Nonprogressive present: nonprogressive form of the present tense.

Nonprogressive tense form: nonprogressive form of a particular tense (e.g. *walked, walks, has walked, will walk ...*).

Nonpunctual (or durative): see durative.

Nonquantificational constitution interpretation: see nonquantificational constitution reading.

Nonquantificational constitution reading (or nonquantificational constitution interpretation): particular type of constitution reading of a specificational clause in the present perfect, namely the one in which the speaker is concerned with the nature of the situation that is conceived of as having lasted throughout the pre-present zone without including the temporal zero-point (e.g. *What have you been doing?*; *Where have you been?*).

Nonrepetitive aspect: the opposite of repetitive aspect: the verb form represents a situation as actualizing only once.

Nonrepetitive situation: situation that actualizes only once, i.e. a semelfactive situation. A nonrepetitive situation is not a hypersituation consisting of subsituations of the same kind.

Nonstatic: see dynamic.

Nontensed (or tenseless or untensed) verb form: verb form which is not marked for tense, i.e. which does not encode information about how a situation time is related (directly or indirectly) to the temporal zero-point. Nonfinite verb forms and subjunctive verb forms are tenseless in this sense.

Not-yet-factual (or not-yet-factual at t): see not-yet-factual at the binding time.

Not-yet-factual at t_0 : said of a situation whose actualization is located in the post-present, since the predicted actualization is not yet a fact at t_0 , and has not even started to become a fact at t_0 .

Not-yet-factual at the binding time (or not-yet-factual at t): in a complex sentence, the interpretation that the actualization of the situation of the subclause is not yet a fact (i.e. has not yet actualized) at the time of the situation of the head clause. For example, in the sentence *John {left / wanted to leave} before Bill arrived*, the situation of Bill's arrival (irrespective of whether or not it eventually actualized at all) is interpreted as 'not-yet-factual at the time of John's leaving', since *before* represents the subclause situation as posterior to the head clause situation.

Not-yet-factual before-clause: *before-clause* that is not-yet-factual at the binding time. For example, in the sentence *John left before Bill had arrived*, the

situation of Bill's arrival (irrespective of whether or not it eventually actualized at all) is interpreted as envisaged but still nonfactual (= not yet factual) at the time of John's leaving: The natural reading of this sentence is 'Bill hadn't yet arrived when John left'. Nothing is said about whether Bill eventually arrived or not. See also modal backshifting.

Noun phrase (NP): a phrase (= structured set of words forming a syntactic unit) whose head is a noun or a nominal (such as a pronoun or gerund). For example: *the girl in the corner; something special; those who are afraid; that poor handling of the case by the police*. The set forming the phrase may be a singleton: in that case the phrase consists only of a noun or nominal (e.g. *Elephants like walking*).

NP: conventional linguistic abbreviation of noun phrase.

Number-quantifying constitution interpretation: see number-quantifying constitution reading.

Number-quantifying constitution reading (or interpretation): particular type of constitution reading of a clause in the present perfect: the clause is interpreted as expressing the speaker's concern with how many times a specific situation (or kind of situation) has actualized in the course of the pre-present zone (e.g. *How many times have you met him in the past week?*).

Ontological aspect (or lexical aspect or Aktionsart): linguistic category pertaining to the way the lexical material in the verb phrase determines one or more inherent characteristics of a kind of a situation (or, more correctly, a type of situation-template), for example, whether it is (conceived of and represented as) durative or punctual (compare, for example, *run* with *arrive*), telic or atelic, dynamic or static, etc.

Ontological feature: one of the features constituting the ontological aspect (= lexical-aspect) of a situation-template denoted by a verb phrase. For example, *drive* (when used as a one-word verb phrase) denotes a situation-template having the ontological features [- static], [+ agentive], [+ homogeneous], [- transitional], [+ durative], [- telic].

Opaque interpretation: see intensional interpretation.

Opaque world: see intensional world.

Open condition: condition which is treated as one that may or may not be fulfilled. For example: [*There will be a lot of damage*] if the hurricane passes over this area; or [*I don't know if Liverpool won this afternoon, but*] if they did, [*they must be top of the League now.*]. An open condition concerning the post-present is not expressed by a tense form from the Absolute Future System

but by a tense form from the Pseudo-t₀-System: [*We'll be in trouble*] if there {*is* / **will be*} a strike tomorrow.

Operator: the first auxiliary in a complex verb form, e. g. *would* in *would have been killed* or *has* in *Has he lied?* If the verb form is marked for one or more of the categories person, number, mood and tense, it is the operator that is morphologically marked.

Optional adverbial: adverbial that is not a necessary adverbial and therefore does not form part of the verb phrase of the clause. For example: *carefully* in *I carefully put the books on the table*.

Orientation time: any time functioning as the origin of a temporal relation expressed by a tense form. There are five kinds of orientation time: the temporal zero-point (as in *He was there*, which relates the situation time to t_0 in terms of 'pastness'), a situation time (as in *I thought that he was feeling sick*, where *was feeling* expresses T-simultaneity with the situation time of *thought*), an unspecified orientation time (as in *He had already left*, where the orientation time to which the situation time of *had left* is T-anterior is not specified), an otherwise unspecified time contained in an Adv-time (as in *At five he had already left*) or an implicit orientation time (as in *He arrived before I had left*, where *had left* represents its situation time as anterior to an orientation time that is implicit in *before*, which means 'before the time at which').

Orientation-time adverbial: time-specifying adverbial indicating an Adv-time which does not contain (in terms of either inclusion or coincidence) the situation time but contains the orientation time to which the situation time is temporally subordinated. For example, in *John will already have left at five* the time adverbial *at five* specifies an Adv-time which contains the (otherwise unspecified) orientation time to which the situation time (= the time of John's leaving) is represented as anterior. The same is true of {*The next day* / *At five o'clock*} *John had already left*.

Participial clause: nonfinite clause whose verb form is a participle, as in *Having missed my train, [I had to wait on that cold platform for another fifty minutes]*.

Participle: see present participle and past participle.

Participle clause: see participial clause.

Partly inchoative interpretation: the interpretation of a sentence like *I had dinner at seven o'clock*, which combines the idea 'I had a full dinner' and 'I started eating at seven o'clock'. (A 'purely inchoative' interpretation would be 'I started having dinner at seven o'clock', which would leave it vague whether I finished my dinner or not.)

Past: (a) Used as a noun, *past* can be shorthand for past zone (or past time-sphere); (b) *Past* can also be used as an adjective modifying the noun situation,

this combination then being short for ‘situation whose situation time is located in the past zone (or past time-sphere)’. (Similarly, when we speak of, for example, a *past period* or a *past point in time*, we mean a period or a point located in the past zone or past time-sphere.); (c) The noun *past* is occasionally also used as shorthand for ‘past tense’ (in the sense of ‘preterite’), when there can be no confusion, as in the combination ‘(non)progressive past’.

Past continuous: progressive form of the past tense.

Past domain: see past temporal domain.

Past participle: nonfinite verb form like *taken*, *walked*, *crept*, *spun*, *known*, etc. which follows the auxiliary verb(s) in a perfect or passive verb form (e.g. *taken* in *has taken*, *had taken*, *was taken*, *would have been taken*, etc.). Some past participles can also be used as modifiers to the head of a noun phrase, e.g. *handed over* in *Next week, I will carefully examine the report handed over to us tomorrow*. Such adjectival past participles are mostly interchangeable with relative clauses: *Next week, I will carefully examine the report that will be handed over to us tomorrow*.

Past perfect: shorthand for past perfect tense.

Past perfect tense (or pluperfect): tense whose forms (e.g. *had said*) are built by combining the past tense form of the auxiliary *have* with the past participle form of the main verb. The semantics of this tense is: ‘The situation time is T-anterior to an orientation time in a past domain, or in a past subdomain (= any subdomain within a past domain), or in a pseudo-past subdomain (within a post-present domain)’. For example: *John said he had done it*; *John said that he would leave immediately after he had done it*; [*If John does it*] *he will tell everybody afterwards that he left immediately after he had done it*.

Past subdomain: subdomain within a past temporal domain.

Past subjunctive: form of the subjunctive, which is a type of mood. In English, the only possible past subjunctive form is *were* (as in *If I were you, I wouldn't do it*), called ‘past’ because of its formal contrast with the present subjunctive form *be* and its formal identity with the past indicative form *were*. The meaning of the past subjunctive is not factual but either counterfactual (e.g. [*I wish*] *he were here*; *If I were you ...*) or tentative (e.g. *I would be surprised if he were to do that*).

Past temporal domain (or past domain): temporal domain established (by one of the past time-sphere tenses) in the past time-sphere. For example, in *Erin arrived late*, the past tense form *arrived* establishes a past domain. A past domain may sometimes comprise one or more situation times that are not W-anterior to the temporal zero-point, as in *He promised me yesterday that he*

would do it tomorrow, but that is irrelevant to the definition of ‘past temporal domain’. A domain is a past domain if and only if its central orientation time is located in the past time-sphere.

Past tense (or **preterite**): (a) The tense realized in such tense forms as *ran*, *walked*, *was*, etc. In this work we distinguish between the absolute past tense (or ‘absolute preterite’), which locates a situation time in the past time-sphere and in doing so establishes a past domain, and the relative past tense (or ‘relative preterite’), which expresses T-simultaneity in a past domain. (For example, in *John said he was feeling tired*, *said* is an absolute past tense form and *was feeling* is a relative past tense form.); (b) Both ‘past tense’ and ‘preterite’ are sometimes used (sloppily) in the sense of ‘past tense form’ (as in *The preterite ‘left’ in ‘John left early’ is an absolute preterite.*); (c) The plural form *past tenses* (but not **preterites*) is sometimes used as an abbreviation of ‘past time-sphere tenses’ (i.e. the four tenses used to locate a situation time in a past domain, viz. the preterite, the past perfect, the conditional tense and the conditional perfect).

Past time-sphere: time-sphere conceptualized as a time span of indefinite length which lies wholly before the temporal zero-point (t_0) and is disconnected from t_0 .

Past time-sphere tense: cover term for any of the four tenses which typically represent a situation time as forming part of a temporal domain that is established in the past time-sphere: the past tense (or preterite), the past perfect, the conditional tense (realized as ‘*would* + infinitive’) and the conditional perfect (realized as ‘*would have* + past participle’). These tenses all involve a past tense inflectional morpheme.

Past time-zone: see past zone.

Past zone (or **past time-zone**): alternative term for ‘past time-sphere’. (The terms zone and time-sphere are equivalent where the past is concerned, but not where the present time-sphere is concerned, which involves three time-zones, viz. the pre-present, the present and the post-present.)

Past-zone adverbial: single-zone time-specifying adverbial which specifies a time in the past zone. Such an adverbial can combine with the past tense but not with the present perfect. For example: *The doctor {came / *has come} yesterday*.

Perfect: shorthand for present perfect, present perfect tense form or perfect tense. The use of the term in any of these senses is avoided in this work: the full terms are used instead.

Perfect auxiliary: see perfect tense auxiliary.

Perfect gerund: nonfinite verb form which is made up of the present gerund form *having* followed by a past participle form and which has a nominal syntactic function, e.g. *having made* in *I admit (to) having made a mistake*. The perfect gerund, though nontensed in our account, expresses anteriority to the time of the head clause situation.

Perfect infinitive: nonfinite verb form made up of the present infinitive form *have* followed by a past participle form, e.g. *have eaten, have been eaten*. The perfect infinitive, though nontensed in our account, expresses anteriority to the time of the head clause situation.

Perfect of experience (or experiential perfect): (in this work), a particular usage type (= a functional reading) of the indefinite perfect, namely one which refers to the actualization of one or more W-bygone situations which are not necessarily recent but which are ‘carried along’ as part of one’s experience and knowledge. For example: *Have you ever been to Casablanca?*

Perfect tense auxiliary: the grammatical auxiliary *have*, which combines with a past participle to form a perfect tense form.

Perfect tenses: cover term for any of the four tenses whose tense forms involve the perfect tense auxiliary *have*: the present perfect (e.g. *I have done it*), the past perfect (e.g. *I had done it*), the future perfect (e.g. *I will have done it*) and the conditional perfect (e.g. *I would have done it*).

Perfective aspect: kind of grammatical aspect: the speaker’s choice of verb form (which is necessarily nonprogressive) reflects his wish to refer to (the actualization of) a situation in its entirety. There is no specific reference to any of the portions (beginning, middle or end) of the actualizing situation.

Perfective meaning: the idea that the verb form refers to the actualization of a situation in its entirety. For example, unlike *John was drawing a circle*, which expresses imperfective (more particularly progressive) meaning, *John drew a circle* expresses perfective meaning.

Performative speech act: speech act that is performed by the very uttering of a sentence. For example, by uttering the sentence *I wish you a merry Christmas*, the speaker actually performs the act of wishing the hearer a merry Christmas.

Periphrastic auxiliary: the grammatical auxiliary *do*, which is used for do-support, i.e. which is inserted into a verb phrase that does not contain an auxiliary when that verb phrase is to be used in a construction that requires an auxiliary (e.g. “*I don’t love her. Do you love her?*” – “*Yes I do; I do love her.*”).

Permanent habit: habit that is not represented as being restricted in time. For example: *I don’t drive to work. I take the bus or walk.*

Phrase: syntactic unit consisting of a word functioning as a ‘head’ or ‘nucleus’-potentially accompanied by one or more other words or word groups clustering around the head. The nature of the phrase is determined by the word class of the head. Thus, in the sentence *Most people in their thirties need money*, we have a five-word noun phrase (NP) *most people in their thirties* (with *people* as head), a three-word prepositional phrase *in their thirties*, a two-word verb phrase (VP) *need money*, and a one-word noun phrase *money*.

Pluperfect: see past perfect tense.

Point of view: term introduced in the discussion of temporal focus, to capture the observation that, by making a marked tense choice, a speaker may represent the actualization of a situation from someone else’s viewpoint, e.g. from the temporal standpoint of a character in a past-tense narrative. For example, *They climbed the Matterhorn, which was very steep* differs from *They climbed the Matterhorn, which is very steep* in that by using the past tense the speaker assumes the point of view of the climbers: *was* makes it clear that it was THEY who experienced THEN and THERE that the Matterhorn is steep. In other words, while *is* triggers a transparent reading (i.e. reveals the speaker’s point of view at t_0), *was* triggers an intensional (opaque) reading.

Polar question (or yes / no-question or wide scope question): interrogative sentence or subclause expressing a question to which the expected reply is *yes* or *no*. The clause does not contain a question word, and the question has scope over the entire proposition. For example: *Is the house humid?* (= ‘Is it the case that the house is humid?’)

Positive polarity item: see assertive item.

Possible world: way that things are or might be. The actual world is the way things actually are at speech time. A nonfactual world is an alternative way of conceptualizing things, such as a future world, the hypothetical world of the imagination of the speaker, a counterfactual world, etc. Thus, *Paris is the capital of France* is true in the actual world, whereas the proposition ‘Paris be the capital of Italy’ in *If Paris had been the capital of Italy [the Pope would have been living there]* is true in a counterfactual world. Similarly, the proposition ‘You be married’ expressed in *I thought you were married!* is true in the speaker’s past world of thinking but assumed (by implicature) to be counterfactual in the actual world.

Posterior: following in time: time A is posterior to B if it follows B. See also T-posterior and W-posterior.

Posteriority: type of temporal relation. A given time A is posterior to a given time B if A follows B in time. Posteriority is W-posteriority if A is interpreted

as posterior to B in the possible world referred to. Posteriority is T-posteriority if it is a relation that not only exists in interpretation but is formally expressed by the tense form of the clause. Thus, in *John said he would do it the next day* the situation time of *would do* is represented as T-posterior to (= following) the situation time of *said*.

Post-present: (a) shorthand for post-present zone; (b) can also be used as an adjective modifying the noun *situation*, this combination then being short for ‘situation whose situation time is located in the post-present time-zone’. (Similarly, when we speak of the *post-present actualization* of a situation, we mean its actualization in the post-present zone.)

Post-present domain: temporal domain whose central orientation time lies in the post-present zone. Such a domain can be established directly by the use of the future tense or by a futurish tense form (e.g. *He’s going to leave*; *I’m leaving tonight*). It may also be established indirectly by expressions implying future time reference, such as imperatives or certain verbs whose lexical meaning implies posterior actualization of the situation referred to in its complement clause, like *expect* [*to V*] or *intend* [*to V*].

Post-present time-zone: see post-present zone.

Post-present zone (or **post-present time-zone**): portion of the present time-sphere that is conceptualized as following the temporal zero-point (t_0). For example, *I will leave* and *I’m going to leave* both locate the time of the actualization of the situation of ‘my leaving’ in the post-present zone.

Potential full situation: In clauses using one of the perfect tenses and receiving a continuative reading, this term refers to the factual full situation plus that part of the full situation that may potentially continue beyond the relevant orientation time (which in the case of the present perfect is the temporal zero-point). Thus, in *Meg has been talking to the elephant for an hour now*, the potential full situation is longer than an hour (since one hour is the adverbially specified length of the factual full situation).

Predicate: (a) syntactically: shorthand for predicate constituent; (b) semantically: what is said (or asked) about the referent of the subject of a clause.

Predicate constituent: the syntactic unit functioning as predicate within a clause. It is made up of all the elements of a clause except the subject, in other words, of the verb phrase and of additional optional phrases, if any.

Predicated situation: that part of the full situation (possibly all of it) about which an assertion is made (or a question is asked) in a tensed clause. In other words, the predicated situation is that part of the full situation (possibly all of it) that is located in time by a tense form. In *Five minutes ago John was in the*

kitchen the predicated situation is that part of the situation that is represented as contained in (which here means: temporally coinciding with) the punctual Adv-time indicated by *five minutes ago*. The full (= complete) situation may take up a much longer period (which may include the temporal zero-point), but the sentence does not tell us anything about this. It just makes a claim about (i. e. predicates something of) that part of the (actualization of the) situation that coincides with the time indicated by *five minutes ago*.

Predicational sentence: any sentence that is not a specificational sentence; in other words, a predicational sentence merely says (or asks) something about the referent of the constituent functioning as topic (theme) of the sentence. An example of this is *John has already read this book*, provided there is no contrastive (= extra heavy) accent on one of the constituents. (A contrastive accent always entails a specificational reading: *JOHN has already read this book* means 'It is John who has already read this book'.)

Predictability: the expression, by means of the future tense (with *will* as auxiliary), of the probability of the truth of a conclusion about a present situation, e. g. *That will be the milkman*, when interpreted as 'It is predictable that that is the milkman'.

Prediction: the expression of an assumption that a situation will actualize in the post-present (or, in the case of *would*, at a time posterior to the time of making the prediction), e. g. *John will be there*, when interpreted as 'It is my opinion that John will be there' (rather than as 'It is predictable that John is there' – see predictability).

Preparatory phase reading: interpretation produced by the use of a progressive form of a verb denoting a transitional situation (like dying). Because a progressive form only refers to the middle part of a durative situation, *He was dying* (as opposed to *He died*) is interpreted as only referring to the phase leading up to the transition (from life to death); in other words, *He was dying* does not state that he died but only refers to the durative process which was interpreted as leading up to his death: the sentence refers to the 'preparatory phase' only, not to the actual transition (which may even be denied, as in *He was dying [when we found him, but he pulled through in hospital.]*).

Pre-present: (a) shorthand for pre-present zone; (b) can also be used as an adjective modifying the noun *situation*, this combination then being short for 'situation whose situation time is located in the pre-present zone'. (Similarly, when we speak of the *pre-present actualization* of a situation, we mean its actualization in the pre-present zone.)

Pre-present domain: temporal domain that is established by a present perfect tense form which locates its situation time in the pre-present zone of the present

time-sphere. This situation time functions as the central orientation time of the pre-present domain that is established.

Pre-present time-zone: see pre-present zone.

Pre-present zone (or **pre-present time-zone**): portion of the present time-sphere that is conceptualized as leading up to the temporal zero-point (t_0) and whose endpoint is conceived of as adjacent to t_0 . (In other words, the pre-present zone is conceptualized as leading up to t_0 without including t_0 .) To locate a situation time in the pre-present English uses the present perfect tense.

Pre-present-zone adverbial: single-zone time-specifying adverbial which specifies a pre-present zone, e.g. *from the beginning of May until now; over the past four years; so far*; etc.

Present: (a) (as a noun) shorthand for present zone; occasionally also shorthand for 'present tense', when there can be no confusion, as in the combination '(non)progressive present'; (b) (as an adjective) 'located in the present', e.g. a *present situation* is a situation whose situation time is located in the present zone; '*present relevance*' refers to the fact that the pre-present actualization of a situation is still relevant at the temporal zero-point.

Present continuous: progressive form of the present tense. (synonym of progressive present)

Present domain: temporal domain established by a present tense form which locates a situation time in the present zone (i.e. represents the situation time as coinciding with the temporal zero-point).

Present gerund: nonfinite verb form involving the suffix *-ing* (e.g. *walking, being hit, swimming*) and forming part of a nominal clause, e.g. *walking in the dark* in *I don't like walking in the dark*. A present gerund differs from a perfect gerund in that it does not involve the *-ing* form of the perfect tense auxiliary *have*.

Present infinitive: nonfinite verb form as it appears as an entry in a dictionary (e.g. *eat*, which is also the stem of the verb); also, the passive counterpart of the dictionary form (e.g. *be eaten*). The present infinitive is nontensed but is interpreted in terms of a single temporal relation, which is usually that of simultaneity with the time of the head clause situation, but occasionally a relation of posteriority: in *I hope to see her tomorrow*, the time of the situation referred to by the infinitive clause is interpreted as posterior to the time of the head clause situation.

Present participle: nonfinite (and therefore nontensed) verb form consisting of the stem of the verb plus the suffix *-ing* and which can either have an adjectival

function or form part of a progressive verb form, e. g. the form *causing* in *The hotel guests causing a disturbance {last night / at the moment / tonight} will be arrested tomorrow*. As this example shows, the time of the situation referred to by a participial clause with a present participle can (according to the context) be interpreted as anterior, simultaneous or posterior to the time of the head clause situation.

Present perfect: tense which is formed by combining a present tense form of the auxiliary *have* with the past participle of the main verb. The semantics of this tense is: 'The situation time is located (i. e. 'contained') in the pre-present zone'. Since 'containment' means either proper inclusion or strict coincidence, there are two T-interpretations that are in keeping with this core meaning: a 'before now' reading ('The situation time lies wholly before t_0 ') and a 'co-extensive' reading ('The situation time leads up to now and therefore coincides with the pre-present zone').

Present subjunctive: type of mood. In English, the present subjunctive form is homonymous and homophonous with the present infinitive (e. g. *if the truth be told...*; [*It is vital that*] *she see her physician (for treatment)*).

Present tense: tense which is formed by using the stem of the verb, except for third person singular subjects, which require the verb form to take an added *-(e)s* ending. (There are some well-known exceptions, notably the verb *be*, the verb *have* and the auxiliaries.) When used as an absolute tense, the most basic meaning of the present tense is that the situation time coincides with the temporal zero-point. When used as a relative tense (as in [*I will be happy*] *if she comes*), it represents the situation time as T-simultaneous with a post-present situation time which is treated as a pseudo-present time.

Present time-sphere (or nonpast time-sphere): time-sphere conceptualized as a time span of indefinite length containing the present zone, which coincides with the temporal zero-point (t_0), the pre-present zone, which leads up to t_0 , and the post-present zone, which begins immediately after t_0 .

Present time-sphere tense: cover term for the four tenses which typically locate a situation time in the present time-sphere: the present tense (as absolute tense), the present perfect, the future tense and the future perfect. These tenses all involve a present tense inflectional morpheme.

Present time-zone: see present zone.

Present zone (or present time-zone): portion of the present time-sphere that coincides with the temporal zero-point. Since t_0 is conceived of as punctual, so is the present zone.

Presuppose: 'presuppose something' means 'treat something as being a presupposition (of a certain linguistic expression)'. For example, in *It was John who*

stole Maud's wallet it is presupposed that there is someone who stole Maud's wallet, hence that Maud's wallet was stolen.

Presupposition: proposition which is assumed to be true by the speaker when he makes his utterance, in other words, a pragmatic condition which is assumed to be fulfilled. Thus, both *I closed the door* and *I didn't close the door* presuppose that the door was not closed at the relevant time. This illustrates a criterial property of presuppositions, viz. that they remain unaffected if the clause is made negative (except if the negation is of the metalinguistic kind).

Preterite: tense locating a situation time in a domain in the past time-sphere. See also past tense (a)–(b).

Principle of Unmarked Temporal Interpretation: strategy for the interpretation of temporal W-relations when two or more clauses with an absolute tense form follow each other and there is no linguistic or contextual indication of the temporal W-relation(s) holding between the situations referred to. In that case, the (non)boundedness of any two consecutive clauses is crucial, in that two bounded clauses are normally interpreted in terms of iconic sequencing, two nonbounded clauses are normally interpreted in terms of W-simultaneity, and a combination of a bounded and an unbounded clause is normally interpreted in terms of inclusion (i. e. the nonbounded situation includes the bounded one).

Prior (to): anterior (to)

Process: type of dynamic situation (i. e. a dynamic situation type), namely a situation which is not controlled by an agent and which is (conceived of as) durative and evolving, i. e. as involving incremental change that implies a scale of some sort (e. g. changing, getting dark, diminishing). In other words, a process is a situation type that is dynamic but not agentive and whose main characteristic is change, i. e. a development, a change of state or a transition into a state (e. g. *The car slowed down*; *The man was dying*).

Process verb: verb denoting a process, e. g. *change, grow, mature, die, widen, slow down, improve, thicken, deteriorate, strengthen, diminish, darken, deepen, develop, increase*.

Progressive aspect: the only type of grammatical aspect that is to be found in English, i. e. the only aspect that is expressed by a special verb form. Progressive aspect means that the speaker uses a special verb form to express progressive meaning, i. e. to represent the actualization of a situation as 'ongoing' (i. e. as in progress at or throughout a given vantage time). Also called 'continuous' or 'durative' aspect.

Progressive form: verb form which consists of a form of *be* followed by the present participle (as in *John was walking home*) and which is used to express progressive meaning. Also called 'continuous form'.

Progressive meaning: the idea that the situation referred to is viewed as ongoing at or throughout a given vantage time. Dynamic verbs use the progressive verb form to express this meaning.

Progressive present: progressive form of the present tense.

Proposition: the semantic contents of a clause when one disregards the semantic contributions of tense, aspect and modality. Thus, the proposition 'John come at five' underlies both *John will come at five* and *John came at five*. Similarly, both John is running and John has run are possible expressions of the proposition 'John run'. A sentence like *John came early* can be referred to as a 'tensed proposition', because its meaning is the combination of the proposition 'John come early' and the meaning of the absolute past tense.

Pseudo-absolute past zone (or **pseudo-absolute past time-sphere**): time-zone which is past relative to a pseudo-zero-point. For example, in *Next time I will say that I was ill the day before*, the form *was* locates its situation time in a pseudo-absolute past zone (which is defined relative to the situation time of *will say*, which is the central orientation time of a post-present domain and is therefore treated as a pseudo-zero-point).

Pseudo-absolute-relative tense form: a tense form whose basic use is as an absolute-relative tense form, but which now expresses a two-part relation with a basic orientation time which is not the temporal zero-point (t_0) but a post-present pseudo-zero-point. For example, the basic use of the future perfect is to express a two-part relation between a situation time and t_0 , as in *I will have left on time*, but the future perfect is used as a 'pseudo-absolute-relative' tense in [*He will say that*] *he will have finished before 5 o'clock*. In this sentence, the origin of the T-posteriority relation expressed by *will* (i. e. the basic orientation time) is not the (real) zero-point but a post-present pseudo- t_0 (viz. the situation time of *will say*).

Pseudo-absolute tense form: a past, present perfect, present or future tense form that relates its situation time to a pseudo-zero-point rather than to the real temporal zero-point. For example: *was* in [*Next time you see him*] *John will again say that*] *he was thirsty the night before*. In this example, *was* represents the being thirsty not as past relative to the (real) zero-point but rather as past relative to the post-present time referred to by *will say*, which is treated as if it were a zero-point (i. e. as a pseudo-zero-point).

Pseudo-absolute zone: cover term for any of the four portions of time that are defined in direct relation to a pseudo-zero-point (i. e. a post-present time which is treated as if it were the zero-point): the pseudo-past zone, the pseudo-pre-present zone, the pseudo-present zone and the pseudo-post-present zone. See also Pseudo- t_0 -System.

Pseudo-cleft (or **pseudo-cleft sentence**, **pseudo-cleft construction**): specificational copular sentence in which the variable is expressed by a *wh*-clause processed as subject and the value constituent is processed as subject complement, e. g. *What I gave him was a BOOK*. (This is interpreted as ‘the x which I gave him was: a book’.) We speak of an inverted pseudo-cleft when the nominal relative clause (representing the variable) follows the constituent expressing the value, as in *A BOOK was what I gave him*.

Pseudo-past subdomain: temporal subdomain forming part of a post-present domain and created by a pseudo-absolute past tense form, which locates a situation time in a pseudo-past zone, i. e. in a time-zone viewed as past with respect to, and as disconnected from, the central orientation time (treated as a pseudo-zero-point) of that post-present domain. For example, *were staying* establishes such a pseudo-past subdomain in *Sooner or later the police will find out that you were staying here today, and not in London*.

Pseudo-past zone: (1) time-zone viewed as past with respect to, and as disconnected from, the central orientation time (treated as a pseudo-zero-point) of a post-present domain. For example, in *Sooner or later the police will find out that you were here today*, the tense form *were* locates the time of the situation referred to in a pseudo-past zone. (The situation in question may be interpreted as W-posterior to the real zero-point, but that relation is not expressed by the past tense form.); (2) A pseudo-past zone can also be defined relative to a pseudo-zero-point which is the central orientation time of a pseudo-post-present subdomain.

Pseudo-post-present subdomain: (1) temporal subdomain forming part of a post-present domain and created by a pseudo-absolute future tense form, which locates a situation time in a pseudo-post-present zone, i. e. in a time-zone viewed as future relative to the central orientation time (treated as a pseudo-zero-point) of that post-present domain. For example, in *I will announce tomorrow that, if I lose, I will leave the country for good*, the future tense form *will leave* establishes a pseudo-post-present subdomain within the post-present domain established by *will announce*; (2) subdomain whose central orientation time is treated as a pseudo-zero-point because it is either T-simultaneous or T-posterior to the central orientation time of a post-present domain or of another pseudo-post-present subdomain.

Pseudo-post-present zone: time-zone viewed as future with respect to the central orientation time (treated as a pseudo-zero-point) of a post-present domain. For example, in *I will announce tomorrow that I will leave the country for good*, the future tense form *will leave* locates its situation time in a time-zone which is treated as post-present relative to a pseudo-zero-point, which is the post-present time of the announcement. Any situation time located in a

pseudo-post-present zone (e.g. the situation time of *will leave* in the above example) is also treated as a pseudo- t_0 and is therefore the central orientation time of a pseudo-post-present subdomain of its own.

Pseudo-pre-present subdomain: (1) temporal subdomain forming part of a post-present domain created by a situation time that is located in a period leading up to (and not felt to be divorced from) the central orientation time (i. e. the pseudo-zero-point) of that post-present domain. For example, the present perfect tense form *have left* in *Who will look after you when Brad and Sybil have left?* is used to locate the time of the situation of leaving in a pseudo-pre-present subdomain; (2) A pseudo-pre-present subdomain may also be a subdomain within a pseudo-post-present subdomain (e.g. the subdomain established by *have left* in *Mother will ask you who will look after you when Brad and Sybil have left*).

Pseudo-pre-present zone: (1) time-zone viewed as leading up to the central orientation time (treated as a pseudo-zero-point) of a post-present domain. In [*If you leave tonight, the police will only discover tomorrow that*] *you have left*, the present perfect tense form *have left* locates the time of the situation referred to in a pseudo-pre-present zone, i.e. in a period leading up to the time of the future discovering. (The situation in question may be interpreted as W-posterior to the real zero-point, but that relation is not expressed by the present perfect tense form.); (2) A pseudo-pre-present zone may also be a zone forming part of a pseudo-post-present subdomain. Thus, in *Mother will ask you who will look after you when Brad and Sybil have left*, the form *have left* locates its situation time in the pseudo-pre-present zone that is defined relative to the situation time of *will look [after you]* which functions as a pseudo- t_0 and establishes a pseudo-post-present subdomain within the post-present domain established by *will ask*.

Pseudo-present time: a post-present time that is treated as if it were the temporal zero-point. A time is a pseudo-present time if (a) it is the central orientation time of a post-present domain or (b) it is a time that is T-simultaneous or T-posterior to that central time, or (c) it is a time that is T-simultaneous or T-posterior to a time of the kind mentioned in (b), etc.

Pseudo-present subdomain: (1) temporal subdomain forming part of a post-present domain and created by a pseudo-absolute present tense form, which represents a situation time as T-simultaneous (= coinciding) with the central orientation time of a post-present domain. (That central orientation time is treated as if it were the zero-point, i. e. as a pseudo-zero-point.) For example, in [*If we hide the money there*] *the police will never find out where it is*, the present tense form *is* creates a pseudo-present subdomain within the post-present domain established by *will find out*; (2) A pseudo-present subdomain may

also be a subdomain within a pseudo-post-present subdomain. Thus, in [*Next time Tim runs away*] *John will tell his parents that he will tell them in due time where Tim is*, the form *is* expresses a pseudo-present subdomain within the pseudo-post-present subdomain established by *will tell*.

Pseudo-present zone: time-zone viewed as coinciding with a pseudo-zero-point (i. e. with a post-present time which is treated as if it were the zero-point).

Pseudo-t₀-System: system of tense forms that can be used to express a T-relation in a post-present domain. This system, which is based on a shift of temporal perspective (since the central orientation time of the domain is treated as if it were the temporal zero-point), comprises the pseudo-absolute tenses, which locate a situation time in one of the pseudo-absolute time-zones, which are defined relative to the post-present central time of orientation (which is treated as a pseudo-zero-point). As pseudo-absolute tenses we use the preterite or present perfect to express T-anteriority, the present tense to express T-simultaneity and the future tense (or a futurish form) to express T-posteriority. Each use of a pseudo-absolute tense establishes a pseudo-absolute subdomain, which can be expanded like a 'normal' domain established by an absolute tense form. For example, in [*If we kill him tonight and put his body in the freezer for two days*] *the police will think that he was killed when he came home on Tuesday*, the form *will think* establishes a post-present domain, whose central orientation time (= the time of the thinking) is treated as a pseudo-t₀, i. e. as if it were the temporal zero-point. The situation time referred to by *was killed* (which is W-posterior to the real t₀) is located in the pseudo-absolute past time-sphere (i. e. in a time-zone that is past relative to the pseudo-t₀), where it establishes a pseudo-absolute past subdomain. The relative past tense form *came* expresses T-simultaneity in that subdomain. (In a true past domain, it is also the relative past tense that is used to express T-simultaneity, e. g. *He was killed when he came home*.)

Pseudo-zero-point (or pseudo-t₀): orientation time which is not the temporal zero-point but is treated as if it were t₀. A pseudo-t₀ is the central orientation time of a post-present domain or a situation time that is T-simultaneous with that or which is the central orientation time of a pseudo-post-present subdomain. For example, in *Next time he will say that he is ill*, the central time of orientation (= the time of saying) of the post-present domain is treated as a pseudo-t₀. This explains why the present tense (*is*) is used to represent the situation time of the *that*-clause as T-simultaneous with it.

Punctual (or nondurative, momentary): (a) ontological feature of a situation-template (as expressed by, e. g. the verb phrase *knocked at the door*) which is conceived of as needing no more than a moment to actualize. By extension, the term can also be applied to a verb phrase denoting such a situation-template

(e.g. *knock at the door*) or to the actualization of a situation that is conceived of as having no (or hardly any) duration. (b) The term *punctual* is also applied to time-specifying adverbials that indicate a specific moment in time, i.e. a time that has no duration to speak of (e.g. *at five*), as well as to duration adverbials that indicate an interval that has no duration to speak of (e.g. *for a split second*).

Punctual situation verb (phrase): verb or verb phrase which denotes a punctual situation-template.

Punctual time-specifying adverbial: time-specifying adverbial which specifies an Adv-time that has (virtually) no duration (e.g. *at five o'clock*).

Pure duration adverbial: temporal adverbial which (unlike a time-specifying adverbial or a bifunctional temporal adverbial) does not identify an Adv-time but only specifies duration, more specifically the duration of the full situation (e.g. [*John was here*] *for a couple of hours*).

Pure future: what is expressed by the future tense if the speaker merely makes a prediction, i.e. if he just expresses that he thinks that a particular situation will actualize in the post-present.

Quantificational constitution reading (or interpretation): cover term for duration-quantifying constitution readings (e.g. *Nearly a year has gone by since then*) and number-quantifying constitution readings (e.g. *How many times have you met him in the past week?*).

Recency reading (or interpretation): a particular reading of the indefinite perfect, viz. that in which the pre-present situation time is lying close to the temporal zero-point. There is a recency reading if a sentence in the present perfect is used to convey 'hot news' (see hot news interpretation) or in cases in which the present perfect combines with an adverb like *just*, *recently* or *this minute*, which establishes a recent indefinite bygone Adv-time (e.g. *I have recently heard that vitamin A may be linked to osteoporosis*).

Recent indefinite bygone time: Adv-time indicated by one of the adverbials *recently*, *just*, *this minute*, *lately*.

Reduced cleft (or reduced *it*-cleft): cleft sentence whose *wh*-clause is deleted because it would only repeat the contents of the preceding subclause. Thus, *it's you* in *If anyone can do it, it's you* (which is interpreted as 'If there is one x who can do it, that x is you') is short for *it's you who can do it*.

Referent: the entity (thing, person, actualization of a situation, etc.) that a linguistic expression (viz. a word, phrase or clause) refers to. This entity usually belongs to an extralinguistic possible world (such as the actual world). Its

existence in that world is affirmed, denied, questioned, hypothesized or presupposed. In *John left*, the referent of the noun phrase *John* is a particular person known as having the name *John*. The referent of a finite clause is the actualization of a situation.

Referential noun phrase: when used in Donnellan's (1966) sense, said of a noun phrase which has definite reference in the sense that the speaker assumes the hearer to know the identity of the referent of the phrase. For example, in [*I'd like to hear more about*] *the trip you've made*, the hearer is assumed to be able to know which particular trip is being referred to. The speaker could therefore also use other NPs to refer to the trip in question, such as *your trip to Italy*.

Regular verb (or weak verb): verb that forms its past tense and its past participle by adding the suffix *-ed* to the verb stem (which then sometimes has to undergo a minor spelling adjustment), e.g. *play – played; love – loved; cry – cried*, etc.

Relative-absolute deictic time-specifying adverbial: time-specifying adverbial which indicates an Adv-time that is anchored to a time which is itself anchored to the temporal zero-point, e.g. *the day before yesterday*.

Relative deictic time-specifying adverbial: time-specifying adverbial which indicates an Adv-time that is anchored to a time other than the temporal zero-point, e.g. *the same day, that morning, the next day, the day before, two days earlier*, etc.

Relative past tense: past tense which expresses T-simultaneity in a past domain. The semantics of the relative past tense is: 'The situation time is represented as T-simultaneous with an orientation time in a past domain (or in a past subdomain or in a pseudo-past subdomain)'

Relative tense: tense which does not T-relate the time of a situation directly to the temporal zero-point but T-relates it to some other time of orientation. A relative tense always indicates a temporal relation within a temporal domain. For example, the past perfect form *had left* in *I knew he had left early* expresses anteriority within the past domain established by the absolute past tense form *knew*.

Repetitive (or iterative) aspect: (1) kind of grammatical aspect, characterized by the fact that the speaker uses a special verb form to represent a situation as a hypersituation consisting of a number of subsituations of the same kind. (2) In this work we also speak of repetitive or iterative 'aspectual meaning' when a situation repeats itself on different occasions, as in *I've only been in this town three times*.

Repetitive habit: habit which involves multiple instantiations of the situation referred to. None of these instantiations need actually be going on at the time

at which the habit is located. For example: *I used to smoke weed when I got hired for my first job.*

Repetitive situation: hypersituation, i. e. situation whose actualization involves the actualization of a number of similar subsituations, e. g. [*All the time I was speaking*] *John was nodding assent*; *She stabbed him six times with her pen-knife.*

Replay comment: comment on a replay (e. g. on television).

Reported speech: the phenomenon of reporting an utterance or thought. Reported speech may be 'direct reported speech' (e. g. *He said: 'I am ill.'*), 'indirect reported speech' (e. g. *He said that he was ill.*) or 'free indirect speech'. In the latter case there is no reporting clause like *He said ...* and what is a subclause in indirect reported speech appears as an independent clause (e. g. [*He let me know that he couldn't come.*] *He was ill. He had to stay at home.*)

Reporting clause: the head clause of a sentence that is an instance of reported speech (e. g. *He said* in *He said he was ill*).

Represented speech: cover term for indirect reported speech (e. g. *Jill told herself that she was going to take revenge*) and free indirect speech (e. g. *She was going to take revenge*, when used to represent the thought of a character in a past-tense novel). Note that in both types, and especially in the latter, *speech* should be interpreted as also including thought rather than just spoken discourse.

Restrictive *when*-clause: term that is sometimes used as an alternative to case-specifying *when*-clause. It is inspired by the fact that a case-specifying *when*-clause can as a rule be replaced by a restrictive relative clause without any obvious change in meaning: compare *Children are orphans when their parents are dead* with *Children whose parents are dead are orphans*.

Result: see direct result and indirect result.

Resultative reading (or interpretation): a particular usage type (a functional reading) of the indefinite perfect: the sentence in the present perfect is taken to draw attention to a present direct result. For example, the reading triggered by the sentence *I've locked up the shop* is that the shop is now locked up.

Rhetorical question: sentence that has the form of an interrogative sentence but which is interpreted as a forceful statement (e. g. *Who can blame him?*, on the interpretation 'Nobody can blame him').

Right boundary: the point at which the actualization of a situation comes to an end.

Root modality: see nonepistemic modality.

Scalarity: the phenomenon that a word (e.g. a focusing adjunct like *even*) is interpreted as a 'scalar operator', i.e. as representing the constituent which it focuses as extremely high or extremely low on a particular scale of values. For example, *Even Mary managed to do it* implies that (of those who did it) Mary was the least likely person (or one of the least likely ones) to be able to do it. (Here the scale is a scale of unlikelihood, on which the values are people that are increasingly unlikely to be able to 'do it'.)

Seemingly sloppy simultaneity: in a complex sentence with an adverbial when-clause, the phenomenon that the (actualization of the) situation of the head clause and that of the when-clause are not interpreted as W-simultaneous (i.e. as having at least one point in common), although the tense form in the when-clause expresses T-simultaneity, e.g. *When John sees this, he will phone the police*. This phenomenon differs from 'real' sloppy simultaneity, as in e.g. *You'll arrive at 8.35 if you take the 7.56 bus*, in that it is not a question of tense choice (more specifically, choice of T-relation to be expressed) but follows naturally from the semantics of *when*, which does not require that the two orientation times that are contained by the durative common Adv-time be W-simultaneous with each other.

Semantics of a tense: the invariant meaning of a tense, i.e. the tense structure expressed by any form belonging to the tense in question. For example, the basic semantics of the present tense is 'The situation time is T-simultaneous with the temporal zero-point'.

Semelfactive aspect: kind of grammatical aspect: the speaker uses a special verb form to represent a situation as actualizing only once (rather than as being a repetitive situation).

Semelfactive situation: situation that actualizes only once, i.e. a nonrepetitive situation. A semelfactive situation is not a hypersituation consisting of subsituations of the same kind.

Sentence: linguistic unit which is prototypically made up of a clause or a combination of clauses and which can function as an independent utterance.

Shift of domain: the creation of a new temporal domain by the use of an absolute tense. In other words, the choice of an absolute tense form to create a new temporal domain (as in *John left after I arrived*, where the past tense form *arrived* does not temporally subordinate its situation time to the situation time of the head clause but establishes a new domain) rather than the use of a relative tense form to expand an already established domain (as in *John left after I had arrived*, where the past perfect is used to express T-anteriority within the domain established by the past tense form *left*).

Shift of temporal domain: see shift of domain.

Shift of temporal focus: deviation from the unmarked choice of temporal focus by the use of a marked tense form. Consider the following example: [*I asked John about the colour of the paint.*] *It is white.* In the second clause, the speaker no longer focuses on the past time when he asked John about the colour of the paint – which he would do if he said *It was white* – but locates the actualization of the situation of the paint being white in the present zone, thus shifting the temporal focus from the past to the present.

Shift of temporal perspective: the selection of a tense, not in order to locate a situation time in a particular time-zone but in order to represent it *as if* lying in that time-zone; in other words, the creation or expansion of a temporal domain by a tense that is typical of domains lying in a different time-zone. For example, in *They leave tomorrow*, the present tense represents a post-present situation as if it were a present one. In *I hear you have been promoted*, the present tense represents a pre-present situation as if it were a present one. In *Next time his excuse will be that he is ill* the time of the post-present excuse is treated as if it were the present. The historic present is another typical case.

Shift the domain: effect a shift of domain, i.e. create a new temporal domain. In *He said that Gordon and Jill are married*, the tense form *are* shifts the domain (from the past to the present).

Simple situation-template: what is denoted by a lexical verb.

Simultaneity: type of temporal relation between two times. As a T-relation (= relation expressed by a tense form), T-simultaneity means strict coincidence (between a bound situation time and the binding orientation time). Simultaneity that is not T-simultaneity may be a relation of either coincidence or overlap. An example is the containment relation that exists between an Adv-time and a situation time. See also W-simultaneity.

Simultaneous: see T-simultaneous and W-simultaneous.

Since-cleft: it-cleft whose second clause is introduced by *since* (rather than by *that* or by a *wh*-word as in *It was John {who / that} did it*). The highlighted (focused) value constituent is always an indication of duration. For example: *It's been three weeks since I have heard from him.*

Single-zone adverbial: see single-zone time-specifying adverbial.

Single-zone time-specifying adverbial (or **single-zone adverbial**): deictic time-specifying adverbial which refers to only one absolute time-zone. For example, *yesterday* specifies an Adv-time which can only lie in the past zone.

Situation: cover term for the various possible types of contents of propositions, i. e. for anything that can be expressed in a clause: an action, event, process,

or state. The verb actualize is used as a cover term for the predicates that are typically associated with one of these categories.

Situation-template: cover term for simple situation-template (denoted by a verb) and enriched situation-template (denoted by a verb phrase or a possibly longer predicate constituent). Situation-templates can be characterized in terms of ontological features.

Situation time (or time of the situation): the time of a predicated situation, i. e. the time of actualization of a situation as it is located in time by a tense form (i. e. as it is temporally related to the temporal zero-point or to another orientation time) and to which the situation time of another situation can be temporally related by a tense form. In homogeneous clauses, the situation time may be shorter than the time of the full situation. Thus, in *At five o'clock I was in my bed*, the situation time is that portion of the full situation (of my being in my bed) that is contained in (in this case: coincides with) the Adv-time specified by *at five o'clock*.

Situation-time adverbial: time-specifying adverbial denoting an Adv-time which 'contains' (in terms of either inclusion or coincidence) a situation time (e. g. [*I left there*] {*yesterday* / *at five o'clock*}).

Situation type: In this work, a situation type is a type of situation (as denoted by a complete clause), such as an action or a state. For example, *John smokes* denotes a permanent habit, which is a kind of state. Where necessary, we distinguish 'situation type' (or 'type of situation') from 'type of situation-template' (as denoted by a verb, verb phrase or predicate constituent). (Other linguistic studies use the term 'situation type' to refer to both kinds of types.)

Situation-unbounding constituent: see unbounding constituent.

Sloppy simultaneity: the phenomenon that a situation time is linguistically represented as T-simultaneous with a binding situation time even though the binding situation time and the bound one are not strictly simultaneous (= coinciding) with each other and the full situations are not even W-simultaneous (= interpreted as having at least one point in common). Thus, both in *If John received a letter, he replied almost at once* and in *If John receives a letter, he will reply almost at once*, the *if*-clause situation is interpreted as W-anterior to the head clause situation, but the *if*-clause uses a relative tense form expressing T-simultaneity (*received* / *receives*) rather than a relative tense form expressing T-anteriority (*had received* / *has received*).

Special Present Time-sphere System: systematic use of present-time-sphere tenses to refer to situations that are interpreted as actualizing in the past, the pre-present or the post-present. For example: the historic present.

Specificational clause / sentence: clause or sentence which specifies a value for a presupposed variable and in doing so focuses (highlights) the value. For example, each of the following sentences specifies ‘a book’ as the value that satisfies the variable ‘the x that I gave him’ and implies ‘nothing else’ (= contrast): *It was a BOOK that I gave him*, *What I gave him was a BOOK*, *A BOOK was what I gave him*, *I gave him a BOOK*.

State (or static situation): type of situation (i. e. situation type) which is conceived of (and represented as) existing (rather than as being done, taking place or developing) and as being unchanged and hence homogeneous throughout its duration. A static kind of situation is not agentive and is not conceived of as needing a continuous input of energy to continue. For example: *Bill’s baby is a girl*.

Statement (or declarative sentence): sentence making an assertion rather than having the illocutionary force of another speech act (such as a question or command).

State verb (or static situation verb): verb that can only be used to refer to a state, e. g. *seem*, *contain*, *know*, *consist of*, etc. Also known as ‘verb of state’.

Static: kind of ontological feature, viz. the opposite of dynamic. The term can be applied to a situation-template denoting a state, a verb phrase lexicalizing the situation-template in question (e. g. *is a boy*), a situation (e. g. Kim’s being a boy) or to a sentence referring to a concrete actualization of a situation (e. g. *Kim is a boy*). In other words, ‘static’ is the quality of being a state, denoting a state or referring to a state.

Static situation: see state.

Static situation verb: see state verb.

Stem (or verb stem): that part of the verb that remains constant in the different forms of the verb, e. g. *unchain* in *unchains*, *unchained*, *unchaining*. The stem of a verb is homophonous with the present infinitive form and the present subjunctive form of that verb.

Strong intensional verb: verb like *imagine*, *fancy*, *dream*, *wonder*, which establishes an intensional domain (= possible world which is different from the actual world) which is so strong that the clause(s) in the scope of the verb can only receive an intensional (opaque, de dicto) interpretation. Such a strong intensional domain is treated as a temporal domain from which a shift of domain is very difficult or impossible. Thus, we can say *Helen dreamed that she was pregnant*, but not **Helen dreamed that she is pregnant*.

Strong verb: see irregular verb.

Subclause (or **subordinate clause**, **dependent clause**, **embedded clause**): clause that forms part of a complex sentence and is syntactically dependent on another clause (the head clause), e. g. *if you leave* in *I'll be glad if you leave*. Most subclauses are either nominal clauses, adjectival clauses or adverbial clauses, depending on their syntactic function.

Subdomain: kind of temporal domain inside a temporal domain. See temporal subdomain.

Subject complement: the complement of a copula. It says something about the referent of the subject, i. e. it either ascribes a characteristic to that referent, as in *He seems a reliable man*, or identifies the person or entity in question, as in *The chair is that woman over there*.

Subjunctive: see present subjunctive and past subjunctive.

Subordinate clause: see subclause.

Subordinating conjunction: conjunction (= nonadverbial connector) introducing a subclause (e. g. *because, if, that, unless*, etc.).

Subordination: (a) as a syntactic term: the phenomenon that the combination of two clauses produces a complex sentence, consisting of a head clause and a subclause, rather than a compound sentence; (b) in connection with tenses: see temporal binding.

Subsituation: any of a series of repeated situations that make up a durative hypersituation. For example, in [*All the time I was speaking*] *John was nodding assent*, any single nod of the head is a subsituation of the repetitive hypersituation. Habitual-repetitive situations are also hypersituations consisting of subsituations: *She comes to see me very evening*.

Superordinate clause: see head clause. Such a clause may or may not be the matrix of a complex sentence.

Syntactic subordination: the syntactic relation (often, but not necessarily, corresponding with a T-relation) between a subordinate clause and its head clause.

t₀: abbreviation of temporal zero-point.

t₀-factual (or **factual at t₀**): said of a situation whose actualization is (interpreted as being) a past, pre-present or present fact.

T-anterior: showing the relation of T-anteriority. For example, in *Helen admitted she had made a mistake, had made* represents the situation time of the situation of Helen making a mistake as T-anterior to (= preceding) the time of Helen's admission.

T-anteriority: anteriority expressed by a tense form; more specifically: the T-relation when the situation time is linguistically (viz. by a tense) represented as

preceding the binding orientation time in one of two ways. Either the bound situation time lies completely before the orientation time (as in *I knew I had locked the door*) or it begins before the orientation time and leads up to it (as in *I told them that we had been friends since we had first met*).

T-binding: see temporal binding.

T-bound: see bound.

T-bygone situation: predicated situation which is represented as T-anterior to the temporal zero-point (t_0) by the use of a tense. Thus, in *Ten minutes ago, Jane was working in the garden*, the time of the predicated situation (which coincides with the punctual Adv-time of *ten minutes ago*) is represented as lying wholly before t_0 by the use of the past tense form *was working*, even though the full situation may still be continuing at t_0 .

T-concept: concept relevant to the description of the tense system. (contrasted with W-concept)

Telic: ontological feature. Said of a situation-template if the verb phrase describing it represents any actualization of the situation as tending towards a natural (inherent) point of completion, i. e. a necessary terminal point, beyond which the actualization of the situation cannot continue. For example, in *Betty ran three miles*, the situation of Betty running three miles is complete and naturally comes to an end when Betty finishes running the third mile. If Betty happened to go on to run another three miles, this would not constitute a continuation of the same (instance of the) situation of Betty running three miles. The term *telic* is also applied to verb phrases representing a situation-template as telic, and, by further extension, to clauses and sentences containing a telic verb phrase.

Telicizing constituent: constituent which renders a verb phrase telic, for example *a mile* in *walk a mile*.

Telos: point of completion. In a telic verb phrase the telos may be indicated by a measure phrase (as in *walk a mile*) or may be pragmatically implied (as in *write a book*).

Temporal adverbial (or **time adverbial**): cover term for three kinds of adverbials giving temporal information: time-specifying adverbials (e. g. *at six o'clock*), pure duration adverbials (e. g. *for two hours*) and bifunctional adverbials (specifying both time and duration, e. g. *from six to eight*).

Temporal anchor: see anchor time.

Temporal binding (or **temporal subordination**): the phenomenon that a situation time is T-related to another situation time (or other orientation time)

within a temporal domain. For example, in *Meg had seen Jill*, the situation time of *had seen* is '(temporally) bound by' (or 'temporally subordinated to') an orientation time which is not explicitly referred to but forms part of a past temporal domain. Strictly speaking, it is only situation times that can be bound, but by extension we can also apply the label to the situation itself. In this way we can say that in *Sue knew that Meg had seen Jill* the situation of knowing is the 'binding situation', while the situation of Meg seeing Jill is the 'bound situation'.

Temporal clause: see time clause.

Temporal domain: set of orientation times which are temporally related to each other by means of tenses. At least one of these orientation times is a situation time (since any tense form locates an actualization of a situation in time). A domain is normally established by an absolute tense form and expanded by one or more relative tense forms. The latter establish temporal subdomains. Thus, in *John said he had prayed*, the absolute past tense form *said* establishes a past domain and *had prayed* creates a subdomain within that domain.

Temporal focus: the phenomenon that the speaker's tense choice is determined by his wish to focus on the time of actualization of a situation or on a particular nonpresent portion of the time of a full situation which also includes t_0 . The former possibility is illustrated by the difference between *He must have been the culprit* (= present conclusion about an anterior situation) and *He had to be the culprit* (= past conclusion about a situation which was then actualizing). The latter possibility is exemplified by *[I spoke to the foreigner in French because] he didn't understand English*. (The foreigner presumably still does not understand English at the temporal zero-point, so the speaker could have used *doesn't understand*. Using the past tense, however, he focuses on the time when he spoke to the foreigner rather than on the present.)

Temporal subdomain: temporal domain inside another temporal domain. Whenever a situation time is incorporated into an already existing temporal domain, it creates a subdomain. This newly introduced situation time automatically functions as the central orientation time of the subdomain in question. For example, in *John said that he had warned the others that he felt sick*, the tense form *said* establishes a past domain, and *had warned* establishes a subdomain within it. *Felt [sick]* expresses a T-relation (viz. simultaneity) in the subdomain established by *had warned* and in doing so creates another subdomain, which is not further expanded.

Temporal subordination: the use of a relative tense. See temporal binding.

Temporal W-interpretation: interpretation of temporal relations as they exist in the actual world (or any other possible world referred to) regardless of

whether they are expressed by tense forms or not. For example, in *When they had first seen it, the house had made an overwhelming impression on them*, the (actualizations of the) two situations are interpreted as W-simultaneous with each other, but neither of the past perfect tense forms expresses T-simultaneity.

Temporal zero-point (or **zero-time** or t_0): the time which is the ultimate ‘origin’ of all the temporal relations expressed by the temporal structure of a tense, i. e. the only time in a tense structure that is not itself represented as dependent on another (more basic) time. It is the only time that is given (‘assumed known’) whenever a sentence is uttered. In English, the temporal zero-point is nearly always the encoding time, i. e. the time of uttering or writing the message. Occasionally, the zero-point is the decoding time, i. e. the time when the addressee is expected to hear or read the message, as is the case when a note stuck to someone’s door reads *I am in room 21*. (As always, the present tense locates the situation time at t_0 , but t_0 is the time of reading the message rather than the time of writing it.)

Temporally bound (or **temporally subordinated**): said of a situation time that is related by a tense form to an orientation time functioning as central orientation time of a temporal domain – see temporal binding.

Temporally subordinated: see temporally bound.

Temporary habit: habit that is represented as being restricted in time. If the verb is dynamic, a temporary habit is expressed by the use of the progressive form. For example: *She’s (currently) working 60 hours a week*.

Tense: (a) the phenomenon that a language has a special system of verb forms to locate (the actualizations of) situations in time; (b) the correlation of a particular grammatical form with a particular tense meaning (e. g. the ‘past tense’). In more detail: tense is a linguistic concept (as opposed to time) denoting the form taken by the verb to locate (the actualization of) the situation referred to in time, i. e. to express the temporal relation between the time of the situation in question and an orientation time which may be either the temporal zero-point or another orientation time that is temporally related (directly or indirectly) to the temporal zero-point. English has several tenses, such as the present tense, the past tense, etc., to which correspond different verb forms, which are called the tense forms of the verb.

Tense auxiliary: cover term for the perfect tense auxiliary *have* and the future tense auxiliary *will* (or *shall*).

Tense form: a concrete verb form expressing a particular tense, in other words, a particular form taken by the verb to express a particular temporal meaning. A tense form can be a simple verb form (e. g. ‘verb stem + past tense mor-

pheme') or a complex one (e.g. '[verb stem of future tense auxiliary + past tense morpheme] + perfect infinitive', i. e. the conditional perfect tense form). That is, it may either consist of one constituent (the main verb) only or be a phrase involving one or more auxiliaries next to the main verb.

Tensed clause: clause involving a tensed verb form, i. e. finite clause.

Tensed proposition: see proposition.

Tensed verb form: see tense form.

Tenseless (or nontensed or untensed) verb form: verb form which is not marked for tense, i. e. which does not encode information about how a situation time is related (directly or indirectly) to the temporal zero-point. Nonfinite verb forms and subjunctive verb forms are tenseless in this sense.

Tense relation (or T-relation): temporal relation expressed by a tense form. For example, the future perfect, which is an absolute-relative tense, expresses two T-relations: 'The time of the situation is anterior to an implicit time of orientation' and 'the implicit time of orientation is posterior to the temporal zero-point' (e. g. *He will have left*).

Tense structure: particular temporal meaning expressed by a tense. This is the temporal structure (minimally involving a situation time, an orientation time and a temporal relation between them) which represents a specific way of locating the actualization of a situation in time. For example, the tense structure of the future tense consists of the temporal relation 'The situation time is T-posterior to the temporal zero-point'.

Tentative world: (a) possible world which is nonfactual and which is assumed by the speaker to be unlikely ever to become the actual world (e. g. the hypothetical future world in *You would be punished if you did that*); (b) Nonfactual world which is represented as tentative for reasons of tact, politeness, etc. (e. g. *Would you please help me?*).

Terminative aspect: see egressive aspect.

Time: extralinguistic category (as opposed to tense), relating to our experience of the way that (the actualizations of) different situations are arranged with respect to one another along a nonspatial continuum (= the time line), from the past through the present to the future.

Time adverbial (or temporal adverbial): cover term for three kinds of adverbials giving temporal information: time-specifying adverbials (e. g. *at six o'clock*), pure duration adverbials (e. g. *for two hours*) and bifunctional adverbials (specifying both time and duration, e. g. *from six to eight*).

Time clause: subclause indicating time. The unmarked interpretation is that of 'adverbial time clause', i. e. subclause specifying an Adv-time. In *He left when*

I left, the *when*-clause specifies an Adv-time which contains (in terms of coincidence) the situation time of the head clause. There are various other types of time clauses, e. g. relative clauses depending on an antecedent referring to time (e. g. [*I'll always remember the day*] *when she died*), time clauses with a nominal function (e. g. [*I don't know*] *when he did it*), narrative time clauses (e. g. [*We were having tea*] *when suddenly the window burst*), etc.

Time line: the conceptualization of the way time 'flows' by users of English. The time line is conceptualized as consisting of two different time-spheres, viz. the past time-sphere and the present time-sphere, between which there is felt to be a break.

Time of orientation: see orientation time.

Time of the full situation: time which is taken up by the full situation and which may be longer than the time of the predicated situation (= the situation time) if the (actualization of the) situation is homogeneous (= nonbounded). For example, in *Two minutes ago John was in the library*, the situation time is that portion of the full situation (of John being in the library) that coincides with the Adv-time specified by *two minutes ago*. The time of the full situation may be much longer and may include the temporal zero-point.

Time of the predicated situation: time taken up by the predicated situation.
Synonym of situation time.

Time of the situation: see situation time.

Time-specifying adverbial: temporal adverbial like *at 5 p.m.*, *yesterday*, etc. whose function is to locate a situation time or other orientation time in time by indicating a specific Adv-time ('adverbially indicated time'). This Adv-time 'contains' the orientation time in question in terms of inclusion or coincidence.

Time-sphere: one of the two main divisions of time reflected in English tense morphology, namely 'past' and 'nonpast'. Hence, we speak of the past time-sphere and the present time-sphere (or nonpast time sphere). In more detail: the use of a tense form in English implies that the speaker views the time of the predicated situation referred to (= the situation time) as either past or nonpast with respect to the time functioning as temporal zero-point (which is usually the moment of speech). This means that any tense form locates a situation time either in the past time-sphere or in the present time-sphere. These time-spheres are not objective physical entities but represent the ways in which an English-language user conceptualizes time. The past time-sphere is conceived of as a time span of indefinite length which lies wholly before (and hence does not include) the temporal zero-point. To locate a situation time in this time-sphere the speaker uses the preterite (past tense). The present time-sphere is

conceived of as a time span of indefinite length which includes the zero-point and is divided by it into three zones: the portion of the present time-sphere that starts before the zero-point and leads up to it is the pre-present (zone); the portion that coincides with the zero-point is the present (zone); and the portion that follows the zero-point is the post-present (zone).

Time-zone (or zone): cover term for any of the four portions of time that together make up the two time-spheres: the three parts of the present time-sphere, namely the pre-present zone, the present zone and the post-present zone, plus the past zone (which coincides with the past time-sphere). Since these four zones (pre-present, present, post-present and past) are defined in direct relation to the temporal zero-point, they constitute the set of absolute zones (or absolute time-zones).

T-interpretation: (a) in general: temporal reading which is based on the semantics (= tense structure) of the chosen tense only; (b) in connection with the present perfect: one of two possible readings that are compatible with the semantics of this tense, namely a 'before now' interpretation (as in *I have done it*) and a 'co-extensive' interpretation (as in *Where have you been?* or *I've been living here for years*).

T-posterior: showing the relation of T-posteriority. A given time A is T-posterior to another time B if the speaker uses a tense form (such as the conditional tense) to represent A as following B, i.e. as predicted or predictable (but not yet a fact) at time B.

T-posteriority: posteriority (futurity) expressed by a tense. For example, in *Jim said he would do it*, the conditional tense form (*would do*) expresses T-posteriority: it represents the situation time of Tim's doing it as following the situation time of his speaking.

Transition: punctual change of one state into another.

Transition reading: punctual interpretation of a clause involving the use of a transitional situation verb, as in *He died* (as opposed to *He was dying*).

Transitional: ontological feature of a situation-template which consists in a single transition, conceived of as punctual, from one state into another.

Transitional situation: situation represented as involving, or consisting of, a single, punctual change of one state into another (e.g. a death).

Transitional situation verb: verb like *die*, *kill*, etc., which refers to a punctual transition or, when the progressive form is used or a nonpunctual duration adverbial is added, to the durative preparatory phase leading up to the transition in question.

Transitive verb: (a) verb that is accompanied by a direct object as complement; (b) verb like *eat* that can in principle take a direct object, even if it does not do so in certain sentences (where it is used intransitively, i. e. without a complement, e. g. *John is eating*).

Transparent interpretation: interpretation in terms of the speaker's actual world. For example, in *John believes that Paris is the capital of Italy*, the *that*-clause is true in the intensional world of John's belief, but not in (what the speaker knows to be) the actual world. That is, *Paris is the capital of Italy* is true on an intensional (opaque) interpretation, but not on a transparent one.

T-relate: express a T-relation.

T-relation (or **tense relation**): temporal relation expressed by a tense form. For example, the future perfect, which is an absolute-relative tense, expresses two T-relations: 'The time of the situation is anterior to an implicit time of orientation' and 'the implicit time of orientation is posterior to the temporal zero-point' (e. g. *He will have left*).

T-simultaneity: kind of T-relation: the situation time is linguistically represented as simultaneous with an orientation time. T-simultaneity is by definition a relation of strict coincidence. Thus, in *Meg said that she was feeling ill*, the situation time of Meg's feeling ill is represented by the tense form as strictly coinciding with the situation time of Meg's speaking, even though the W-relation between the (actualizations of) the two situations is assumed to be one of W-simultaneity, i. e. overlap or inclusion.

T-simultaneous: showing T-simultaneity. A given orientation time A is T-simultaneous with an orientation time B if the speaker uses a tense form representing A as coinciding with B.

Type of situation: see situation type.

Unanchored time-specifying adverbial (or **nondeictic time-specifying adverbial**): time-specifying adverbial which does not relate the Adv-time which it indicates to a temporal anchor. For example: in *I've heard that name at some time or other*, the Adv-time specified by *at some time or other* is anchored neither to the temporal zero-point nor to a contextually given time.

Unbounding constituent: clause constituent which removes the idea of a temporal right boundary, thus rendering the clause L-nonbounded, e. g. the constituent to *party activists* in *Bill handed out the Labour Party badge to party activists* or the temporal adverbial in *I will run the marathon for many more years*.

Unembedded clause: syntactically independent clause. See also matrix.

Unexpanded domain: temporal domain which consists of just one situation time: the set of orientation times forming the domain is a singleton. For exam-

ple, in *He left at five and I will leave at eight*, both tense forms establish a past domain of their own which is not further expanded.

Universal (or gnomic) sentence: sentence referring to a habit or other state which holds at all times or at every time in the existence of the referent of the subject (e.g. *Two and two is four*; *The sun rises in the east*).

Unmarked interpretation: the interpretation which (failing any indication to the contrary) the addressee or hearer will naturally assume to be the reading that is intended by the speaker.

Unmarked up-to-now reading (or unmarked up-to-now interpretation): up-to-now reading (of a clause in the present perfect) which is not a constitution reading, because it is not specificational. For example: *You've been thinking of something else all the time I've been talking*.

Unspecified orientation time: orientation time which has to be recovered from the linguistic context. For example, in the case of the sentence *Bill had left the room*, the orientation time to which Bill's leaving is related as T-anterior may be the time of a predicated situation referred to in a previous sentence (as in [*When Megan woke up, it was no longer dark.*] *Bill had left the room*), or it may be an otherwise unspecified time contained in an Adv-time (e.g. *Yesterday Bill had left the hotel*). Only in the former case do we speak of an 'unspecified orientation time'.

Untensed (or nontensed or tenseless) verb form: verb form which is not marked for tense, i.e. which does not encode information about how a situation time is related (directly or indirectly) to the temporal zero-point. Nonfinite verb forms and subjunctive verb forms are tenseless in this sense.

Up-to-now perfect: shorthand for 'present perfect used in a clause receiving an up-to-now reading'.

Up-to-now reading (or up-to-now interpretation): one of three possible W-interpretations of a clause in the present perfect, namely that in which the full situation fills the entire period leading up to the temporal zero-point (t_0) but does not include t_0 , thus coinciding with the situation time (which itself coincides with the pre-present zone). Such a reading is assigned, for example, to *Where have you been?*, when said to someone who has just come in.

Utterance: a structured set of words which a speaker or writer produces in the form of speech sounds or letters. A meaningful utterance is the physical form of a sentence.

Utterance-explaining *because*-clause: clause which is introduced by the subordinating conjunction *because* and which explains why the speaker makes the

speech act (i. e. assertion, question, instruction, etc.) that he makes by uttering the head clause. For example: [*You'd better hurry up,*] *because there's going to be a storm.*

Value (of specificational sentence): that constituent of a specificational structure that is specified as value for a presupposed variable, e. g. *a book* in *It was a BOOK* that I gave him, *What I gave him was a BOOK*, *I gave him a BOOK*, *A BOOK* was what I gave him. The value constituent always receives a heavy (contrastive) accent.

Value constituent: constituent representing the value of a specificational sentence, e. g. *a book* in *What I gave him was a BOOK*.

Vantage time: a point in time or a time interval from which (the actualization of) a situation is viewed as ongoing (= in progress) by the speaker referring to that progressive situation. The vantage time is explicitly mentioned in sentences like *At 7 p.m. I was still working.*

Variable (of specificational sentence): the (presupposed) constituent of a specificational structure for which a value is specified (or, in questions, asked). For example, in each of the following sentences the variable is 'the x that I gave him': *It was a BOOK* that I gave him, *What I gave him was a BOOK*, *I gave him a BOOK*, *A BOOK* was what I gave him.

Variable constituent: constituent representing the variable of a specificational sentence, e. g. *What I gave him* in *What I gave him was a BOOK*.

Verb complement: a VP internal argument of a verb (i. e. any argument of the verb that is not the subject), such as a direct object (e. g. *I hit him*), indirect object (e. g. *I gave him a kite*), subject complement (e. g. *Bill is ill*), object complement (e. g. *We called him a fool*), prepositional object (e. g. *I looked into the question carefully*).

Verb form: particular form of a verb. In *Bill sneezed*, the verb form *sneezed* consists of a conjugated form of the verb *sneeze* only; so does *takes* in *Bill takes drugs*; in *Bill may have been working*, the verb form consists of the participle form of the main verb (*working*) preceded by three auxiliary verbs; in *John will leave now*, the form consists of one auxiliary followed by the present infinitive form of the main verb.

Verb of creation: verb like *write*, *form* or *build*, which expresses the making (bringing into existence) of something. In clauses like *A problem has {arisen / cropped up}*, the verbs *arise* and *crop up* are also called verbs of creation because they refer to the coming into existence of something.

Verb phrase (VP): phrase whose head is a main verb. In the clause *John left the house last night*, the verb phrase is *left the house last night*. In this case the

verb phrase constitutes the entire predicate constituent. (The latter comprises the verb phrase plus the optional adverbials, if any.) A verb phrase minimally consists of a verb form. It also includes the verb complement(s) and/or the necessary adverbial(s), if any.

Verb stem: that part of the verb that remains constant in the different forms of the verb, e.g. *unchain* in *unchains*, *unchained*, *unchaining*. As a rule, the stem is identical in form with the present infinitive or the present subjunctive form of the verb.

Voice auxiliary: the grammatical auxiliary *be* when it is used to build a passive verb form.

VP: conventional linguistic abbreviation of verb phrase.

W-anterior: time A is W-anterior to time B if it is anterior to B without necessarily being represented as T-anterior to time B by a tense form.

W-anteriority: anteriority that exists in the actual world (or in whatever non-factual world is being referred to) but which is not necessarily expressed by the tense used. For example, in *I left before John arrived*, my leaving is W-anterior to John's arrival, but it is not represented as T-anterior to it by the tense form *left*.

W-bounded: said of a bounded situation whose boundedness is not a question of linguistic representation – see L-bounded – but merely a matter of interpretation based on pragmatic inference. For example, out of context the sentence *John was in the park this morning* will be taken to imply that John is no longer in the park at the temporal zero-point, but this implicature can be cancelled by a contextual addition like *and he told me he would stay there until you came to fetch him, so you'd better hurry off*. In other words, in isolation the sentence *John was in the park this morning* is by implicature interpreted as W-bounded, but is not L-bounded (= linguistically represented as bounded).

W-bygone situation: situation which is conceived of as completely over at the temporal zero-point, as in *I've closed the door*; *Once upon a time there was a princess who felt very lonely*.

W-concept: concept which has to do with the interpretation of situations and temporal relations in the actual world or in whatever alternative world is being referred to. (contrasted with T-concept)

Weak verb: see regular verb.

Weak intensional verb: verb like *see* or *say*, which establishes an intensional domain but allows its object clause to create a new temporal domain so that the clause in question receives a transparent interpretation rather than an inten-

sional (opaque) interpretation. There is such a shift of domain, e.g. in *Bill {saw / said} that the bridge is rather mouldered*. See also strong intensional verb.

Wh-question: interrogative sentence or subclause containing a question word (usually in initial position), with the question having narrow scope (over the questioned constituent only), e.g. *Who did that? – [I don't know] who did that*.

Wide scope negation: negation with scope over the entire clause or sentence, as in *These spiders are not dangerous* (= 'It is not the case that these spiders are dangerous').

Wide scope question (or 'polar question' or 'yes / no-question'): interrogative sentence or subclause expressing a question which invites either *yes* or *no* as an answer (e.g. *Did you tell him about me?*). That such questions have wide scope is illustrated by the fact that they allow a paraphrase like *Is it true that ...?* or *Is it the case that ...?*

W-interpretation: (a) in general: temporal reading which is not exclusively based on the semantics of the chosen tense but also takes into account such elements as temporal adverbials, context, situation of speaking, knowledge of the (actual or nonfactual) world referred to and pragmatic principles such as the Gricean Maxims of conversation, (b) in connection with the present perfect: one of three possible readings related to the full situation: the 'indefinite reading' (i.e. the full situation comes to an end before the temporal zero-point), the 'continuative reading' (i.e. the time of the full situation includes t_0) and the 'up-to-now reading' (i.e. the terminal point of the full situation preceding t_0 is adjacent to t_0).

W-nonbounded: said of (the time of actualization of) a full situation which is not *interpreted* as bounded, even though its situation time may be *represented* as bounded. For example, in *From 9 to 12 Tom was not in his office*, the situation time is bounded by virtue of being contained by (in this case: coinciding with) the Adv-time specified by the heterogeneous time adverbial *from 9 to 12*. However, unless *from 9 to 12* is taken to represent important new information, the time of (actualization of) the full situation is not interpreted as bounded: Tom may also have been absent from his office before nine and/or after 12. In fact, it is theoretically possible that he has *never* been in his office. In that case the (time of actualization of) the full situation of his not being in his office is clearly W-nonbounded, i.e. not interpreted as bounded. Similarly, sentences like *John was reading the letter* or *John drank whisky* do not involve reference to a terminal point, so that the actualizations referred to are not represented as bounded (= reaching a terminal point). However, it is possible that for pragmatic reasons (e.g. present knowledge of the actual world) the

actualization is interpreted as being over (and hence as bounded). If that is the case, the (actualization of) the situation is L-nonbounded but W-bounded.

World relation: see W-relation.

W-posterior: time A is W-posterior to time B if it is posterior to B without necessarily being represented as T-posterior to B by a tense form.

W-posteriority: posteriority that exists in the actual world (or in whatever non-factual world is being referred to) but which is not necessarily expressed by the tense used. For example, in *I left before John arrived*, John's arrival is W-posterior to my leaving but is not represented as T-posterior to it by the tense form *left*. (T-posteriority would be expressed by *had left*.)

W-relation: temporal relation that exists between two times but is not necessarily a T-relation (i.e. a relation expressed by a tense form). The unmarked interpretation of the term 'W-relation' is: temporal relation not expressed by a tense form. In that case, the nature of the temporal relation can only be identified from pragmatic knowledge or inference. A W-relation is either W-anteriority, W-posteriority or W-simultaneity.

W-simultaneity: simultaneity that exists in the actual world (or in whatever nonfactual world is being referred to) but which is not necessarily expressed by the tense used. For example, in *There had been no one in the house when he had first visited it*, the two situations are (and are interpreted as being) W-simultaneous with each other, but the past perfect tense forms represent both as T-anterior to the same (unspecified) past orientation time. Unlike T-simultaneity, W-simultaneity need not be a relation of strict coincidence: it is sufficient that the two times in question have a point in common. For example, in *I live in London*, the (durative) full situation includes the (punctual) temporal zero-point. The containment relation between a situation time and the time (of actualization) of the corresponding full situation is also an instance of W-simultaneity.

W-simultaneous: time A is W-simultaneous with time B if it is simultaneous with B but not necessarily represented as T-simultaneous with B by a tense form. Two times are W-simultaneous with each other if they have at least one point in common. See also W-simultaneity and W-simultaneous domains.

W-simultaneous domains: separate temporal domains which are interpreted as W-simultaneous. For example, in *He looked at the figure in the distance but didn't recognize it*, both preterite forms establish a domain of their own, but these are interpreted as W-simultaneous with each other.

Yes / no-question (or **polar question** or **wide scope question**): interrogative sentence or subclause expressing a question to which the expected reply is *yes*

or *no*. The clause does not contain a question word, and the question has scope over the entire proposition. For example: *Is the house humid?* (= 'Is it the case that the house is humid?')

Zero-conjunction: This term is used in cases of syntactic subordination, when the subclause is not connected to the head clause by a subordinating conjunction. Thus, in *I said you could trust me*, the nominal clause (object clause) is not introduced by the conjunction *that*.

Zero-point: see temporal zero-point (t_0).

Zero-time: see temporal zero-point (t_0).

Zone (or time-zone): cover term for any of the four portions of time that together make up the two time-spheres: the three parts of the present time-sphere, namely the pre-present zone, the present zone and the post-present zone, plus the past zone (which coincides with the past time-sphere). Since these four zones (pre-present, present, post-present and past) are defined in direct relation to the temporal zero-point, they constitute the set of absolute zones (or absolute time-zones).

Zone-independent adverbial: see zone-independent time-specifying adverbial.

Zone-independent time-specifying adverbial (or zone-independent adverbial): time-specifying adverbial which specifies a time which is not linked up with one particular time-zone, e. g. *at five o'clock*. Such an adverbial is compatible with more than one absolute tense: *He left at five o'clock*; *He will leave at five o'clock*.

DELETED

References

- Brinton, Laurel
2000 *The Structure of Modern English: A Linguistic Introduction*. Amsterdam / Philadelphia: John Benjamins
- Bussmann, Hadumod
1996 *Routledge Dictionary of Language and Linguistics*. London / New York: Routledge.
- Comrie, Bernard
1985 *Tense*. Cambridge: Cambridge University Press.
1986 Tense in indirect speech. *Folia Linguistica* 20: 265–296.
- Cygan, Jan
1972 Tense and aspect in English and Slavic. *Anglica Wratislaviensia* 2: 5–12.
- Declerck, Renaat
1991 *Tense in English: Its Structure and Use in Discourse*. London / New York: Routledge.
1997 *When-clauses and Temporal Structure*. London / New York: Routledge.
- Declerck, Renaat and Susan Reed
2001 *Conditionals: A Comprehensive Empirical Analysis*. Berlin / New York: Mouton De Gruyter.
- Donnellan, Keith S.
1966 Reference and definite descriptions. *The Philosophical Review* 75: 281–304.
- Fleischman, Suzanne
1982 *The future in Thought and Language: Diachronic Evidence from Romance*. Cambridge: Cambridge University Press.
- Haegeman, Liliane
1989 *Be going to* and *will*: a pragmatic account. *Journal of Linguistics* 25: 291–317.
- Huddleston, Rodney
1976 Some theoretical issues in the description of the English verb. Review article on Palmer (1974). *Lingua* 40: 331–383.
- Grice, H. Paul
1975 Logic and conversation. In: Peter Cole and Jerry L. Morgan (eds), 41–58, *Syntax and Semantics. Volume 3: Speech Acts*. New York: Academic Press.
- Jespersen, Otto
1932 *A Modern English Grammar on Historical Principles. Part 4: Syntax (3rd volume)*. London: Allen and Unwin; Copenhagen: Ejnar Munksgaard.
- Klein, Wolfgang
1992 The present perfect puzzle. *Language* 68: 525–553.
1994 *Time in Language*. London / New York: Routledge.
- Lakoff, George
1970 A note on ambiguity and vagueness. *Linguistic Inquiry* 1: 357–359
- Lakoff, Robin
1970 Tense and its relation to participants. *Language* 46: 838–849.

Leech, Geoffrey

1971 *Meaning and the English verb*. London: Longman.

Levinson, Stephen S.

2000 *Presumptive Meanings: The Theory of Generalized Conversational Principles*. Cambridge, MAS: MIT Press.

Lyons, John

1977 *Semantics*. Cambridge: Cambridge University Press.

Matthiessen, Christian.

1983 Choosing primary tense in English. *Studies in Language* 7: 369–429.

Palmer, Frank R.

1974 *The English Verb*. London: Longman.

1988 *The English Verb*. Second edition. London: Longman.

Quirk, Randolph, Sidney Greenbaum, Geoffrey Leech and Jan Svartvik

1985 *A Comprehensive Grammar of the English Language*. London: Longman.

Vendler, Zeno

1967 Verbs and times. In: Zeno Vendler, 97–121, *Linguistics in Philosophy*. Ithaca, NY: Cornell University Press.

DEMO

Index

A

- absolute deictic relation 485, 490
absolute deictic time-specifying adverbial 112, 591–592, 629
Absolute Future System 519, 527, 531, 535–557, 560–565, 567–570, 638, 676, 692, 701, 703, 706, 725–726, 737, 746, 754, 756–757
absolute past tense 153, 155–156, 193–208, 373–374, 383–424, 435–438, 444, 446, 449–450, 502, 573, 655, 665, 694–697, 707, 716, 746, 754–755
absolute present tense 171–191, 466, 486, 682
absolute preterite *see* absolute past tense
absolute relation 443
absolute-relative tense 25–26, 156–157, 345, 374, 503, 531–532, 727–728
absolute tense 16, 25, 117, 120, 183–154, 207, 171–360, 378, 381, 383–424, 468, 479–480, 485–487, 529–570, 573, 675–682, 692–717, 721–725, 732, 746
absolute time-zone 150, 169, 371–372, 377, 381, 427–428, 501, 575, 593, 629
absolute zone *see* absolute time-zone
abstract situation type 41, 49–71
accomplishment 70–71
achievement 70–71
action 57, 66–69
action verb 68
activity 69–71
actualization 12, 40
actualization adverbial 622–623, 632
actualization aspect 30, 72–81
actualization focus 204–206, 299, 319–322, 326, 331, 604–605
actualization-explaining *because*-clause 552–553
actualize 12, 40
adjectival clause 14
adverbial *see* absolute deictic time-specifying adverbial, actualization adverbial, bifunctional adverbial, deictic time-specifying adverbial, duration adverbial, durative time-specifying adverbial, inclusive duration adverbial, multiple-orientation-time adverbial, multi-zone adverbial, nondeictic time-specifying adverbial, noninclusive adverbial, orientation-time adverbial, past zone adverbial, present zone adverbial, punctual time-specifying adverbial, pure duration adverbial, relative-absolute deictic time-specifying adverbial, relative deictic time-specifying adverbial, single-zone adverbial, situation-time adverbial, temporal adverbial, time-specifying adverbial, zone-independent adverbial
adverbial clause 14 (*see also after*-clause, *because*-clause, *before*-clause, bounded clause, conditional clause, free relative clause, heterogeneous, homogeneous, nonbounded, *since*-clause, subclause, *until*-clause, *when*-clause, *while*-clause)
Adv-time 119, 122, 132–144, 173, 367–368, 612, 644
Adv-time adverbial *see* time-specifying adverbial
Adv-time of the head clause 642–643, 651–652
Adv-time of the *when*-clause 642–645, 650, 654
Adv-time-relation 122, 134

Adv-time-simultaneity 134–135, 139–140, 145
after-clause 446, 523, 741–753
 agent 48, 53, 67, 186, 191
 agentive 50–54, 61, 66–70, 281, 290, 342–343, 346, 356
 Aktionsart *see* ontological aspect
 Anchor time 195, 197, 202, 289, 320, 352, 562, 591, 629, 688–692, 706–718, 722–728, 738–751
 anchored time-specifying adverbial *see* deictic time-specifying adverbial
 anteriority 17–18, 25, 161 (*see also* T-anteriority, W-anteriority)
 argument (NP) 20–21, 79, 123, 295, 541
 aspect *see* actualization aspect, grammatical aspect, ontological aspect
 aspect auxiliary 19
 aspectualizer 31–32
 assertive clause 606
 atelic 60–65, 68, 70–71, 75–77, 115, 306, 366–367, 595
 atemporal *when*-clause 672
 attributive definite noun phrase 204, 247, 574, 592
 auxiliary 18–20
 auxiliary verb *see* auxiliary

B

background 177, 430
 background situation 220, 225, 274, 284–286, 470
 backgrounding 430
 backshifted 384, 390, 394, 396, 471, 698, 719
 backshifting 391
 basic orientation time 474, 537–538, 543–548, 554
because-clause 552–554
before-clause 406–408, 446, 523, 562–563, 607, 685–741, 754–755
 ‘before now’ interpretation 215, 219
 bifunctional adverbial 133–134, 233, 591, 612–613, 738–739

bifunctional temporal adverbial *see* bifunctional adverbial
 binding *see* direct binding, indirect binding, temporal binding
 binding time 118, 158, 375
 bound time 118, 158, 369
 bounded 30, 61, 72–82, 114–115, 121–125, 140–143, 145–146, 190 (*see also* L-bounded, W-bounded)
 bounding constituent 79–80
 bygone 196 (*see also* T-bygone, W-bygone)

C

case-specifying *when*-clause 671
 central orientation time 154, 159, 169, 376–377
 central time of orientation *see* central orientation time
 clause 13–14 (*see also* head clause, matrix, subclause)
 cleft 260, 265–267, 545, 631, 733–734 (*see also* *since*-cleft)
 cleft construction *see* cleft
 cleft sentence *see* cleft
 closed condition 103–104, 354–355, 520, 536, 545–546, 556, 566–567
 code 20, 720
 co-extensive interpretation 215–216, 445–446, 459–460
 coincidence 122–126, 132–136, 369–370, 494
 common Adv-time 644, 646–650, 654, 667
 complement 20–21 (*see also* complement clause)
 complement clause 393, 401, 475, 495, 521, 548–550
 complex relative tense 26
 complex relation *see* complex T-relation
 complex sentence 14, 539
 complex T-relation 457, 664
 conditional clause 129, 352, 359, 455–456, 495, 540, 566–568

conditional connotation 540, 545, 556, 565–566, 674

conditional perfect (tense) 22, 24, 457–458, 520, 523–524, 673, 715, 735

conditional sentence 129, 166, 354, 497, 556

conditional tense 22, 24, 158, 166, 341–342, 387, 405–408, 421–424, 436, 450, 520, 523, 735

conjugation 18

constitution interpretation (of a clause in the present perfect) *see* constitution reading

constitution reading 229, 256, 255–269, 279–286, 288, 290, 292–293, 324, 326, 331–332, 613, 618–622

contain 122, 132, 134, 212, 640, 644

contained orientation time 134, 640–642, 644–662, 664, 667, 670, 677–678, 687–691, 723, 727–728, 731, 734, 739, 741, 744, 747, 750–753

containment 122–123, 132, 134, 137, 139, 214–215, 643, 645, 650–651, 687, 691, 750

continuative habit 228, 237, 240, 271–273

continuative interpretation *see* continuative reading

continuative perfect 226, 460

continuative reading (of clause in the present perfect) 216, 219, 222, 225–228, 230–243, 245–246, 260–263, 265–267, 271–274, 287–291, 323–325, 350, 364, 460, 470, 478–484, 600, 606, 608–610, 613–615, 617, 622

continuous form *see* progressive form

copula 21

core meaning of a tense 214, 216

counterfactual 128–129, 568, 673–674, 710–713, 715–718, 735–736

counterfactual *before*-clause 735–736

counterfactual *when*-clause 673–674

counterfactual world 42, 674

D

de dicto interpretation *see* intensional interpretation

deictic adverbial *see* deictic time-specifying adverbial

deictic time-specifying adverbial 591–592

denotation 40–49, 55–59, 70, 136–138

dependent clause *see* subclause

de re interpretation *see* transparent interpretation

direct binding 393, 407, 516–522, 660–666

direct result 248, 280–281, 302–306

direct speech 390

dissective 594

domain *see* temporal domain

do-support 20

double pluperfect 27

duration adverbial 59, 75–76, 133, 143, 227, 235, 243, 287, 364, 366–367, 739 (*see also* pure duration adverbial, bifunctional adverbial)

duration-quantifying constitution reading 229, 248, 255, 258–259, 261–263, 265, 282–283

durative situation 45, 47, 49, 51, 55, 57–58, 67, 70–71, 74, 113, 131, 140–141, 167–168, 173–175, 413–415, 508

durative situation verb 45–46, 59

durative situation verb phrase 57, 62

durative time-specifying adverbial 132–133, 138–139

durative verb phrase *see* durative situation verb phrase

dynamic 51–52, 67–71

dynamic verb phrase 52, 68

E

effected noun phrase 298–300

egressive aspect *see* terminative

embedded clause *see* subclause

enriched situation-template 40–41
 epistemic modal adverbs 187
 epistemic modality 39, 103–105, 453
 establish a domain indirectly 488, 500,
 681, 720, 725
 evaluation time 105, 138, 163, 547,
 583–585
 event 46, 48, 66–67, 68–69
 event verb 68
 evidential *because*-clause 553–554
 evolving 65, 68–70
 expand (a temporal domain) 121,
 123–125, 158
 expanded domain 123–125, 158
 experiential indefinite perfect *see* per-
 fect of experience
 experiential perfect *see* perfect of ex-
 perience
 explanatory-resultative (use of the pres-
 ent perfect) 253–255, 277–279, 293
 extensional interpretation *see* transpar-
 ent interpretation

F

factual *see* factual at t_0
 factual at t_0 235, 606, 689, 693–697,
 699, 707, 710–719, 722, 725–726,
 730–737, 739, 747–748, 750, 754–
 756
 factual full situation 144, 235, 364, 612
 finite clause 42–44
 finite verb form 45, 98, 485
 focalizing *when*-clause 671
 foreground 177, 430
 foregrounding 430
 free indirect speech 390, 452, 583,
 452–453, 583, 747–748, 753
 free relative clause 637, 642
 full situation 113–116, 122–125, 127,
 133, 135–136, 138–146, 164–168,
 173–175, 189–190, 196–199, 207,
 213, 216–229, 233–238, 253, 256,
 267, 290–292, 364–366, 368–369,
 377–378, 413–414, 459–461, 474,
 478–483, 573, 586–587, 612–614

(*see also* factual full situation, poten-
 tial full situation)
 full verb 18–19, 31
 future 120 (*see also* post-present zone)
 future continuous form *see* progressive
 form
 future perfect (tense) 25, 97, 108, 493,
 503–504, 518–520, 532, 558, 725–
 726, 749–750, 755
 future tense 22, 24–25, 78, 96–97,
 101–108, 162–163, 337–340,
 342–345, 499–500, 519–520, 531–
 532, 537–569, 675–676, 700–703,
 749–750
 futurish tense form 106–108, 268,
 337–340, 345–346, 356–360, 392,
 451–455
 futurity *see* posteriority

generic sentence 151
 gerund 18, 99
 gnomic sentence 130–131
 grammatical aspect 28–31, 35, 56, 77,
 81
 grammatical auxiliary 19
 Gricean Maxim 32, 63, 73, 88, 133,
 136, 185, 198, 271, 349, 454, 577,
 599, 617, 649, 672, 737

H

habit 28–29, 34–35, 37, 52–54, 131,
 271–273, 277, 288–290, 402–405,
 436, 619, 676–678, 680–682, 701,
 704–706, 729
 head (of a phrase) 12
 head clause 14, 380, 687
 headless relative clause 559, 637 (*see*
also free relative clause)
 heterogeneous 45–46, 49–50, 55–56,
 74–75, 77–78, 114–115, 145, 165,
 235, 253, 366, 394, 396–397, 413–
 414, 551
 heterogeneous Adv-time 594–595,
 599–600, 629

- historic(al) present 28, 176–178, 382, 398, 424–425, 704–705, 729
 homogeneous 35, 45–47, 49–51, 55–57, 74–75, 77, 114–115, 123–125, 131, 136, 138–142, 174–175, 190, 222, 235, 365–366, 392, 413–415, 470, 551, 576
 homogeneous Adv-time 593–594, 601–602, 629–630, 669
 hot news reading (of the present perfect) 246–247, 249–250, 297, 301, 460, 463–464
 hypersituation 28, 36–37, 58, 76, 79–80, 225, 229, 231–232, 238, 258–259, 267–269, 272–273, 279–280, 283–285, 291–292, 462, 470–473, 475–476, 483, 487, 595, 613–614, 677, 704
- I**
- iconic sequencing 428, 431
 imperfective 28, 31–35, 38
 implicature 32, 54, 62–63, 73, 197–199, 247–248, 254, 273, 280–281, 301–306, 349–351, 431, 454, 577, 644, 647–648, 654, 713, 737 (*see also* Gricean Maxim)
 implicature of discontinuation 197–199, 365
 implicit condition 342, 347, 353, 458, 676, 715, 717
 implicit orientation time 119, 161, 367–368, 406–408, 436, 508, 524, 561–562, 638, 640, 642, 644, 646–649, 650, 652, 670, 689–691, 695–696, 706–709, 715, 718–719, 722, 725, 728, 734, 738, 740, 742–744, 748–750, 755–757
 implicit pre-present (time-zone) 214, 255, 258, 295, 298–300, 305, 474
 inceptive *see* inchoative
 inchoative 28, 31–32, 75–76, 140–141, 401, 430, 470, 608–609, 669
 inclusion 122, 132–144, 148, 213–229, 233–235, 241–242, 252–253, 267–271, 280, 290–291, 350, 364–365, 370, 379–380, 430–431, 649–651, 658, 688–690, 744
 inclusive adverbial 75–76, 595, 602–603
 incurable habit 54
 indefinite interpretation *see* indefinite reading
 indefinite perfect 226, 460
 indefinite reading (of clause in the present perfect) 216, 219–234, 236–237, 239–250, 261–266, 273–276, 280–282, 287–294, 303–305, 317–319, 321–322, 326, 331–332, 459–474, 480, 484, 501, 504, 607–608, 614–615, 618–619, 623–625, 681, 704, 730, 749
 independent clause 14, 199, 349, 380–381, 495, 520, 535, 673
 indirect binding 378–379, 393–395, 404, 407, 516–522, 660–666, 696–698, 708, 740, 748, 757
 indirect reported speech 349, 388, 390, 395, 411
 indirect result 254, 293, 302–306
 indirect speech *see* indirect reported speech; free indirect speech
 ingressive *see* inchoative
 intensional context *see* intensional domain
 intensional domain 349–350, 388–389, 406–407, 541–544, 554–555, 560–561, 693, 695–697, 707–710, 719, 737, 739–740
 intensional interpretation 388–389, 469, 407, 541–544, 554, 693, 695
 intensional verb 396, 407, 542, 693, 695 (*see also* strong intensional verb, weak intensional verb)
 intensional world *see* intensional domain
 intentionality 54, 186, 191, 342–343, 351
 interpretive unit 540, 547, 553
 intransitive verb 20–21, 36, 40, 65
 inversion 20

- inverted pseudo-cleft 260
 irrealis 128–129, 568, 673–675, 710–713, 715–718, 735–736
 irregular verb 23–24
it-cleft *see* cleft
 iterative *see* repetitive
 iterative verb 50
- K**
- kind of situation *see* situation type
- L**
- L-bounded 73, 79–82, 140, 142, 198, 226, 235, 237, 272, 366–367, 429–431 (*see also* bounded)
 L-bounding constituent *see* bounding constituent
 lexical aspect *see* ontological aspect
 lexical meaning 18–20, 40, 47
 lexical verb 18–19, 31
 linking verb *see* copula
 L-nonbounded 73, 77, 79–82, 227, 239, 268, 291, 366, 429, 431 (*see also* nonbounded)
- M**
- main clause *see* head clause, matrix
 main verb 15, 20, 23, 96, 99
 marked interpretation 576, 647, 649, 661, 667
 marked temporal focus 576–581, 583–584
 marked tense 501, 675
 matrix (clause) 14, 381, 393, 516–517, 660, 666, 695–697, 757
 Maxim of Quantity 133, 136, 599
 Maxim of Relation 185, 198, 323, 349, 454, 577, 617, 672
 Maxim of Relevance *see* Maxim of Relation
measure (a period or situation) 62–64, 75–76, 79–80, 142, 223, 229, 259, 269, 282–283, 595, 620, 703, 735, 745
measure phrase 265, 447, 606, 711, 715–717, 719, 728, 731, 734, 736, 745, 751
 metalinguistic negation 244
 metaphorical uses 27–28, 337, 382, 424–425, 438, 501–502, 711, 731
 modal auxiliary 19, 34
 modality 22, 27, 38–39, 102–103, 105–106, 116, 128–129, 147, 162, 166, 187, 200, 340–342, 348, 356, 453, 541, 583, 587, 636, 702, 715, 721
 momentary *see* punctual
 mood 39
 multi-zone adverbial 593, 603–605, 629–630
 multi-zone time-specifying adverbial *see* multi-zone adverbial
 multiple-orientation-time adverbial 137
- N**
- narrative *before*-clause 730–733
 narrative clause 177, 275, 446
 narrative text 430, 452, 455, 587, 670
 narrative *when*-clause 275, 638
 neutral prediction 342, 359 (*see also* pure future)
 NICE-properties 20
 nominal clause 14, 540–541, 550–552, 559, 637
 nominal relative clause *see* free relative clause
 nonassertive clause 606
 nonbounded 72–82, 121–125, 145, 190 (*see also* L-nonbounded, W-nonbounded)
 nondeictic adverbial *see* nondeictic time-specifying adverbial
 nondeictic time-specifying adverbial 591–592, 596 (*see also* unanchored time-specifying adverbial)
 nondurative *see* punctual
 nonepistemic modality 39, 147
 nonevent 289

- nonfactual 42 (*see also* intensional interpretation, intensional domain, not-yet-factual at *t*, not-yet-factual at *t*₀)
- nonfinite clause 13, 44, 98, 162
- nonfinite verb form 16–17, 98–99, 121, 162
- nonhomogeneous *see* heterogeneous
- noninclusive adverbial 75, 595, 599–602
- nonpast time-sphere *see* present time-sphere
- nonprogressive form 22, 29–30, 34–36, 49, 57, 81, 99, 115, 122, 141, 174, 180–186, 191, 199, 224, 228, 269, 271–272, 276–277, 281, 284–285, 287–288, 290, 337, 343, 348, 357, 360, 369, 401, 412–413, 454, 551
- nonprogressive meaning 29, 49, 72, 81–82, 85, 271, 366–367
- nonquantificational constitution interpretation *see* nonquantificational constitution reading
- nonquantificational constitution reading 229, 248, 253–254, 256–258, 261, 279–282, 290, 293, 303, 311–312, 317, 324, 445, 478, 613, 618
- nonrepetitive 36, 75, 474, 485
- nonstatic *see* dynamic
- not ... until* 740–741
- not-yet-factual *see* not-yet-factual at *t*
- not-yet-factual at *t* 120, 406–407, 694, 709, 712, 717–718, 726, 755
- not-yet-factual at *t*₀ 162, 340, 541, 695, 712, 719
- not-yet-factual at the binding time *see* not-yet-factual at *t*
- not-yet-factual *before*-clause 706, 710–711, 735–738
- noun clause *see* nominal clause
- number-quantifying constitution interpretation *see* number-quantifying constitution reading
- number-quantifying constitution reading 223, 229, 232, 248, 256–258, 283–286, 303, 317, 322, 326, 329, 331–332
- O**
- ontological aspect 29–30, 49–71, 81
- opaque domain *see* intensional domain
- opaque interpretation *see* intensional interpretation
- opaque world *see* intensional domain
- open condition 103, 352, 495, 500, 536, 540, 543–546, 548, 556, 559–561, 568, 649, 676
- operator auxiliary 23–24
- orientation time 16–17, 22, 25–27, 38, 94–96, 105, 117–121, 123, 125–126, 132, 134–135, 137, 139, 143–144, 153–159, 289, 339, 365–370, 372–378, 383–384, 386–388, 392, 399, 402–408, 414–416, 420–424, 444–457, 459, 461–464, 474, 485, 487–494, 498–515, 523–526, 531–534, 537–538, 543–548, 558, 561–564, 568–569, 573, 575, 579–580, 583, 606–607, 616, 637–668, 670, 677–678, 687–691, 694, 700, 706, 719, 722–723, 725–728, 731, 733–735, 738–741, 743–753
- orientation-time adverbial 137, 639, 652, 655–658, 662–663, 687–688, 690, 725, 727–728, 747, 750–753
- participial clause 3
- participle 15–18, 24, 96, 98–99, 162, 497
- past (N) *see* past time-sphere
- past continuous form *see* progressive form
- past domain 121, 154–156, 158–159, 195, 370, 373–374, 383, 385–388, 392–398, 401–404, 420–423, 444–458, 460–463, 492–494, 502–505, 516, 519–520, 681, 720, 722, 725–726, 730–731, 748, 754–757
- past participle 17, 24, 96, 98, 162
- past perfect (tense) 17, 22, 24, 27, 38, 95, 97, 117–118, 120–121, 126,

- 128–129, 152–153, 156–157, 159, 178, 200, 367, 374, 392, 395, 402–404, 420–421, 423–424, 438, 444–448, 460, 501, 505, 507–516, 520–523, 534, 569, 661–666, 689, 698, 704, 712–720, 724, 726–727, 731–736, 744–748, 755
- past represented speech 388, 390–392, 394, 395–397, 401, 413, 436, 451, 469, 471, 521, 542, 555, 698, 719
- past subdomain 159, 435, 449, 491, 502, 666
- past subjunctive 16
- past temporal domain *see* past domain
- past tense 16, 22–25, 27, 64, 96–101, 109, 127–129, 148, 152–156, 163–166, 193–208, 213, 242, 244, 249–250, 275, 293–295, 301–302, 315–333, 365, 372–374, 383–428, 437–438, 444, 446–451, 454–456, 460–471, 477, 479–480, 490–492, 501–503, 505–506, 514, 520–521, 523, 533, 568, 573, 578–584, 586–587, 589–633, 655, 661, 665–670, 677–678, 680–681, 692–699, 707, 711–716, 718–719, 722, 724–726, 730–737, 745–749, 754–756
- past time-sphere 147–148, 150–152, 200, 319, 370–372, 374, 444–457, 518, 580
- past time-sphere domain *see* past domain
- past time-sphere tenses 152, 166, 170, 200, 207, 421, 424, 438, 469, 568, 681, 704, 730
- past time-zone 169–170, 178, 213, 295, 371, 382, 484, 525, 573, 598, 652, 721 (*see also* past time-sphere)
- past zone *see* past time-zone
- past zone adverbial 598
- perfect *see* perfect tenses, present perfect
- perfect aspect 37–38, 109
- perfect gerund 18
- perfect infinitive 17, 98
- perfect of experience 245–250, 274–275, 303, 463–464, 614, 713–714
- perfect tense *see* perfect tenses, present perfect
- perfect tenses 24, 37–38, 143, 514
- perfective aspect 28, 30–31, 38, 366
- perfective meaning 28, 30, 34
- performative sentence 74
- performative speech act 174
- periphrastic auxiliary 19–20
- permanent habit 35, 52, 175, 227, 271–273, 277, 290, 477
- phrase 12–13
- pluperfect *see* double pluperfect, past perfect
- point of view 111, 452–453, 469, 511, 541, 557, 582–583, 717
- possible world 78, 113, 122, 126, 235, 407, 541–543, 674 (*see also* intensional domain)
- posterior *see* posteriority
- posteriority 25, 124–126, 369, 450–458, 462–465, 476, 482, 489–490, 499–500, 575, 655–659, 664, 666–670, 681, 694, 707, 720, 727–728, 733, 739–740, 747–748, 751–753, 757 (*see also* T-posteriority, W-posteriority)
- post-present *see* post-present zone
- post-present domain 130, 153, 339, 345, 358, 380, 382, 384–385, 389, 408, 411, 482, 488–515, 518–520, 529–570, 646, 691, 699–703, 706, 713, 720, 725, 728, 730, 737, 740, 750, 756
- post-present time-zone *see* post-present zone
- post-present zone 9–10, 148–150, 153, 181–188, 268–269, 335–360, 371–373, 377, 380–382, 387–389, 424, 488–515, 529–570, 581, 584–585, 681, 700–702, 725–728, 739–740, 743, 745–746, 749–750, 754–756
- potential full situation 144, 235, 364, 617

- predicate *see* predicate constituent
- predicate constituent 13, 15, 20, 41–43, 47–49, 55–56, 66
- predicated situation 113–118, 138, 142, 164, 174, 196, 364–368
- predicational {clause / meaning / sentence} 260–262
- predictability 103–105, 342, 350–351
- prediction 103–105, 182–183, 337–340, 342, 350, 355, 358–359, 388, 511, 539, 541–542, 544, 560, 737, 748, 750
- preparatory phase 58–60
- pre-present *see* pre-present zone
- pre-present domain 378, 397–398, 459–485, 490, 493–494, 504, 519, 524–526, 698
- pre-present situation 180–181, 254, 256, 271, 278, 281, 291, 460, 463–464, 475, 524–525, 600, 620, 632
- pre-present time-zone *see* pre-present zone
- pre-present zone 109–110, 148–153, 195–196, 200, 207, 212–216, 219–229, 232–234, 238–247, 252–271, 277–292, 295, 302–305, 319, 323–326, 370–372, 397–398, 424, 435, 459–485, 491, 493–494, 501–502, 525–526, 576, 593, 597, 599–602, 608, 612–613, 624, 626, 677–678, 681–682, 704, 730, 745
- pre-present-zone adverbial 593, 599–603, 606, 630
- present continuous (form) *see* progressive form
- present domain 130, 173–175, 380, 485–486, 519
- present gerund 18
- present infinitive 17
- present participle 17, 98, 162, 497
- present perfect (tense) 24–25, 38, 97, 108–110, 143–144, 149–150, 188–191, 200–201, 204–206, 209–332, 417–418, 444–445, 459–462, 464–474, 476–482, 491, 493–494, 501, 503, 508–516, 526, 533, 536–537, 558, 589–633, 659, 677–678, 681–682, 698, 703–706, 713, 730, 745, 749–750
- present perfect continuous form *see* progressive form
- present subjunctive 16
- present tense 22–25, 27–28, 96, 109–112, 128, 130–131, 138–139, 147–149, 152–153, 171–191, 240, 263, 267–269, 297–298, 337, 357, 364, 380, 382, 384–385, 389, 396, 398, 408, 412–414, 423–425, 466–467, 470–471, 478, 480–490, 494–498, 500–502, 505–507, 512–514, 533, 535, 541, 550–552, 557–558, 561, 568–569, 577–578, 584, 609–611, 619, 621, 626, 645–646, 675–677, 680–682, 700–702, 705–706, 713, 720, 729–730, 749–750
- present tenses *see* present time-sphere tenses
- present time-sphere 147–148, 150, 152, 159, 190, 195, 214–216, 250, 370–372, 423–425, 555
- present time-sphere tenses 101, 152, 157, 176, 178, 190, 424, 555, 704
- present time-zone *see* present zone
- present zone 109, 148, 151–152, 371, 525, 583, 593, 629
- pre-supposition 70–71, 143, 202, 247, 254, 258–263, 265, 267, 278, 282, 292, 294, 321–326, 328–329, 331–332, 344, 352, 473, 543–546, 560, 673
- preterite *see* past tense
- Principle of Unmarked Temporal Interpretation 427–433
- prior (to) *see* anteriority
- process 66–69, 186
- process verb 68
- progressive {aspect / form / meaning} 28–38, 46, 49–50, 56–61, 64–65, 68–69, 72, 76–78, 80–82, 96, 99, 108–109, 113, 115, 131, 135–136, 138, 162–163, 173–174, 183–186, 199, 220–221, 225, 231–232, 237–240, 245, 250, 254, 267–269, 271–

- 285, 288, 290, 343–344, 355–358, 412–414, 454, 615, 744
- proposition 38–39, 74, 272, 322, 398, 541, 544–545, 553–554, 560
- prospective meaning 564, 658–659, 668, 670, 727
- pseudo-absolute-relative tense
form 519, 532
- pseudo-absolute subdomain 490, 501
- pseudo-absolute tense 26–27, 408, 411–412, 490–491, 493, 495–496, 498–499, 501–502, 519, 533–534, 750
- pseudo-absolute time-zones *see*
pseudo-absolute zones
- pseudo-absolute zones 489, 499
- pseudo-cleft 260
- pseudo-past subdomain 386, 435, 449, 461, 491–493, 502, 504, 506–507, 534
- pseudo-past zone 159, 490, 526
- pseudo-post-present subdomain 499
- pseudo-post-present zone 499
- pseudo-pre-present subdomain 496, 493–494, 507, 526, 534
- pseudo-pre-present zone 472–473, 491, 493, 502, 504, 526
- pseudo-present subdomain 534
- pseudo-present time 474 (*see also*
pseudo- t_0)
- pseudo-sloppy simultaneity 648–649, 667–672
- pseudo- t_0 26, 147, 411–412, 472, 489–495, 498–503, 506–510, 514, 526, 532–534, 537–538, 541 (*see also* Pseudo- t_0 -System)
- Pseudo- t_0 -System 519, 527, 533–570, 638, 646, 656, 675–676, 681, 689, 691–692, 700–702, 706, 709, 720, 725–526, 528, 737, 740, 743, 746, 749, 755–757
- pseudo-zero-point *see* pseudo- t_0
- punctual Adv-time 132, 135, 138, 140–141, 145, 167, 173, 197, 368, 398, 640 (*see also* punctual time-specifying adverbial)
- punctual situation 36, 45–47, 51, 55, 58–59, 65, 67, 127, 131, 138, 168, 173–175, 637 (*see also* punctual situation type)
- punctual situation time 125, 131–133, 135–136, 138–142, 165–168, 175, 197, 378, 392, 394, 413–414, 508, 639–640, 646, 654
- punctual situation type 50, 57–59, 70
- punctual situation verb (phrase) 45–47, 57–59, 61, 273
- punctual time-specifying adverbial 132, 135–136, 140, 167, 398–401, 436, 616
- punctual transition 59–60, 65, 70
- punctual verb *see* punctual situation verb
- pure duration adverbial 133, 142–144, 167–168, 612, 614, 616, 618, 620, 631
- pure future 103–105, 107, 337, 339–340, 342–345, 352, 359–360
- Q**
- quantificational constitution reading 229, 232, 238, 246, 248, 252–268, 282–286, 288, 290–293, 303, 317, 322, 326, 329, 331–332, 473, 478, 599–600, 613, 618–620, 627, 630
- R**
- recency interpretation *see* recency reading
- recency reading 221, 231, 244, 249–250, 265, 276, 297, 463, 467–469, 475, 477, 484, 524–525, 632
- recent indefinite bygone time 623–625
- recursivity 159, 170, 489, 502–503
- referent 40
- referential definite noun phrase 574
- regular verb 23
- relative-absolute deictic Adv-time 592
- relative-absolute deictic time-specifying adverbial 592

- relative deictic Adv-time 592
 relative deictic time-specifying adverbial 591–592
 relative past tense 124, 155–156, 372–374, 380, 383–424, 448–449, 461–467, 491–492, 501–502, 505–506, 520, 523, 534, 579, 596, 655, 661, 677–678, 681, 689, 692–698, 722, 732–733, 735, 748
 relative tense 25–27, 120–121, 153–154, 156–158, 199, 372, 232, 372–374, 377, 380, 383–424, 428, 432, 446–499, 467–468, 485–486, 490–491, 501–502, 534, 575, 485–486, 652, 654, 656, 689–692, 695, 697–699, 707–725, 737, 744, 747 (*see also* absolute-relative tense, complex relative tense, conditional tense, conditional perfect tense, past perfect tense, pseudo-absolute-relative tense form, relative past tense)
 repetitive 28, 35–37, 46, 53–54, 58, 79–80, 238, 259, 271, 273, 462, 466–476, 483, 487, 595, 597–598, 613, 676–678, 681–682
 replay comment 179
 represented speech 388, 390–392, 394, 395–397, 401, 413, 436, 451, 469, 471, 521, 542, 555, 698, 719
 restrictive *when*-clause 672
 result *see* direct result, indirect result
 resultative reading 248, 305–306, 510, 713, 724 (*see also* direct result, indirect result)
 rhetorical question 181
 root modality 39
- S**
- scope 187–188, 244, 294, 616, 695
 semantics of a tense 26–27, 119–121, 155, 176, 195, 202, 212–219, 222–224, 228, 233, 295, 304, 369–370, 386, 396, 409, 420, 423, 449, 541
 semelfactive aspect 28, 36, 277, 597
 sentence 13–14
 shift of domain 381–382, 393, 396, 574, 427, 432, 446, 464–465, 467–468, 470, 475–485, 490, 495, 516, 518, 524–525, 695, 706, 720
 shift of temporal domain *see* shift of domain
 shift of temporal focus 105, 466, 574, 577, 581–583, 585
 shift of temporal perspective 129–130, 176, 180–181, 199, 337, 382, 424–425, 461, 484, 489, 491, 501–502, 524–526, 533, 535, 551
 shift the domain *see* shift of domain
 simple situation-template 40–43, 47, 58
 simultaneity 25, 123–125, 496 (*see also* Adv-time-simultaneity, pseudo-sloppy simultaneity, sloppy simultaneity, T-simultaneity, W-simultaneity)
since-adverbial 189, 191, 266, 600, 605–611 (*see also* *since*-clause)
since-clause 289, 447–448, 523, 600, 608–611
since-left 263, 447
 single-zone adverbial 593
 situation kind *see* situation type
 situation-template 40–44, 47–48, 51, 55–56, 58, 60–61, 63–64, 66, 77–78
 situation time 95, 116–117, 365
 situation-time adverbial 136–137, 638–641, 644, 649, 658, 662–667, 687–690, 698–699, 707, 716–723, 727, 745–750, 754
 situation time of the *after*-clause 742–751
 situation time of the *before*-clause 687–692, 694, 696, 706–709, 713, 715, 718, 722, 725–728, 731, 733–734
 situation time of the *until*-clause 407, 739–741
 situation time of the *when*-clause 122, 143, 393, 638, 641, 643–661, 664–667, 670–672, 675, 677–678, 681

- situation time of the *while*-clause 294
 situation type 12, 28–29, 41–45, 47–51, 55–57, 59–61, 63–71, 77–78, 201, 229, 279
 situation-unbounding adverbial constituent 600 (*see also* unbounding constituent)
 sloppy simultaneity 496–497, 560–561, 647–648 (*see also* pseudo-sloppy simultaneity)
 Special Present Time-sphere System 176–188, 619, 675, 704–706, 729
 specificational {clause / meaning / sentence} 259–267, 312, 447, 544
 state 45, 51–53, 66, 68
 state verb 51
 static situation *see* state
 static situation verb *see* state verb
 stem 23
 strict coincidence 123–124, 369
 strong intensional verb 554, 569
 strong verb 23–24
 subclause 14
 subdomain 158–159, 383, 502–503
 subject complement 21
 subjunctive *see* present subjunctive, past subjunctive
 subordinate clause *see* subclause
 subordinating conjunction 14
 subsituation 34–36, 258–259
- T**
- t_0 *see* temporal zero-point
 t_0 -factual *see* factual at t_0
 t_0 -nonfactual *see* not-yet-factual at t_0
 T-anteriority 123–125, 369
 T-binding *see* temporal binding
 T-bygone 196
 T-concept 368 (*see also* T-interpretation, T-relation)
 telic 60–65, 68, 70–72, 75–82, 238, 254, 272–273, 278–279
 telicizing constituent 63–64
 telos 63
- temporal adverbial 132–134 (*see also* bifunctional adverbial, pure duration adverbial, temporal clause, time-specifying adverbial)
 temporal anchor *see* Anchor time
 temporal binding 157–158, 374–375, 380, 516–522, 660–666
 temporal clause *see after*-clause, *before*-clause, *since*-clause, *until*-clause, *when*-clause, *while*-clause
 temporal domain 119–121, 123–125, 153–159, 372–373, 376–382
 temporal focus 511, 546, 571–573–587 (*see also* actualization focus)
 temporal interpretation *see* temporal W-interpretation, T-interpretation
 temporal subdomain *see* subdomain
 temporal subordination *see* temporal binding
 temporal W-interpretation 122, 126–127, 216–224, 252, 369
 temporal zero-point 97–98, 110–112, 117, 138, 148, 173
 temporary habit 35, 37, 271–273
 tense 22, 96
 tense auxiliary 24–25
 tense form 96
 tense relation 122, 369 (*see also* T-anteriority, T-posteriority, T-simultaneity)
 tense structure 96, 120, 214, 386
 tensed verb form 15
 tenseless *see* untensed
 tentative 128–129, 568, 673–674
 terminative 28, 32, 140–141, 168, 401, 744
 time adverbial *see* temporal adverbial
 time clause *see* temporal clause
 time line 149, 154, 377
 time of evaluation *see* evaluation time
 time of orientation *see* orientation time
 time of the full situation 116, 365 (*see also* full situation)
 time of the predicated situation *see* situation time
 time of the situation *see* situation time

time-specifying adverbial 132–138,
591–595, 603–605, 612, 619, 637,
650–651, 687, 750
time-sphere 147–152
time-zone 148–151, 370–372
T-interpretation 214–218, 369
T-posteriority 125, 369, 387–388,
450–458, 462–464, 499
transition reading 58–59, 68, 70–71
transitional event verb 45
transitional situation verb 46, 59
transitive verb 21
transparent interpretation 407, 469,
541, 554–555, 567, 695, 712, 717
T-relation 122, 369 (*see also* T-anteri-
ority, T-posteriority, T-simultaneity)
T-simultaneity 122–125, 377–378,
380, 383, 409, 414–416, 448–449,
486, 494–498
type of situation *see* situation type

U

unanchored time-specifying adver-
bial 398–401 (*see also* nondeictic
time-specifying adverbial)
unbounding constituent 80, 600
unembedded clause *see* independent
clause
unexpanded domain 155, 158, 373
unidirectional relation 378, 414–416
universal sentence 130–131
unmarked interpretation 259, 287, 342,
423, 514, 520, 576, 614–615, 647,
649–650, 660–661, 667, 714
unmarked orientation time 117
unmarked temporal focus 576–581,
583–585
unmarked temporal interpretation *see*
Principle of Unmarked Temporal In-
terpretation
unmarked tense 176, 179–180, 450,
502, 552, 561, 600, 668
unmarked up-to-now interpretation
see unmarked up-to-now reading

unmarked up-to-now reading 229, 232,
236–237, 240, 252–255, 277–281,
292–293, 478, 613, 618, 621
unreality *see* irrealis
unspecified orientation time 118, 368
untensed 15–17, 98–99
until-adverbial 80, 616–618, 740–741
(*see also until*-clause)
until-clause 406–407, 738–741
up-to-now interpretation *see* up-to-
now reading
up-to-now perfect 226, 460
up-to-now reading (of clause in the pres-
ent perfect) 216, 219, 222–223,
228–233, 251–270, 277–286, 289–
294, 445, 474–478, 613
utterance-explaining *because*-
clause 552–553

V

value (of specificational sentence)
259–266 (*see also* specificational)
value constituent *see* value
vantage time 29, 33, 285, 344
variable (of specificational sentence)
259–263
variable constituent *see* variable
verb complement *see* complement
verb form 15–17, 19
verb of creation 298–300
verb of state *see* state verb
verb phrase 12–13, 15, 20, 41–45,
47–52, 57–68, 77–78, 81

W

W-anteriority 122, 126, 369–370, 479
W-bounded 73, 198, 224–226
W-bygone 196
W-concept 368 (*see also* W-interpreta-
tion, W-relation)
weak intensional verb 555
weak verb 23
wh-question 181, 254, 260–261, 322,
331–332

- when*-clause 78, 122, 137, 143, 221,
 275, 393, 635–681
while-clause 293–294, 477–478
 W-interpretation *see* temporal W-inter-
 pretation
 W-nonbounded 235, 238
 world relation *see* W-relation
 W-posteriority 126, 385–389, 482,
 517–518, 669, 720, 751–752
 W-reading *see* temporal W-interpreta-
 tion
 W-relation 122, 126, 369–370, 378
 (*see also* W-anteriority, W-posterior-
 ity, W-simultaneity)
 W-simultaneity 122, 126–127, 370,
 377–379, 392–393, 395–397, 409,
 427, 429–432, 462, 464–468, 471–
 472, 480–481, 517–522, 579, 648–
 649, 663–665
 W-simultaneous domains 378, 429,
 466, 471

Z

- zero-conjunction 14
 zero-point *see* temporal zero-point
 zero-time *see* temporal zero-point
 zone *see* time-zone
 zone-independent adverbial 593–594,
 596
 zone-independent time-specifying adver-
 bial *see* zone-independent adver-
 bial

DEMO