

OXFORD REFERENCE 

THE OXFORD-DUDEN

Pictorial
English
Dictionary

DEMO



Over 28,000 illustrations

OXFORD REFERENCE
THE
OXFORD-DUDEN
PICTORIAL ENGLISH
DICTIONARY

DEMO

Foreword

THE OXFORD-DUDEN PICTORIAL ENGLISH DICTIONARY

There are certain kinds of words which are more readily illustrated by pictures than by text. The pictorial English Dictionary is a reference work which is designed to help the reader to understand the meaning of such words. It is a dictionary of pictorial English, and it is the only one of its kind. It is a dictionary of pictorial English, and it is the only one of its kind. It is a dictionary of pictorial English, and it is the only one of its kind.

The word 'DUDEN' is a registered trademark of the Bibliographisches Institut for books of any kind. Edited by John Perry, Oxford, with the assistance of Roland Breigebauer, Michael Clark, John Cunningham, David Jordan, and Werner Schuler-Zander. Illustrations by Robert Schindler, Mannheim. The Oxford-Duden Pictorial English Dictionary. ISBN 0-19-504122-9 (hard cover). Oxford University Press.

OXFORD UNIVERSITY PRESS

Oxford University Press, Walton Street, Oxford OX2 6DP

Oxford New York Toronto
Delhi Bombay Calcutta Madras Karachi
Petaling Jaya Singapore Hong Kong Tokyo
Nairobi Dar es Salaam Cape Town
Melbourne Auckland
and associated companies in
Berlin Ibadan

Oxford is a trade mark of Oxford University Press

© Illustrations: Bibliographisches Institut, Mannheim 1979

© Text: Oxford University Press 1981

First published 1981

First issued as a paperback 1984

Reprinted 1984 (twice), 1985 (twice), 1987, 1988, 1990 (twice), 1991

All rights reserved. No part of this publication may be reproduced, stored in a retrieval system, or transmitted, in any form or by any means, electronic, mechanical, photocopying, recording, or otherwise, without the prior permission of Oxford University Press

This book is sold subject to the condition that it shall not, by way of trade or otherwise, be lent, re-sold, hired out or otherwise circulated without the publisher's prior consent in any form of binding or cover other than that in which it is published and without a similar condition including this condition being imposed on the subsequent purchaser

The word 'DUDEN' is a registered trademark of the Bibliographisches Institut for books of any kind

Edited by John Pheby, Oxford, with the assistance of Roland Breitsprecher, Michael Clark, Judith Cunningham, Derek Jordan, and Werner Scholze-Stubenrecht
Illustrations by Jochen Schmidt, Mannheim

British Library Cataloguing in Publication Data

The Oxford-Duden pictorial English dictionary.

1. English language—Dictionaries

I. Pheby, J. A.

423 PE1625

ISBN 0-19-864155-9 (pbk)

Printed in Hong Kong

Foreword

This pictorial dictionary is based on the Oxford-Duden Pictorial German-English Dictionary published in 1980. It was produced by the German Section of the Oxford University Press Dictionary Department in cooperation with the Dudenredaktion of the Bibliographisches Institut, Mannheim, and with the assistance of various British companies, institutions, and specialists. Numerous modifications of the text and illustrations of the original work have been carried out, especially regarding the depiction of everyday objects and situations, in order to allow greater scope for the treatment of these objects and situations in the context of English-speaking countries.

There are certain kinds of information which can be conveyed more readily and clearly by pictures than by definitions and explanations alone: an illustration will help the reader to visualize the object denoted by the word and to form an impression of the way in which objects function in their own technical field or in the everyday life of English-speaking countries. The layout of the illustrations and the text will be particularly useful to the learner. Each double page of the dictionary contains a list of the vocabulary of a subject together with a picture illustrating this vocabulary. This arrangement, and the presence of an alphabetical index, allows the book to be used in two ways: either as a key to the vocabulary of a subject or as an alphabetical dictionary in which the reader is referred to the section or sections in which the word is illustrated.

Oxford, 1981

J.P.

Abbreviations

Am.	American usage
c.	castrated (animal)
coll.	colloquial
f.	female (animal)
form.	formerly
joc.	jocular
m.	male (animal)
poet.	poetic
sg.	singular
sim.	similar
y.	young (animal)

Contents

The arabic numerals are the numbers of the pictures.

Atom, Universe, Earth

Atom I 1
Atom II 2
Astronomy I 3
Astronomy II 4
Astronomy III 5
Moon Landing 6
The Atmosphere 7
Meteorology I 8
Meteorology II and Climatology 9
Meteorological Instruments 10
Physical Geography I 11
Physical Geography II 12
Physical Geography III 13
Map I 14
Map II 15

Man and his Social Environment

Man I 16
Man II 17
Man III 18
Man IV 19
Man V 20
First Aid 21
Doctor I 22
Doctor II 23
Dentist 24
Hospital I 25
Hospital II 26
Hospital III 27
Infant Care and Layette 28
Children's Clothes 29
Ladies' Wear I (Winter Wear) 30
Ladies' Wear II (Summer Wear) 31
Underwear, Nightwear 32
Men's Wear 33
Hairstyles and Beards 34
Headgear 35
Jewellery (Am. Jewelry) 36
Types of Dwelling 37
Roof and Boiler Room 38
Kitchen 39
Kitchen Utensils and Appliances 40
Hall 41
Living Room (Lounge) 42
Bedroom 43
Dining Room 44
Tableware and Cutlery 45
Flat (Apartment) 46
Children's Room (Nursery) 47
Kindergarten (Day Nursery) 48
Bathroom and Toilet 49
Household Appliances and Utensils 50

Nature as Environment, Agriculture, and Forestry

Flower Garden 51
Fruit and Vegetable Garden 52
Indoor Plants (Houseplants) 53
Propagation of Plants 54
Market Garden (Am. Truck Garden, Truck Farm) 55
Garden Tools 56
Vegetables (Vegetable Plants) 57
Soft Fruit and Pomes 58
Drupes and Nuts 59
Garden Flowers 60
Weeds 61
Farm Buildings (Am. Farmstead) 62
Agriculture (Farming) 63
Agricultural Machinery I 64
Agricultural Machinery II 65
Agricultural Implements 66
Overhead Irrigation 67
Arable Crops 68
Fodder Plants (Forage Plants) 69
Breeds of Dog 70
Horse I 71
Horse II 72
Domestic Animals 73
Poultry Farming, Egg Production 74
Rearing (Am. Raising) of Livestock 75
Dairy 76
Bees and Beekeeping (Apiculture) 77
Wine Growing (Viculture, Viticulture) 78
Wine Cellar 79
Garden and Field Pests 80
House Insects, Food Pests, and Parasites 81
Forest Pests 82
Pest Control 83
Forestry I 84
Forestry II 85
Hunting 86
Hunting Weapons, Hunting Equipment 87
Game 88
Fish Farming (Fish Culture, Pisciculture) and Angling 89
Sea Fishing 90

Trades, Crafts, and Industry

Mills 91
Malting and Brewing I 92
Brewing II 93
Slaughterhouse (Abattoir) 94

Meat Joints 95
Butcher's Shop 96
Bakery 97
Grocer's Shop (Am. Grocery Store) 98
Supermarket 99
Shoemaker (Bootmaker) 100
Shoes (Footwear) 101
Needlework 102
Dressmaker 103
Tailor 104
Ladies' Hairdresser 105
Men's Hairdresser (Barber) 106
Tobacco and Smoking Requisites 107
Goldsmith, Silversmith 108
Watchmaker, Clockmaker 109
Clocks and Watches 110
Optician 111
Optical Instruments I 112
Optical Instruments II 113
Photography I 114
Photography II 115
Photography III 116
Cine Film 117
Building Site (Construction Site) I 118
Building Site (Construction Site) II 119
Carpenter 120
Roof, Timber Joints 121
Roof and Roofer 122
Floor, Ceiling, Staircase Construction 123
Grazier 124
Plumber 125
Plumber, Gas Fitter, Heating-Engineer 126
Electrician 127
Paperhanger 128
Painter 129
Cooper and Tank Construction Engineer 130
Furrier 131
Joiner I 132
Joiner II 133
Do-it-yourself 134
Turner (Ivory Carver) 135
Basket Maker 136
Blacksmith (Smith) I 137
Blacksmith (Smith) II (Farm Vehicle Engineering) 138
Hammer Forging (Smith Forging) and Drop Forging 139
Metalworker 140
Gas Welder 141
Arc Welder 142
Sections, Bolts, and Machine Parts 143
Coal Mine 144
Mineral Oil (Oil, Petroleum) 145
Offshore Drilling 146
Iron and Steel Works 147
Iron Foundry and Rolling Mill 148
Machine Tools I 149
Machine Tools II 150

Drawing Office 151
Power Plant (Power Station) I 152
Power Plant (Power Station) II 153
Nuclear Energy 154
Modern Sources of Energy 155
Coking Plant 156
Sawmill 157
Quarry 158
Brickworks (Brickyard, Brickfield) 159
Cement Works (Cement Factory) 160
Porcelain and China Manufacture 161
Glass Production 162
Cotton Spinning I 163
Cotton Spinning II 164
Weaving I 165
Weaving II 166
Knitting 167
Finishing of Textile Fabrics 168
Synthetic (Man-made) Fibres (Am. Fibers) I 169
Synthetic (Man-made) Fibres (Am. Fibers) II 170
Weaves and Knits 171
Papermaking I 172
Papermaking II 173

Printing Industry

Composing Room (Case Room) I 174
Composing Room (Case Room) II 175
Composing Room (Case Room) III (Phototypesetting, Photocomposition, Photosetting, Filmsetting) 176
Photomechanical Reproduction 177
Electrotyping and Block Making 178
Offset Platemaking 179
Offset Printing 180
Letterpress Printing 181
Photogravure (Gravure Printing, Intaglio Printing) 182
Bookbinding I 183
Bookbinding II 184
Bookbinding III 185

Transport, Communications, and Information Technology

Horse-drawn Carriages 186
Bicycle 187
Motorcycles, Bicycles, Scooters, Mopeds 188
Motorcycle 189
Internal Combustion Engines 190
Motor Car (Am. Automobile) I 191
Motor Car (Am. Automobile) II 192
Motor Car (Am. Automobile) III 193
Lorries (Am. Trucks), Vans, Buses 194
Garage (Am. Shop) 195
Service Station 196
Tram (Am. Streetcar, Trolley), Interurban Electric Train 197

Cross-section of a Street 198
Refuse Disposal (*Am. Garbage Disposition*), Street Cleaning 199
Road Construction I (Road Building, Road Making) 200
Road Construction II (Road Building, Road Making) 201
Railway Line (*Am. Railroad Track*) I 202
Railway Line (*Am. Railroad Track*) II (Signalling Equipment) 203
Station Hall 204
Station Platform 205
Goods Station (Freight Depot) 206
Railway Vehicles (Rolling Stock) I 207
Railway Vehicles (Rolling Stock) II 208
Railway Vehicles (Rolling Stock) III 209
Railway Vehicles (Rolling Stock) IV 210
Railway Vehicles (Rolling Stock) V 211
Railway Vehicles (Rolling Stock) VI 212
Railway Vehicles (Rolling Stock) VII 213
Mountain Railways (*Am. Mountain Railroads*) and Cableways 214
Bridges 215
Rivers and River Engineering 216
Waterway and Hydraulic Engineering 217
Types of Historical Ship 218
Sailing Ship I 219
Sailing Ship II 220
Types of Ship 221
Shipbuilding 222
Motor Ship 223
Navigation 224
Docks, Port, Harbour (*Am. Harbor*) I 225
Docks, Port, Harbour (*Am. Harbor*) II 226
Salvage (Salving) and Towage 227
Life Saving 228
Aircraft I 229
Aircraft II 230
Aircraft III 231
Aircraft IV 232
Airport 233
Space Flight I 234
Space Flight II 235
Post Office I 236
Post Office II (Telephones and Telegraphy) 237
Broadcasting (Radio and Television) I 238
Broadcasting (Radio and Television) II 239
Broadcasting III (Television Engineering) 240
Music Systems (Audio Systems) 241
Teaching Equipment and Information Technology 242
Audiovision (AV) 243
Computer Centre (*Am. Center*) 244

Office, Bank, Stock Exchange

Office I 245
Office II 246
Office III 247
Office IV 248
Office V 249
Bank 250
Stock Exchange 251

Community

Money (Coins and Notes, *Am. Coins and Bills*) 252
Flags 253
Heraldry, Crowns and Coronets 254
Armed Forces I (Army) 255
Armed Forces II (Air Force I) 256
Armed Forces III (Air Force II) 257
Warships I 258
Warships II (Modern Fighting Ships) 259
School I (Primary School) 260
School II (Secondary School, High School) 261
University 262
Election 263
Police 264
Café 265
Restaurant 266
Hotel 267
Town (Town Centre, *Am. Downtown*) 268
Water Supply 269
Fire Service (*Am. Fire Department*) 270
Department Store 271
Park 272

Recreation, Games, Sport

Children's Playground 273
Spa 274
Roulette 275
Board Games and Party Games 276
Billiards 277
Camping and Caravanning (*Am. Trailering*) 278
Surf Riding (Surfing), Skin Diving 279
Bathing Beach 280
Swimming Bath (Leisure Centre, *Am. Center*) 281
Swimming 282
Rowing and Canoeing 283
Sailing (Yachting) I 284
Sailing (Yachting) II 285
Motorboats (Powerboats), Water Skiing 286
Gliding (Soaring) 287
Aerial Sports (Airsports) 288
Horsemanship, Equestrian Sport 289
Cycle Racing and Motorsports 290
Ball Games I (Football, Association Football, Soccer) 291

Ball Games II 292
Ball Games III 293
Fencing 294
Free Exercise 295
Apparatus Gymnastics I 296
Apparatus Gymnastics II (Women's Gymnastics) 297
Athletics (Track and Field Events) 298
Weightlifting and Combat Sports 299
Mountaineering 300
Winter Sports I (Skiing) 301
Winter Sports II 302
Winter Sports III 303
Countryside in Winter 304
Various Sports 305

Entertainment, Culture, and Art

Carnival 306
Circus 307
Fair, Fairground 308
Flea Market 309
Films (Motion Pictures) I 310
Films (Motion Pictures) II 311
Films (Motion Pictures) III 312
Films (Motion Pictures) IV 313
Ballet 314
Theatre (*Am. Theater*) I 315
Theatre (*Am. Theater*) II 316
Discotheque 317
Nightclub 318
Bullfighting, Rodeo 319
Musical Notation I 320
Musical Notation II 321
Musical Instruments I 322
Musical Instruments II 323
Musical Instruments III 324
Musical Instruments IV 325
Musical Instruments V 326
Fabulous Creatures (Fabled Beings) 327
Prehistory 328
Chivalry 329
Church I 330
Church II 331
Church III 332
Art I 333
Art II 334
Art III 335
Art IV 336
Art V 337
Artist's Studio 338
Sculptor's Studio 339
Graphic Art 340
Script I 341

Script II 342
Colour (*Am. Color*) 343
Mathematics I 344
Mathematics II 345
Mathematics III (Geometry I) 346
Mathematics IV (Geometry II) 347
Mathematics V (Sets) 348
Chemistry Laboratory I 349
Chemistry Laboratory II 350
Crystals, Crystallography 351
Ethnology I 352
Ethnology II 353
Ethnology III 354
Historical Costumes 355

Animals and Plants

Zoo (Zoological Gardens) 356
Invertebrates 357
Articulates 358
Birds I 359
Birds II (Indigenous Birds, Endemic Birds) 360
Birds III (Passerines) 361
Birds IV (Birds of Prey) 362
Birds V (Exotic Birds) 363
Fish, Amphibia, and Reptiles 364
Lepidoptera (Butterflies and Moths) 365
Mammals I 366
Mammals II 367
Mammals III 368
Deep-sea Fauna 369
General Botany 370
Deciduous Trees 371
Conifers 372
Ornamental Shrubs and Trees I 373
Ornamental Shrubs and Trees II 374
Meadow Flowers and Wayside Flowers (Wild Flowers) I 375
Meadow Flowers and Wayside Flowers (Wild Flowers) II 376
Plants of Forest, Marsh, and Heathland 377
Alpine Plants, Aquatic Plants (Water Plants), and Marsh Plants 378
Poisonous Plants 379
Medicinal Plants 380
Edible Fungi (Esculent Fungi) 381
Tropical Plants used as Stimulants, Spices, and Flavourings (*Am. Flavorings*) 382
Plants used in Industry 383
Southern Fruits (Tropical, Subtropical, and Mediterranean Fruits) 384

- 1-8 atom models
- 1 model of the hydrogen (H) atom
- 2 atomic nucleus, a proton
- 3 electron
- 4 electron spin
- 5 model of the helium (He) atom
- 6 electron shell
- 7 Pauli exclusion principle (exclusion principle, Pauli principle)
- 8 complete electron shell of the Na atom (sodium atom)
- 9-14 molecular structures (lattice structures)
- 9 crystal of sodium chloride (of common salt)
- 10 chlorine ion
- 11 sodium ion
- 12 crystal of cristobalite
- 13 oxygen atom
- 14 silicon atom
- 15 energy levels (possible quantum jumps) of the hydrogen atom
- 16 atomic nucleus (proton)
- 17 electron
- 18 ground state level
- 19 excited state
- 20-25 quantum jumps (quantum transitions)
- 20 Lyman series
- 21 Balmer series
- 22 Paschen series
- 23 Brackett series
- 24 Pfund series
- 25 free electron
- 26 Bohr-Sommerfeld model of the H atom
- 27 energy levels of the electron
- 28 spontaneous decay of radioactive material
- 29 atomic nucleus
- 30-31 alpha particle (α , alpha radiation, helium nucleus)
- 30 neutron
- 31 proton
- 32 beta particle (β , beta radiation, electron)
- 33 gamma radiation (γ , a hard X-radiation)
- 34 nuclear fission:
- 35 heavy atomic nucleus
- 36 neutron bombardment

- 37-38 fission fragments
- 39 released neutron
- 40 gamma radiation (γ)
- 41 chain reaction
- 42 incident neutron
- 43 nucleus prior to fission
- 44 fission fragment
- 45 released neutron
- 46 repeated fission
- 47 fission fragment
- 48 controlled chain reaction in a nuclear reactor
- 49 atomic nucleus of a fissionable element
- 50 neutron bombardment
- 51 fission fragment (new atomic nucleus)
- 52 released neutron
- 53 absorbed neutrons
- 54 moderator, a retarding layer of graphite
- 55 extraction of heat (production of energy)
- 56 X-radiation
- 57 concrete and lead shield
- 58 bubble chamber for showing the tracks of high-energy ionizing particles
- 59 light source
- 60 camera
- 61 expansion line
- 62 path of light rays
- 63 magnet
- 64 beam entry point
- 65 reflector
- 66 chamber

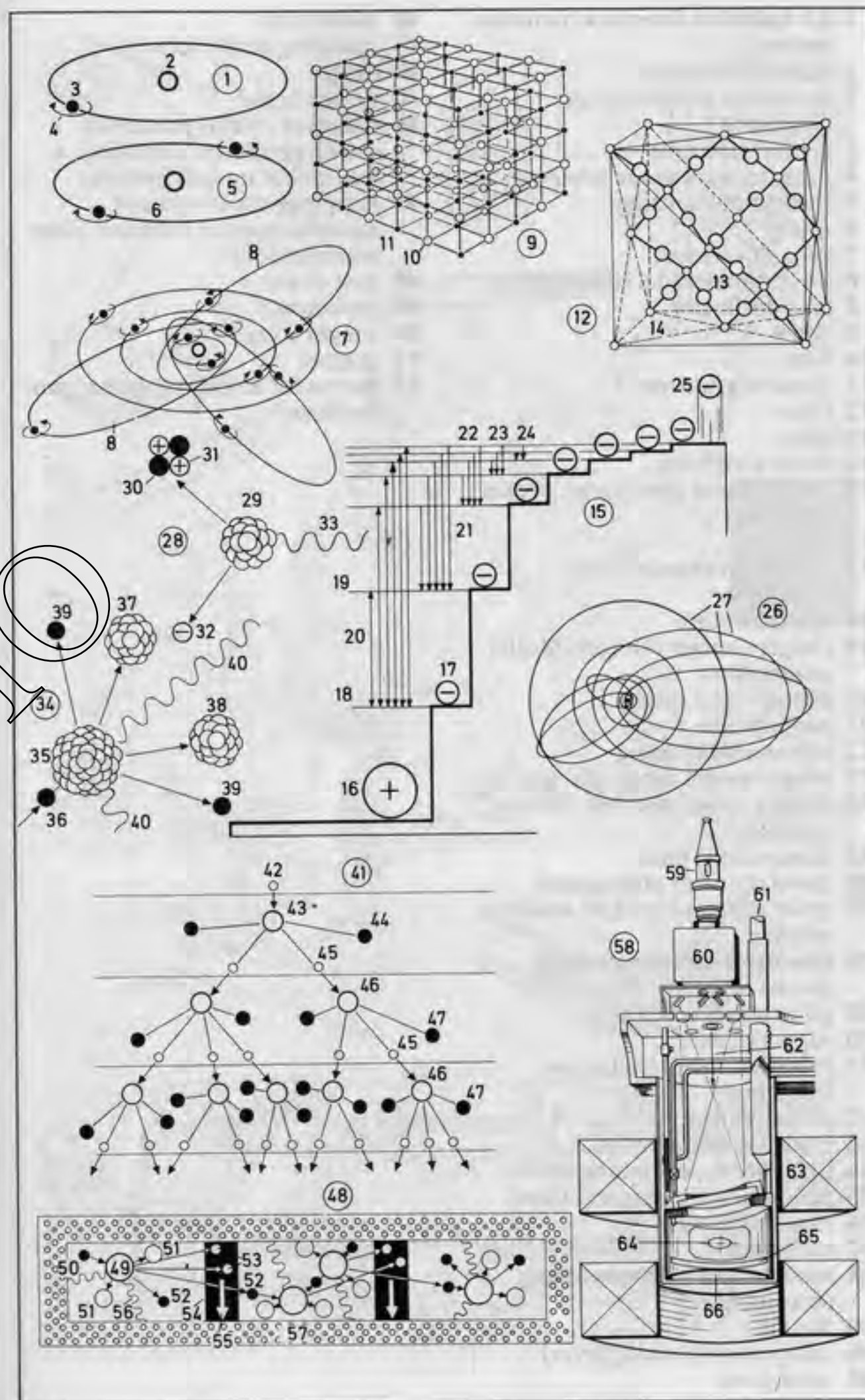

- 1-23 radiation detectors (radiation meters)
 1 radiation monitor
 2 ionization chamber (ion chamber)
 3 central electrode
 4 measurement range selector
 5 instrument housing
 6 meter
 7 zero adjustment
 8-23 dosimeter (dosemeter)
 8 film dosimeter
 9 filter
 10 film
 11 film-ring dosimeter
 12 filter
 13 film
 14 cover with filter
 15 pocket meter (pen meter, pocket chamber)
 16 window
 17 ionization chamber (ion chamber)
 18 clip (pen clip)
 19 Geiger counter (Geiger-Müller counter)
 20 counter tube casing
 21 counter tube
 22 instrument housing
 23 measurement range selector
 24 Wilson cloud chamber (Wilson chamber)
 25 compression plate
 26 cloud chamber photograph
 27 cloud chamber track of an alpha particle
 28 telecobalt unit (coll. cobalt bomb)
 29 pillar stand
 30 support cables
 31 radiation shield (radiation shielding)
 32 sliding shield
 33 bladed diaphragm
 34 light-beam positioning device
 35 pendulum device (pendulum)
 36 irradiation table
 37 rail (track)
 38 manipulator with sphere unit (manipulator)
 39 handle
 40 safety catch (locking lever)
 41 wrist joint

- 42 master arm
 43 clamping device (clamp)
 44 tongs
 45 slotted board
 46 radiation shield (protective shield, protective shielding), a lead shielding wall [section]
 47 grasping arm of a pair of manipulators (of a master/slave manipulator)
 48 dust shield
 49 cyclotron
 50 danger zone
 51 magnet
 52 pumps for emptying the vacuum chamber

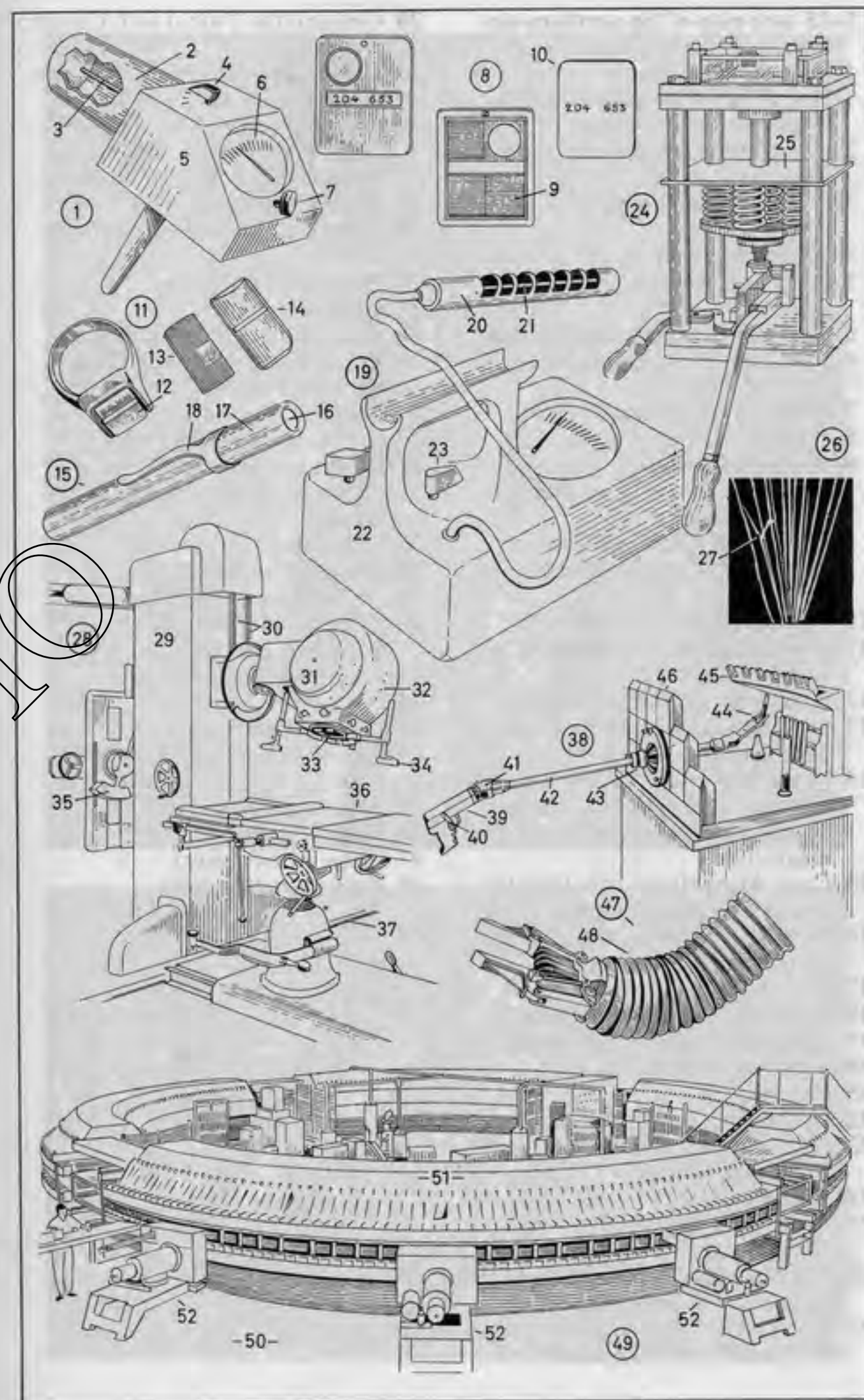

- 1-35 star map of the northern sky**
(northern hemisphere)
- 1-8 divisions of the sky**
- 1 celestial pole with the Pole Star (Polaris, the North Star)
 - 2 ecliptic (apparent annual path of the sun)
 - 3 celestial equator (equinoctial line)
 - 4 tropic of Cancer
 - 5 circle enclosing circumpolar stars
 - 6-7 equinoctial points (equinoxes)
 - 6 vernal equinoctial point (first point of Aries)
 - 7 autumnal equinoctial point
 - 8 summer solstice (solstice)
- 9-48 constellations** (grouping of fixed stars into figures) **and names of stars**
- 9 Aquila (the Eagle) with Altair the principal star (the brightest star)
 - 10 Pegasus (the Winged Horse)
 - 11 Cetus (the Whale) with Mira, a variable star
 - 12 Eridanus (the Celestial River)
 - 13 Orion (the Hunter) with Rigel, Betelgeuse and Bellatrix
 - 14 Canis Major (the Great Dog, the Greater Dog) with Sirius (the Dog Star), a star of the first magnitude
 - 15 Canis Minor (the Little Dog, the Lesser Dog) with Procyon
 - 16 Hydra (the Water Snake, the Sea Serpent)
 - 17 Leo (the Lion)
 - 18 Virgo (the Virgin) with Spica
 - 19 Libra (the Balance, the Scales)
 - 20 Serpens (the Serpent)
 - 21 Hercules
 - 22 Lyra (the Lyre) with Vega
 - 23 Cygnus (the Swan, the Northern Cross) with Deneb
 - 24 Andromeda
 - 25 Taurus (the Bull) with Aldebaran
 - 26 The Pleiades (Pleiads, the Seven Sisters), an open cluster of stars
 - 27 Auriga (the Wagoner, the Charioteer) with Capella
 - 28 Gemini (the Twins) with Castor and Pollux
 - 29 Ursa Major (the Great Bear, the Greater Bear, the Plough, Charles's Wain, *Am.* the Big Dipper) with the double star (binary star) Mizar and Alcor
 - 30 Boötes (the Herdsman)
 - 31 Corona Borealis (the Northern Crown)
 - 32 Draco (the Dragon)
 - 33 Cassiopeia
 - 34 Ursa Minor (the Little Bear, Lesser Bear, *Am.* Little Dipper) with the Pole Star (Polaris, the North Star)
- 35 the Milky Way (the Galaxy)**
- 36-48 the southern sky**
- 36 Capricorn (the Goat, the Sea Goat)
 - 37 Sagittarius (the Archer)
 - 38 Scorpio (the Scorpion)
 - 39 Centaurus (the Centaur)
 - 40 Triangulum Australe (the Southern Triangle)
 - 41 Pavo (the Peacock)
 - 42 Grus (the Crane)
 - 43 Octans (the Octant)
 - 44 Crux (the Southern Cross, the Cross)
 - 45 Argo (the Celestial Ship)
 - 46 Carina (the Keel)
 - 47 Pictor (the Painter)
 - 48 Reticulum (the Net)

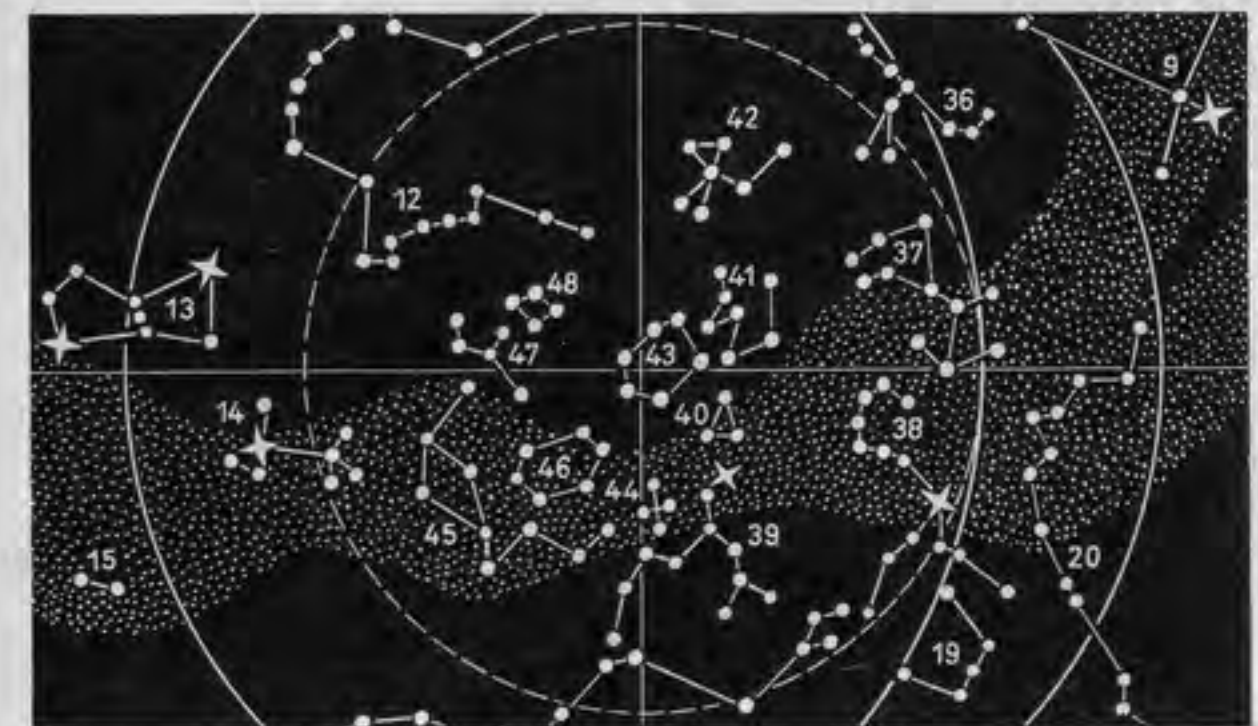
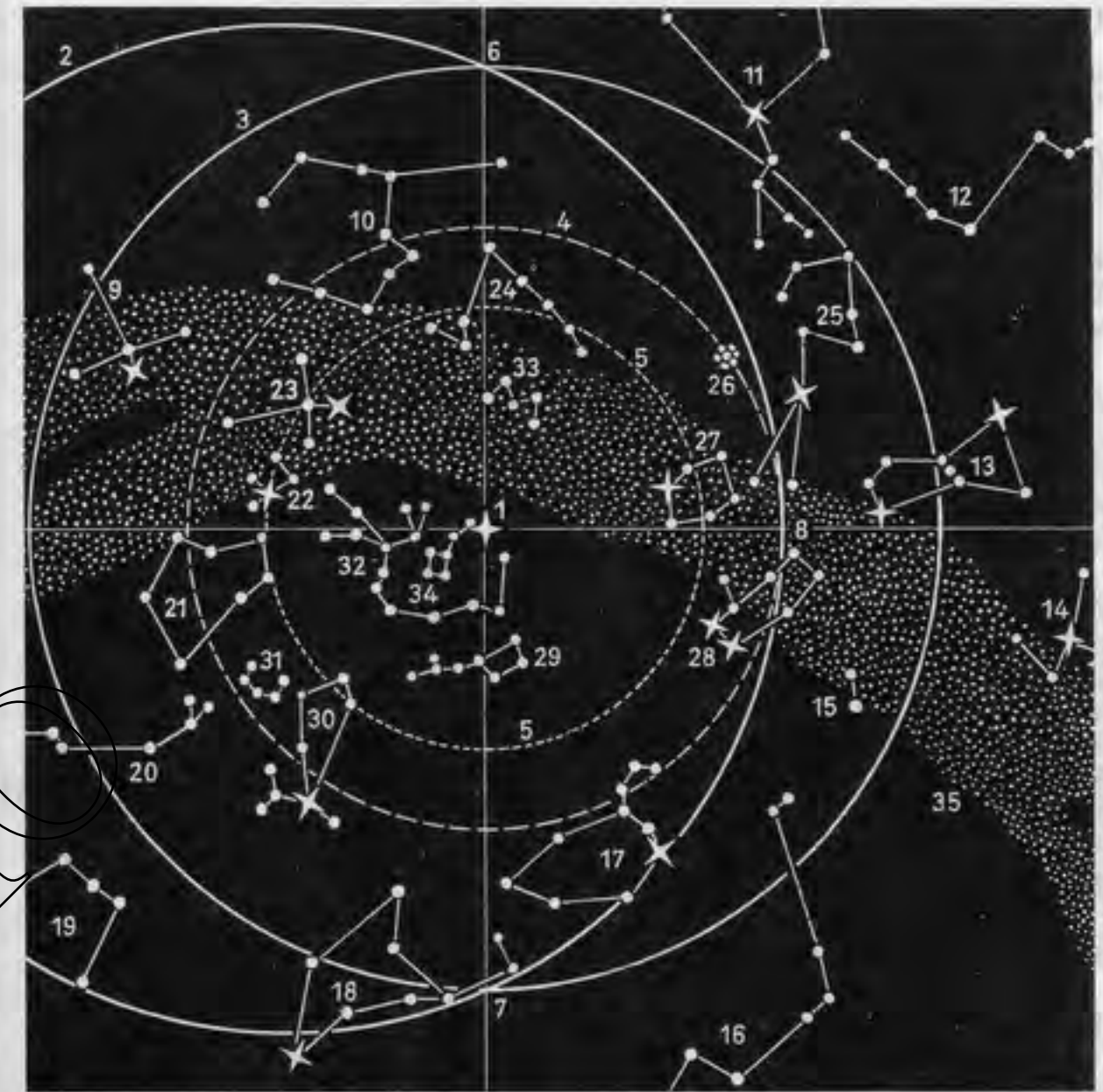

- 1-9 the moon
- 1 moon's path (moon's orbit round the earth)
- 2-7 lunar phases (moon's phases, lunation)
- 2 new moon
- 3 crescent (crescent moon, waxing moon)
- 4 half-moon (first quarter)
- 5 full moon
- 6 half-moon (last quarter, third quarter)
- 7 crescent (crescent moon, waning moon)
- 8 the earth (terrestrial globe)
- 9 direction of the sun's rays
- 10-21 apparent path of the sun at the beginning of the seasons
- 10 celestial axis
- 11 zenith
- 12 horizontal plane
- 13 nadir
- 14 east point
- 15 west point
- 16 north point
- 17 south point
- 18 apparent path of the sun on 21 December
- 19 apparent path of the sun on 21 March and 23 September
- 20 apparent path of the sun on 21 June
- 21 border of the twilight area
- 22-28 rotary motions of the earth's axis
- 22 axis of the ecliptic
- 23 celestial sphere
- 24 path of the celestial pole (precession and nutation)
- 25 instantaneous axis of rotation
- 26 celestial pole
- 27 mean axis of rotation
- 28 polhode
- 29-35 solar and lunar eclipse [not to scale]
- 29 the sun
- 30 the earth
- 31 the moon
- 32 solar eclipse
- 33 area of the earth in which the eclipse appears total
- 34-35 lunar eclipse
- 34 penumbra (partial shadow)
- 35 umbra (total shadow)
- 36-41 the sun
- 36 solar disc (disk) (solar globe, solar sphere)
- 37 sunspots
- 38 cyclones in the area of sunspots
- 39 corona (solar corona), observable during total solar eclipse or by means of special instruments
- 40 prominences (solar prominences)
- 41 moon's limb during a total solar eclipse
- 42-52 planets (planetary system, solar system) [not to scale] and planet symbols
- 42 the sun
- 43 Mercury
- 44 Venus
- 45 Earth, with the moon, a satellite
- 46 Mars, with two moons (satellites)
- 47 asteroids (minor planets)
- 48 Jupiter, with 14 moons (satellites)
- 49 Saturn, with 10 moons (satellites)
- 50 Uranus, with five moons (satellites)
- 51 Neptune, with two moons (satellites)
- 52 Pluto
- 53-64 signs of the zodiac (zodiacal signs)
- 53 Aries (the Ram)
- 54 Taurus (the Bull)
- 55 Gemini (the Twins)
- 56 Cancer (the Crab)
- 57 Leo (the Lion)
- 58 Virgo (the Virgin)
- 59 Libra (the Balance, the Scales)
- 60 Scorpio (the Scorpion)
- 61 Sagittarius (the Archer)
- 62 Capricorn (the Goat, the Sea Goat)
- 63 Aquarius (the Water Carrier, the Water Bearer)
- 64 Pisces (the Fish)

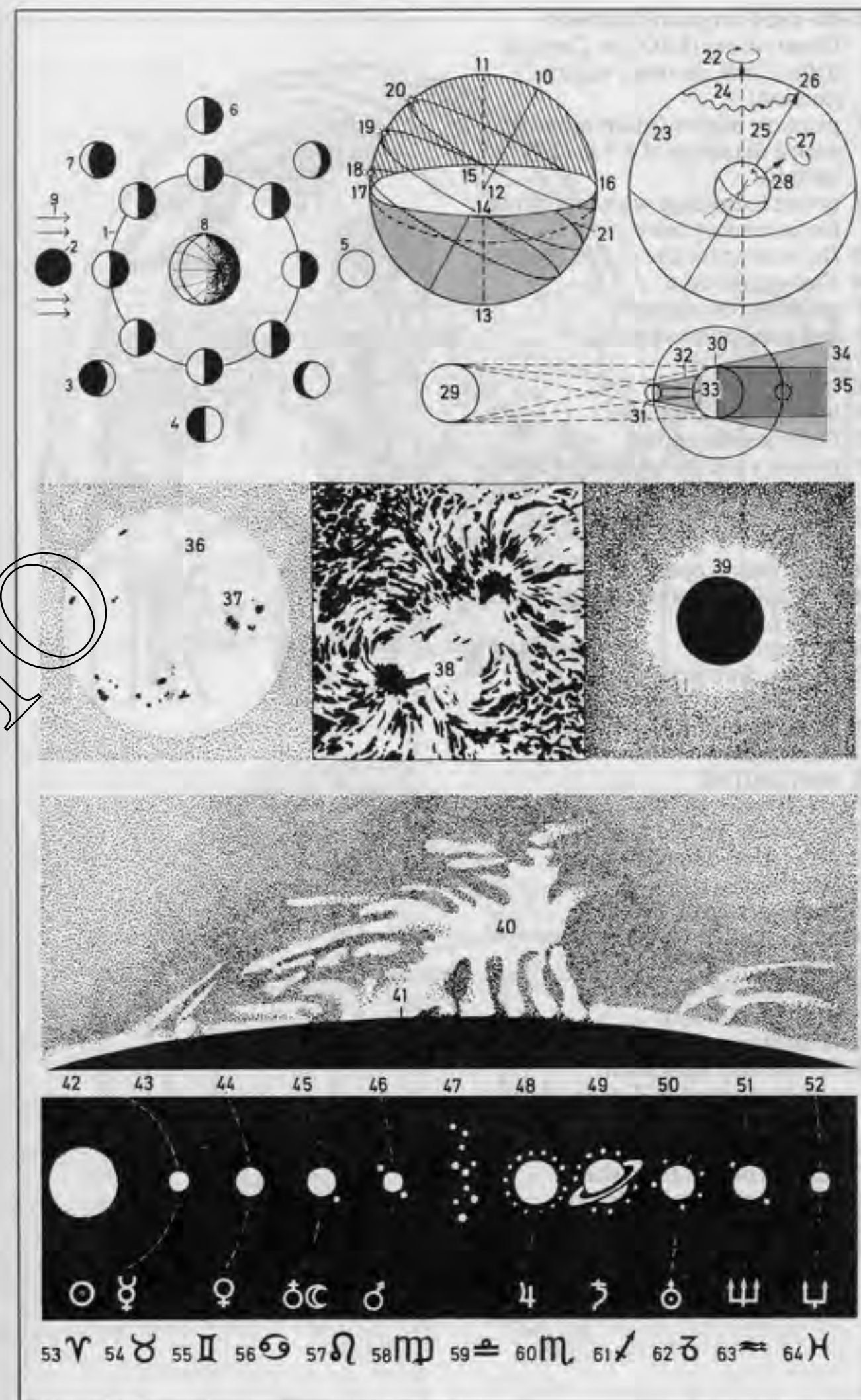

- 1-16 the European Southern Observatory (ESO) on *Cerro la Silla, Chile*, an observatory [section]
- 1 primary mirror (main mirror) with a diameter of 3.6 m (144 inches)
 - 2 prime focus cage with mounting for secondary mirrors
 - 3 flat mirror for the coudé ray path
 - 4 Cassegrain cage
 - 5 grating spectrograph
 - 6 spectrographic camera
 - 7 hour axis drive
 - 8 hour axis
 - 9 horseshoe mounting
 - 10 hydrostatic bearing
 - 11 primary and secondary focusing devices
 - 12 observatory dome (revolving dome)
 - 13 observation opening
 - 14 vertically movable dome shutter
 - 15 wind screen
 - 16 siderostat
- 17-28 the *Stuttgart Planetarium* [section]
- 17 administration, workshop, and store area
 - 18 steel scaffold
 - 19 glass pyramid
 - 20 revolving arched ladder
 - 21 projection dome
 - 22 light stop
 - 23 planetarium projector
 - 24 well
 - 25 foyer
 - 26 theatre (*Am. theater*)
 - 27 projection booth
 - 28 foundation pile
- 29-33 the *Kitt Peak solar observatory near Tucson, Ariz.* [section]
- 29 heliostat
 - 30 sunken observation shaft
 - 31 water-cooled windshield
 - 32 concave mirror
 - 33 observation room housing the spectrograph

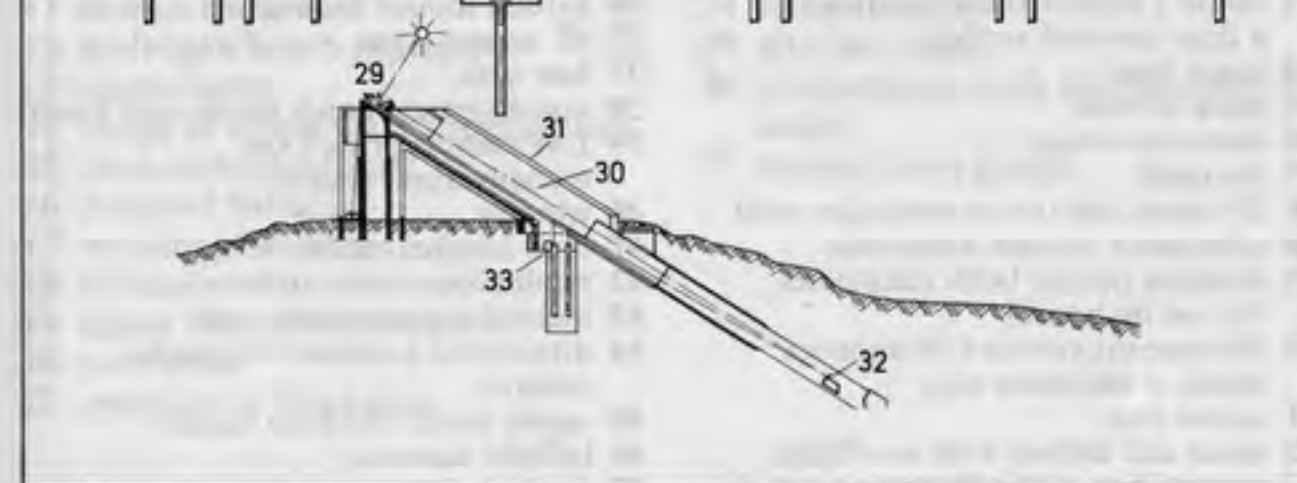
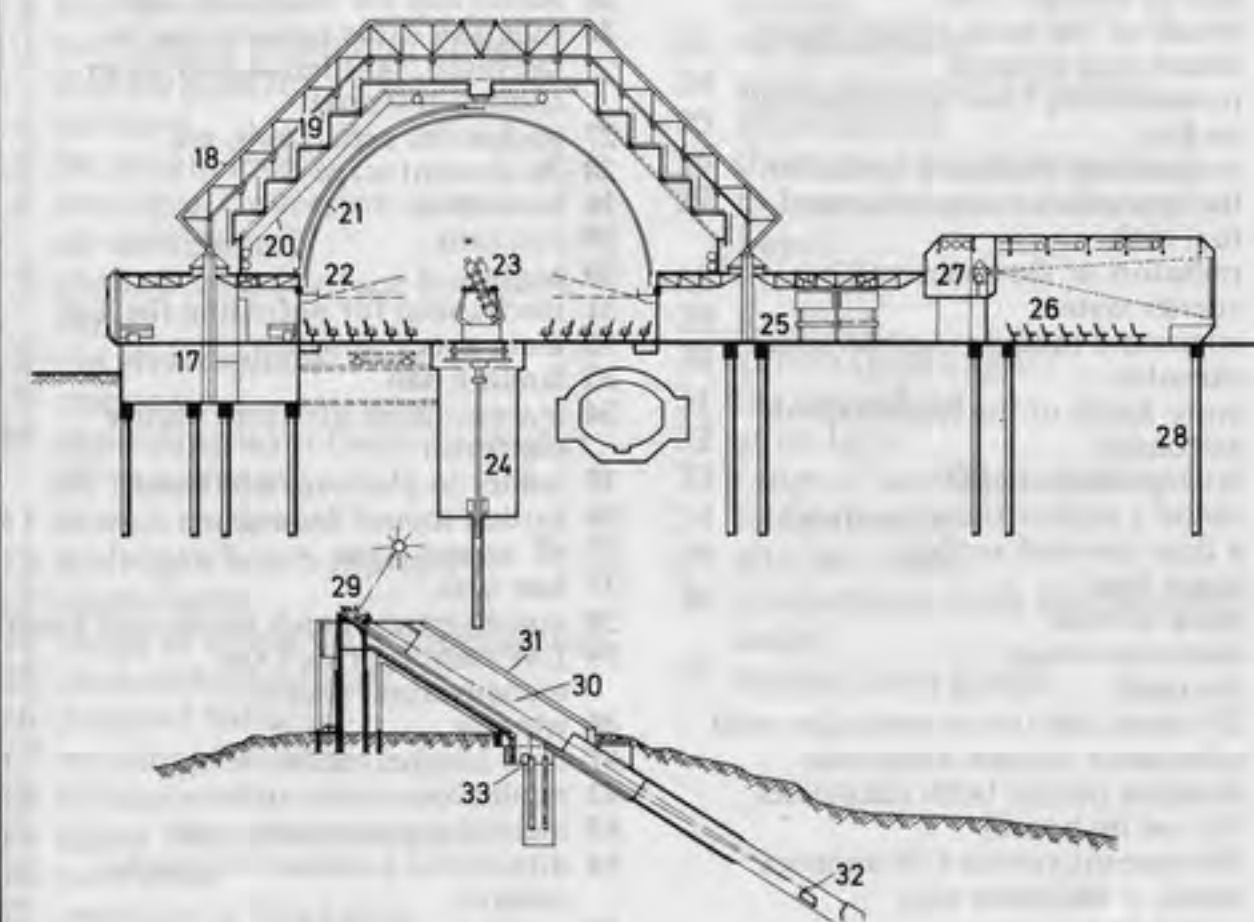
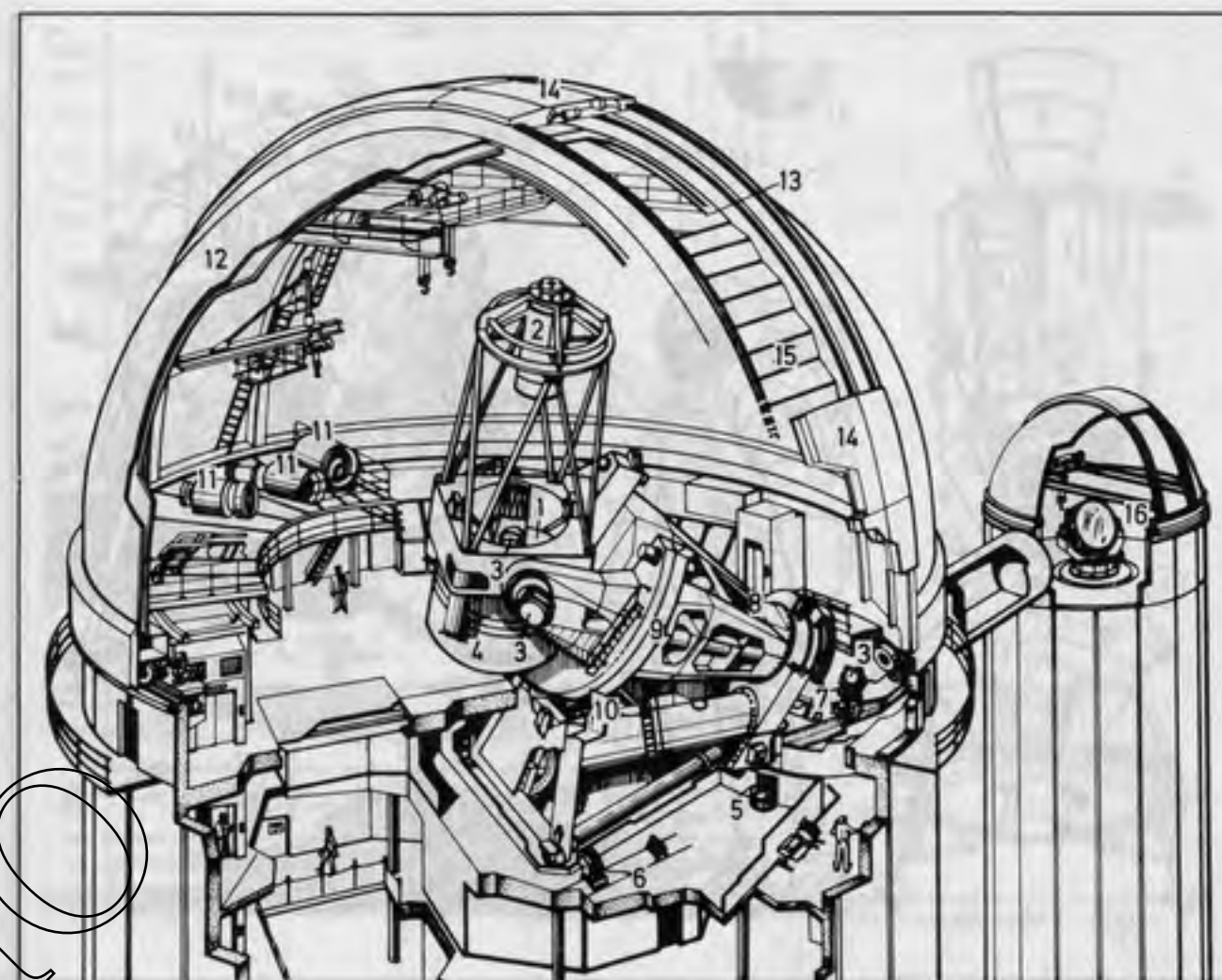

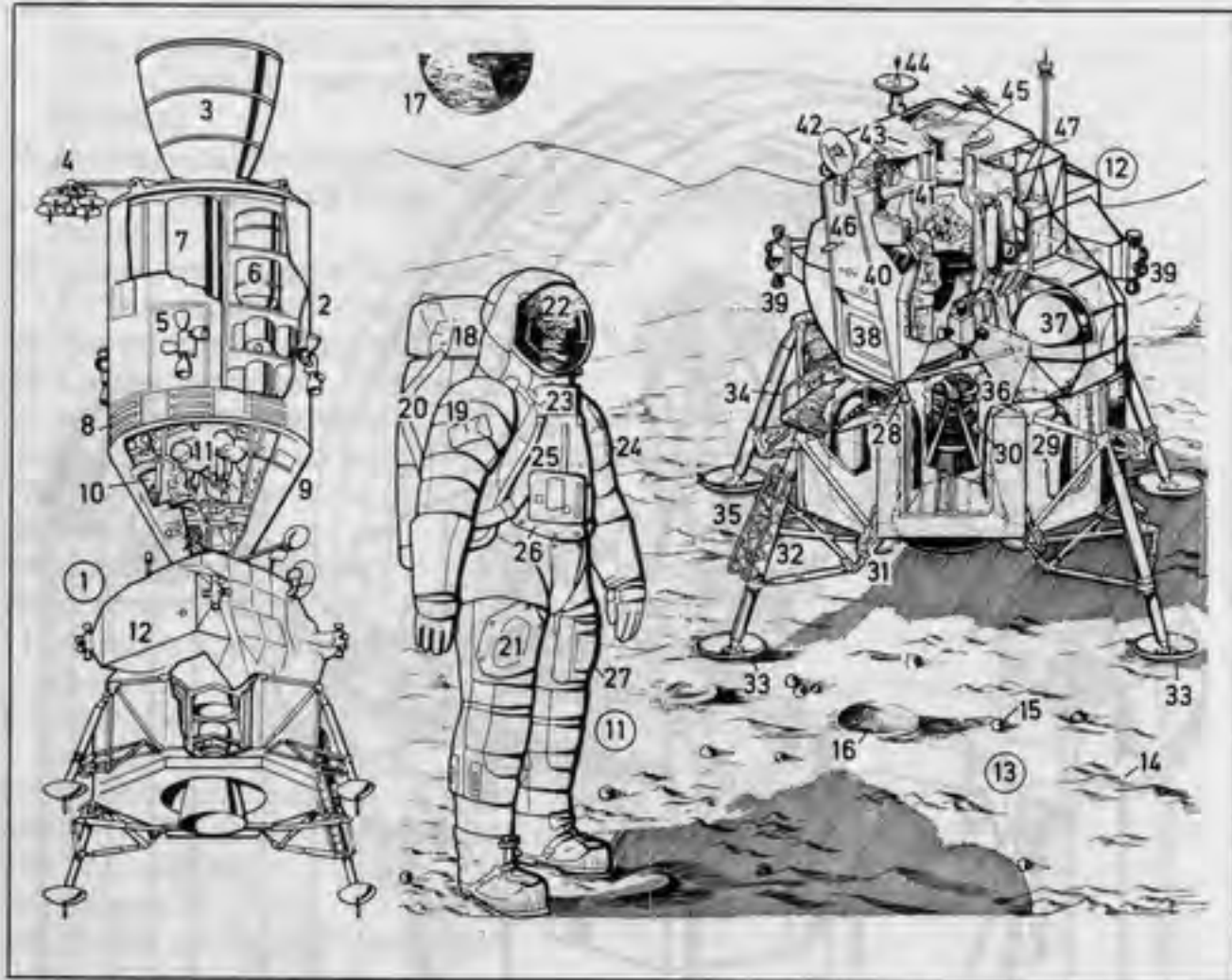

- 1 Apollo spacecraft
- 2 service module (SM)
- 3 nozzle of the main rocket engine
- 4 directional antenna
- 5 manoeuvring (*Am.* maneuvering) rockets
- 6 oxygen and hydrogen tanks for the spacecraft's energy system
- 7 fuel tank
- 8 radiators of the spacecraft's energy system
- 9 command module (Apollo space capsule)
- 10 entry hatch of the space capsule
- 11 astronaut
- 12 lunar module (LM)
- 13 moon's surface (lunar surface), a dust-covered surface
- 14 lunar dust
- 15 piece of rock
- 16 meteorite crater
- 17 the earth
- 18-27 space suit (extra-vehicular suit)
- 18 emergency oxygen apparatus
- 19 sunglass pocket [with sunglasses for use on board]
- 20 life support system (life support pack), a backpack unit
- 21 access flap
- 22 space suit helmet with sun filters
- 23 control box of the life support pack
- 24 penlight pocket
- 25 access flap for the purge valve
- 26 tube and cable connections for the radio, ventilation, and water-cooling systems
- 27 pocket for pens, tools, etc.
- 28-36 descent stage
- 28 connector
- 29 fuel tank
- 30 engine
- 31 mechanism for unfolding the legs
- 32 main shock absorber
- 33 landing pad
- 34 ingress/egress platform (hatch platform)
- 35 ladder to platform and hatch
- 36 cardan mount for engine
- 37-47 ascent stage
- 37 fuel tank
- 38 ingress/egress hatch (entry/exit hatch)
- 39 LM manoeuvring (*Am.* maneuvering) rockets
- 40 window
- 41 crew compartment
- 42 rendezvous radar antenna
- 43 inertial measurement unit
- 44 directional antenna for ground control
- 45 upper hatch (docking hatch)
- 46 inflight antenna
- 47 docking target recess

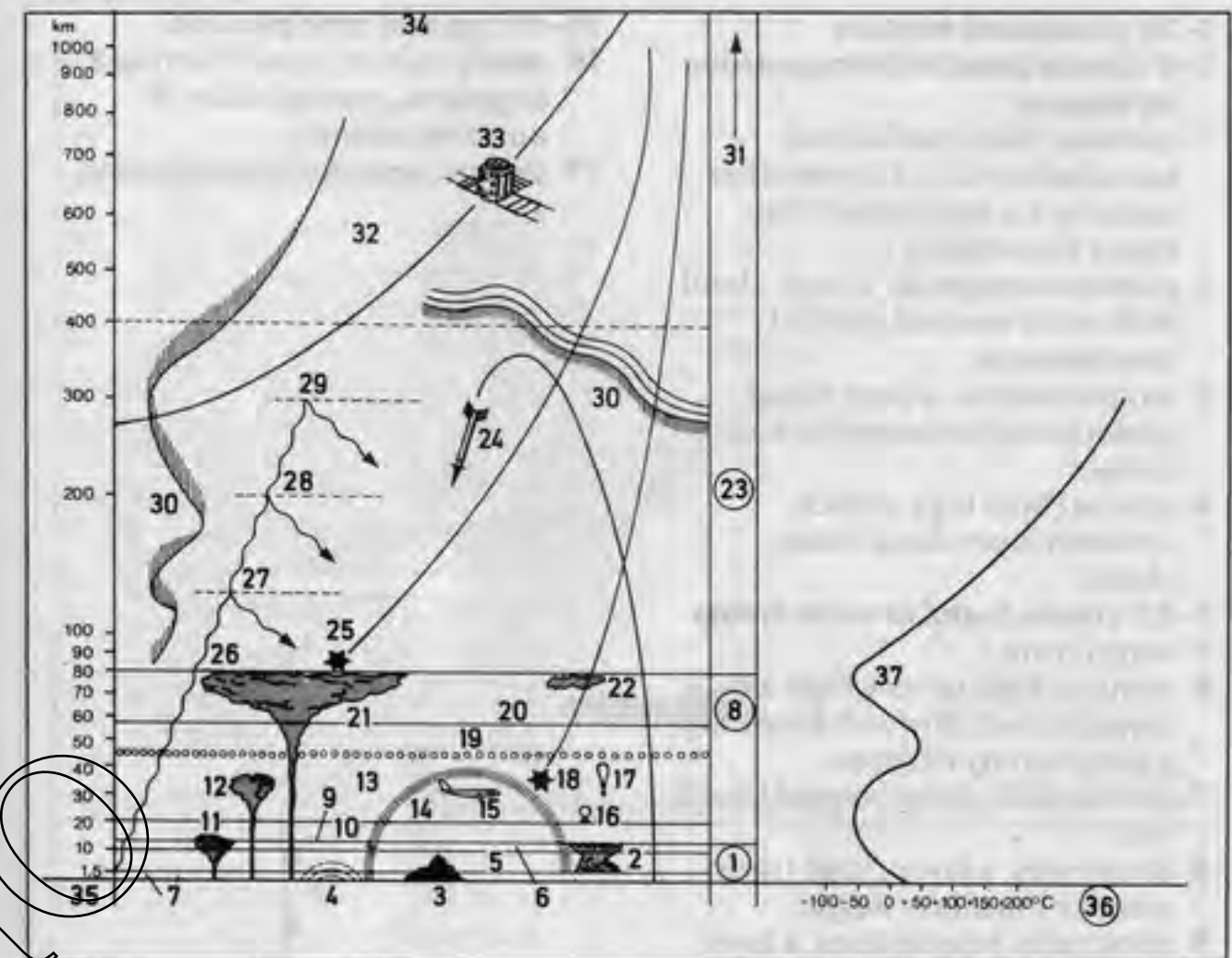

- 1 the troposphere
- 2 thunderclouds
- 3 the highest mountain, *Mount Everest* [8,882m]
- 4 rainbow
- 5 jet stream level
- 6 zero level (inversion of vertical air movement)
- 7 ground layer (surface boundary layer)
- 8 the stratosphere
- 9 tropopause
- 10 separating layer (layer of weaker air movement)
- 11 atomic explosion
- 12 hydrogen bomb explosion
- 13 ozone layer
- 14 range of sound wave propagation
- 15 stratosphere aircraft
- 16 manned balloon
- 17 sounding balloon
- 18 meteor
- 19 upper limit of ozone layer
- 20 zero level
- 21 eruption of Krakatoa
- 22 luminous clouds (noctilucent clouds)
- 23 the ionosphere
- 24 range of research rockets
- 25 shooting star
- 26 short wave (high frequency)
- 27 E-layer (Heaviside-Kennelly Layer)
- 28 F₁-layer
- 29 F₂-layer
- 30 aurora (polar light)
- 31 the exosphere
- 32 atom layer
- 33 range of satellite sounding
- 34 fringe region
- 35 altitude scale
- 36 temperature scale (thermometric scale)
- 37 temperature graph

1-19 clouds and weather

1-4 clouds found in homogeneous air masses

- 1 cumulus (woolpack cloud, cumulus humilis, fair-weather cumulus), a heap cloud (flat-based heap cloud)
- 2 cumulus congestus, a heap cloud with more marked vertical development
- 3 stratocumulus, a layer cloud (sheet cloud) arranged in heavy masses
- 4 stratus (high fog), a thick, uniform layer cloud (sheet cloud)

5-12 clouds found at warm fronts

- 5 warm front
- 6 cirrus, a high to very high ice-crystal cloud, thin and assuming a wide variety of forms
- 7 cirrostratus, an ice-crystal cloud veil
- 8 altostratus, a layer cloud (sheet cloud) of medium height
- 9 altostratus praecipitans, a layer cloud (sheet cloud) with precipitation in its upper parts
- 10 nimbostratus, a rain cloud, a layer cloud (sheet cloud) of very large vertical extent which produces precipitation (rain or snow)

- 11 fractostratus, a ragged cloud occurring beneath nimbostratus
- 12 fractocumulus, a ragged cloud like 11 but with billowing shapes

13-17 clouds at cold fronts

- 13 cold front
- 14 cirrocumulus, thin fleecy cloud in the form of globular masses; covering the sky: mackerel sky
- 15 altocumulus, a cloud in the form of large globular masses
- 16 altocumulus castellanus and altocumulus floccus, species of 15
- 17 cumulonimbus, a heap cloud of very large vertical extent, to be classified under 1-4 in the case of tropical storms

18-19 types of precipitation

- 18 steady rain or snow covering a large area, precipitation of uniform intensity
- 19 shower, scattered precipitation

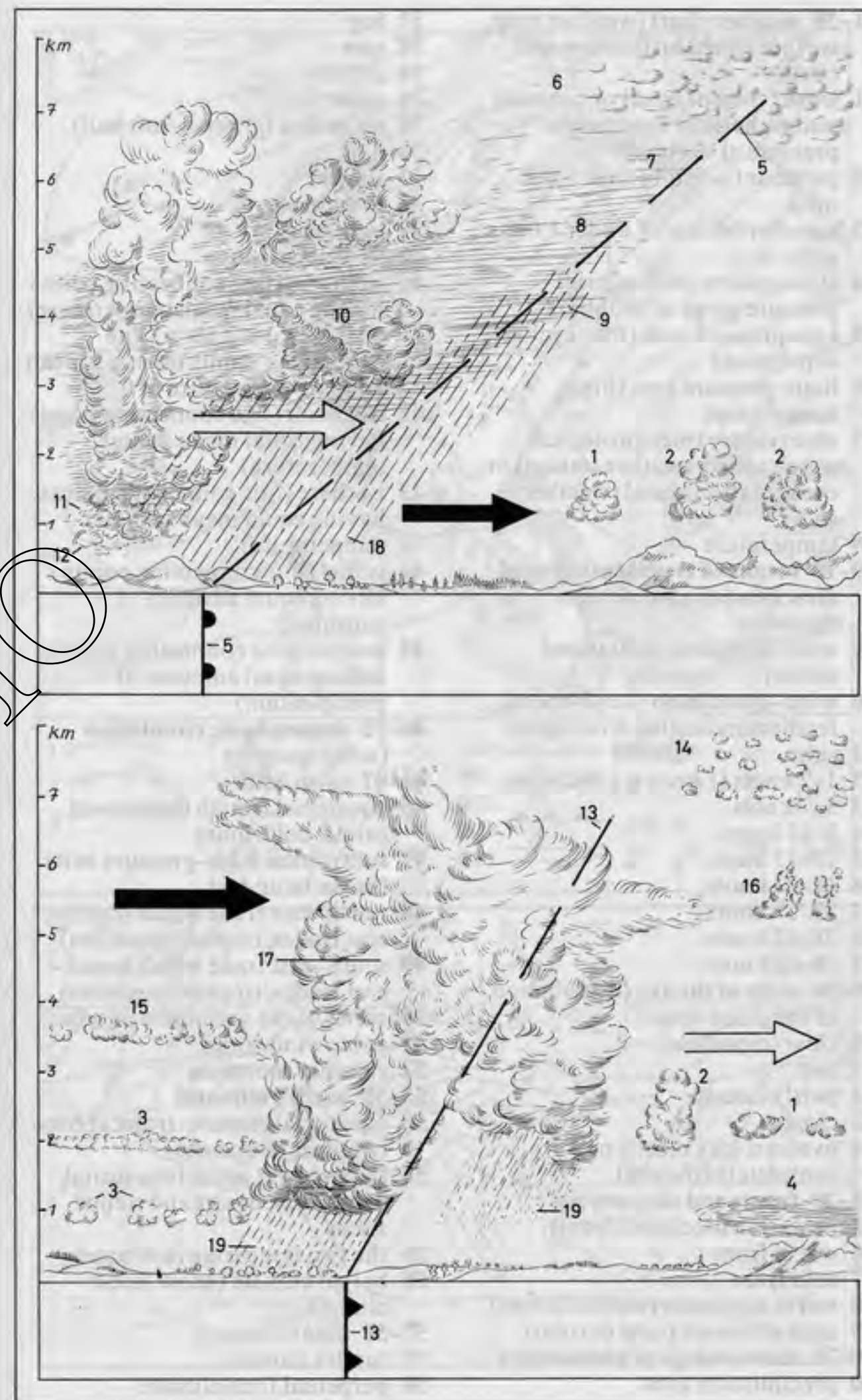

black arrow = cold air white arrow = warm air

- 1-39 weather chart (weather map, surface chart, surface synoptic chart)
- 1 isobar (line of equal or constant atmospheric or barometric pressure at sea level)
- 2 pleiobar (isobar of over 1,000 mb)
- 3 meiobar (isobar of under 1,000 mb)
- 4 atmospheric (barometric) pressure given in millibars
- 5 low-pressure area (low, cyclone, depression)
- 6 high-pressure area (high, anticyclone)
- 7 observatory (meteorological watch office, weather station) or ocean station vessel (weather ship)
- 8 temperature
- 9-19 means of representing wind direction (wind-direction symbols)
- 9 wind-direction shaft (wind arrow)
- 10 wind-speed barb (wind-speed feather) indicating wind speed
- 11 calm
- 12 1-2 knots (1 knot = 1.852 kph)
- 13 3-7 knots
- 14 8-12 knots
- 15 13-17 knots
- 16 18-22 knots
- 17 23-27 knots
- 18 28-32 knots
- 19 58-62 knots
- 20-24 state of the sky (distribution of the cloud cover)
- 20 clear (cloudless)
- 21 fair
- 22 partly cloudy
- 23 cloudy
- 24 overcast (sky mostly or completely covered)
- 25-29 fronts and air currents
- 25 occlusion (occluded front)
- 26 warm front
- 27 cold front
- 28 warm airstream (warm current)
- 29 cold airstream (cold current)
- 30-39 meteorological phenomena
- 30 precipitation area

- 31 fog
- 32 rain
- 33 drizzle
- 34 snow
- 35 ice pellets (graupel, soft hail)
- 36 hail
- 37 shower
- 38 thunderstorm
- 39 lightning
- 40-58 climatic map
- 40 isotherm (line connecting points having equal mean temperature)
- 41 0 °C (zero) isotherm (line connecting points having a mean annual temperature of 0 °C)
- 42 isocheim (line connecting points having equal mean winter temperature)
- 43 isothere (line connecting points having equal mean summer temperature)
- 44 isohel (line connecting points having equal duration of sunshine)
- 45 isohyet (line connecting points having equal amounts of precipitation)
- 46-52 atmospheric circulation (wind systems)
- 46-47 calm belts
- 46 equatorial trough (equatorial calms, doldrums)
- 47 subtropical high-pressure belts (horse latitudes)
- 48 north-east trade winds (north-east trades, tropical easterlies)
- 49 south-east trade winds (south-east trades, tropical easterlies)
- 50 zones of the variable westerlies
- 51 polar wind zones
- 52 summer monsoon
- 53-58 earth's climates
- 53 equatorial climate: tropical zone (tropical rain zone)
- 54 the two arid zones (equatorial dry zones): desert and steppe zones
- 55 the two temperate rain zones
- 56 boreal climate (snow forest climate)
- 57-58 polar climates
- 57 tundra climate
- 58 perpetual frost climate

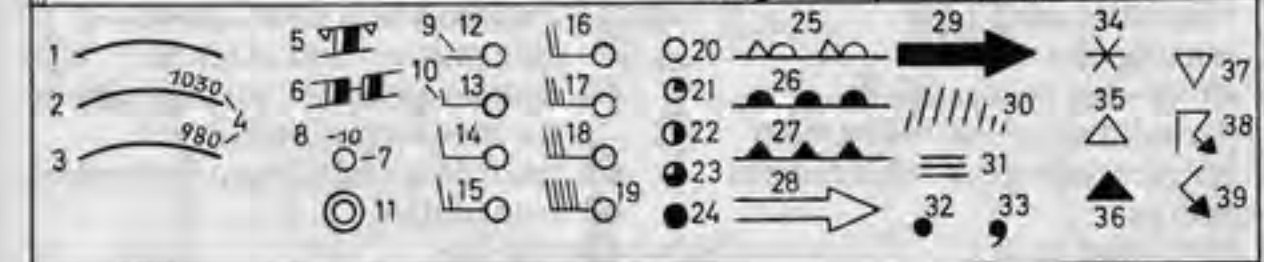
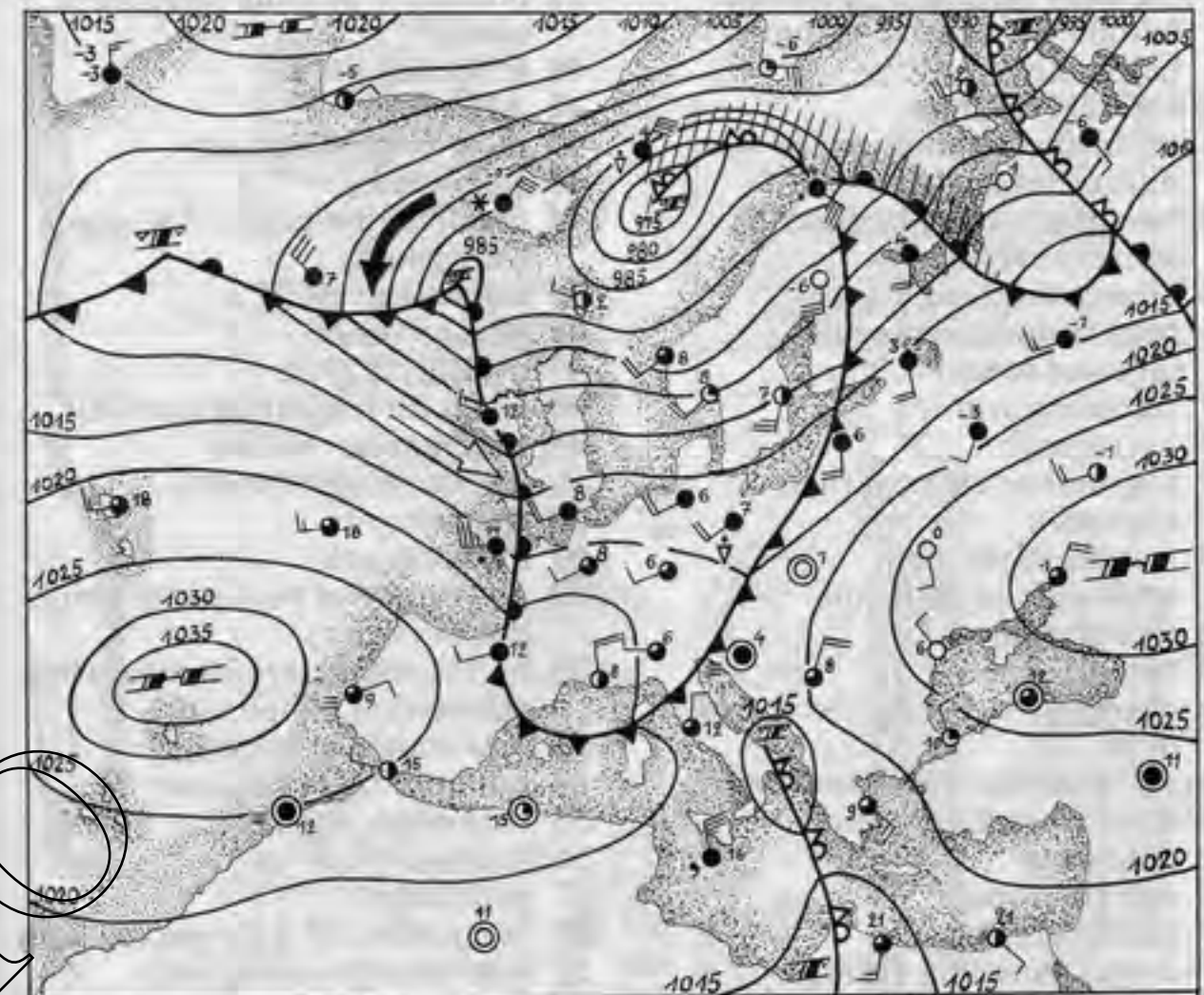

- | | |
|--|--|
| 1 mercury barometer, a siphon barometer, a liquid-column barometer | 39 protective housing (protective casing) |
| 2 mercury column | 40 collecting vessel |
| 3 millibar scale (millimetre, <i>Am.</i> millimeter, scale) | 41 rain cover |
| 4 barograph, a self-registering aneroid barometer | 42 recording mechanism |
| 5 drum (recording drum) | 43 siphon tube |
| 6 bank of aneroid capsules (aneroid boxes) | 44 precipitation gauge (<i>Am.</i> gage) (rain gauge) |
| 7 recording arm | 45 collecting vessel |
| 8 hygograph | 46 storage vessel |
| 9 hygrometer element (hair element) | 47 measuring glass |
| 10 reading adjustment | 48 insert for measuring snowfall |
| 11 amplitude adjustment | 49 thermometer screen (thermometer shelter) |
| 12 recording arm | 50 hygograph |
| 13 recording pen | 51 thermograph |
| 14 change gears for the clockwork drive | 52 psychrometer (wet and dry bulb thermometer) |
| 15 off switch for the recording arm | 53-54 thermometers for measuring extremes of temperature |
| 16 drum (recording drum) | 53 maximum thermometer |
| 17 time scale | 54 minimum thermometer |
| 18 case (housing) | 55 radiosonde assembly |
| 19 thermograph | 56 hydrogen balloon |
| 20 drum (recording drum) | 57 parachute |
| 21 recording arm | 58 radar reflector with spacing lines |
| 22 sensing element | 59 instrument housing with radiosonde (a short-wave transmitter) and antenna |
| 23 silver-disc (silver-disk) pyrheliometer, an instrument for measuring the sun's radiant energy | 60 transmissometer, an instrument for measuring visibility |
| 24 silver disc (disk) | 61 recording instrument (recorder) |
| 25 thermometer | 62 transmitter |
| 26 wooden insulating casing | 63 receiver |
| 27 tube with diaphragm (diaphragmed tube) | 64 weather satellite (ITOS satellite) |
| 28 wind gauge (<i>Am.</i> gage) (anemometer) | 65 temperature regulation flaps |
| 29 wind-speed indicator (wind-speed meter) | 66 solar panel |
| 30 cross arms with hemispherical cups | 67 television camera |
| 31 wind-direction indicator | 68 antenna |
| 32 wind vane | 69 solar sensor (sun sensor) |
| 33 aspiration psychrometer | 70 telemetry antenna |
| 34 dry bulb thermometer | 71 radiometer |
| 35 wet bulb thermometer | |
| 36 solar radiation shielding | |
| 37 suction tube | |
| 38 recording rain gauge (<i>Am.</i> gage) | |

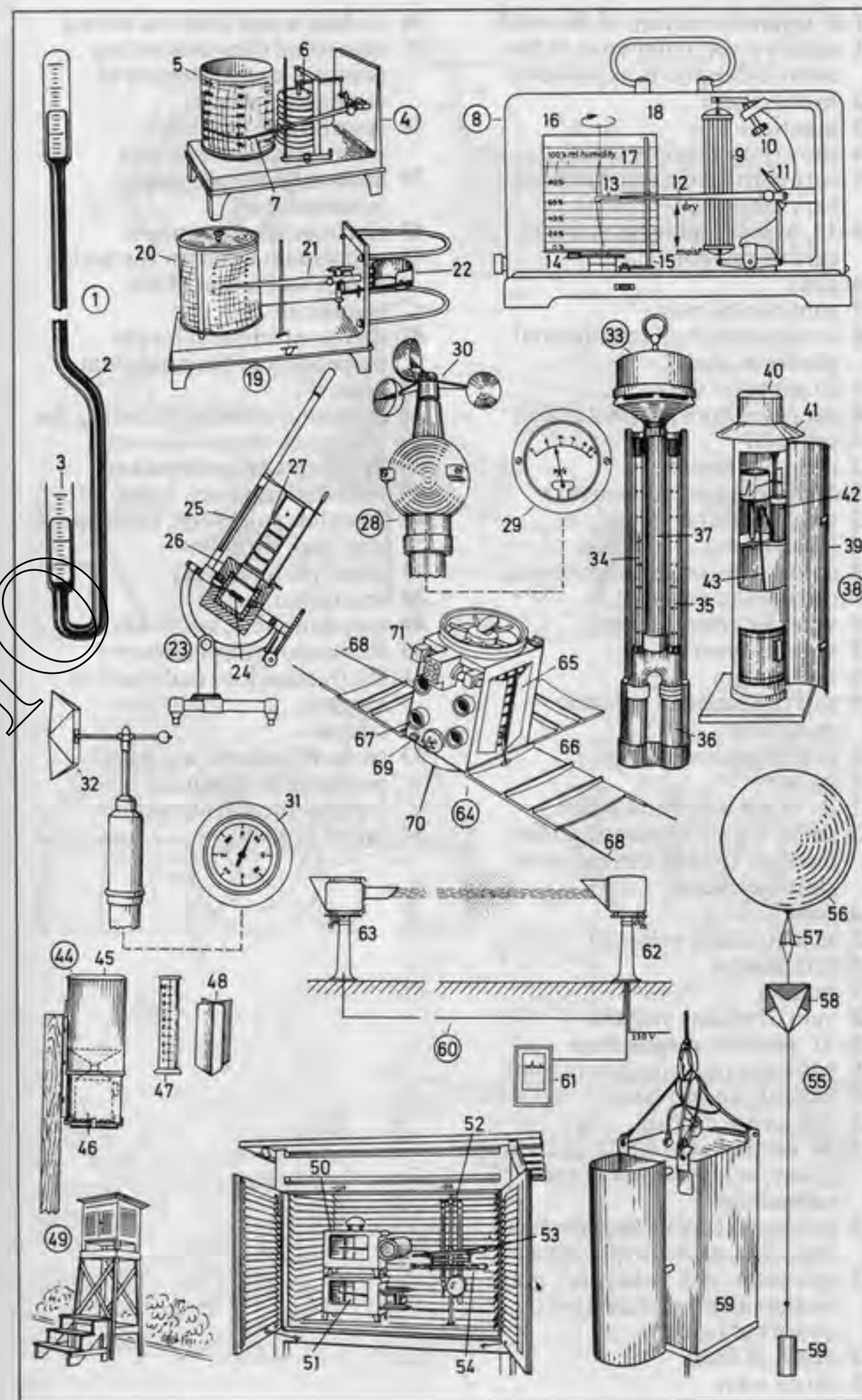

- 1-5 layered structure of the earth
- 1 earth's crust (outer crust of the earth, lithosphere, oxysphere)
- 2 hydrosphere
- 3 mantle
- 4 sima (intermediate layer)
- 5 core (earth core, centrosphere, barysphere)
- 6-12 hypsographic curve of the earth's surface
- 6 peak
- 7 continental mass
- 8 continental shelf (continental platform, shelf)
- 9 continental slope
- 10 deep-sea floor (abyssal plane)
- 11 sea level
- 12 deep-sea trench
- 13-28 volcanism (vulcanicity)
- 13 shield volcano
- 14 lava plateau
- 15 active volcano, a stratovolcano (composite volcano)
- 16 volcanic crater (crater)
- 17 volcanic vent
- 18 lava stream
- 19 tuff (fragmented volcanic material)
- 20 subterranean volcano
- 21 geyser
- 22 jet of hot water and steam
- 23 sinter terraces (siliceous sinter terraces, fiorite terraces, pearl sinter terraces)
- 24 cone
- 25 maar (extinct volcano)
- 26 tuff deposit
- 27 breccia
- 28 vent of extinct volcano
- 29-31 plutonic magmatism
- 29 batholite (massive protrusion)
- 30 lacolith, an intrusion
- 31 sill, an ore deposit
- 32-38 earthquake (kinds: tectonic quake, volcanic quake) and seismology
- 32 earthquake focus (seismic focus, hypocentre, *Am.* hypocenter)
- 33 epicentre (*Am.* epicenter), point on the earth's surface directly above the focus
- 34 depth of focus
- 35 shock wave

- 36 surface waves (seismic waves)
- 37 isoseismal (line connecting points of equal intensity of earthquake shock)
- 38 epicentral area (area of macroseismic vibration)
- 39 horizontal seismograph (seismometer)
- 40 electromagnetic damper
- 41 adjustment knob for the period of free oscillation of the pendulum
- 42 spring attachment for the suspension of the pendulum
- 43 mass
- 44 induction coils for recording the voltage of the galvanometer
- 45-54 effects of earthquakes
- 45 waterfall (cataract, falls)
- 46 landslide (rockslide, landslip, *Am.* rock slip)
- 47 talus (rubble, scree)
- 48 scar (scaur, scaw)
- 49 sink (sinkhole, swallowhole)
- 50 dislocation (displacement)
- 51 solifluction lobe (solifluction tongue)
- 52 fissure
- 53 tsunami (seismic sea wave) produced by seaquake (submarine earthquake)
- 54 raised beach

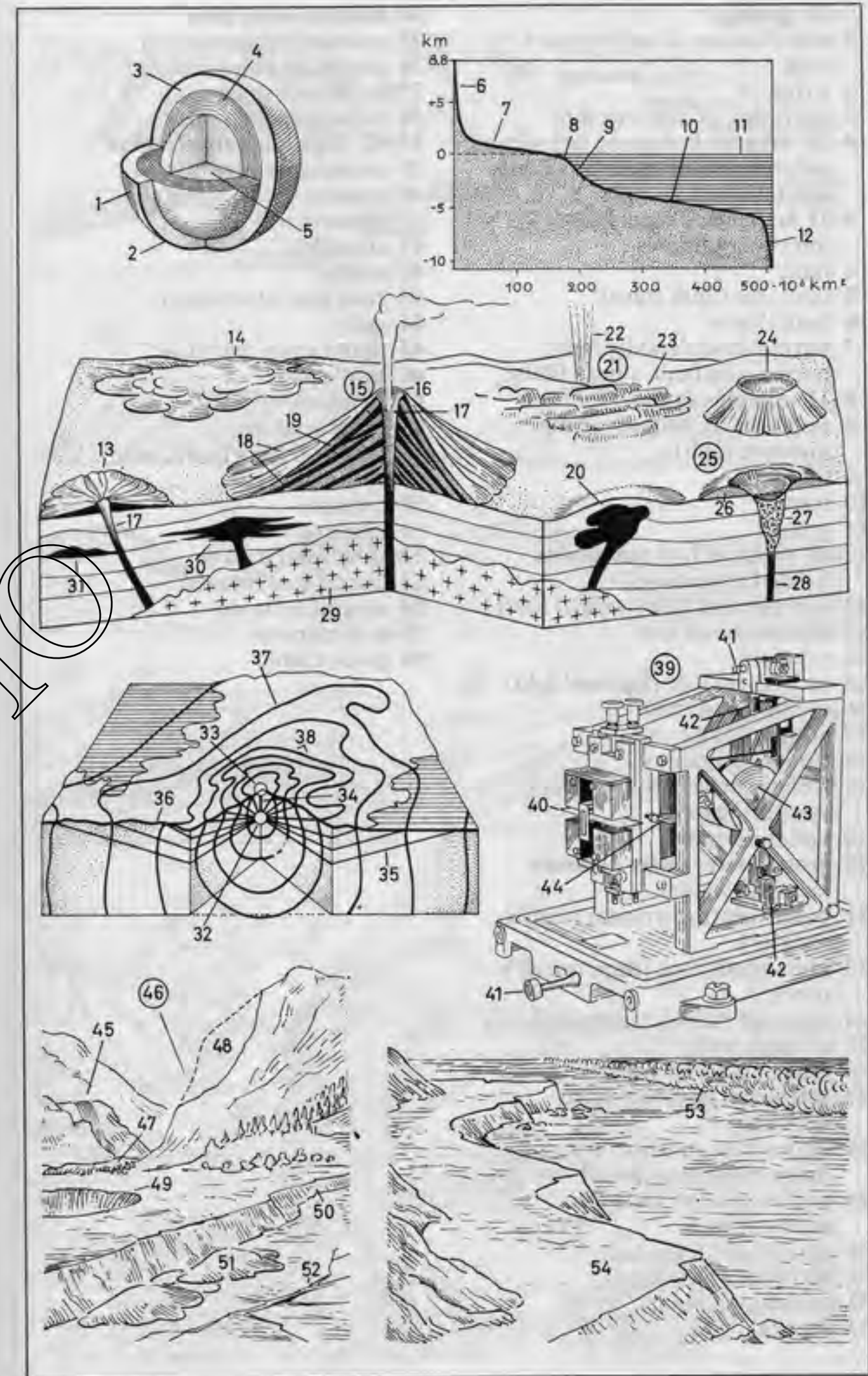

DEMO

1-33 geology

- 1 stratification of sedimentary rock
- 2 strike
- 3 dip (angle of dip, true dip)
- 4-20 orogeny (orogenesis, tectogenesis, deformation of rocks by folding and faulting)
- 4-11 fault-block mountains (block mountains)
- 4 fault
- 5 fault line (fault trace)
- 6 fault throw
- 7 normal fault (gravity fault, normal slip fault, slump fault)
- 8-11 complex faults
- 8 step fault (distributive fault, multiple fault)
- 9 tilt block
- 10 horst
- 11 graben
- 12-20 range of fold mountains (folded mountains)
- 12 symmetrical fold (normal fold)
- 13 asymmetrical fold
- 14 overfold
- 15 recumbent fold (reclined fold)
- 16 saddle (anticline)
- 17 anticlinal axis
- 18 trough (syncline)
- 19 trough surface (trough plane, synclinal axis)
- 20 anticlinorium
- 21 groundwater under pressure (artesian water)
- 22 water-bearing stratum (aquifer, aquafer)
- 23 impervious rock (impermeable rock)
- 24 drainage basin (catchment area)
- 25 artesian well
- 26 rising water, an artesian spring
- 27 petroleum reservoir in an anticline
- 28 impervious stratum (impermeable stratum)
- 29 porous stratum acting as reservoir rock
- 30 natural gas, a gas cap
- 31 petroleum (crude oil)
- 32 underlying water
- 33 derrick

34 mountainous area

- 35 rounded mountain top
- 36 mountain ridge (ridge)
- 37 mountain slope
- 38 hillside spring
- 39-47 high-mountain region
- 39 mountain range, a massif
- 40 summit (peak, top of the mountain)
- 41 shoulder
- 42 saddle
- 43 rock face (steep face)
- 44 gully
- 45 talus (scree, detritus)
- 46 bridle path
- 47 pass (col)
- 48-56 glacial ice
- 48 firn field (firn basin, nevé)
- 49 valley glacier
- 50 crevasse
- 51 glacier snout
- 52 subglacial stream
- 53 lateral moraine
- 54 medial moraine
- 55 end moraine
- 56 glacier table

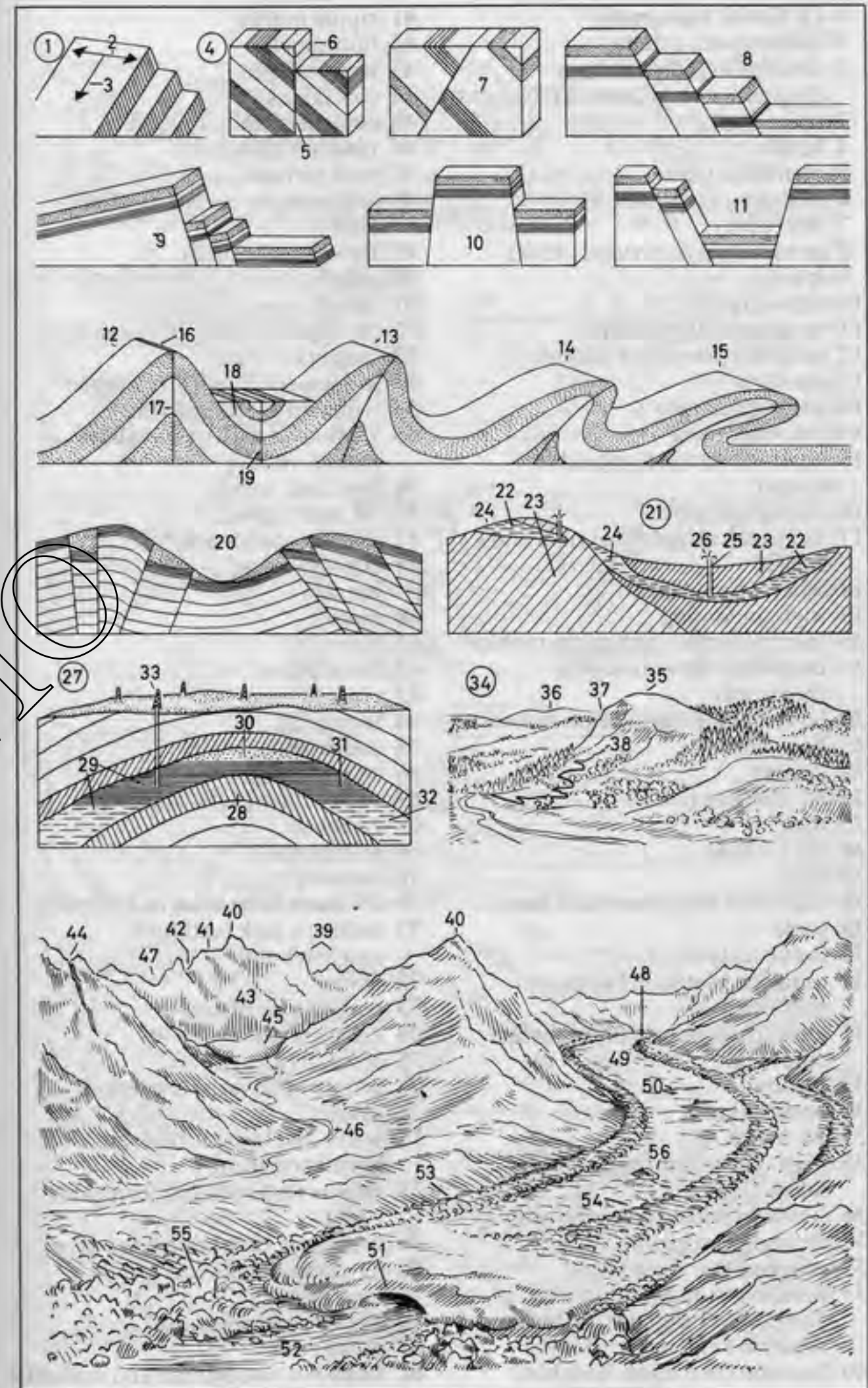

DEMO

1-13 fluvial topography

- 1 river mouth, a delta
- 2 distributary (distributary channel), a river branch (river arm)
- 3 lake
- 4 bank
- 5 peninsula (spit)
- 6 island
- 7 bay (cove)
- 8 stream (brook, rivulet, creek)
- 9 levee
- 10 alluvial plain
- 11 meander (river bend)
- 12 meander core (rock island)
- 13 meadow
- 14-24 bog (marsh)
- 14 low-moor bog
- 15 layers of decayed vegetable matter
- 16 entrapped water
- 17 fen peat [consisting of rush and sedge]
- 18 alder-swamp peat
- 19 high-moor bog
- 20 layer of recent sphagnum mosses
- 21 boundary between layers (horizons)
- 22 layer of older sphagnum mosses
- 23 bog pool
- 24 swamp
- 25-31 cliffline (cliffs)
- 25 rock
- 26 sea (ocean)
- 27 surf
- 28 cliff (cliff face, steep rock face)
- 29 scree
- 30 [wave-cut] notch
- 31 abrasion platform (wave-cut platform)
- 32 atoll (ring-shaped coral reef), a coral reef
- 33 lagoon
- 34 breach (hole)
- 35-44 beach
- 35 high-water line (high-water mark, tidemark)
- 36 waves breaking on the shore
- 37 groyne (Am. groin)
- 38 groyne (Am. groin) head
- 39 wandering dune (migratory dune, travelling, Am. traveling dune), a dune
- 40 barchan (barchane, barkhan, crescentic dune)

- 41 ripple marks
- 42 hummock
- 43 wind cripple
- 44 coastal lake
- 45 canyon (cañon, coulee)
- 46 plateau (tableland)
- 47 rock terrace
- 48 sedimentary rock (stratified rock)
- 49 river terrace (bed)
- 50 joint
- 51 canyon river
- 52-56 types of valley [cross section]
- 52 gorge (ravine)
- 53 V-shaped valley (V-valley)
- 54 widened V-shaped valley
- 55 U-shaped valley (U-valley, trough valley)
- 56 synclinal valley
- 57-70 river valley
- 57 scarp (escarpment)
- 58 slip-off slope
- 59 mesa
- 60 ridge
- 61 river
- 62 flood plain
- 63 river terrace
- 64 terracette
- 65 pediment
- 66 hill
- 67 valley floor (valley bottom)
- 68 riverbed
- 69 sediment
- 70 bedrock
- 71-83 karst formation in limestone
- 71 dolina, a sink (sinkhole, swallowhole)
- 72 polje
- 73 percolation of a river
- 74 karst spring
- 75 dry valley
- 76 system of caverns (system of caves)
- 77 water level (water table) in a karst formation
- 78 impervious rock (impermeable rock)
- 79 limestone cave (dripstone cave)
- 80-81 speleothems (cave formations)
- 80 stalactite (dripstone)
- 81 stalagmite
- 82 linked-up stalagmite and stalactite
- 83 subterranean river

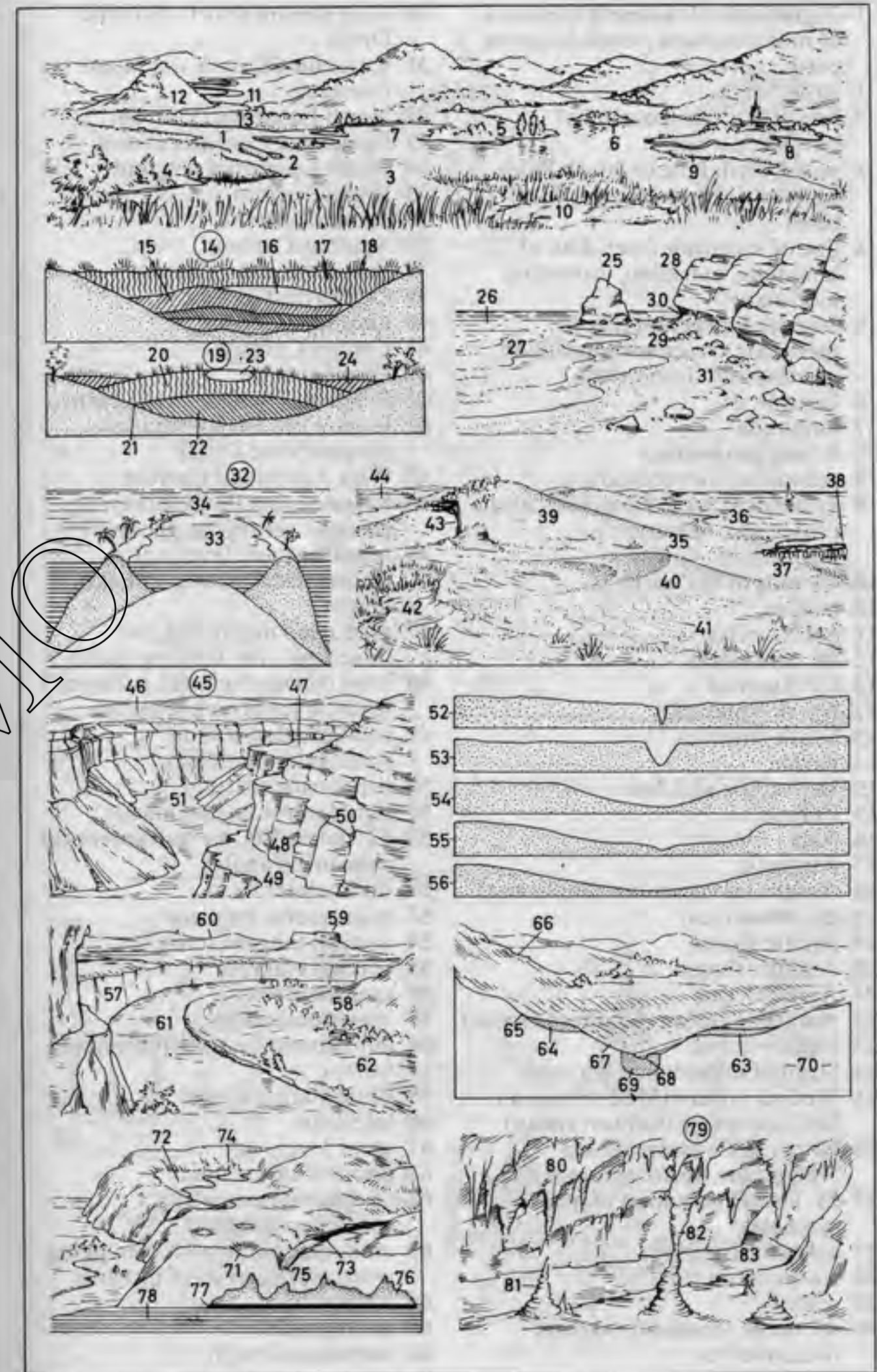

- 1-7 **graticule of the earth** (network of meridians and parallels on the earth's surface)
- 1 equator
 - 2 line of latitude (parallel of latitude, parallel)
 - 3 pole (North Pole or South Pole), a terrestrial pole (geographical pole)
 - 4 line of longitude (meridian of longitude, meridian, terrestrial meridian)
 - 5 Standard meridian (Prime meridian, Greenwich meridian, meridian of Greenwich)
 - 6 latitude
 - 7 longitude
- 8-9 **map projections**
- 8 conical (conic) projection
 - 9 cylindrical projection (Mercator projection, Mercator's projection)
- 10-45 **map of the world**
- 10 tropics
 - 11 polar circles
 - 12-18 **continents**
 - 12-13 America
 - 12 North America
 - 13 South America
 - 14 Africa
 - 15-16 Europe and Asia
 - 15 Europe
 - 16 Asia
 - 17 Australia
 - 18 Antarctica (Antarctic Continent)
 - 19-26 **ocean (sea)**
 - 19 Pacific Ocean
 - 20 Atlantic Ocean
 - 21 Arctic Ocean
 - 22 Antarctic Ocean (Southern Ocean)
 - 23 Indian Ocean
 - 24 Strait of Gibraltar, a sea strait
 - 25 Mediterranean (Mediterranean Sea, European Mediterranean)
 - 26 North Sea, a marginal sea (epeiric sea, epicontinental sea)
 - 27-29 **key (explanation of map symbols)**
 - 27 cold ocean current
 - 28 warm ocean current
 - 29 scale
 - 30-45 **ocean (oceanic) currents (ocean drifts)**
 - 30 Gulf Stream (North Atlantic Drift)
 - 31 Kuroshio (Kuro Siwo, Japan Current)
 - 32 North Equatorial Current
 - 33 Equatorial Countercurrent
 - 34 South Equatorial Current
 - 35 Brazil Current
 - 36 Somali Current
 - 37 Agulhas Current
 - 38 East Australian Current
 - 39 California Current
 - 40 Labrador Current
 - 41 Canary Current
 - 42 Peru Current
 - 43 Benguela (Benguella) Current
 - 44 West Wind Drift (Antarctic Circumpolar Drift)
 - 45 West Australian Current
- 46-62 **surveying (land surveying, geodetic surveying, geodesy)**
- 46 levelling (*Am.* leveling) (geometrical measurement of height)
 - 47 graduated measuring rod (levelling, *Am.* leveling, staff)
 - 48 level (surveying level, surveyor's level), a surveyor's telescope
 - 49 triangulation station (triangulation point)
 - 50 supporting scaffold
 - 51 signal tower (signal mast)
 - 52-62 **theodolite, an instrument for measuring angles**
 - 52 micrometer head
 - 53 micrometer eyepiece
 - 54 vertical tangent screw
 - 55 vertical clamp
 - 56 tangent screw
 - 57 horizontal clamp
 - 58 adjustment for the illuminating mirror
 - 59 illuminating mirror
 - 60 telescope
 - 61 spirit level
 - 62 circular adjustment
- 63-66 **photogrammetry (phototopography)**
- 63 air survey camera for producing overlapping series of pictures
 - 64 stereoscope
 - 65 pantograph
 - 66 stereoplanigraph

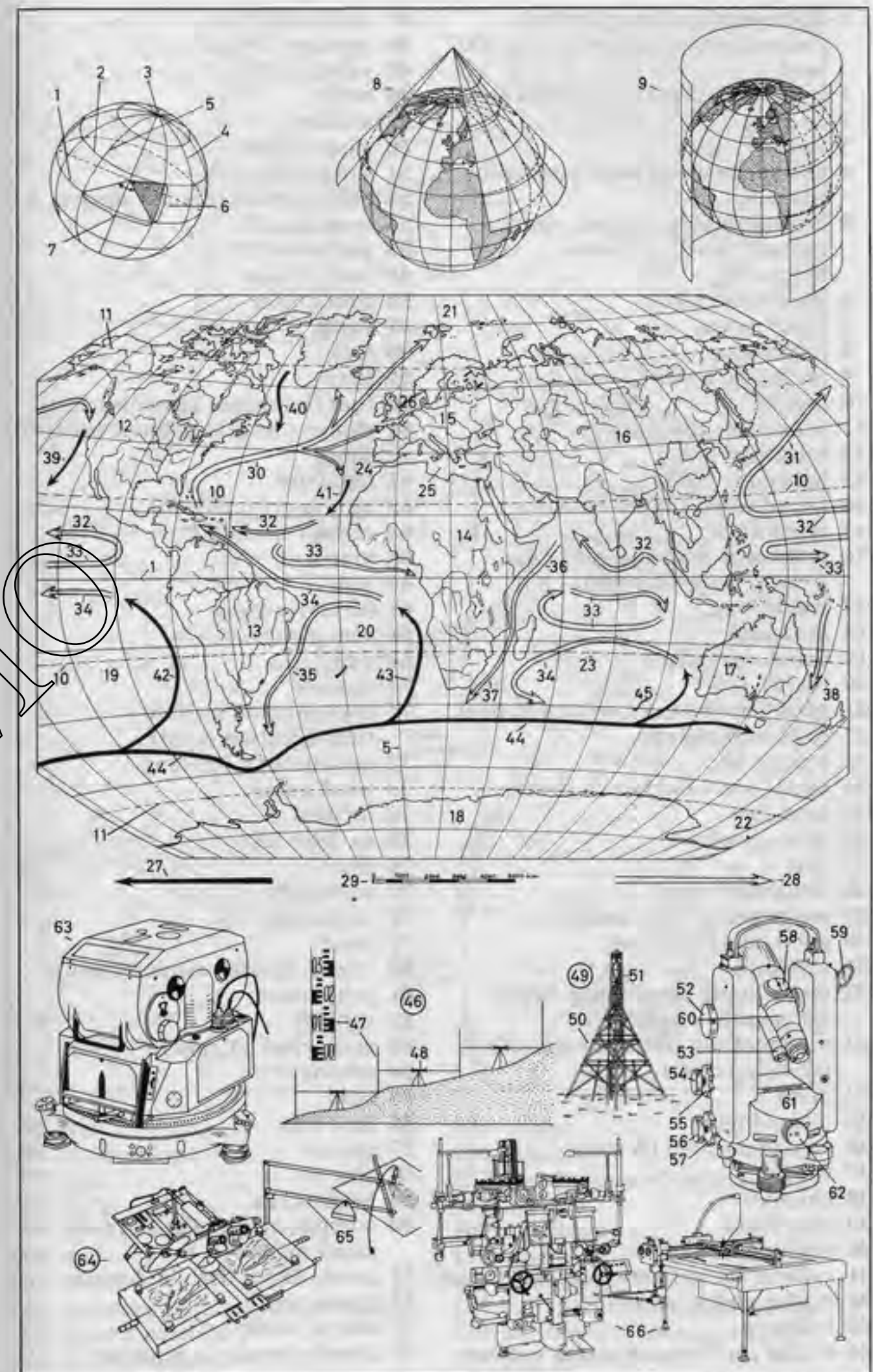

- | | |
|---|--|
| 1-114 map signs (map symbols, conventional signs) on a 1:25 000 map | 45 navigable river |
| 1 coniferous wood (coniferous trees) | 46 pontoon bridge |
| 2 clearing | 47 vehicle ferry |
| 3 forestry office | 48 mole |
| 4 deciduous wood (non-coniferous trees) | 49 beacon |
| 5 heath (rough grassland, rough pasture, heath and moor, bracken) | 50 stone bridge |
| 6 sand (sand hills) | 51 town (city) |
| 7 beach grass | 52 market place (market square) |
| 8 lighthouse | 53 large church |
| 9 mean low water | 54 public building |
| 10 beacon | 55 road bridge |
| 11 submarine contours | 56 iron bridge |
| 12 train ferry | 57 canal |
| 13 lightship | 58 lock |
| 14 mixed wood (mixed trees) | 59 jetty |
| 15 brushwood | 60 foot ferry (foot passenger ferry) |
| 16 motorway with slip road (Am. freeway with on-ramp) | 61 chapel (church) without tower or spire |
| 17 trunk road | 62 contours |
| 18 grassland | 63 monastery (convent) |
| 19 marshy grassland | 64 church landmark |
| 20 marsh | 65 vineyard |
| 21 main line railway (Am. trunk line) | 66 weir |
| 22 road over railway | 67 aerial ropeway |
| 23 branch line | 68 view point |
| 24 signal box (Am. switch tower) | 69 dam |
| 25 local line | 70 tunnel |
| 26 level crossing | 71 triangulation station (triangulation point) |
| 27 halt | 72 remains of a building |
| 28 residential area | 73 wind pump |
| 29 water gauge (Am. gage) | 74 fortress |
| 30 good, metalled road | 75 ox-bow lake |
| 31 windmill | 76 river |
| 32 thorn house (graduation house, salina, salt-works) | 77 watermill |
| 33 broadcasting station (wireless or television mast) | 78 footbridge |
| 34 mine | 79 pond |
| 35 disused mine | 80 stream (brook, rivulet, creek) |
| 36 secondary road (B road) | 81 water tower |
| 37 works | 82 spring |
| 38 chimney | 83 main road (A road) |
| 39 wire fence | 84 cutting |
| 40 bridge over railway | 85 cave |
| 41 railway station (Am. railroad station) | 86 lime kiln |
| 42 bridge under railway | 87 quarry |
| 43 footpath | 88 clay pit |
| 44 bridge for footpath under railway | 89 brickworks |
| | 90 narrow-gauge (Am. narrow gage) railway |
| | 91 goods depot (freight depot) |
| | 92 monument |
| | 93 site of battle |
| | 94 country estate, a demesne |



- | | |
|------------------------------------|--------------------------------------|
| 95 wall | 105 village |
| 96 stately home | 106 cemetery |
| 97 park | 107 church (chapel) with spire |
| 98 hedge | 108 orchard |
| 99 poor or unmetalled road | 109 milestone |
| 100 well | 110 guide post |
| 101 farm | 111 tree nursery |
| 102 unfenced path (unfenced track) | 112 ride (aisle, lane, section line) |
| 103 district boundary | 113 electricity transmission line |
| 104 embankment | 114 hop garden |

- 1-54 the human body
- 1-18 head
- 1 vertex (crown of the head, top of the head)
- 2 occiput (back of the head)
- 3 hair
- 4-17 face
- 4-5 forehead
- 4 frontal eminence (frontal protuberance)
- 5 superciliary arch
- 6 temple
- 7 eye
- 8 zygomatic bone (malar bone, jugal bone, cheekbone)
- 9 cheek
- 10 nose
- 11 nasolabial fold
- 12 philtrum
- 13 mouth
- 14 angle of the mouth (labial commissure)
- 15 chin
- 16 dimple (fossette) in the chin
- 17 jaw
- 18 ear
- 19-21 neck
- 19 throat
- 20 hollow of the throat
- 21 nape of the neck
- 22-41 trunk
- 22-25 back
- 22 shoulder
- 23 shoulderblade (scapula)
- 24 loins
- 25 small of the back
- 26 armpit
- 27 armpit hair
- 28-30 thorax (chest)
- 28-29 breasts (breast, mamma)
- 28 nipple
- 29 areola
- 30 bosom
- 31 waist
- 32 flank (side)
- 33 hip
- 34 navel
- 35-37 abdomen (stomach)
- 35 upper abdomen
- 36 abdomen
- 37 lower abdomen
- 38 groin
- 39 pudenda (vulva)
- 40 seat (backside, coll. bottom)
- 41 anal groove (anal cleft)
- 42 gluteal fold (gluteal furrow)
- 43-54 limbs
- 43-48 arm
- 43 upper arm
- 44 crook of the arm
- 45 elbow
- 46 forearm
- 47 hand
- 48 fist (clenched fist, clenched hand)
- 49-54 leg
- 49 thigh
- 50 knee
- 51 popliteal space
- 52 shank
- 53 calf
- 54 foot

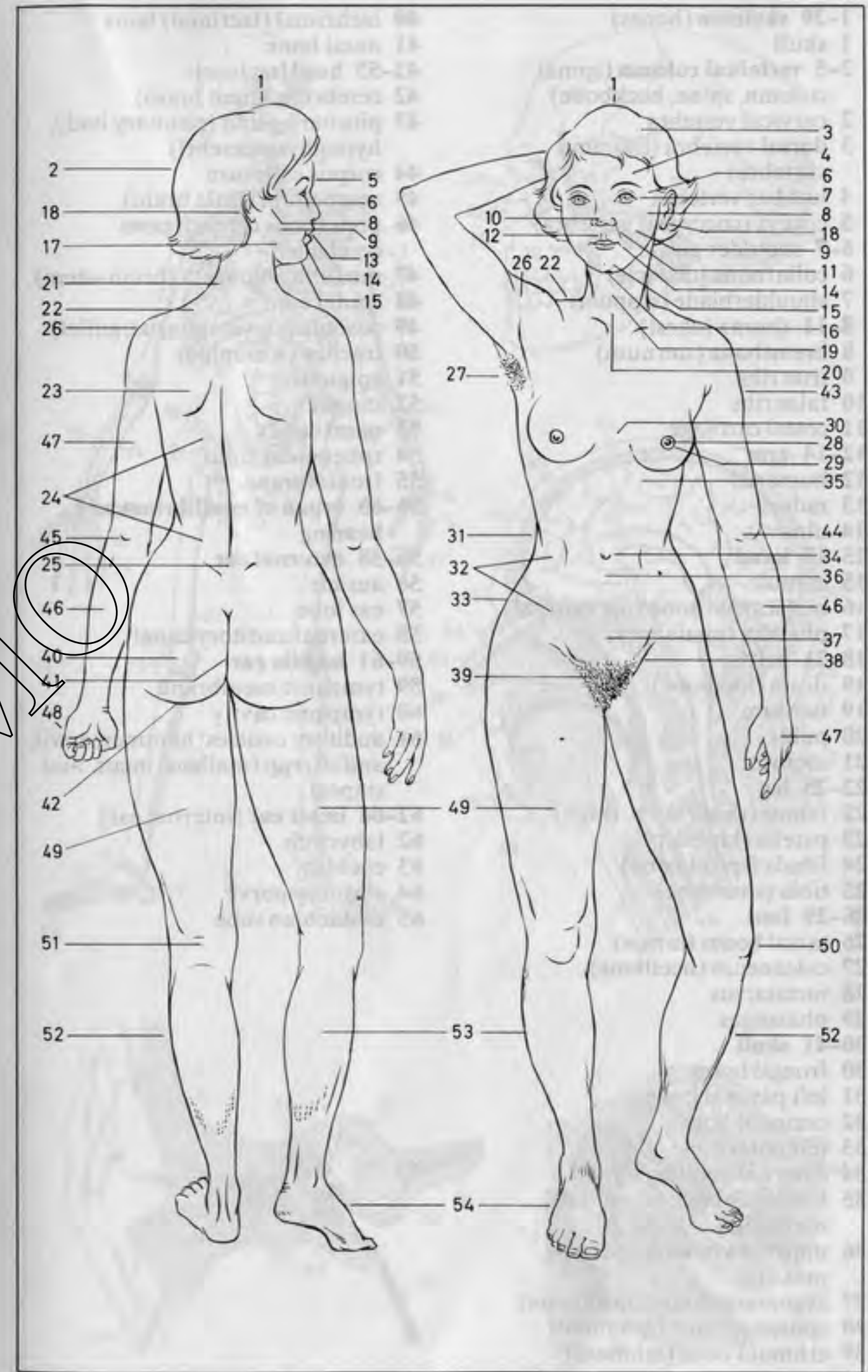

- 1-29 skeleton (bones)
 1 skull
 2-5 vertebral column (spinal column, spine, backbone)
 2 cervical vertebra
 3 dorsal vertebra (thoracic vertebra)
 4 lumbar vertebra
 5 coccyx (coccygeal vertebra)
 6-7 shoulder girdle
 6 collarbone (clavicle)
 7 shoulderblade (scapula)
 8-11 thorax (chest)
 8 breastbone (sternum)
 9 true ribs
 10 false ribs
 11 costal cartilage
 12-14 arm
 12 humerus
 13 radius
 14 ulna
 15-17 hand
 15 carpus
 16 metacarpal bone (metacarpal)
 17 phalanx (phalange)
 18-21 pelvis
 18 ilium (hip bone)
 19 ischium
 20 pubis
 21 sacrum
 22-25 leg
 22 femur (thigh bone, thigh)
 23 patella (kneecap)
 24 fibula (splint bone)
 25 tibia (shinbone)
 26-29 foot
 26 tarsal bones (tarsus)
 27 calcaneum (heelbone)
 28 metatarsus
 29 phalanges
 30-41 skull
 30 frontal bone
 31 left parietal bone
 32 occipital bone
 33 temporal bone
 34 external auditory canal
 35 lower jawbone (lower jaw, mandible)
 36 upper jawbone (upper jaw, maxilla)
 37 zygomatic bone (cheekbone)
 38 sphenoid bone (sphenoid)
 39 ethmoid bone (ethmoid)

- 40 lacrimal (lacrimal) bone
 41 nasal bone
 42-55 head [section]
 42 cerebrum (great brain)
 43 pituitary gland (pituitary body, hypophysis cerebri)
 44 corpus callosum
 45 cerebellum (little brain)
 46 pons (pons cerebri, pons cerebelli)
 47 medulla oblongata (brain-stem)
 48 spinal cord
 49 oesophagus (esophagus, gullet)
 50 trachea (windpipe)
 51 epiglottis
 52 tongue
 53 nasal cavity
 54 sphenoidal sinus
 55 frontal sinus
 56-65 organ of equilibrium and hearing
 56-58 external ear
 56 auricle
 57 ear lobe
 58 external auditory canal
 59-61 middle ear
 59 tympanic membrane
 60 tympanic cavity
 61 auditory ossicles: hammer, anvil, and stirrup (malleus, incus, and stapes)
 62-64 inner ear (internal ear)
 62 labyrinth
 63 cochlea
 64 auditory nerve
 65 eustachian tube

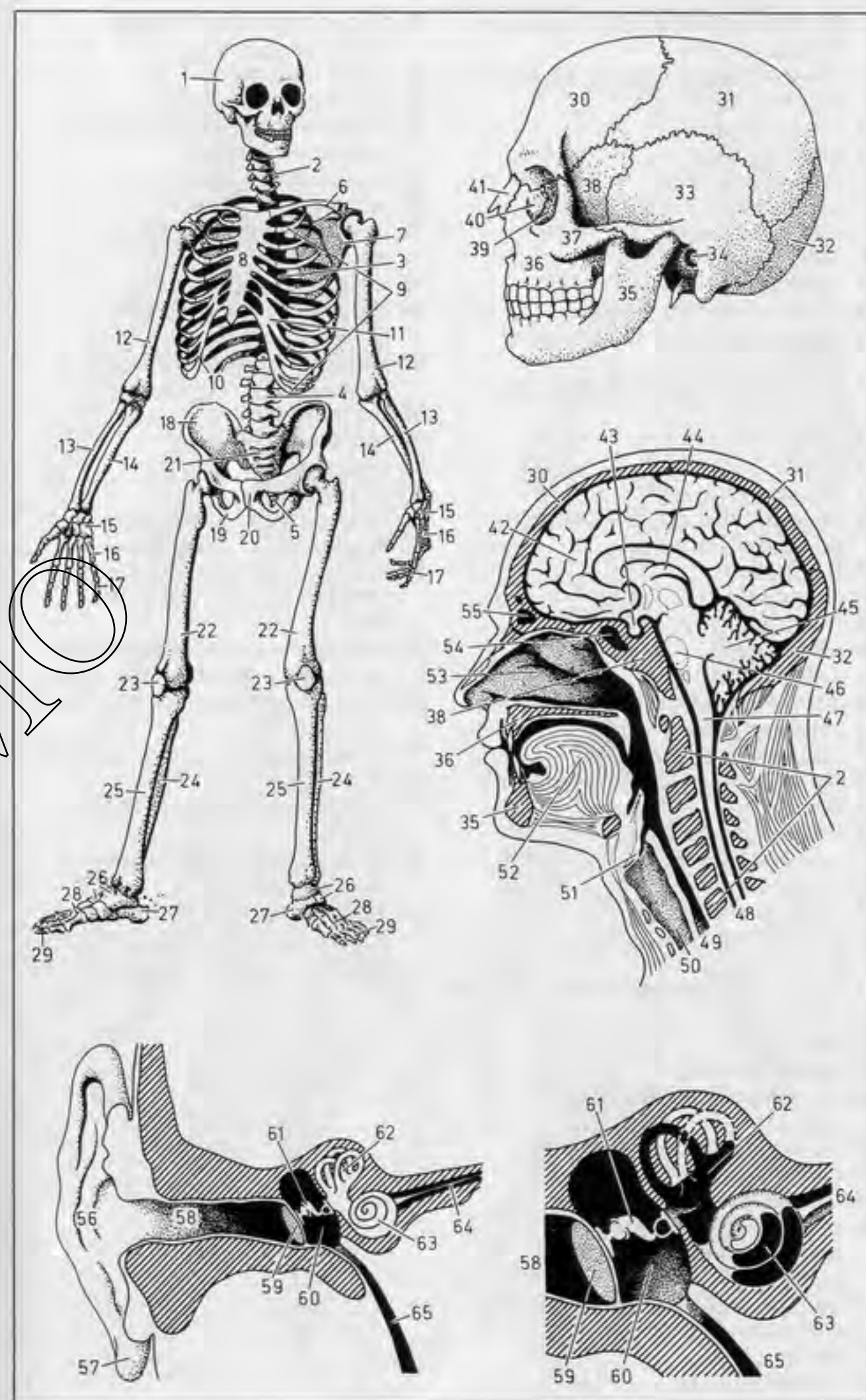

- 1-21 blood circulation** (circulatory system)
- 1 common carotid artery, an artery
 - 2 jugular vein, a vein
 - 3 temporal artery
 - 4 temporal vein
 - 5 frontal artery
 - 6 frontal vein
 - 7 subclavian artery
 - 8 subclavian vein
 - 9 superior vena cava
 - 10 arch of the aorta (aorta)
 - 11 pulmonary artery [with venous blood]
 - 12 pulmonary vein [with arterial blood]
 - 13 lungs
 - 14 heart
 - 15 inferior vena cava
 - 16 abdominal aorta (descending portion of the aorta)
 - 17 iliac artery
 - 18 iliac vein
 - 19 femoral artery
 - 20 tibial artery
 - 21 radial artery
- 22-33 nervous system**
- 22 cerebrum (great brain)
 - 23 cerebellum (little brain)
 - 24 medulla oblongata (brain-stem)
 - 25 spinal cord
 - 26 thoracic nerves
 - 27 brachial plexus
 - 28 radial nerve
 - 29 ulnar nerve
 - 30 great sciatic nerve [lying posteriorly]
 - 31 femoral nerve (anterior crural nerve)
 - 32 tibial nerve
 - 33 peroneal nerve
- 34-64 musculature** (muscular system)
- 34 sternocleidomastoid muscle (sternomastoid muscle)
 - 35 deltoid muscle
 - 36 pectoralis major (greater pectoralis muscle, greater pectoralis)
 - 37 biceps brachii (biceps of the arm)
 - 38 triceps brachii (triceps of the arm)
 - 39 brachioradialis
 - 40 flexor carpi radialis (radial flexor of the wrist)
 - 41 thenar muscle
 - 42 serratus anterior
 - 43 obliquus externus abdominis (external oblique)
 - 44 rectus abdominis
 - 45 sartorius
 - 46 vastus lateralis and vastus medialis
 - 47 tibialis anterior
 - 48 tendo calcaneus (Achilles' tendon)
 - 49 abductor hallucis (abductor of the hallux), a foot muscle
 - 50 occipitalis
 - 51 splenius of the neck
 - 52 trapezius
 - 53 infraspinatus
 - 54 teres minor (lesser teres)
 - 55 teres major (greater teres)
 - 56 extensor carpi radialis longus (long radial extensor of the wrist)
 - 57 extensor communis digitorum (common extensor of the digits)
 - 58 flexor carpi ulnaris (ulnar flexor of the wrist)
 - 59 latissimus dorsi
 - 60 gluteus maximus
 - 61 biceps femoris (biceps of the thigh)
 - 62 gastrocnemius, medial and lateral heads
 - 63 extensor communis digitorum (common extensor of the digits)
 - 64 peroneus longus (long peroneus)

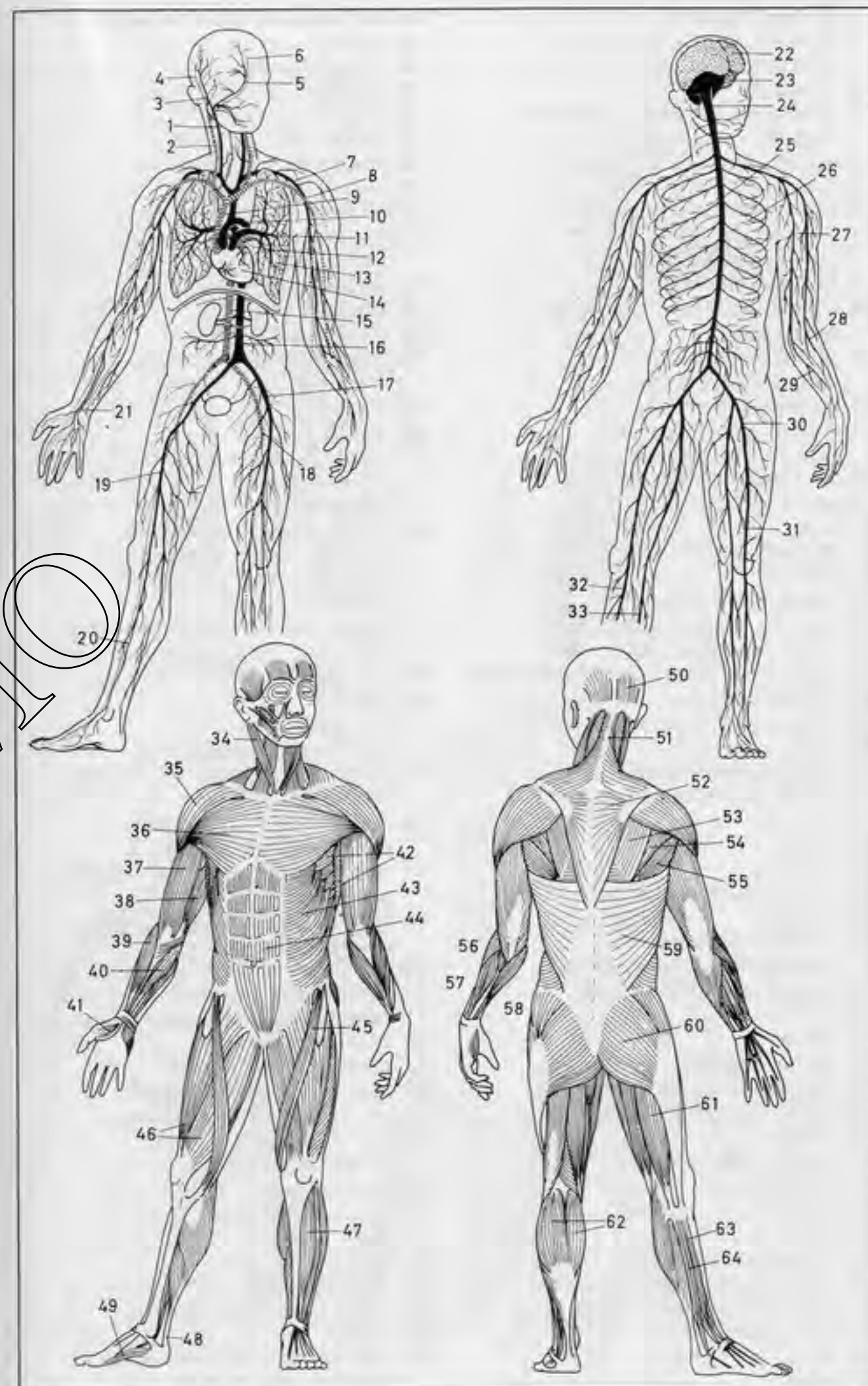

1-13 head and neck

- 1 sternocleidomastoid muscle (sternomastoid muscle)
- 2 occipitalis
- 3 temporalis (temporal, temporal muscle)
- 4 occipito frontalis (frontalis)
- 5 orbicularis oculi
- 6 muscles of facial expression
- 7 masseter
- 8 orbicularis oris
- 9 parotid gland
- 10 lymph node (submandibular lymph gland)
- 11 submandibular gland (submaxillary gland)
- 12 muscles of the neck
- 13 Adam's apple (laryngeal prominence) [in men only]
- 14-37 mouth and throat
- 14 upper lip
- 15 gum
- 16-18 teeth (set of teeth)
- 16 incisors
- 17 canine tooth (canine)
- 18 premolar (bicuspid) and molar teeth (premolars and molars)
- 19 angle of the mouth (labial commissure)
- 20 hard palate
- 21 soft palate (velum palati, velum)
- 22 uvula
- 23 palatine tonsil (tonsil)
- 24 pharyngeal opening (pharynx, throat)
- 25 tongue
- 26 lower lip
- 27 upper jaw (maxilla)
- 28-37 tooth
- 28 periodontal membrane (periodontium, pericementum)
- 29 cement (dental cementum, crusta petrosa)
- 30 enamel
- 31 dentine (dentin)
- 32 dental pulp (tooth pulp, pulp)
- 33 nerves and blood vessels
- 34 incisor
- 35 molar tooth (molar)
- 36 root (fang)
- 37 crown
- 38-51 eye
- 38 eyebrow (supercilium)
- 39 upper eyelid (upper palpebra)
- 40 lower eyelid (lower palpebra)
- 41 eyelash (cilium)
- 42 iris
- 43 pupil

- 44 eye muscles (ocular muscles)
- 45 eyeball
- 46 vitreous body
- 47 cornea
- 48 lens
- 49 retina
- 50 blind spot
- 51 optic nerve
- 52-63 foot
- 52 big toe (great toe, first toe, hallux, digitus I)
- 53 second toe (digitus II)
- 54 third toe (digitus III)
- 55 fourth toe (digitus IV)
- 56 little toe (digitus minimus, digitus V)
- 57 toenail
- 58 ball of the foot
- 59 lateral malleolus (external malleolus, outer malleolus, malleolus fibulae)
- 60 medial malleolus (internal malleolus, inner malleolus, malleolus tibiae, malleolus medialis)
- 61 instep (medial longitudinal arch, dorsum of the foot, dorsum pedis)
- 62 sole of the foot
- 63 heel
- 64-83 hand
- 64 thumb (pollex, digitus I)
- 65 index finger (forefinger, second finger, digitus II)
- 66 middle finger (third finger, digitus medius, digitus III)
- 67 ring finger (fourth finger, digitus anularis, digitus IV)
- 68 little finger (fifth finger, digitus minimus, digitus V)
- 69 radial side of the hand
- 70 ulnar side of the hand
- 71 palm of the hand (palma manus)
- 72-74 lines of the hand
- 72 life line (line of life)
- 73 head line (line of the head)
- 74 heart line (line of the heart)
- 75 ball of the thumb (thenar eminence)
- 76 wrist (carpus)
- 77 phalanx (phalange)
- 78 finger pad
- 79 fingertip
- 80 fingernail (nail)
- 81 lunule (lunula) of the nail
- 82 knuckle
- 83 back of the hand (dorsum of the hand, dorsum manus)

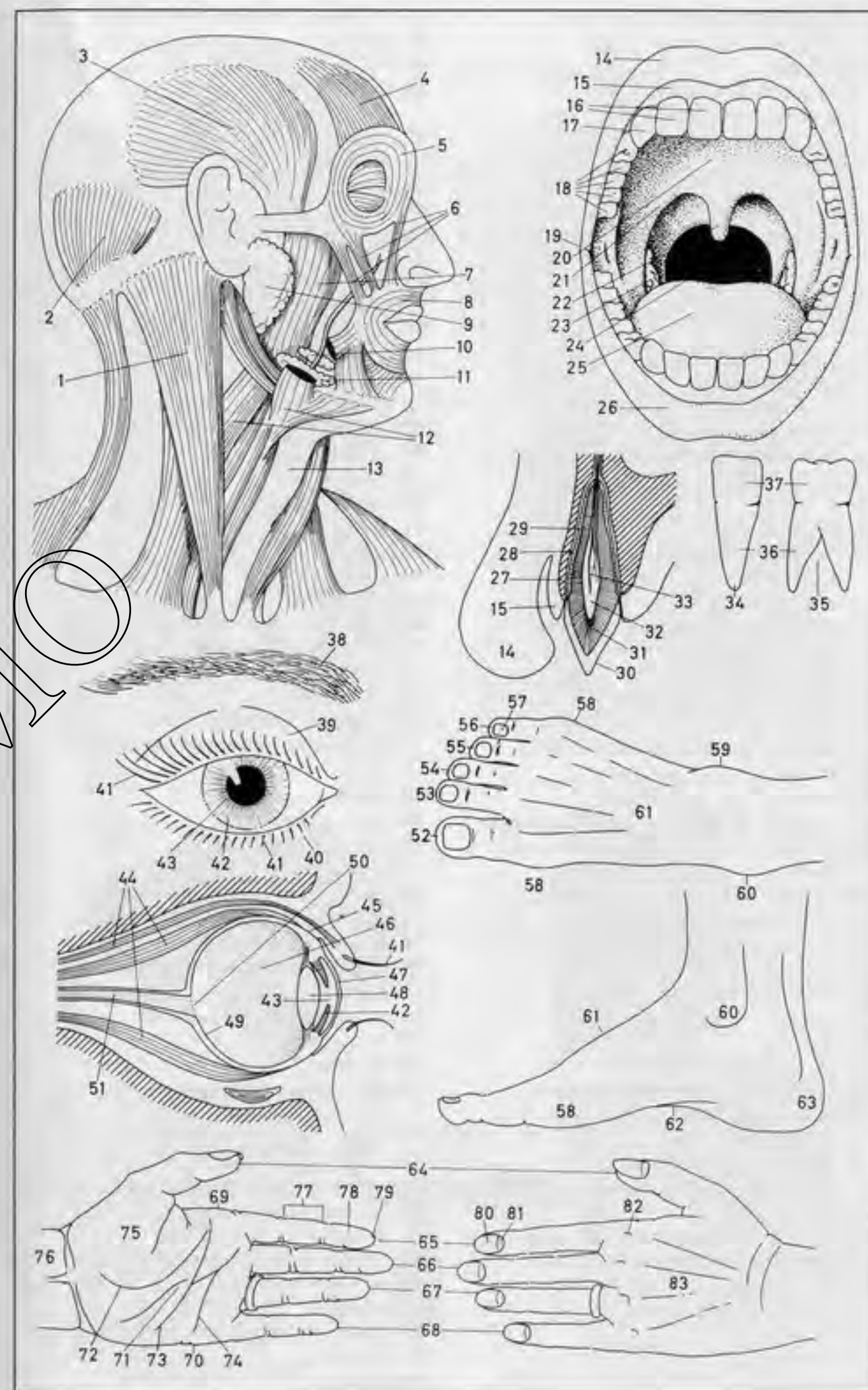

1-57 internal organs [front view]

- 1 thyroid gland
- 2-3 larynx
- 2 hyoid bone (hyoid)
- 3 thyroid cartilage
- 4 trachea (windpipe)
- 5 bronchus
- 6-7 lung
- 6 right lung
- 7 upper pulmonary lobe (upper lobe of the lung) [section]
- 8 heart
- 9 diaphragm
- 10 liver
- 11 gall bladder
- 12 spleen
- 13 stomach
- 14-22 intestines (bowel)
- 14-16 small intestine (intestinum tenue)
- 14 duodenum
- 15 jejunum
- 16 ileum
- 17-22 large intestine (intestinum crassum)
- 17 caecum (cecum)
- 18 appendix (vermiform appendix)
- 19 ascending colon
- 20 transverse colon
- 21 descending colon
- 22 rectum
- 23 oesophagus (esophagus, gullet)
- 24-25 heart
- 24 auricle
- 25 anterior longitudinal cardiac sulcus
- 26 diaphragm
- 27 spleen
- 28 right kidney
- 29 suprarenal gland
- 30-31 left kidney [longitudinal section]
- 30 calyx (renal calyx)
- 31 renal pelvis
- 32 ureter
- 33 bladder
- 34-35 liver [from behind]
- 34 falciform ligament of the liver
- 35 lobe of the liver
- 36 gall bladder
- 37-38 common bile duct
- 37 hepatic duct (common hepatic duct)
- 38 cystic duct
- 39 portal vein (hepatic portal vein)
- 40 oesophagus (esophagus, gullet)
- 41-42 stomach
- 41 cardiac orifice
- 42 pylorus
- 43 duodenum
- 44 pancreas

45-57 heart (longitudinal section)

- 45 atrium
- 46-47 valves of the heart
- 46 tricuspid valve (right atrioventricular valve)
- 47 bicuspid valve (mitral valve, left atrioventricular valve)
- 48 cusp
- 49 aortic valve
- 50 pulmonary valve
- 51 ventricle
- 52 ventricular septum (interventricular septum)
- 53 superior vena cava
- 54 aorta
- 55 pulmonary artery
- 56 pulmonary vein
- 57 inferior vena cava
- 58 peritoneum
- 59 sacrum
- 60 coccyx (coccygeal vertebra)
- 61 rectum
- 62 anus
- 63 anal sphincter
- 64 perineum
- 65 pubic symphysis (symphysis pubis)

66-77 male sex organs [longitudinal section]

- 66 penis
- 67 corpus cavernosum and spongiosum of the penis (erectile tissue of the penis)
- 68 urethra
- 69 glans penis
- 70 prepuce (foreskin)
- 71 scrotum
- 72 right testicle (testis)
- 73 epididymis
- 74 spermatic duct (vas deferens)
- 75 Cowper's gland (bulbourethral gland)
- 76 prostate (prostate gland)
- 77 seminal vesicle
- 78 bladder

79-88 female sex organs [longitudinal section]

- 79 uterus (matrix, womb)
- 80 cavity of the uterus
- 81 fallopian tube (uterine tube, oviduct)
- 82 fimbria (fimbriated extremity)
- 83 ovary
- 84 follicle with ovum (egg)
- 85 os uteri externum
- 86 vagina
- 87 lip of the pudendum (lip of the vulva)
- 88 clitoris

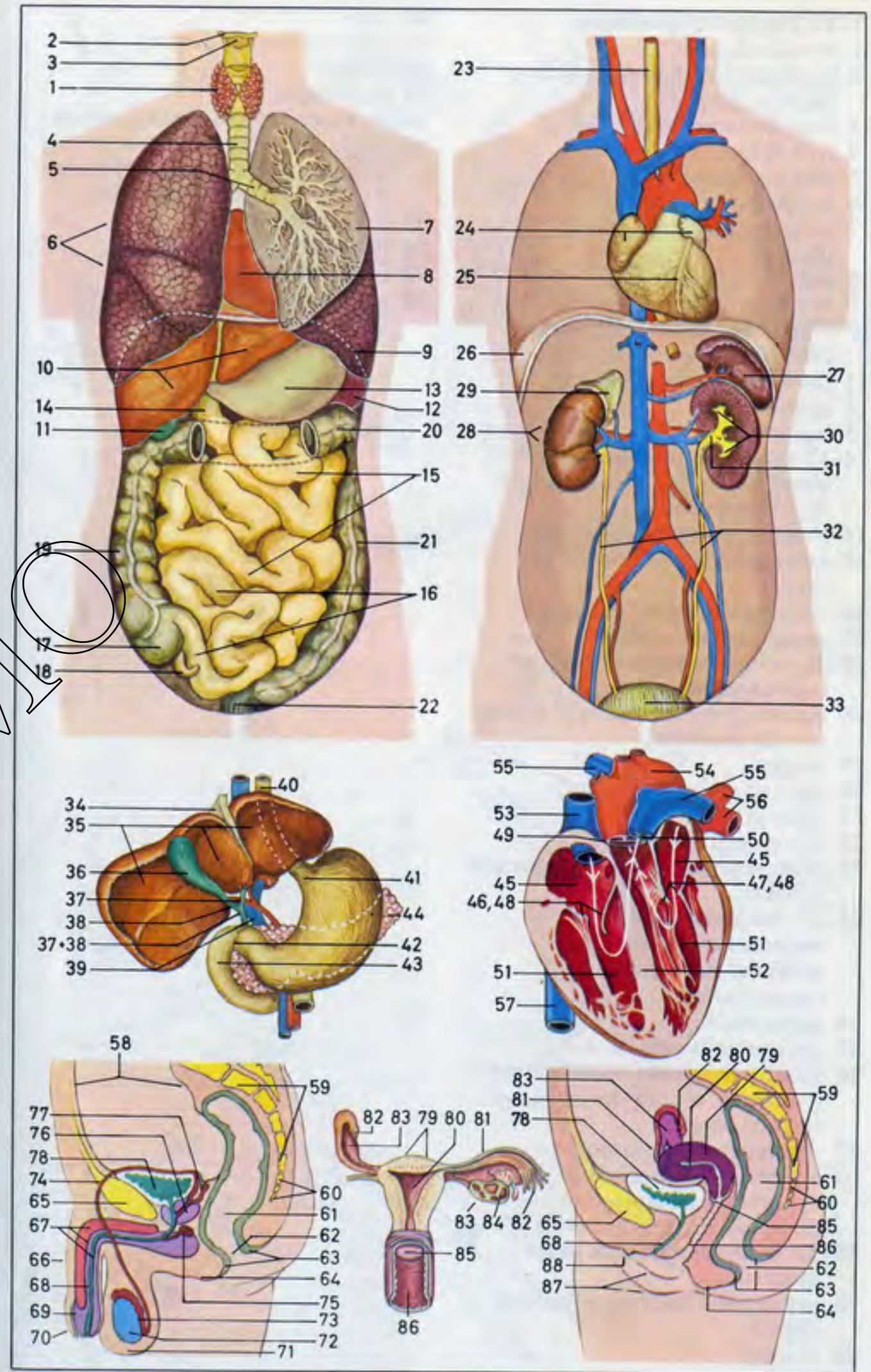

- 1-13 emergency bandages
 1 arm bandage
 2 triangular cloth used as a sling (an arm sling)
 3 head bandage (capeline)
 4 first aid kit
 5 first aid dressing
 6 sterile gauze dressing
 7 adhesive plaster (sticking plaster)
 8 wound
 9 bandage
 10 emergency splint for a broken limb (fractured limb)
 11 fractured leg (broken leg)
 12 splint
 13 headrest
 14-17 measures for stanching the blood flow (tying up of, ligature of, a blood vessel)
 14 pressure points of the arteries
 15 emergency tourniquet on the thigh
 16 walking stick used as a screw
 17 compression bandage
 18-23 rescue and transport of an injured person
 18 Rautek grip (for rescue of victim of a car accident)
 19 helper
 20 injured person (casualty)
 21 chair grip
 22 carrying grip
 23 emergency stretcher of sticks and a jacket
 24-27 the positioning of an unconscious person and artificial respiration (resuscitation)
 24 coma position
 25 unconscious person
 26 mouth-to-mouth resuscitation (variation: mouth-to-nose resuscitation)
 27 resuscitator (respiratory apparatus, resuscitation apparatus), a respirator (artificial breathing device)
 28-33 methods of rescue in ice accidents
 28 person who has fallen through the ice
 29 rescuer
 30 rope
 31 table (or similar device)
 32 ladder
 33 self-rescue
 34-38 rescue of a drowning person
 34 method of release (release grip, release) to free rescuer from the clutch of a drowning person
 35 drowning person
 36 lifesaver
 37 chest grip, a towing grip
 38 tired swimmer grip (hip grip)

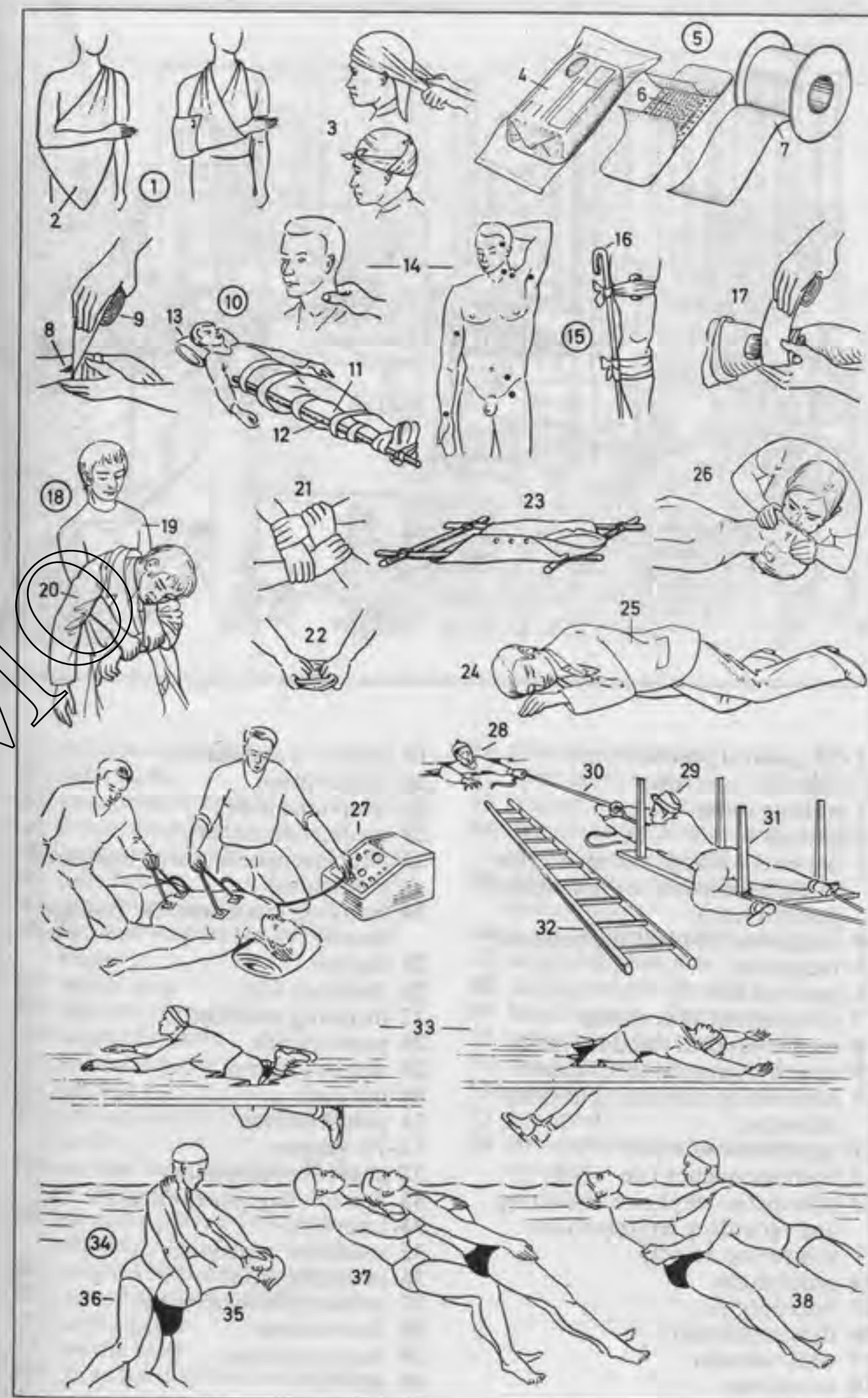

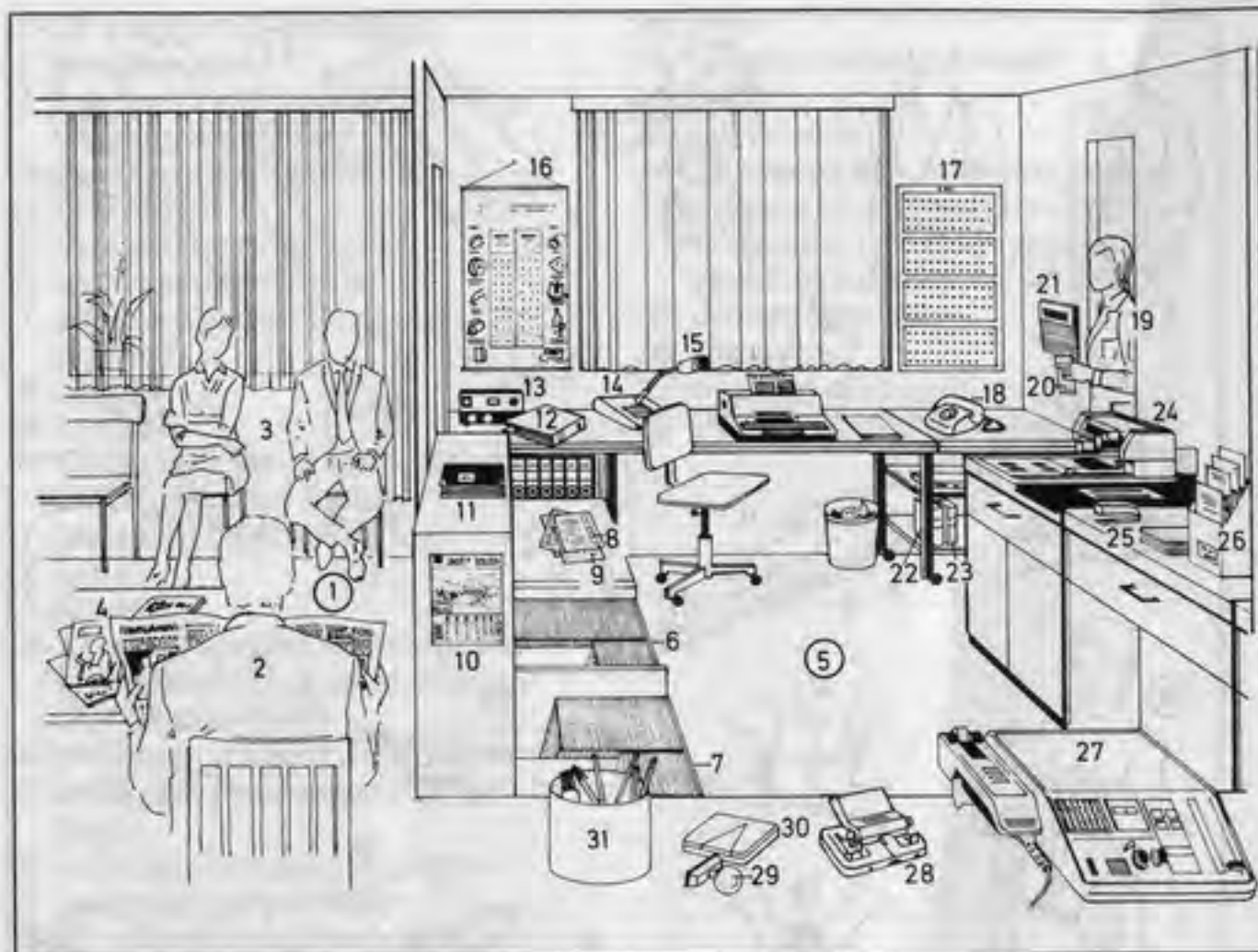

1-74 general practice (Am. physician's office)

- 1 waiting room
- 2 patient
- 3 patients with appointments (for a routine checkup or renewal of prescription)
- 4 magazines [for waiting patients]
- 5 reception
- 6 patients file
- 7 eliminated index cards
- 8 medical record (medical card)
- 9 health insurance certificate
- 10 advertising calendar (publicity calendar)
- 11 appointments book
- 12 correspondence file
- 13 automatic telephone answering and recording set (telephone answering device)
- 14 radiophone
- 15 microphone
- 16 illustrated chart
- 17 wall calendar
- 18 telephone

- 19 [doctor's] assistant
- 20 prescription
- 21 telephone index
- 22 medical dictionary
- 23 pharmacopoeia (list of registered medicines)
- 24 franking machine (Am. postage meter)
- 25 stapler
- 26 diabetics file
- 27 dictating machine
- 28 paper punch
- 29 doctor's stamp
- 30 ink pad
- 31 pencil holder
- 32-74 surgery**
- 32 chart of eyegrounds
- 33 doctor's bag (doctor's case)
- 34 intercom
- 35 medicine cupboard
- 36 swab dispenser
- 37 inflator (Poltzer bag)
- 38 electrotome
- 39 steam sterilizer
- 40 cabinet

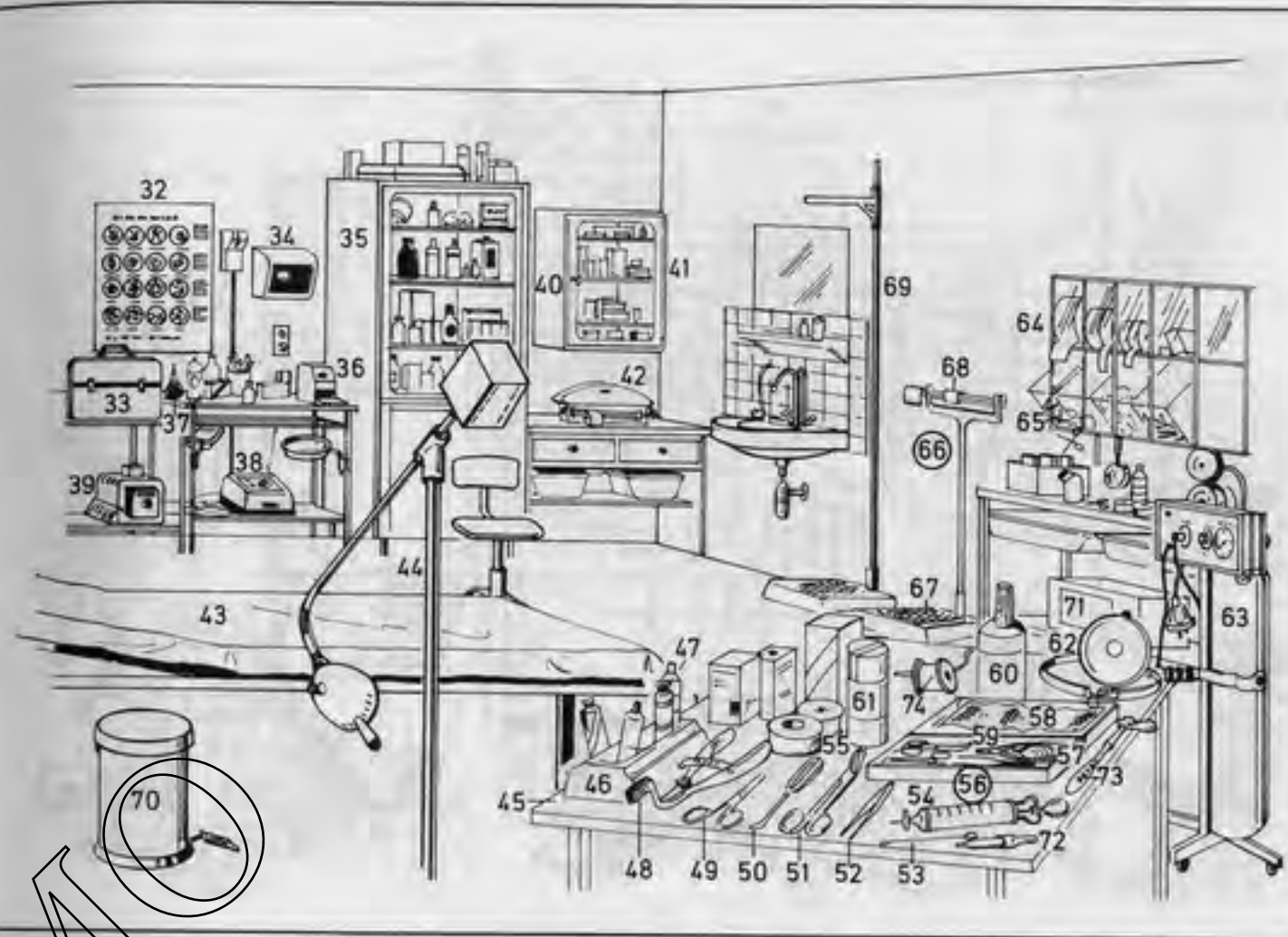

- 41 medicine samples
- 42 baby scales
- 43 examination couch
- 44 directional lamp
- 45 instrument table
- 46 tube holder
- 47 tube of ointment
- 48-50 instruments for minor surgery**
- 48 mouth gag
- 49 Kocher's forceps
- 50 scoop (curette)
- 51 angled scissors
- 52 forceps
- 53 olive-pointed (bulb-headed) probe
- 54 syringe for irrigations of the ear or bladder
- 55 adhesive plaster (sticking plaster)
- 56 surgical suture material
- 57 curved surgical needle
- 58 sterile gauze
- 59 needle holder
- 60 spray for disinfecting the skin

- 61 thread container
- 62 ophthalmoscope
- 63 freezer for cryosurgery
- 64 dispenser for plasters and small pieces of equipment
- 65 disposable hypodermic needles and syringes
- 66 scales, sliding-weight scales
- 67 weighing platform
- 68 sliding weight (jockey)
- 69 height gauge (Am. gage)
- 70 waste bin (Am. trash bin)
- 71 hot-air sterilizer
- 72 pipette
- 73 percussor
- 74 aural speculum (auriscope, aural syringe)

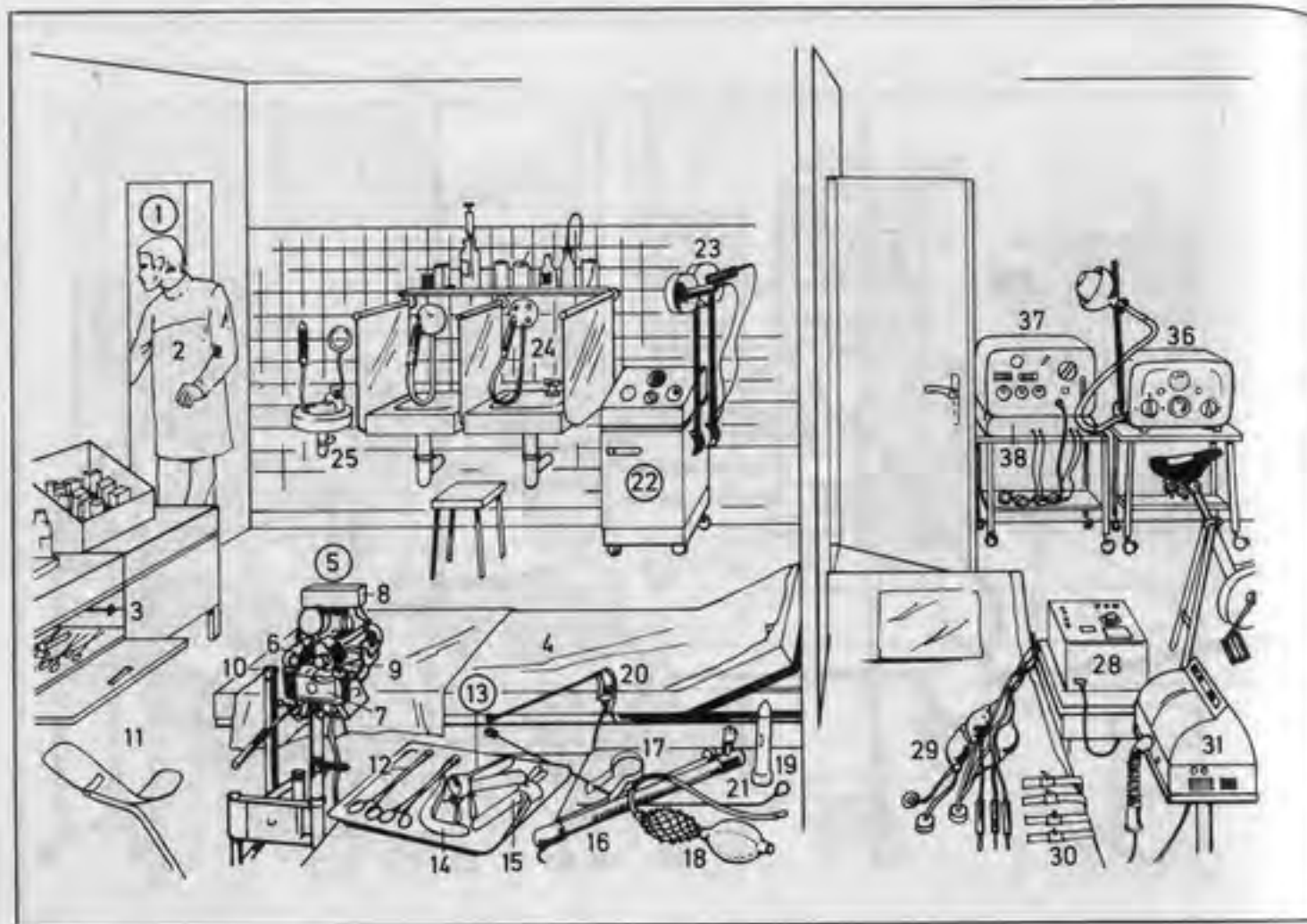

- 1 consulting room
 2 general practitioner
 3-21 instruments for gynecological and proctological examinations
 3 warming the instruments up to body temperature
 4 examination couch
 5 colposcope
 6 binocular eyepiece
 7 miniature camera
 8 cold light source
 9 cable release
 10 bracket for the leg support
 11 leg support (leg holder)
 12 holding forceps (sponge holder)
 13 vaginal speculum
 14 lower blade of the vaginal speculum
 15 platinum loop (for smears)
 16 rectoscope
 17 biopsy forceps used with the rectoscope (proctoscope)
 18 insufflator for proctoscopy (rectoscopy)
 19 proctoscope (rectal speculum)
 20 urethroscope
 21 guide for inserting the proctoscope
 22 diathermy unit (short-wave therapy apparatus)
 23 radiator
 24 inhaling apparatus (inhalator)
 25 basin (for sputum)
 26-31 ergometry
 26 bicycle ergometer
 27 monitor (visual display of the ECG and of pulse and respiratory rates when performing work)
 28 ECG (electrocardiograph)
 29 suction electrodes
 30 strap-on electrodes for the limbs
 31 spirometer (for measuring respiratory functions)
 32 measuring the blood pressure



- 33 sphygmomanometer
 34 inflatable cuff
 35 stethoscope
 36 microwave treatment unit
 37 faradization unit (application of low-frequency currents with different pulse shapes)
 38 automatic tuner
 39 short-wave therapy apparatus
 40 timer
 41-59 laboratory
 41 medical laboratory technician
 42 capillary tube stand for blood sedimentation
 43 measuring cylinder
 44 automatic pipette
 45 kidney dish
 46 portable ECG machine for emergency use
 47 automatic pipetting device
 48 constant temperature water bath
 49 tap with water jet pump
 50 staining dish (for staining blood smears, sediments and other smears)
 51 binocular research microscope
 52 pipette stand for photometry
 53 computer and analyser for photometry
 54 photometer
 55 potentiometric recorder
 56 transforming section
 57 laboratory apparatus (laboratory equipment)
 58 urine sediment chart
 59 centrifuge

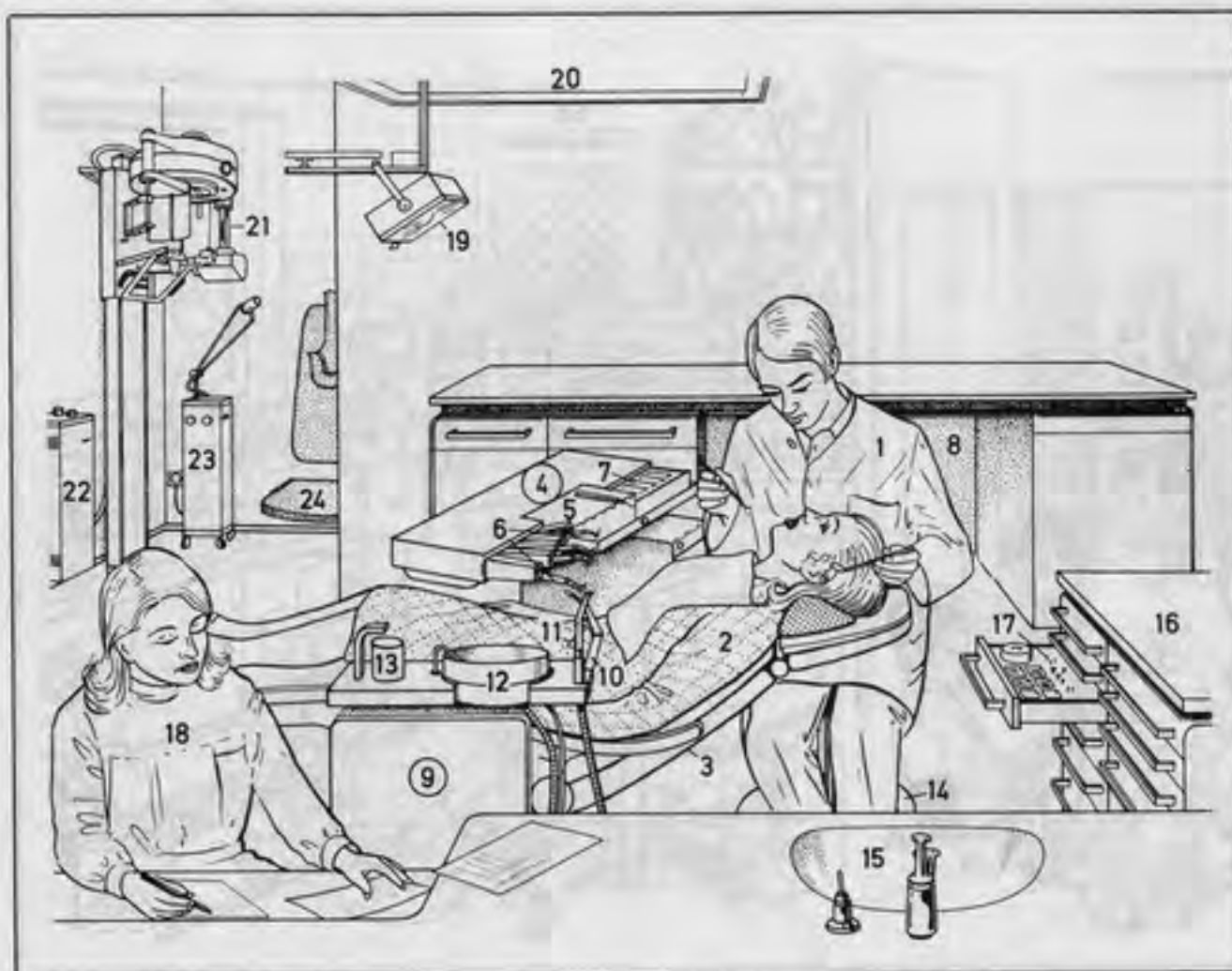

- | | |
|--|---|
| 1 dentist (dental surgeon) | 22 X-ray generator |
| 2 patient | 23 microwave treatment unit, a radiation unit |
| 3 dentist's chair | 24 seat |
| 4 dental instruments | 25 denture (set of false teeth) |
| 5 instrument tray | 26 bridge (dental bridge) |
| 6 drills with different handpieces | 27 prepared stump of the tooth |
| 7 medicine case | 28 crown (kinds: gold crown, jacket crown) |
| 8 storage unit (for dental instruments) | 29 porcelain tooth (porcelain pontic) |
| 9 assistant's unit | 30 filling |
| 10 multi-purpose syringe (for cold and warm water, spray or air) | 31 post crown |
| 11 suction apparatus | 32 facing |
| 12 basin | 33 diaphragm |
| 13 water glass, filled automatically | 34 post |
| 14 stool | 35 carborundum disc (disk) |
| 15 washbasin | 36 grinding wheel |
| 16 instrument cabinet | 37 burs |
| 17 drawer for drills | 38 flame-shaped finishing bur |
| 18 dentist's assistant | 39 fissure burs |
| 19 dentist's lamp | 40 diamond point |
| 20 ceiling light | 41 mouth mirror |
| 21 X-ray apparatus for panoramic pictures | 42 mouth lamp |

- | |
|--|
| 43 cautery |
| 44 platinum-iridium electrode |
| 45 tooth scalers |
| 46 probe |
| 47 extraction forceps |
| 48 tooth-root elevator |
| 49 bone chisel |
| 50 spatula |
| 51 mixer for filling material |
| 52 synchronous timer |
| 53 hypodermic syringe for injection of local anaesthetic |
| 54 hypodermic needle |
| 55 matrix holder |
| 56 impression tray |
| 57 spirit lamp |

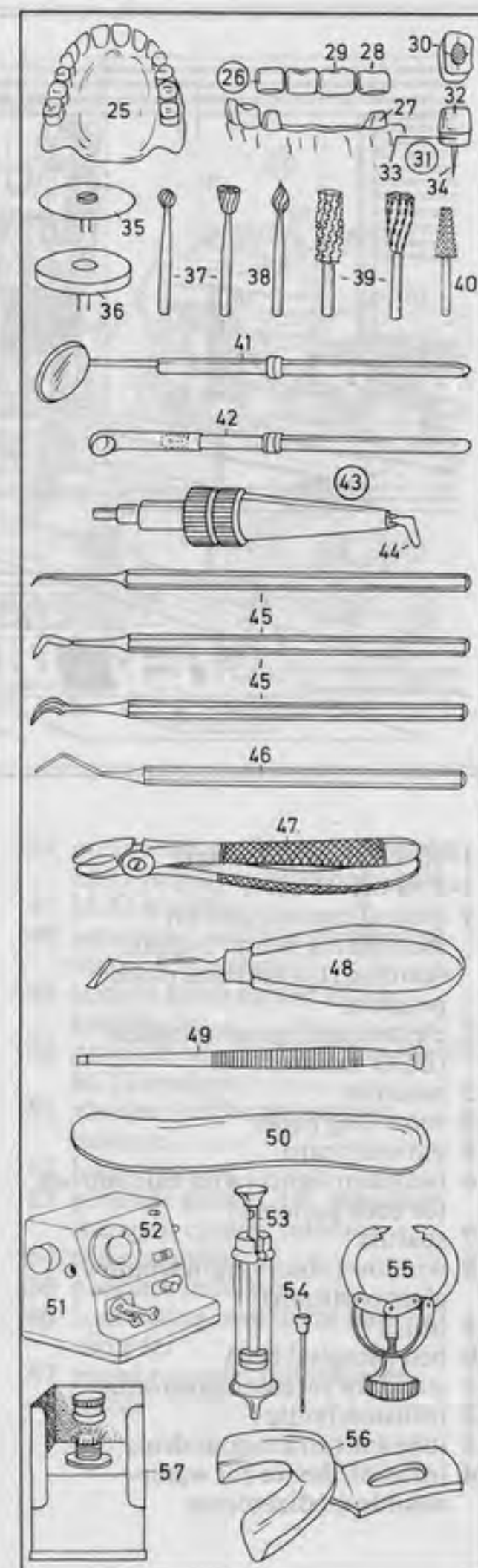

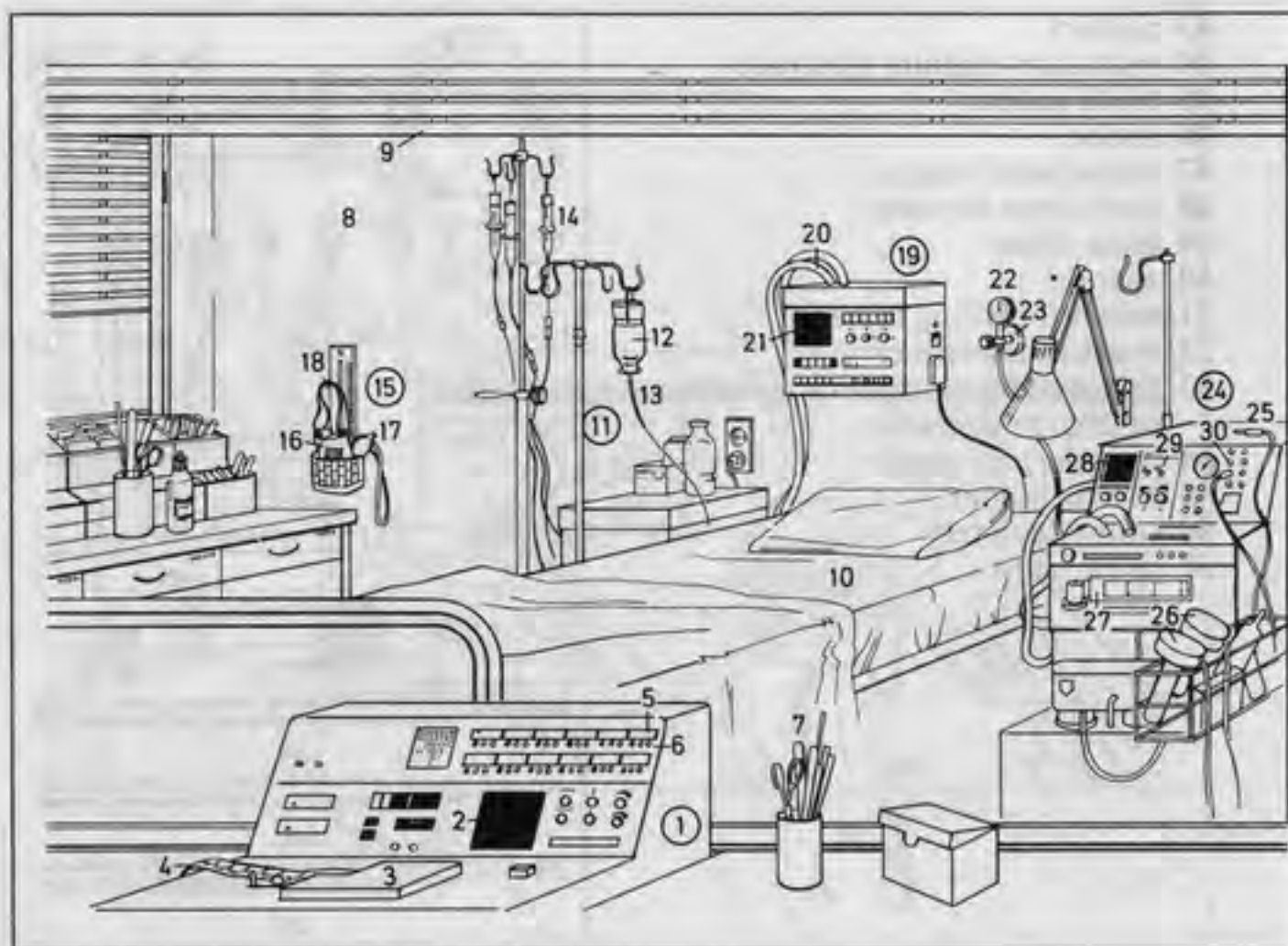
**1-30 intensive care unit****1-9 control room**

- 1 central control unit for monitoring heart rhythm (cardiac rhythm) and blood pressure
- 2 electrocardiogram monitor (ECG monitor)
- 3 recorder
- 4 recording paper
- 5 patient's card
- 6 indicator lights (with call buttons for each patient)
- 7 spatula
- 8 window (observation window, glass partition)
- 9 blind
- 10 bed (hospital bed)
- 11 stand for infusion apparatus
- 12 infusion bottle
- 13 tube for intravenous drips
- 14 infusion device for water-soluble medicaments
- 15 sphygmomanometer
- 16 cuff
- 17 inflating bulb
- 18 mercury manometer
- 19 bed monitor
- 20 connecting lead to the central control unit
- 21 electrocardiogram monitor (ECG monitor)
- 22 manometer for the oxygen supply
- 23 wall connection for oxygen treatment
- 24 mobile monitoring unit
- 25 electrode lead to the short-term pacemaker
- 26 electrodes for shock treatment
- 27 ECG recording unit
- 28 electrocardiogram monitor (ECG monitor)
- 29 control switches and knobs (controls) for adjusting the monitor

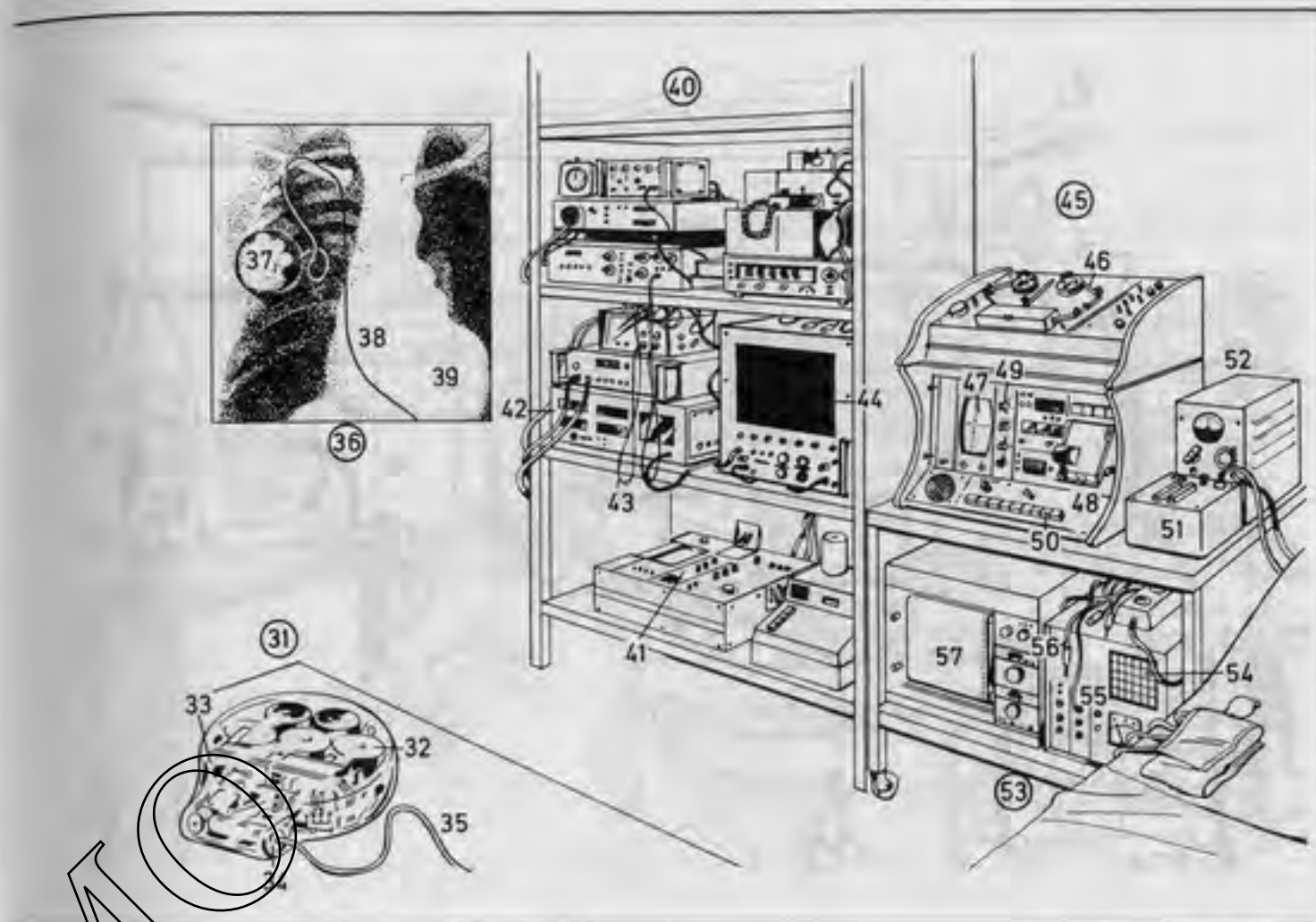

- 30 control buttons for the pacemaker unit
- 31 **pacemaker** (cardiac pacemaker)
- 32 mercury battery
- 33 programmed impulse generator
- 34 electrode exit point
- 35 electrode
- 36 implantation of the pacemaker
- 37 internal cardiac pacemaker (internal pacemaker, pacemaker)
- 38 electrode inserted through the vein
- 39 cardiac silhouette on the X-ray
- 40 **pacemaker control unit**
- 41 electrocardiograph (ECG recorder)
- 42 automatic impulse meter
- 43 ECG lead to the patient
- 44 monitor unit for visual monitoring of the pacemaker impulses
- 45 long-term ECG analyser

- 46 magnetic tape for recording the ECG impulses during analysis
- 47 ECG monitor
- 48 automatic analysis on paper of the ECG rhythm
- 49 control knob for the ECG amplitude
- 50 program selector switches for the ECG analysis
- 51 charger for the pacemaker batteries
- 52 battery tester
- 53 pressure gauge (*Am. gage*) for the right cardiac catheter
- 54 trace monitor
- 55 pressure indicator
- 56 connecting lead to the paper recorder
- 57 paper recorder for pressure traces

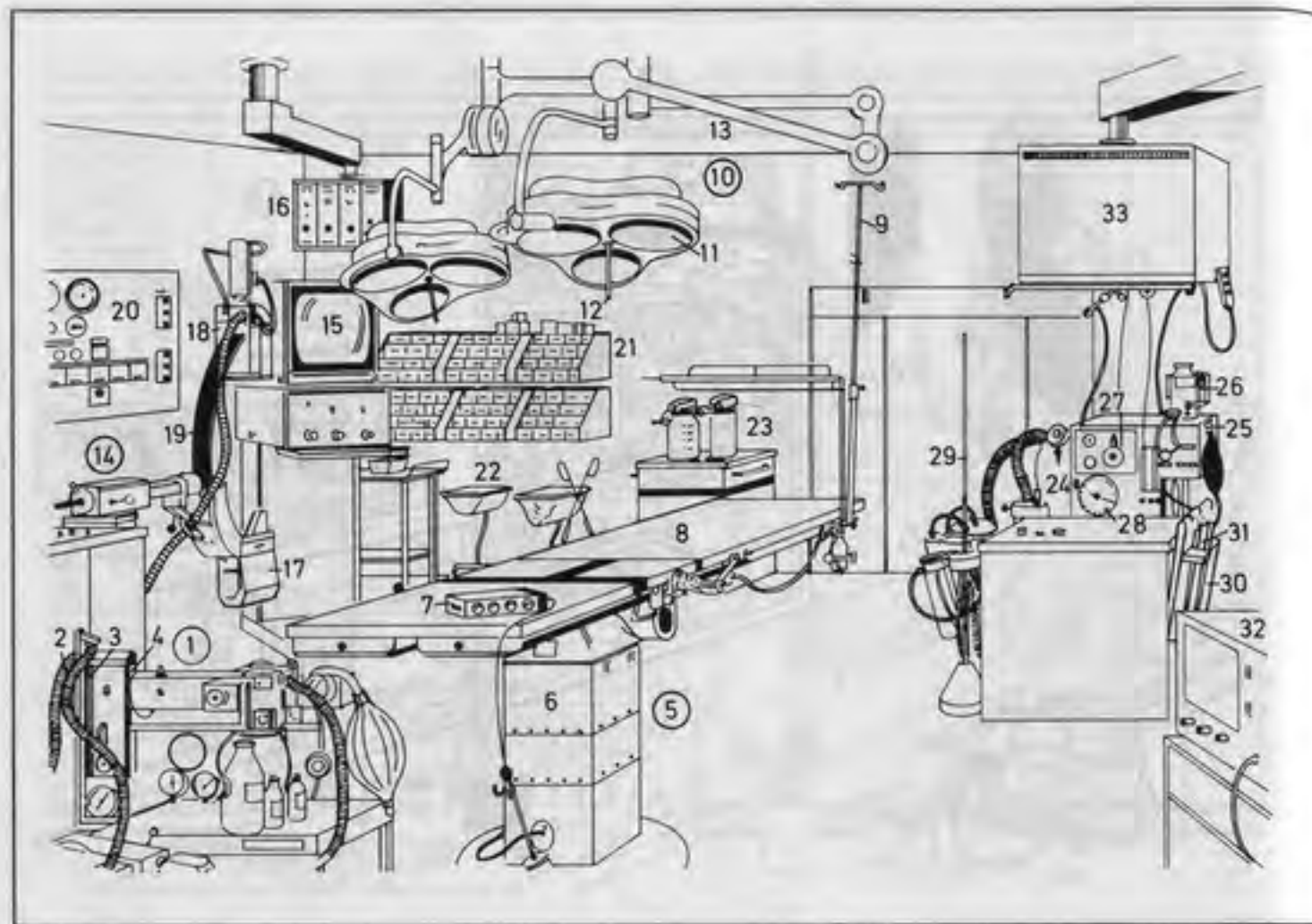
**1-54 surgical unit****1-33 operating theatre (Am. theater)**

- 1 anaesthesia and breathing apparatus (respiratory machine)
- 2 inhalers (inhaling tubes)
- 3 flowmeter for nitrous oxide
- 4 oxygen flow meter
- 5 pedestal operating table
- 6 table pedestal
- 7 control device (control unit)
- 8 adjustable top of the operating table
- 9 stand for intravenous drips
- 10 swivel-mounted shadow-free operating lamp
- 11 individual lamp
- 12 handle
- 13 swivel arm
- 14 mobile fluoroscope
- 15 monitor of the image converter
- 16 monitor [back]
- 17 tube
- 18 image converter
- 19 C-shaped frame
- 20 control panel for the air-conditioning
- 21 surgical suture material
- 22 mobile waste tray
- 23 containers for unsterile (unsterilized) pads
- 24 anaesthesia and respiratory apparatus
- 25 respirator
- 26 fluothane container (halothane container)
- 27 ventilation control knob
- 28 indicator with pointer for respiratory volume
- 29 stand with inhalers (inhaling tubes) and pressure gauges (Am. gages)
- 30 catheter holder
- 31 catheter in sterile packing

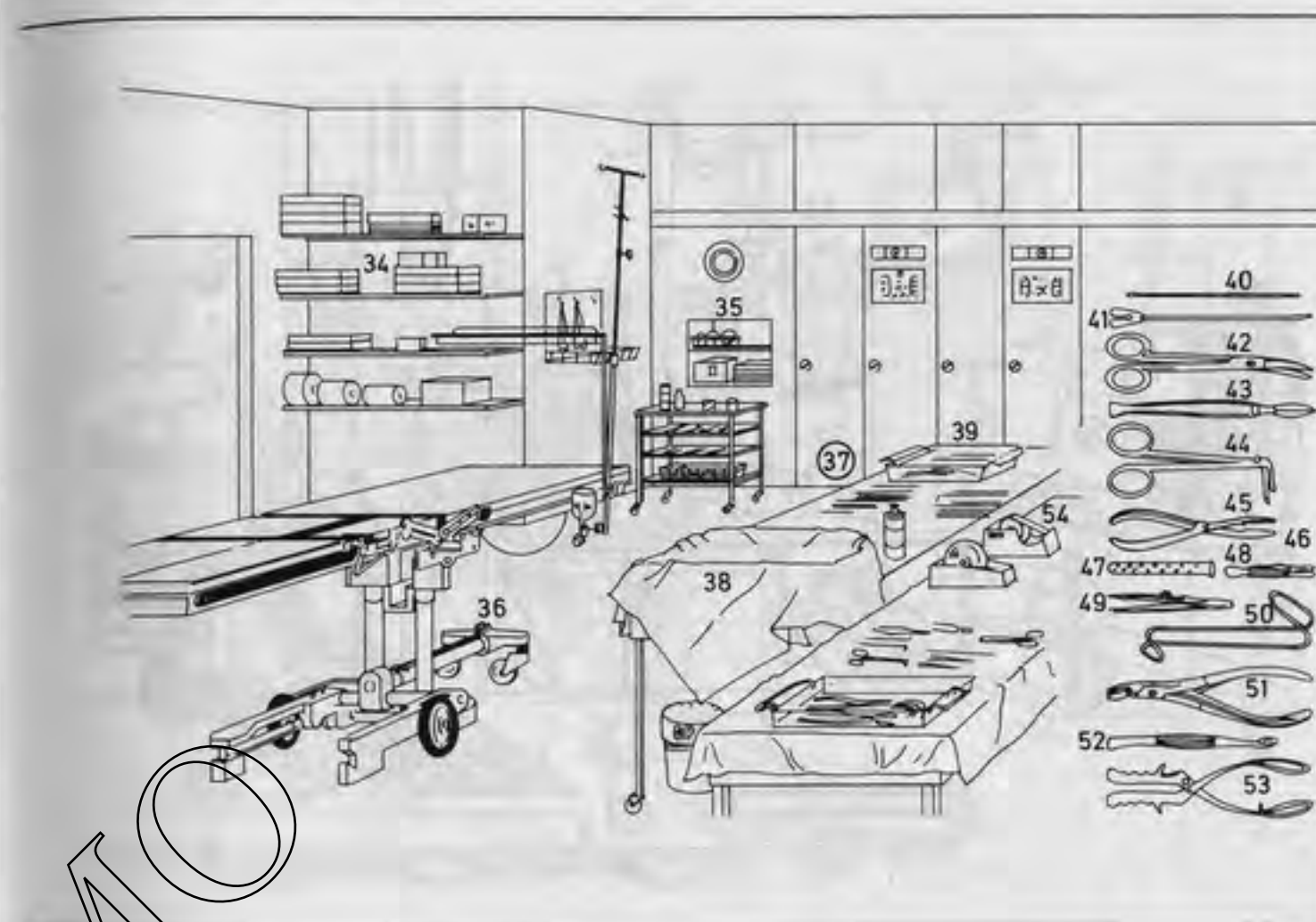
**32 sphygmograph****33 monitor****34-54 preparation and sterilization room**

- 34 dressing material
- 35 small sterilizer
- 36 carriage of the operating table
- 37 mobile instrument table
- 38 sterile cloth
- 39 instrument tray
- 40-53 surgical instruments**
- 40 olive-pointed (bulb-headed) probe
- 41 hollow probe
- 42 curved scissors
- 43 scalpel (surgical knife)
- 44 ligature-holding forceps
- 45 sequestrum forceps
- 46 jaw
- 47 drainage tube
- 48 surgeon's tourniquet
- 49 artery forceps

50 blunt hook**51 bone nippers (bone-cutting forceps)****52 scoop (curette) for erosion (curettage)****53 obstetrical forceps****54 roll of plaster**

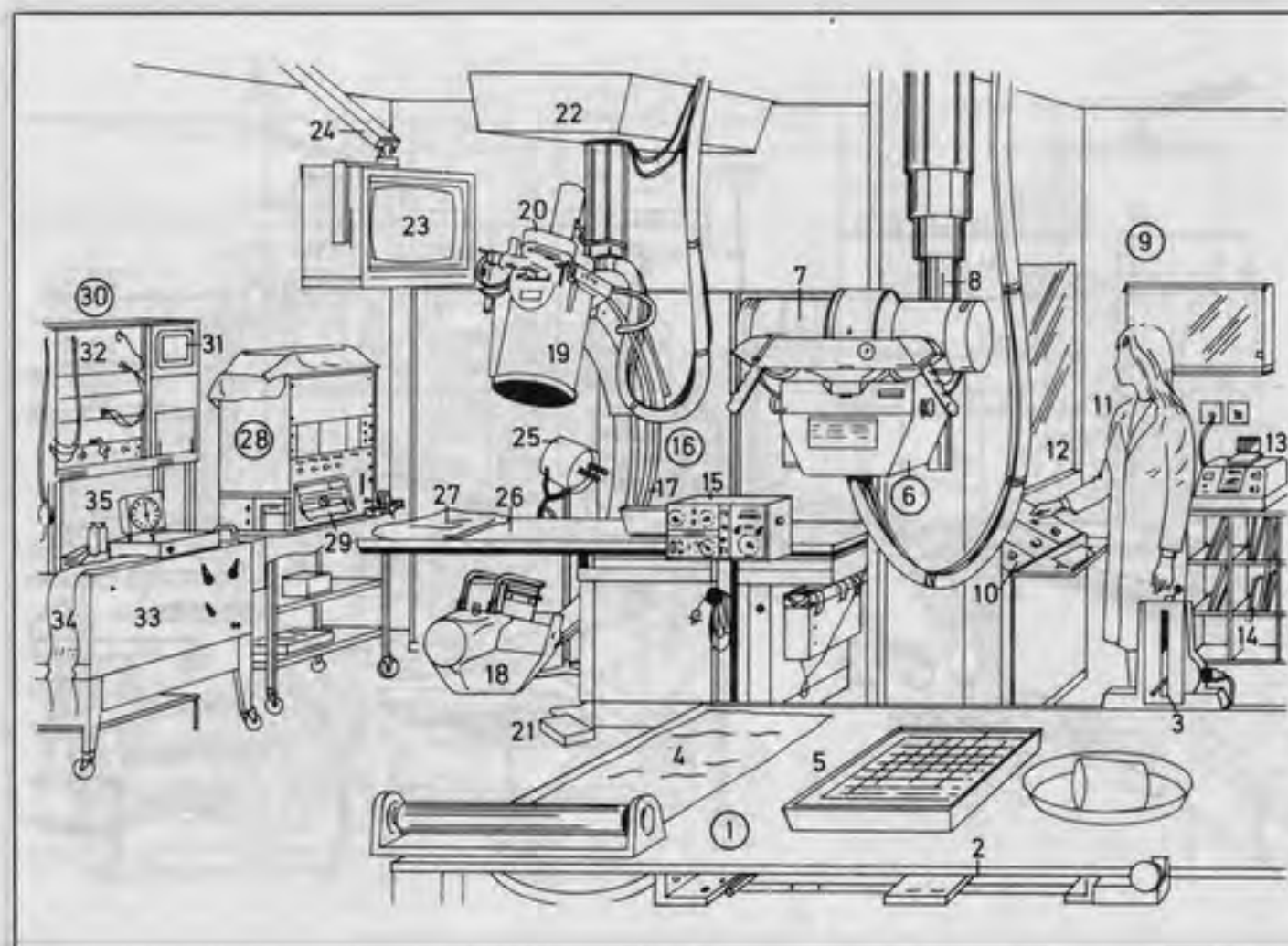
**1-35 X-ray unit**

- 1 X-ray examination table
- 2 support for X-ray cassettes
- 3 height adjustment of the central beam for lateral views
- 4 compress for pyelography and cholecystography
- 5 instrument basin
- 6 X-ray apparatus for pyelograms
- 7 X-ray tube
- 8 telescopic X-ray support
- 9 central X-ray control unit
- 10 control panel (control desk)
- 11 radiographer (X-ray technician)
- 12 window to the angiography room
- 13 oxymeter
- 14 pyelogram cassettes
- 15 contrast medium injector
- 16 X-ray image intensifier
- 17 C-shaped frame
- 18 X-ray head with X-ray tube
- 19 image converter with converter tube
- 20 film camera
- 21 foot switch
- 22 mobile mounting
- 23 monitor
- 24 swivel-mounted monitor support
- 25 operating lamp
- 26 angiographic examination table
- 27 pillow
- 28 eight-channel recorder
- 29 recording paper
- 30 catheter gauge (*Am. gage*) unit for catheterization of the heart
- 31 six-channel monitor for pressure graphs and ECG
- 32 slide-in units of the pressure transducer
- 33 paper recorder unit with developer for photographic recording
- 34 recording paper
- 35 timer

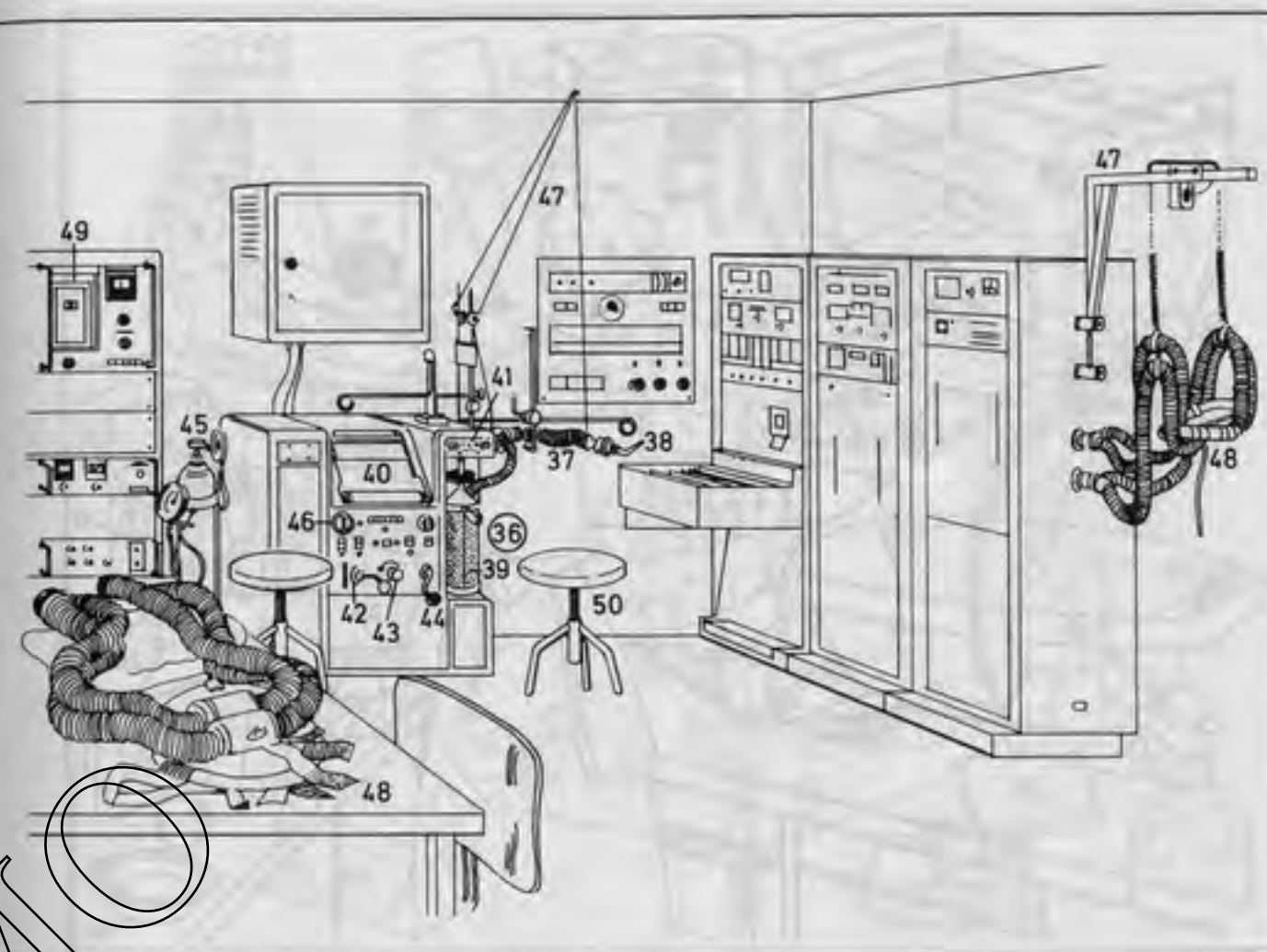
**36-50 spirometry**

- 36 spirometer for pulmonary function tests
- 37 breathing tube
- 38 mouthpiece
- 39 soda-lime absorber
- 40 recording paper
- 41 control knobs for gas supply
- 42 O₂-stabilizer
- 43 throttle valve
- 44 absorber attachment
- 45 oxygen cylinder
- 46 water supply
- 47 tube support
- 48 mask
- 49 CO₂ consumption meter
- 50 stool for the patient

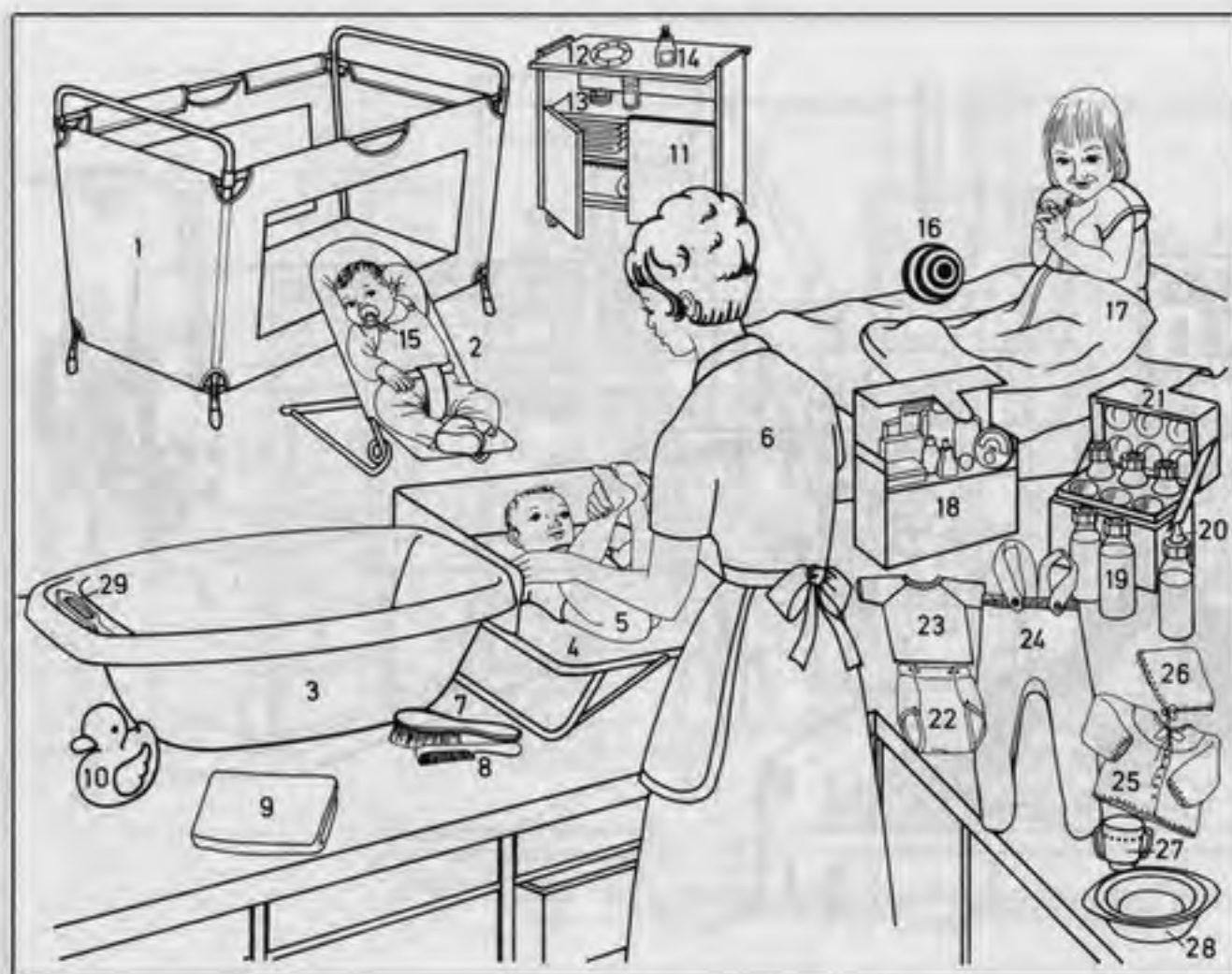

- 1 collapsible cot
- 2 bouncing cradle
- 3 baby bath
- 4 changing top
- 5 baby (new-born baby)
- 6 mother
- 7 hairbrush
- 8 comb
- 9 hand towel
- 10 toy duck
- 11 changing unit
- 12 teething ring
- 13 cream jar
- 14 box of baby powder
- 15 dummy
- 16 ball
- 17 sleeping bag
- 18 layette box
- 19 feeding bottle
- 20 teat
- 21 bottle warmer
- 22 rubber baby pants for disposable nappies (Am. diapers)
- 23 vest
- 24 leggings

- 25 baby's jacket
- 26 hood
- 27 baby's cup
- 28 baby's plate, a stay-warm plate
- 29 thermometer

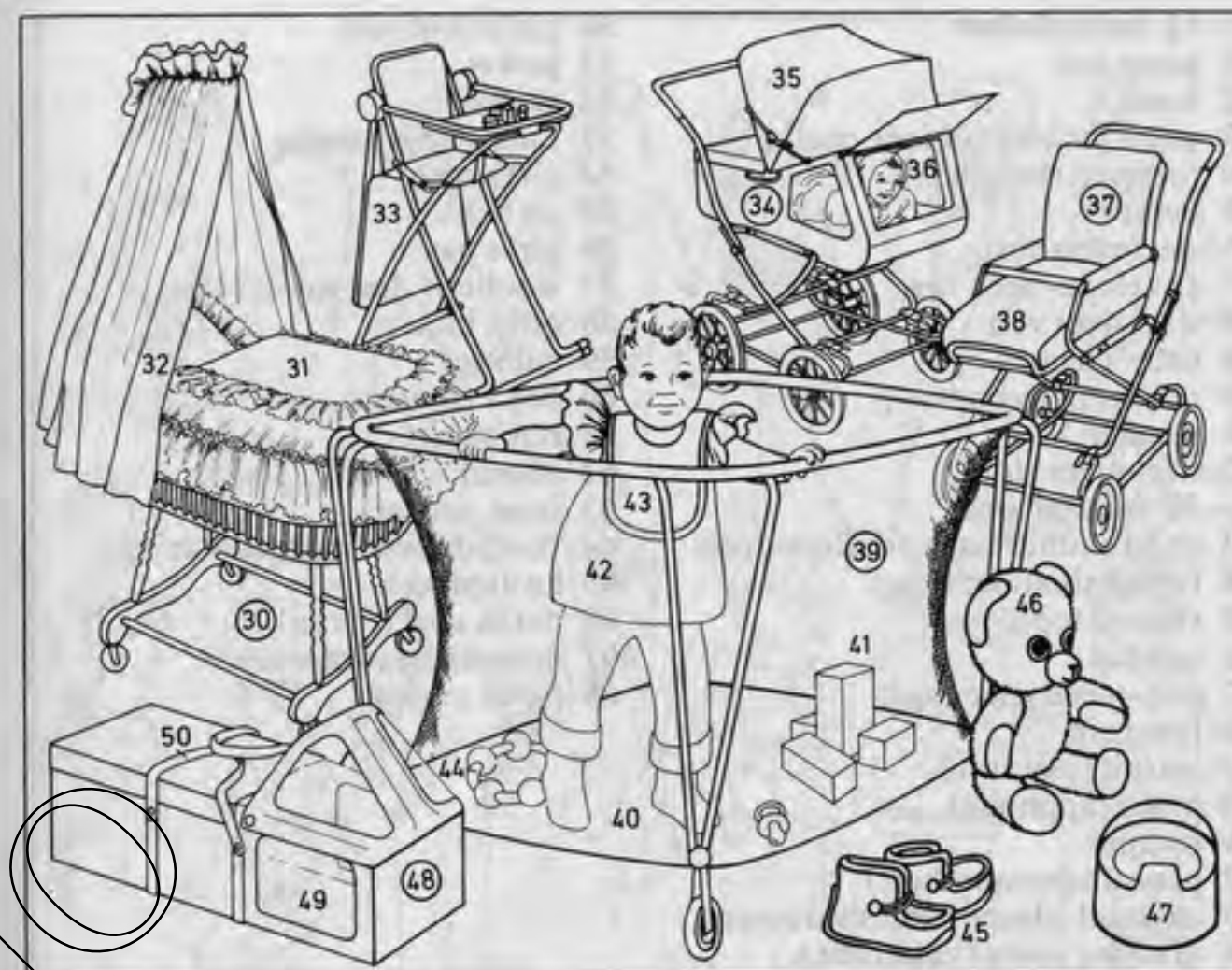

- 30 bassinet, a wicker pram
- 31 set of bassinet covers
- 32 canopy
- 33 baby's high chair, a folding chair
- 34 pram (baby-carriage)[with windows]
- 35 folding hood
- 36 window
- 37 pushchair (Am. stroller)
- 38 foot-muff (Am. foot-bag)
- 39 play pen
- 40 floor of the play pen
- 41 building blocks (building bricks)
- 42 small child
- 43 bib
- 44 rattle (baby's rattle)
- 45 booties
- 46 teddy bear
- 47 potty (baby's pot)
- 48 carrycot
- 49 window
- 50 handles

1-12 baby clothes

- 1 pram suit
- 2 hood
- 3 pram jacket (matinée coat)
- 4 pompon (bobble)
- 5 bootees
- 6 sleeveless vest
- 7 envelope-neck vest
- 8 wrapover vest
- 9 baby's jacket
- 10 rubber baby pants
- 11 playsuit
- 12 two-piece suit
- 13-30 infants' wear
- 13 child's sundress, a pinafore dress
- 14 frilled shoulder strap
- 15 Shirred top
- 16 sun hat
- 17 one-piece jersey suit
- 18 front zip
- 19 catsuit (playsuit)
- 20 motif (appliqué)
- 21 romper
- 22 playsuit (romper suit)
- 23 coverall (sleeper and strampler)
- 24 dressing gown (bath robe)
- 25 children's shorts
- 26 braces (Am. suspenders)
- 27 children's T-shirt
- 28 jersey dress (knitted dress)
- 29 embroidery
- 30 children's ankle socks

31-47 school children's wear

- 31 raincoat (loden coat)
- 32 leather shorts (lederhosen)
- 33 staghorn button
- 34 braces (Am. suspenders)
- 35 flap
- 36 girl's dirndl
- 37 cross lacing
- 38 snow suit (quilted suit)
- 39 quilt stitching (quilting)
- 40 dungarees (bib and brace)
- 41 bib skirt (bib top pinafore)
- 42 tights
- 43 sweater (jumper)
- 44 pile jacket
- 45 leggings
- 46 girl's skirt
- 47 child's jumper
- 48-68 teenagers' clothes
- 48 girl's overblouse (overtop)
- 49 slacks

- 50 girl's skirt suit
- 51 jacket
- 52 skirt
- 53 knee-length socks
- 54 girl's coat
- 55 tie belt
- 56 girl's bag
- 57 woollen (Am. woolen) hat
- 58 girl's blouse
- 59 culottes
- 60 boy's trousers
- 61 boy's shirt
- 62 anorak
- 63 inset pockets
- 64 hood drawstring (drawstring)
- 65 knitted welt
- 66 parka coat (parka)
- 67 drawstring (draw cord)
- 68 patch pockets



- 1 mink jacket
- 2 cowl neck jumper
- 3 cowl collar
- 4 knitted overtop
- 5 turndown collar
- 6 turn-up (turnover) sleeve
- 7 polo neck jumper
- 8 pinafore dress
- 9 blouse with revers collar
- 10 shirt-waister dress, a button-through dress
- 11 belt
- 12 winter dress
- 13 piping
- 14 cuff
- 15 long sleeve
- 16 quilted waistcoat
- 17 quilt stitching (quilting)
- 18 leather trimming
- 19 winter slacks
- 20 striped polo jumper
- 21 boiler suit (dungarees, bib and brace)
- 22 patch pocket
- 23 front pocket
- 24 bib
- 25 wrapover dress (wrap-around dress)
- 26 shirt
- 27 peasant-style dress
- 28 floral braid
- 29 tunic (tunic top, tunic dress)
- 30 ribbed cuff
- 31 quilted design
- 32 pleated skirt
- 33 two-piece knitted dress
- 34 boat neck, a neckline
- 35 turn-up
- 36 kimono sleeve
- 37 knitted design
- 38 lumber-jacket
- 39 cable pattern
- 40 shirt-blouse
- 41 loop fastening
- 42 embroidery
- 43 stand-up collar
- 44 cossack trousers
- 45 two-piece combination (shirt top and long skirt)
- 46 tie (bow)
- 47 decorative facing
- 48 cuff slit
- 49 side slit

- 50 tabard
- 51 inverted pleat skirt
- 52 godet
- 53 evening gown
- 54 pleated bell sleeve
- 55 party blouse
- 56 party skirt
- 57 trouser suit (slack suit)
- 58 suede jacket
- 59 fur trimming
- 60 fur coat (*kinds: Persian lamb, broadtail, mink, sable*)
- 61 winter coat (cloth coat)
- 62 fur cuff (fur-trimmed cuff)
- 63 fur collar (fur-trimmed collar)
- 64 loden coat
- 65 cape
- 66 toggle fastenings
- 67 loden skirt
- 68 poncho-style coat
- 69 hood



- 1-15 ladies' underwear (ladies' underclothes, lingerie)
- 1 brassière (bra)
- 2 pantie-girdle
- 3 pantie-corsette
- 4 longline brassière (longline bra)
- 5 stretch girdle
- 6 suspender
- 7 vest
- 8 pantie briefs
- 9 ladies' knee-high stocking
- 10 long-legged (long leg) panties
- 11 long pants
- 12 tights (pantie-hose)
- 13 slip
- 14 waist slip
- 15 bikini briefs
- 16-21 ladies' nightwear
- 16 nightdress (nightgown, nightie)
- 17 pyjamas (*Am.* pajamas)
- 18 pyjama top
- 19 pyjama trousers
- 20 housecoat
- 21 vest and shorts set [for leisure wear and as nightwear]
- 22-29 men's underwear (men's underclothes)
- 22 string vest
- 23 string briefs
- 24 front panel
- 25 sleeveless vest
- 26 briefs
- 27 trunks
- 28 short-sleeved vest
- 29 long johns
- 30 braces (*Am.* suspenders)
- 31 braces clip
- 32-34 men's socks
- 32 knee-length sock
- 33 elasticated top
- 34 long sock
- 35-37 men's nightwear
- 35 dressing gown
- 36 pyjamas (*Am.* pajamas)
- 37 nightshirt

- 38-47 men's shirts
- 38 casual shirt
- 39 belt
- 40 cravat
- 41 tie
- 42 knot
- 43 dress shirt
- 44 frill (frill front)
- 45 cuff
- 46 cuff link
- 47 bow-tie



1-67 men's fashion

- 1 single-breasted suit, a men's suit
- 2 jacket
- 3 suit trousers
- 4 waistcoat (vest)
- 5 lapel
- 6 trouser leg with crease
- 7 dinner dress, an evening suit
- 8 silk lapel
- 9 breast pocket
- 10 dress handkerchief
- 11 bow-tie
- 12 side pocket
- 13 tailcoat (tails), evening dress
- 14 coat-tail
- 15 white waistcoat (vest)
- 16 white bow-tie
- 17 casual suit
- 18 pocket flap
- 19 front yoke
- 20 denim suit
- 21 denim jacket
- 22 jeans (denims)
- 23 waistband
- 24 beach suit
- 25 shorts
- 26 short-sleeved jacket
- 27 tracksuit
- 28 tracksuit top with zip
- 29 tracksuit bottoms
- 30 cardigan
- 31 knitted collar
- 32 men's short-sleeved pullover (men's short-sleeved sweater)
- 33 short-sleeved shirt
- 34 shirt button
- 35 turn-up
- 36 knitted shirt
- 37 casual shirt
- 38 patch pocket
- 39 casual jacket
- 40 knee-breeches
- 41 knee strap
- 42 knee-length sock
- 43 leather jacket
- 44 bib and brace overalls
- 45 adjustable braces (*Am.* suspenders)
- 46 front pocket
- 47 trouser pocket
- 48 fly
- 49 rule pocket
- 50 check shirt

- 51 men's pullover
- 52 heavy pullover
- 53 knitted waistcoat (vest)
- 54 blazer
- 55 jacket button
- 56 overall
- 57 trenchcoat
- 58 coat collar
- 59 coat belt
- 60 poplin coat
- 61 coat pocket
- 62 fly front
- 63 car coat
- 64 coat button
- 65 scarf
- 66 cloth coat
- 67 glove



1-25 men's beards and hairstyles

- 1 long hair worn loose
- 2 allonge periwig (full-bottomed wig), a wig; shorter and smoother: bob wig, toupet
- 3 curls
- 4 bag wig (purse wig)
- 5 pigtail wig
- 6 queue (pigtail)
- 7 bow (ribbon)
- 8 handlebars (handlebar moustache, *Am.* mustache)
- 9 centre (*Am.* center) parting
- 10 goatee (goatee beard), chintuft
- 11 closely-cropped head of hair (crew cut)
- 12 whiskers
- 13 Vandyke beard (stiletto beard, bodkin beard), with waxed moustache (*Am.* mustache)
- 14 side parting
- 15 full beard (circular beard, round beard)
- 16 tile beard
- 17 shadow
- 18 head of curly hair
- 19 military moustache (*Am.* mustache) (*English-style* moustache)
- 20 partly bald head
- 21 bald patch
- 22 bald head
- 23 stubble beard (stubble, short beard bristles)
- 24 side-whiskers (sideboards, sideburns)
- 25 clean shave
- 26 Afro look (for men and women)

- 34 shingle (shingled hair, bobbed hair)
- 35 pageboy style
- 36 fringe (*Am.* bangs)
- 37 earphones
- 38 earphone (coiled plait)

- 27 ponytail
- 28 swept-back hair (swept-up hair, pinned-up hair)
- 29 bun (chignon)
- 30 plaits (bunches)
- 31 chaplet hairstyle (Gretchen style)
- 32 chaplet (coiled plaits)
- 33 curled hair

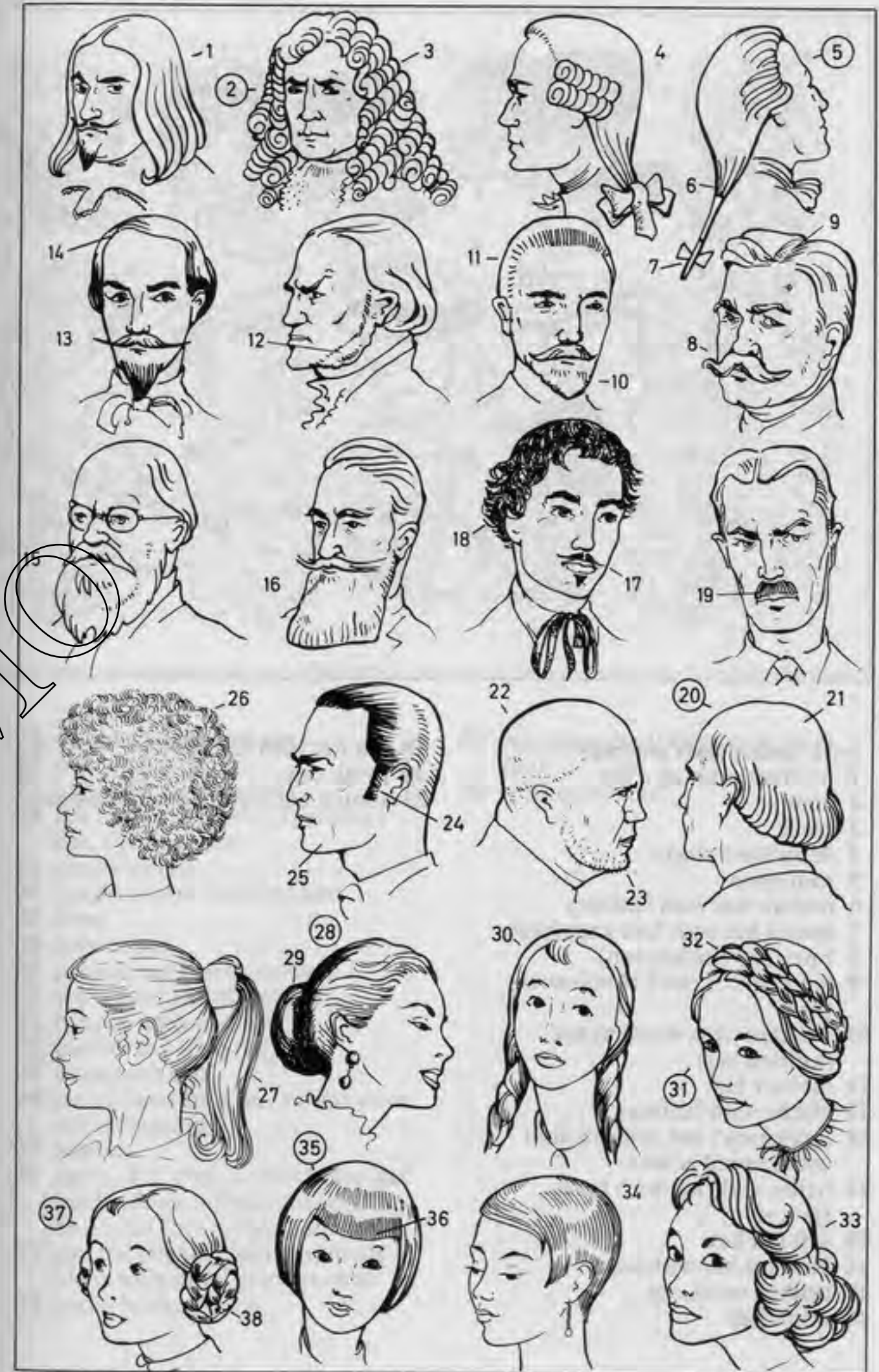

**1-21 ladies' hats and caps**

- 1 milliner making a hat
- 2 hood
- 3 block
- 4 decorative pieces
- 5 sombrero
- 6 mohair hat with feathers
- 7 model hat with fancy appliqué
- 8 linen cap (jockey cap)
- 9 hat made of thick candlewick yarn
- 10 woollen (*Am.* woolen) hat (knitted hat)
- 11 mohair hat
- 12 cloche with feathers
- 13 large men's hat made of sisal with corded ribbon
- 14 trilby-style hat with fancy ribbon
- 15 soft felt hat
- 16 Panama hat with scarf
- 17 peaked mink cap
- 18 mink hat

19 fox hat with leather top

- 20 mink cap
- 21 slouch hat trimmed with flowers

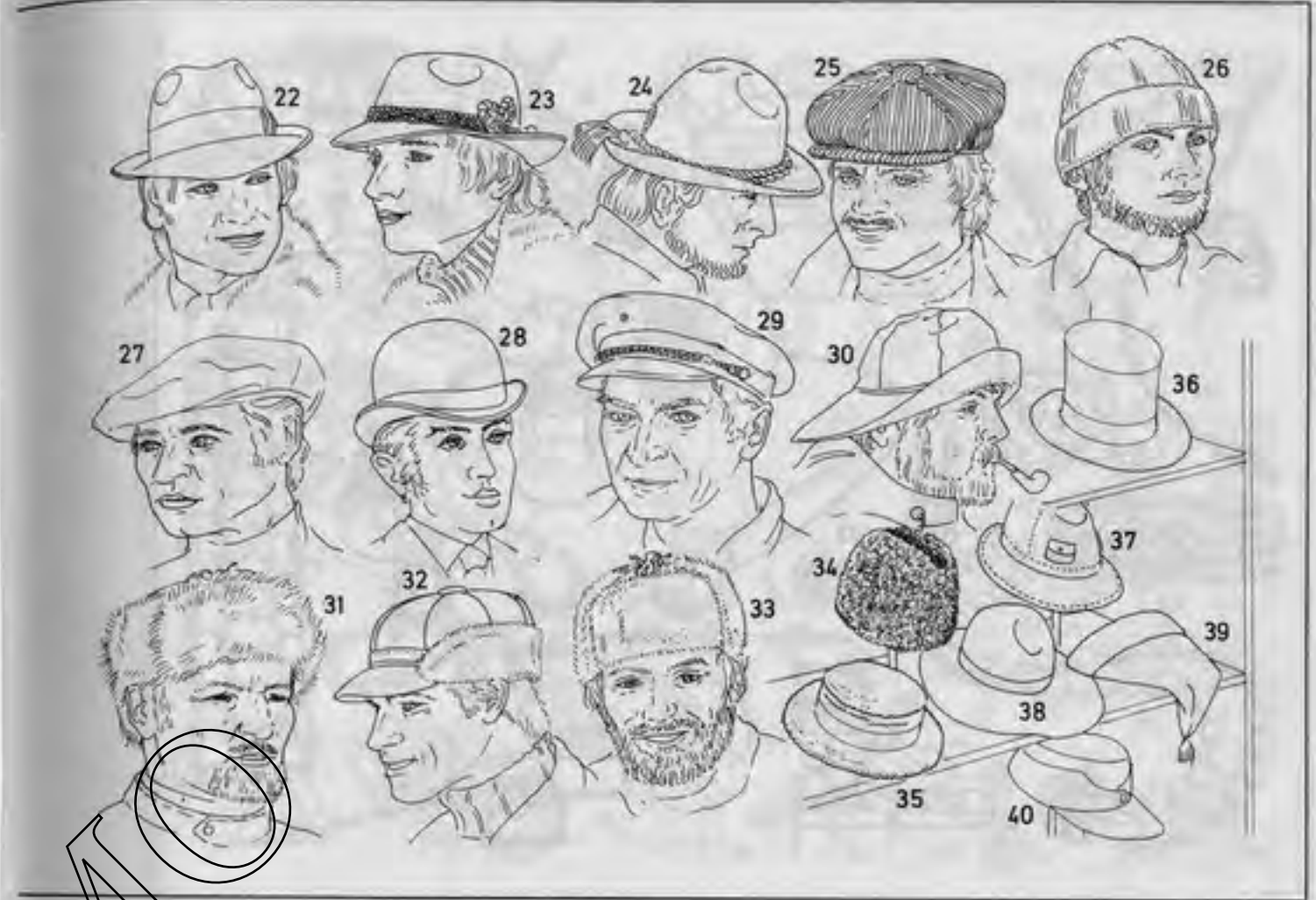
**22-40 men's hats and caps**

- 22 trilby hat (trilby)
- 23 loden hat (Alpine hat)
- 24 felt hat with tassels (Tyrolean hat, Tyrolese hat)
- 25 corduroy cap
- 26 woollen (*Am.* woolen) hat
- 27 beret
- 28 bowler hat
- 29 peaked cap (yachting cap)
- 30 sou'wester (southwester)
- 31 fox cap with earflaps
- 32 leather cap with fur flaps
- 33 musquash cap
- 34 astrakhan cap, a real or imitation astrakhan cap
- 35 boater
- 36 (grey, *Am.* gray, or black) top hat made of silk taffeta; *collapsible*: crush hat (opera hat, claque)
- 37 sun hat (lightweight hat) made of cloth with small patch pocket
- 38 wide-brimmed hat

39 toboggan cap (skiing cap, ski cap)

- 40 workman's cap

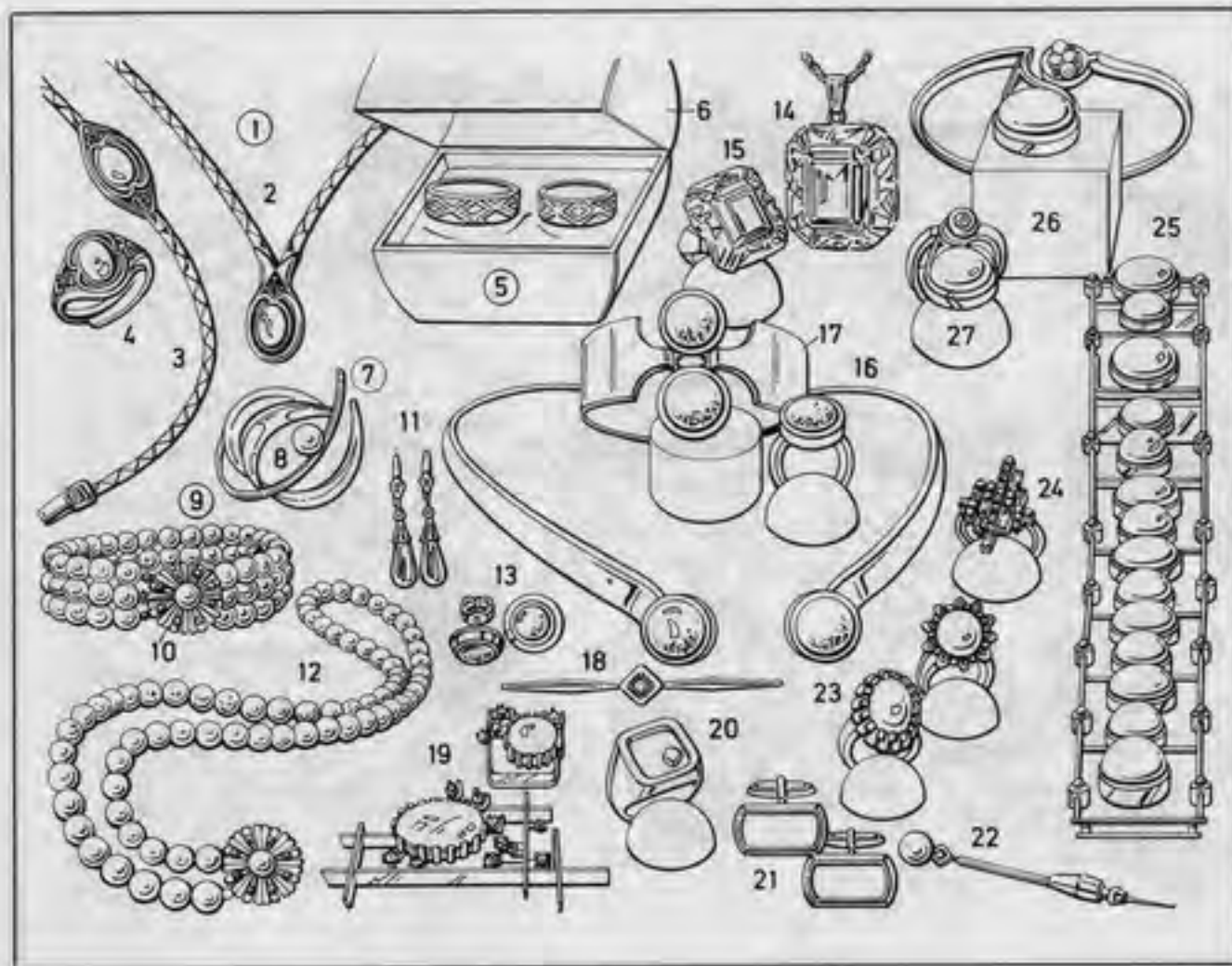

- 1 set of jewellery (Am. jewelry)
- 2 necklace
- 3 bracelet
- 4 ring
- 5 wedding rings
- 6 wedding ring box
- 7 brooch, a pearl brooch
- 8 pearl
- 9 cultured pearl bracelet
- 10 clasp, a white gold clasp
- 11 pendant earrings (drop earrings)
- 12 cultured pearl necklace
- 13 earrings
- 14 gemstone pendant
- 15 gemstone ring
- 16 choker (collar, neckband)
- 17 bangle
- 18 diamond pin
- 19 modern-style brooches
- 20 man's ring
- 21 cuff links
- 22 tiepin
- 23 diamond ring with pearl
- 24 modern-style diamond ring
- 25 gemstone bracelet
- 26 asymmetrical bangle
- 27 asymmetrical ring
- 28 ivory necklace
- 29 ivory rose
- 30 ivory brooch
- 31 jewel box (jewel case)
- 32 pearl necklace
- 33 bracelet watch
- 34 coral necklace
- 35 charms
- 36 coin bracelet
- 37 gold coin
- 38 coin setting
- 39 link
- 40 signet ring
- 41 engraving (monogram)

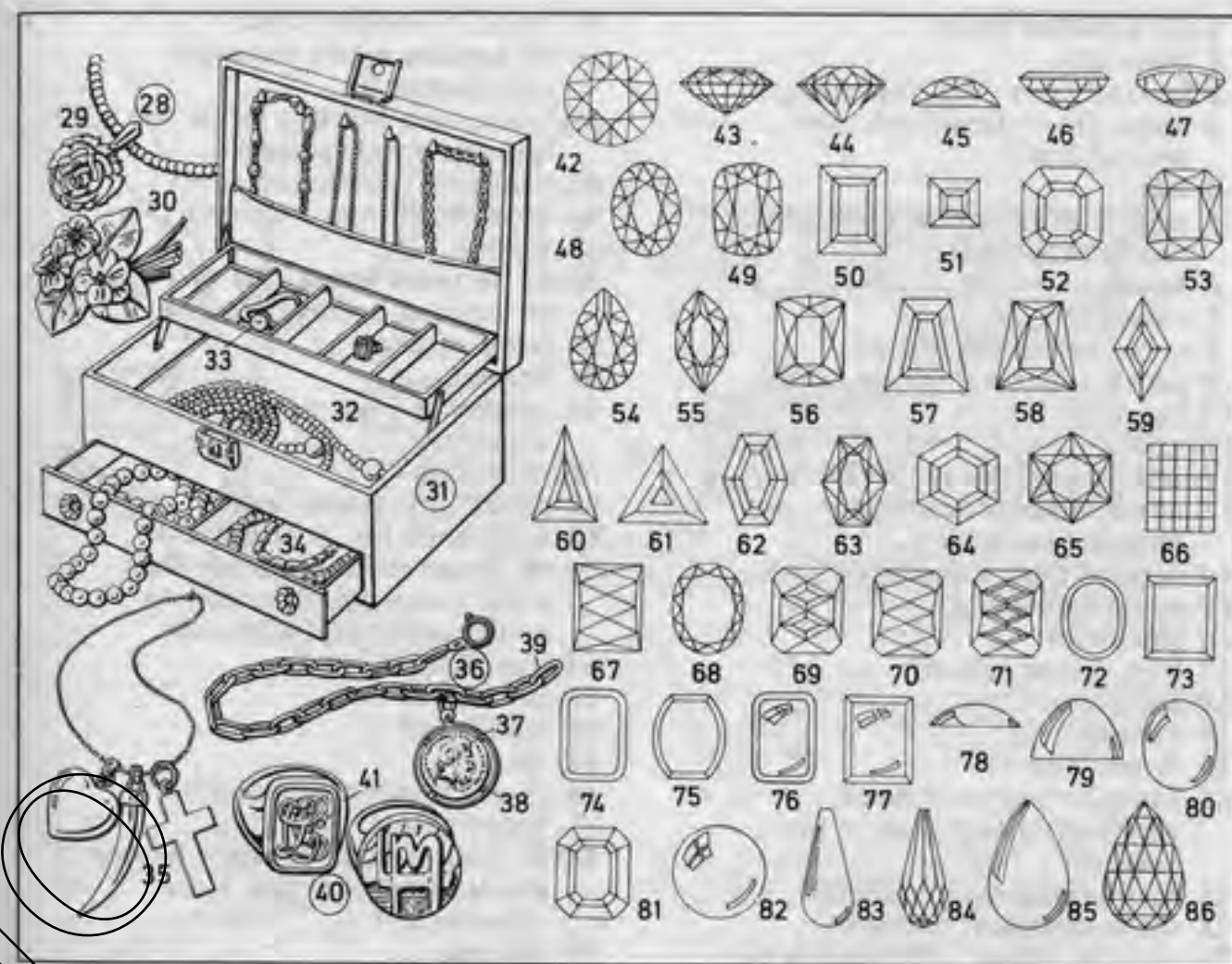

- 42-71 faceted stones
- 42-43 standard round cut
- 44 brilliant cut
- 45 rose cut
- 46 flat table
- 47 table en cabochon
- 48 standard cut
- 49 standard antique cut
- 50 rectangular step-cut
- 51 square step-cut
- 52 octagonal step-cut
- 53 octagonal cross-cut
- 54 standard pear-shape (pendeloque)
- 55 marquise (navette)
- 56 standard barrel-shape
- 57 trapezium step-cut
- 58 trapezium cross-cut
- 59 rhombus step-cut
- 60-61 triangular step-cut
- 62 hexagonal step-cut
- 63 oval hexagonal cross-cut
- 64 round hexagonal step-cut
- 65 round hexagonal cross-cut
- 66 chequer-board cut
- 67 triangle cut
- 68-71 fancy cuts
- 72-77 ring gemstones
- 72 oval flat table
- 73 rectangular flat table
- 74 octagonal flat table
- 75 barrel-shape
- 76 antique table en cabochon
- 77 rectangular table en cabochon
- 78-81 cabochons
- 78 round cabochon (simple cabochon)
- 79 high dome (high cabochon)
- 80 oval cabochon
- 81 octagonal cabochon
- 82-86 spheres and pear-shapes
- 82 plain sphere
- 83 plain pear-shape
- 84 faceted pear-shape
- 85 plain drop
- 86 faceted briolette

- 1-53 detached house
- 1 basement
- 2 ground floor (*Am.* first floor)
- 3 upper floor (first floor, *Am.* second floor)
- 4 loft
- 5 roof, a gable roof (saddle roof, saddleback roof)
- 6 gutter
- 7 ridge
- 8 verge with bargeboards
- 9 eaves, rafter-supported eaves
- 10 chimney
- 11 gutter
- 12 swan's neck (swan-neck)
- 13 rainwater pipe (downpipe, *Am.* downspout, leader)
- 14 vertical pipe, a cast-iron pipe
- 15 gable (gable end)
- 16 glass wall
- 17 base course (plinth)
- 18 balcony
- 19 parapet
- 20 flower box
- 21 French window (French windows) opening on to the balcony
- 22 double casement window
- 23 single casement window
- 24 window breast with window sill
- 25 lintel (window head)
- 26 reveal
- 27 cellar window (basement window)
- 28 rolling shutter
- 29 rolling shutter frame
- 30 window shutter (folding shutter)
- 31 shutter catch
- 32 garage with tool shed
- 33 espalier
- 34 batten door (ledged door)
- 35 fanlight with mullion and transom
- 36 terrace
- 37 garden wall with coping stones
- 38 garden light
- 39 steps
- 40 rockery (rock garden)
- 41 outside tap (*Am.* faucet) for the hose
- 42 garden hose
- 43 lawn sprinkler
- 44 paddling pool
- 45 stepping stones
- 46 sunbathing area (lawn)
- 47 deck-chair
- 48 sunshade (garden parasol)
- 49 garden chair
- 50 garden table
- 51 frame for beating carpets
- 52 garage driveway
- 53 fence, a wooden fence
- 54-57 housing estate (housing development)
- 54 house on a housing estate (on a housing development)
- 55 pent roof (penthouse roof)
- 56 dormer (dormer window)
- 57 garden
- 58-63 terraced house [one of a row of terraced houses], stepped
- 58 front garden
- 59 hedge
- 60 pavement (*Am.* sidewalk, walkway)
- 61 street (road)
- 62 street lamp (street light)
- 63 litter bin (*Am.* litter basket)
- 64-68 house divided into two flats (*Am.* house divided into two apartments, duplex house)
- 64 hip (hipped) roof
- 65 front door
- 66 front steps
- 67 canopy
- 68 flower window (window for house plants)
- 69-71 pair of semi-detached houses divided into four flats (*Am.* apartments)
- 69 balcony
- 70 sun lounge (*Am.* sun parlor)
- 71 awning (sun blind, sunshade)
- 72-76 block of flats (*Am.* apartment building, apartment house) with access balconies
- 72 staircase
- 73 balcony
- 74 studio flat (*Am.* studio apartment)
- 75 sun roof, a sun terrace
- 76 open space
- 77-81 multi-storey block of flats (*Am.* multistorey apartment building, multistorey apartment house)
- 77 flat roof
- 78 pent roof (shed roof, lean-to roof)
- 79 garage
- 80 pergola
- 81 staircase window
- 82 high-rise block of flats (*Am.* high-rise apartment building, high-rise apartment house)
- 83 penthouse
- 84-86 weekend house, a timber house
- 84 horizontal boarding
- 85 natural stone base course (natural stone plinth)
- 86 strip windows (ribbon windows)

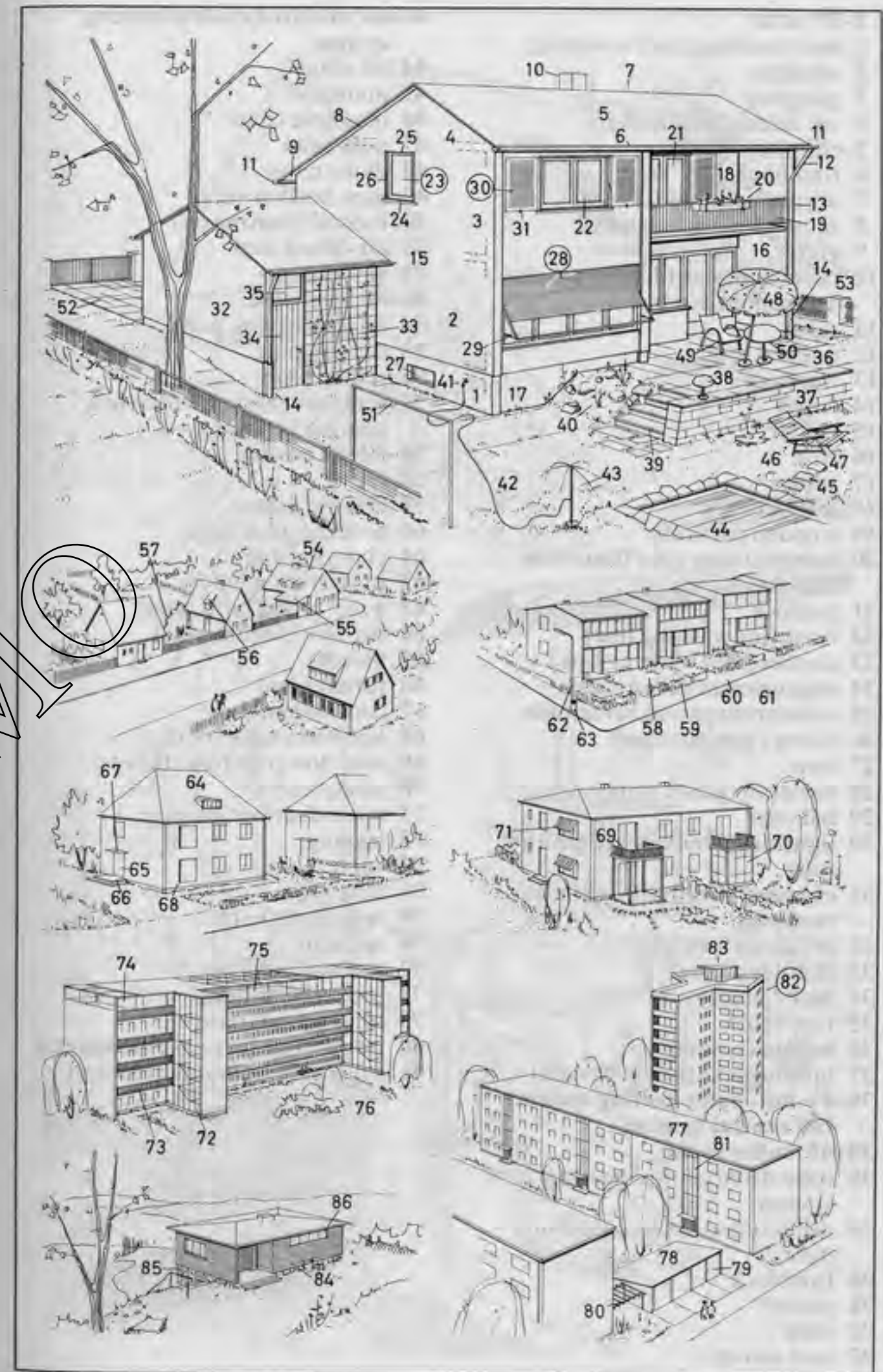

- 1-29 attic
- 1 roof cladding (roof covering)
- 2 skylight
- 3 gangway
- 4 cat ladder (roof ladder)
- 5 chimney
- 6 roof hook
- 7 dormer window (dormer)
- 8 snow guard (roof guard)
- 9 gutter
- 10 rainwater pipe (downpipe, *Am.* downspout, leader)
- 11 eaves
- 12 pitched roof
- 13 trapdoor
- 14 hatch
- 15 ladder
- 16 stile
- 17 rung
- 18 loft (attic)
- 19 wooden partition
- 20 lumber room door (boxroom door)
- 21 padlock
- 22 hook [for washing line]
- 23 clothes line (washing line)
- 24 expansion tank for boiler
- 25 wooden steps and balustrade
- 26 string (*Am.* stringer)
- 27 step
- 28 handrail (guard rail)
- 29 baluster
- 30 lightning conductor (lightning rod)
- 31 chimney sweep (*Am.* chimney sweeper)
- 32 brush with weight
- 33 shoulder iron
- 34 sack for soot
- 35 flue brush
- 36 broom (besom)
- 37 broomstick (broom handle)
- 38-81 hot-water heating system, full central heating
- 38-43 boiler room
- 38 coke-fired central heating system
- 39 ash box door (*Am.* cleanout door)
- 40 flueblock
- 41 poker
- 42 rake
- 43 coal shovel

- 44-60 oil-fired central heating system
- 44 oil tank
- 45 manhole
- 46 manhole cover
- 47 tank inlet
- 48 dome cover
- 49 tank bottom valve
- 50 fuel oil (heating oil)
- 51 air-bleed duct
- 52 air vent cap
- 53 oil level pipe
- 54 oil gauge (*Am.* gage)
- 55 suction pipe
- 56 return pipe
- 57 central heating furnace (oil heating furnace)
- 58-60 oil burner
- 58 fan
- 59 electric motor
- 60 covered pilot light
- 61 charging door
- 62 inspection window
- 63 water gauge (*Am.* gage)
- 64 furnace thermometer
- 65 bleeder
- 66 furnace bed
- 67 control panel
- 68 hot water tank (boiler)
- 69 overflow pipe (overflow)
- 70 safety valve
- 71 main distribution pipe
- 72 lagging
- 73 valve
- 74 flow pipe
- 75 regulating valve
- 76 radiator
- 77 radiator rib
- 78 room thermostat
- 79 return pipe (return)
- 80 return pipe [in two-pipe system]
- 81 smoke outlet (smoke extract)

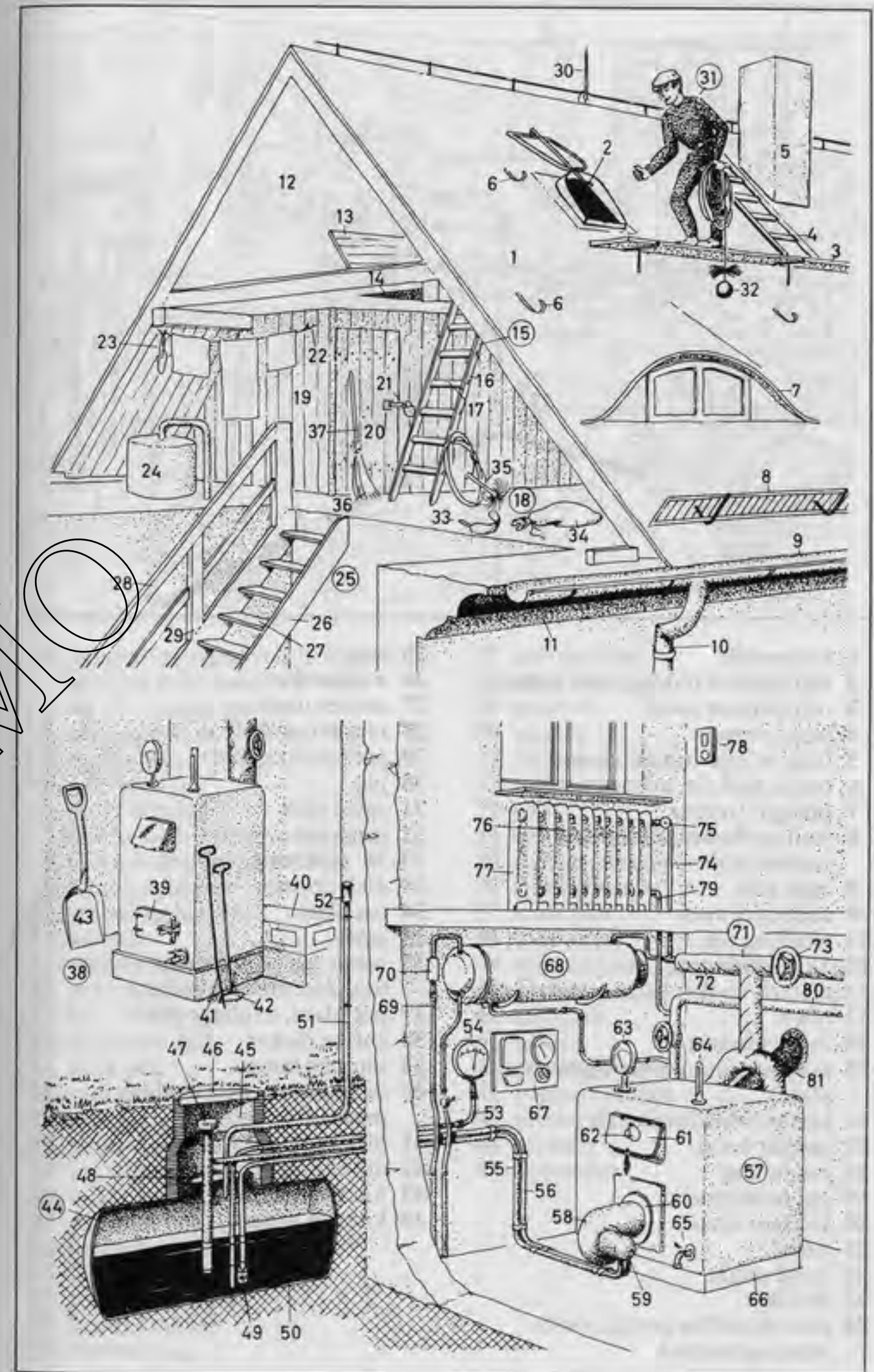



- | | |
|---|---|
| 1 housewife | 25 lead |
| 2 refrigerator (fridge, <i>Am.</i> icebox) | 26 wall socket |
| 3 refrigerator shelf | 27 corner unit |
| 4 salad drawer | 28 revolving shelf |
| 5 frozen food compartment | 29 pot (cooking pot) |
| 6 bottle rack (in storage door) | 30 jug |
| 7 upright freezer | 31 spice rack |
| 8 wall cupboard, a kitchen cupboard | 32 spice jar |
| 9 base unit | 33-36 sink unit |
| 10 cutlery drawer | 33 dish drainer |
| 11 working top | 34 tea plate |
| 12-17 cooker unit | 35 sink |
| 12 electric cooker (<i>also:</i> gas cooker) | 36 water tap (<i>Am.</i> faucet) (mixer tap, <i>Am.</i> mixing faucet) |
| 13 oven | 37 pot plant, a foliage plant |
| 14 oven window | 38 coffee maker |
| 15 hotplate (automatic high-speed plate) | 39 kitchen lamp |
| 16 kettle (whistling kettle) | 40 dishwasher (dishwashing machine) |
| 17 cooker hood | 41 dish rack |
| 18 pot holder | 42 dinner plate |
| 19 pot holder rack | 43 kitchen chair |
| 20 kitchen clock | 44 kitchen table |
| 21 timer | |
| 22 hand mixer | |
| 23 whisk | |
| 24 electric coffee grinder (with rotating blades) | |

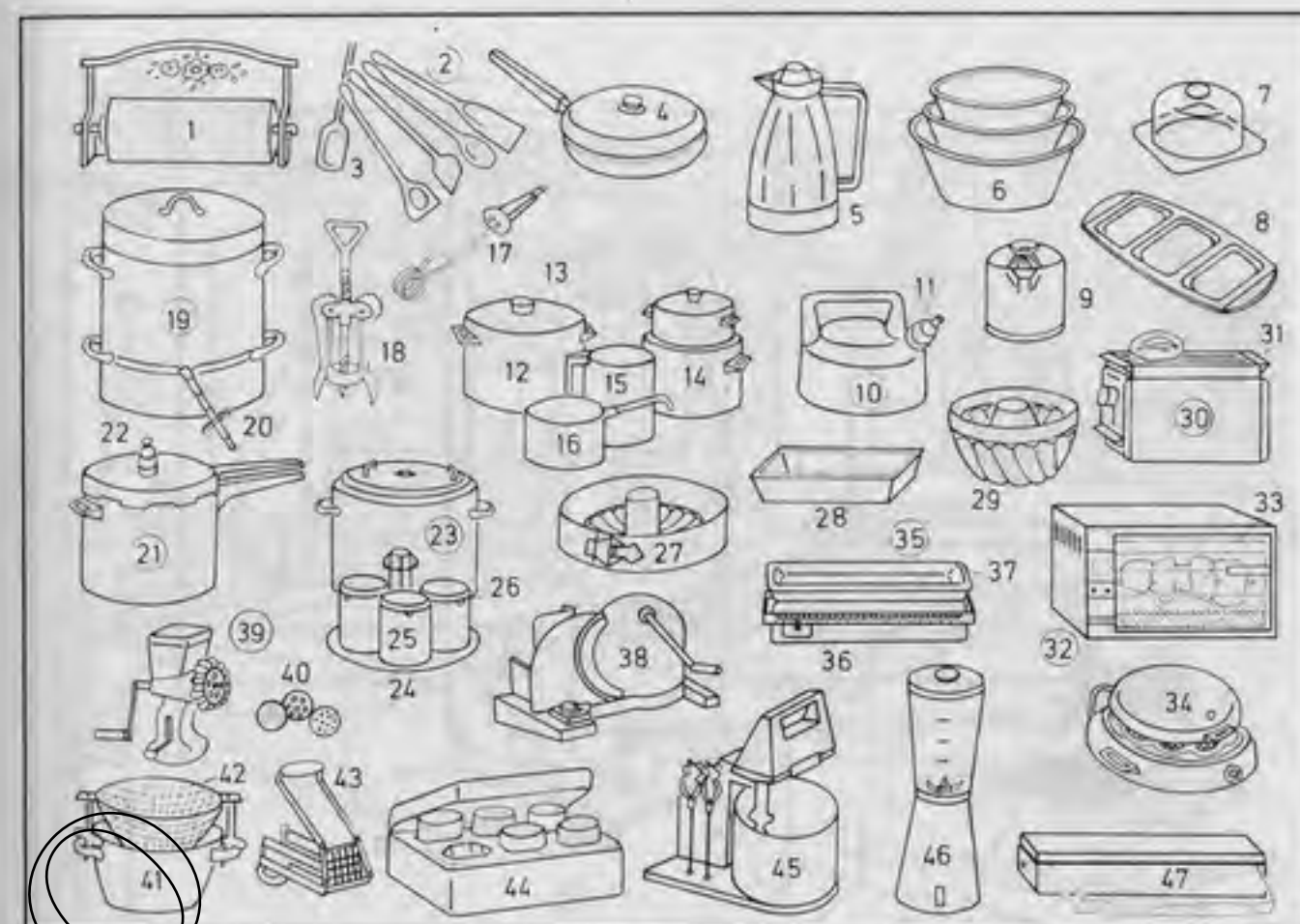

- | | |
|--|--------------------------------------|
| 1 general-purpose roll holder with kitchen roll (paper towels) | 27 spring form |
| 2 set of wooden spoons | 28 cake tin |
| 3 mixing spoon | 29 cake tin |
| 4 frying pan | 30 toaster |
| 5 Thermos jug | 31 rack for rolls |
| 6 set of bowls | 32 rotisserie |
| 7 cheese dish with glass cover | 33 spit |
| 8 three-compartment dish | 34 electric waffle iron |
| 9 lemon squeezer | 35 sliding-weight scales |
| 10 whistling kettle | 36 sliding weight |
| 11 whistle | 37 scale pan |
| 12-16 pan set | 38 food slicer |
| 12 pot (cooking pot) | 39 mincer (<i>Am.</i> meat chopper) |
| 13 lid | 40 blades |
| 14 casserole dish | 41 chip pan |
| 15 milk pot | 42 basket |
| 16 saucepan | 43 potato chipper |
| 17 immersion heater | 44 yoghurt maker |
| 18 corkscrew [with levers] | 45 mixer |
| 19 juice extractor | 46 blender |
| 20 tube clamp (tube clip) | 47 bag sealer |
| 21 pressure cooker | |
| 22 pressure valve | |
| 23 fruit preserver | |
| 24 removable rack | |
| 25 preserving jar | |
| 26 rubber ring | |

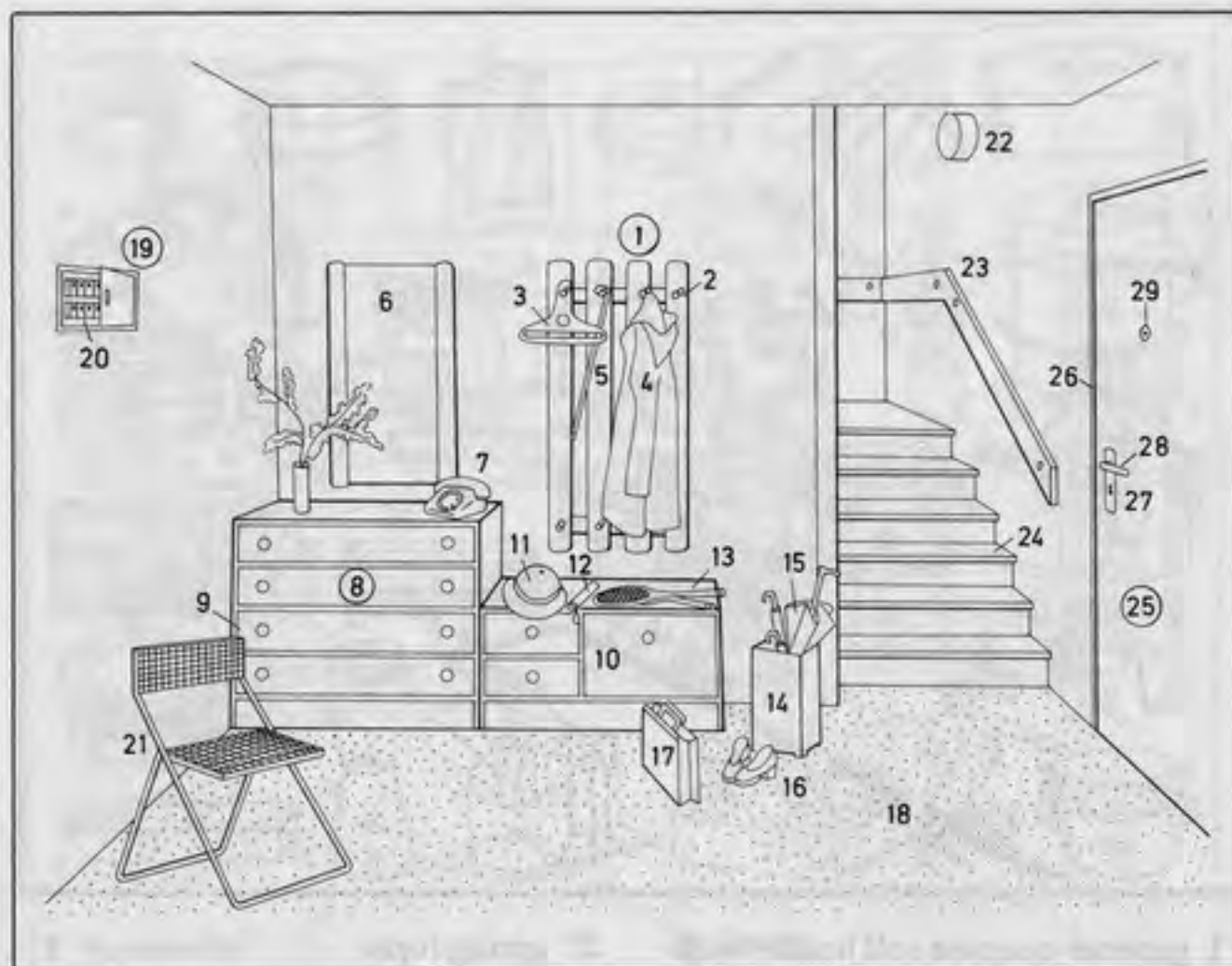
**1-29 hall (entrance hall)**

- 1 coat rack
- 2 coat hook
- 3 coat hanger
- 4 rain cape
- 5 walking stick
- 6 hall mirror
- 7 telephone
- 8 chest of drawers for shoes, etc.
- 9 drawer
- 10 seat
- 11 ladies' hat
- 12 telescopic umbrella
- 13 tennis rackets (tennis racquets)
- 14 umbrella stand
- 15 umbrella
- 16 shoes
- 17 briefcase
- 18 fitted carpet
- 19 fuse box
- 20 miniature circuit breaker
- 21 tubular steel chair
- 22 stair light
- 23 handrail
- 24 step

- 25 front door
- 26 door frame
- 27 door lock
- 28 door handle
- 29 spyhole



- 1 wall units
- 2 side wall
- 3 bookshelf
- 4 row of books
- 5 display cabinet unit
- 6 cupboard base unit
- 7 cupboard unit
- 8 television set (TV set)
- 9 stereo system (stereo equipment)
- 10 speaker (loudspeaker)
- 11 pipe rack
- 12 pipe
- 13 globe
- 14 brass kettle
- 15 telescope
- 16 mantle clock
- 17 bust
- 18 encyclopaedia [in several volumes]
- 19 room divider
- 20 drinks cupboard
- 21-26 upholstered suite (seating group)
- 21 armchair
- 22 arm

- 23 seat cushion (cushion)
- 24 settee
- 25 back cushion
- 26 [round] corner section
- 27 scatter cushion
- 28 coffee table
- 29 ashtray
- 30 tray
- 31 whisky (whiskey) bottle
- 32 soda water bottle (soda bottle)
- 33-34 dining set
- 33 dining table
- 34 chair
- 35 net curtain
- 36 indoor plants (houseplants)



- 1 wardrobe (*Am.* clothes closet)
- 2 linen shelf
- 3 cane chair
- 4-13 **double bed** (*sim.*: double divan)
- 4-6 **bedstead**
- 4 foot of the bed
- 5 bed frame
- 6 headboard
- 7 bedspread
- 8 duvet, a quilted duvet
- 9 sheet, a linen sheet
- 10 mattress, a foam mattress with drill tick
- 11 [wedge-shaped] bolster
- 12-13 pillow
- 12 pillowcase (pillowslip)
- 13 tick
- 14 bookshelf [attached to the headboard]
- 15 reading lamp
- 16 electric alarm clock
- 17 bedside cabinet
- 18 drawer
- 19 bedroom lamp
- 20 picture
- 21 picture frame
- 22 bedside rug
- 23 fitted carpet
- 24 dressing stool
- 25 dressing table
- 26 perfume spray
- 27 perfume bottle
- 28 powder box
- 29 dressing-table mirror (mirror)

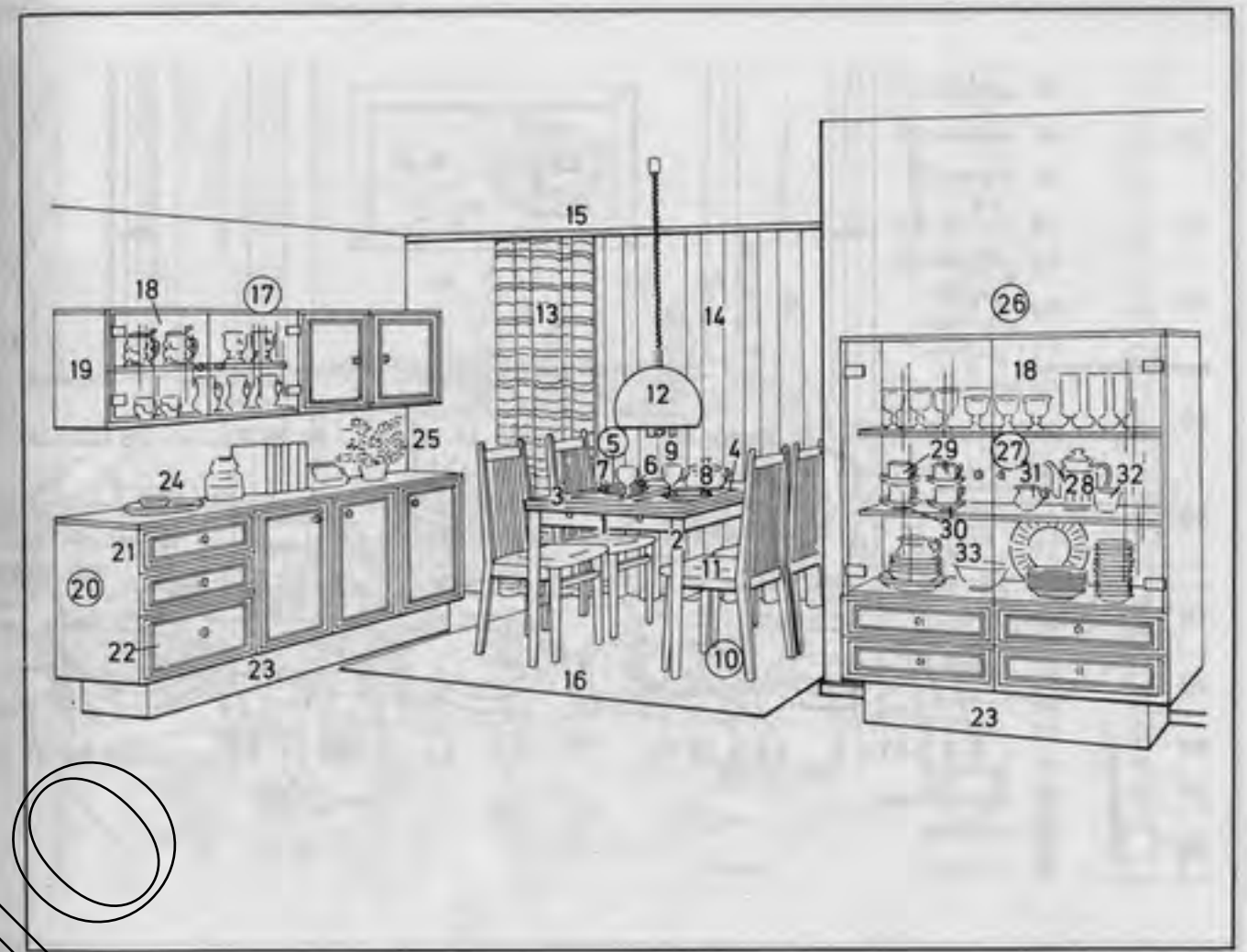

- 1-11 **dining set**
- 1 dining table
- 2 table leg
- 3 table top
- 4 place mat
- 5 place (place setting, cover)
- 6 soup plate (deep plate)
- 7 dinner plate
- 8 soup tureen
- 9 wineglass
- 10 dining chair
- 11 seat
- 12 lamp (pendant lamp)
- 13 curtains
- 14 net curtain
- 15 curtain rail
- 16 carpet
- 17 wall unit
- 18 glass door
- 19 shelf
- 20 sideboard
- 21 cutlery drawer
- 22 linen drawer
- 23 base
- 24 round tray
- 25 pot plant
- 26 china cabinet (display cabinet)
- 27 coffee set (coffee service)
- 28 coffee pot
- 29 coffee cup
- 30 saucer
- 31 milk jug
- 32 sugar bowl
- 33 dinner set (dinner service)

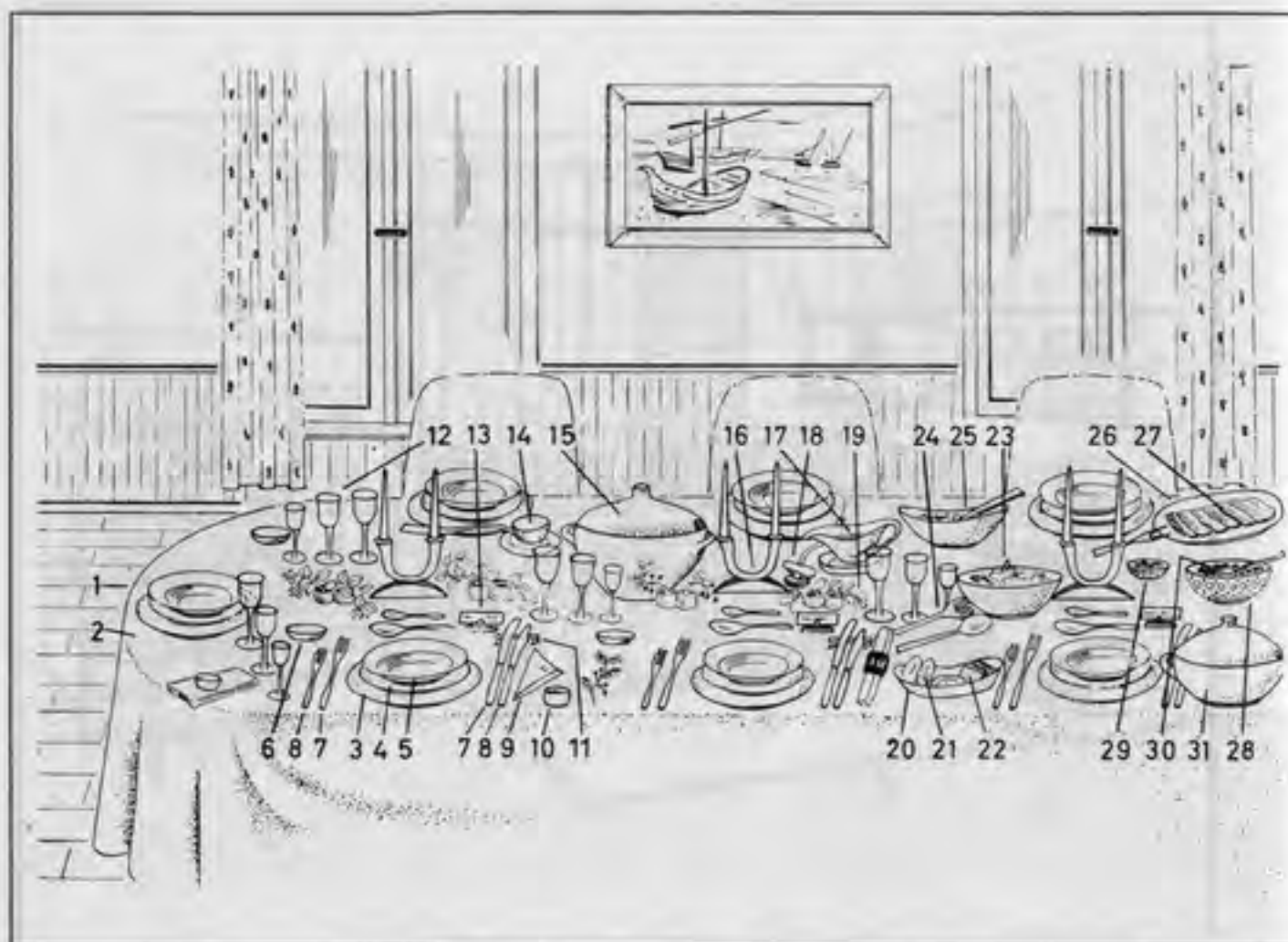

- 1 dining table
 2 tablecloth, a damask cloth
 3-12 **place** (place setting, cover)
 3 bottom plate
 4 dinner plate
 5 deep plate (soup plate)
 6 dessert plate (dessert bowl)
 7 knife and fork
 8 fish knife and fork
 9 serviette (napkin, table napkin)
 10 serviette ring (napkin ring)
 11 knife rest
 12 wineglasses
 13 place card
 14 soup ladle
 15 soup tureen (tureen)
 16 candelabra
 17 sauceboat (gravy boat)
 18 sauce ladle (gravy ladle)
 19 table decoration
 20 bread basket
 21 roll
 22 slice of bread
 23 salad bowl
 24 salad servers
 25 vegetable dish
 26 meat plate (*Am.* meat platter)
 27 roast meat (roast)
 28 fruit dish
 29 fruit bowl
 30 fruit (stewed fruit)
 31 potato dish
 32 serving trolley
 33 vegetable plate (*Am.* vegetable platter)
 34 toast
 35 cheeseboard
 36 butter dish
 37 open sandwich
 38 filling
 39 sandwich
 40 fruit bowl
 41 almonds (*also*: potato crisps, peanuts)
 42 oil and vinegar bottle
 43 ketchup (catchup, catsup)

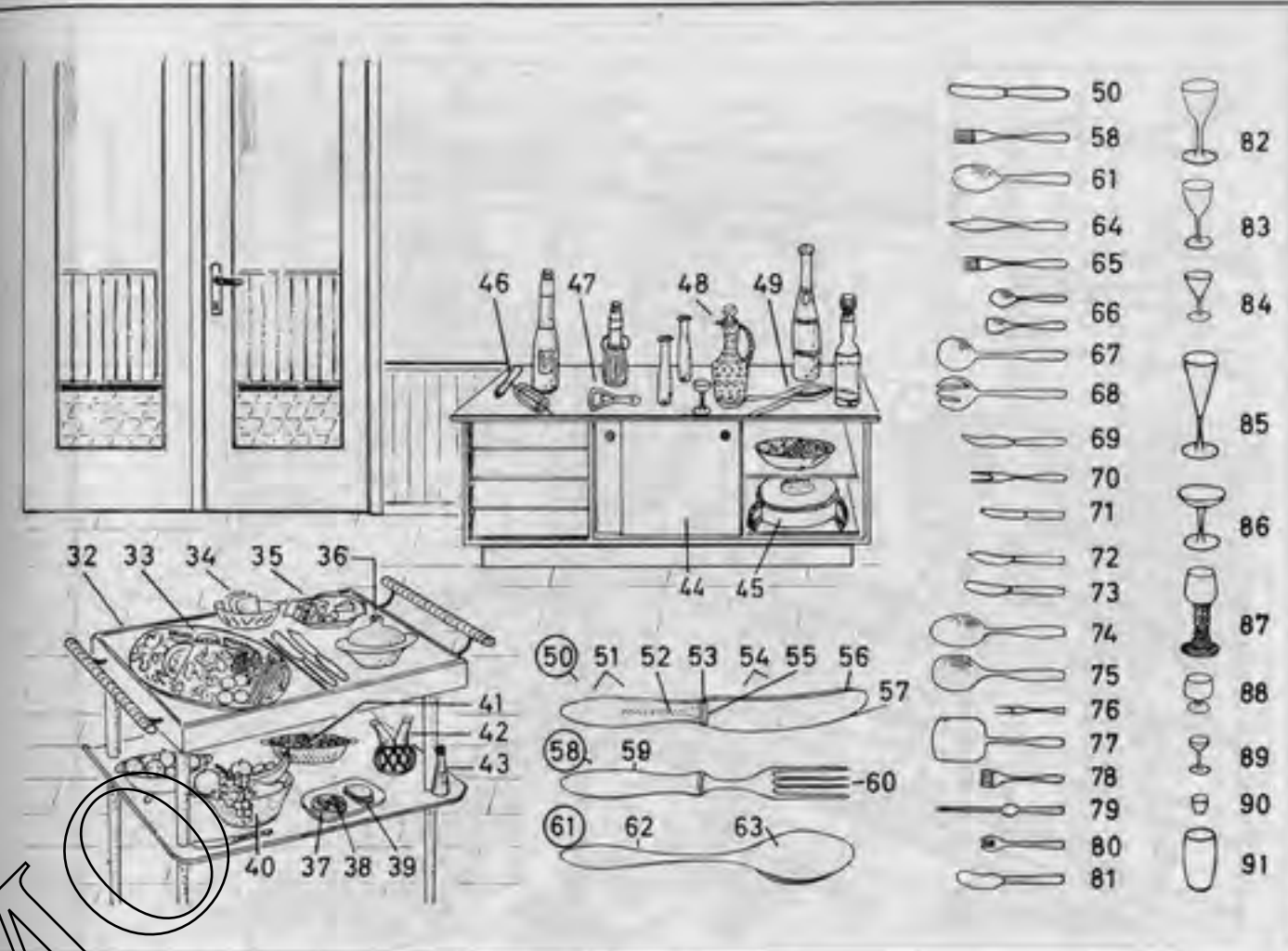

- 44 sideboard
 45 electric hotplate
 46 corkscrew
 47 crown cork bottle-opener (crown cork opener), a bottle-opener
 48 liqueur decanter
 49 nutcrackers (nutcracker)
 50 knife
 51 handle
 52 tang (tongue)
 53 ferrule
 54 blade
 55 bolster
 56 back
 57 edge (cutting edge)
 58 fork
 59 handle
 60 prong (tang, tine)
 61 spoon; *here*: dessert spoon
 62 handle
 63 bowl
 64 fish knife
 65 fish fork
 66 dessert spoon (fruit spoon)
 67 salad spoon
 68 salad fork
 69-70 carving set (serving cutlery)
 69 carving knife
 70 serving fork
 71 fruit knife
 72 cheese knife
 73 butter knife
 74 vegetable spoon, a serving spoon
 75 potato server (serving spoon for potatoes)
 76 cocktail fork
 77 asparagus server (asparagus slice)
 78 sardine server
 79 lobster fork
 80 oyster fork
 81 caviare knife
 82 white wine glass
 83 red wine glass
 84 sherry glass (madeira glass)
 85-86 champagne glasses
 85 tapered glass
 86 champagne glass, a crystal glass
 87 rummer
 88 brandy glass
 89 liqueur glass
 90 spirit glass
 91 beer glass

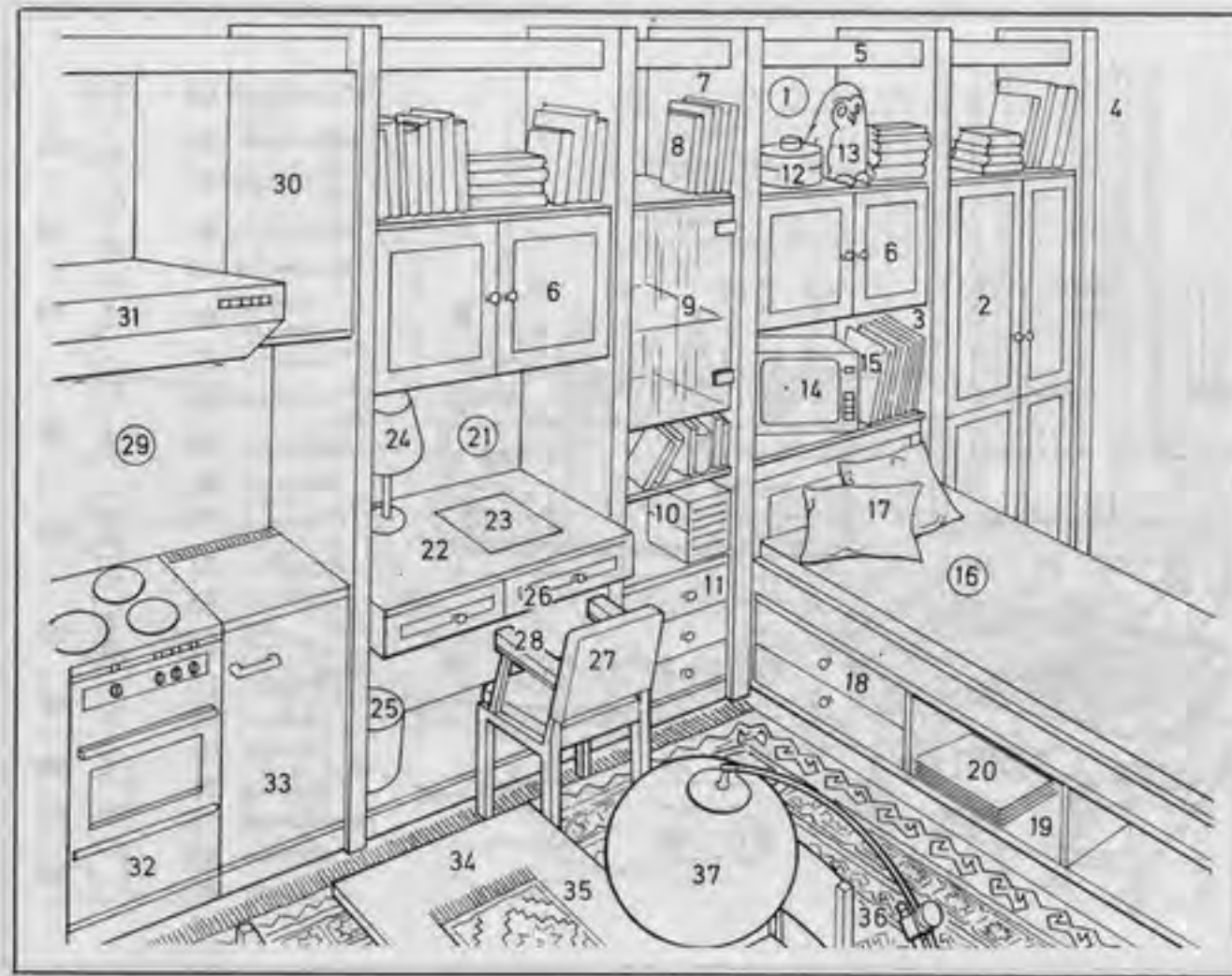

- | | |
|--|--|
| 1 wall units (shelf units) | 24 table lamp |
| 2 wardrobe door (<i>Am.</i> clothes closet door) | 25 wastepaper basket |
| 3 body | 26 desk drawer |
| 4 side wall | 27 desk chair |
| 5 trim | 28 arm |
| 6 two-door cupboard unit | 29 kitchen unit |
| 7 bookshelf unit (bookcase unit) [with glass door] | 30 wall cupboard |
| 8 books | 31 cooker hood |
| 9 display cabinet | 32 electric cooker |
| 10 card index boxes | 33 refrigerator (<i>fridge, Am.</i> icebox) |
| 11 drawer | 34 dining table |
| 12 decorative biscuit tin | 35 table runner |
| 13 soft toy animal | 36 oriental carpet |
| 14 television set (TV set) | 37 standard lamp |
| 15 records (discs) | |
| 16 bed unit | |
| 17 scatter cushion | |
| 18 bed unit drawer | |
| 19 bed unit shelf | |
| 20 magazines | |
| 21 desk unit (writing unit) | |
| 22 desk | |
| 23 desk mat (blotter) | |



- | | |
|--|--|
| 1 children's bed, a bunk-bed | 25 school books |
| 2 storage box | 26 pencil (<i>also: crayon, felt tip pen, ballpoint pen</i>) |
| 3 mattress | 27 toy shop |
| 4 pillow | 28 counter |
| 5 ladder | 29 spice rack |
| 6 soft toy elephant, a cuddly toy animal | 30 display |
| 7 soft toy dog | 31 assortment of sweets (<i>Am.</i> candies) |
| 8 cushion | 32 bag of sweets (<i>Am.</i> candies) |
| 9 fashion doll | 33 scales |
| 10 doll's pram | 34 cash register |
| 11 sleeping doll | 35 toy telephone |
| 12 canopy | 36 shop shelves (goods shelves) |
| 13 blackboard | 37 wooden train set |
| 14 counting beads | 38 dump truck, a toy lorry (toy truck) |
| 15 toy horse for rocking and pulling | 39 tower crane |
| 16 rockers | 40 concrete mixer |
| 17 children's book | 41 large soft toy dog |
| 18 compendium of games | 42 dice cup |
| 19 ludo | |
| 20 chessboard | |
| 21 children's cupboard | |
| 22 linen drawer | |
| 23 drop-flap writing surface | |
| 24 notebook (exercise book) | |



1-20 pre-school education

(nursery education)

- 1 nursery teacher
- 2 nursery child
- 3 handicraft
- 4 glue
- 5 watercolour (*Am.* watercolor) painting
- 6 paintbox
- 7 paintbrush
- 8 glass of water
- 9 jigsaw puzzle (puzzle)
- 10 jigsaw puzzle piece
- 11 coloured (*Am.* colored) pencils (wax crayons)
- 12 modelling (*Am.* modeling) clay (plasticine)
- 13 clay figures (plasticine figures)
- 14 modelling (*Am.* modeling) board
- 15 chalk (blackboard chalk)
- 16 blackboard
- 17 counting blocks
- 18 felt pen (felt tip pen)
- 19 shapes game
- 20 group of players

21-32 toys

- 21 building and filling cupes
- 22 construction set
- 23 children's books
- 24 doll's pram, a wicker pram
- 25 baby doll
- 26 canopy
- 27 building bricks (building blocks)
- 28 wooden model building
- 29 wooden train set
- 30 rocking teddy bear
- 31 doll's pushchair
- 32 fashion doll
- 33 child of nursery school age
- 34 cloakroom

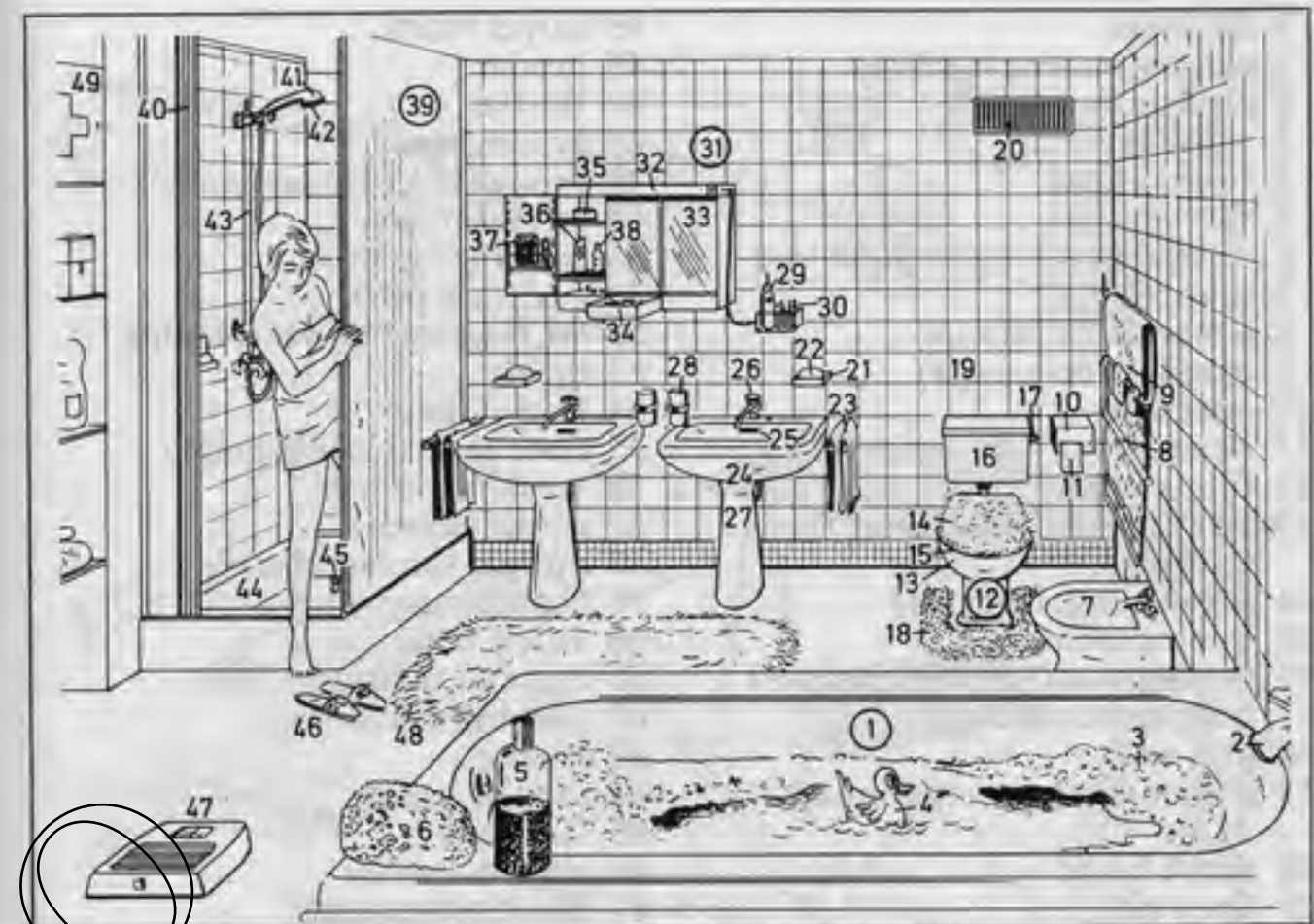

- 1 bath
- 2 mixer tap (*Am.* mixing faucet) for hot and cold water
- 3 foam bath (bubble bath)
- 4 toy duck
- 5 bath salts
- 6 bath sponge (sponge)
- 7 bidet
- 8 towel rail
- 9 terry towel
- 10 toilet roll holder (*Am.* bathroom tissue holder)
- 11 toilet paper (*coll.* loo paper, *Am.* bathroom tissue), a roll of crepe paper
- 12 toilet (lavatory, W.C., *coll.* loo)
- 13 toilet pan (toilet bowl)
- 14 toilet lid with terry cover
- 15 toilet seat
- 16 cistern
- 17 flushing lever
- 18 pedestal mat
- 19 tile
- 20 ventilator (extraction vent)
- 21 soap dish
- 22 soap
- 23 hand towel
- 24 washbasin

- 25 overflow
- 26 hot and cold water tap
- 27 washbasin pedestal with trap (anti-syphon trap)
- 28 tooth glass (tooth mug)
- 29 electric toothbrush
- 30 detachable brush heads
- 31 mirrored bathroom cabinet
- 32 fluorescent lamp
- 33 mirror
- 34 drawer
- 35 powder box
- 36 mouthwash
- 37 electric shaver
- 38 aftershave lotion
- 39 shower cubicle
- 40 shower curtain
- 41 adjustable shower head
- 42 shower nozzle
- 43 shower adjustment rail
- 44 shower base
- 45 waste pipe (overflow)
- 46 bathroom mat
- 47 bathroom scales
- 48 bath mat
- 49 medicine cabinet

- 1-20 irons
- 1 electric ironing machine
- 2 electric foot switch
- 3 roller covering
- 4 ironing head
- 5 sheet
- 6 electric iron, a lightweight iron
- 7 sole-plate
- 8 temperature selector
- 9 handle (iron handle)
- 10 pilot light
- 11 steam, spray, and dry iron
- 12 filling inlet
- 13 spray nozzle for damping the washing
- 14 steam hole (steam slit)
- 15 ironing table
- 16 ironing board (ironing surface)
- 17 ironing-board cover
- 18 iron well
- 19 aluminium (*Am.* aluminum) frame
- 20 sleeve board
- 21 linen bin
- 22 dirty linen
- 23-34 washing machines and driers
- 23 washing machine (automatic washing machine)
- 24 washing drum
- 25 safety latch (safety catch)
- 26 program selector control
- 27 front soap dispenser [with several compartments]
- 28 tumble drier
- 29 drum
- 30 front door with ventilation slits
- 31 work top
- 32 ailer
- 33 clothes line (washing line)
- 34 extending ailer
- 35 stepladder (steps), an aluminium (*Am.* aluminum) ladder
- 36 stile
- 37 prop
- 38 tread (rung)
- 39-43 shoe care utensils
- 39 tin of shoe polish
- 40 shoe spray, an impregnating spray
- 41 shoe brush
- 42 brush for applying polish
- 43 tube of shoe polish
- 44 clothes brush

- 45 carpet brush
- 46 broom
- 47 bristles
- 48 broom head
- 49 broomstick (broom handle)
- 50 screw thread
- 51 washing-up brush
- 52 pan (dust pan)
- 53-86 floor and carpet cleaning
- 53 brush
- 54 bucket (pail)
- 55 floor cloth (cleaning rag)
- 56 scrubbing brush
- 57 carpet sweeper
- 58 upright vacuum cleaner
- 59 changeover switch
- 60 swivel head
- 61 bag-full indicator
- 62 dust bag container
- 63 handle
- 64 tubular handle
- 65 flex hook
- 66 wound-up flex
- 67 all-purpose nozzle
- 68 cylinder vacuum cleaner
- 69 swivel coupling
- 70 extension tube
- 71 floor nozzle (*sim.*: carpet beater nozzle)
- 72 suction control
- 73 bag-full indicator
- 74 sliding fingertip suction control
- 75 hose (suction hose)
- 76 combined carpet sweeper and shampooer
- 77 electric lead (flex)
- 78 plug socket
- 79 carpet beater head (*sim.*: shampooing head, brush head)
- 80 all-purpose vacuum cleaner (dry and wet operation)
- 81 castor
- 82 motor unit
- 83 lid clip
- 84 coarse dirt hose
- 85 special accessory (special attachment) for coarse dirt
- 86 dust container
- 87 shopper (shopping trolley)

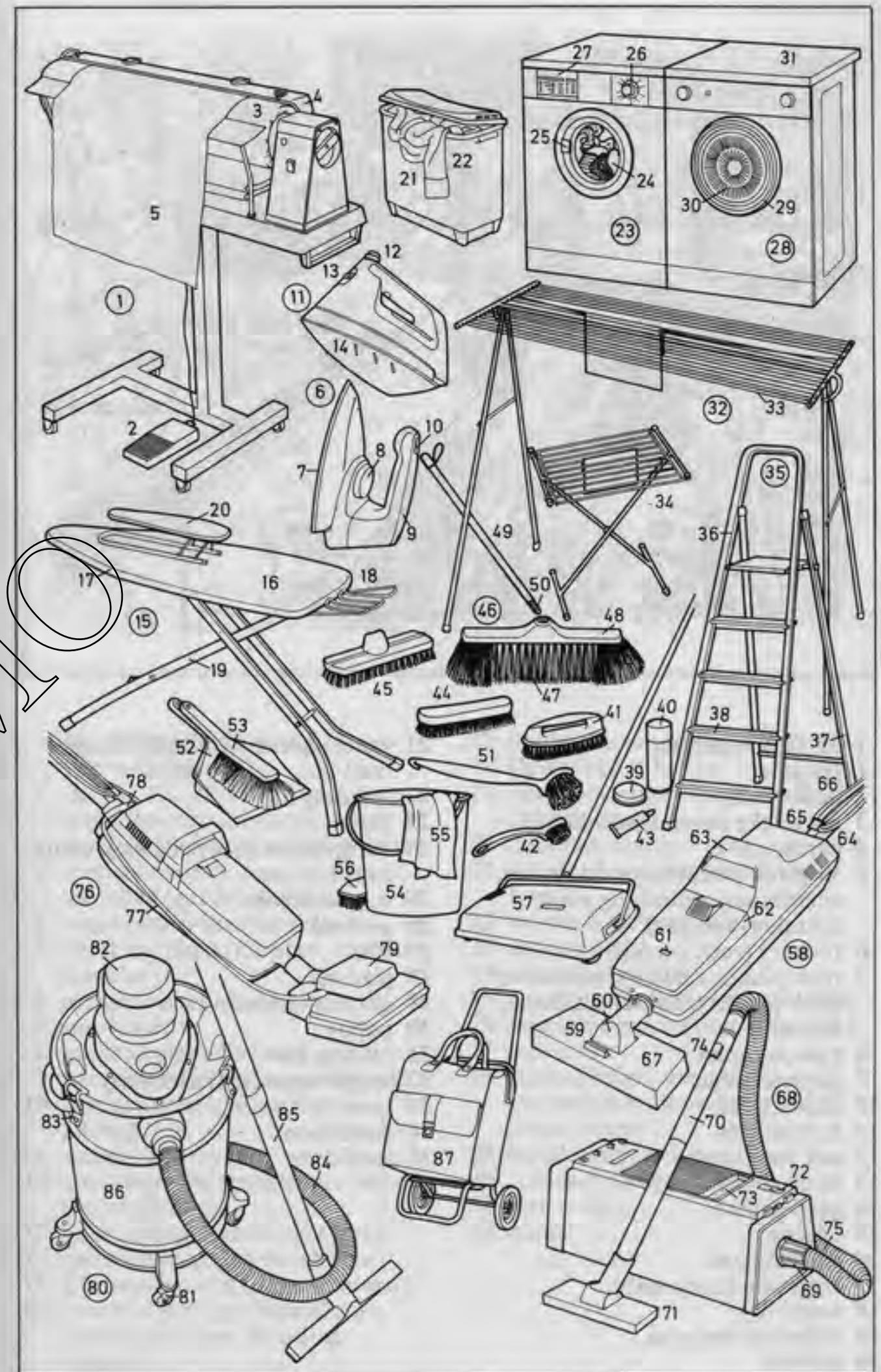

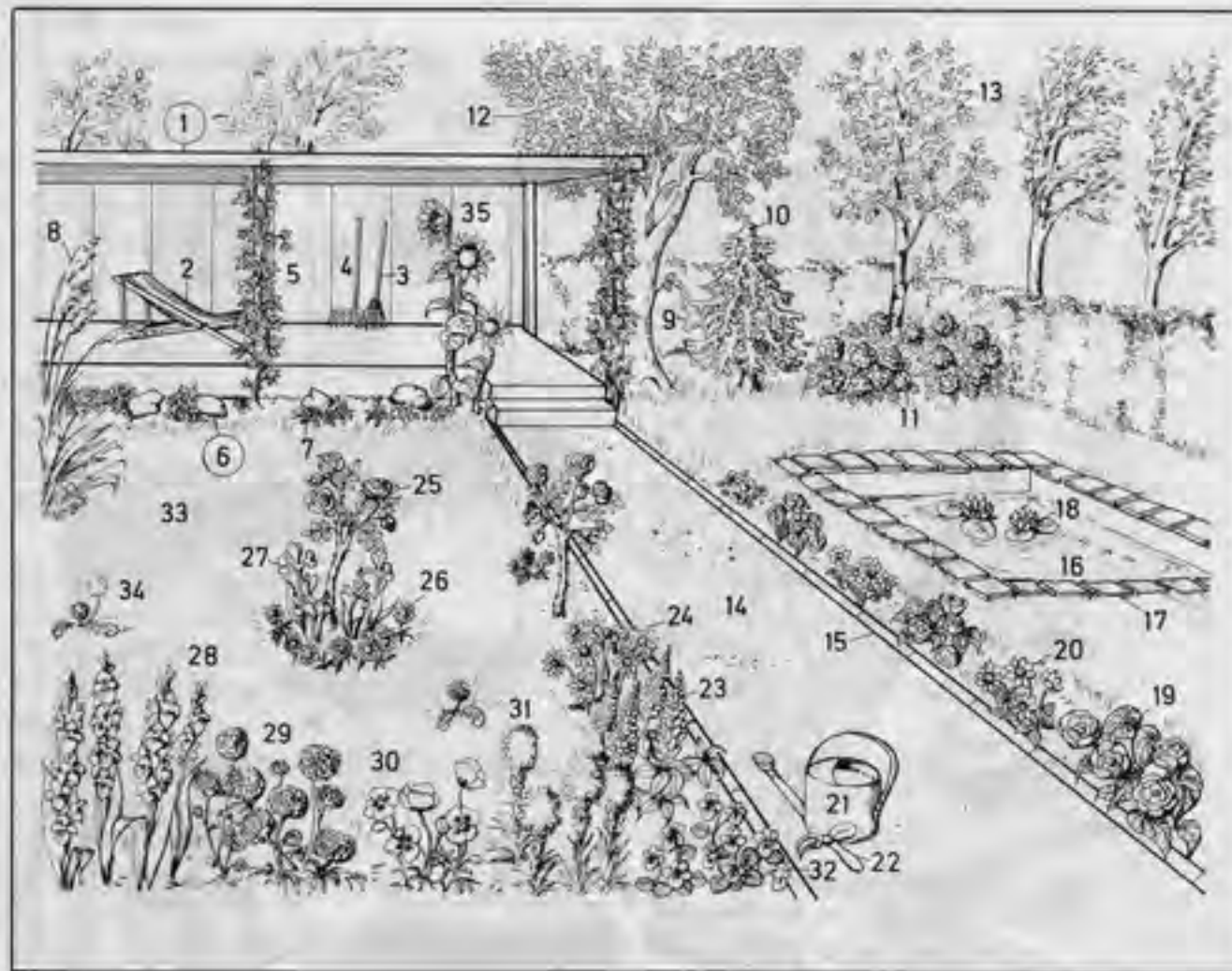

1-35 flower garden

- 1 pergola
- 2 deck-chair
- 3 lawn rake (wire-tooth rake)
- 4 garden rake
- 5 Virginia creeper (American ivy, woodbine), a climbing plant (climber, creeper)
- 6 rockery (rock garden)
- 7 rock plants; *varieties*: stonecrop (wall pepper), houseleek, dryas, aubretia
- 8 pampas grass
- 9 garden hedge
- 10 blue spruce
- 11 hydrangeas
- 12 oak (oak tree)
- 13 birch (birch tree)
- 14 garden path
- 15 edging
- 16 garden pond
- 17 flagstone (stone slab)
- 18 water lily
- 19 tuberous begonias
- 20 dahlias
- 21 watering can (*Am.* sprinkling can)
- 22 weeding hoe
- 23 lupin
- 24 marguerites (oxeye daisies, white oxeye daisies)
- 25 standard rose
- 26 gerbera
- 27 iris
- 28 gladioli
- 29 chrysanthemums
- 30 poppy
- 31 blazing star
- 32 snapdragon (*antirrhinum*)
- 33 lawn
- 34 dandelion
- 35 sunflower

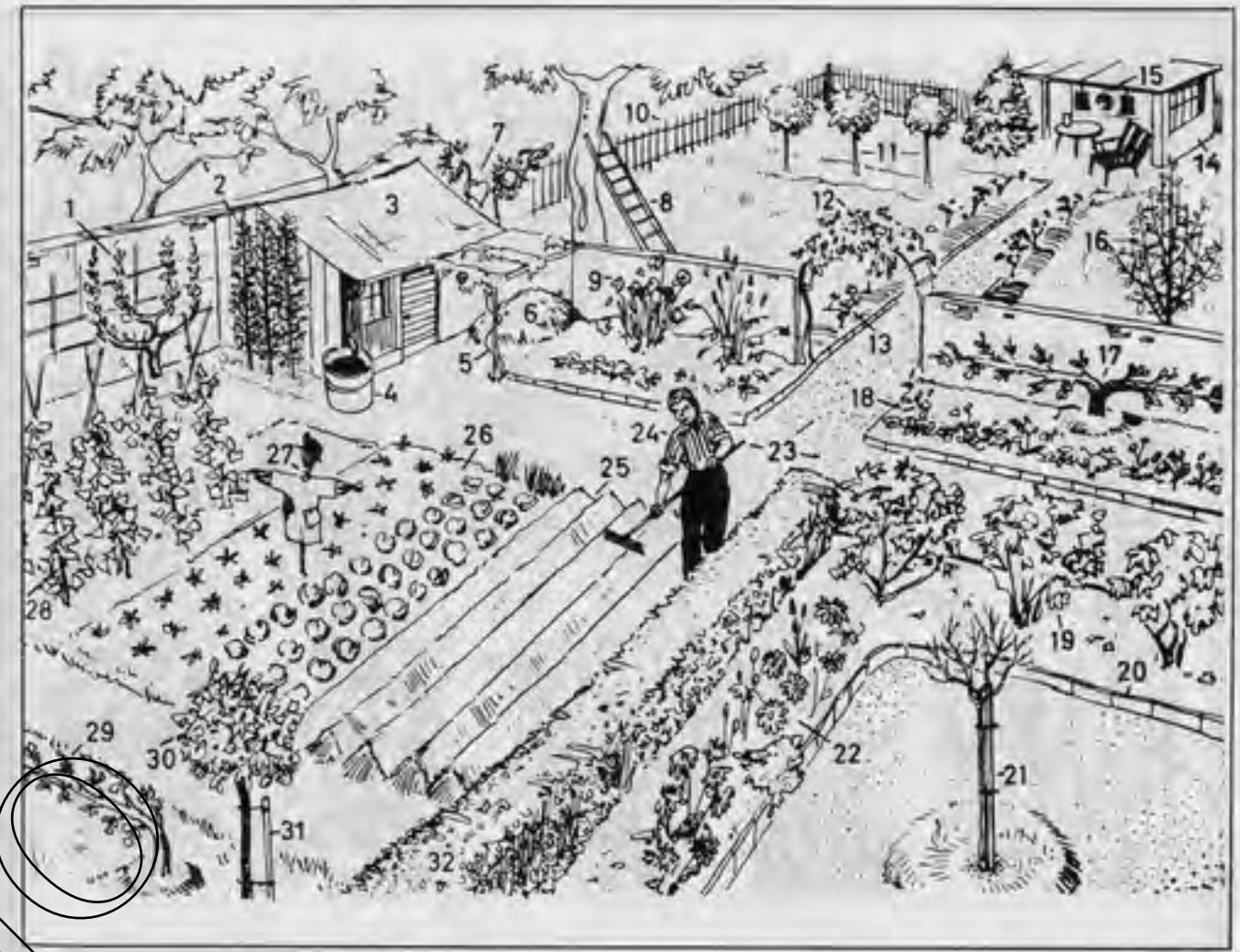

1-32 allotment (fruit and vegetable garden)

- 1, 2, 16, 17, 29 dwarf fruit trees (espaliers, espalier fruit trees)
- 1 quadruple cordon, a wall espalier
- 2 vertical cordon
- 3 tool shed (garden shed)
- 4 water butt (water barrel)
- 5 climbing plant (climber, creeper, rambler)
- 6 compost heap
- 7 sunflower
- 8 garden ladder (ladder)
- 9 perennial (flowering perennial)
- 10 garden fence (paling fence, paling)
- 11 standard berry tree
- 12 climbing rose (rambling rose) on the trellis arch
- 13 bush rose (standard rose tree)
- 14 summerhouse (garden house)
- 15 Chinese lantern (paper lantern)
- 16 pyramid tree (pyramidal tree, pyramid), a free-standing espalier
- 17 double horizontal cordon
- 18 flower bed, a border
- 19 berry bush (gooseberry bush, currant bush)
- 20 concrete edging
- 21 standard rose (standard rose tree)
- 22 border with perennials
- 23 garden path
- 24 allotment holder
- 25 asparagus patch (asparagus bed)
- 26 vegetable patch (vegetable plot)
- 27 scarecrow
- 28 runner bean (*Am.* scarlet runner), a bean plant on poles (bean poles)
- 29 horizontal cordon
- 30 standard fruit tree
- 31 tree stake
- 32 hedge

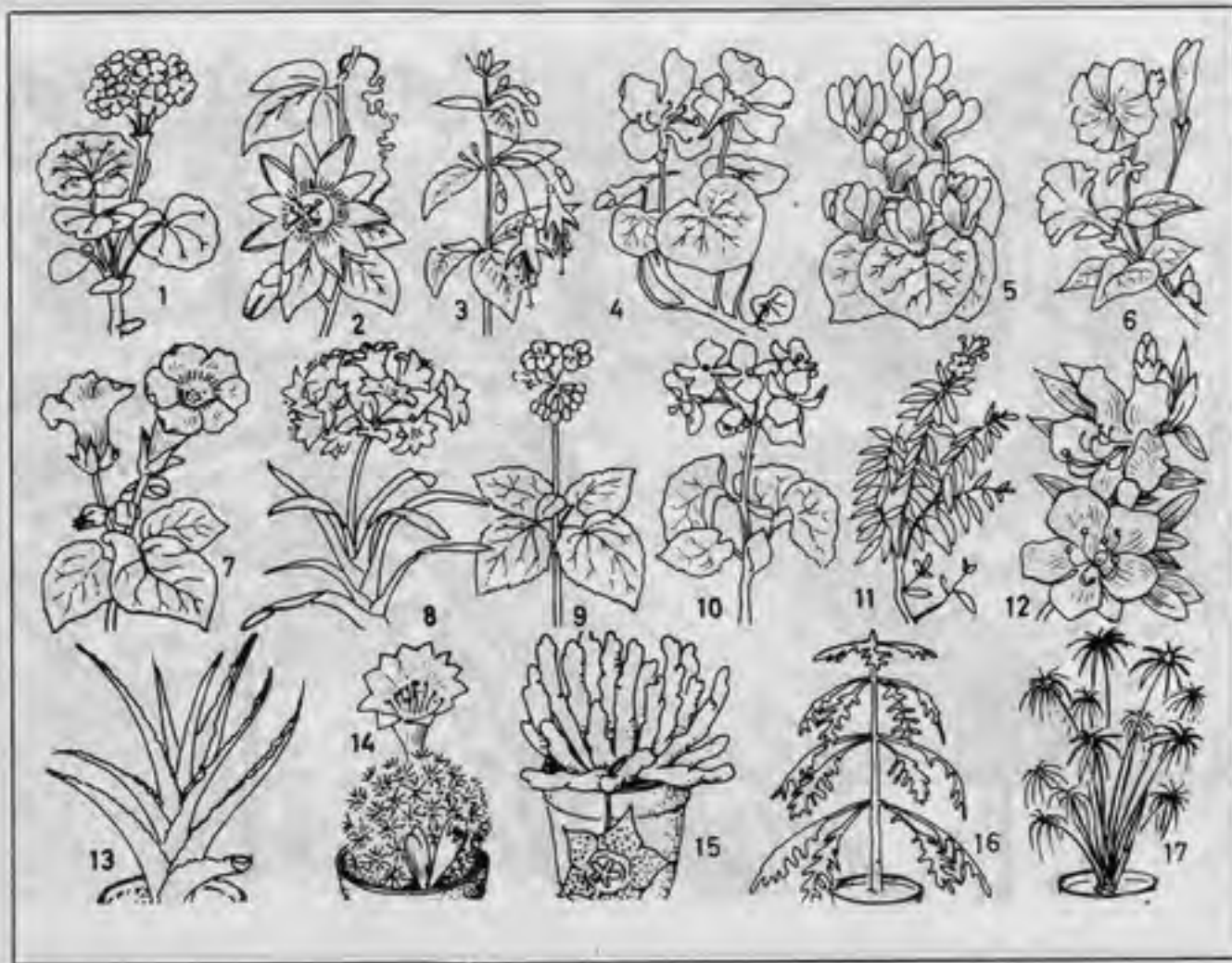

- 1 pelargonium (crane's bill), a geranium
- 2 passion flower (*Passiflora*), a climbing plant (climber, creeper)
- 3 fuchsia, an anagraceous plant
- 4 nasturtium (*Indian cress*, *tropaeolum*)
- 5 cyclamen, a primulaceous herb
- 6 petunia, a solanaceous herb
- 7 gloxinia (*Sinningia*), a gesneriaceous plant
- 8 *Clivia minata*, an amaryllis (narcissus)
- 9 African hemp (*Sparmannia*), a tiliaceous plant, a linden plant
- 10 begonia
- 11 myrtle (common myrtle, *Myrtus*)
- 12 azalea, an ericaceous plant
- 13 aloe, a liliaceous plant
- 14 globe thistle (*Echinops*)
- 15 stapelia (carrion flower), an asclepiadaceous plant

- 16 Norfolk Island Pine (an *araucaria*, grown as an ornamental)
- 17 galingale, a cyperaceous plant of the sedge family

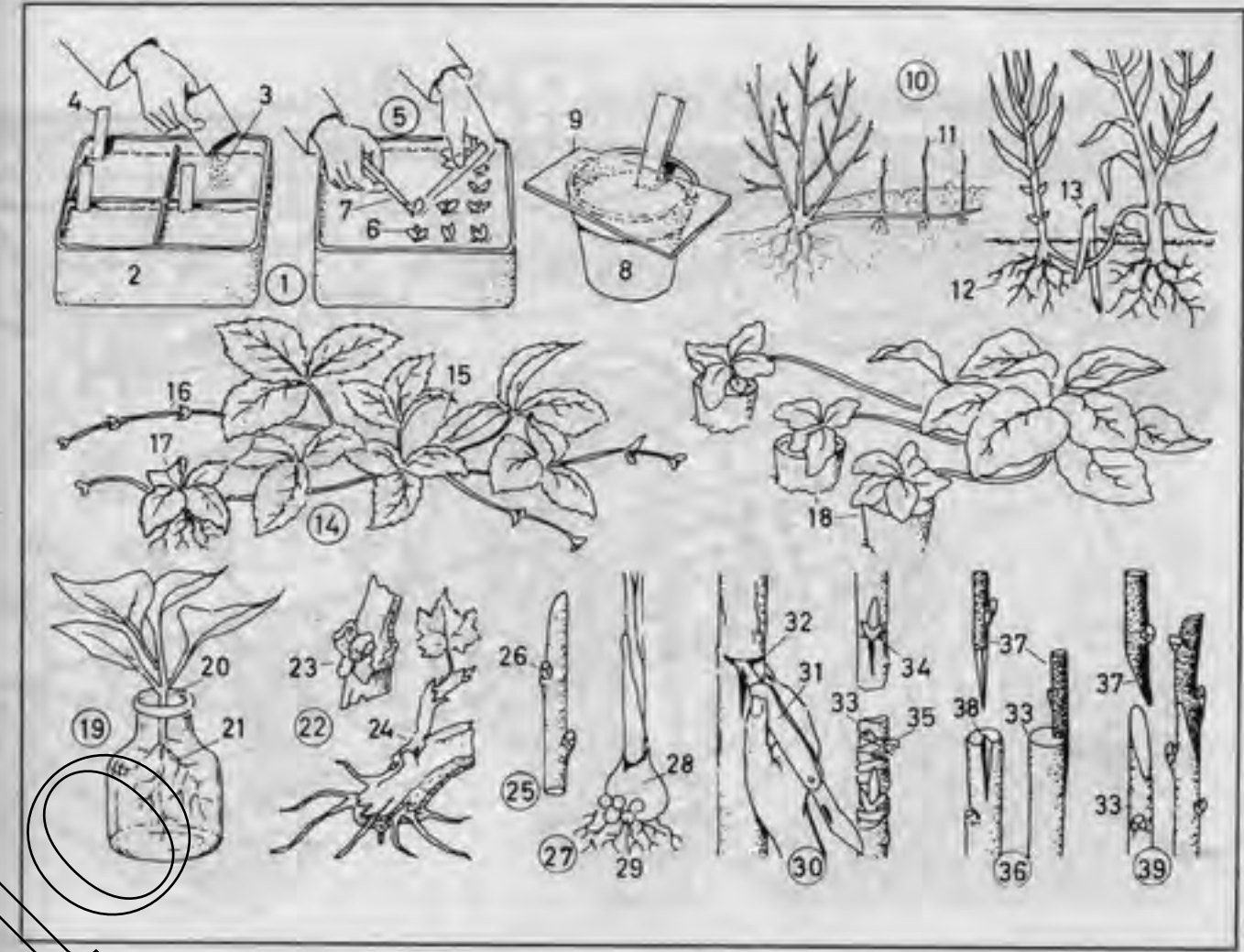

- 1 seed sowing (sowing)
- 2 seed pan
- 3 seed
- 4 label
- 5 pricking out (pricking off, transplanting)
- 6 seedling (seedling plant)
- 7 dibber (dibble)
- 8 flower pot (pot)
- 9 sheet of glass
- 10 propagation by layering
- 11 layer
- 12 layer with roots
- 13 forked stick used for fastening
- 14 propagation by runners
- 15 parent (parent plant)
- 16 runner
- 17 small rooted leaf cluster
- 18 setting in pots
- 19 cutting in water
- 20 cutting (slip, set)
- 21 root
- 22 bud cutting on vine tendril
- 23 scion bud, a bud
- 24 sprouting (shooting) cutting
- 25 stem cutting (hardwood cutting)
- 26 bud
- 27 propagation by bulbils (brood bud bulblets)
- 28 old bulb
- 29 bulbil (brood bud bulblet)
- 30-39 grafting (graftage)
- 30 budding (shield budding)
- 31 budding knife
- 32 T-cut
- 33 support (stock, rootstock)
- 34 inserted scion bud
- 35 raffia layer (bast layer)
- 36 side grafting
- 37 scion (shoot)
- 38 wedge-shaped notch
- 39 splice graft (splice grafting)

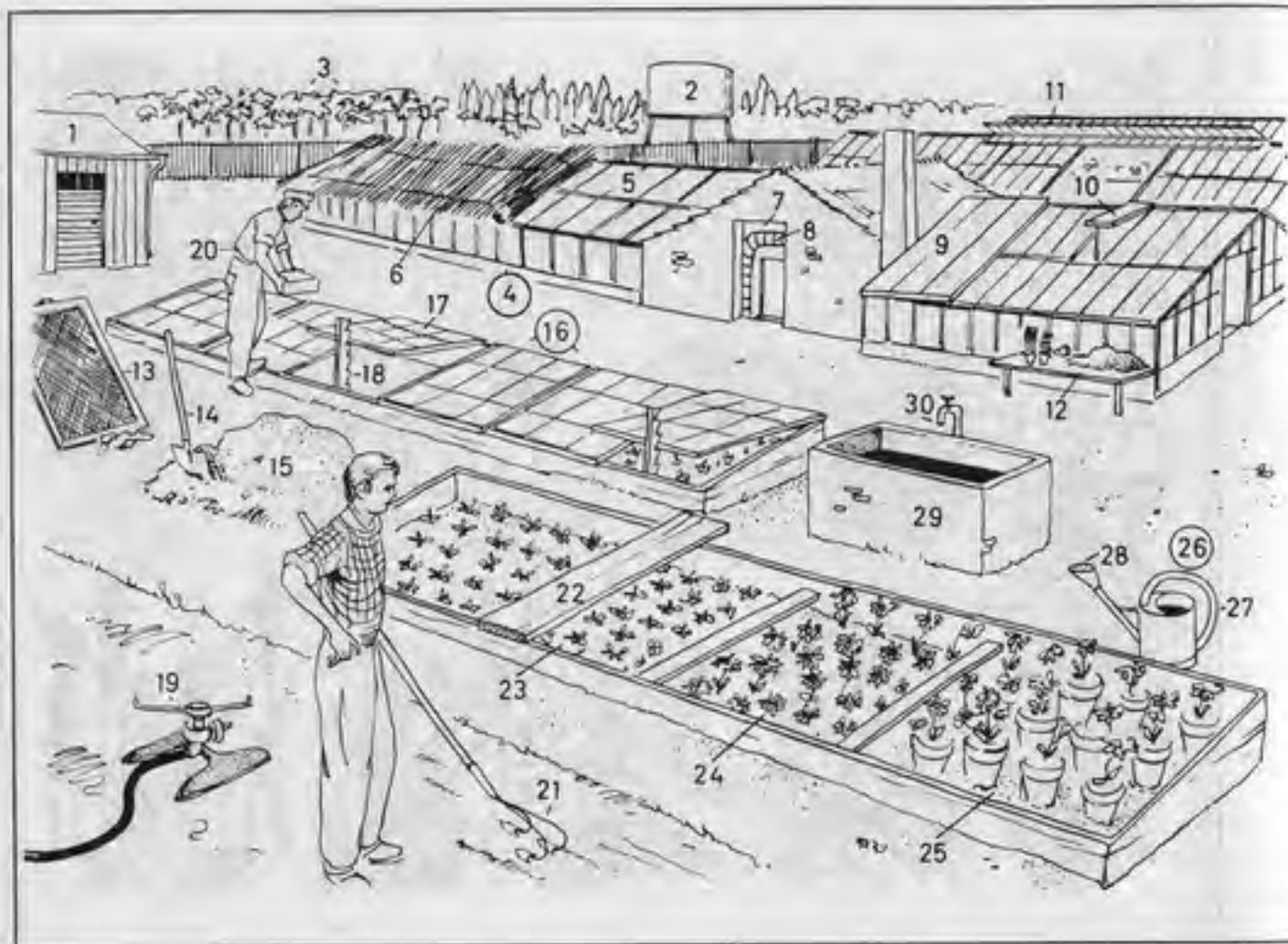
**1-51 market garden (Am. truck garden, truck farm)**

- 1 tool shed
- 2 water tower (water tank)
- 3 market garden (Am. truck garden, truck farm), a tree nursery
- 4 hothouse (forcing house, warm house)
- 5 glass roof
- 6 matting, e.g. straw matting, reed matting
- 7 boiler room (boiler house)
- 8 heating pipe (pressure pipe)
- 9 shading panel (shutter)
- 10-11 ventilators (vents)
- 10 ventilation window (window vent, hinged ventilator)
- 11 ridge vent
- 12 potting table (potting bench)
- 13 riddle (sieve, garden sieve, upright sieve)
- 14 garden shovel (shovel)
- 15 heap of earth (composted earth, prepared earth, garden mould, Am. mold)
- 16 hotbed (forcing bed, heated frame)
- 17 hotbed vent (frame vent)
- 18 vent prop
- 19 sprinkler (sprinkling device)
- 20 gardener (nursery gardener, grower, commercial grower)
- 21 cultivator (hand cultivator, grubber)
- 22 plank
- 23 pricked-out seedlings (pricked-off seedlings)
- 24 forced flowers [forcing]
- 25 potted plants (plants in pots, pot plants)
- 26 watering can (Am. sprinkling can)
- 27 handle
- 28 rose
- 29 water tank

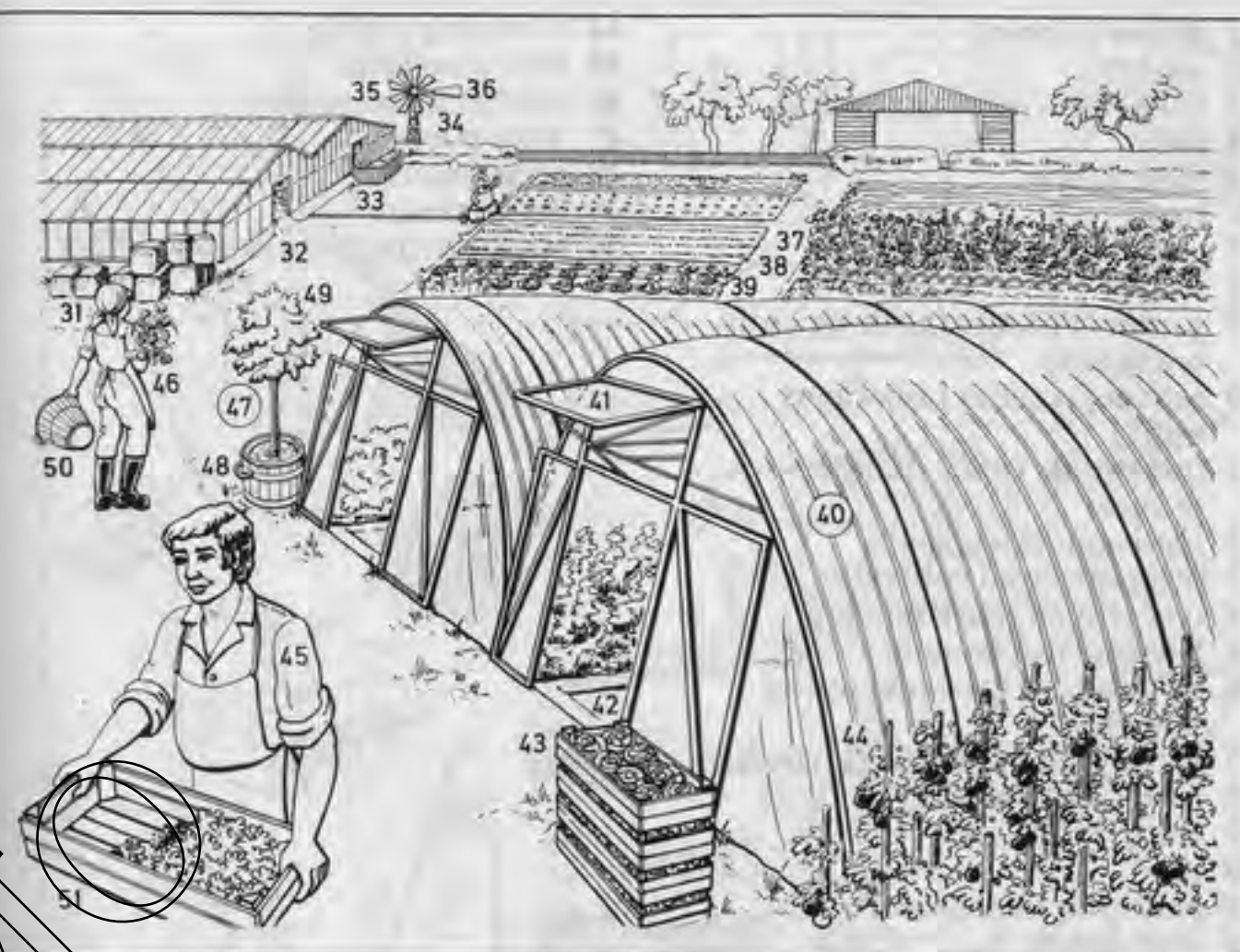

- 30 water pipe
- 31 bale of peat
- 32 warm house (heated greenhouse)
- 33 cold house (unheated greenhouse)
- 34 wind pump; *sim.*: wind generator (aerogenerator)
- 35 wind wheel
- 36 wind vane
- 37 shrub bed, a flower bed
- 38 hoop edging
- 39 vegetable plot
- 40 plastic tunnel (polythene greenhouse)
- 41 ventilation flap
- 42 central path
- 43 vegetable crate
- 44 tomato plant
- 45 nursery hand
- 46 nursery hand
- 47 tub plant
- 48 tub
- 49 orange tree
- 50 wire basket
- 51 seedling box

- 1 dibber (dibble)
- 2 spade
- 3 lawn rake (wire-tooth rake)
- 4 rake
- 5 ridging hoe
- 6 trowel
- 7 combined hoe and fork
- 8 sickle
- 9 gardener's knife (pruning knife, billhook)
- 10 asparagus cutter (asparagus knife)
- 11 tree pruner (long-handled pruner)
- 12 semi-automatic spade
- 13 three-pronged cultivator
- 14 tree scraper (bark scraper)
- 15 lawn aerator (aerator)
- 16 pruning saw (saw for cutting branches)
- 17 battery-operated hedge trimmer
- 18 motor cultivator
- 19 electric drill
- 20 gear
- 21 cultivator attachment
- 22 fruit picker
- 23 tree brush (bark brush)
- 24 sprayer for pest control
- 25 lance
- 26 hose reel (reel and carrying cart)
- 27 garden hose
- 28 motor lawn mower (motor mower)
- 29 grassbox
- 30 two-stroke motor
- 31 electric lawn mower (electric mower)
- 32 electric lead (electric cable)
- 33 cutting unit
- 34 hand mower
- 35 cutting cylinder
- 36 blade
- 37 riding mower
- 38 brake lock
- 39 electric starter
- 40 brake pedal
- 41 cutting unit
- 42 tip-up trailer
- 43 revolving sprinkler, a lawn sprinkler
- 44 revolving nozzle
- 45 hose connector
- 46 oscillating sprinkler
- 47 wheelbarrow
- 48 grass shears
- 49 hedge shears
- 50 secateurs (pruning shears)

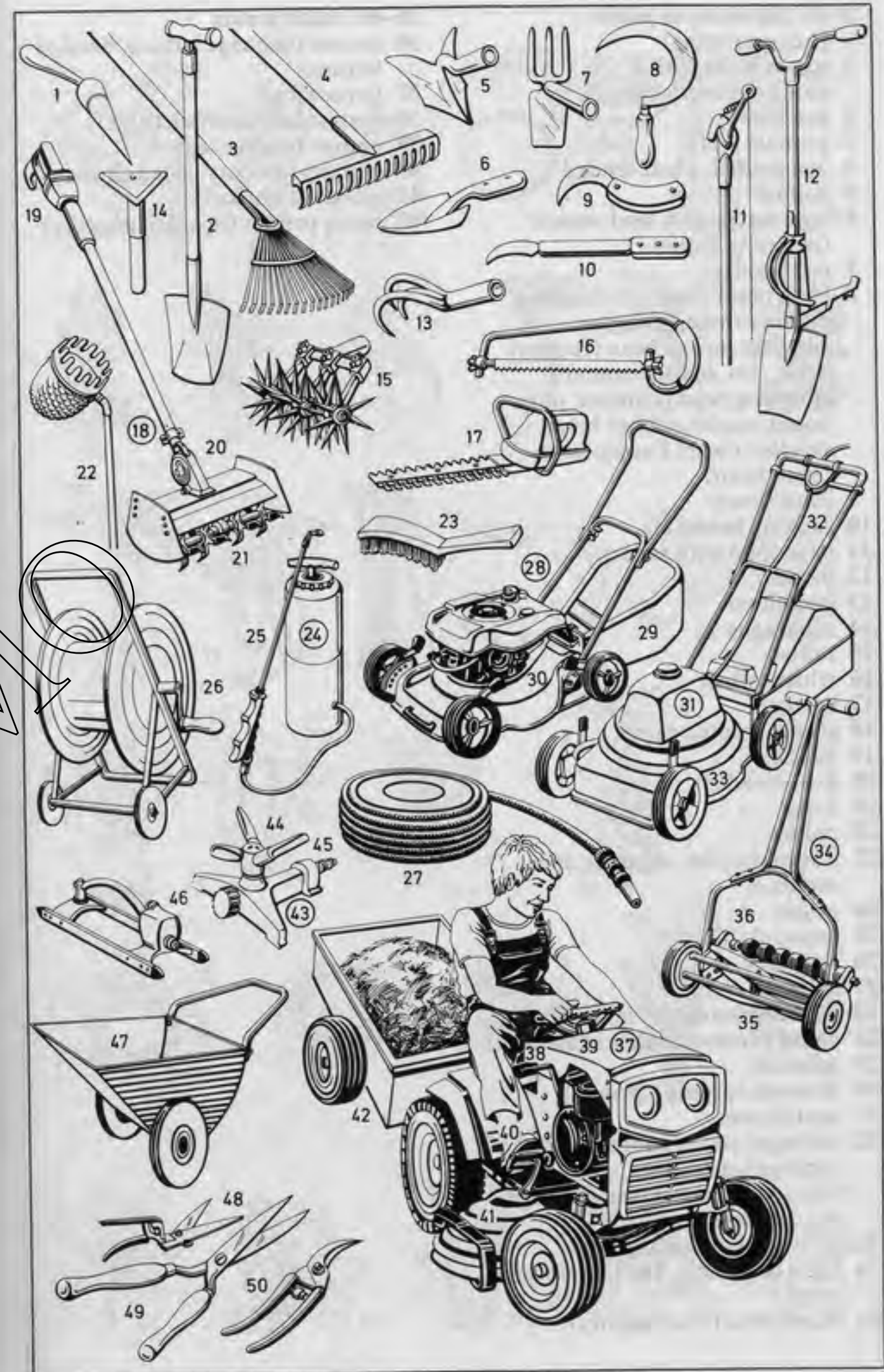

1-11 leguminous plants

(Leguminosae)

- 1 pea, a plant with a papilionaceous corolla
- 2 pea flower
- 3 pinnate leaf
- 4 pea tendril, a leaf tendril
- 5 stipule
- 6 legume (pod), a seed vessel (pericarp, legume)
- 7 pea [seed]
- 8 bean plant (bean), a climbing plant (climber, creeper); *varieties*: broad bean (runner bean, *Am.* scarlet runner), climbing bean (climber, pole bean), scarlet runner bean; *smaller*: dwarf French bean (bush bean)
- 9 bean flower
- 10 twining beanstalk
- 11 bean [pod with seeds]
- 12 tomato
- 13 cucumber
- 14 asparagus
- 15 radish
- 16 white radish
- 17 carrot
- 18 stump-rooted carrot
- 19 parsley
- 20 horse-radish
- 21 leeks
- 22 chives
- 23 pumpkin (*Am.* squash); *sim.*: melon
- 24 onion
- 25 onion skin
- 26 kohlrabi
- 27 celeriac
- 28-34 brassicas (leaf vegetables)
- 28 chard (Swiss chard, seakale beet)
- 29 spinach
- 30 Brussels sprouts (sprouts)
- 31 cauliflower
- 32 cabbage (round cabbage, head of cabbage), a brassica; *cultivated races (cultivars)*: green cabbage, red cabbage
- 33 savoy (savoy cabbage)
- 34 kale (curly kale, kail), a winter green
- 35 scorzonera (black salsify)

36-40 salad plants

- 36 lettuce (cabbage lettuce, head of lettuce)
- 37 lettuce leaf
- 38 corn salad (lamb's lettuce)
- 39 endive (endive leaves)
- 40 chicory (succory, salad chicory)
- 41 globe artichoke
- 42 sweet pepper (Spanish paprika)

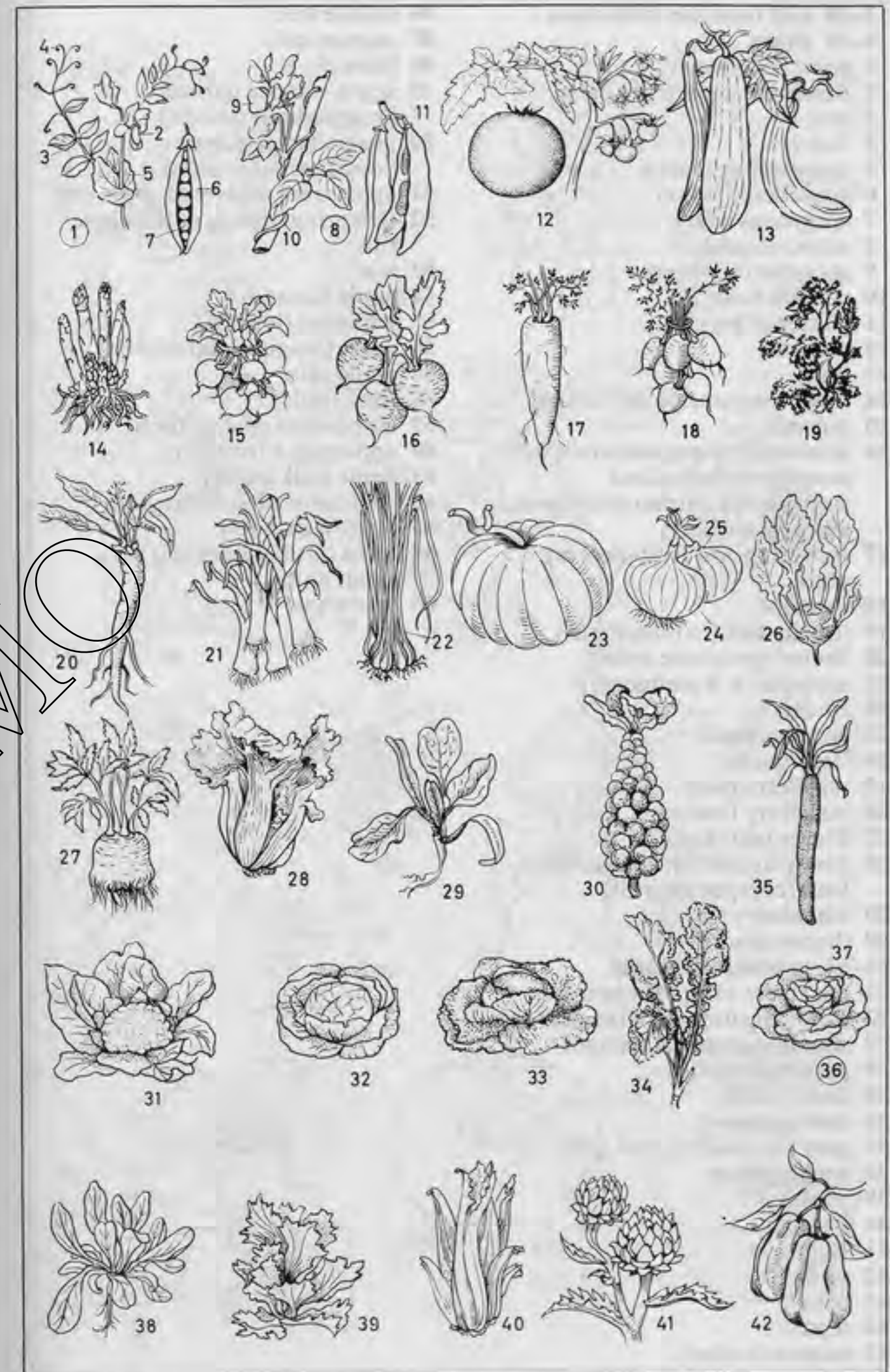

1-30 soft fruit (berry bushes)

1-15 Ribes

- 1 gooseberry bush
- 2 flowering gooseberry cane
- 3 leaf
- 4 flower
- 5 magpie moth larva
- 6 gooseberry flower
- 7 epigynous ovary
- 8 calyx (sepals)
- 9 gooseberry, a berry
- 10 currant bush
- 11 cluster of berries
- 12 currant
- 13 stalk
- 14 flowering cane of the currant
- 15 raceme
- 16 strawberry plant; *varieties*: wild strawberry (woodland strawberry), garden strawberry, alpine strawberry
- 17 flowering and fruit-bearing plant
- 18 rhizome
- 19 ternate leaf (trifoliate leaf)
- 20 runner (prostrate stem)
- 21 strawberry, a pseudocarp
- 22 epicalyx
- 23 achene (seed)
- 24 flesh (pulp)
- 25 raspberry bush
- 26 raspberry flower
- 27 flower bud (bud)
- 28 fruit (raspberry), an aggregate fruit (compound fruit)
- 29 blackberry
- 30 thorny tendril

31-61 pomiferous plants

- 31 pear tree; *wild*: wild pear tree
- 32 flowering branch of the pear tree
- 33 pear [longitudinal section]
- 34 pear stalk (stalk)
- 35 flesh (pulp)
- 36 core (carpels)
- 37 pear pip (seed), a fruit pip
- 38 pear blossom
- 39 ovules
- 40 ovary
- 41 stigma
- 42 style
- 43 petal
- 44 sepal
- 45 stamen (anther)

- 46 quince tree
- 47 quince leaf
- 48 stipule
- 49 apple-shaped quince [longitudinal section]
- 50 pear-shaped quince [longitudinal section]
- 51 apple tree; *wild*: crab apple tree
- 52 flowering branch of the apple tree
- 53 leaf
- 54 apple blossom
- 55 withered flower
- 56 apple [longitudinal section]
- 57 apple skin
- 58 flesh (pulp)
- 59 core (apple core, carpels)
- 60 apple pip, a fruit pip
- 61 apple stalk (stalk)
- 62 codling moth (codlin moth)
- 63 burrow (tunnel)
- 64 larva (grub, caterpillar) of a small moth
- 65 wormhole

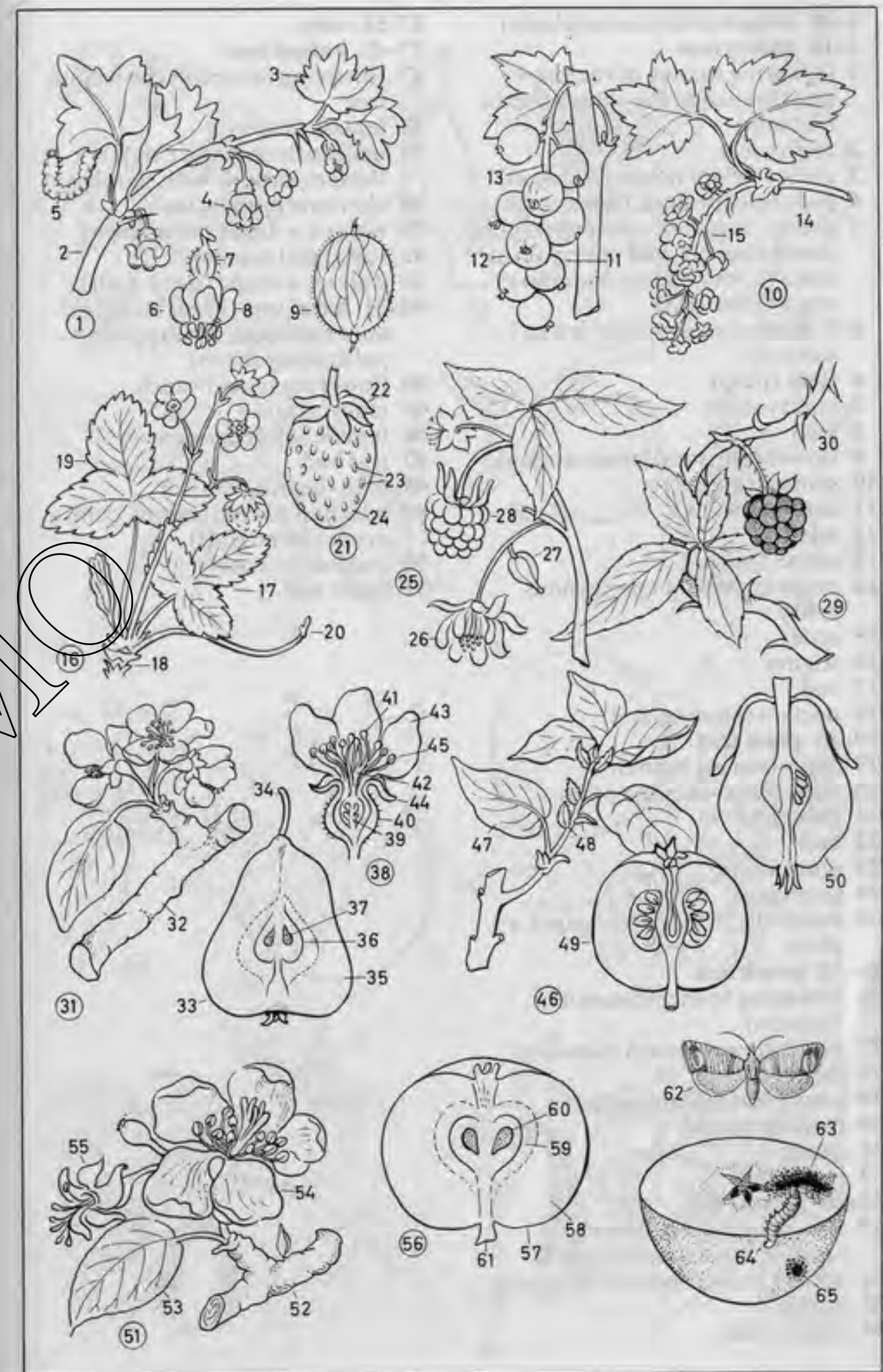

- 1-36 drupes (drupaceous plants)
 1-18 cherry tree
 1 flowering branch of the cherry tree (branch of the cherry tree in blossom)
 2 cherry leaf
 3 cherry flower (cherry blossom)
 4 peduncle (pedicel, flower stalk)
 5 cherry; *varieties*: sweet cherry (heart cherry), wild cherry (bird cherry), sour cherry, morello cherry (morello)
 6-8 cherry (cherry fruit) [cross section]
 6 flesh (pulp)
 7 cherry stone
 8 seed
 9 flower (blossom) [cross section]
 10 stamen (anther)
 11 corolla (petals)
 12 sepal
 13 carpel (pistil)
 14 ovule enclosed in perigynous ovary
 15 style
 16 stigma
 17 leaf
 18 nectary (honey gland)
 19-23 plum tree
 19 fruit-bearing branch
 20 oval, black-skinned plum
 21 plum leaf
 22 bud
 23 plum stone
 24 greengage
 25 mirabelle (transparent gage), a plum
 26-32 peach tree
 26 flowering branch (branch in blossom)
 27 peach flower (peach blossom)
 28 flower shoot
 29 young leaf (sprouting leaf)
 30 fruiting branch
 31 peach
 32 peach leaf
 33-36 apricot tree
 33 flowering apricot branch (apricot branch in blossom)
 34 apricot flower (apricot blossom)
 35 apricot
 36 apricot leaf

- 37-51 nuts
 37-43 walnut tree
 37 flowering branch of the walnut tree
 38 female flower
 39 male inflorescence (male flowers, catkins with stamens)
 40 alternate pinnate leaf
 41 walnut, a drupe (stone fruit)
 42 soft shell (cupule)
 43 walnut, a drupe (stone fruit)
 44-51 hazel tree (hazel bush), an anemophilous shrub (a wind-pollinating shrub)
 44 flowering hazel branch
 45 male catkin
 46 female inflorescence
 47 leaf bud
 48 fruit-bearing branch
 49 hazelnut (hazel, cobnut, cob), a drupe (stone fruit)
 50 involucre (husk)
 51 hazel leaf

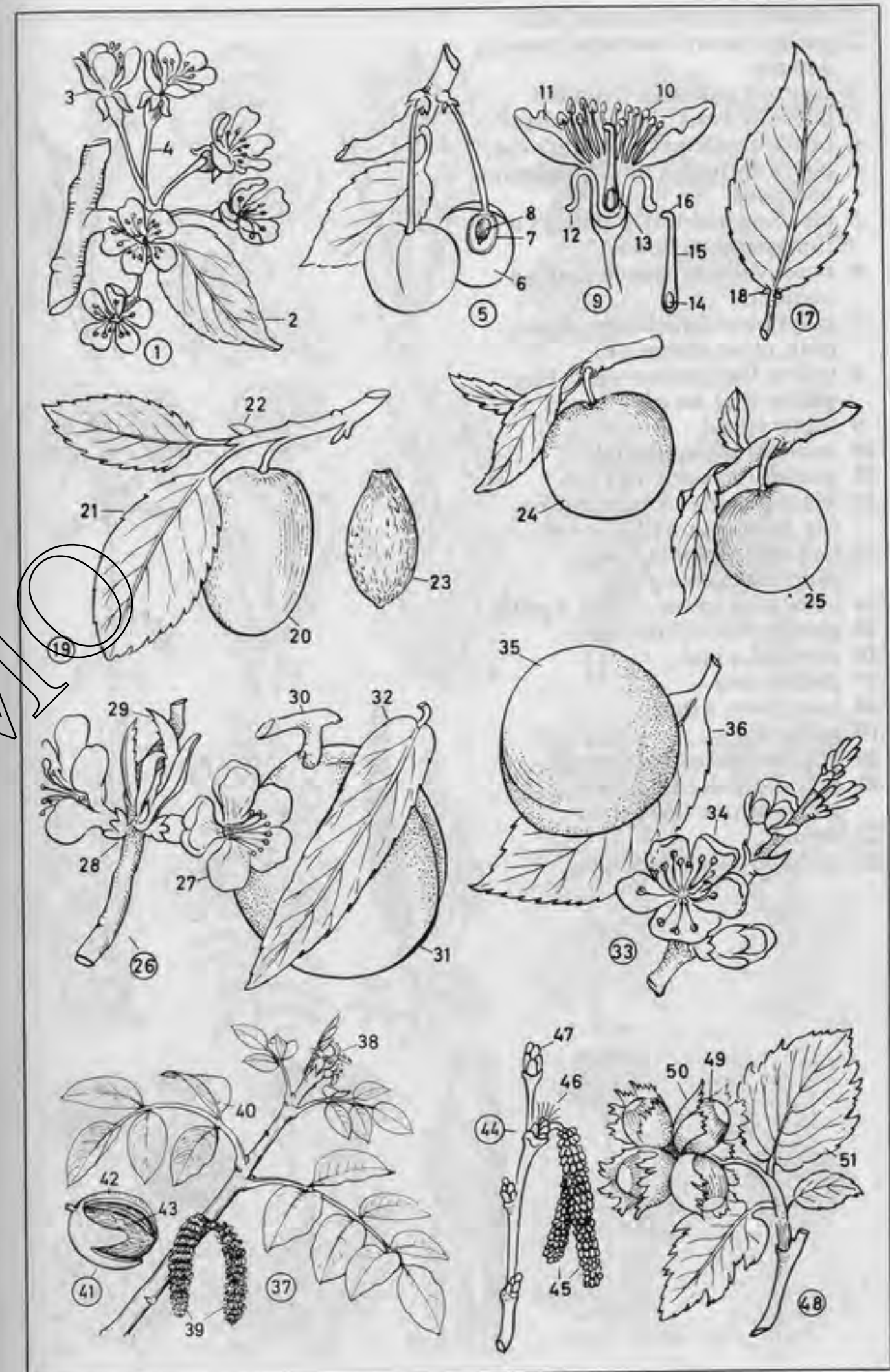

- 1 snowdrop (spring snowflake)
- 2 garden pansy (heartsease pansy), a pansy
- 3 trumpet narcissus (trumpet daffodil, Lent lily), a narcissus
- 4 poet's narcissus (pheasant's eye, poet's daffodil); *sim.*: polyanthus narcissus
- 5 bleeding heart (lyre flower), a fumariaceous flower
- 6 sweet william (bunch pink), a carnation
- 7 gillyflower (gilliflower, clove pink, clove carnation)
- 8 yellow flag (yellow water flag, yellow iris), an iris
- 9 tuberose
- 10 columbine (aquilegia)
- 11 gladiolus (sword lily)
- 12 Madonna lily (Annunciation lily, Lent lily), a lily
- 13 larkspur (delphinium), a ranunculaceous plant
- 14 moss pink (moss phlox), a phlox
- 15 garden rose (China rose)
- 16 rosebud, a bud
- 17 double rose
- 18 rose thorn, a thorn
- 19 gaillardia
- 20 African marigold (tagetes)
- 21 love-lies-bleeding, an amaranthine flower
- 22 zinnia
- 23 pompon dahlia, a dahlia

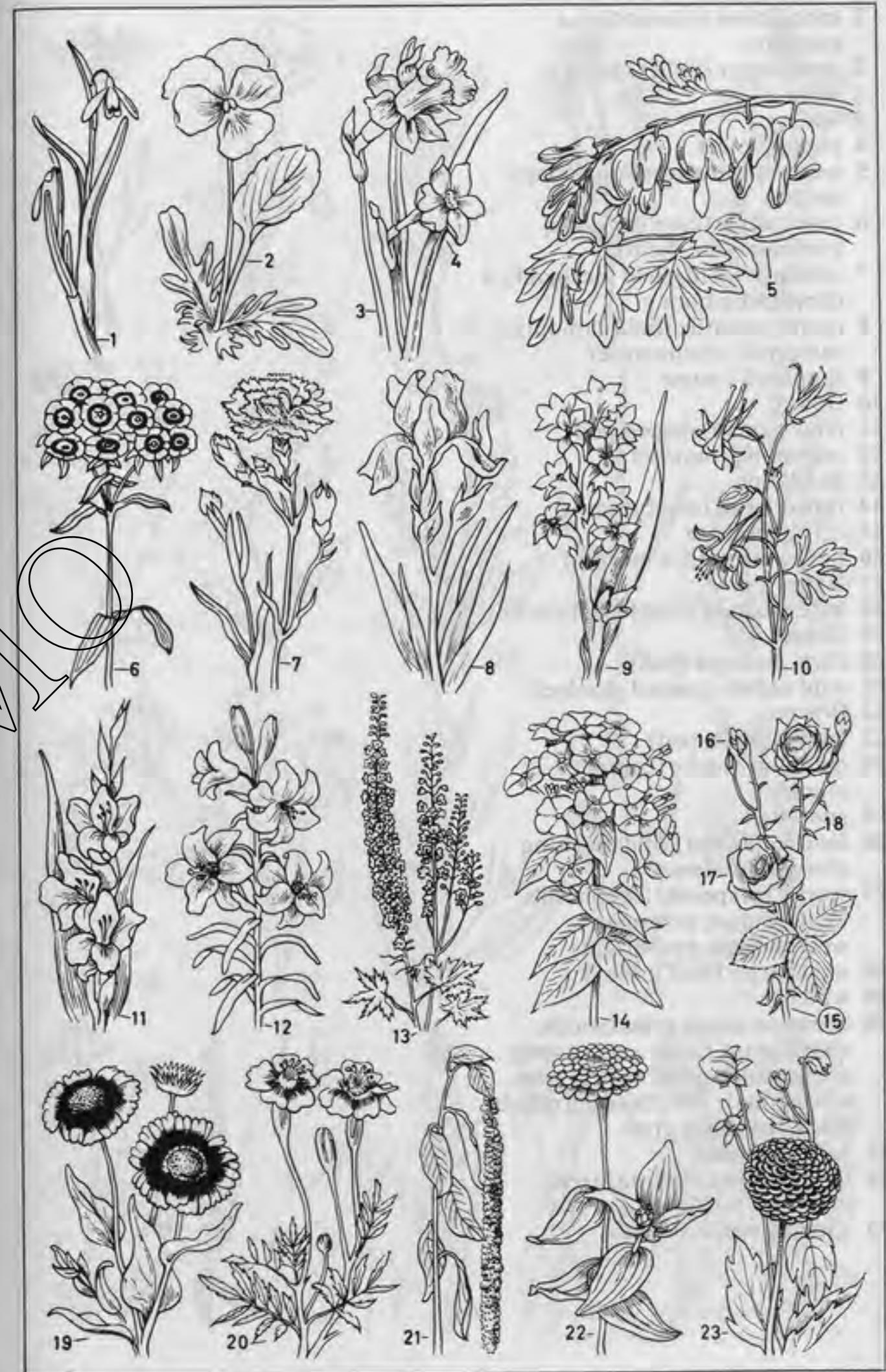

- 1 corn flower (bluebottle), a centaury
- 2 corn poppy (field poppy), a poppy
- 3 bud
- 4 poppy flower
- 5 seed capsule containing poppy seeds
- 6 corn cockle (corn campion, crown-of-the-field)
- 7 corn marigold (field marigold), a chrysanthemum
- 8 corn camomile (field camomile, camomile, chamomile)
- 9 shepherd's purse
- 10 flower
- 11 fruit (pouch-shaped pod)
- 12 common groundsel
- 13 dandelion
- 14 flower head (capitulum)
- 15 infructescence
- 16 hedge mustard, a mustard
- 17 stonecrop
- 18 wild mustard (charlock, runch)
- 19 flower
- 20 fruit, a siliqua (pod)
- 21 wild radish (jointed charlock)
- 22 flower
- 23 fruit (siliqua, pod)
- 24 common orache (common orach)
- 25 goosefoot
- 26 field bindweed (wild morning glory), a bindweed
- 27 scarlet pimpernel (shepherd's weatherglass, poor man's weatherglass, eye-bright)
- 28 wild barley (wall barley)
- 29 wild oat
- 30 common couch grass (couch, quack grass, quick grass, quitch grass, scutch grass, twitch grass, witchgrass); *sim.*: bearded couch grass, sea couch grass
- 31 gallant soldier
- 32 field eryngo (Watling Street thistle), a thistle
- 33 stinging nettle, a nettle



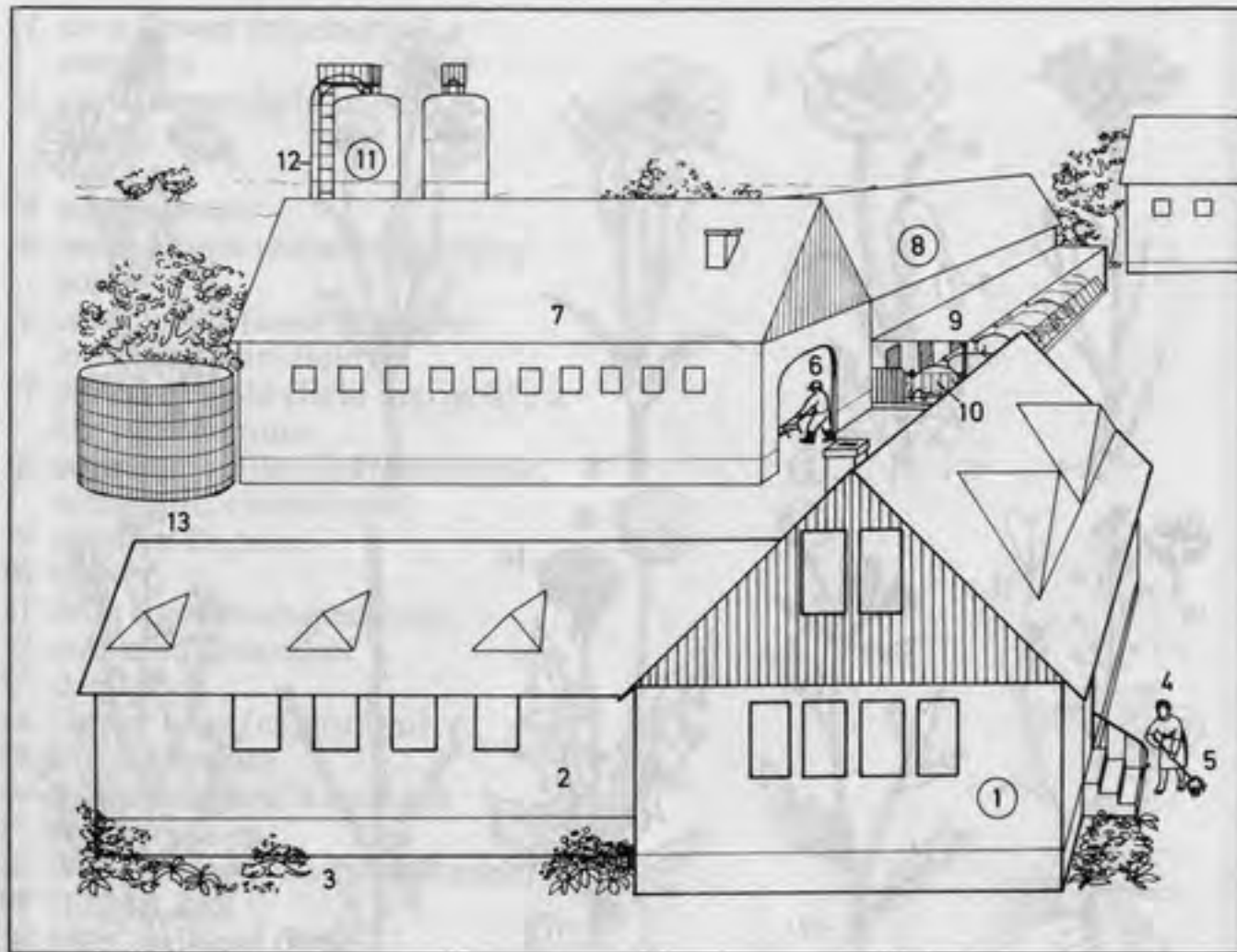

- 1 house
- 2 stable
- 3 house cat (cat)
- 4 farmer's wife
- 5 broom
- 6 farmer
- 7 cowshed
- 8 pigsty (sty, *Am.* pigpen, hogpen)
- 9 outdoor trough
- 10 pig
- 11 above-ground silo (fodder silo)
- 12 silo pipe (standpipe for filling the silo)
- 13 liquid manure silo
- 14 outhouse
- 15 machinery shed
- 16 sliding door
- 17 door to the workshop
- 18 three-way tip-cart, a transport vehicle
- 19 tipping cylinder
- 20 shafts
- 21 manure spreader (fertilizer spreader, manure distributor)

- 22 spreader unit (distributor unit)
- 23 spreader cylinder (distributor cylinder)
- 24 movable scraper floor
- 25 side planking (side board)
- 26 wire mesh front
- 27 sprinkler cart
- 28 sprinkler stand
- 29 sprinkler, a revolving sprinkler
- 30 sprinkler hoses
- 31 farmyard
- 32 watchdog
- 33 calf
- 34 dairy cow (milch-cow, milker)
- 35 farmyard hedge
- 36 chicken (hen)
- 37 cock (*Am.* rooster)
- 38 tractor
- 39 tractor driver
- 40 all-purpose trailer
- 41 [folded] pickup attachment
- 42 unloading unit

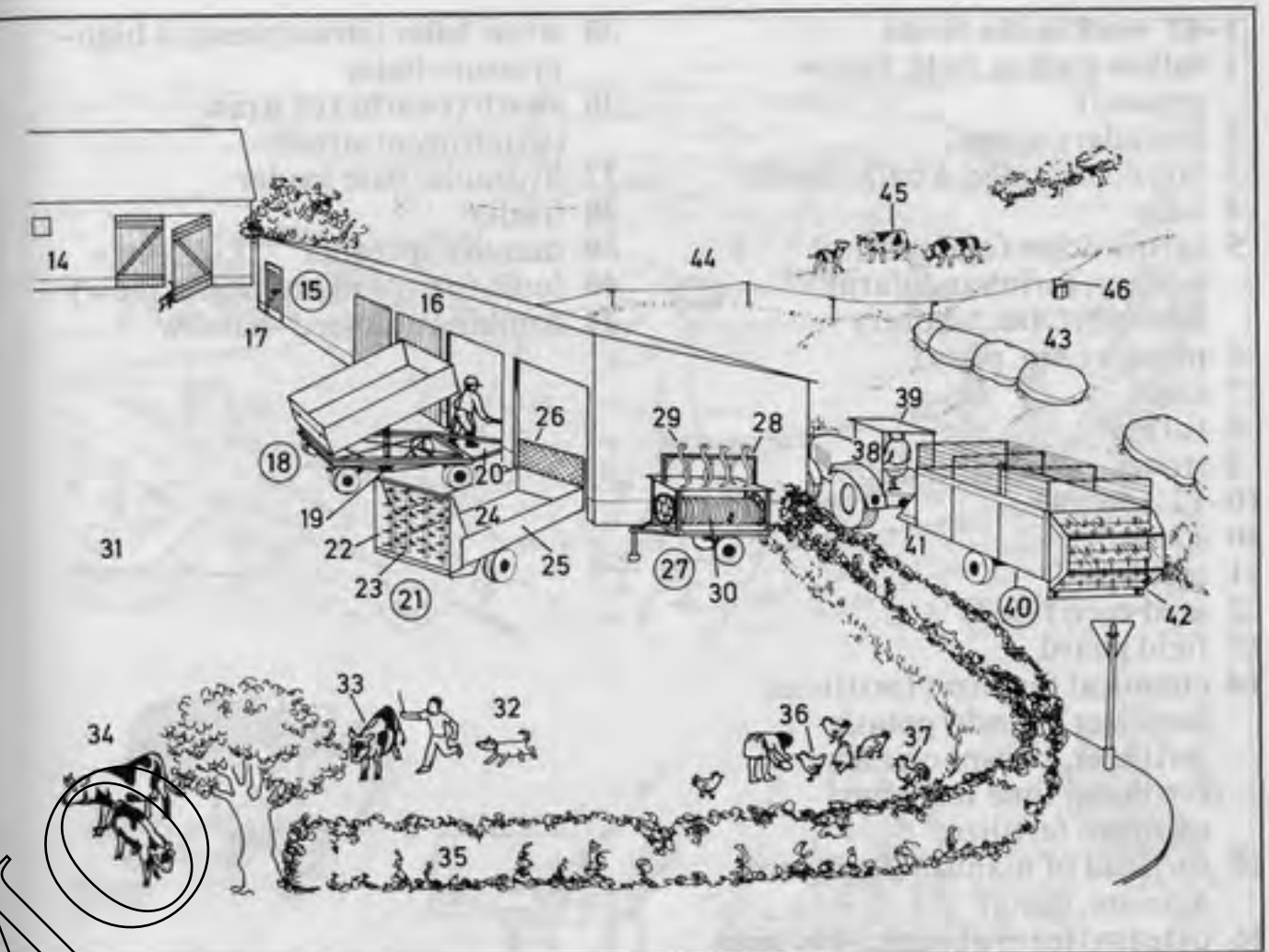

- 43 polythene silo, a fodder silo
- 44 meadow
- 45 grazing cattle
- 46 electrified fence

- 1-41 work in the fields
 1 fallow (fallow field, fallow ground)
 2 boundary stone
 3 boundary ridge, a balk (balk)
 4 field
 5 farmworker (agricultural worker, farmhand, farm labourer, *Am.* laborer)
 6 plough (*Am.* plow)
 7 clod
 8 furrow
 9 stone
 10-12 sowing
 10 sower
 11 seedlip
 12 seed corn (seed)
 13 field guard
 14 chemical fertilizer (artificial fertilizer); *kinds*: potash fertilizer, phosphoric acid fertilizer, lime fertilizer, nitrogen fertilizer
 15 cartload of manure (farmyard manure, dung)
 16 oxteam (team of oxen, *Am.* span of oxen)
 17 fields (farmland)
 18 farm track (farm road)
 19-30 hay harvest (haymaking)
 19 rotary mower with swather (swath reaper)
 20 connecting shaft (connecting rod)
 21 power take-off (power take-off shaft)
 22 meadow
 23 swath (swathe)
 24 tedder (rotary tedder)
 25 teded hay
 26 rotary swather
 27 trailer with pickup attachment
 28 fence rack (rickstand), a drying rack for hay
 29 rickstand, a drying rack for hay
 30 hay tripod
 31-41 grain harvest and seedbed preparation
 31 combine harvester
 32 cornfield
 33 stubble field
 34 bale of straw

- 35 straw baler (straw press), a high-pressure baler
 36 swath (swathe) of straw (windrow of straw)
 37 hydraulic bale loader
 38 trailer
 39 manure spreader
 40 four-furrow plough (*Am.* plow)
 41 combination seed-harrow

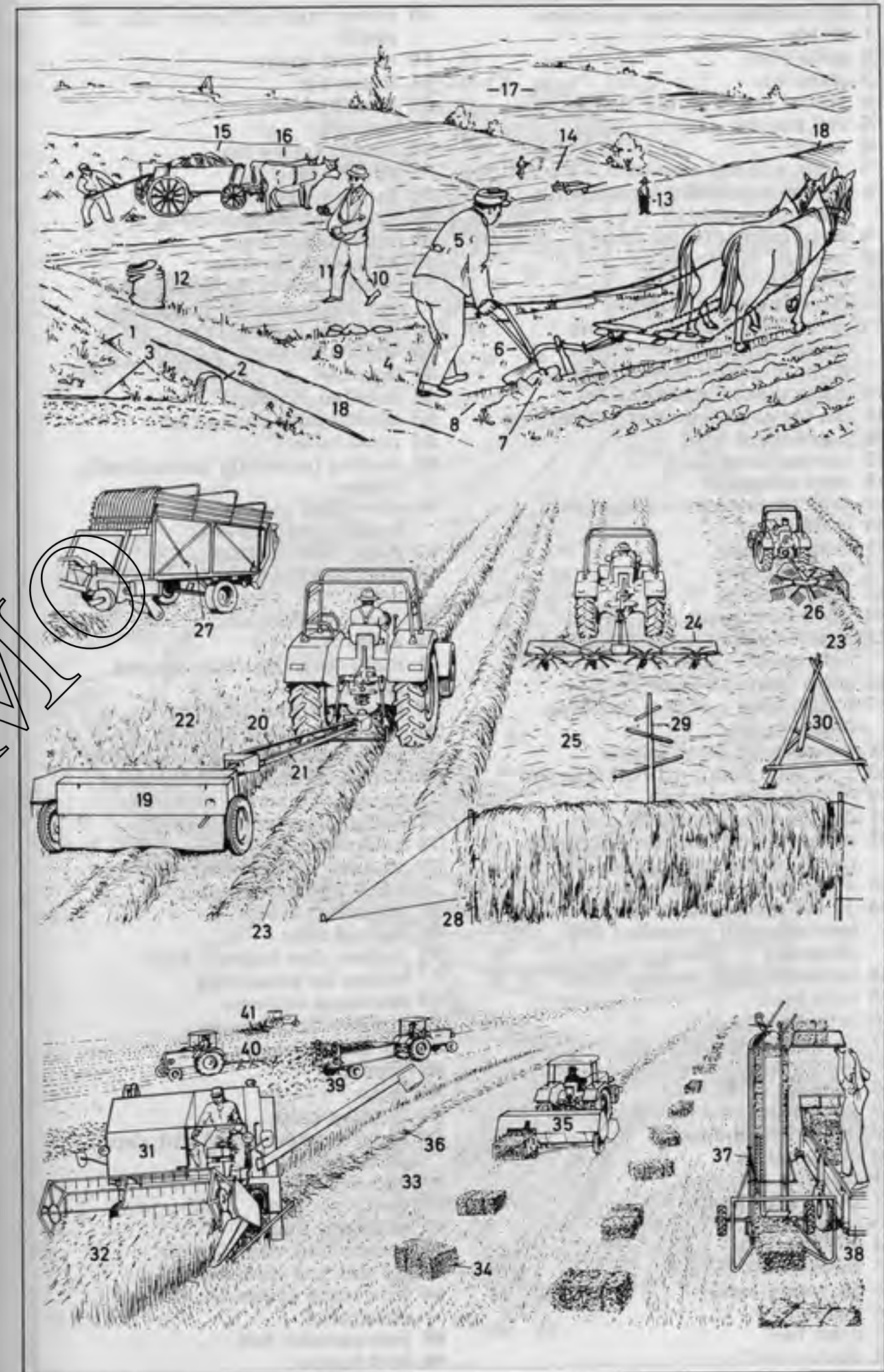

- 1-33 combine harvester (combine)
- 1 divider
 - 2 grain lifter
 - 3 cutter bar
 - 4 pickup reel, a spring-tine reel
 - 5 reel gearing
 - 6 auger
 - 7 chain and slat elevator
 - 8 hydraulic cylinder for adjusting the cutting unit
 - 9 stone catcher (stone trap)
 - 10 awner
 - 11 concave
 - 12 threshing drum (drum)
 - 13 revolving beater [for freeing straw from the drum and preparing it for the shakers]
 - 14 straw shaker (strawwalker)
 - 15 fan for compressed-air winnowing
 - 16 preparation level
 - 17 louvred-type sieve
 - 18 sieve extension
 - 19 shoe sieve (reciprocating sieve)
 - 20 grain auger
 - 21 tailings auger
 - 22 tailings outlet
 - 23 grain tank
 - 24 grain tank auger
 - 25 augers feeding to the grain tank unloader
 - 26 grain unloader spout
 - 27 observation ports for checking tank contents
 - 28 six-cylinder diesel engine
 - 29 hydraulic pump with oil reservoir
 - 30 driving axle gearing
 - 31 driving wheel tyre (Am. tire)
 - 32 rubber-tyred (Am. rubber-tired) wheel on the steering axle
 - 33 driver's position
 - 34-39 self-propelled forage harvester (self-propelled field chopper)
 - 34 cutting drum (chopper drum)
 - 35 corn head
 - 36 cab (driver's cab)
 - 37 swivel-mounted spout (discharge pipe)
 - 38 exhaust
 - 39 rear-wheel steering system
 - 40-45 rotary swather
 - 40 cardan shaft
 - 41 running wheel
 - 42 double spring tine
 - 43 crank
 - 44 swath rake
 - 45 three-point linkage
 - 46-58 rotary tedder
 - 46 tractor
 - 47 draw bar
 - 48 cardan shaft
 - 49 power take-off (power take-off shaft)
 - 50 gearing (gears)
 - 51 frame bar
 - 52 rotating head
 - 53 tine bar
 - 54 double spring tine
 - 55 guard rail
 - 56 running wheel
 - 57 height adjustment crank
 - 58 wheel adjustment
 - 59-84 potato harvester
 - 59 control levers for the lifters of the digger and the hopper and for adjusting the shaft
 - 60 adjustable hitch
 - 61 drawbar
 - 62 drawbar support
 - 63 cardan shaft connection
 - 64 press roller
 - 65 gearing (gears) for the hydraulic system
 - 66 disc (disk) coulter (Am. colter) (rolling coulter)
 - 67 three-bladed share
 - 68 disc (disk) coulter (Am. colter) drive
 - 69 open-web elevator
 - 70 agitator
 - 71 multi-step reduction gearing
 - 72 feeder
 - 73 haulm stripper (flail rotor)
 - 74 rotary elevating drum
 - 75 mechanical tumbling separator
 - 76 haulm conveyor with flexible haulm strippers
 - 77 haulm conveyor agitator
 - 78 haulm conveyor drive with V-belt
 - 79 studded rubber belt for sorting vines, clods and stones
 - 80 trash conveyor
 - 81 sorting table
 - 82 rubber-disc (rubber-disk) rollers for presorting
 - 83 discharge conveyor
 - 84 endless-floor hopper
 - 85-96 beet harvester
 - 85 topper
 - 86 feeler
 - 87 topping knife
 - 88 feeler support wheel with depth adjustment
 - 89 beet cleaner
 - 90 haulm elevator
 - 91 hydraulic pump
 - 92 compressed-air reservoir
 - 93 oil tank (oil reservoir)
 - 94 tensioning device for the beet elevator
 - 95 beet elevator belt
 - 96 beet hopper

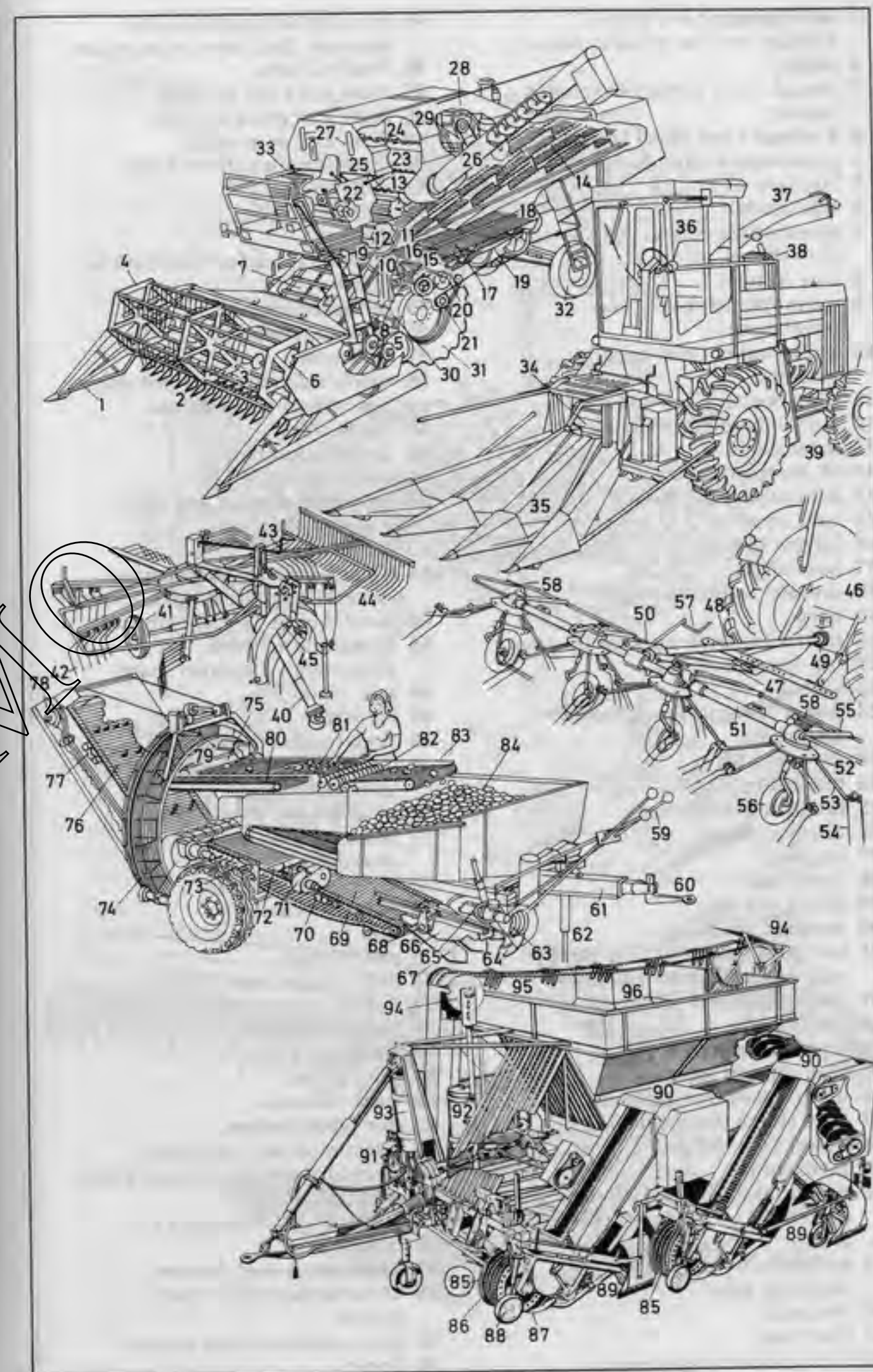

- 1 wheel plough (*Am. plow*),
a single-bottom plough [*form.*]
- 2 handle
- 3 plough (*Am. plow*) stilt (plough
handle)
- 4-8 plough (*Am. plow*) bottom
- 4 mouldboard (*Am. moldboard*)
- 5 landside
- 6 sole (slade)
- 7 ploughshare (share, *Am.*
plowshare)
- 8 frog (frame)
- 9 beam (plough beam, *Am.*
plowbeam)
- 10 knife coulter (*Am. colter*),
a coulter
- 11 skim coulter (*Am. colter*)
- 12 guide-chain crossbar
- 13 guide chain
- 14-19 forecarriage
- 14 adjustable yoke (yoke)
- 15 land wheel
- 16 furrow wheel
- 17 hake chain
- 18 draught beam (drawbar)
- 19 hake
- 20 tractor (general-purpose tractor)
- 21 cab frame (roll bar)
- 22 seat
- 23 power take-off gear-change
(gearshift)
- 24-29 power lift
- 24 ram piston
- 25 lifting rod adjustment
- 26 drawbar frame
- 27 top link
- 28 lower link
- 29 lifting rod
- 30 drawbar coupling
- 31 live power take-off (live power
take-off shaft, take-off shaft)
- 32 differential gear (differential)
- 33 floating axle
- 34 torque converter lever
- 35 gear-change (gearshift)
- 36 multi-speed transmission
- 37 fluid clutch (fluid drive)
- 38 power take-off gear
- 39 main clutch
- 40 power take-off gear-change
(gearshift) with power take-off
clutch
- 41 hydraulic power steering and
reversing gears
- 42 fuel tank
- 43 float lever
- 44 four-cylinder diesel engine
- 45 oil sump and pump for the
pressure-feed lubrication system
- 46 fresh oil tank
- 47 track rod (*Am. tie rod*)
- 48 front axle pivot pin
- 49 front axle suspension
- 50 front coupling (front hitch)
- 51 radiator
- 52 fan
- 53 battery
- 54 oil bath air cleaner (oil bath air
filter)
- 55 cultivator (grubber)
- 56 sectional frame
- 57 spring tine
- 58 share, a diamond-shaped share;
sim.: chisel-shaped share
- 59 depth wheel
- 60 depth adjustment
- 61 coupling (hitch)
- 62 reversible plough (*Am. plow*),
a mounted plough
- 63 depth wheel
- 64-67 plough (*Am. plow*) bottom,
a general-purpose plough bottom
- 64 mouldboard (*Am. moldboard*)
- 65 ploughshare (share, *Am.*
plowshare), a pointed share
- 66 sole (slade)
- 67 landside
- 68 skim coulter (*Am. colter*)
- 69 disc (disk) coulter (*Am. colter*)
(rolling coulter)
- 70 plough (*Am. plow*) frame
- 71 beam (plough beam, *Am.*
plowbeam)
- 72 three-point linkage
- 73 swivel mechanism
- 74 drill
- 75 seed hopper
- 76 drill coulter (*Am. colter*)
- 77 delivery tube, a telescopic tube
- 78 feed mechanism
- 79 gearbox
- 80 drive wheel
- 81 track indicator
- 82 disc (disk) harrow,
a semimounted implement
- 83 discs (disks) in X-configuration
- 84 plain disc (disk)
- 85 serrated-edge disc (disk)
- 86 quick hitch
- 87 combination seed-harrow
- 88 three-section spike-tooth
harrow
- 89 three-section rotary harrow
- 90 frame

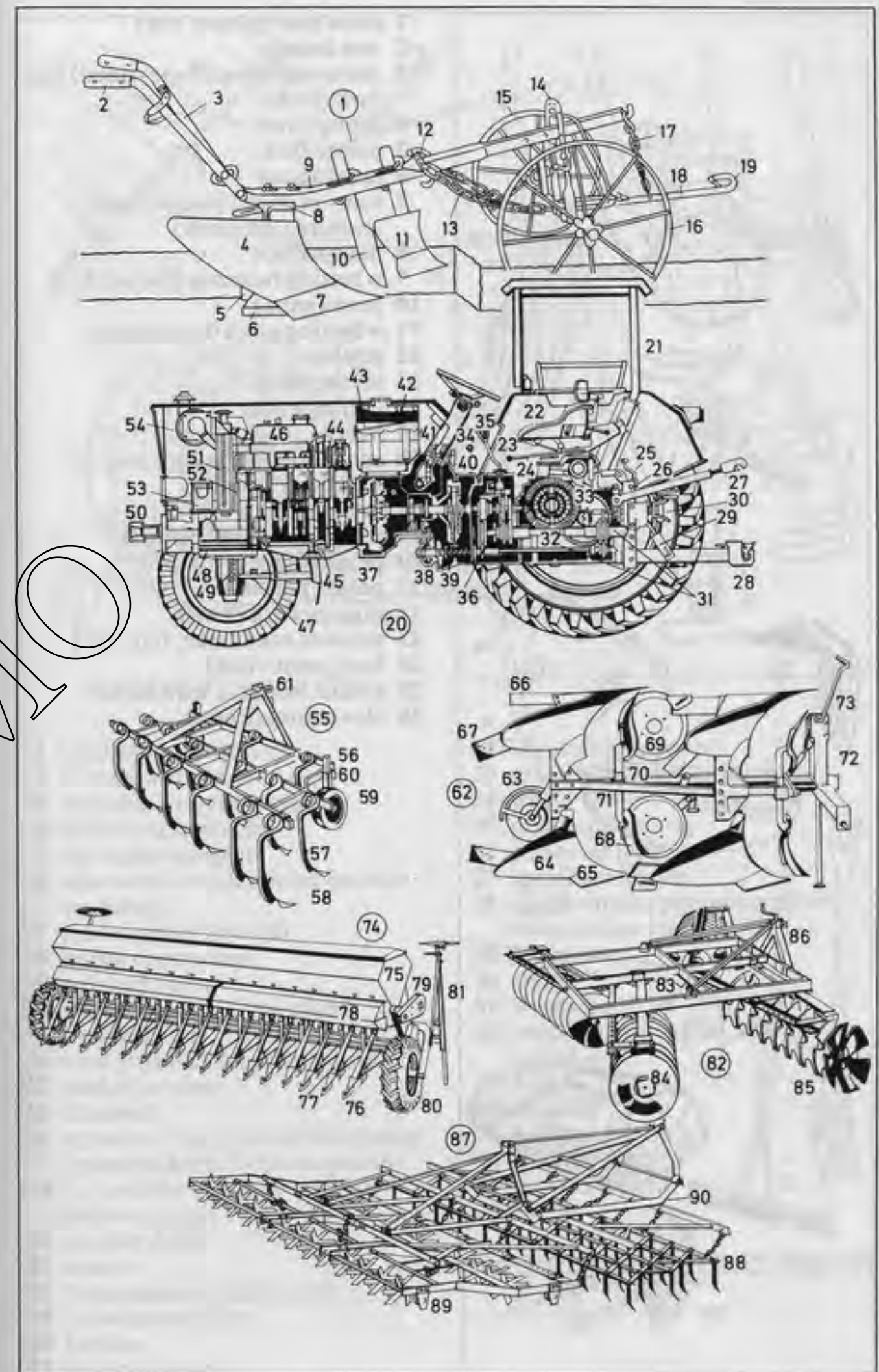

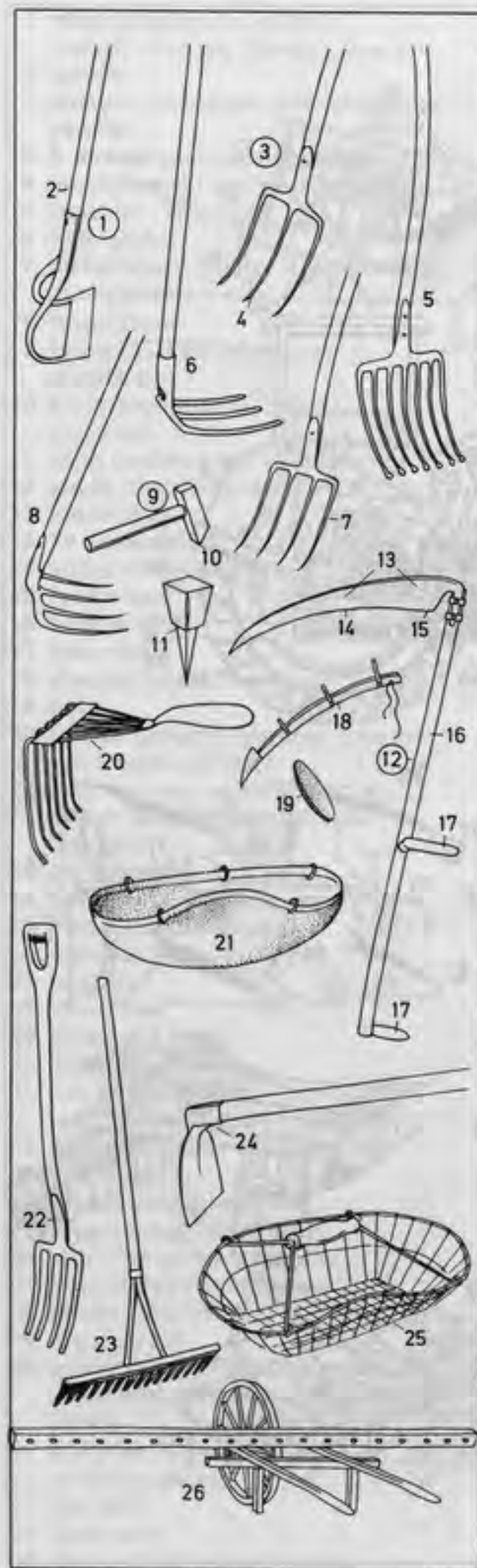

- 1 draw hoe (garden hoe)
- 2 hoe handle
- 3 three-pronged (three-tined) hay fork (fork)
- 4 prong (tine)
- 5 potato fork
- 6 potato hook
- 7 four-pronged (four-tined) manure fork (fork)
- 8 manure hoe
- 9 whetting hammer [for scythes]
- 10 peen (pane)
- 11 whetting anvil [for scythes]
- 12 scythe
- 13 scythe blade
- 14 cutting edge
- 15 heel
- 16 snath (snathe, snead, sneath)
- 17 handle
- 18 scythe sheath
- 19 whetstone (scythestone)
- 20 potato rake
- 21 potato planter
- 22 digging fork (fork)
- 23 wooden rake (rake, hayrake)
- 24 hoe (potato hoe)
- 25 potato basket, a wire basket
- 26 clover broadcaster

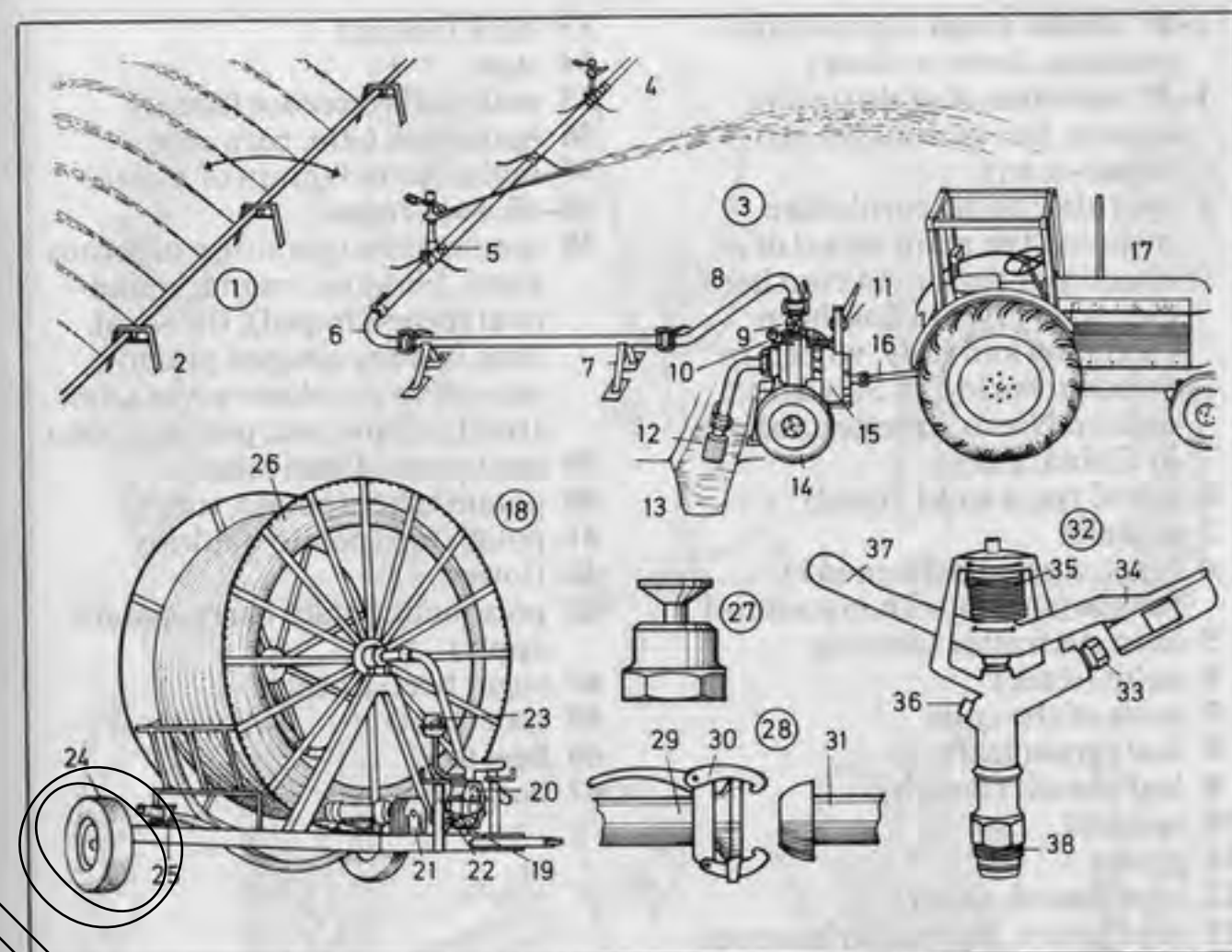

- 1 oscillating spray line
- 2 stand (steel chair)
- 3 portable irrigation system
- 4 revolving sprinkler
- 5 standpipe coupler
- 6 elbow with cardan joint (cardan coupling)
- 7 pipe support (trestle)
- 8 pump connection
- 9 delivery valve
- 10 pressure gauge (*Am. gage*) (manometer)
- 11 centrifugal evacuating pump
- 12 basket strainer
- 13 channel
- 14 chassis of the p.t.o.-driven pump (power take-off-driven pump)
- 15 p.t.o.-driven (power take-off-driven) pump
- 16 cardan shaft
- 17 tractor
- 18 long-range irrigation unit
- 19 drive connection
- 20 turbine
- 21 gearing (gears)
- 22 adjustable support
- 23 centrifugal evacuating pump
- 24 wheel
- 25 pipe support
- 26 polyester pipe
- 27 sprinkler nozzle
- 28 quick-fitting pipe connection with cardan joint
- 29 M-cardan
- 30 clamp
- 31 V-cardan
- 32 revolving sprinkler, a field sprinkler
- 33 nozzle
- 34 breaker
- 35 breaker spring
- 36 stopper
- 37 counterweight
- 38 thread

- 1-47 arable crops (agricultural produce, farm produce)
- 1-37 varieties of grain (grain, cereals, farinaceous plants, bread-corn)
- 1 rye (*also*: corn, 'corn' often meaning the main cereal of a country or region; in Northern Germany: rye; in Southern Germany and Italy: wheat; in Sweden: barley; in Scotland: oats; in North America: maize; in China: rice)
- 2 ear of rye, a spike (head)
- 3 spikelet
- 4 ergot, a grain deformed by fungus [shown with mycelium]
- 5 corn stem after tillering
- 6 culm (stalk)
- 7 node of the culm
- 8 leaf (grain leaf)
- 9 leaf sheath (sheath)
- 10 spikelet
- 11 glume
- 12 awn (beard, arista)
- 13 seed (grain, kernel, farinaceous grain)
- 14 embryo plant
- 15 seed
- 16 embryo
- 17 root
- 18 root hair
- 19 grain leaf
- 20 leaf blade (blade, lamina)
- 21 leaf sheath
- 22 ligule (ligula)
- 23 wheat
- 24 spelt
- 25 seed; *unripe*: green spelt, a soup vegetable
- 26 barley
- 27 oat panicle, a panicle
- 28 millet
- 29 rice
- 30 rice grain
- 31 maize (Indian corn, *Am. corn*); *varieties*: popcorn, dent corn, flint corn (flint maize, *Am. Yankee corn*), pod corn (*Am. cow corn*, husk corn), soft corn (*Am. flour corn*, squaw corn), sweet corn
- 32 female inflorescence

- 33 husk (shuck)
- 34 style
- 35 male inflorescence (tassel)
- 36 maize cob (*Am. corn cob*)
- 37 maize kernel (grain of maize)
- 38-45 root crops
- 38 potato plant (potato), a tuberous plant; *varieties*: round, round-oval (pear-shaped), flat-oval, long, kidney-shaped potato; *according to colour*: white (*Am. Irish*), yellow, red, purple potato
- 39 seed potato (seed tuber)
- 40 potato tuber (potato, tuber)
- 41 potato top (potato haulm)
- 42 flower
- 43 poisonous potato berry (potato apple)
- 44 sugar beet, a beet
- 45 root (beet)
- 46 beet top
- 47 beet leaf

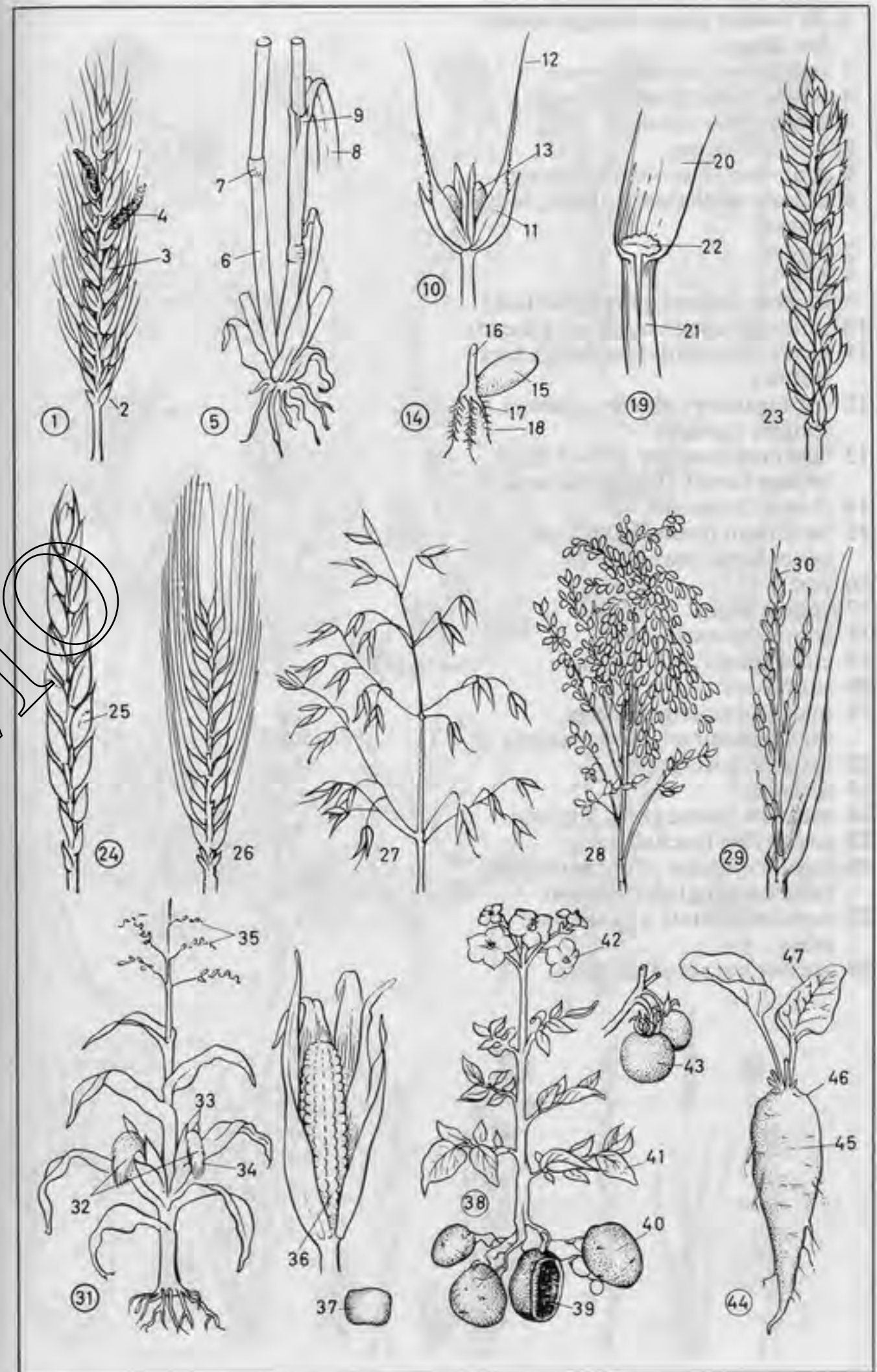

- 1-28 fodder plants (forage plants)
for tillage
- 1 red clover (purple clover)
 - 2 white clover (Dutch clover)
 - 3 alsike clover (alsike)
 - 4 crimson clover
 - 5 four-leaf (four-leaved) clover
 - 6 kidney vetch (lady's finger, lady-finger)
 - 7 flower
 - 8 pod
 - 9 lucerne (lucerne, purple medick)
 - 10 sainfoin (cock's head, cockshead)
 - 11 bird's foot (bird-foot, bird's foot trefoil)
 - 12 corn spurrey (spurrey, spurry), a spurrey (spurry)
 - 13 common comfrey, one of the borage family (Boraginaceae)
 - 14 flower (blossom)
 - 15 field bean (broad bean, tick bean, horse bean)
 - 16 pod
 - 17 yellow lupin
 - 18 common vetch
 - 19 chick-pea
 - 20 sunflower
 - 21 mangold (mangelwurzel, mangoldwurzel, field mangel)
 - 22 false oat (oat-grass)
 - 23 spikelet
 - 24 meadow fescue grass, a fescue
 - 25 cock's foot (cocksfoot)
 - 26 Italian ryegrass; *sim.*: perennial ryegrass (English ryegrass)
 - 27 meadow foxtail, a paniculate grass
 - 28 greater burnet saxifrage





- 1 bulldog
 2 ear, a rose-ear
 3 muzzle
 4 nose
 5 foreleg
 6 forepaw
 7 hind leg
 8 hind paw
 9 pug (pug dog)
 10 boxer
 11 withers
 12 tail, a docked tail
 13 collar
 14 Great Dane
 15 wire-haired fox terrier
 16 bull terrier
 17 Scottish terrier
 18 Bedlington terrier
 19 Pekinese (Pekingese, Pekinese dog, Pekingese dog)
 20 spitz (Pomeranian)
 21 chow (chow-chow)
 22 husky
 23 Afghan (Afghan hound)
 24 greyhound (*Am.* grayhound), a courser
 25 Alsatian (German sheepdog, *Am.* German shepherd), a police dog, watch dog, and guide dog
 26 flews (chaps)
 27 Dobermann terrier

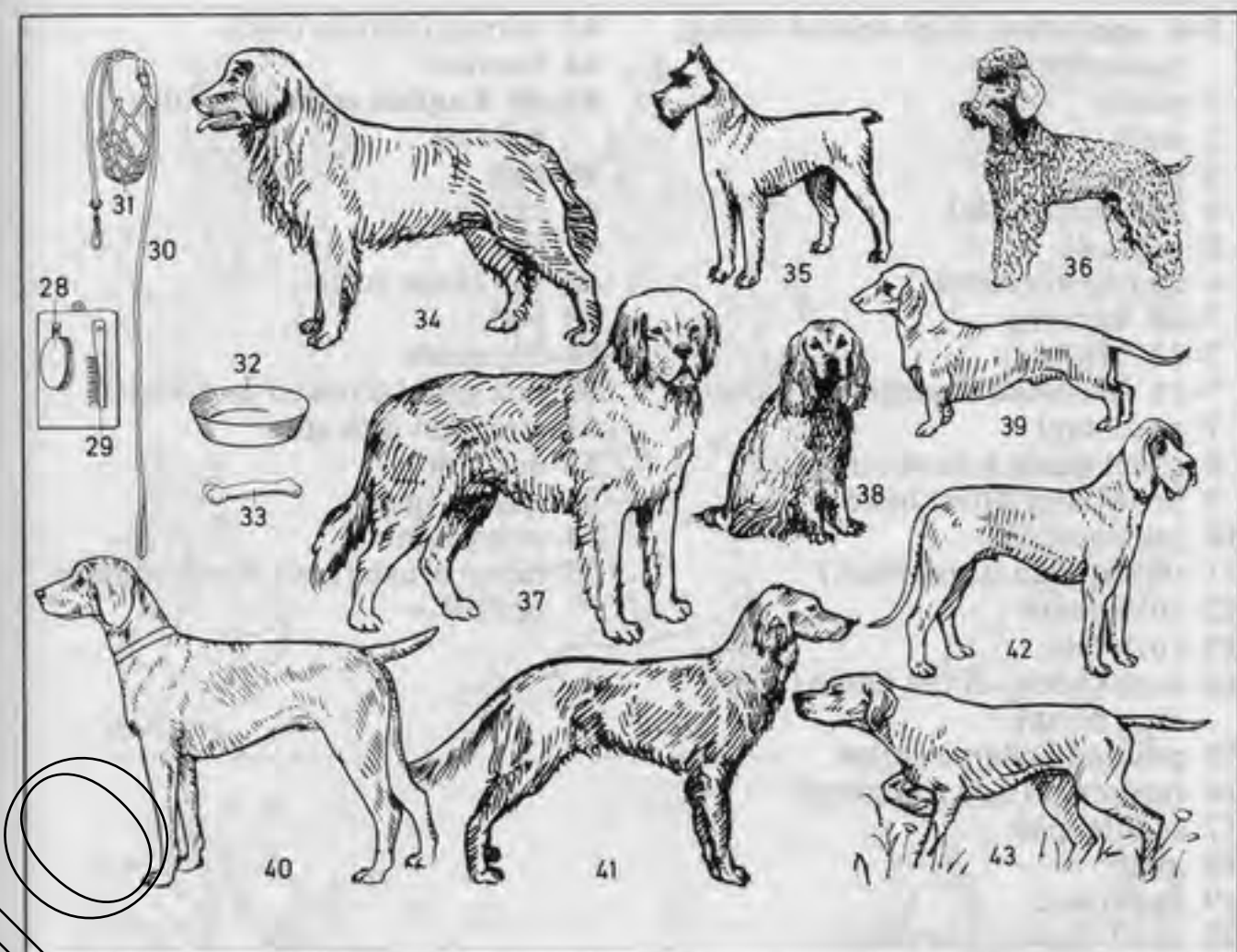

- 28 dog brush
 29 dog comb
 30 lead (dog lead, leash); *for hunting*: leash
 31 muzzle
 32 feeding bowl (dog bowl)
 33 bone
 34 Newfoundland dog
 35 schnauzer
 36 poodle; *sim. and smaller*: pygmy (pigmy) poodle
 37 St. Bernard (St. Bernard dog)
 38 cocker spaniel
 39 dachshund, a terrier
 40 German pointer
 41 English setter
 42 trackhound
 43 pointer, a trackhound

- 1-6 **equitation** (high school riding, haute école)
- 1 piaffe
 - 2 walk
 - 3 passage
 - 4 levade (pesade)
 - 5 capriole
 - 6 courbette (curvet)
- 7-25 **harness**
- 7-13 **bridle**
 - 7-11 **headstall** (headpiece, halter)
 - 7 noseband
 - 8 cheek piece (cheek strap)
 - 9 browband (front band)
 - 10 crownpiece
 - 11 throatlatch (throatlash)
 - 12 curb chain
 - 13 curb bit
 - 14 hasp (hook) of the hame (*Am.* drag hook)
 - 15 pointed collar, a collar
 - 16 trappings (side trappings)
 - 17 saddle-pad
 - 18 girth
 - 19 backband
 - 20 shaft chain (pole chain)
 - 21 pole
 - 22 trace
 - 23 second girth (emergency girth)
 - 24 trace
 - 25 reins (*Am.* lines)
- 26-36 **breast harness**
- 26 blinker (*Am.* blinder, winker)
 - 27 breast collar ring
 - 28 breast collar (Dutch collar)
 - 29 fork
 - 30 neck strap
 - 31 saddle-pad
 - 32 loin strap
 - 33 reins (rein, *Am.* line)
 - 34 crupper (crupper-strap)
 - 35 trace
 - 36 girth (belly-band)
- 37-49 **saddles**
- 37-44 **stock saddle** (*Am.* western saddle)
 - 37 saddle seat
 - 38 pommel horn (horn)
 - 39 cantle
 - 40 flap (*Am.* fender)
 - 41 bar
 - 42 stirrup leather
 - 43 stirrup (stirrup iron)
 - 44 blanket
- 45-49 **English saddle** (cavalry saddle)
- 45 seat
 - 46 cantle
 - 47 flap
 - 48 roll (knee roll)
 - 49 pad
- 50-51 **spurs**
- 50 box spur (screwed jack spur)
 - 51 strapped jack spur
 - 52 curb bit
 - 53 gag bit (gag)
 - 54 currycomb
 - 55 horse brush (body brush, dandy brush)

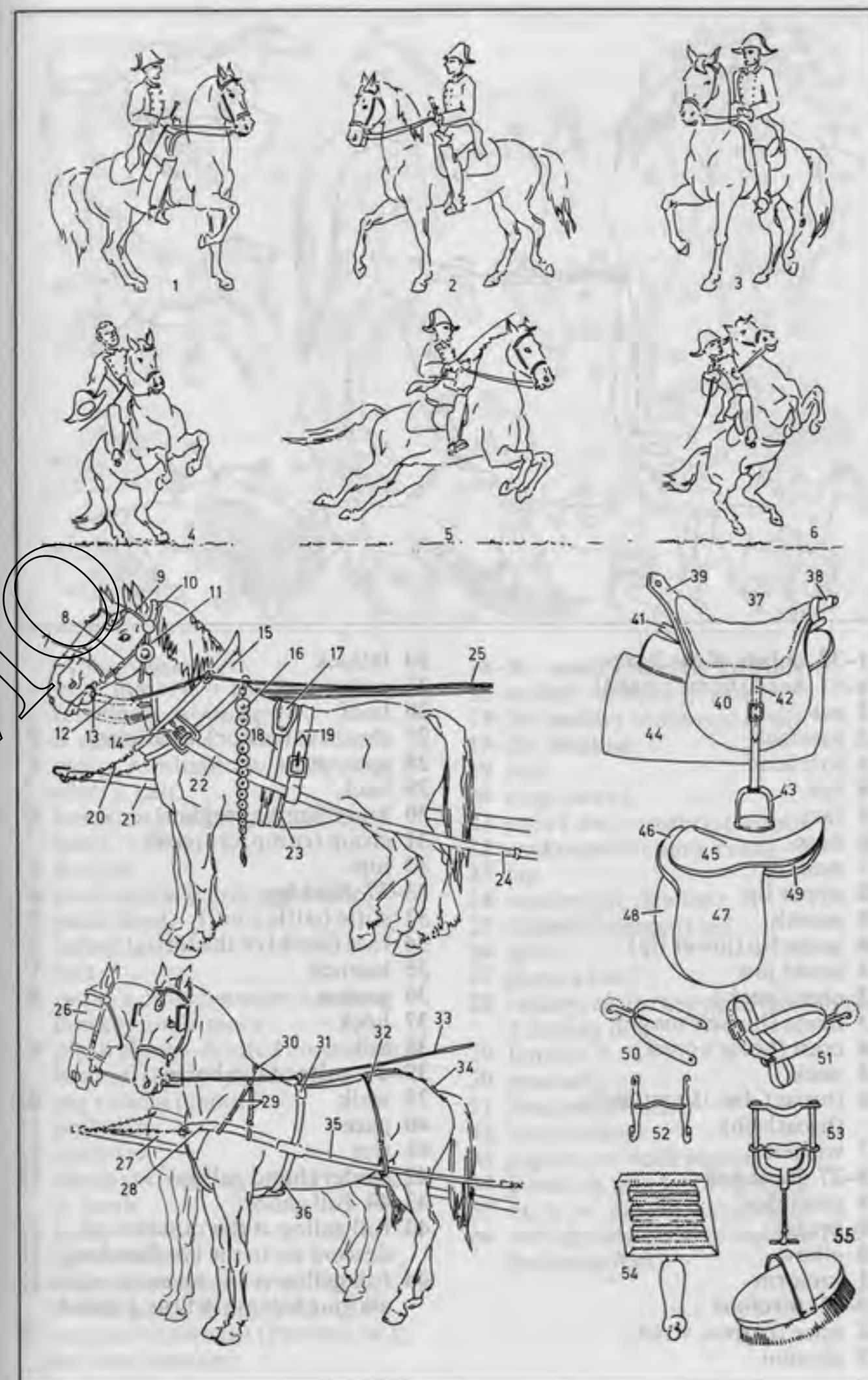

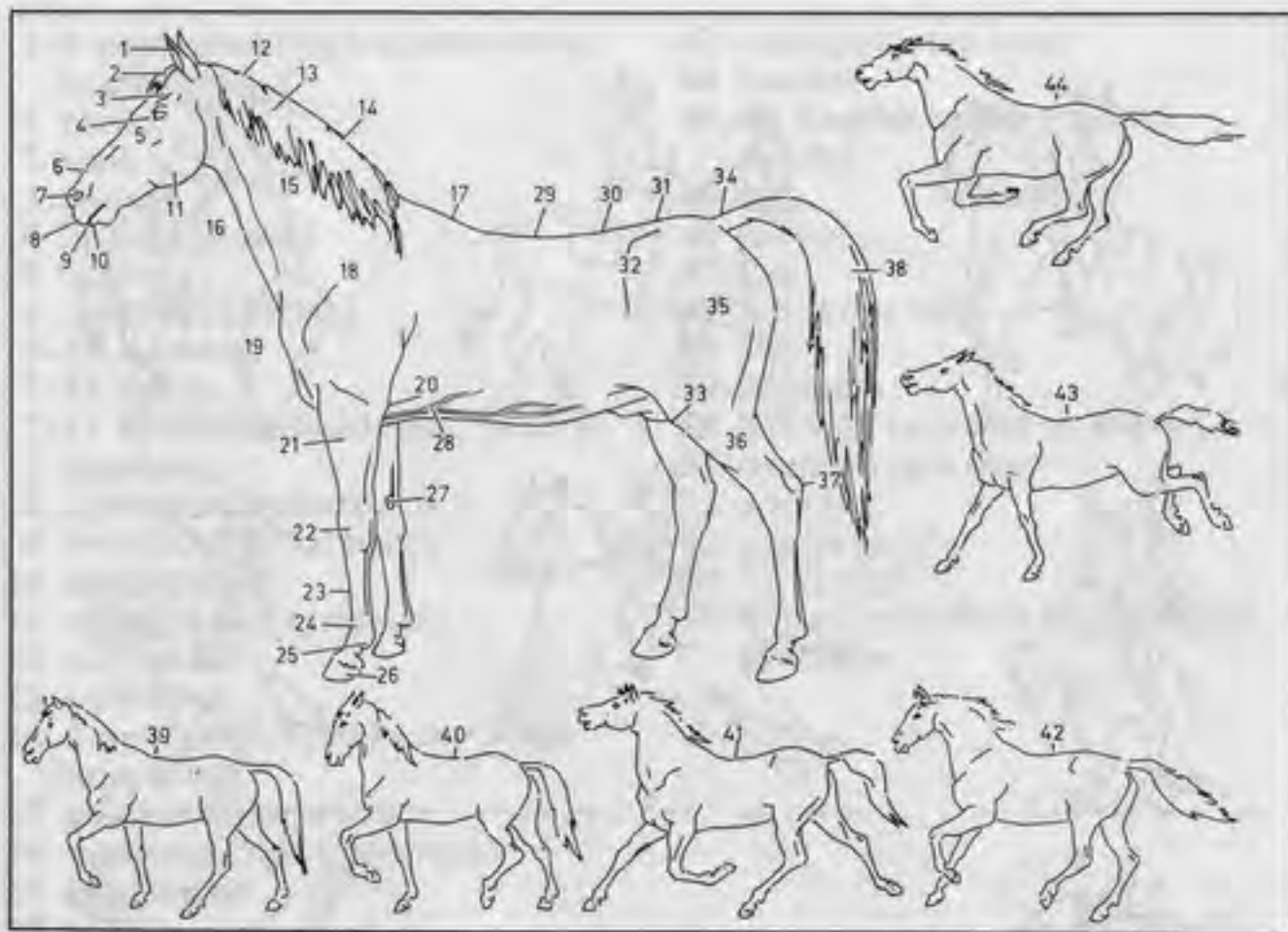
**1-38 points of the horse****1-11 head (horse's head)**

- 1 ear
- 2 forelock
- 3 forehead
- 4 eye
- 5 face
- 6 nose
- 7 nostril
- 8 upper lip
- 9 mouth
- 10 underlip (lower lip)
- 11 lower jaw
- 12 crest (neck)
- 13 mane (horse's mane)
- 14 crest (horse's crest)
- 15 neck
- 16 throat (*Am.* throatlatch, throatlash)
- 17 withers
- 18-27 forehand**
- 18 shoulder
- 19 breast
- 20 elbow
- 21 forearm
- 22-26 forefoot**
- 22 knee (carpus, wrist)
- 23 cannon

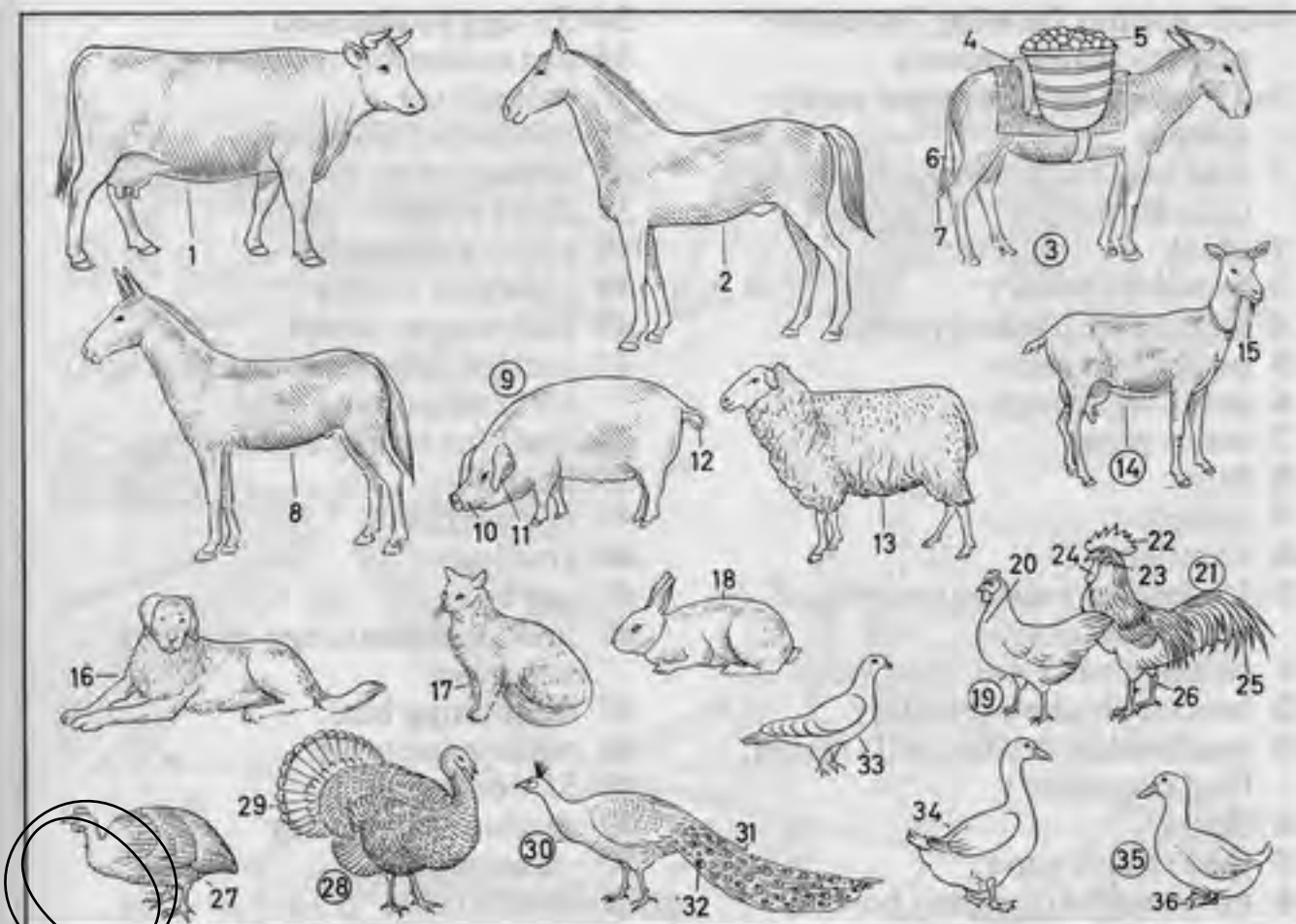
24 fetlock**25 pastern****26 hoof****27 chestnut (castor), a callosity****28 spur vein****29 back****30 loins (lumbar region)****31 croup (rump, crupper)****32 hip****33-37 hind leg****33 stifle (stifle joint)****34 root (dock) of the tail****35 haunch****36 gaskin****37 hock****38 tail****39-44 gaits of the horse****39 walk****40 pace****41 trot****42 canter (hand gallop)****43-44 full gallop****43 full gallop at the moment of descent on to the two forefeet****44 full gallop at the moment when all four feet are off the ground****Abbreviations:**

m. = male; *c.* = castrated; *f.* = female; *y.* = young

1-2 cattle

1 cow, a ruminant; *m.* bull; *c.* ox; *f.* cow; *y.* calf

2 horse; *m.* stallion; *c.* gelding; *f.* mare; *y.* foal

3 donkey

4 pack saddle (carrying saddle)

5 pack (load)

6 tufted tail

7 tuft

8 mule, a cross between a male donkey and a mare

9 pig, a cloven-hoofed animal; *m.* boar; *f.* sow; *y.* piglet

10 pig's snout (snout)

11 pig's ear

12 curly tail

13 sheep; *m.* ram; *c.* wether; *f.* ewe; *y.* lamb

14 goat

15 goat's beard

16 dog, a Leonberger; *m.* dog; *f.* bitch; *y.* pup (puppy, whelp)

17 cat, an Angora cat (Persian cat); *m.* tom (tom cat)

18-36 small domestic animals

18 rabbit; *m.* buck; *f.* doe

19-36 poultry (domestic fowl)**19-26 chicken**

19 hen

20 crop (crop)

21 cock (*Am.* rooster); *c.* capon

22 cockscomb (comb, crest)

23 lap

24 wattle (gill, dewlap)

25 falcate (falcated) tail

26 spur

27 guinea fowl

28 turkey; *m.* turkey cock (gobbler); *f.* turkey hen

29 fan tail

30 peacock

31 peacock's feather

32 eye (ocellus)

33 pigeon; *m.* cock pigeon

34 goose; *m.* gander; *y.* gosling

35 duck; *m.* drake; *y.* duckling

36 web (palmations) of webbed foot (palmate foot)

1-27 poultry farming (intensive poultry management)

1-17 straw yard (strawed yard) system

- 1 fold unit for growing stock (chick unit)
- 2 chick
- 3 brooder (hover)
- 4 adjustable feeding trough
- 5 pullet fold unit
- 6 drinking trough
- 7 water pipe
- 8 litter
- 9 pullet
- 10 ventilator
- 11-17 broiler rearing (rearing of broiler chickens)
- 11 chicken run (*Am.* fowl run)
- 12 broiler chicken (broiler)
- 13 mechanical feeder (self-feeder, feed dispenser)
- 14 chain
- 15 feed supply pipe
- 16 mechanical drinking bowl (mechanical drinker)
- 17 ventilator
- 18 battery system (cage system)
- 19 battery (laying battery)
- 20 tiered cage (battery cage, stepped cage)
- 21 feeding trough
- 22 egg collection by conveyor
- 23-27 mechanical feeding and dunging (manure removal, droppings removal)
- 23 rapid feeding system for battery feeding (mechanical feeder)
- 24 feed hopper
- 25 endless-chain conveyor (chain feeder)
- 26 water pipe (liquid feed pipe)
- 27 dunging chain (dunging conveyor)
- 28 [cabinet type] setting and hatching machine
- 29 ventilation drum [for the setting compartment]
- 30 hatching compartment (hatcher)
- 31 metal trolley for hatching trays
- 32 hatching tray
- 33 ventilation drum motor

34-53 egg production

- 34 egg collection system (egg collection)
- 35 multi-tier transport
- 36 collection by pivoted fingers
- 37 drive motor
- 38 sorting machine
- 39 conveyor trolley
- 40 fluorescent screen
- 41 suction apparatus (suction box) for transporting eggs
- 42 shelf for empty and full egg boxes
- 43 egg weighers
- 44 grading
- 45 egg box
- 46 fully automatic egg-packing machine
- 47 radioscope box
- 48 radioscope table
- 49-51 feeder
- 49 suction transporter
- 50 vacuum line
- 51 supply table
- 52 automatic counting and grading
- 53 packing box dispenser
- 54 leg ring
- 55 wing tally (identification tally)
- 56 bantam
- 57 laying hen
- 58 hen's egg (egg)
- 59 eggshell, an egg integument
- 60 shell membrane
- 61 air space
- 62 white [of the egg] (albumen)
- 63 chalaza (*Am.* treadle)
- 64 vitelline membrane (yolk sac)
- 65 blastodisc (germinal disc, cock's tread, cock's treadle)
- 66 germinal vesicle
- 67 white
- 68 yolk

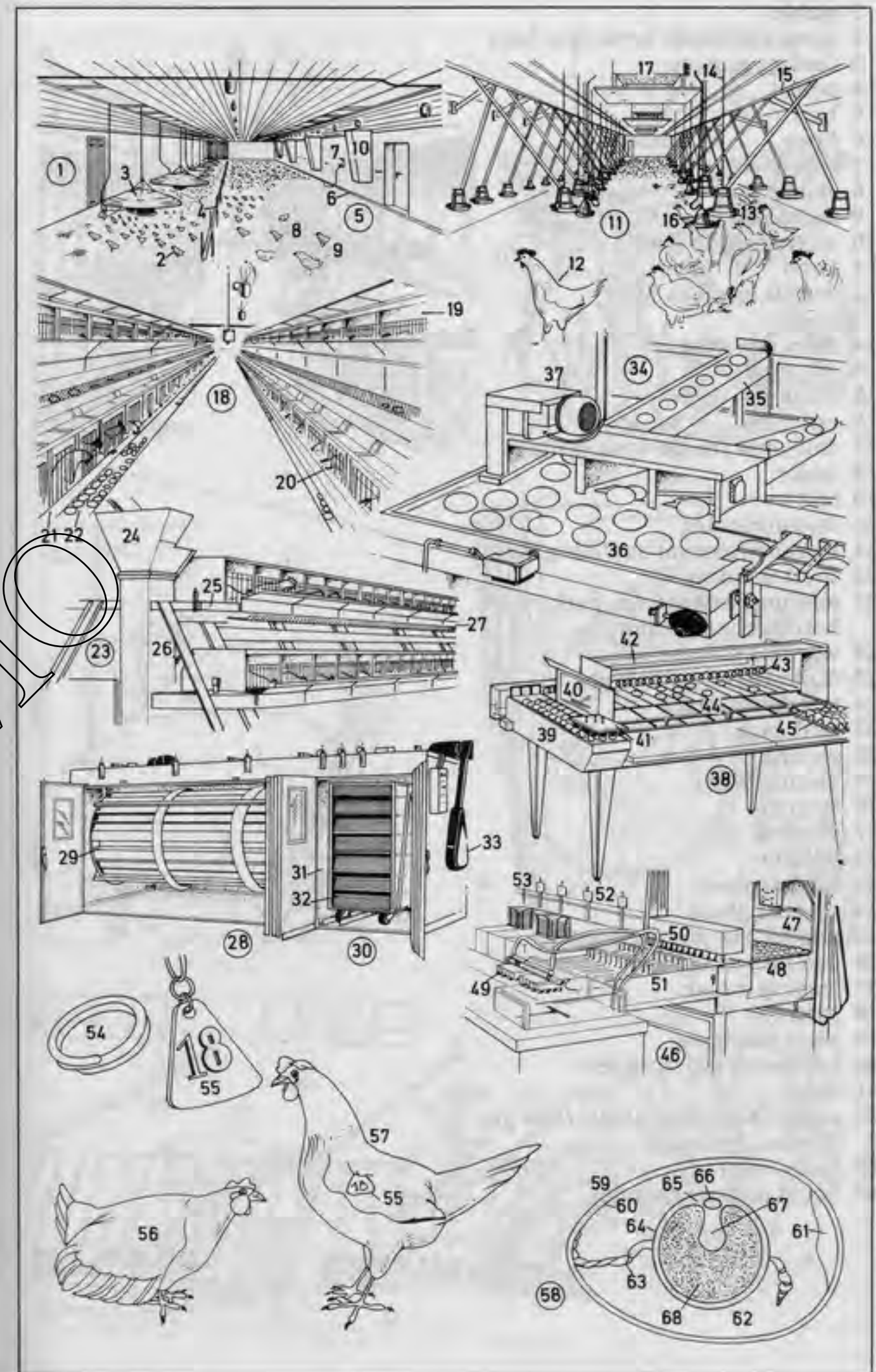

- 1 stable
- 2 horse stall (stall, horse box, box)
- 3 feeding passage
- 4 pony
- 5 bars
- 6 litter
- 7 bale of straw
- 8 ceiling light
- 9 sheep pen
- 10 mother sheep (ewe)
- 11 lamb
- 12 double hay rack
- 13 hay
- 14 dairy cow shed
- 15-16 tether
- 15 chain
- 16 rail
- 17 dairy cow (milch-cow, milker)
- 18 udder
- 19 teat
- 20 manure gutter
- 21 manure removal by sliding bars
- 22 short standing
- 23 milking parlour (*Am.* parlor), a herringbone parlour
- 24 working passage
- 25 milker (*Am.* milkman)
- 26 teat cup cluster
- 27 milk pipe
- 28 air line
- 29 vacuum line
- 30 teat cup
- 31 window
- 32 pulsator
- 33 release phase
- 34 squeeze phase
- 35 pigsty (*Am.* pigpen, hogpen)
- 36 pen for young pigs
- 37 feeding trough
- 38 partition
- 39 pig, a young pig
- 40 farrowing and store pen
- 41 sow
- 42 piglet (*Am.* shoat, shote) (sow pig [for first 8 weeks])
- 43 farrowing rails
- 44 liquid manure channel

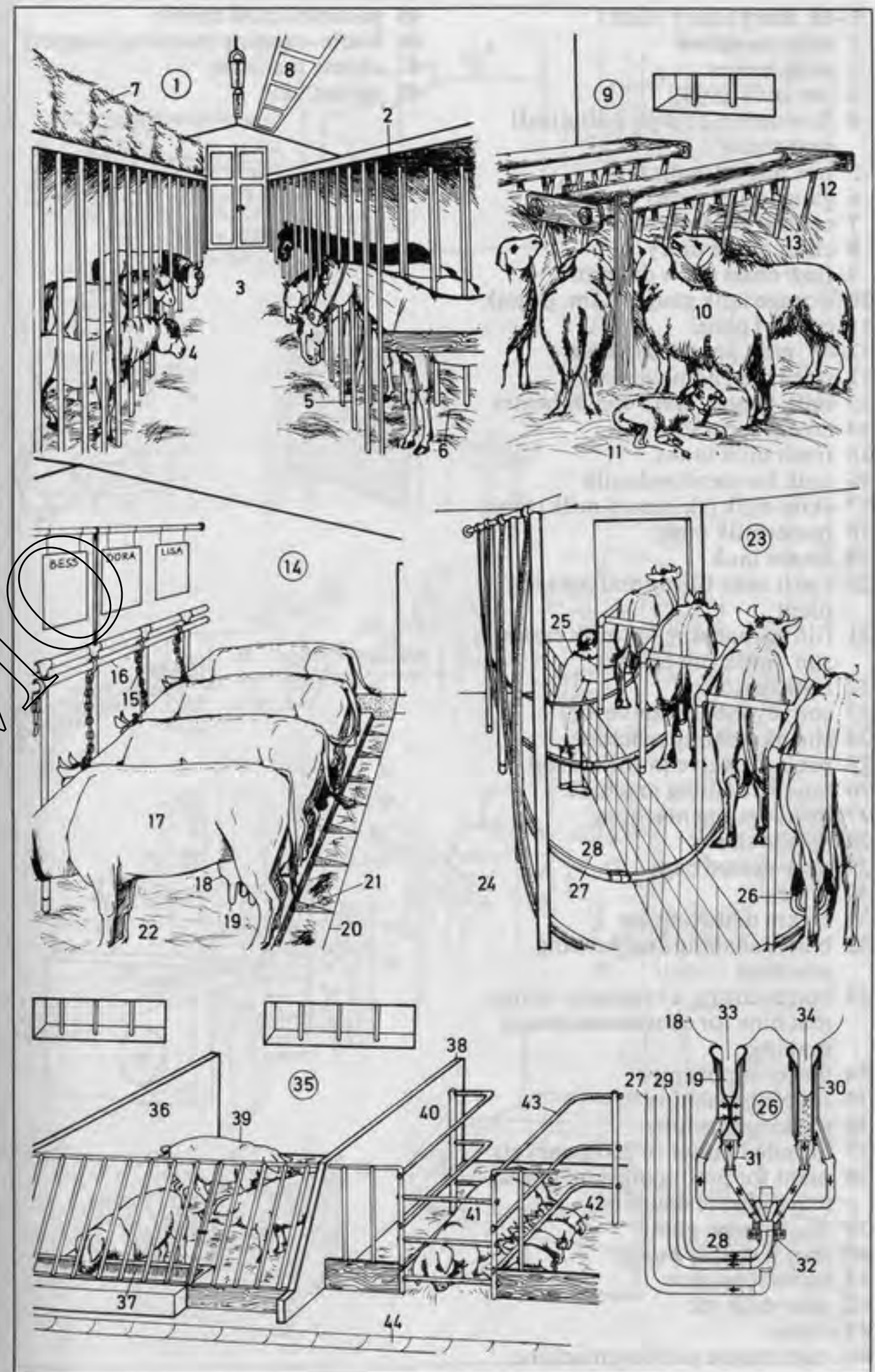

- 1-48 dairy (dairy plant)
- 1 milk reception
 - 2 milk tanker
 - 3 raw milk pump
 - 4 flowmeter, an oval (elliptical) gear meter
 - 5 raw milk storage tank
 - 6 gauge (Am. gage)
 - 7 central control room
 - 8 chart of the dairy
 - 9 flow chart (flow diagram)
 - 10 storage tank gauges (Am. gages)
 - 11 control panel
 - 12-48 milk processing area
 - 12 sterilizer (homogenizer)
 - 13 milk heater; *sim.*: cream heater
 - 14 cream separator
 - 15 fresh milk tanks
 - 16 tank for sterilized milk
 - 17 skim milk (skimmed milk) tank
 - 18 buttermilk tank
 - 19 cream tank
 - 20 fresh milk filling and packing plant
 - 21 filling machine for milk cartons; *sim.*: milk tub filler
 - 22 milk carton
 - 23 conveyor belt (conveyor)
 - 24 shrink-sealing machine
 - 25 pack of twelve in shrink foil
 - 26 ten-litre filling machine
 - 27 heat-sealing machine
 - 28 plastic sheets
 - 29 heat-sealed bag
 - 30 crate
 - 31 cream maturing vat
 - 32 butter shaping and packing machine
 - 33 butter churn, a creamery butter machine for continuous butter making
 - 34 butter supply pipe
 - 35 shaping machine
 - 36 packing machine
 - 37 branded butter in 250 g packets
 - 38 plant for producing curd cheese (curd cheese machine)
 - 39 curd cheese pump
 - 40 cream supply pump
 - 41 curds separator
 - 42 sour milk vat
 - 43 stirrer
 - 44 curd cheese packing machine
 - 45 packeted curd cheese
 - 46 bottle-capping machine (capper)
 - 47 cheese machine
 - 48 rennet vat

- 45 packeted curd cheese
- 46 bottle-capping machine (capper)
- 47 cheese machine
- 48 rennet vat

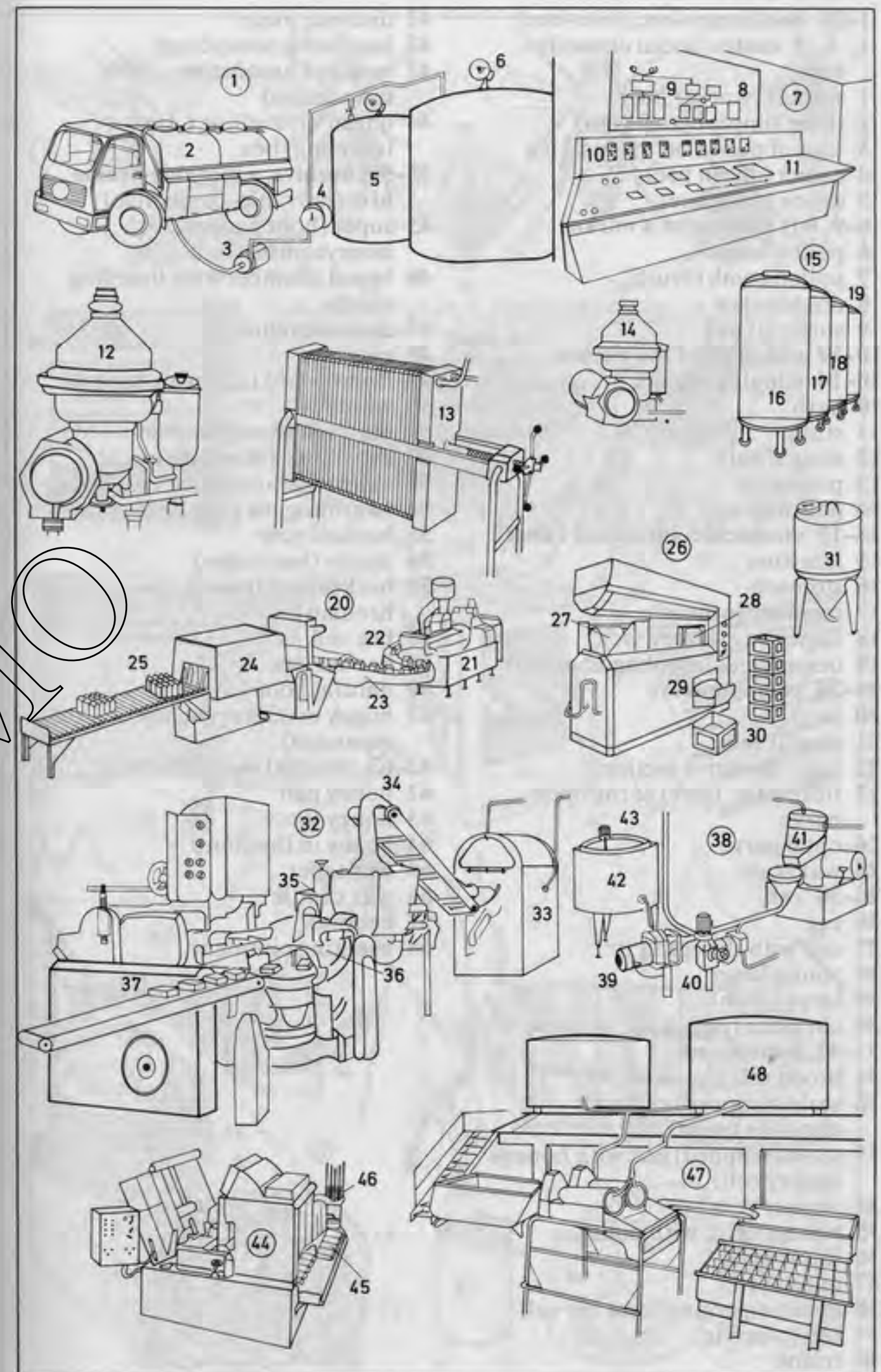

- 1-25 bee (honey-bee, hive-bee)
 1, 4, 5 castes (social classes) of bees
 1 worker (worker bee)
 2 three simple eyes (ocelli)
 3 load of pollen on the hind leg
 4 queen (queen bee)
 5 drone (male bee)
 6-9 left hind leg of a worker
 6 pollen basket
 7 pollen comb (brush)
 8 double claw
 9 suctorial pad
 10-19 abdomen of the worker
 10-14 stinging organs
 10 barb
 11 sting
 12 sting sheath
 13 poison sac
 14 poison gland
 15-19 stomachic-intestinal canal
 15 intestine
 16 stomach
 17 contractile muscle
 18 honey bag (honey sac)
 19 oesophagus (esophagus, gullet)
 20-24 compound eye
 20 facet
 21 crystal cone
 22 light-sensitive section
 23 fibre (*Am.* fiber) of the optic nerve
 24 optic nerve
 25 wax scale
 26-30 cell
 26 egg
 27 cell with the egg in it
 28 young larva
 29 larva (grub)
 30 chrysalis (pupa)
 31-43 honeycomb
 31 brood cell
 32 sealed (capped) cell with chrysalis (pupa)
 33 sealed (capped) cell with honey (honey cell)
 34 worker cells
 35 storage cells, with pollen
 36 drone cells
 37 queen cell
 38 queen emerging from her cell
 39 cap (capping)
 40 frame

- 41 distance piece
 42 [artificial] honeycomb
 43 septum (foundation, comb foundation)
 44 queen's travelling (*Am.* traveling) box
 45-50 beehive, a movable-frame hive (movable-comb hive)
 45 super (honey super) with honeycombs
 46 brood chamber with breeding combs
 47 queen-excluder
 48 entrance
 49 flight board (alighting board)
 50 window
 51 old-fashioned bee shed
 52 straw hive (skep), a hive
 53 swarm (swarm cluster) of bees
 54 swarming net (bag net)
 55 hooked pole
 56 apiary (bee house)
 57 beekeeper (apiarist, *Am.* beeman)
 58 bee veil
 59 bee smoker
 60 natural honeycomb
 61 honey extractor (honey separator)
 62-63 strained honey (honey)
 62 honey pail
 63 honey jar
 64 honey in the comb
 65 wax taper
 66 wax candle
 67 beeswax
 68 bee sting ointment

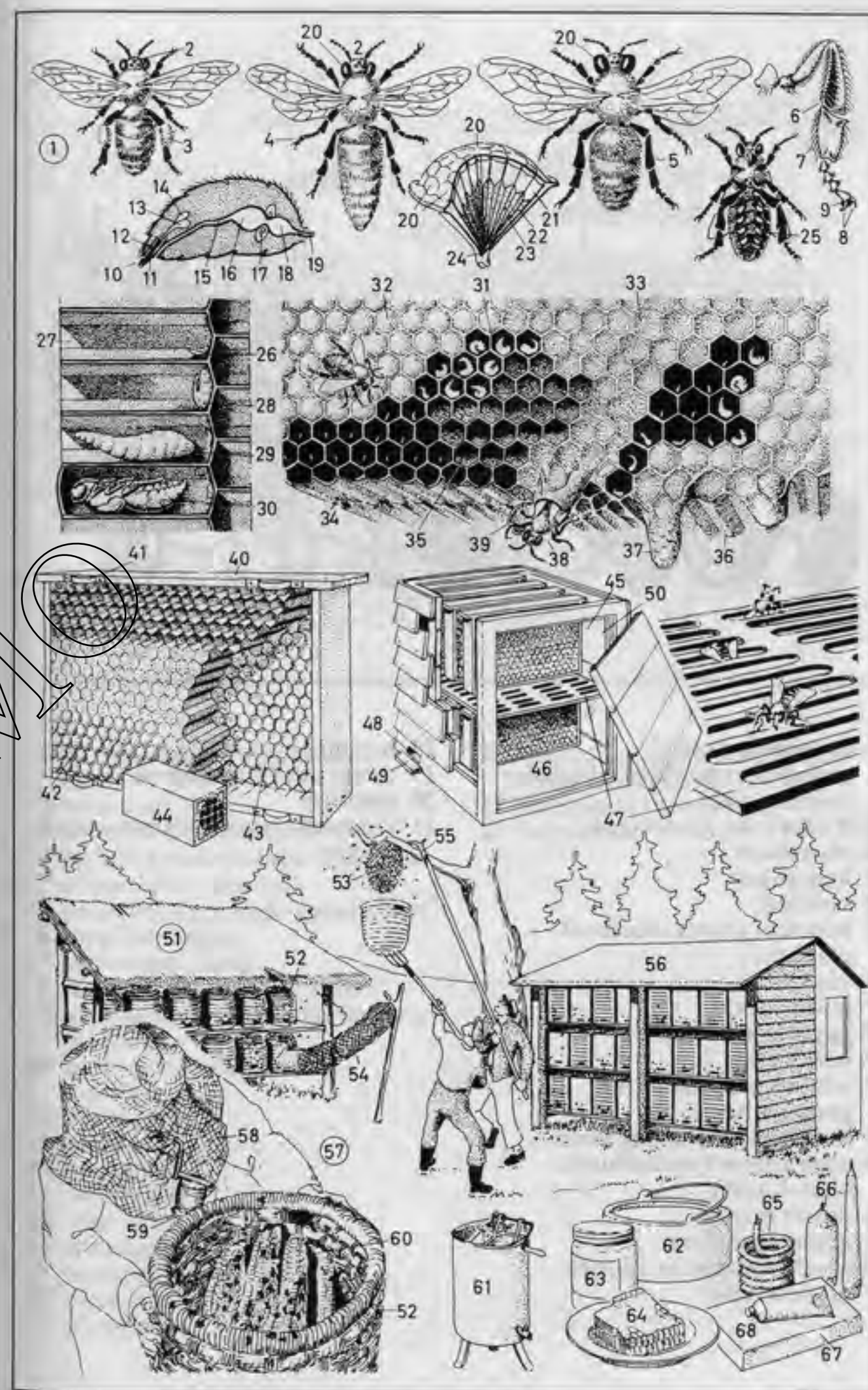

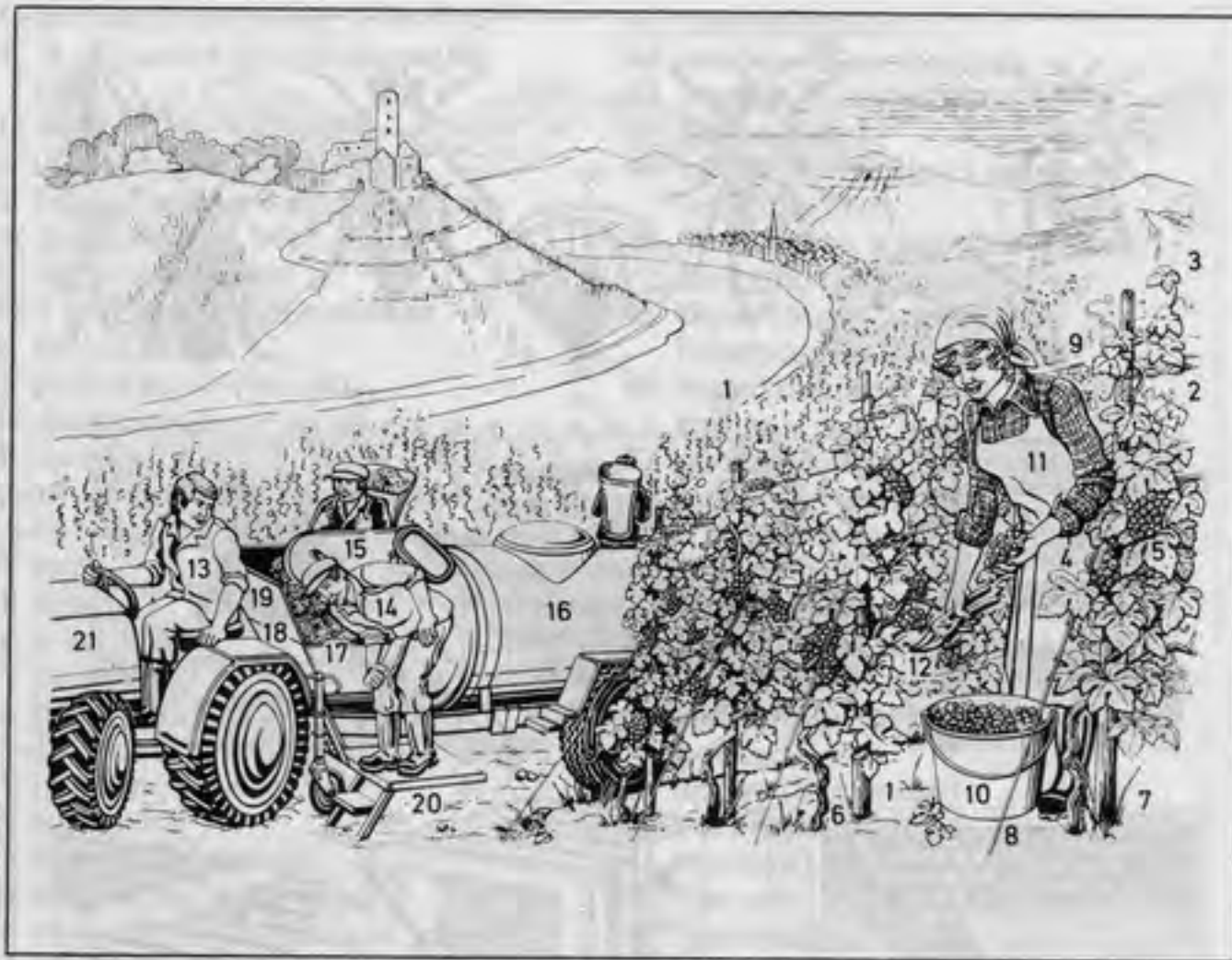
**1-21 vineyard area**

- 1 vineyard using wire trellises for training vines
- 2-9 vine (*Am.* grapevine)
 - 2 vine shoot
 - 3 long shoot
 - 4 vine leaf
 - 5 bunch of grapes (cluster of grapes)
 - 6 vine stem
 - 7 post (stake)
 - 8 guy (guy wire)
 - 9 wire trellis
- 10 tub for grape gathering
- 11 grape gatherer
- 12 secateurs for pruning vines
- 13 wine grower (viniculturist, viticulturist)
- 14 dossier carrier
- 15 dossier (pannier)
- 16 crushed grape transporter
- 17 grape crusher

18 hopper

- 19 three-sided flap extension
- 20 platform
- 21 vineyard tractor, a narrow-track tractor

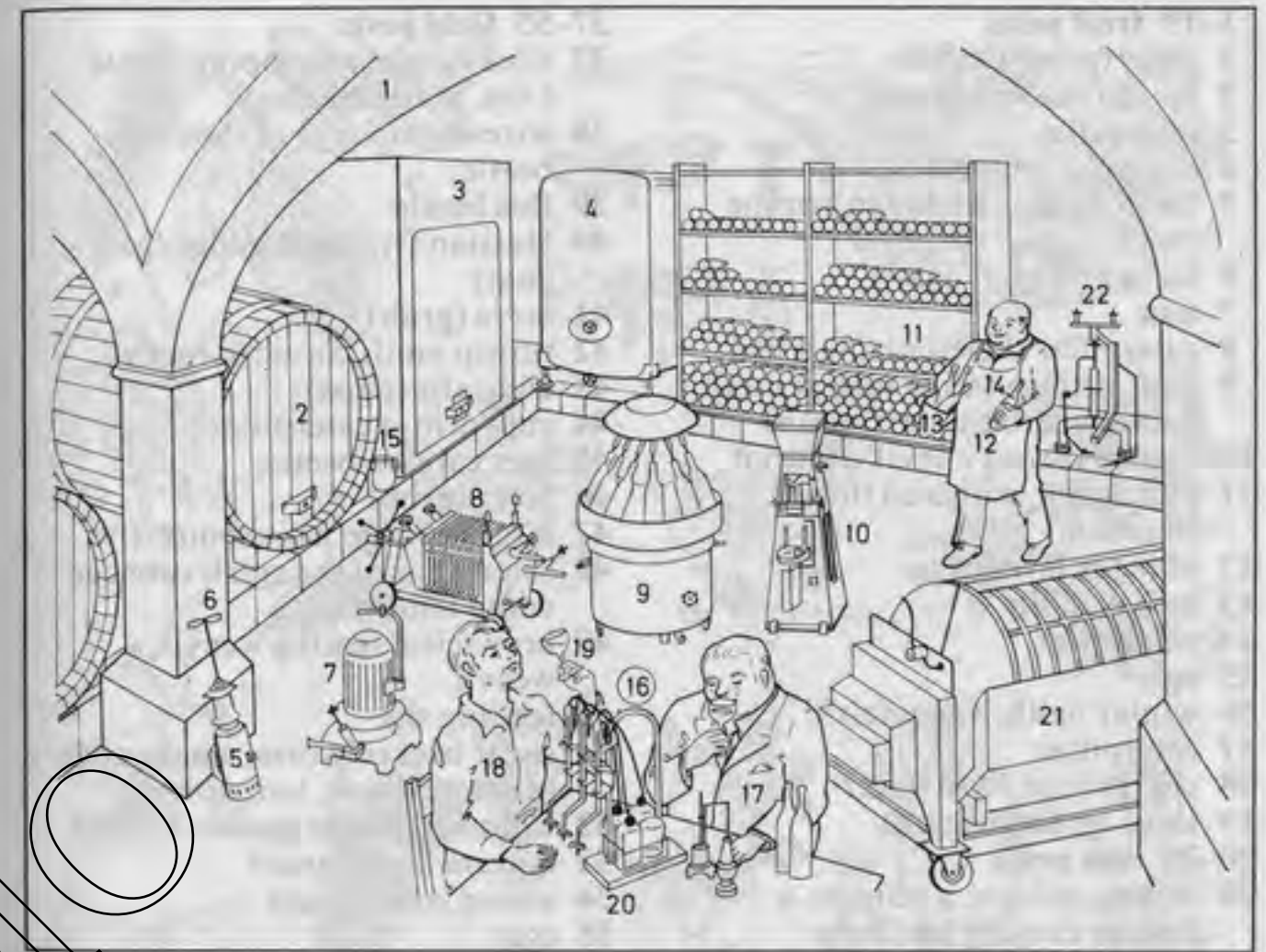
**1-22 wine cellar (wine vault)**

- 1 vault
- 2 wine cask
- 3 wine vat, a concrete vat
- 4 stainless steel vat (*also*: vat made of synthetic material)
- 5 propeller-type high-speed mixer
- 6 propeller mixer
- 7 centrifugal pump
- 8 stainless steel sediment filter
- 9 semi-automatic circular bottling machine
- 10 semi-automatic corking machine
- 11 bottle rack
- 12 cellarer's assistant
- 13 bottle basket
- 14 wine bottle
- 15 wine jug
- 16 wine tasting
- 17 head cellarman
- 18 cellarman
- 19 wineglass

20 inspection apparatus [for spot-checking samples]

- 21 horizontal wine press
- 22 humidifier

1-19 fruit pests

- 1 gipsy (gypsy) moth
- 2 batch (cluster) of eggs
- 3 caterpillar
- 4 chrysalis (pupa)
- 5 small ermine moth, an ermine moth
- 6 larva (grub)
- 7 tent
- 8 caterpillar skeletonizing a leaf
- 9 fruit surface eating tortrix moth (summer fruit tortrix moth)
- 10 appleblossom weevil, a weevil
- 11 punctured, withered flower (blossom)
- 12 hole for laying eggs
- 13 lackey moth
- 14 caterpillar
- 15 eggs
- 16 winter moth, a geometrid
- 17 caterpillar
- 18 cherry fruit fly, a borer
- 19 larva (grub, maggot)

37-55 field pests

- 20-27 vine pests
- 20 downy mildew, a mildew, a disease causing leaf drop
- 21 grape affected with downy mildew
- 22 grape-berry moth
- 23 first-generation larva of the grape-berry moth (*Am. grape worm*)
- 24 second-generation larva of the grape-berry moth (*Am. grape worm*)
- 25 chrysalis (pupa)
- 26 root louse, a grape phylloxera
- 27 root gall (knotty swelling of the root, nodosity, tuberosity)
- 28 brown-tail moth
- 29 caterpillar
- 30 batch (cluster) of eggs
- 31 hibernation cocoon
- 32 woolly apple aphid (American blight), an aphid
- 33 gall caused by the woolly apple aphid
- 34 woolly apple aphid colony
- 35 San-José scale, a scale insect (scale louse)
- 36 larvae (grubs) [*male elongated, female round*]
- 37 click beetle, a snapping beetle (*Am. snapping bug*)
- 38 wireworm, larva of the click beetle
- 39 flea beetle
- 40 Hessian fly, a gall midge (gall gnat)
- 41 larva (grub)
- 42 turnip moth, an earth moth
- 43 chrysalis (pupa)
- 44 cutworm, a caterpillar
- 45 beet carrion beetle
- 46 larva (grub)
- 47 large cabbage white butterfly
- 48 caterpillar of the small cabbage white butterfly
- 49 brown leaf-eating weevil, a weevil
- 50 feeding site
- 51 sugar beet eelworm, a nematode (a threadworm, hairworm)
- 52 Colorado beetle (potato beetle)
- 53 mature larva (grub)
- 54 young larva (grub)
- 55 eggs

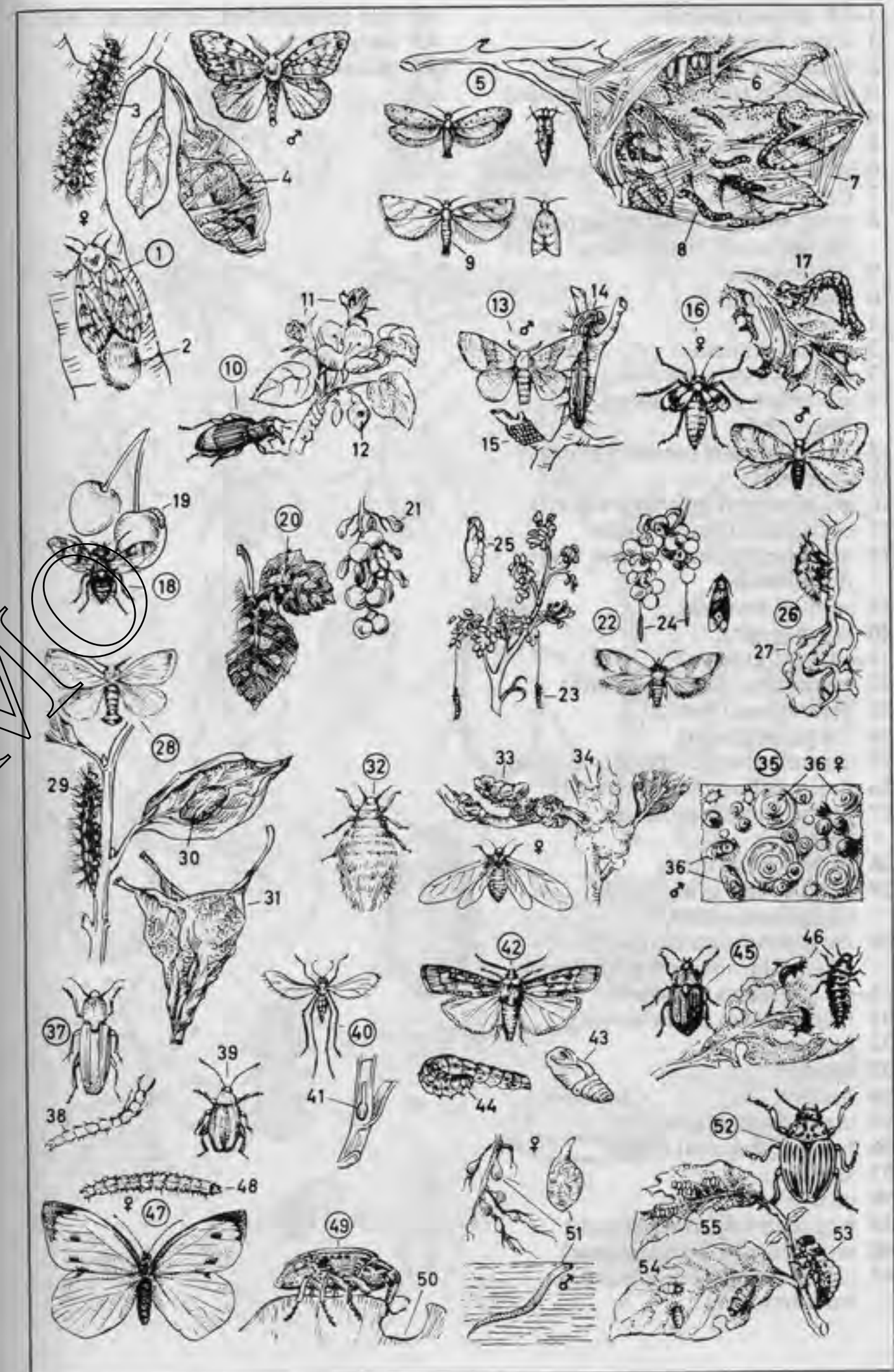

- 1-14 house insects
 1 lesser housefly
 2 common housefly
 3 chrysalis (pupa, coarctate pupa)
 4 stable fly (biting housefly)
 5 trichotomous antenna
 6 wood louse (slater, *Am.* sow bug)
 7 house cricket
 8 wing with stridulating apparatus (stridulating mechanism)
 9 house spider
 10 spider's web
 11 earwig
 12 caudal pincers
 13 clothes moth, a moth
 14 silverfish (*Am.* slicker), a bristletail
 15-30 food pests (pests to stores)
 15 cheese fly
 16 grain weevil (granary weevil)
 17 cockroach (black beetle)
 18 meal beetle (meal worm beetle, flour beetle)
 19 spotted bruchus
 20 larva (grub)
 21 chrysalis (pupa)
 22 leather beetle (hide beetle)
 23 yellow meal beetle
 24 chrysalis (pupa)
 25 cigarette beetle (tobacco beetle)
 26 maize billbug (corn weevil)
 27 one of the *Cryptolestes*, a grain pest
 28 Indian meal moth
 29 Angoumois grain moth (Angoumois moth)
 30 Angoumois grain moth caterpillar inside a grain kernel
 31-42 parasites of man
 31 round worm (maw worm)
 32 female
 33 head
 34 male
 35 tapeworm, a flatworm
 36 head, a suckorial organ
 37 sucker
 38 crown of hooks
 39 bug (bed bug, *Am.* chinch)
 40 crab louse (a human louse)
 41 clothes louse (body louse, a human louse)

- 42 flea (human flea, common flea)
 43 tsetse fly
 44 malaria mosquito

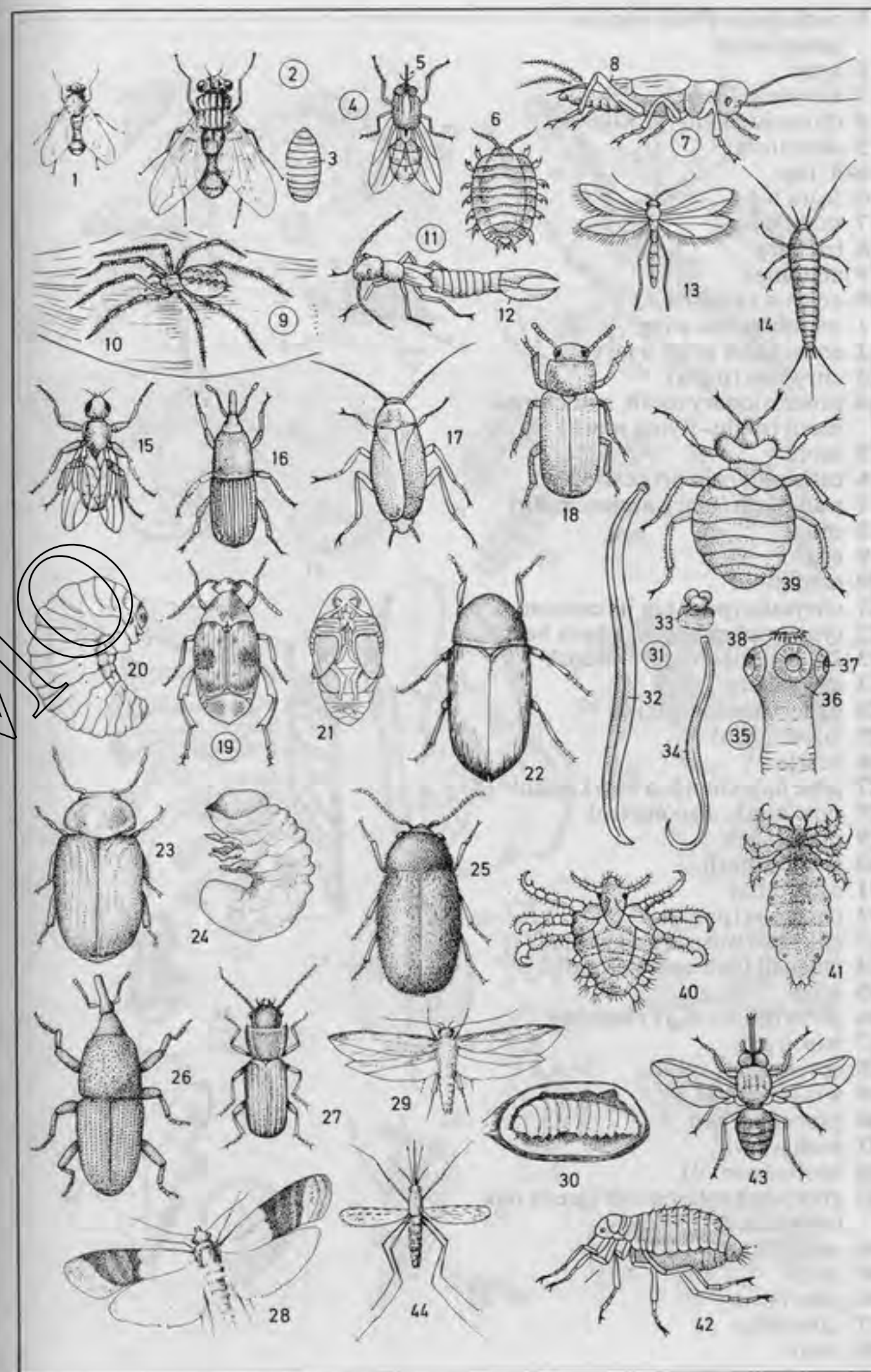

- 1 cockchafer (May bug), a lamellicorn
- 2 head
- 3 antenna (feeler)
- 4 thoracic shield (prothorax)
- 5 scutellum
- 6-8 legs
- 6 front leg
- 7 middle leg
- 8 back leg
- 9 abdomen
- 10 elytron (wing case)
- 11 membranous wing
- 12 cockchafer grub, a larva
- 13 chrysalis (pupa)
- 14 processionary moth, a nocturnal moth (night-flying moth)
- 15 moth
- 16 caterpillars in procession
- 17 nun moth (black arches moth)
- 18 moth
- 19 eggs
- 20 caterpillar
- 21 chrysalis (pupa) in its cocoon
- 22 typographer beetle, a bark beetle
- 23-24 galleries under the bark
- 23 egg gallery
- 24 gallery made by larva
- 25 larva (grub)
- 26 beetle
- 27 pine hawkmoth, a hawkmoth
- 28 pine moth, a geometrid
- 29 male moth
- 30 female moth
- 31 caterpillar
- 32 chrysalis (pupa)
- 33 oak-gall wasp, a gall wasp
- 34 oak gall (oak apple), a gall
- 35 wasp
- 36 larva (grub) in its chamber
- 37 beech gall
- 38 spruce-gall aphid
- 39 winged aphid
- 40 pineapple gall
- 41 pine weevil
- 42 beetle (weevil)
- 43 green oak roller moth (green oak tortrix), a leaf roller
- 44 caterpillar
- 45 moth
- 46 pine beauty
- 47 caterpillar
- 48 moth

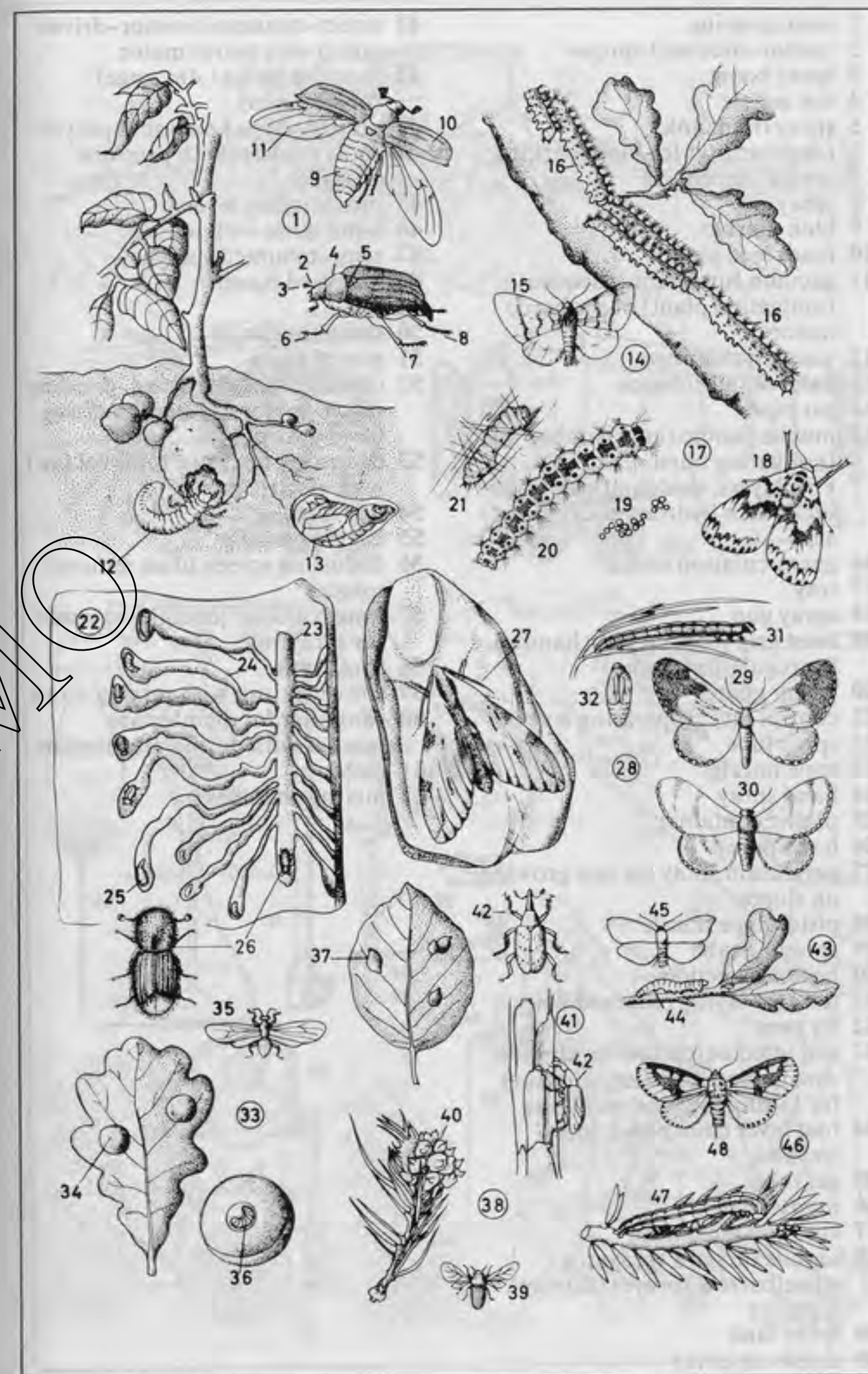

- 1 area spraying
- 2 tractor-mounted sprayer
- 3 spray boom
- 4 fan nozzle
- 5 spray fluid tank
- 6 foam canister for blob marking
- 7 spring suspension
- 8 spray
- 9 blob marker
- 10 foam feed pipe
- 11 vacuum fumigator (vacuum fumigation plant) of a tobacco factory
- 12 vacuum chamber
- 13 bales of raw tobacco
- 14 gas pipe
- 15 mobile fumigation chamber for fumigating nursery saplings, vine layers, seeds, and empty sacks with hydrocyanic (prussic) acid
- 16 gas circulation unit
- 17 tray
- 18 spray gun
- 19 twist grip (control grip, handle) for regulating the jet
- 20 finger guard
- 21 control lever (operating lever)
- 22 spray tube
- 23 cone nozzle
- 24 hand spray
- 25 plastic container
- 26 hand pump
- 27 pendulum spray for hop growing on slopes
- 28 pistol-type nozzle
- 29 spraying tube
- 30 hose connection
- 31 tube for laying poisoned bait
- 32 fly swat
- 33 soil injector (carbon disulphide, *Am.* carbon disulfide, injector) for killing the vine root louse
- 34 foot lever (foot pedal, foot treadle)
- 35 gas tube
- 36 mousetrap
- 37 vole and mole trap
- 38 mobile orchard sprayer, a wheelbarrow sprayer (carriage sprayer)
- 39 spray tank
- 40 screw-on cover
- 41 direct-connected motor-driven pump with petrol motor
- 42 pressure gauge (*Am.* gage) (manometer)
- 43 plunger-type knapsack sprayer
- 44 spray canister with pressure chamber
- 45 piston pump lever
- 46 hand lance with nozzle
- 47 semi-mounted sprayer
- 48 vineyard tractor
- 49 fan
- 50 spray fluid tank
- 51 row of vines
- 52 dressing machine (seed-dressing machine) for dry-seed dressing (seed dusting)
- 53 dedusting fan (dust removal fan) with electric motor
- 54 bag filter
- 55 bagging nozzle
- 56 dedusting screen (dust removal screen)
- 57 water canister [containing water for spraying]
- 58 spray unit
- 59 conveyor unit with mixing screw
- 60 container for disinfectant powder with dosing mechanism
- 61 castor
- 62 mixing chamber

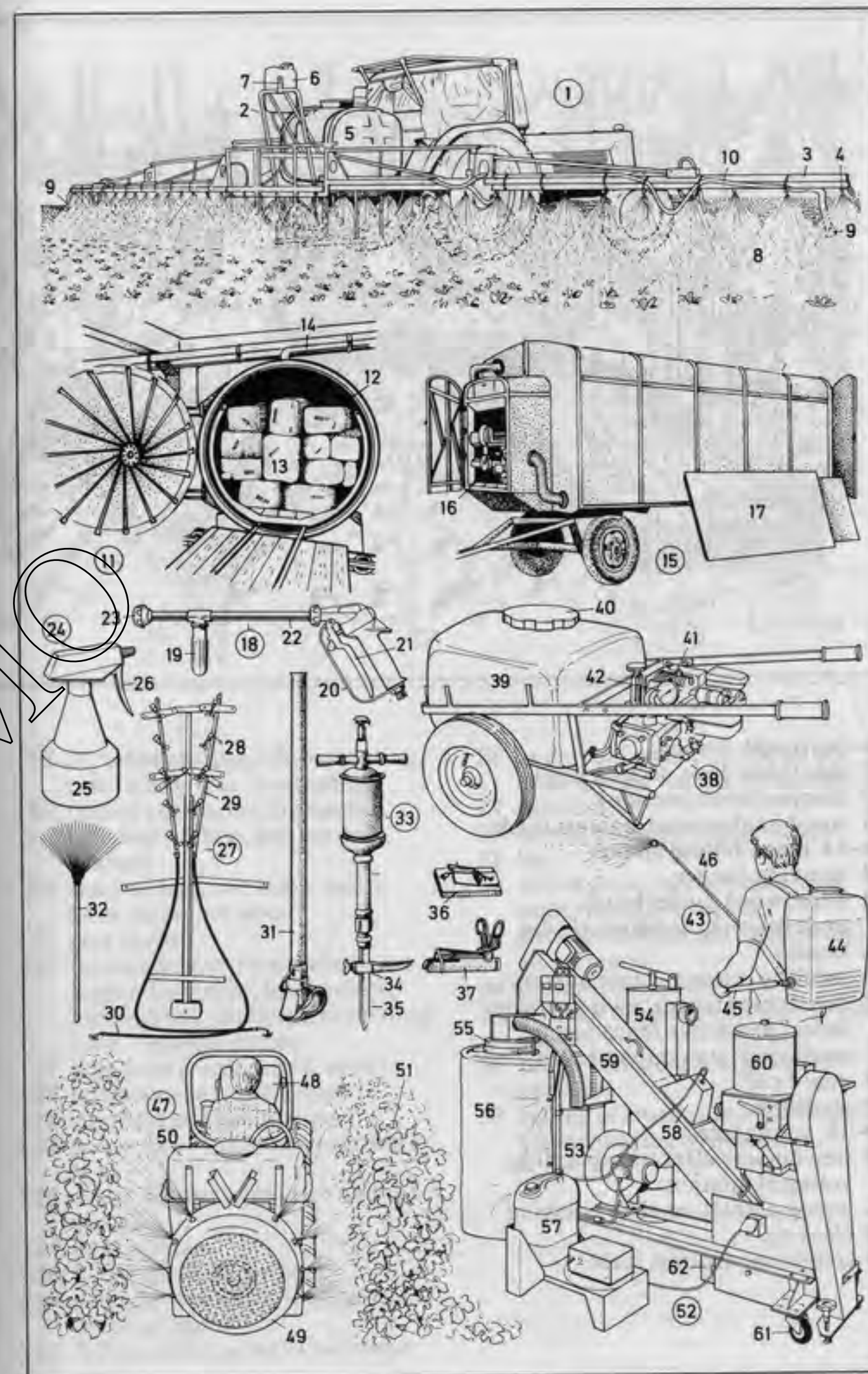

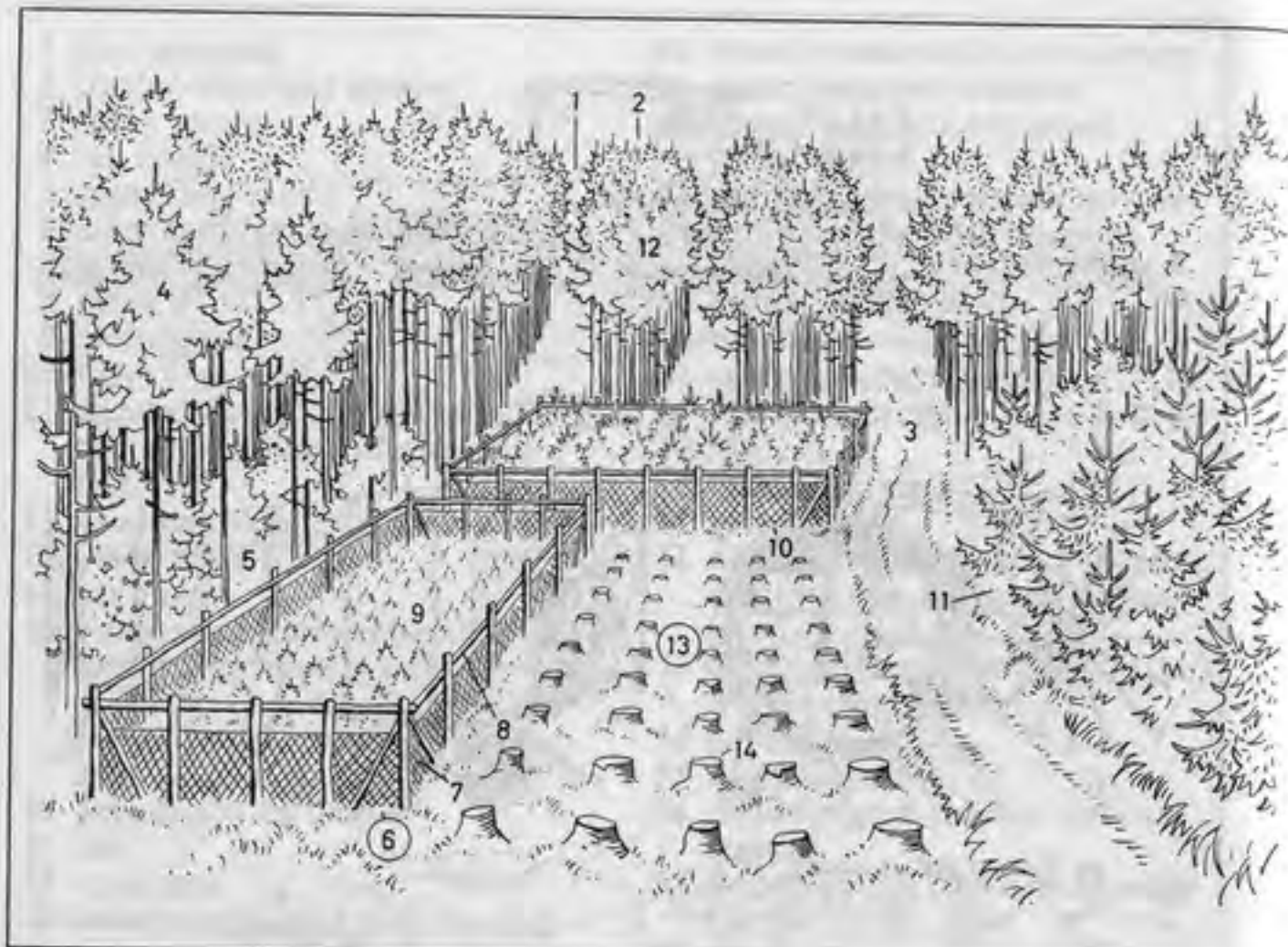

- 1-34 forest, a wood
 1 ride (aisle, lane, section line)
 2 compartment (section)
 3 wood haulage way, a forest track
 4-14 clear-felling system
 4 standing timber
 5 underwood (underbrush, undergrowth, brushwood, *Am.* brush)
 6 seedling nursery, a tree nursery
 7 deer fence (fence), a wire netting fence (protective fence for seedlings); *sim.*: rabbit fence
 8 guard rail
 9 seedlings
 10-11 young trees
 10 tree nursery after transplanting
 11 young plantation
 12 young plantation after brashing
 13 clearing
 14 tree stump (stump, stub)

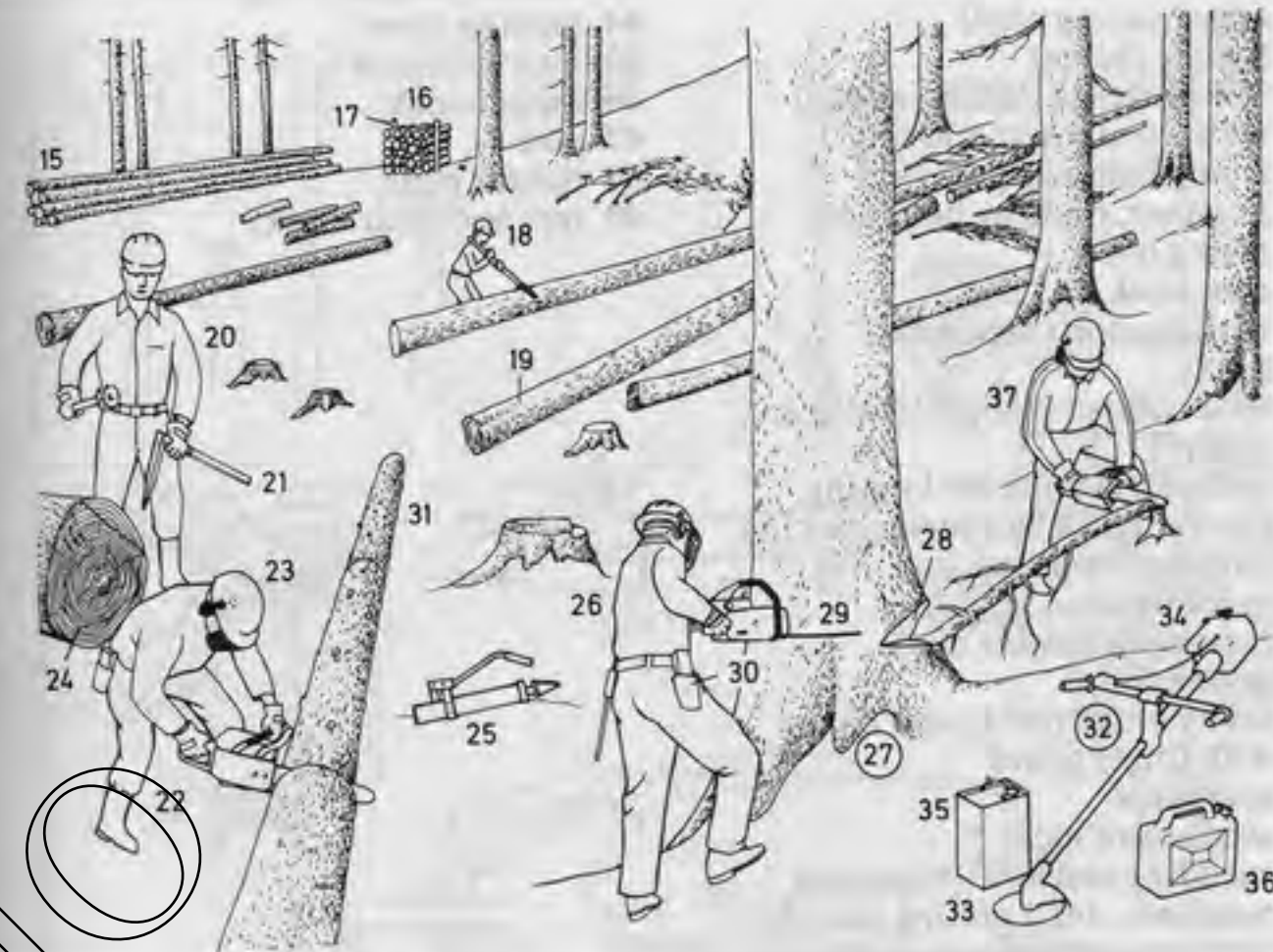

- 15-37 wood cutting (timber cutting, tree felling, *Am.* lumbering)
 15 timber skidded to the stack (stacked timber, *Am.* yarded timber)
 16 stack of logs, one cubic metre (*Am.* meter) of wood
 17 post (stake)
 18 forest labourer (woodsman, *Am.* logger, lumberer, lumberjack, lumberman, timberjack) turning (*Am.* canting) timber
 19 bole (tree trunk, trunk, stem)
 20 feller numbering the logs
 21 steel tree calliper (caliper)
 22 power saw (motor saw) cutting a bole
 23 safety helmet with visor and ear pieces
 24 annual rings
 25 hydraulic felling wedge
 26 protective clothing [orange top, green trousers]
 27 felling with a power saw (motor saw)
 28 undercut (notch, throat, gullet, mouth, sink, kerf, birdsmouth)
 29 back cut
 30 sheath holding felling wedge
 31 log
 32 free-cutting saw for removing underwood and weeds
 33 circular saw (or activated blade) attachment
 34 power unit (motor)
 35 canister of viscous oil for the saw chain
 36 petrol canister (*Am.* gasoline canister)
 37 felling of small timber (of small-sized thinnings) (thinning)

- | | |
|--|---------------------------|
| 1 axe (<i>Am.</i> ax) | 43 tractor (tractor unit) |
| 2 edge (cutting edge) | 44 loading crane |
| 3 handle (helve) | 45 hydraulic jack |
| 4 felling wedge (falling wedge)
with wood insert and ring | 46 cable winch |
| 5 riving hammer (cleaving
hammer, splitting hammer) | 47 post |
| 6 lifting hook | 48 bolster plate |
| 7 cant hook | 49 rear bed (rear bunk) |
| 8 barking iron (bark spud) | |
| 9 peavy | |
| 10 slide calliper (caliper) (calliper
square) | |
| 11 billhook, a knife for lopping | |
| 12 revolving die hammer (marking
hammer, marking iron, <i>Am.</i>
marker) | |
| 13 power saw (motor saw) | |
| 14 saw chain | |
| 15 safety brake for the saw chain,
with finger guard | |
| 16 saw guide | |
| 17 accelerator lock | |
| 18 snedding machine (trimming
machine, <i>Am.</i> knotting machine,
limbing machine) | |
| 19 feed rolls | |
| 20 flexible blade | |
| 21 hydraulic arm | |
| 22 trimming blade | |
| 23 debarking (barking, bark
stripping) of boles | |
| 24 feed roller | |
| 25 cylinder trimmer | |
| 26 rotary cutter | |
| 27 short-haul skidder | |
| 28 loading crane | |
| 29 log grips | |
| 30 post | |
| 31 Ackermann steering system | |
| 32 log dump | |
| 33 number (identification number) | |
| 34 skidder | |
| 35 front blade (front plate) | |
| 36 crush-proof safety bonnet (<i>Am.</i>
safety hood) | |
| 37 Ackermann steering system | |
| 38 cable winch | |
| 39 cable drum | |
| 40 rear blade (rear plate) | |
| 41 boles with butt ends held off the
ground | |
| 42 haulage of timber by road | |

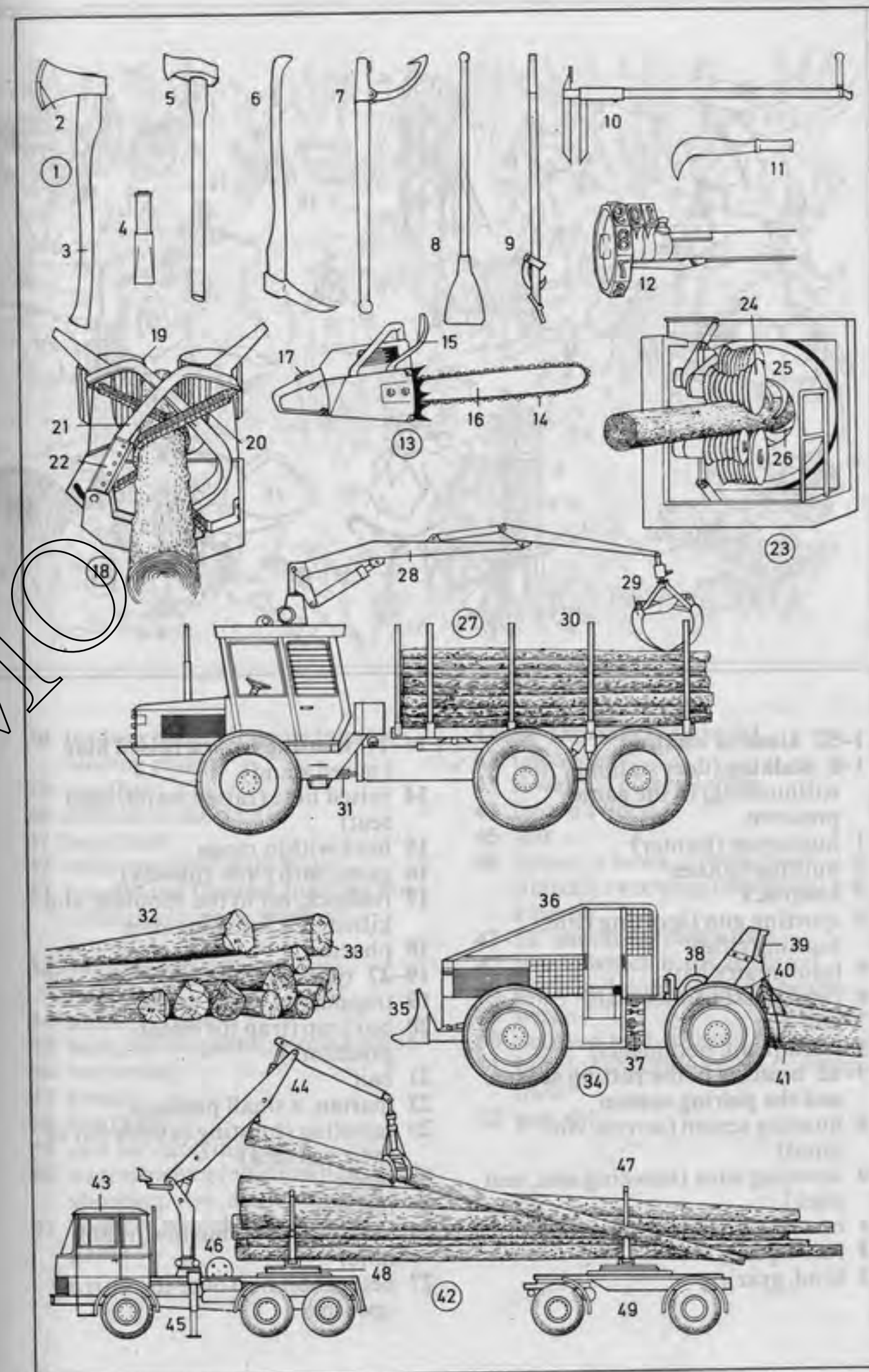

**1-52 kinds of hunting**

1-8 stalking (deer stalking, *Am.* stillhunting) in the game preserve

1 huntsman (hunter)

2 hunting clothes

3 knapsack

4 sporting gun (sporting rifle, hunting rifle)

5 huntsman's hat

6 field glasses, binoculars

7 gun dog

8 track (trail, hoofprints)

9-12 hunting in the rutting season and the pairing season

9 hunting screen (screen, *Am.* blind)

10 shooting stick (shooting seat, seat stick)

11 blackcock, displaying

12 rutting stag

13 hind, grazing

14-17 hunting from a raised hide (raised stand)

14 raised hide (raised stand, high seat)

15 herd within range

16 game path (*Am.* runway)

17 roebuck, hit in the shoulder and killed by a finishing shot

18 phaeton

19-27 types of trapping

19 trapping of small predators

20 box trap (trap for small predators)

21 bait

22 marten, a small predator

23 ferreting (hunting rabbits out of their warrens)

24 ferret

25 ferreter

26 burrow (rabbit burrow, rabbit hole)

27 net (rabbit net) over the burrow opening

28 feeding place for game (winter feeding place)

29 poacher

30 carbine, a short rifle

31 boar hunt

32 wild sow (sow, wild boar)

33 boarhound (hound, hunting dog; collectively: pack, pack of hounds)

34-39 beating (driving, hare hunting)

34 aiming position

35 hare, furred game, ground game

36 retrieving

37 beater

38 bag (kill)

39 cart for carrying game

40 waterfowling (wildfowling, duck shooting, *Am.* duck hunting)

41 flight of wild ducks, winged game

42-46 falconry (hawking)

42 falconer

43 reward, a piece of meat

44 falcon's hood

45 jess

46 falcon, a hawk, a male hawk (tiercel) swooping (stooping) on a heron

47-52 shooting from a butt

47 tree to which birds are lured

48 eagle owl, a decoy bird (decoy)

49 perch

50 decoyed bird, a crow

51 butt for shooting crows or eagle owls

52 gun slit

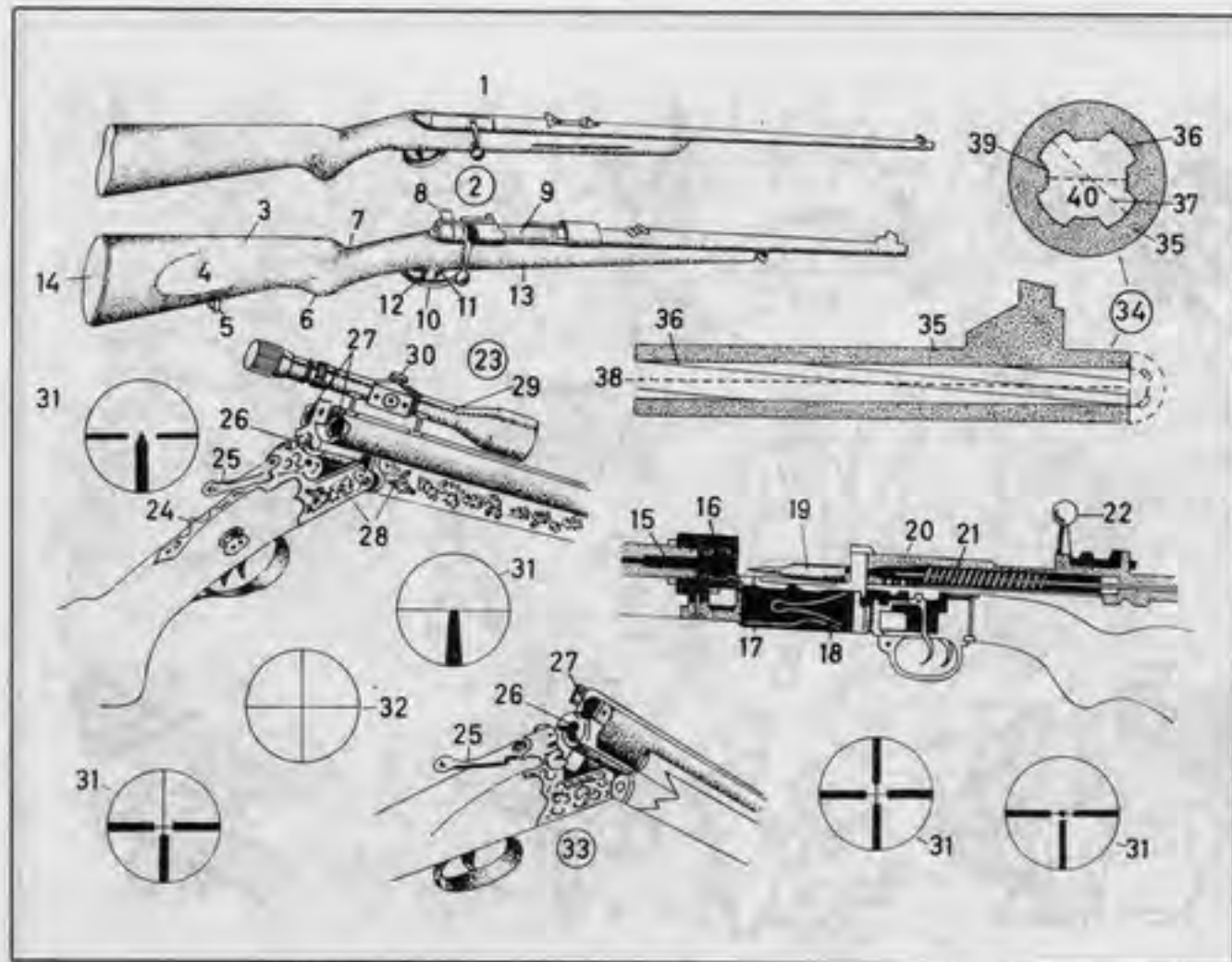
**1-40 sporting guns** (sporting rifles, hunting rifles)

- | | |
|---|---|
| 1 single-loader (single-loading rifle) | 21 firing pin (striker) |
| 2 repeating rifle, a small-arm (fire-arm), a repeater (magazine rifle, magazine repeater) | 22 bolt handle (bolt lever) |
| 3, 4, 6, 13 stock | 23 triple-barrelled (triple-barreled) rifle, a self-cocking gun |
| 3 butt | 24 reversing catch (<i>in various guns</i> : safety catch) |
| 4 cheek [on the left side] | 25 sliding safety catch |
| 5 sling ring | 26 rifle barrel (rifled barrel) |
| 6 pistol grip | 27 smooth-bore barrel |
| 7 small of the butt | 28 chasing |
| 8 safety catch | 29 telescopic sight (riflescope, telescope sight) |
| 9 lock | 30 graticule adjuster screws |
| 10 trigger guard | 31-32 graticule (sight graticule) |
| 11 second set trigger (firing trigger) | 31 various graticule systems |
| 12 hair trigger (set trigger) | 32 cross wires (<i>Am.</i> cross hairs) |
| 13 foregrip | 33 over-and-under shotgun |
| 14 butt plate | 34 rifled gun barrel |
| 15 cartridge chamber | 35 barrel casing |
| 16 receiver | 36 rifling |
| 17 magazine | 37 rifling calibre (<i>Am.</i> caliber) |
| 18 magazine spring | 38 bore axis |
| 19 ammunition (cartridge) | 39 land |
| 20 chamber | 40 calibre (bore diameter, <i>Am.</i> caliber) |

41-48 hunting equipment

- | |
|---|
| 41 double-edged hunting knife |
| 42 [single-edged] hunting knife |
| 43-47 calls for luring game (for calling game) |
| 43 roe call |
| 44 hare call |
| 45 quail call |
| 46 stag call |
| 47 partridge call |
| 48 bow trap (bow gin), a jaw trap |
| 49 small-shot cartridge |
| 50 cardboard case |
| 51 small-shot charge |
| 52 felt wad |
| 53 smokeless powder (<i>different kind</i> : black powder) |
| 54 cartridge |
| 55 full-jacketed cartridge |
| 56 soft-lead core |
| 57 powder charge |
| 58 detonator cap |
| 59 percussion cap |
| 60 hunting horn |
| 61-64 rifle cleaning kit |
| 61 cleaning rod |
| 62 cleaning brush |
| 63 cleaning tow |
| 64 pull-through (<i>Am.</i> pull-thru) |
| 65 sights |
| 66 notch (sighting notch) |
| 67 back sight leaf |
| 68 sight scale division |
| 69 back sight slide |
| 70 notch [to hold the spring] |
| 71 front sight (foresight) |
| 72 bead |
| 73 ballistics |
| 74 azimuth |
| 75 angle of departure |
| 76 angle of elevation |
| 77 apex (zenith) |
| 78 angle of descent |
| 79 ballistic curve |

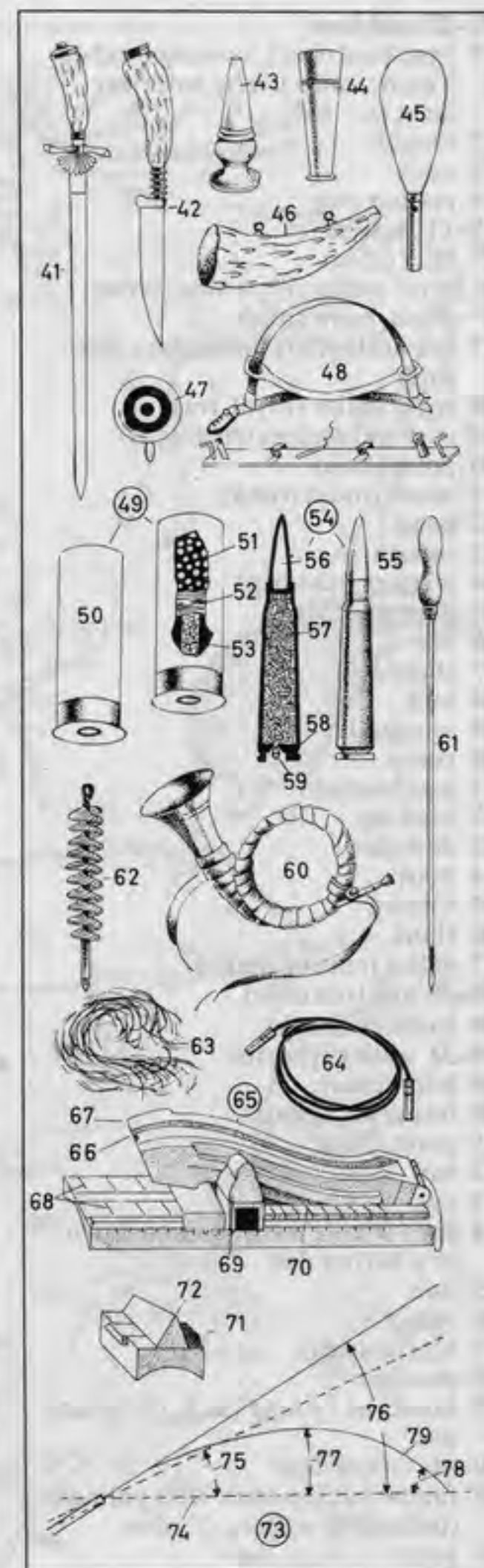

- 1-27 red deer
 1 hind (red deer), a young hind or a dam; *collectively*: anterless deer, (*y.*) calf
 2 tongue
 3 neck
 4 rutting stag
 5-11 antlers
 5 burr (rose)
 6 brow antler (brow tine, brow point, brow snag)
 7 bez antler (bay antler, bay, bez tine)
 8 royal antler (royal, tray)
 9 surroyal antlers (surroyals)
 10 point (tine)
 11 beam (main trunk)
 12 head
 13 mouth
 14 larmier (tear bag)
 15 eye
 16 ear
 17 shoulder
 18 loin
 19 scut (tail)
 20 rump
 21 leg (haunch)
 22 hind leg
 23 dew claw
 24 hoof
 25 foreleg
 26 flank
 27 collar (rutting mane)
 28-39 roe (roe deer)
 28 roebuck (buck)
 29-31 antlers (horns)
 29 burr (rose)
 30 beam with pearls
 31 point (tine)
 32 ear
 33 eye
 34 doe (female roe), a female fawn or a barren doe
 35 loin
 36 rump
 37 leg (haunch)
 38 shoulder
 39 fawn, (*m.*) young buck, (*f.*) young doe
 40-41 fallow deer
 40 fallow buck, a buck with palmate (palmated) antlers, (*f.*) doe
 41 palm

- 42 red fox, (*m.*) dog, (*f.*) vixen, (*y.*) cub
 43 eyes
 44 ear
 45 muzzle (mouth)
 46 pads (paws)
 47 brush (tail)
 48 badger, (*f.*) sow
 49 tail
 50 paws
 51 wild boar, (*m.*) boar, (*f.*) wild sow (sow), (*y.*) young boar
 52 bristles
 53 snout
 54 tusk
 55 shield
 56 hide
 57 dew claw
 58 tail
 59 hare, (*m.*) buck, (*f.*) doe
 60 eye
 61 ear
 62 scut (tail)
 63 hind leg
 64 foreleg
 65 rabbit
 66 blackcock
 67 tail
 68 falcate (falcated) feathers
 69 hazel grouse (hazel hen)
 70 partridge
 71 horseshoe (horseshoe marking)
 72 wood grouse (capercaillie)
 73 beard
 74 axillary marking
 75 tail (fan)
 76 wing (pinion)
 77 common pheasant, a pheasant, (*m.*) cock pheasant (pheasant cock), (*f.*) hen pheasant (pheasant hen)
 78 plumicorn (feathered ear, ear tuft, ear, horn)
 79 wing
 80 tail
 81 leg
 82 spur
 83 snipe
 84 bill (beak)

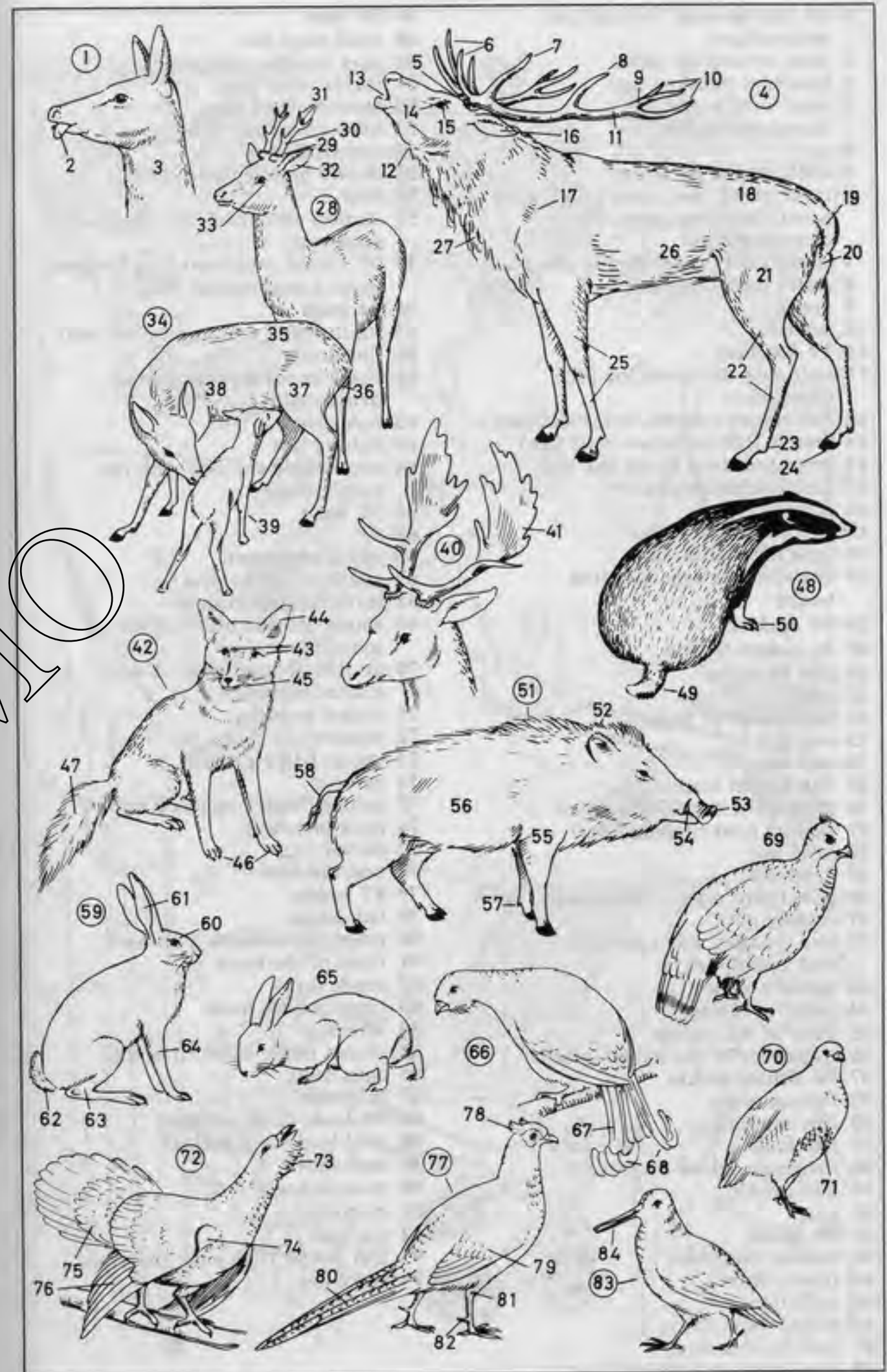

- 1-19 fish farming (fish culture, pisciculture)
- 1 cage in running water
- 2 hand net (landing net)
- 3 semi-oval barrel for transporting fish
- 4 vat
- 5 trellis in the overflow
- 6 trout pond; *sim.*: carp pond, a fry pond, fattening pond, or cleansing pond
- 7 water inlet (water supply pipe)
- 8 water outlet (outlet pipe)
- 9 monk
- 10 screen
- 11-19 hatchery
- 11 stripping the spawning pike (seed pike)
- 12 fish spawn (spawn, roe, fish eggs)
- 13 female fish (spawner, seed fish)
- 14 trout breeding (trout rearing)
- 15 Californian incubator
- 16 trout fry
- 17 hatching jar for pike
- 18 long incubation tank
- 19 Brandstetter egg-counting board
- 20-94 angling
- 20-31 coarse fishing
- 20 line shooting
- 21 coils
- 22 cloth (rag) or paper
- 23 rod rest
- 24 bait tin
- 25 fish basket (creel)
- 26 fishing for carp from a boat
- 27 rowing boat (fishing boat)
- 28 keep net
- 29 drop net
- 30 pole (punt pole, quant pole)
- 31 casting net
- 32 two-handed side cast with fixed-spool reel
- 33 initial position
- 34 point of release
- 35 path of the rod tip
- 36 trajectory of the baited weight
- 37-94 fishing tackle
- 37 fishing pliers
- 38 filleting knife
- 39 fish knife
- 40 disgorging (hook disgorging)
- 41 bait needle
- 42 gag
- 43-48 floats
- 43 sliding cork float
- 44 plastic float
- 45 quill float
- 46 polystyrene float
- 47 oval bubble float
- 48 lead-weighted sliding float

- 49-58 rods
- 49 solid glass rod
- 50 cork handle (cork butt)
- 51 spring-steel ring
- 52 top ring (end ring)
- 53 telescopic rod
- 54 rod section
- 55 bound handle (bound butt)
- 56 ring
- 57 carbon-fibre rod; *sim.*: hollow glass rod
- 58 all-round ring (butt ring for long cast), a steel bridge ring
- 59-64 reels
- 59 multiplying reel (multiplier reel)
- 60 line guide
- 61 fixed-spool reel (stationary-drum reel)
- 62 bale arm
- 63 fishing line
- 64 controlling the cast with the index finger
- 65-76 baits
- 65 fly
- 66 artificial nymph
- 67 artificial earthworm
- 68 artificial grasshopper
- 69 single-jointed plug (single-jointed wobbler)
- 70 double-jointed plug (double-jointed wobbler)
- 71 round wobbler
- 72 wiggler
- 73 spoon bait (spoon)
- 74 spinner
- 75 spinner with concealed hook
- 76 long spinner
- 77 swivel
- 78 cast (leader)
- 79-87 hooks
- 79 fish hook
- 80 point of the hook with barb
- 81 bend of the hook
- 82 spade (eye)
- 83 open double hook
- 84 limerick
- 85 closed treble hook (triangle)
- 86 carp hook
- 87 eel hook
- 88-92 leads (lead weights)
- 88 oval lead (oval sinker)
- 89 lead shot
- 90 pear-shaped lead
- 81 plummet
- 92 sea lead
- 93 fish ladder (fish pass, fish way)
- 94 stake net

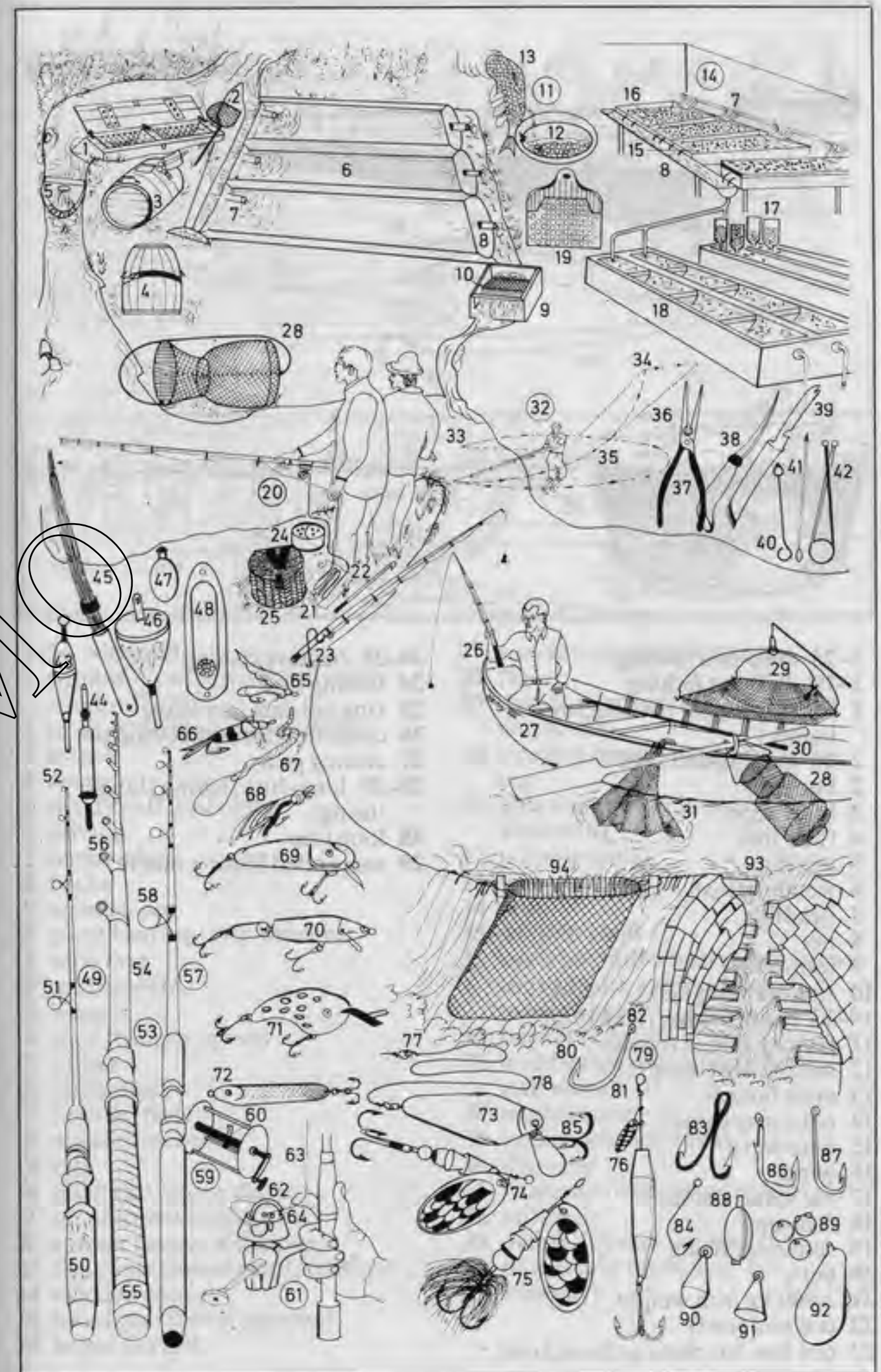

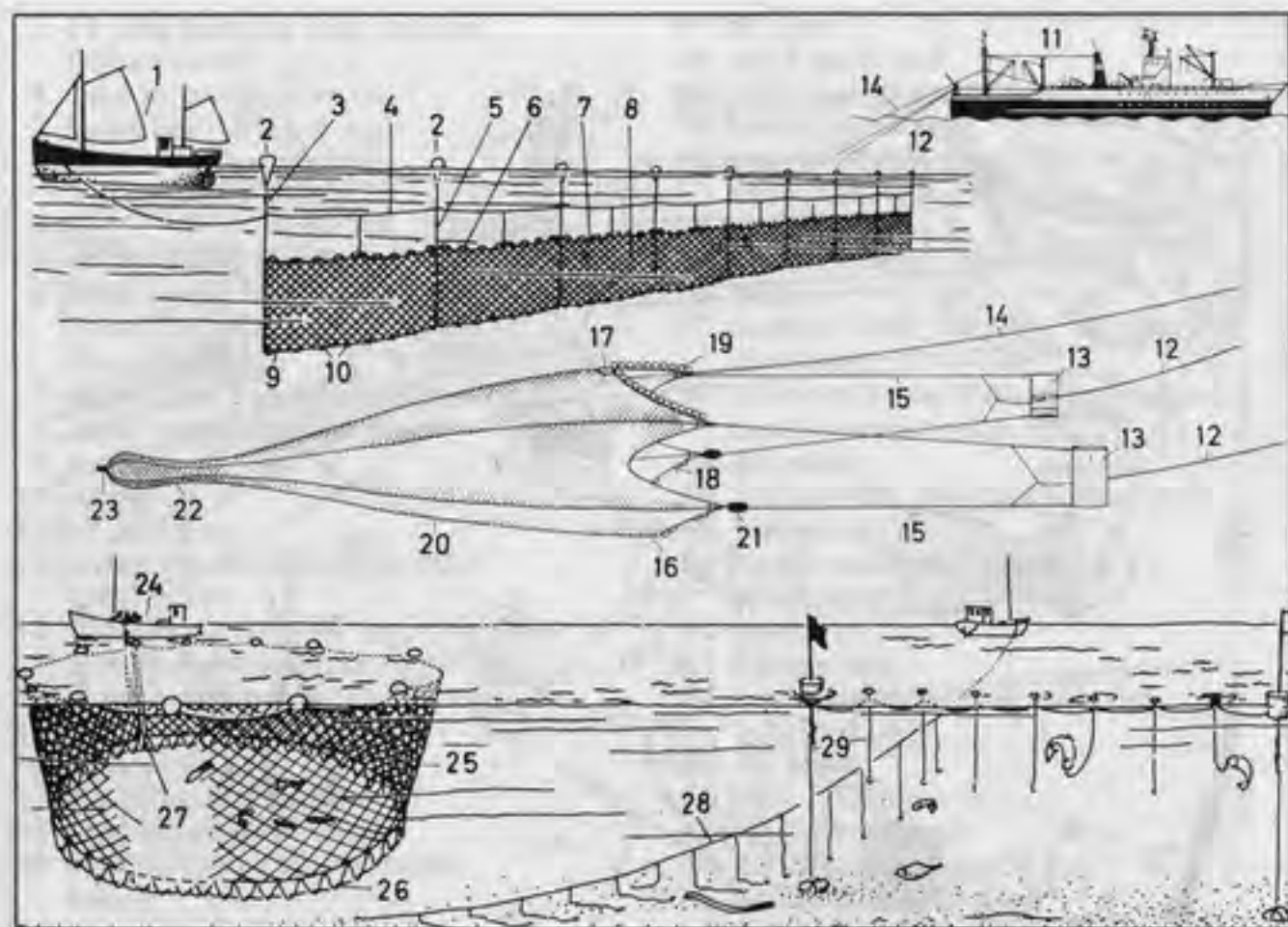
**1-23 deep-sea fishing****1-10 drift net fishing**

1 herring lugger (fishing lugger, lugger)

2-10 herring drift net

2 buoy
3 buoy rope
4 float line
5 seizing
6 wooden float
7 headline
8 net
9 footrope

10 sinkers (weights)

11-23 trawl fishing (trawling)

11 factory ship, a trawler
12 warp (trawl warp)
13 otter boards
14 net sonar cable
15 wire warp
16 wing
17 net sonar device
18 footrope
19 spherical floats
20 belly
21 1,800 kg iron weight
22 cod end (cod)
23 cod line for closing the cod end

24-29 inshore fishing

24 fishing boat
25 ring net cast in a circle
26 cable for closing the ring net
27 closing gear
28-29 long-line fishing (long-lining)
28 long line
29 suspended fishing tackle

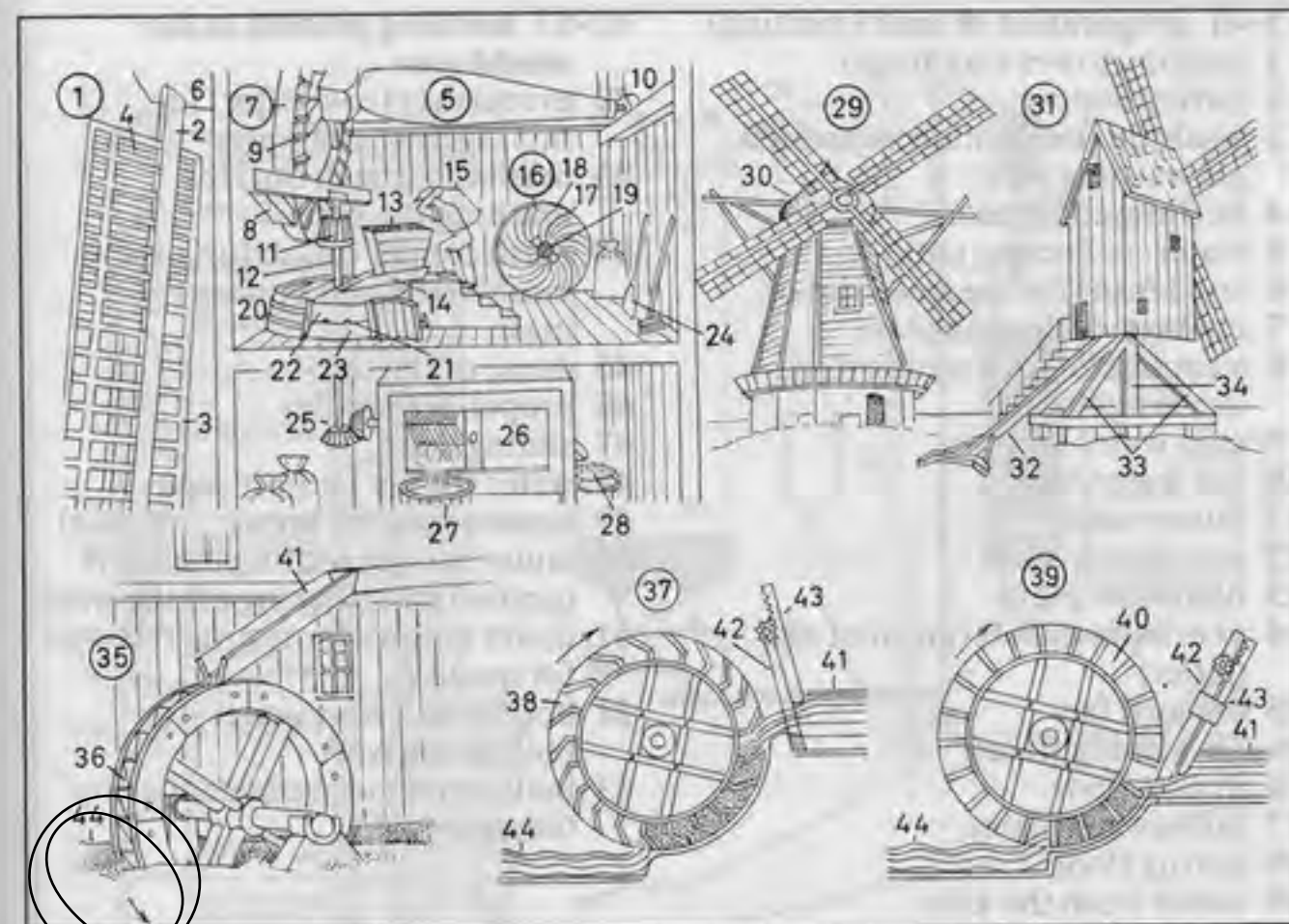
**1-34 windmill**

1 windmill vane (windmill sail, windmill arm)
2 stock (middling, back, radius)
3 frame
4 shutter
5 wind shaft (sail axle)
6 sail top
7 brake wheel
8 brake
9 wooden cog
10 pivot bearing (step bearing)
11 wallower
12 mill spindle
13 hopper
14 shoe (trough, spout)
15 miller
16 millstone
17 furrow (flute)
18 master furrow
19 eye
20 hurst (millstone casing)
21 set of stones (millstones)
22 runner (upper millstone)
23 bed stone (lower stone, bedder)
24 wooden shovel
25 bevel gear (bevel gearing)
26 bolter (sifter)

27 wooden tub (wooden tun)

28 flour

29 smock windmill (Dutch windmill)

30 rotating (revolving) windmill cap

31 post windmill (German windmill)

32 tailpole (pole)

33 base

34 post

35-44 watermill

35 overshot mill wheel (high-breast mill wheel), a mill wheel (waterwheel)

36 bucket (cavity)

37 middleshot mill wheel (breast mill wheel)

38 curved vane

39 undershot mill wheel

40 flat vane

41 headrace (discharge flume)

42 mill weir

43 overfall (water overfall)

44 millstream (millrace, *Am.* raceway)

- 1-41 preparation of malt (malting)**
- 1 malting tower (maltings)
 - 2 barley hopper
 - 3 washing floor with compressed-air washing unit
 - 4 outflow condenser
 - 5 water-collecting tank
 - 6 condenser for the steep liquor
 - 7 coolant-collecting plant
 - 8 steeping floor (steeping tank, dressing floor)
 - 9 cold water tank
 - 10 hot water tank
 - 11 pump room
 - 12 pneumatic plant
 - 13 hydraulic plant
 - 14 ventilation shaft (air inlet and outlet)
 - 15 exhaust fan
 - 16-18 kilning floors**
 - 16 drying floor
 - 17 burner ventilator
 - 18 curing floor
 - 19 outlet from the kiln
 - 20 finished malt collecting hopper
 - 21 transformer station
 - 22 cooling compressors
 - 23 green malt (germinated barley)
 - 24 turner (plough)
 - 25 central control room with flow diagram
 - 26 screw conveyor
 - 27 washing floor
 - 28 steeping floor
 - 29 drying kiln
 - 30 curing kiln
 - 31 barley silo
 - 32 weighing apparatus
 - 33 barley elevator
 - 34 three-way chute (three-way tippler)
 - 35 malt elevator
 - 36 cleaning machine
 - 37 malt silo
 - 38 corn removal by suction
 - 39 sacker
 - 40 dust extractor
 - 41 barley reception

- 42-53 mashing process in the mashhouse**
- 42 premasher (converter) for mixing grist and water
 - 43 mash tub (mash tun) for mashing the malt
 - 44 mash copper (mash tun, Am. mash kettle) for boiling the mash
 - 45 dome of the tun
 - 46 propeller (paddle)
 - 47 sliding door
 - 48 water (liquor) supply pipe
 - 49 brewer (master brewer, masher)
 - 50 lauter tun for settling the draff (grains) and filtering off the wort for quality
 - 51 lauter battery for testing the wort for quality
 - 52 hop boiler (wort boiler) for boiling the wort
 - 53 ladle-type thermometer (scoop thermometer)

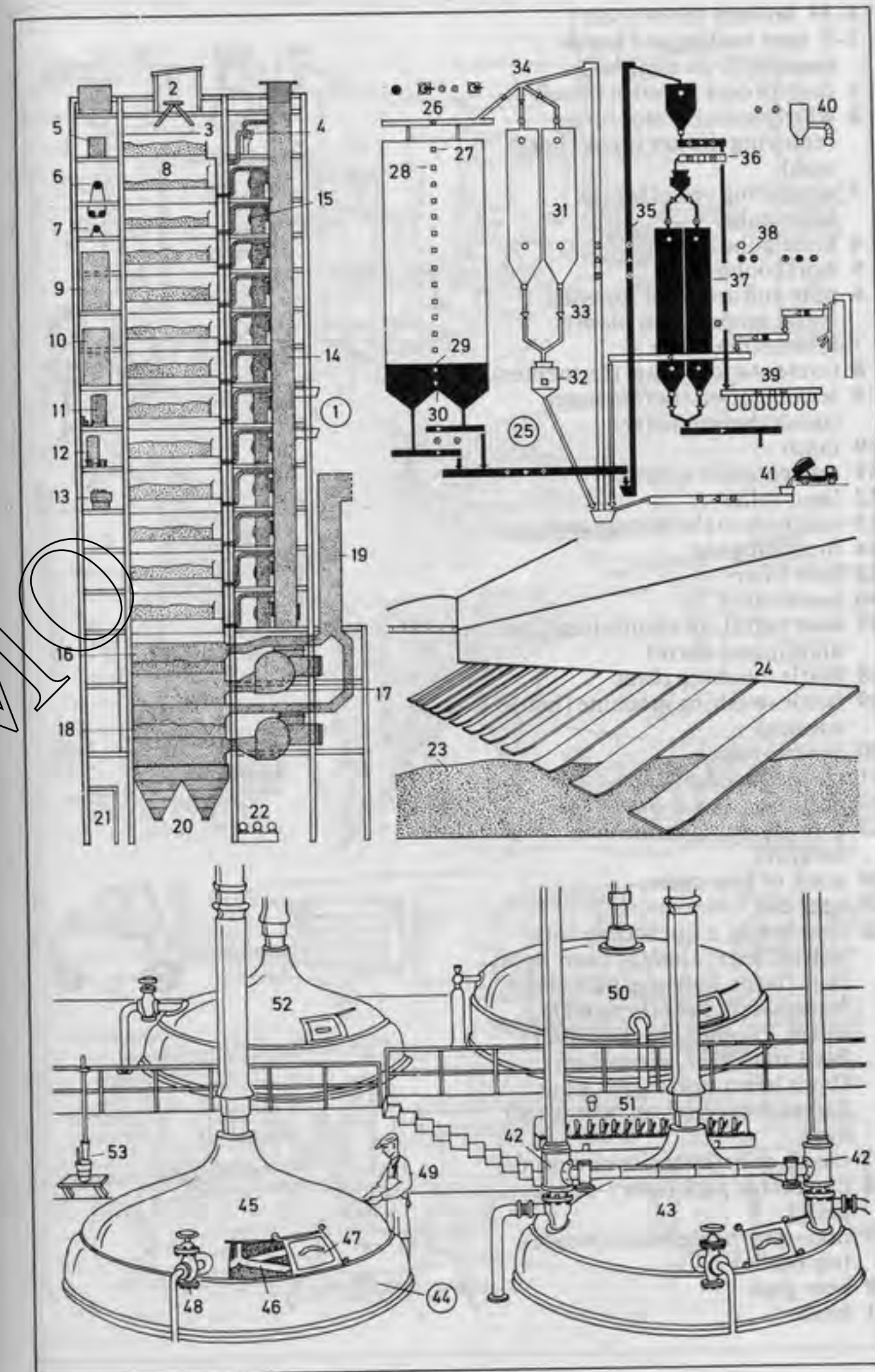

- 1-31 brewery (brewhouse)
- 1-5 wort cooling and break removal (trub removal)
- 1 control desk (control panel)
- 2 whirlpool separator for removing the hot break (hot trub)
- 3 measuring vessel for the kieselguhr
- 4 kieselguhr filter
- 5 wort cooler
- 6 pure culture plant for yeast (yeast propagation plant)
- 7 fermenting cellar
- 8 fermentation vessel (fermenter)
- 9 fermentation thermometer (mash thermometer)
- 10 mash
- 11 refrigeration system
- 12 lager cellar
- 13 manhole to the storage tank
- 14 broaching tap
- 15 beer filter
- 16 barrel store
- 17 beer barrel, an aluminium (*Am.* aluminum) barrel
- 18 bottle-washing plant
- 19 bottle-washing machine (bottle washer)
- 20 control panel
- 21 cleaned bottles
- 22 bottling
- 23 forklift truck (fork truck, forklift)
- 24 stack of beer crates
- 25 beer can
- 26 beer bottle, a Eurobottle with bottled beer; *kinds of beer*: light beer (lager, light ale, pale ale or bitter), dark beer (brown ale, mild), Pilsener beer, Munich beer, malt beer, strong beer (bock beer), porter, ale, stout, Salvator beer, wheat beer, small beer
- 27 crown cork (crown cork closure)
- 28 disposable pack (carry-home pack)
- 29 non-returnable bottle (single-trip bottle)
- 30 beer glass
- 31 head

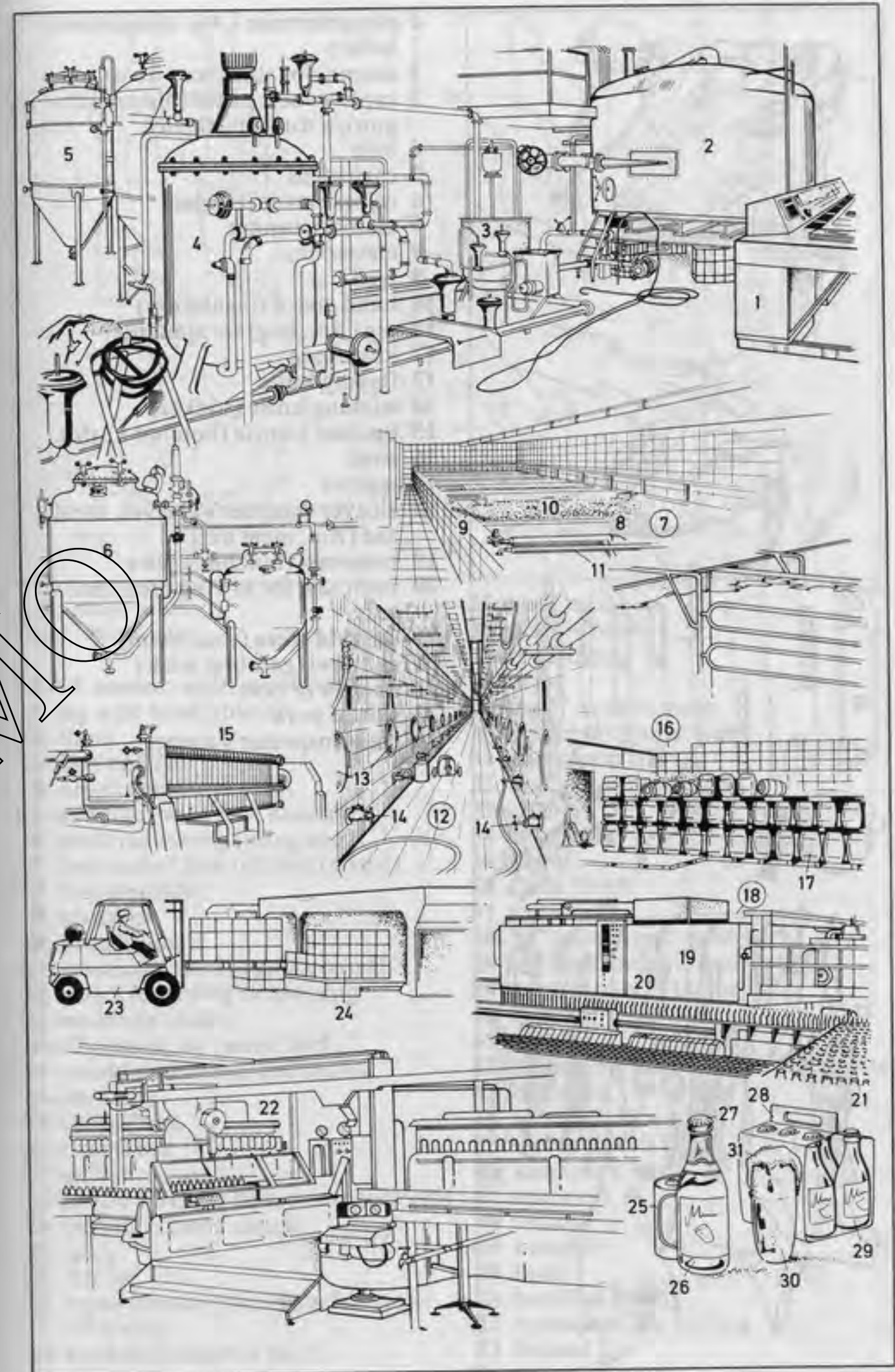

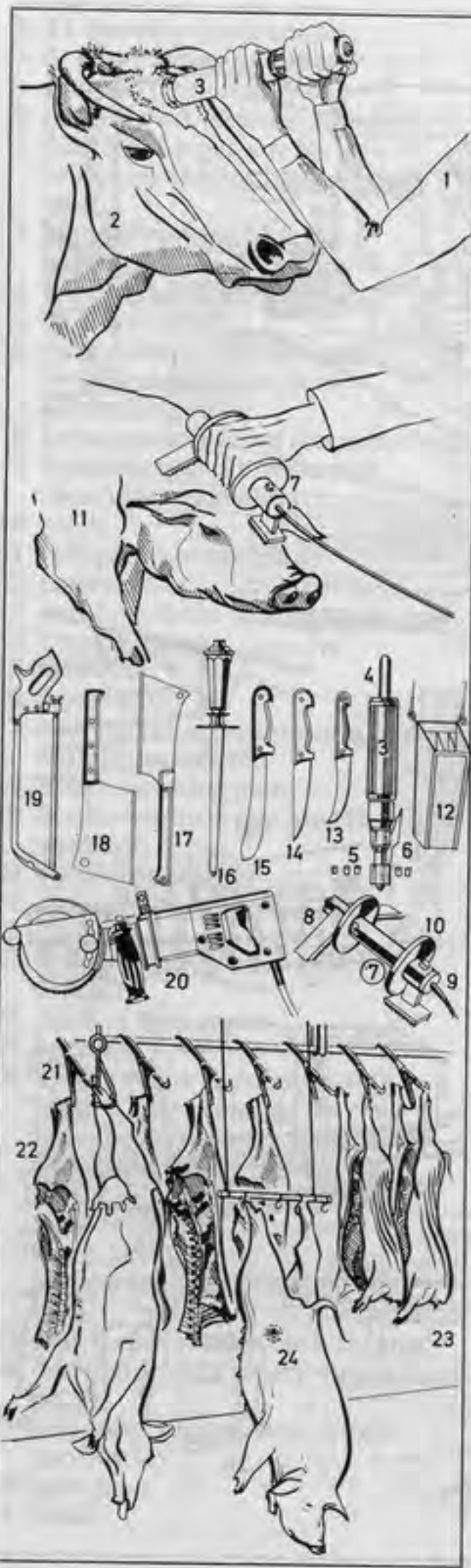

- 1 slaughterman (*Am.* slaughterer, killer)
- 2 animal for slaughter, an ox
- 3 captive-bolt pistol (pneumatic gun), a stunning device
- 4 bolt
- 5 cartridges
- 6 release lever (trigger)
- 7 electric stunner
- 8 electrode
- 9 lead
- 10 hand guard (insulation)
- 11 pig (*Am.* hog) for slaughter
- 12 knife case
- 13 flaying knife
- 14 sticking knife (sticker)
- 15 butcher's knife (butcher knife)
- 16 steel
- 17 splitter
- 18 cleaver (butcher's cleaver, meat axe (*Am.* meat ax))
- 19 bone saw (butcher's saw)
- 20 meat saw for sawing meat into cuts
- 21-24 cold store (cold room)
- 21 gambrel (gambrel stick)
- 22 quarter of beef
- 23 side of pork
- 24 meat inspector's stamp

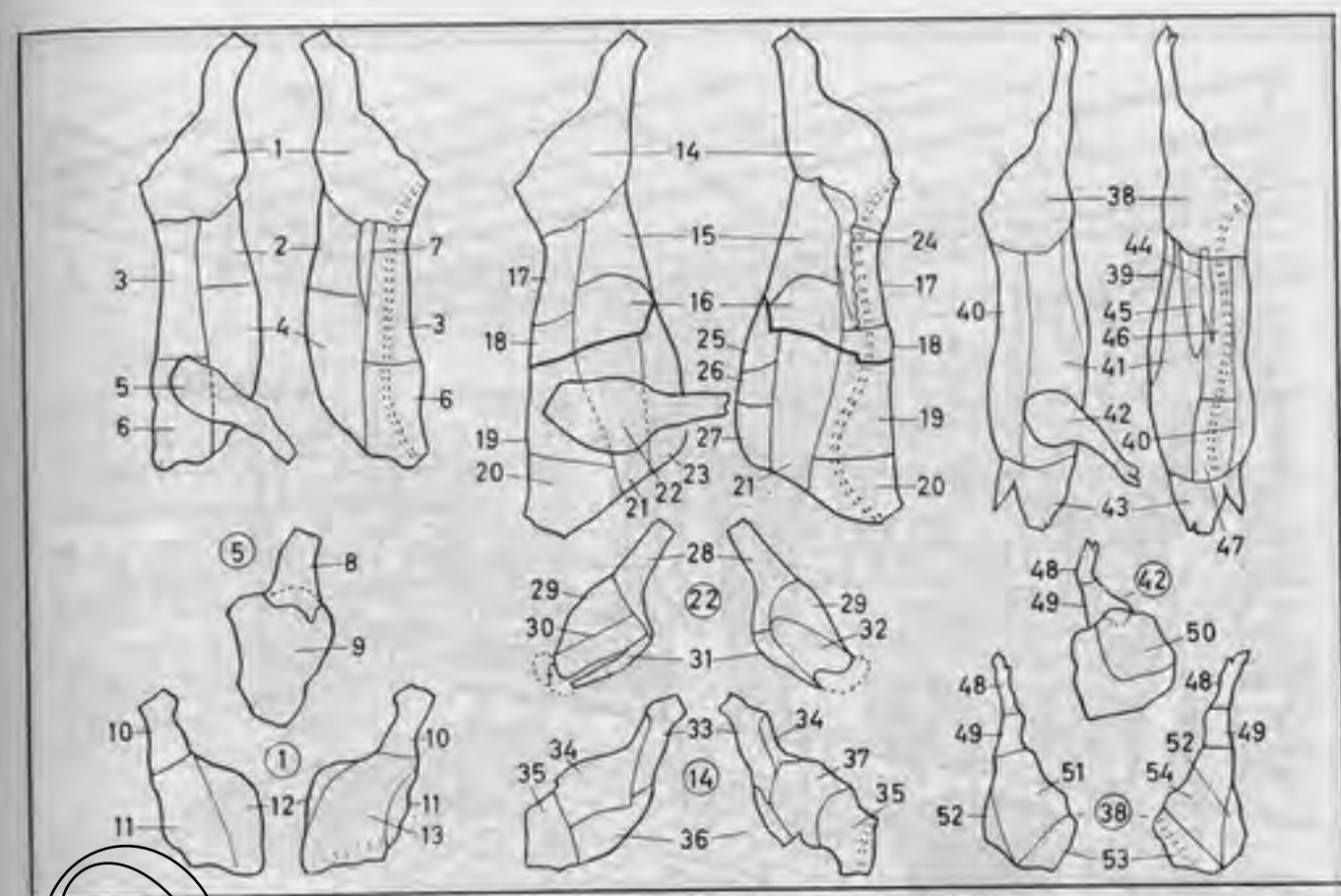

left: meat side;
right: bone side

- 1-13 animal: calf; meat: veal
- 1 leg with hind knuckle
- 2 flank
- 3 loin and rib
- 4 breast (breast of veal)
- 5 shoulder with fore knuckle
- 6 neck with scrag (scrag end)
- 7 best end of loin (of loin of veal)
- 8 fore knuckle
- 9 shoulder
- 10 hind knuckle
- 11 roasting round (oyster round)
- 12 cutlet for frying or braising
- 13 undercut (fillet)
- 14-37 animal: ox; meat: beef
- 14 round with rump and shank
- 15-16 flank
- 15 thick flank
- 16 thin flank
- 17 sirloin
- 18 prime rib (fore ribs, prime fore rib)
- 19 middle rib and chuck
- 20 neck
- 21 flat rib
- 22 leg of mutton piece (bladebone) with shin
- 23 brisket (brisket of beef)
- 24 fillet (fillet of beef)
- 25 hind brisket
- 26 middle brisket
- 27 breastbone
- 28 shin
- 29 leg of mutton piece
- 30 bladebone [meat side]
- 31 part of top rib
- 32 bladebone [bone side]
- 33 shank
- 34 silverside
- 35 rump
- 36 thick flank
- 37 top side
- 38-54 animal: pig; meat: pork
- 38 leg with knuckle and trotter
- 39 ventral part of the belly
- 40 back fat
- 41 belly
- 42 bladebone with knuckle and trotter
- 43 head (pig's head)
- 44 fillet (fillet of pork)
- 45 leaf fat (pork flare)
- 46 loin (pork loin)
- 47 spare rib
- 48 trotter
- 49 knuckle
- 50 butt
- 51 fore end (ham)
- 52 round end for boiling
- 53 fat end
- 54 gammon steak

**1-30 butcher's shop****1-4 meat**

- 1 ham on the bone
- 2 flitch of bacon
- 3 smoked meat
- 4 piece of loin (piece of sirloin)
- 5 lard
- 6-11 sausages**
- 6 price label
- 7 mortadella
- 8 scalded sausage; *kinds*: Vienna sausage (Wiener), Frankfurter sausage (Frankfurter)
- 9 collared pork (*Am.* headcheese)
- 10 ring of Lyoner sausage
- 11 pork sausages; *also*: beef sausages
- 12 cold shelves
- 13 meat salad (diced meat salad)
- 14 cold meats (*Am.* cold cuts)
- 15 pâté
- 16 mince (mincemeat, minced meat)
- 17 knuckle of pork

- 18 basket for special offers
- 19 price list for special offers
- 20 special offer
- 21 freezer
- 22 pre-packed joints
- 23 deep-frozen ready-to-eat meal
- 24 chicken
- 25 canned food
- 26 can
- 27 canned vegetables
- 28 canned fish
- 29 salad cream
- 30 soft drinks

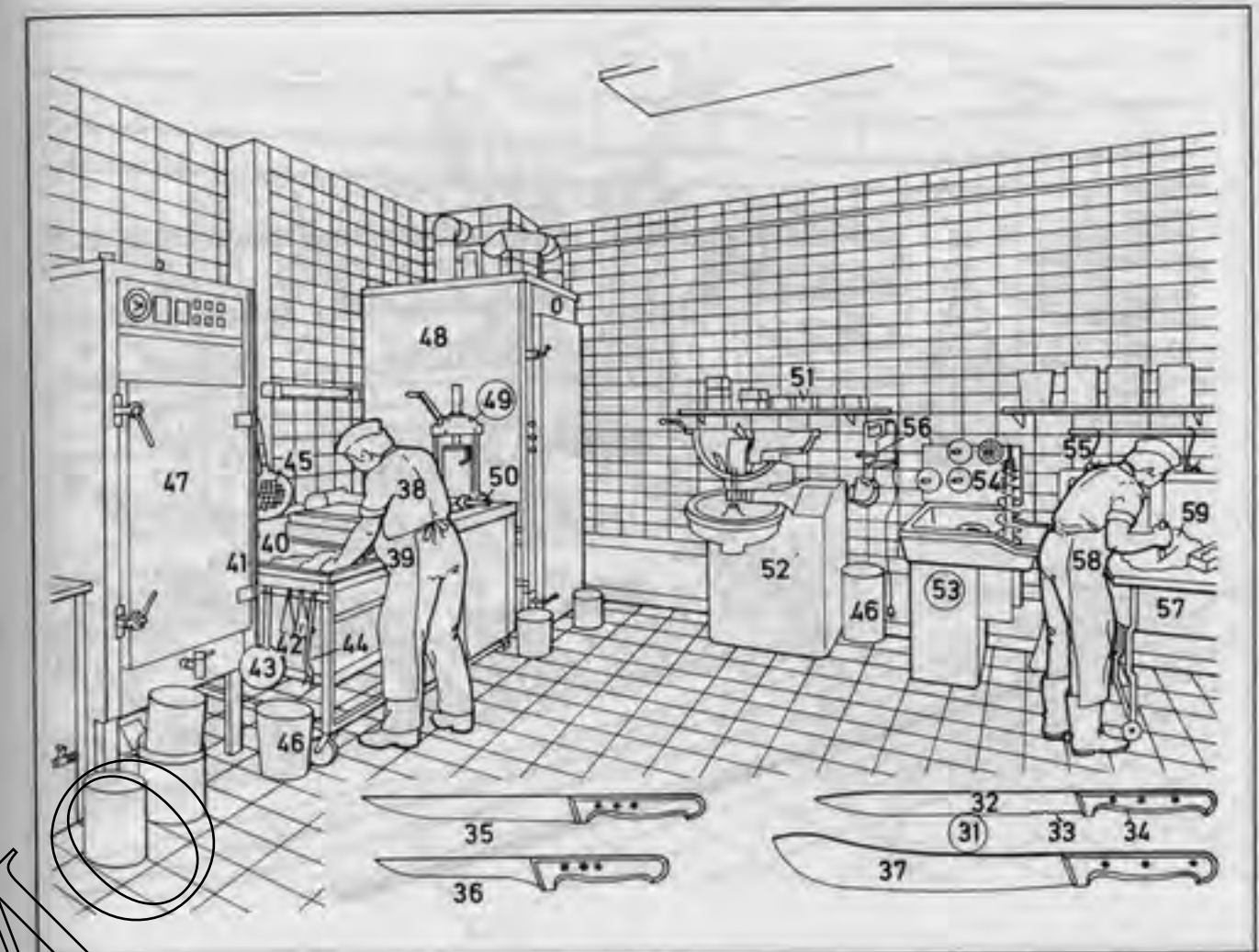
**31-59 manufacture of sausages****31-37 butcher's knives**

- 31 slicer
- 32 knife blade
- 33 saw teeth
- 34 knife handle
- 35 carver (carving knife)
- 36 boning knife
- 37 butcher's knife (butcher knife)
- 38 butcher (master butcher)
- 39 butcher's apron
- 40 meat-mixing trough
- 41 sausage meat
- 42 scraper
- 43 skimmer
- 44 sausage fork
- 45 scalding colander
- 46 waste bin (*Am.* trash bin)
- 47 cooker, for cooking with steam or hot air
- 48 smoke house
- 49 sausage filler (sausage stuffer)
- 50 feed pipe (supply pipe)
- 51 containers for vegetables

- 52 mincing machine for sausage meat
- 53 mincing machine (meat mincer, mincer, *Am.* meat grinder)
- 54 plates (steel plates)
- 55 meathook (butcher's hook)
- 56 bone saw
- 57 chopping board
- 58 butcher, cutting meat
- 59 piece of meat

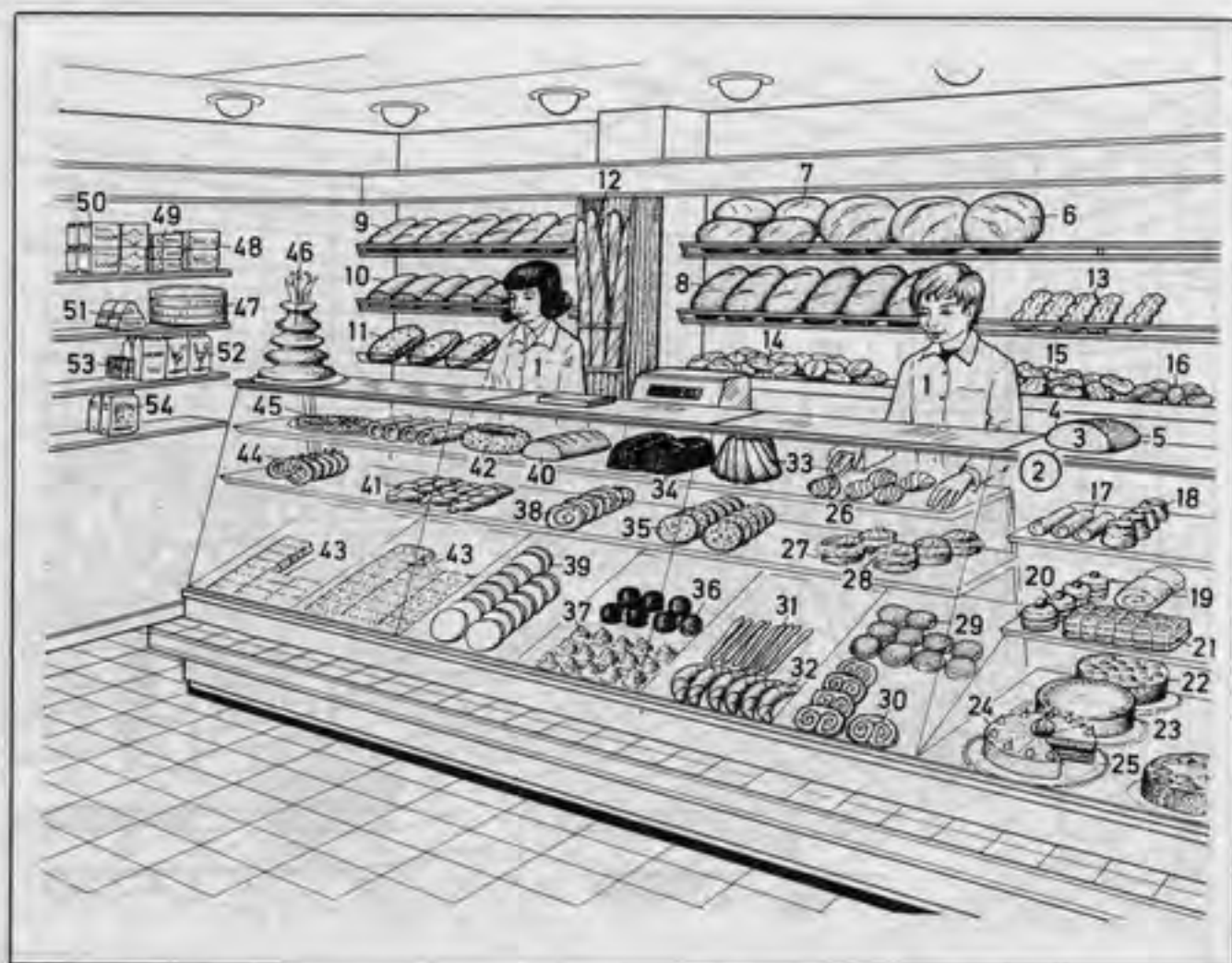
**1-54 baker's shop**

- 1 shop assistant (*Am.* salesgirl, saleslady)
- 2 bread (loaf of bread, loaf)
- 3 crumb
- 4 crust (bread crust)
- 5 crust (*Am.* heel)
- 6-12 kinds of bread (breads)**
- 6 round loaf, a wheat and rye bread
- 7 small round loaf
- 8 long loaf (bloomer), a wheat and rye bread
- 9 white loaf
- 10 pan loaf, a wholemeal rye bread
- 11 yeast bread (*Am.* stollen)
- 12 French loaf (baguette, French stick)
- 13-16 rolls**
- 13 brown roll
- 14 white roll
- 15 finger roll
- 16 rye-bread roll
- 17-47 cakes (confectionery)**
- 17 cream roll
- 18 vol-au-vent, a puff pastry (*Am.* puff paste)

- 19 Swiss roll (*Am.* jelly roll)
- 20 tartlet
- 21 slice of cream cake
- 22-24 flans (*Am.* pies) and gateaux (torten)**
- 22 fruit flan (*kinds:* strawberry flan, cherry flan, gooseberry flan, peach flan, rhubarb flan)
- 23 cheesecake
- 24 cream cake (*Am.* cream pie) (*kinds:* butter-cream cake, Black Forest gateau)
- 25 cake plate
- 26 meringue
- 27 cream puff
- 28 whipped cream
- 29 doughnut (*Am.* bismarck)
- 30 Danish pastry
- 31 saltstick (saltzstange) (*also:* caraway roll, caraway stick)
- 32 croissant (crescent roll, *Am.* crescent)
- 33 ring cake (gugelhupf)
- 34 slab cake with chocolate icing
- 35 streusel cakes
- 36 marshmallow

DEMO

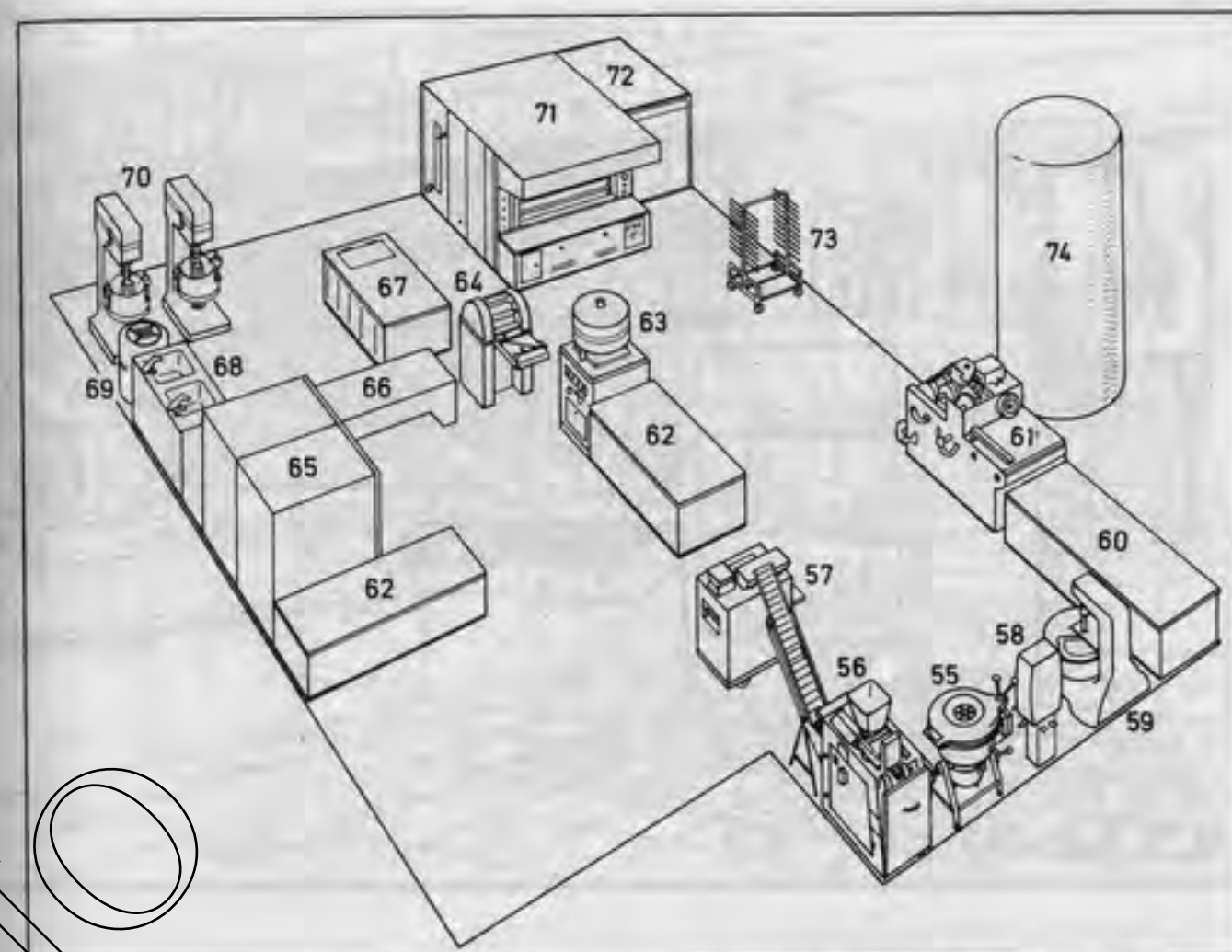

- 37 coconut macaroon
- 38 pastry whirl
- 39 iced bun
- 40 sweet bread
- 41 plaited bun (plait)
- 42 Frankfurter garland cake
- 43 slices (*kinds:* streusel slices, sugared slices, plum slices)
- 44 pretzel
- 45 wafer (*Am.* waffle)
- 46 tree cake (baumkuchen)
- 47 flan case
- 48-50 wrapped bread**
- 48 wholemeal bread (*also:* wheatgerm bread)
- 49 pumpernickel (wholemeal rye bread)
- 50 crispbread
- 51 gingerbread (*Am.* lebkuchen)
- 52 flour (*kinds:* wheat flour, rye flour)
- 53 yeast (baker's yeast)
- 54 rusks (French toast)
- 55-74 bakery (bakehouse)**
- 55 kneading machine (dough mixer)

- 56-57 bread unit**
- 56 divider
- 57 moulder (*Am.* molder)
- 58 premixer
- 59 dough mixer
- 60 workbench
- 61 roll unit
- 62 workbench
- 63 divider and rounder (rounding machine)
- 64 crescent-forming machine
- 65 freezers
- 66 oven [for baking with fat]
- 67-70 confectionery unit**
- 67 cooling table
- 68 sink
- 69 boiler
- 70 whipping unit [with beater]
- 71 reel oven (oven)
- 72 fermentation room
- 73 fermentation trolley
- 74 flour silo



1-87 **grocer's shop** (grocer's, delicatessen shop, *Am. grocery store*, delicatessen store), a retail shop (*Am. retail store*)

- 1 window display
- 2 poster (advertisement)
- 3 cold shelves
- 4 sausages
- 5 cheese
- 6 roasting chicken (broiler)
- 7 poulard, a fattened hen
- 8-11 **baking ingredients**
- 8 raisins; *sim.*: sultanas
- 9 currants
- 10 candied lemon peel
- 11 candied orange peel
- 12 computing scale, a rapid scale
- 13 shop assistant (*Am. salesclerk*)
- 14 goods shelves (shelves)
- 15-20 **canned food**
- 15 canned milk
- 16 canned fruit (cans of fruit)
- 17 canned vegetables
- 18 fruit juice
- 19 sardines in oil, a can of fish
- 20 canned meat (cans of meat)
- 21 margarine

- 22 butter
- 23 coconut oil, a vegetable oil
- 24 oil; *kinds*: salad oil, olive oil, sunflower oil, wheatgerm oil, ground-nut oil
- 25 vinegar
- 26 stock cube
- 27 bouillon cube
- 28 mustard
- 29 gherkin (pickled gherkin)
- 30 soup seasoning
- 31 shop assistant (*Am. salesgirl*, saleslady)
- 32-34 **pastas**
- 32 spaghetti
- 33 macaroni
- 34 noodles
- 35-39 **cereal products**
- 35 pearl barley
- 36 semolina
- 37 rolled oats (porridge oats, oats)
- 38 rice
- 39 sago
- 40 salt
- 41 grocer (*Am. groceryman*), a shopkeeper (tradesman, retailer, *Am. storekeeper*)



- 42 papers
- 43 customer
- 44 receipt (sales check)
- 45 shopping bag
- 46-49 **wrapping material**
- 46 wrapping paper
- 47 adhesive tape
- 48 paper bag
- 49 cone-shaped paper bag
- 50 blancmange powder
- 51 whole-fruit jam (preserve)
- 52 jam
- 53-55 **sugar**
- 53 cube sugar
- 54 icing sugar (*Am. confectioner's sugar*)
- 55 refined sugar in crystals
- 56-59 **spirits**
- 56 whisky (whiskey)
- 57 rum
- 58 liqueur
- 59 brandy (cognac)
- 60-64 **wine in bottles** (bottled wine)
- 60 white wine
- 61 Chianti
- 62 vermouth
- 63 sparkling wine

- 64 red wine
- 65-68 **tea, coffee, etc.**
- 65 coffee (pure coffee)
- 66 cocoa
- 67 coffee
- 68 tea bag
- 69 electric coffee grinder
- 70 coffee roaster
- 71 roasting drum
- 72 sample scoop
- 73 price list
- 74 freezer
- 75-86 **confectionery** (*Am. candies*)
- 75 sweet (*Am. candy*)
- 76 drops
- 77 toffees
- 78 bar of chocolate
- 79 chocolate box
- 80 chocolate, a sweet
- 81 nougat
- 82 marzipan
- 83 chocolate liqueur
- 84 Turkish delight
- 85 croquant
- 86 truffle
- 87 soda water

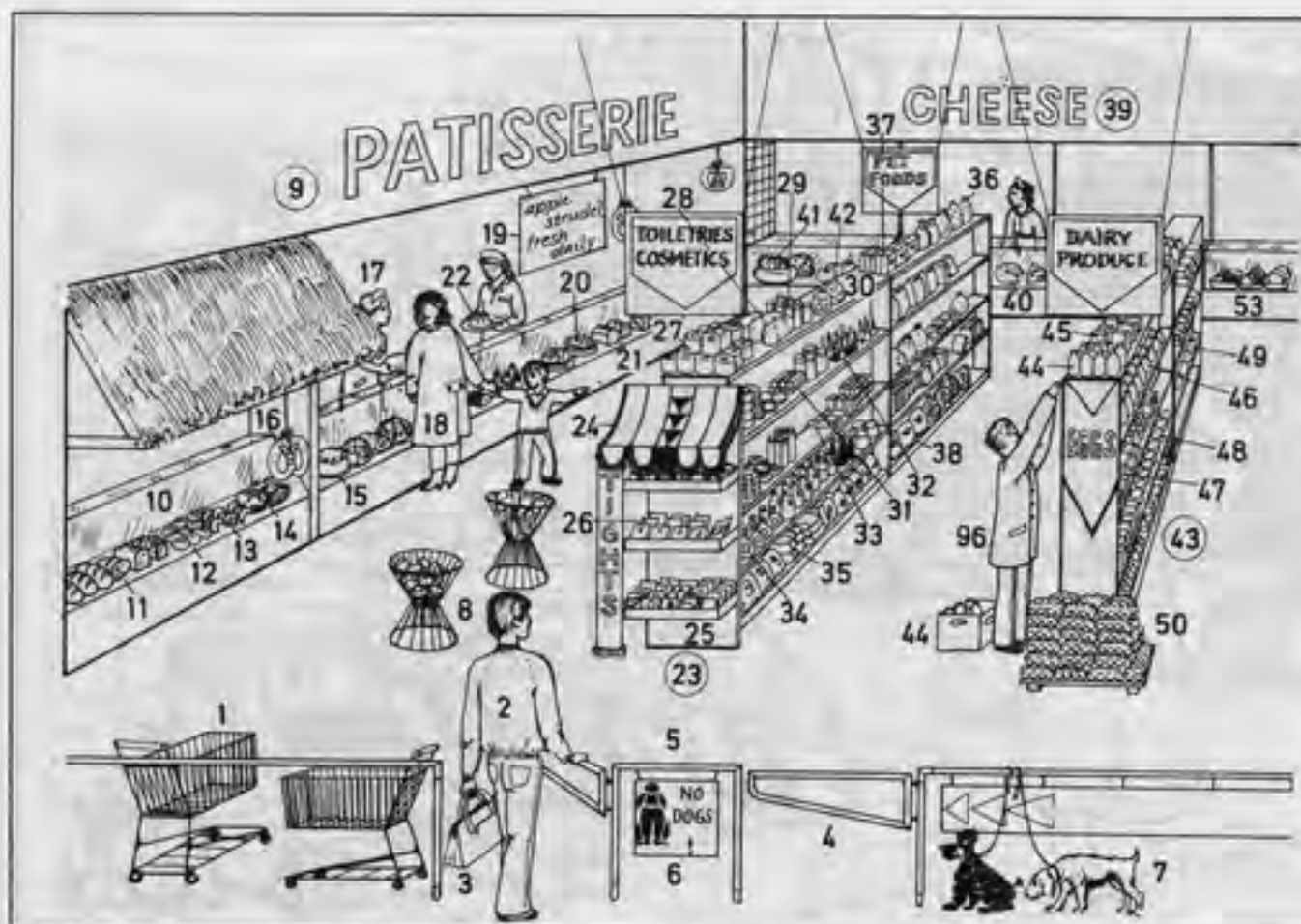

1-96 supermarket, a self-service

- food store
- 1 shopping trolley
- 2 customer
- 3 shopping bag
- 4 entrance to the sales area
- 5 barrier
- 6 sign (notice) banning dogs
- 7 dogs tied by their leads
- 8 basket
- 9 **bread and cake counter** (bread counter, cake counter)
- 10 display counter for bread and cakes
- 11 kinds of bread (breads)
- 12 rolls
- 13 croissants (crescent rolls, *Am.* crescents)
- 14 round loaf
- 15 gateau
- 16 pretzel [made with yeast dough]
- 17 shop assistant (*Am.* salesgirl, saleslady)
- 18 customer
- 19 sign listing goods
- 20 fruit flan
- 21 slab cake
- 22 ring cake
- 23 **cosmetics gondola**, a gondola (sales shelves)
- 24 canopy
- 25 hosiery shelf
- 26 stockings (nylons)
- 27-35 **toiletries** (cosmetics)
- 27 jar of cream (*kinds*: moisturising cream, day cream, night-care cream, hand cream)
- 28 packet of cotton wool
- 29 talcum powder
- 30 packet of cotton wool balls
- 31 toothpaste
- 32 nail varnish (nail polish)
- 33 shaving cream
- 34 bath salts
- 35 sanitary articles
- 36-37 pet foods
- 36 complete dog food
- 37 packet of dog biscuits
- 38 bag of cat litter
- 39 **cheese counter**
- 40 whole cheese
- 41 Swiss cheese (Emmental cheese) with holes
- 42 Edam cheese, a round cheese
- 43 gondola for dairy products
- 44 long-life milk; *also*: pasteurized milk, homogenized milk
- 45 plastic milk bag
- 46 cream

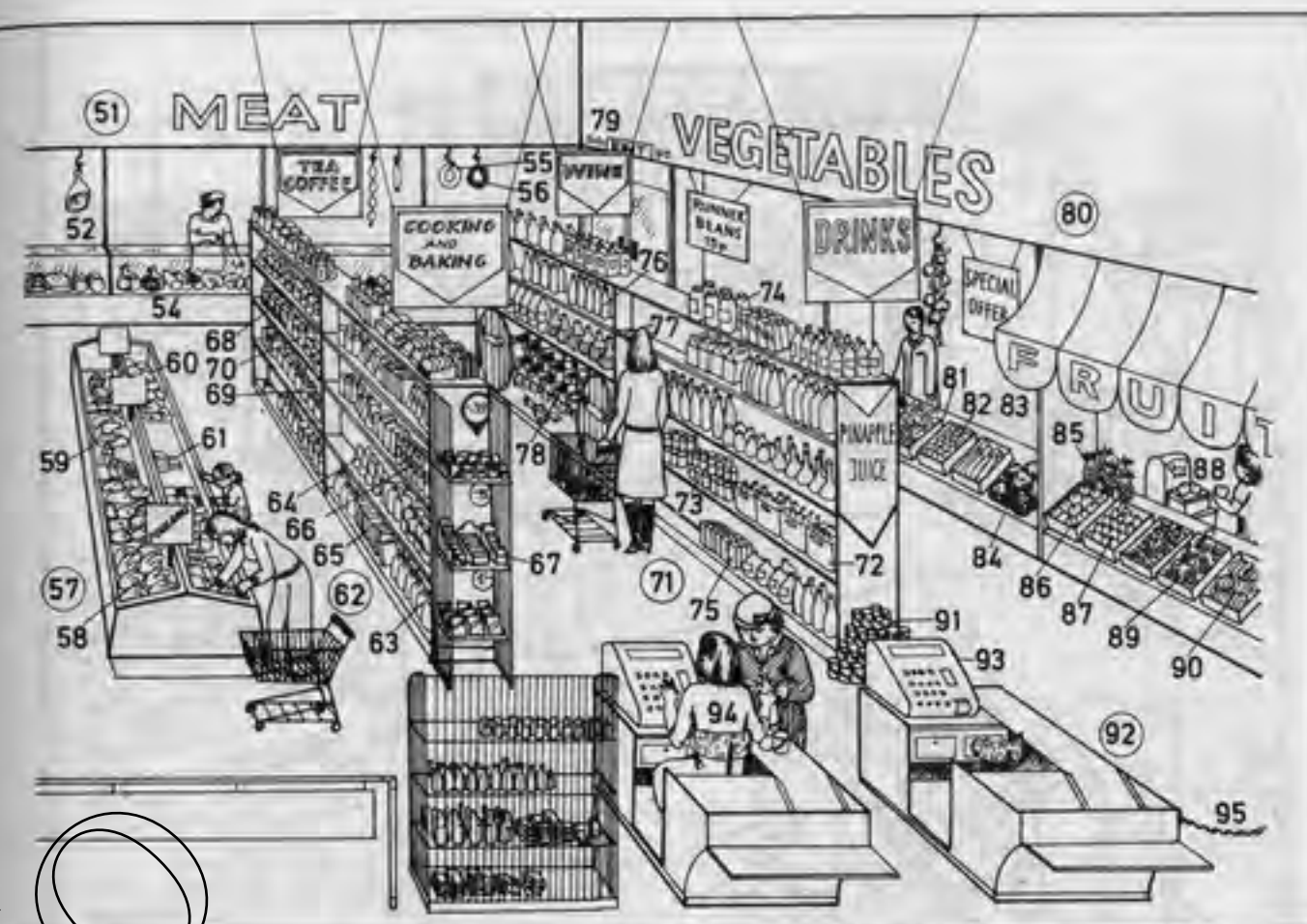

- 47 butter
- 48 margarine
- 49 box of cheeses
- 50 box of eggs
- 51 **fresh meat counter** (meat counter)
- 52 ham on the bone
- 53 meat (meat products)
- 54 sausages
- 55 ring of pork sausage
- 56 ring of blood sausage
- 57 freezer
- 58-61 **frozen food**
- 58 poulard
- 59 turkey leg (drumstick)
- 60 boiling fowl
- 61 frozen vegetables
- 62 **gondola for baking ingredients and cereal products**
- 63 wheat flour
- 64 sugar loaf
- 65 packet of noodles
- 66 salad oil
- 67 packet of spice
- 68-70 **tea, coffee, etc.**
- 68 coffee
- 69 packet of tea
- 70 instant coffee

- 71 **drinks gondola**
- 72 soft drinks
- 73 can of beer (canned beer)
- 74 bottle of fruit juice (bottled fruit juice)
- 75 can of fruit juice (canned fruit juice)
- 76 bottle of wine
- 77 bottle of Chianti
- 78 bottle of champagne
- 79 emergency exit
- 80 **fruit and vegetable counter**
- 81 vegetable basket
- 82 tomatoes
- 83 cucumbers
- 84 cauliflower
- 85 pineapple
- 86 apples
- 87 pears
- 88 scales for weighing fruit
- 89 grapes (bunches of grapes)
- 90 bananas
- 91 can
- 92 **checkout**
- 93 cash register
- 94 cashier
- 95 chain

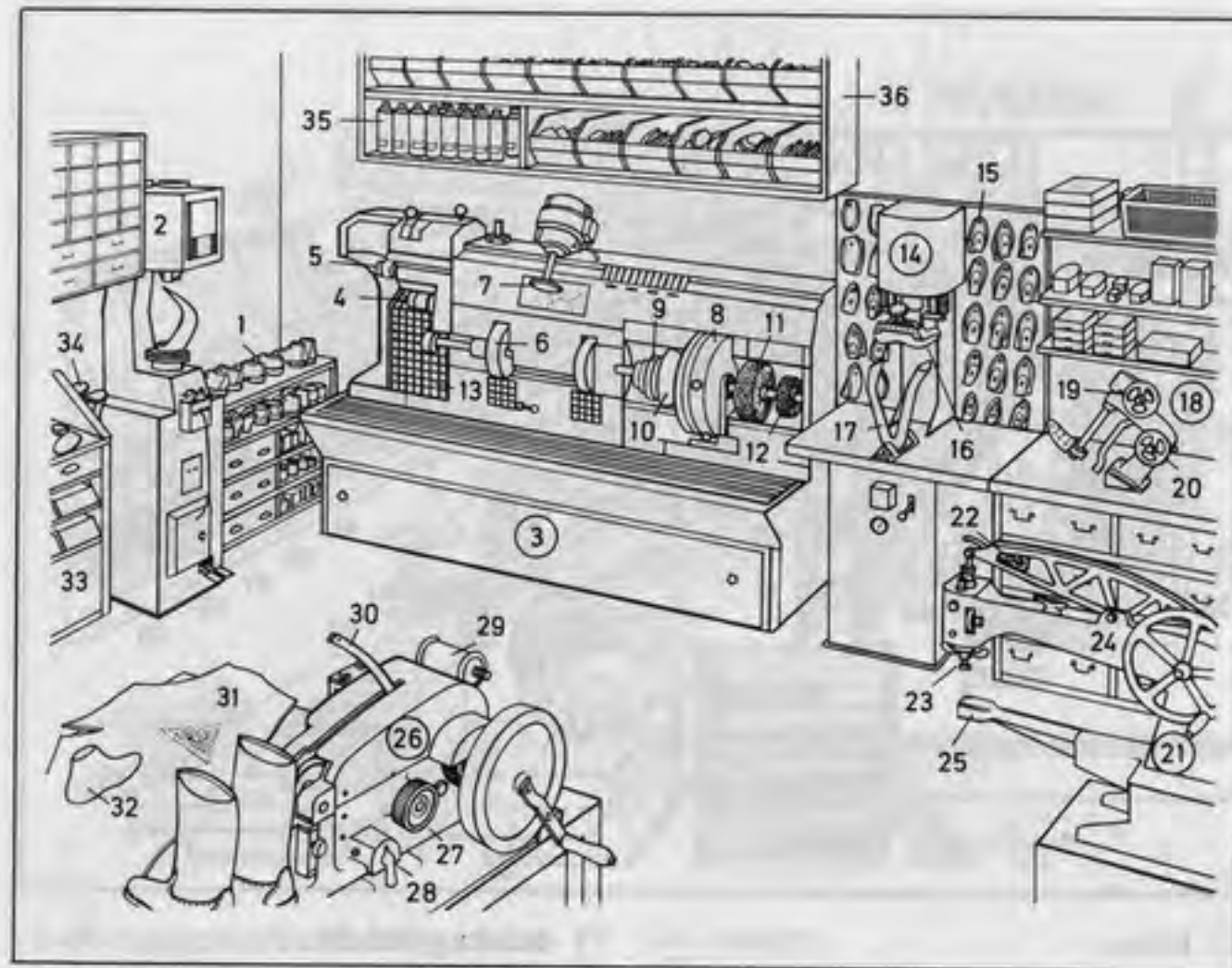

- 1-68 shoemaker's workshop (bootmaker's workshop)
 1 finished (repaired) shoes
 2 auto-soling machine
 3 finishing machine
 4 heel trimmer
 5 sole trimmer
 6 scouring wheel
 7 naum keag
 8 drive unit (drive wheel)
 9 iron
 10 buffing wheel
 11 polishing brush
 12 horsehair brush
 13 extractor grid
 14 automatic sole press
 15 press attachment
 16 pad
 17 press bar
 18 stretching machine
 19 width adjustment
 20 length adjustment
 21 stitching machine
 22 power regulator (power control)
 23 foot

- 24 handwheel
 25 arm
 26 sole stitcher (sole-stitching machine)
 27 foot bar lever
 28 feed adjustment (feed setting)
 29 bobbin (cotton bobbin)
 30 thread guide (yarn guide)
 31 sole leather
 32 [wooden] last
 33 workbench
 34 last
 35 dye spray
 36 shelves for materials

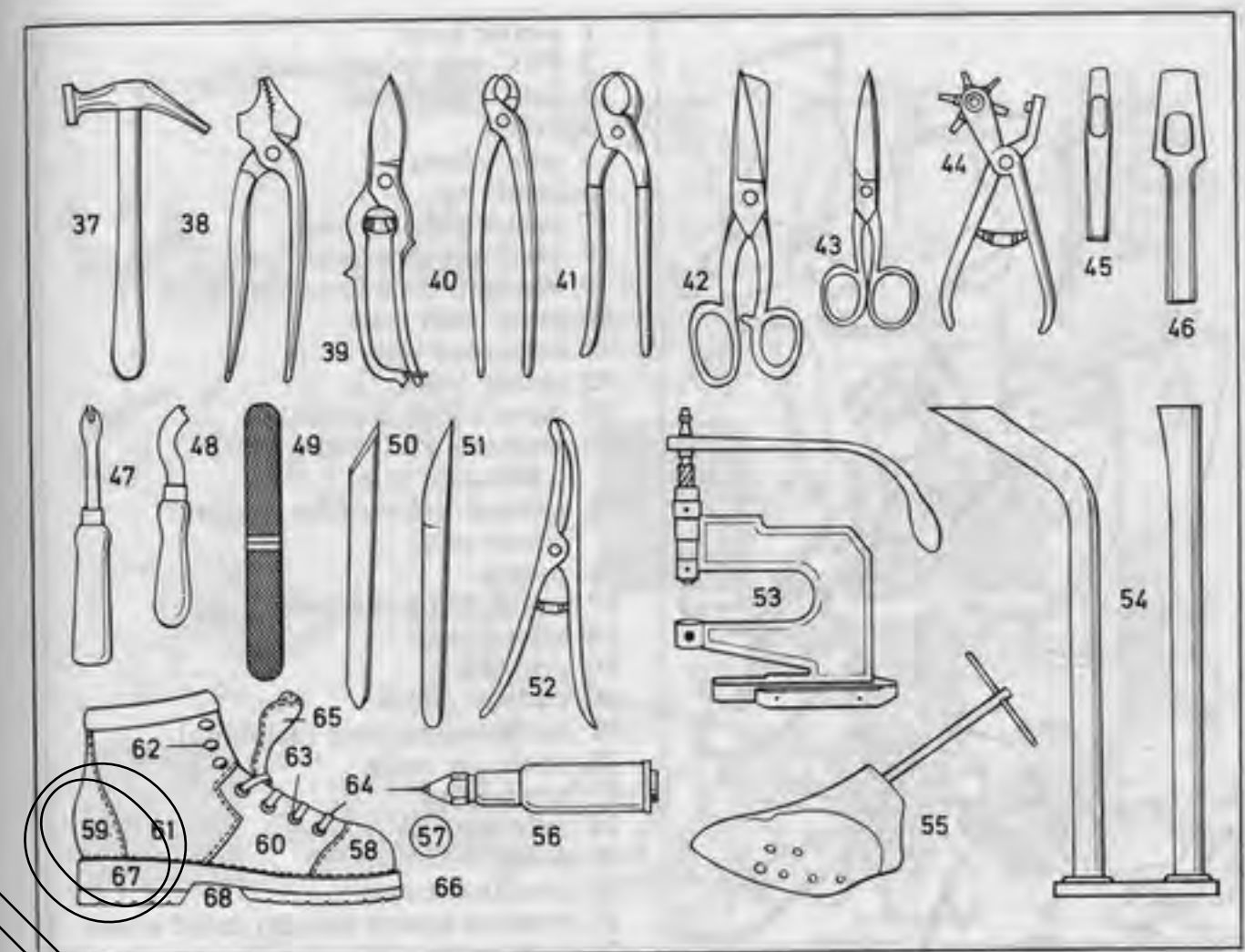

- 37 shoemaker's hammer
 38 shoemaker's pliers (welt pincers)
 39 sole-leather shears
 40 small pincers (nippers)
 41 large pincers (nippers)
 42 upper-leather shears
 43 scissors
 44 revolving punch (rotary punch)
 45 punch
 46 punch with handle
 47 nail puller
 48 welt cutter
 49 shoemaker's rasp
 50 cobbler's knife (shoemaker's knife)
 51 skiving knife (skife knife, paring knife)
 52 toecap remover
 53 eyelet, hook, and press-stud setter
 54 stand with iron lasts
 55 width-setting tree
 56 nail grip
 57 boot
 58 toecap
- 59 counter
 60 vamp
 61 quarter
 62 hook
 63 eyelet
 64 lace (shoelace, bootlace)
 65 tongue
 66 sole
 67 heel
 68 shank (waist)



- 1 winter boot
- 2 PVC sole (plastic sole)
- 3 high-pile lining
- 4 nylon
- 5 men's boot
- 6 inside zip
- 7 men's high leg boot
- 8 platform sole (platform)
- 9 Western boot (cowboy boot)
- 10 pony-skin boot
- 11 cemented sole
- 12 ladies' boot
- 13 mens's high leg boot
- 14 seamless PVC waterproof wellington boot
- 15 natural-colour (*Am.* natural-color) sole
- 16 toecap
- 17 tricot lining (knitwear lining)
- 18 hiking boot
- 19 grip sole
- 20 padded collar
- 21 tie fastening (lace fastening)
- 22 open-toe mule
- 23 terry upper
- 24 polo outsole
- 25 mule
- 26 corduroy upper
- 27 evening sandal (sandal court shoe)
- 28 high heel (stiletto heel)
- 29 court shoe (*Am.* pump)
- 30 moccasin
- 31 shoe, a tie shoe (laced shoe, Oxford shoe, *Am.* Oxford)
- 32 tongue
- 33 high-heeled shoe (shoe with raised heel)
- 34 casual
- 35 trainer (training shoe)
- 36 tennis shoe
- 37 counter (stiffening)
- 38 natural-colour (*Am.* natural-color) rubber sole
- 39 heavy-duty boot (*Am.* stogy, stogie)
- 40 toecap
- 41 slipper
- 42 woollen (*Am.* woolen) slip sock
- 43 knit stitch (knit)
- 44 clog
- 45 wooden sole
- 46 soft-leather upper
- 47 sabot
- 48 toe post sandal
- 49 ladies' sandal
- 50 surgical footbed (sock)
- 51 sandal
- 52 shoe buckle (buckle)
- 53 sling-back court shoe (*Am.* sling pump)
- 54 fabric court shoe
- 55 wedge heel
- 56 baby's first walking boot

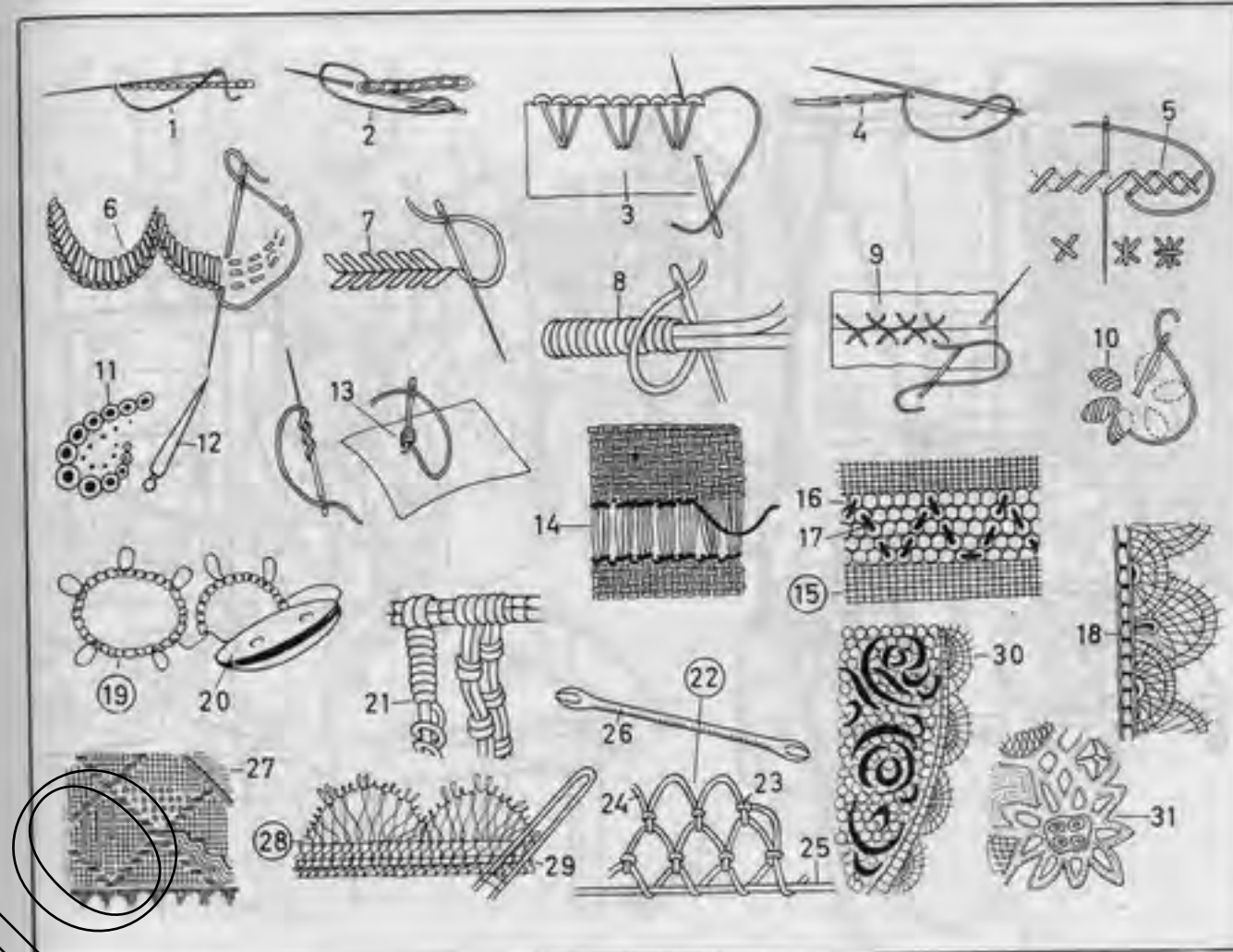

- 1 backstitch seam
- 2 chain stitch
- 3 ornamental stitch
- 4 stem stitch
- 5 cross stitch
- 6 buttonhole stitch (button stitch)
- 7 fishbone stitch
- 8 overcast stitch
- 9 herringbone stitch (Russian stitch, Russian cross stitch)
- 10 satin stitch (flat stitch)
- 11 eyelet embroidery (broderie anglaise)
- 12 stiletto
- 13 French knot (French dot, knotted stitch, twisted knot stitch)
- 14 hem stitch work
- 15 tulle work (tulle lace)
- 16 tulle background (net background)
- 17 darning stitch
- 18 pillow lace (bobbin lace, bone lace); *kinds:* Valenciennes, Brussels lace
- 19 tatting
- 20 tatting shuttle (shuttle)
- 21 knotted work (macramé)
- 22 filet (netting)
- 23 netting loop
- 24 netting thread
- 25 mesh pin (mesh gauge)
- 26 netting needle
- 27 open work
- 28 gimping (hairpin work)
- 29 gimping needle (hairpin)
- 30 needlepoint lace (point lace, needlepoint); *kinds:* reticella lace, Venetian lace, Alençon lace; *sim.* with metal thread: filigree work
- 31 braid embroidery (braid work)

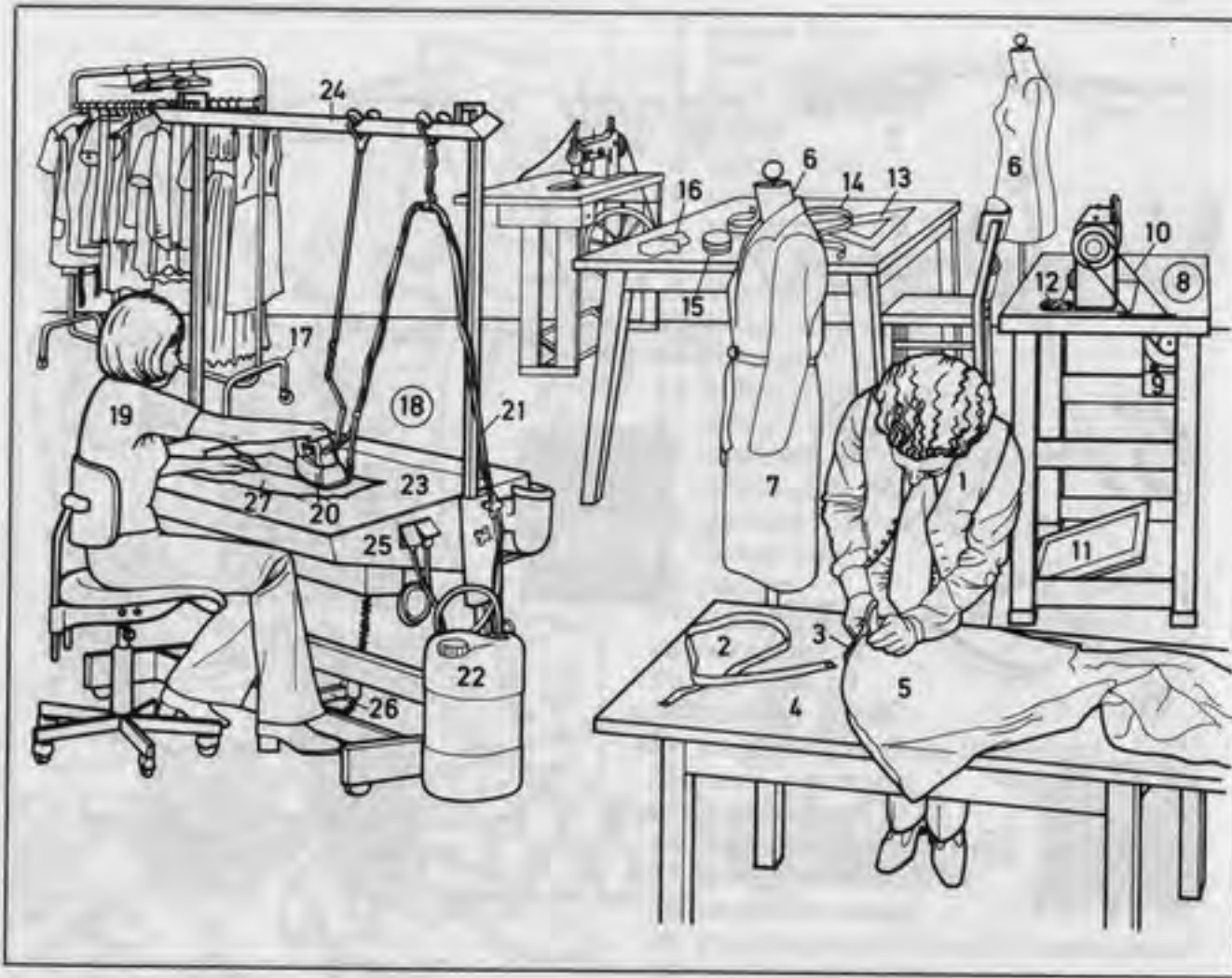
**1-27 dressmaker's workroom**

- 1 dressmaker
- 2 tape measure (measuring tape), a metre (*Am.* meter) tape measure
- 3 cutting shears
- 4 cutting table
- 5 model dress
- 6 dressmaker's model (dressmaker's dummy, dress form)
- 7 model coat
- 8 sewing machine
- 9 drive motor
- 10 drive belt
- 11 treadle
- 12 sewing machine cotton (sewing machine thread) [on bobbin]
- 13 cutting template
- 14 seam binding
- 15 button box
- 16 remnant
- 17 movable clothes rack
- 18 hand-iron press
- 19 presser (ironer)
- 20 steam iron

- 21 water feed pipe
- 22 water container
- 23 adjustable-tilt ironing surface
- 24 lift device for the iron
- 25 steam extractor
- 26 foot switch controlling steam extraction
- 27 pressed non-woven woollen (*Am.* woolen) fabric

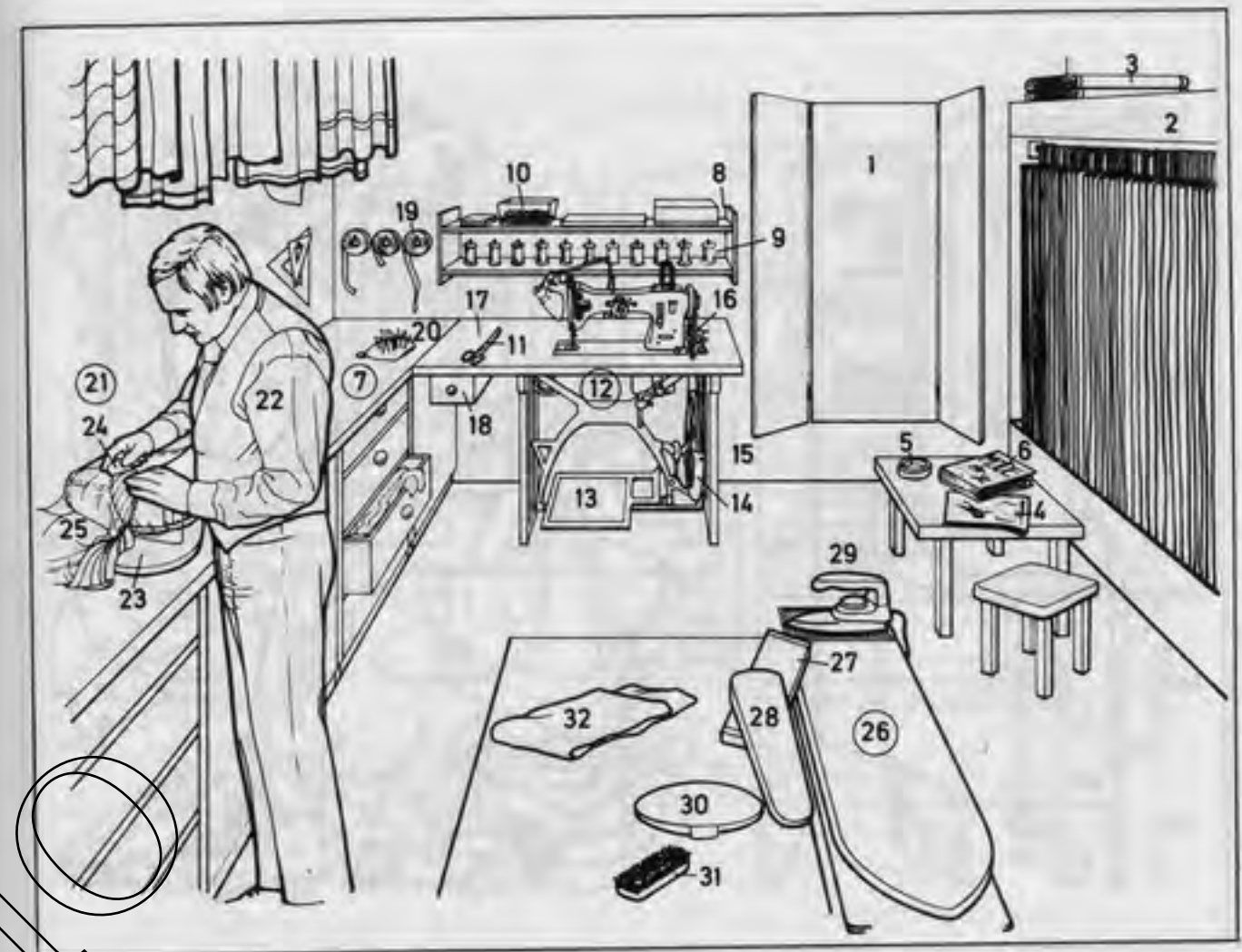
**1-32 tailor's workroom**

- 1 triple mirror
- 2 lengths of material
- 3 suiting
- 4 fashion journal (fashion magazine)
- 5 ashtray
- 6 fashion catalogue
- 7 workbench
- 8 wall shelves (wall shelf unit)
- 9 cotton reel
- 10 small reels of sewing silk
- 11 hand shears
- 12 combined electric and treadle sewing machine
- 13 treadle
- 14 dress guard
- 15 band wheel
- 16 bobbin thread
- 17 sewing machine table
- 18 sewing machine drawer
- 19 seam binding
- 20 pincushion
- 21 marking out
- 22 tailor

- 23 shaping pad
- 24 tailor's chalk (French chalk)
- 25 workpiece
- 26 steam press (steam pressing unit)
- 27 swivel arm
- 28 pressing cushion (pressing pad)
- 29 iron
- 30 hand-ironing pad
- 31 clothes brush
- 32 pressing cloth

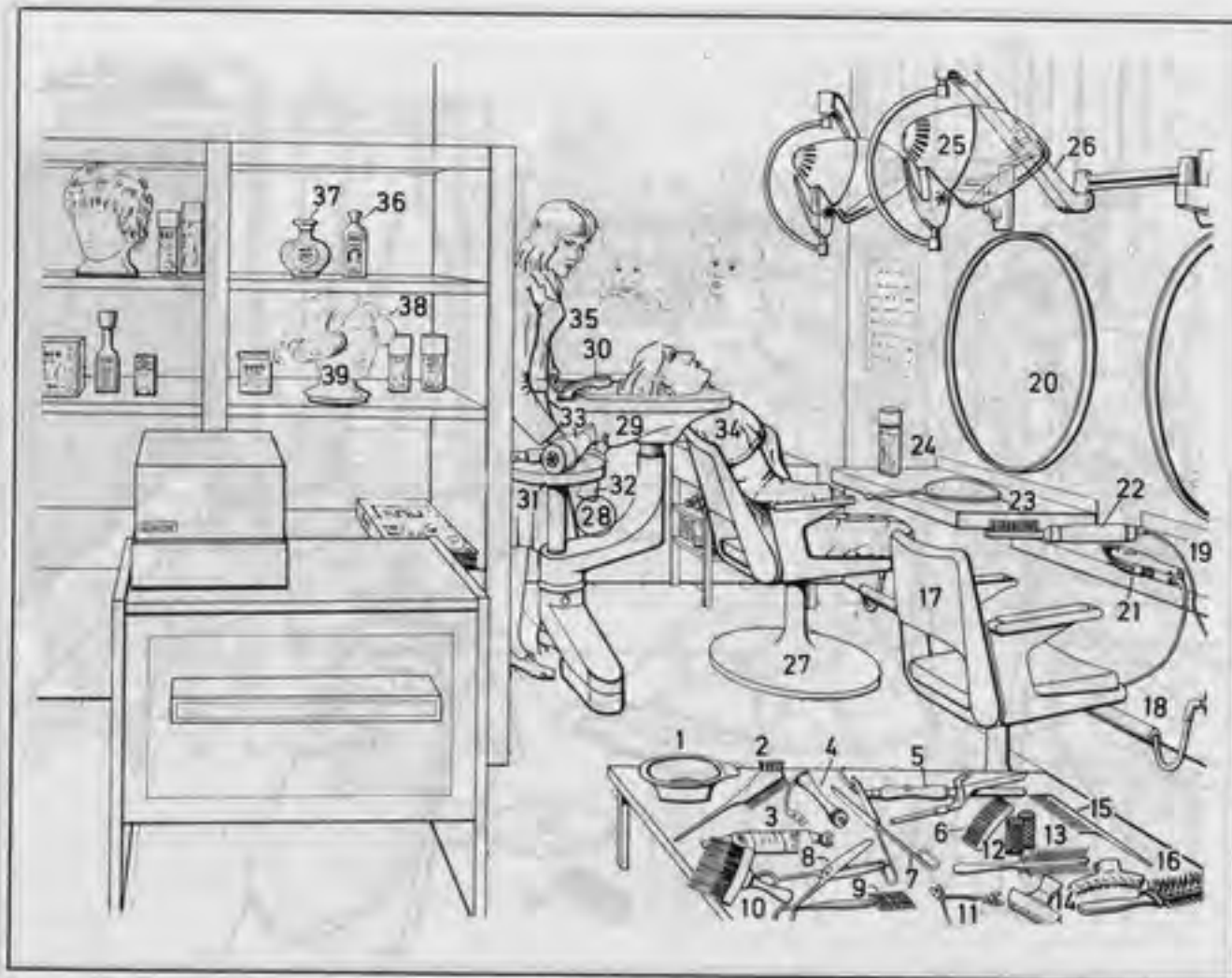

1-39 ladies' hairdressing salon and beauty salon (*Am.* beauty parlor, beauty shop)

1-16 hairdresser's tools

- 1 bowl containing bleach
- 2 detangling brush
- 3 bleach tube
- 4 curler [used in dyeing]
- 5 curling tongs (curling iron)
- 6 comb (back comb, side comb)
- 7 haircutting scissors
- 8 thinning scissors (*Am.* thinning shears)
- 9 thinning razor
- 10 hairbrush
- 11 hair clip
- 12 roller
- 13 curl brush
- 14 curl clip
- 15 dressing comb
- 16 stiff-bristle brush
- 17 adjustable hairdresser's chair
- 18 footrest
- 19 dressing table
- 20 salon mirror (mirror)
- 21 electric clippers

- 22 warm-air comb
- 23 hand mirror (hand glass)
- 24 hair spray (hair-fixing spray)
- 25 drier, a swivel-mounted drier
- 26 swivel arm of the drier
- 27 round base
- 28 shampoo unit
- 29 shampoo basin
- 30 hand spray (shampoo spray)
- 31 service tray
- 32 shampoo bottle
- 33 hair drier (hand hair drier, hand-held hair drier)
- 34 cape (gown)
- 35 hairdresser
- 36 perfume bottle
- 37 bottle of toilet water
- 38 wig
- 39 wig block



- 1-42 men's salon** (men's hairdressing salon, barber's shop, *Am.* barbershop)
- 1 hairdresser (barber)
 - 2 overalls (hairdresser's overalls)
 - 3 hairstyle (haircut)
 - 4 cape (gown)
 - 5 paper towel
 - 6 salon mirror (mirror)
 - 7 hand mirror (hand glass)
 - 8 light
 - 9 toilet water
 - 10 hair tonic
 - 11 shampoo unit
 - 12 shampoo basin
 - 13 hand spray (shampoo spray)
 - 14 mixer tap (*Am.* mixing faucet)
 - 15 sockets, e.g. for hair drier
 - 16 adjustable hairdresser's chair (barber's chair)
 - 17 height-adjuster bar (height adjuster)
 - 18 armrest
 - 19 footrest
 - 20 shampoo
 - 21 perfume spray

- 22 hair drier (hand hair drier, hand-held hair drier)
- 23 setting lotion in a spray can
- 24 hand towels for drying hair
- 25 towels for face compresses
- 26 crimping iron
- 27 neck brush
- 28 dressing comb
- 29 warm-air comb
- 30 warm-air brush
- 31 curling tongs (hair curler, curling iron)
- 32 electric clippers
- 33 thinning scissors (*Am.* thinning shears)
- 34 haircutting scissors; *sim.*: styling scissors
- 35 scissor-blade
- 36 pivot
- 37 handle
- 38 open razor (straight razor)
- 39 razor handle
- 40 edge (cutting edge, razor's edge, razor's cutting edge)
- 41 thinning razor
- 42 diploma

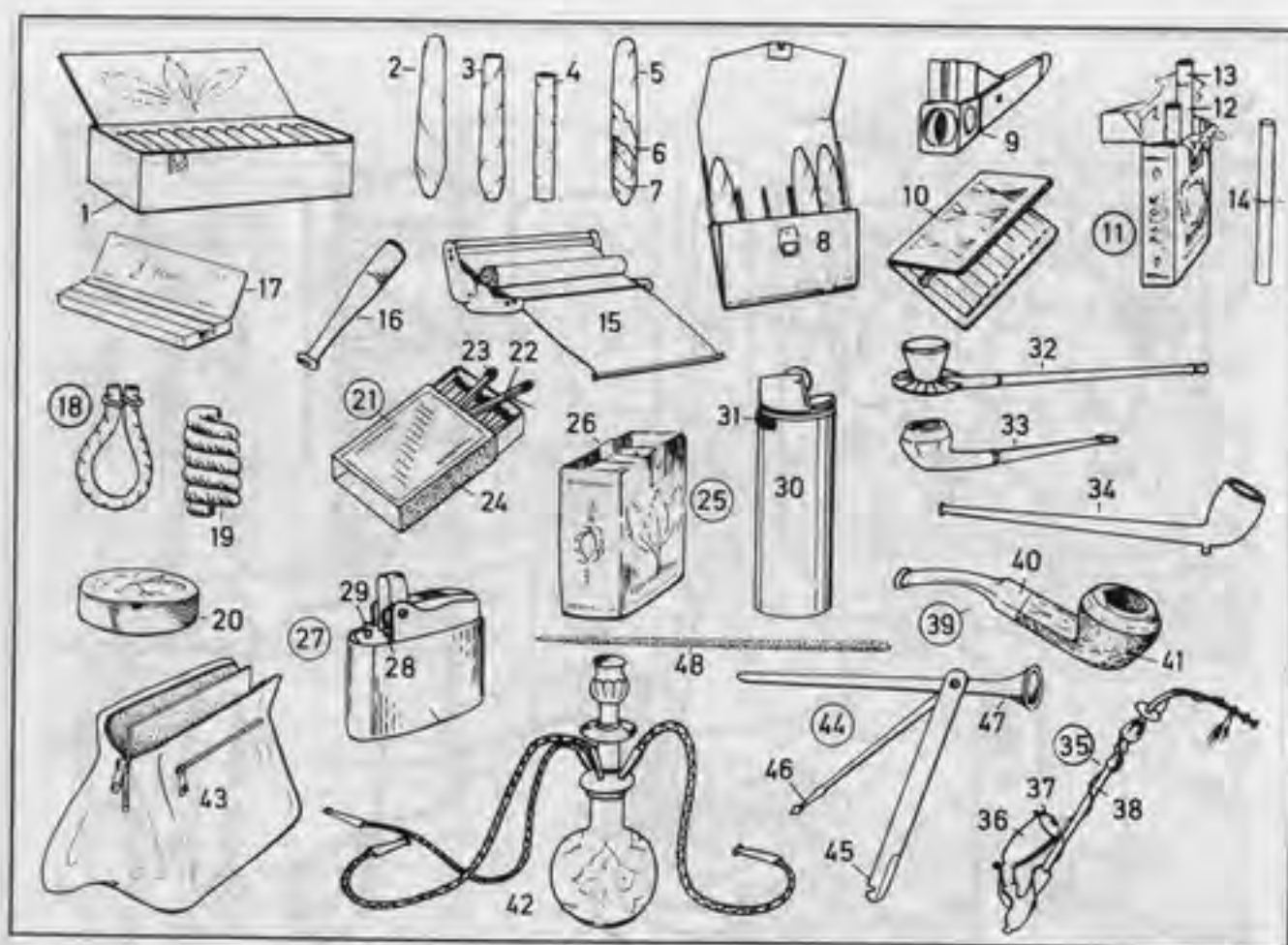

- 1 cigar box
- 2 cigar; *kinds*: Havana cigar (Havana), Brazilian cigar, Sumatra cigar
- 3 cigarillo
- 4 cheroot
- 5 wrapper
- 6 binder
- 7 filler
- 8 cigar case
- 9 cigar cutter
- 10 cigarette case
- 11 cigarette packet (*Am. pack*)
- 12 cigarette, a filter-tipped cigarette
- 13 cigarette tip; *kinds*: cork tip, gold tip
- 14 Russian cigarette
- 15 cigarette roller
- 16 cigarette holder
- 17 packet of cigarette papers
- 18 pigtail (twist of tobacco)
- 19 chewing tobacco; *a piece*: plug (quid, chew)
- 20 snuff box, containing snuff
- 21 matchbox
- 22 match
- 23 head (match head)
- 24 striking surface
- 25 packet of tobacco; *kinds*: fine cut, shag, navy plug
- 26 revenue stamp
- 27 petrol cigarette lighter (petrol lighter)
- 28 flint
- 29 wick
- 30 gas cigarette lighter (gas lighter), a disposable lighter
- 31 flame regulator
- 32 chibonk (chibonque)
- 33 short pipe
- 34 clay pipe (Dutch pipe)
- 35 long pipe
- 36 pipe bowl (bowl)
- 37 bowl lid
- 38 pipe stem (stem)
- 39 briar pipe
- 40 mouthpiece
- 41 sand-blast finished or polished briar grain
- 42 hookah (narghile, narghileh), a water pipe
- 43 tobacco pouch
- 44 smoker's companion
- 45 pipe scraper
- 46 pipe cleaner
- 47 tobacco presser
- 48 pipe cleaner

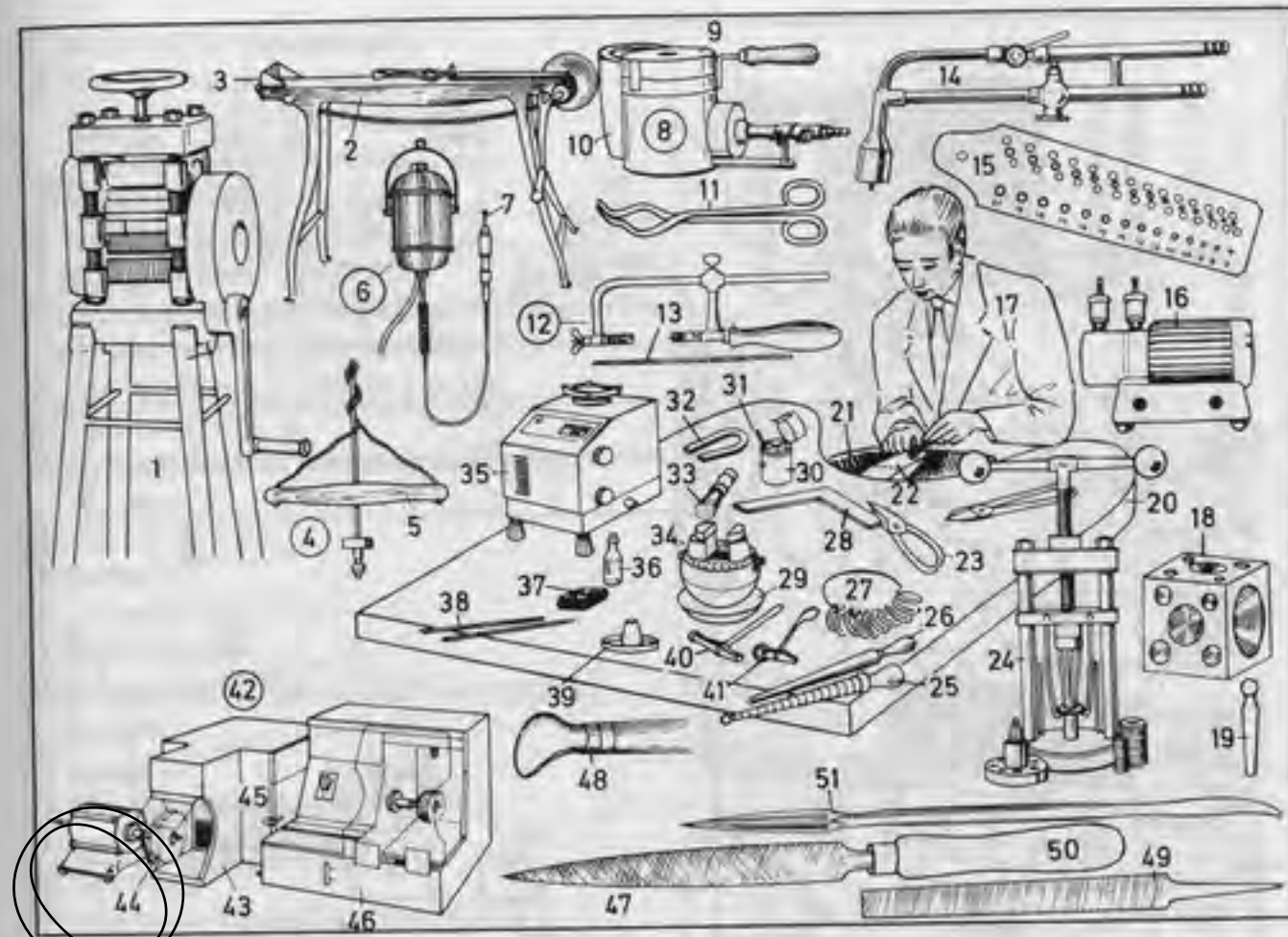

- 1 wire and sheet roller
- 2 drawbench (drawing bench)
- 3 wire (gold or silver wire)
- 4 archimedes drill (drill)
- 5 crossbar
- 6 suspended (pendant) electric drilling machine
- 7 spherical cutter (cherry)
- 8 melting pot
- 9 fireclay top
- 10 graphite crucible
- 11 crucible tongs
- 12 piercing saw (jig saw)
- 13 piercing saw blade
- 14 soldering gun
- 15 thread tapper
- 16 blast burner (blast lamp) for soldering
- 17 goldsmith
- 18 swage block
- 19 punch
- 20 workbench (bench)
- 21 bench apron
- 22 needle file
- 23 metal shears
- 24 wedding ring sizing machine
- 25 ring gauge (*Am. gage*)
- 26 ring-rounding tool
- 27 ring gauge (*Am. gage*)
- 28 steel set-square
- 29 leather pad
- 30 box of punches
- 31 punch
- 32 magnet
- 33 bench brush
- 34 engraving ball (joint vice, clamp)
- 35 gold and silver balance (assay balance), a precision balance
- 36 soldering flux (flux)
- 37 charcoal block
- 38 stick of solder
- 39 soldering borax
- 40 shaping hammer
- 41 chasing (enchasing) hammer
- 42 polishing and burnishing machine
- 43 dust exhaustor (vacuum cleaner)
- 44 polishing wheel
- 45 dust collector (dust catcher)
- 46 buffing machine
- 47 round file
- 48 bloodstone (haematite, hematite)
- 49 flat file
- 50 file handle
- 51 polishing iron (burnisher)

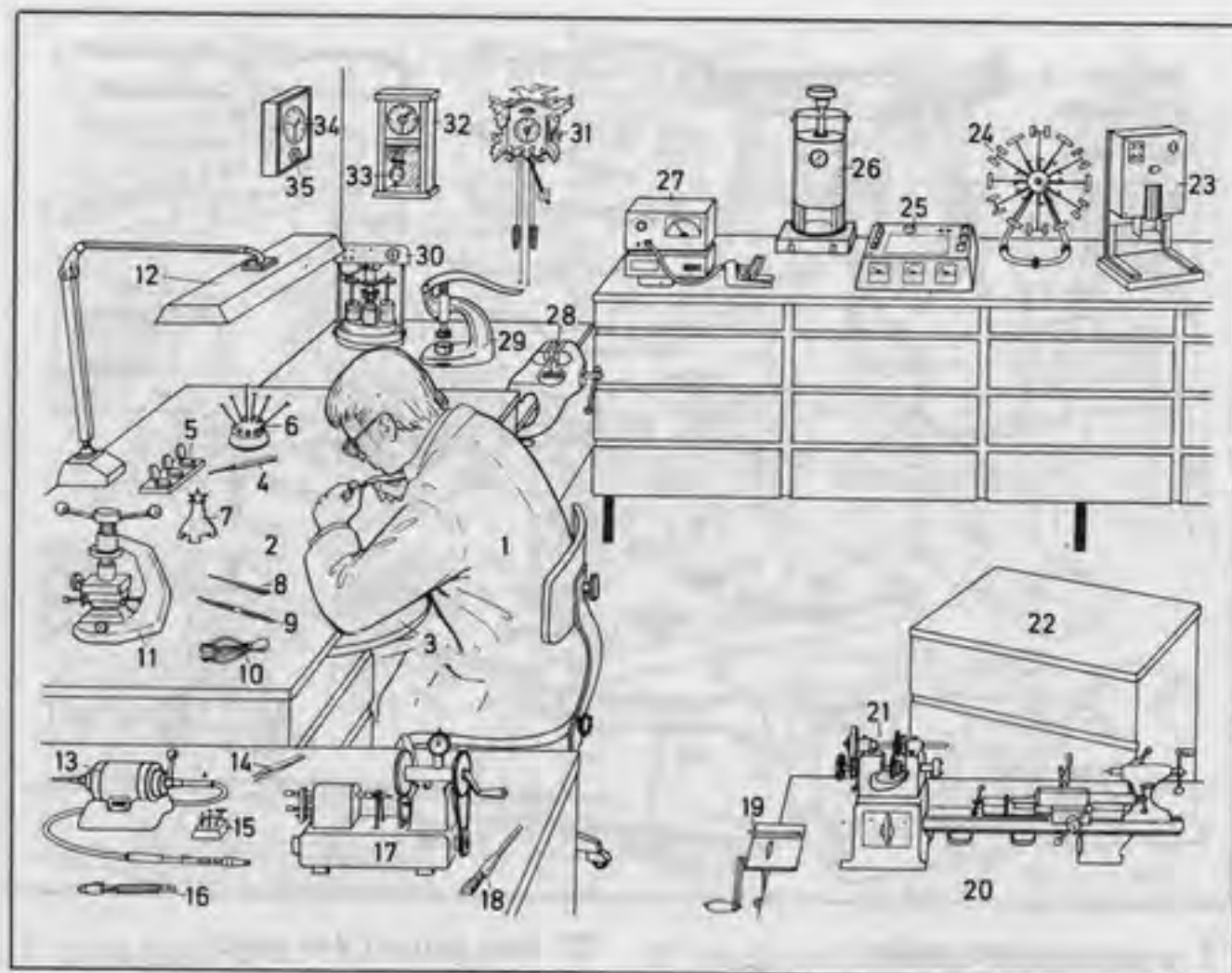

- 1 watchmaker; *also*: clockmaker
- 2 workbench
- 3 armrest
- 4 oiler
- 5 oil stand
- 6 set of screwdrivers
- 7 clockmaker's anvil
- 8 broach, a reamer
- 9 spring pin tool
- 10 hand-removing tool
- 11 watchglass-fitting tool
- 12 workbench lamp, a multi-purpose lamp
- 13 multi-purpose motor
- 14 tweezers
- 15 polishing machine attachments
- 16 pin vice (pin holder)
- 17 burnisher, for burnishing, polishing, and shortening of spindles
- 18 dust brush
- 19 cutter for metal watch straps
- 20 precision bench lathe (watchmaker's lathe)
- 21 drive-belt gear

- 22 workshop trolley for spare parts
- 23 ultrasonic cleaner
- 24 rotating watch-testing machine for automatic watches
- 25 watch-timing machine for electronic components
- 26 testing device for waterproof watches
- 27 electronic timing machine
- 28 vice (*Am.* vise)
- 29 watchglass-fitting tool for armoured (*Am.* armored) glasses
- 30 [automatic] cleaning machine for conventional cleaning
- 31 cuckoo clock (Black Forest clock)
- 32 wall clock (regulator)
- 33 compensation pendulum
- 34 kitchen clock
- 35 timer

- 1 electronic wristwatch
- 2 digital readout, a light-emitting diode (LED) readout; *also*: liquid crystal readout
- 3 hour and minute button
- 4 date and second button
- 5 strap (watch strap)
- 6 tuning fork principle (principle of the tuning fork watch)
- 7 power source (battery cell)
- 8 transformer
- 9 tuning fork element (oscillating element)
- 10 wheel ratchet
- 11 wheels
- 12 minute hand
- 13 hour hand
- 14 principle of the electronic quartz watch
- 15 quartz
- 16 integrated circuit
- 17 oscillation counter
- 18 decoder
- 19 calendar clock (alarm clock)
- 20 digital display with flip-over numerals
- 21 second indicator
- 22 stop button
- 23 forward and backward wind knob
- 24 grandfather clock
- 25 face
- 26 clock case
- 27 pendulum
- 28 striking weight
- 29 time weight
- 30 sundial
- 31 hourglass (egg timer)
- 32-43 **components of an automatic watch** (automatic wristwatch)
- 32 weight (rotor)
- 33 stone (jewel, jewelled bearing), a synthetic ruby
- 34 click
- 35 click wheel
- 36 clockwork (clockwork mechanism)
- 37 bottom train plate
- 38 spring barrel
- 39 balance wheel
- 40 escape wheel
- 41 crown wheel
- 42 winding crown
- 43 drive mechanism

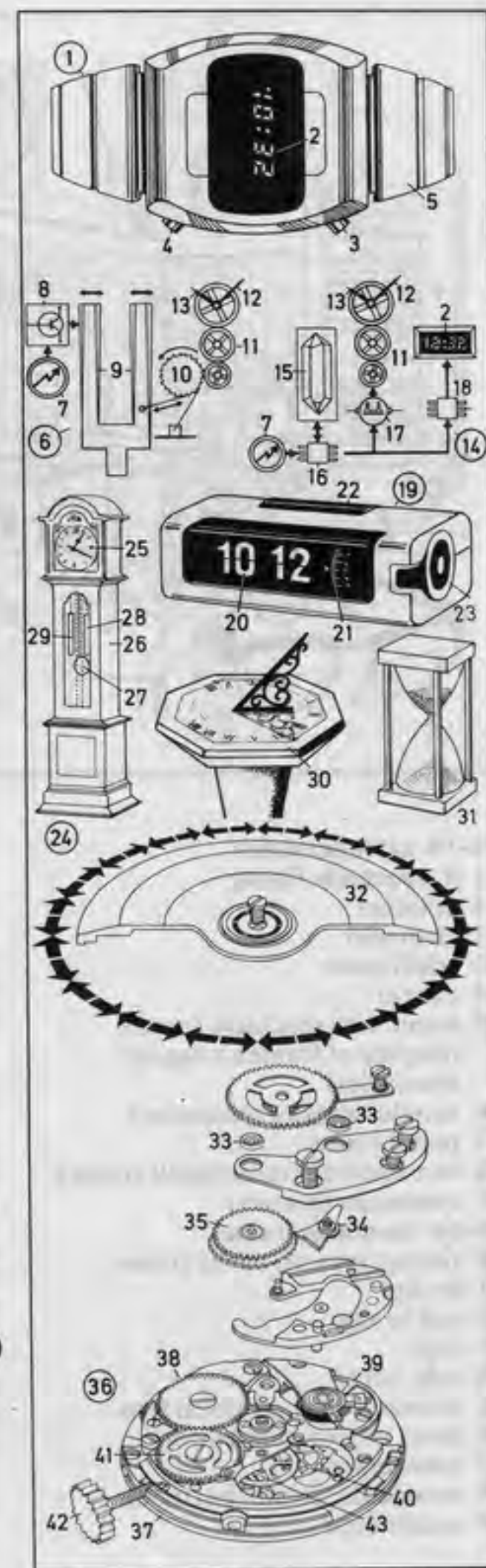

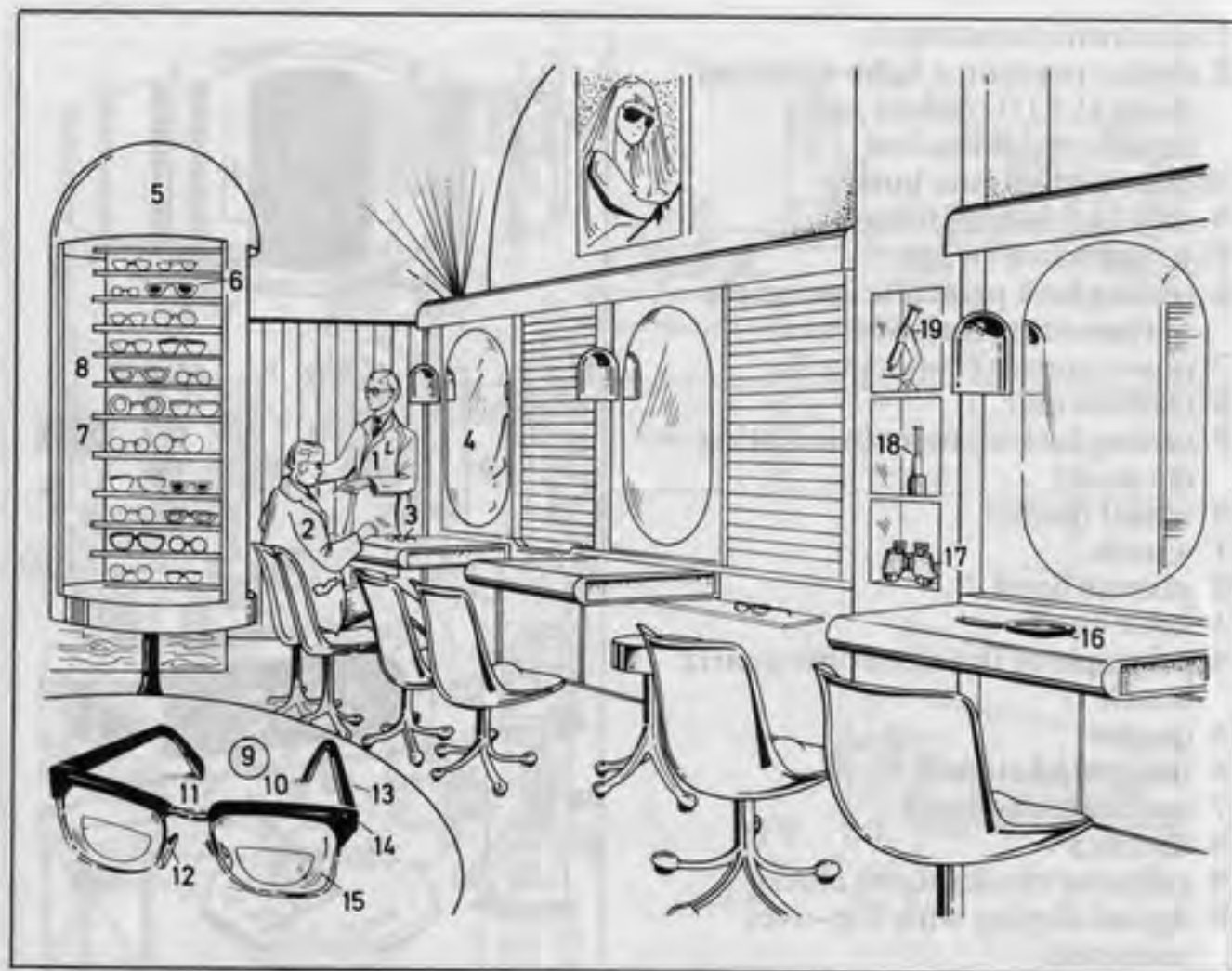
**1-19 sales premises****1-4 spectacle fitting**

- 1 optician
- 2 customer
- 3 trial frame
- 4 mirror
- 5 stand with spectacle frames (display of frames, range of spectacles)
- 6 sunglasses (sun spectacles)
- 7 metal frame
- 8 tortoiseshell frame (shell frame)
- 9 spectacles (glasses)

10-14 spectacle frame

- 10 fitting (mount) of the frame
- 11 bridge
- 12 pad bridge
- 13 side
- 14 side joint
- 15 spectacle lens, a bifocal lens

20-47 optician's workshop

- 20 workbench
- 21 universal centring (centering) apparatus
- 22 centring (centering) suction holder
- 23 sucker
- 24 edging machine
- 25 formers for the lens edging machine
- 26 inserted former
- 27 rotating printer
- 28 abrasive wheel combination
- 29 control unit
- 30 machine part
- 31 cooling water pipe
- 32 cleaning fluid
- 33 focimeter (vertex refractionometer)
- 34 metal-blocking device
- 35 abrasive wheel combination and forms of edging
- 36 roughing wheel for preliminary surfacing

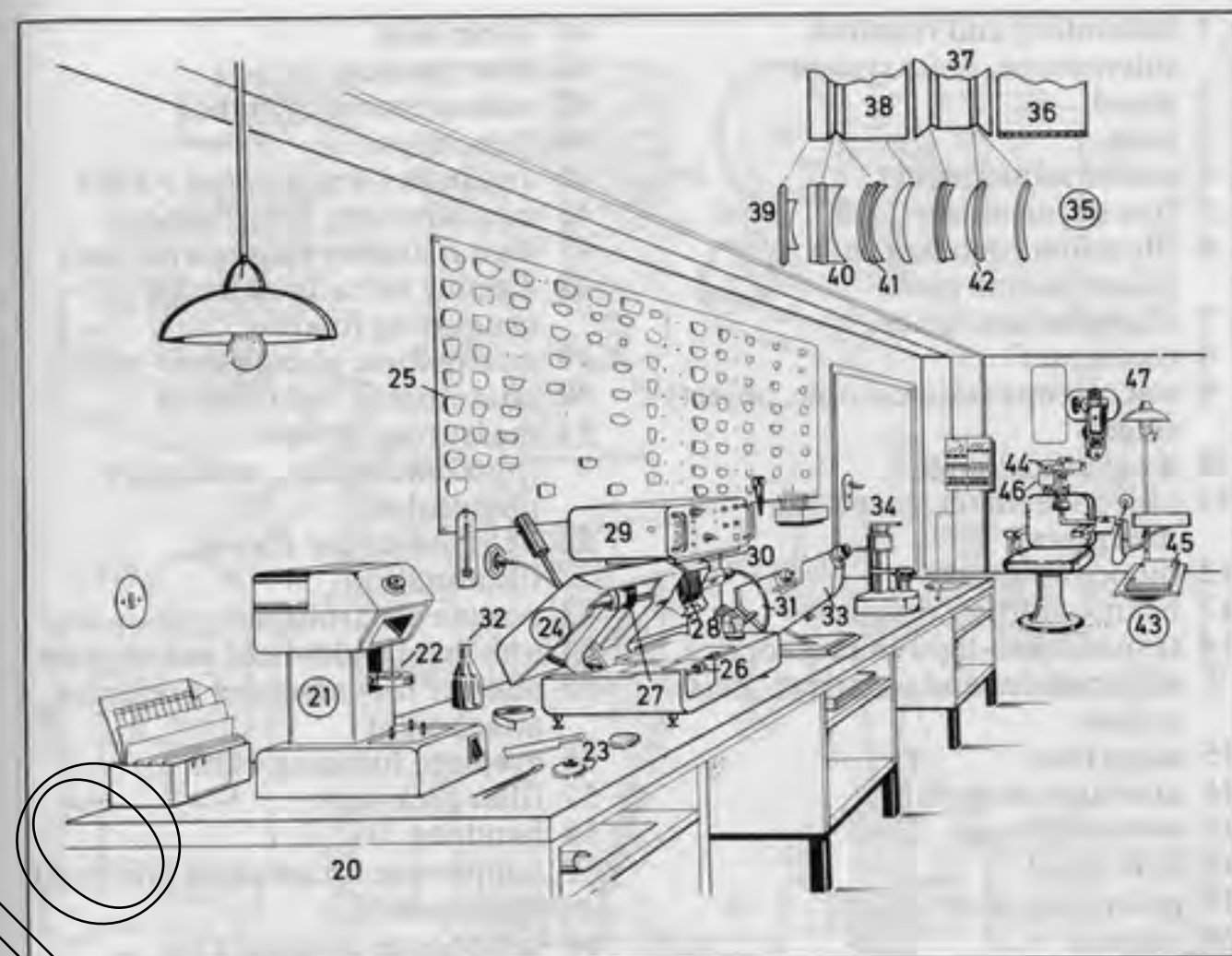

- 37 fining lap for positive and negative lens surfaces
- 38 fining lap for special and flat lenses
- 39 plano-concave lens with a flat surface
- 40 plano-concave lens with a special surface
- 41 concave and convex lens with a special surface
- 42 convex and concave lens with a special surface
- 43 ophthalmic test stand
- 44 phoropter with ophthalmometer and optometer (refractometer)
- 45 trial lens case
- 46 collimator
- 47 acuity projector

- 1 laboratory and research microscope, *Leitz system*
- 2 stand
- 3 base
- 4 coarse adjustment
- 5 fine adjustment
- 6 illumination beam path (illumination path)
- 7 illumination optics
- 8 condenser
- 9 microscope (microscopic, object) stage
- 10 mechanical stage
- 11 objective turret (revolving nosepiece)
- 12 binocular head
- 13 beam-splitting prisms
- 14 transmitted-light microscope with camera and polarizer, *Zeiss system*
- 15 stage base
- 16 aperture-stop slide
- 17 universal stage
- 18 lens panel
- 19 polarizing filter
- 20 camera
- 21 focusing screen
- 22 discussion tube arrangement
- 23 wide-field metallurgical microscope, a reflected-light microscope (microscope for reflected light)
- 24 matt screen (ground glass screen, projection screen)
- 25 large-format camera
- 26 miniature camera
- 27 base plate
- 28 lamphouse
- 29 mechanical stage
- 30 objective turret (revolving nosepiece)
- 31 surgical microscope
- 32 pillar stand
- 33 field illumination
- 34 photomicroscope
- 35 miniature film cassette
- 36 photomicrographic camera attachment for large-format or television camera
- 37 surface-finish microscope
- 38 light section tube
- 39 rack and pinion
- 40 zoom stereomicroscope
- 41 zoom lens
- 42 dust counter
- 43 measurement chamber
- 44 data output
- 45 analogue (*Am.* analog) output
- 46 measurement range selector
- 47 digital display (digital readout)
- 48 dipping refractometer for examining food
- 49 microscopic photometer
- 50 photometric light source
- 51 measuring device (photomultiplier, multiplier phototube)
- 52 light source for survey illumination
- 53 remote electronics
- 54 universal wide-field microscope
- 55 adapter for camera or projector attachment
- 56 eyepiece focusing knob
- 57 filter pick-up
- 58 handrest
- 59 lamphouse for incident (vertical) illumination
- 60 lamphouse connector for transillumination
- 61 wide-field stereomicroscope
- 62 interchangeable lenses (objectives)
- 63 incident (vertical) illumination (incident top lighting)
- 64 fully automatic microscope camera, a camera with photomicro mount adapter
- 65 film cassette
- 66 universal condenser for research microscope I
- 67 universal-type measuring machine for photogrammetry (phototheodolite)
- 68 photogrammetric camera
- 69 motor-driven level, a compensator level
- 70 electro-optical distance-measuring instrument
- 71 stereometric camera
- 72 horizontal base
- 73 one-second theodolite

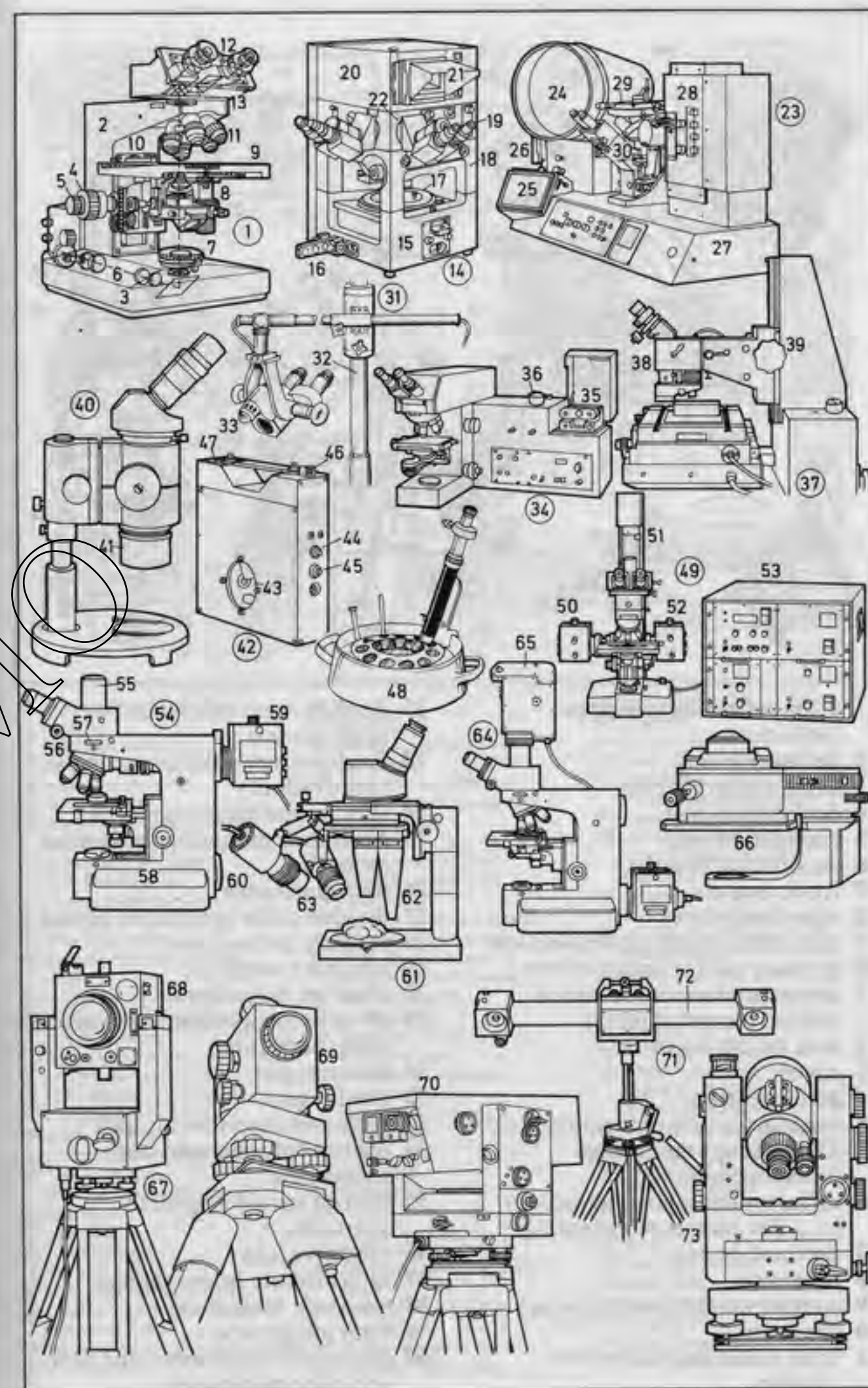

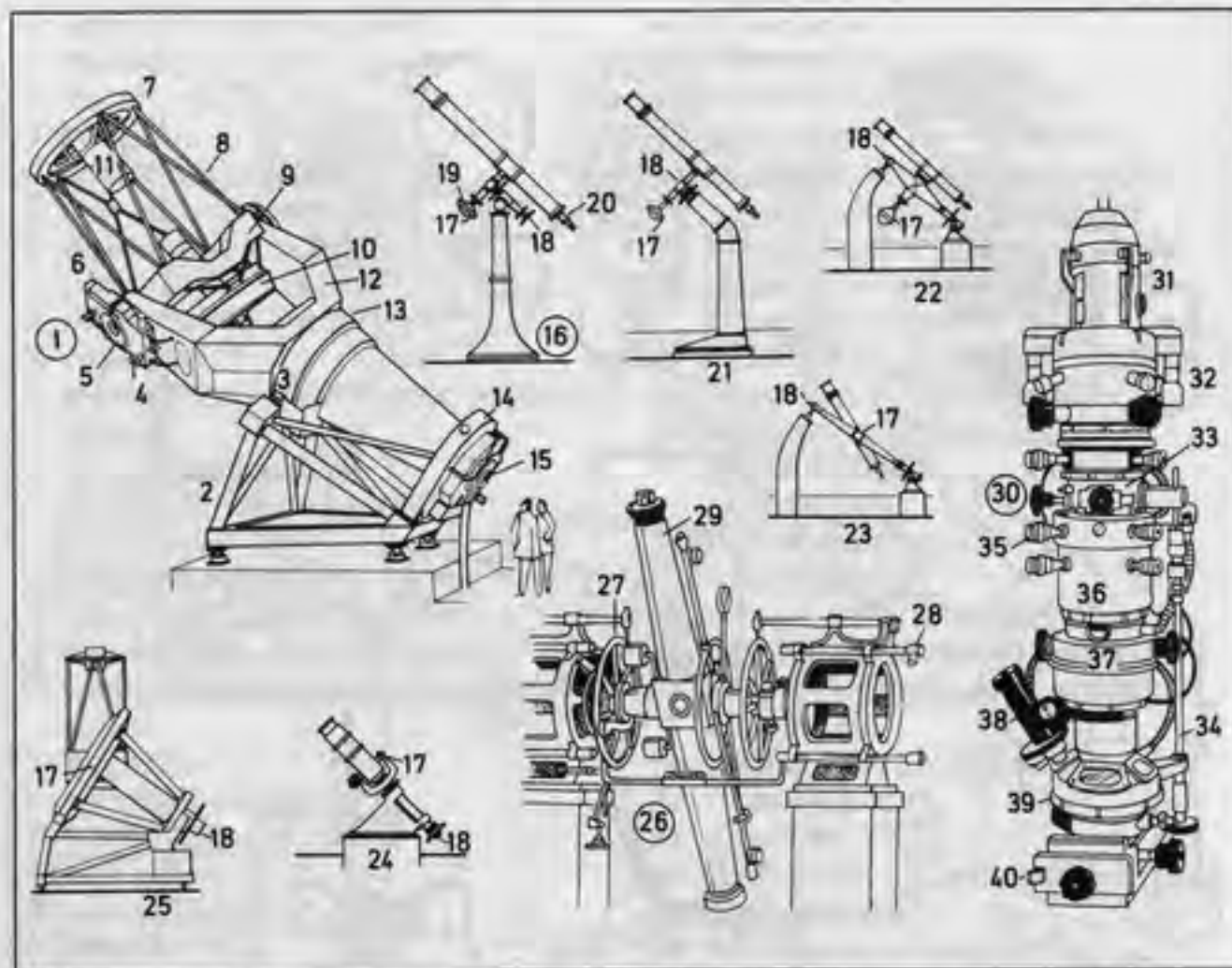

- 1 2.2 m reflecting telescope (reflector)
- 2 pedestal (base)
- 3 axial-radial bearing
- 4 declination gear
- 5 declination axis
- 6 declination bearing
- 7 front ring
- 8 tube (body tube)
- 9 tube centre (*Am.* center) section
- 10 primary mirror (main mirror)
- 11 secondary mirror (deviation mirror, corrector plate)
- 12 fork mounting (fork)
- 13 cover
- 14 guide bearing
- 15 main drive unit of the polar axis
- 16-25 telescope mountings (telescope mounts)
- 16 refractor (refracting telescope) on a German-type mounting
- 17 declination axis
- 18 polar axis
- 19 counterweight (counterpoise)
- 20 eyepiece
- 21 knee mounting with a bent column
- 22 English-type axis mounting (axis mount)
- 23 English-type yoke mounting (yoke mount)
- 24 fork mounting (fork mount)
- 25 horseshoe mounting (horseshoe mount)
- 26 meridian circle
- 27 divided circle (graduated circle)
- 28 reading microscope
- 29 meridian telescope
- 30 electron microscope
- 31-39 microscope tube (microscope body, body tube)
- 31 electron gun
- 32 condensers
- 33 specimen insertion air lock
- 34 control for specimen stage adjustment
- 35 control for the objective apertures
- 36 objective lens
- 37 intermediate image screen
- 38 telescope magnifier
- 39 final image tube
- 40 photographic chamber for film and plate magazines

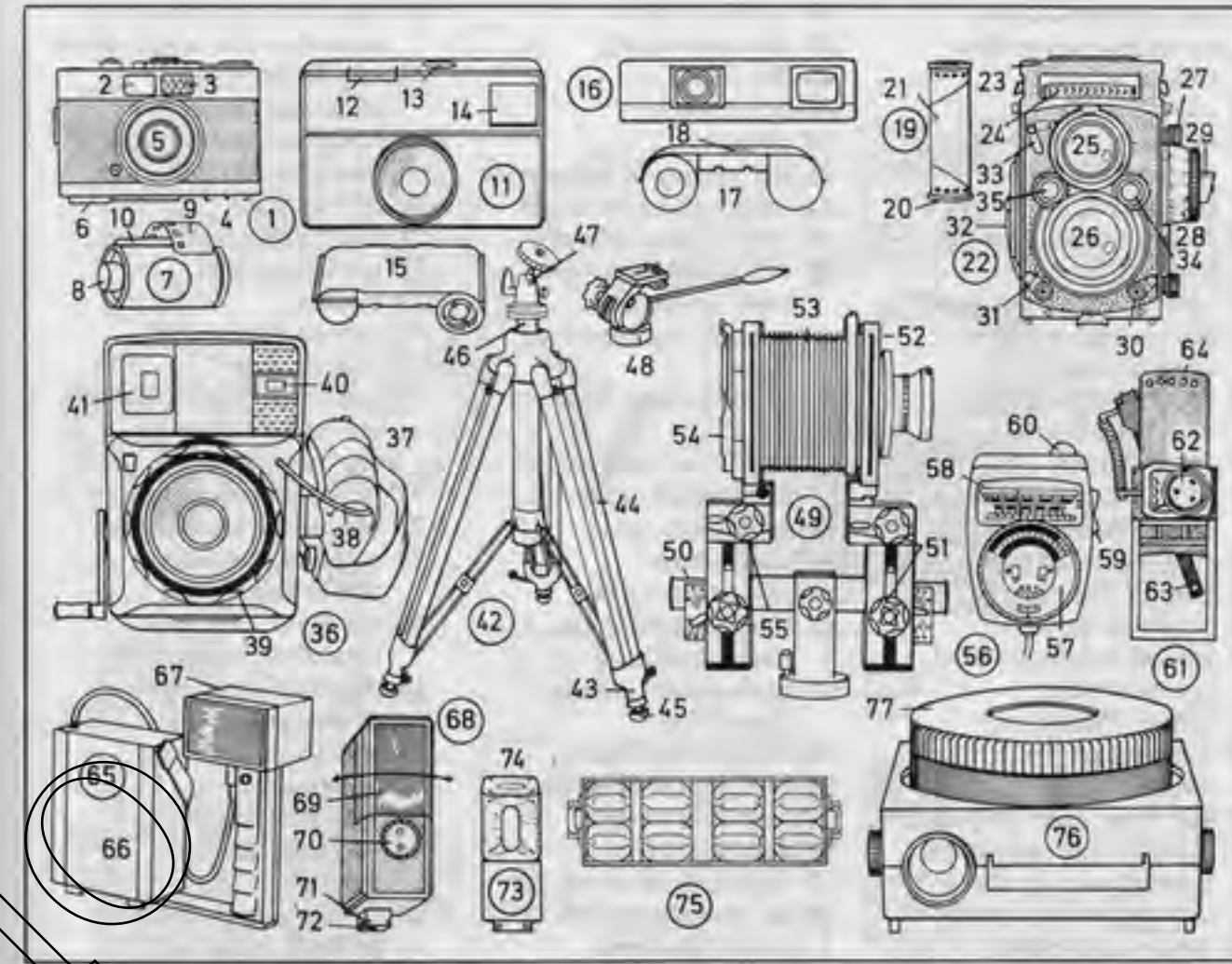

- 1 miniature camera (35 mm camera)
- 2 viewfinder eyepiece
- 3 meter cell
- 4 accessory shoe
- 5 flush lens
- 6 rewind handle (rewind, rewind crank)
- 7 miniature film cassette (135 film cassette, 35 mm cassette)
- 8 film spool
- 9 film with leader
- 10 cassette slit (cassette exit slot)
- 11 cartridge-loading camera
- 12 shutter release (shutter release button)
- 13 flash cube contact
- 14 rectangular viewfinder
- 15 126 cartridge (instamatic cartridge)
- 16 pocket camera (subminiature camera)
- 17 110 cartridge (subminiature cartridge)
- 18 film window
- 19 120 rollfilm
- 20 rollfilm spool
- 21 backing paper
- 22 twin-lens reflex camera
- 23 folding viewfinder hood (focusing hood)
- 24 meter cell
- 25 viewing lens
- 26 object lens
- 27 spool knob
- 28 distance setting (focus setting)
- 29 exposure meter using needle-matching system
- 30 flash contact
- 31 shutter release
- 32 film transport (film advance, film wind)
- 33 flash switch
- 34 aperture-setting control
- 35 shutter speed control
- 36 large format hand camera (press camera)
- 37 grip (handgrip)
- 38 cable release
- 39 distance-setting ring (focusing ring)
- 40 rangefinder window
- 41 multiple-frame viewfinder (universal viewfinder)
- 42 tripod
- 43 tripod leg
- 44 tubular leg
- 45 rubber foot
- 46 central column
- 47 ball and socket head
- 48 cine camera pan and tilt head
- 49 large-format folding camera
- 50 optical bench
- 51 standard adjustment
- 52 lens standard
- 53 bellows
- 54 camera back
- 55 back standard adjustment
- 56 hand-held exposure meter (exposure meter)
- 57 calculator dial
- 58 scales (indicator scales) with indicator needle (pointer)
- 59 range switch (high/low range selector)
- 60 diffuser for incident light measurement
- 61 probe exposure meter for large-format cameras
- 62 meter
- 63 probe
- 64 dark slide
- 65 battery-portable electronic flash (battery-portable electronic flash unit)
- 66 powerpack unit (battery)
- 67 flash head
- 68 single-unit electronic flash (flashgun)
- 69 swivel-mounted reflector
- 70 photodiode
- 71 foot
- 72 hot-shoe contact
- 73 flash cube unit
- 74 flash cube
- 75 flash bar
- 76 slide projector
- 77 rotary magazine

- 1-105 system camera
 1 miniature single-lens reflex camera
 2 camera body
 3-8 lens, a normal lens (standard lens)
 3 lens barrel
 4 distance scale in metres and feet
 5 aperture ring (aperture-setting ring, aperture control ring)
 6 front element mount with filter mount
 7 front element
 8 focusing ring (distance-setting ring)
 9 ring for the carrying strap
 10 battery chamber
 11 screw-in cover
 12 rewind handle (rewind, rewind crank)
 13 battery switch
 14 flash socket for F and X contact
 15 self-time lever (setting lever for the self-timer, setting lever for the delayed-action release)
 16 single-stroke film advance lever
 17 exposure counter (frame counter)
 18 shutter release (shutter release button)
 19 shutter speed setting knob (shutter speed control)
 20 accessory shoe
 21 hot-shoe flash contact
 22 viewfinder eyepiece with correcting lens
 23 camera back
 24 pressure plate
 25 take-up spool of the rapid-loading system
 26 transport sprocket
 27 rewind release button (reversing clutch)
 28 film window
 29 rewind cam
 30 tripod socket (tripod bush)
 31 reflex system (mirror reflex system)
 32 lens
 33 reflex mirror
 34 film window
 35 path of the image beam
 36 path of the sample beam
 37 meter cell
 38 auxiliary mirror
 39 focusing screen
 40 field lens
 41 pentaprism
 42 eyepiece
 43-105 system of accessories
 43 interchangeable lenses
 44 fisheye lens (fisheye)
 45 wide-angle lens (short focal length lens)
 46 normal lens (standard lens)
 47 medium focal length lens
 48 telephoto lens (long focal length lens)
 49 long-focus lens
 50 mirror lens
 51 viewfinder image
 52 signal to switch to manual control
 53 matt collar (ground glass collar)
 54 microprism collar
 55 split-image rangefinder (focusing wedges)
 56 aperture scale
 57 exposure meter needle
 58-66 interchangeable focusing screens
 58 all-matt screen (ground glass screen) with microprism spot
 59 all-matt screen (ground glass screen) with microprism spot and split-image rangefinder
 60 all-matt screen (ground glass screen) without focusing aids
 61 matt screen (ground glass screen) with reticule
 62 microprism spot for lenses with a large aperture
 63 microprism spot for lenses with an aperture of $f = 1:3.5$ or larger
 64 Fresnel lens with matt collar (ground glass collar) and split-image rangefinder
 65 all-matt screen (ground glass screen) with finely matted central spot and graduated markings
 66 matt screen (ground glass screen) with clear spot and double cross hairs

- 67 data recording back for exposing data about shots
 68 viewfinder hood (focusing hood)
 69 interchangeable pentaprism viewfinder
 70 pentaprism
 71 right-angle viewfinder
 72 correction lens
 73 eyecup
 74 focusing telescope
 75 battery unit
 76 combined battery holder and control grip for the motor drive
 77 rapid-sequence camera
 78 attachable motor drive
 79 external (outside) power supply
 80 ten meter film back (magazine back)
 81-98 close-up and macro equipment
 81 extension tube
 82 adapter ring
 83 reversing ring
 84 lens in retrofocus position
 85 bellows unit (extension bellows, close-up bellows attachment)
 86 focusing stage
 87 slide-copying attachment
 88 slide-copying adapter
 89 micro attachment (photomicroscope adapter)
 90 copying stand (copy stand, copypod)
 91 spider legs
 92 copying stand (copy stand)
 93 arm of the copying stand (copy stand)
 94 macrophoto stand
 95 stage plates for the macrophoto stand
 96 insertable disc (disk)
 97 Lieberkühn reflector
 98 mechanical stage
 99 table tripod (table-top tripod)
 100 rifle grip
 101 cable release
 102 double cable release
 103 camera case (ever-ready case)
 104 lens case
 105 soft-leather lens pouch

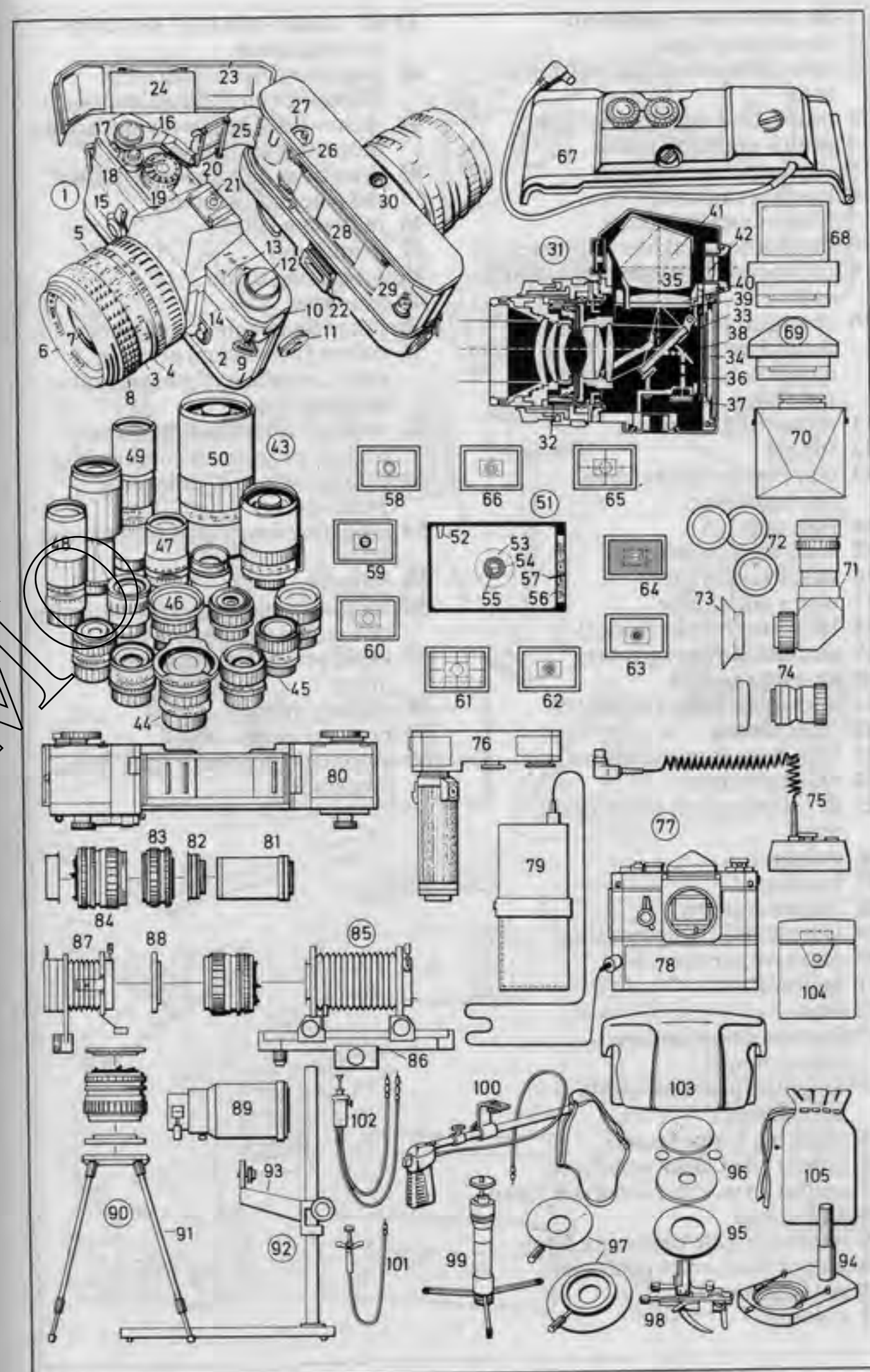

1-60 darkroom equipment

- 1 developing tank
- 2 spiral (developing spiral, tank reel)
- 3 multi-unit developing tank
- 4 multi-unit tank spiral
- 5 daylight-loading tank
- 6 loading chamber
- 7 film transport handle
- 8 developing tank thermometer
- 9 collapsible bottle for developing solution
- 10 chemical bottles for first developer, stop bath, colour developer, bleach-hardener, stabilizer
- 11 measuring cylinders
- 12 funnel
- 13 tray thermometer (dish thermometer)
- 14 film clip
- 15 wash tank (washer)
- 16 water supply pipe
- 17 water outlet pipe
- 18 laboratory timer (timer)
- 19 automatic film agitator
- 20 developing tank
- 21 darkroom lamp (safelight)
- 22 filter screen
- 23 film drier (drying cabinet)
- 24 exposure timer
- 25 developing dish (developing tray)
- 26 enlarger
- 27 baseboard
- 28 angled column
- 29 lamphouse (lamp housing)
- 30 negative carrier
- 31 bellows
- 32 lens
- 33 friction drive for fine adjustment
- 34 height adjustment (scale adjustment)
- 35 masking frame (easel)
- 36 colour (*Am. color*) analyser
- 37 colour (*Am. color*) analyser lamp
- 38 probe lead
- 39 exposure time balancing knob
- 40 colour (*Am. color*) enlarger
- 41 enlarger head
- 42 column
- 43-45 colour-mixing (*Am. color-mixing*) knob
- 43 magenta filter adjustment (minus green filter adjustment)
- 44 yellow filter adjustment (minus blue filter adjustment)
- 45 cyan filter adjustment (minus red filter adjustment)
- 46 red swing filter
- 47 print tongs
- 48 processing drum
- 49 squeegee
- 50 range (assortment) of papers
- 51 colour (*Am. color*) printing paper, a packet of photographic printing paper
- 52 colour (*Am. color*) chemicals (colour processing chemicals)
- 53 enlarging meter (enlarging photometer)
- 54 adjusting knob with paper speed scale
- 55 probe
- 56 semi-automatic thermostatically controlled developing dish
- 57 rapid print drier (heated print drier)
- 58 glazing sheet
- 59 pressure cloth
- 60 automatic processor (machine processor)

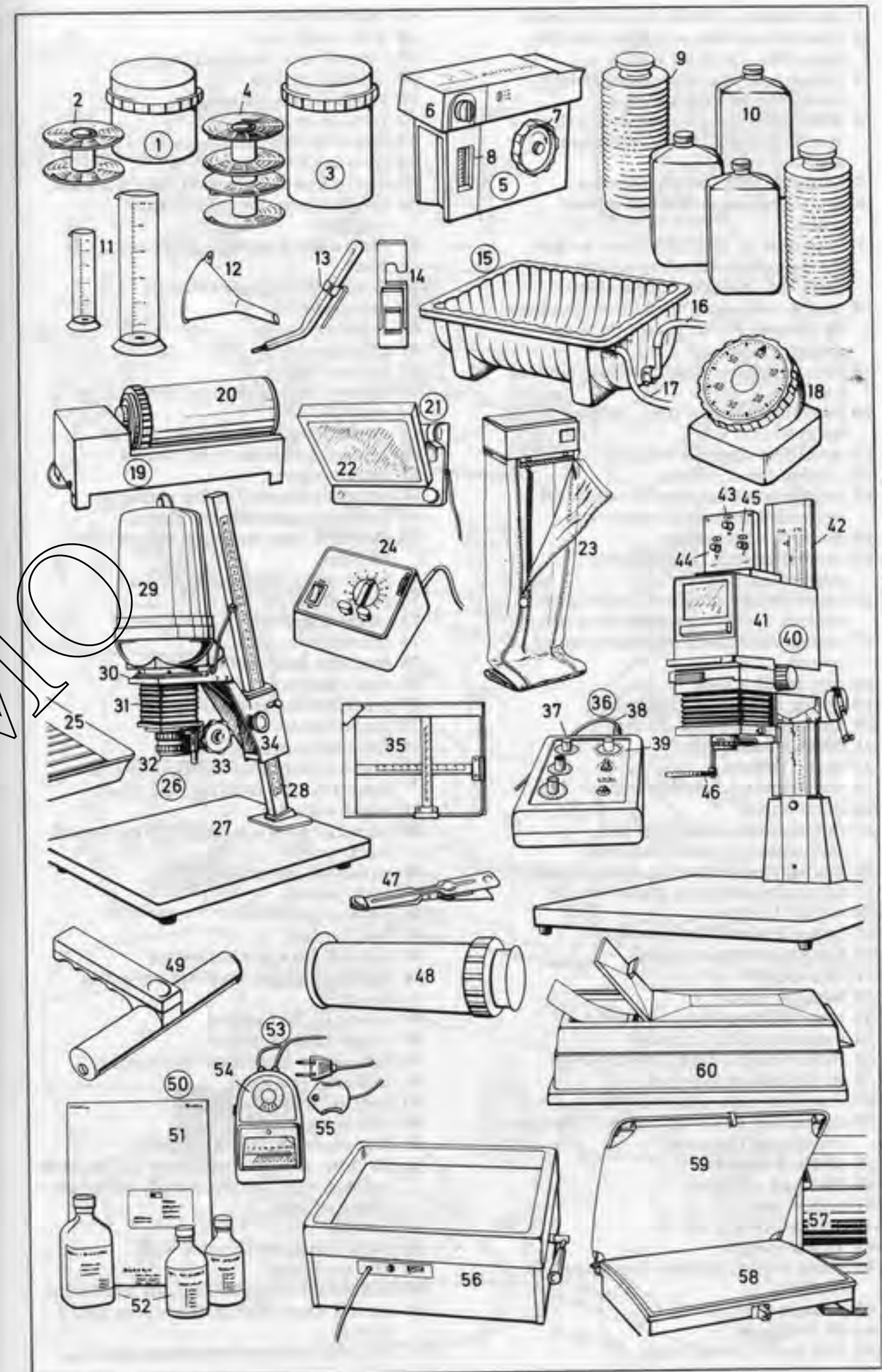

- 1 cine camera, a Super-8 sound camera
- 2 interchangeable zoom lens (variable focus lens, varifocal lens)
- 3 distance setting (focus setting) and manual focal length setting
- 4 aperture ring (aperture-setting ring, aperture control ring) for manual aperture setting
- 5 handgrip with battery chamber
- 6 shutter release with cable release socket
- 7 pilot tone or pulse generator socket for the sound recording equipment (with the dual film-tape system)
- 8 sound connecting cord for microphone or external sound source (in single-system recording)
- 9 remote control socket (remote control jack)
- 10 headphone socket (*sim.*: earphone socket)
- 11 autofocus override switch
- 12 filming speed selector
- 13 sound recording selector switch for automatic or manual operation
- 14 eyepiece with eyecup
- 15 diopter control ring (dioptric adjustment ring)
- 16 recording level control (audio level control, recording sensitivity selector)
- 17 manual/automatic exposure control switch
- 18 film speed setting
- 19 power zooming arrangement
- 20 automatic aperture control
- 21 sound track system
- 22 sound camera
- 23 telescopic microphone boom
- 24 microphone
- 25 microphone connecting lead (microphone connecting cord)
- 26 mixing console (mixing desk, mixer)
- 27 inputs from various sound sources
- 28 output to camera
- 29 Super-8 sound film cartridge
- 30 film gate of the cartridge
- 31 feed spool
- 32 take-up spool
- 33 recording head (sound head)
- 34 transport roller (capstan)
- 35 rubber pinch roller (capstan idler)
- 36 guide step (guide notch)
- 37 exposure meter control step
- 38 conversion filter step (colour, *Am.* color, conversion filter step)
- 39 single-8 cassette
- 40 film gate opening
- 41 unexposed film
- 42 exposed film
- 43 16 mm camera
- 44 reflex finder (through-the-lens reflex finder)
- 45 magazine
- 46-49 lens head
- 46 lens turret (turret head)

- 47 telephoto lens
- 48 wide-angle lens
- 49 normal lens (standard lens)
- 50 winding handle
- 51 compact Super-8 camera
- 52 footage counter
- 53 macro zoom lens
- 54 zooming lever
- 55 macro lens attachment (close-up lens)
- 56 macro frame (mount for small originals)
- 57 underwater housing (underwater case)
- 58 direct-vision frame finder
- 59 measuring rod
- 60 stabilizing wing
- 61 grip (handgrip)
- 62 locking bolt
- 63 control lever (operating lever)
- 64 porthole
- 65 synchronization start (sync start)
- 66 professional press-type camera
- 67 cameraman
- 68 camera assistant (sound assistant)
- 69 handclap marking sync start
- 70 dual film-tape recording using a tape recorder
- 71 pulse-generating camera
- 72 pulse cable
- 73 cassette recorder
- 74 microphone
- 75 dual film-tape reproduction
- 76 tape cassette
- 77 synchronization unit
- 78 cine projector
- 79 film feed spool
- 80 take-up reel (take-up spool), an automatic take-up reel (take-up spool)
- 81 sound projector
- 82 sound film with magnetic stripe (sound track, track)
- 83 automatic-threading button
- 84 trick button
- 85 volume control
- 86 reset button
- 87 fast and slow motion switch
- 88 forward, reverse, and still projection switch
- 89 splicer for wet splices
- 90 hinged clamping plate
- 91 film viewer (animated viewer editor)
- 92 foldaway reel arm
- 93 rewind handle (rewinder)
- 94 viewing screen
- 95 film perforator (film marker)
- 96 six-turn-able film and sound cutting table (editing table, cutting bench, animated sound editor)
- 97 monitor
- 98 control buttons (control well)
- 99 film turntable
- 100 first sound turntable, e.g. for live sound
- 101 second sound turntable for post-sync sound
- 102 film and tape synchronizing head

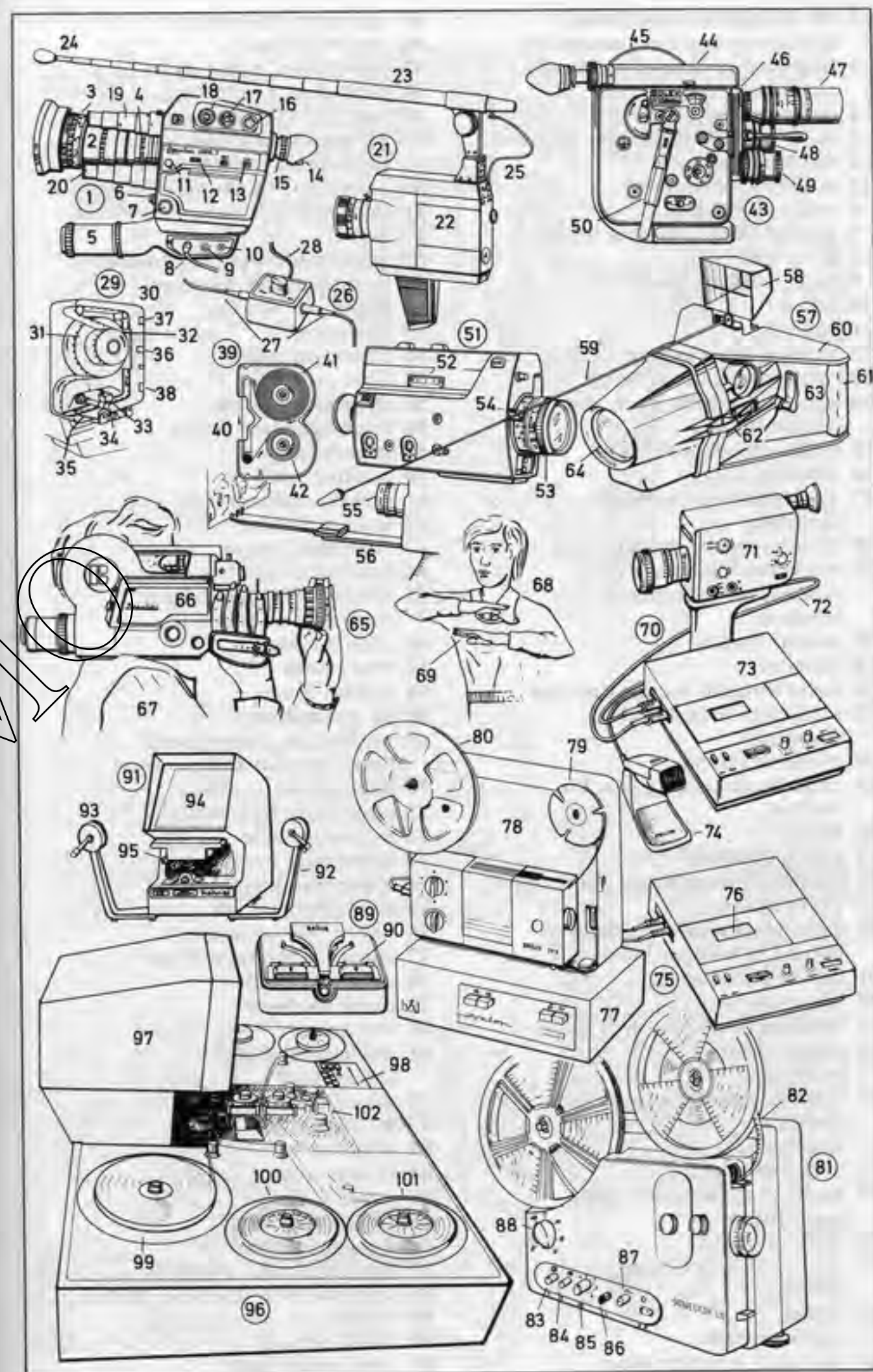

- 1-49 carcass (carcass, fabric)
[house construction, carcassing]
- 1 basement of tamped (rammed) concrete
- 2 concrete base course
- 3 cellar window (basement window)
- 4 outside cellar steps
- 5 utility room window
- 6 utility room door
- 7 ground floor (*Am.* first floor)
- 8 brick wall
- 9 lintel (window head)
- 10 reveal
- 11 jamb
- 12 window ledge (window sill)
- 13 reinforced concrete lintel
- 14 upper floor (first floor, *Am.* second floor)
- 15 hollow-block wall
- 16 concrete floor
- 17 work platform (working platform)
- 18 bricklayer (*Am.* brickmason)
- 19 bricklayer's labourer (*Am.* laborer); *also*: builder's labourer
- 20 mortar trough
- 21 chimney
- 22 cover (boards) for the staircase
- 23 scaffold pole (scaffold standard)
- 24 platform railing
- 25 angle brace (angle tie) in the scaffold
- 26 ledger
- 27 putlog (putlock)
- 28 plank platform (board platform)
- 29 guard board
- 30 scaffolding joint with chain or lashing or whip or bond
- 31 builder's hoist
- 32 mixer operator
- 33 concrete mixer, a gravity mixer
- 34 mixing drum
- 35 feeder skip
- 36 concrete aggregate [sand and gravel]
- 37 wheelbarrow
- 38 hose (hosepipe)
- 39 mortar pan (mortar trough, mortar tub)
- 40 stack of bricks
- 41 stacked shutter boards (lining boards)
- 42 ladder
- 43 bag of cement
- 44 site fence, a timber fence
- 45 signboard (billboard)
- 46 removable gate
- 47 contractors' name plates
- 48 site hut (site office)
- 49 building site latrine
- 50-57 bricklayer's (*Am.* brickmason's) tools
- 50 plumb bob (plummet)
- 51 thick lead pencil
- 52 trowel
- 53 bricklayer's (*Am.* brickmason's) hammer (brick hammer)
- 54 mallet
- 55 spirit level
- 56 laying-on trowel
- 57 float
- 58-68 masonry bonds
- 58 brick (standard brick)
- 59 stretching bond
- 60 heading bond
- 61 racking (raking) back
- 62 English bond
- 63 stretching course
- 64 heading course
- 65 English cross bond (Saint Andrew's cross bond)
- 66 chimney bond
- 67 first course
- 68 second course
- 69-82 excavation
- 69 profile (*Am.* batterboard) [fixed on edge at the corner]
- 70 intersection of strings
- 71 plumb bob (plummet)
- 72 excavation side
- 73 upper edge board
- 74 lower edge board
- 75 foundation trench
- 76 navy (*Am.* excavator)
- 77 conveyor belt (conveyor)
- 78 excavated earth
- 79 plank roadway
- 80 tree guard
- 81 mechanical shovel (excavator)
- 82 shovel bucket (bucket)
- 83-91 plastering
- 83 plasterer
- 84 mortar trough
- 85 screen
- 86-89 ladder scaffold
- 86 standard ladder
- 87 boards (planks, platform)
- 88 diagonal strut (diagonal brace)
- 89 railing
- 90 guard netting
- 91 rope-pulley hoist

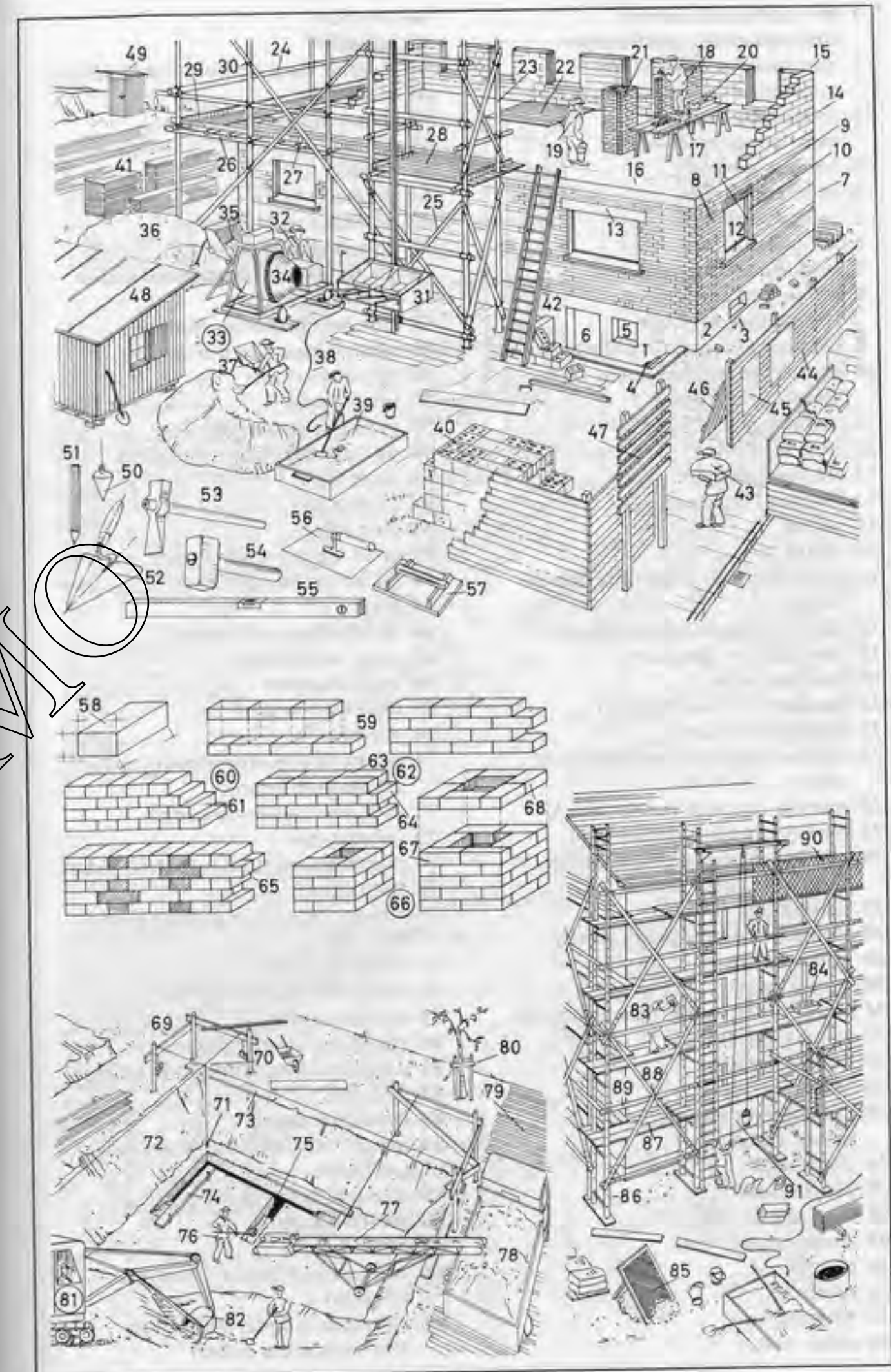

- 1-89 reinforced concrete (ferroconcrete) construction
- 1 reinforced concrete (ferroconcrete) skeleton construction
- 2 reinforced concrete (ferroconcrete) frame
- 3 inferior purlin
- 4 concrete purlin
- 5 ceiling joist
- 6 arch (flank)
- 7 rubble concrete wall
- 8 reinforced concrete (ferroconcrete) floor
- 9 concreter (concretor), flattening out
- 10 projecting reinforcement (*Am.* connection rebars)
- 11 column box
- 12 joist shuttering
- 13 shuttering strut
- 14 diagonal bracing
- 15 wedge
- 16 board
- 17 sheet pile wall (sheet pile, sheet piling)
- 18 shutter boards (lining boards)
- 19 circular saw (buzz saw)
- 20 bending table
- 21 bar bender (steel bender)
- 22 hand steel shears
- 23 reinforcing steel (reinforcement rods)
- 24 pumice concrete hollow block
- 25 partition wall, a timber wall
- 26 concrete aggregate [gravel and sand of various grades]
- 27 crane track
- 28 tipping wagon (tipping truck)
- 29 concrete mixer
- 30 cement silo
- 31 tower crane (tower slewing crane)
- 32 bogie (*Am.* truck)
- 33 counterweight
- 34 tower
- 35 crane driver's cabin (crane driver's cage)
- 36 jib (boom)
- 37 bearer cable
- 38 concrete bucket
- 39 sleepers (*Am.* ties)
- 40 chock
- 41 ramp
- 42 wheelbarrow
- 43 safety rail

- 44 site hut
- 45 canteen
- 46 tubular steel scaffold (scaffolding)
- 47 standard
- 48 ledger tube
- 49 tie tube
- 50 shoe
- 51 diagonal brace
- 52 planking (platform)
- 53 coupling (coupler)
- 54-76 formwork (shuttering) and reinforcement
- 54 bottom shuttering (lining)
- 55 side shutter of a purlin
- 56 cut-in bottom
- 57 cross beam
- 58 cramp iron (cramp, dog)
- 59 upright member, a standard
- 60 strap
- 61 cross piece
- 62 stop fillet
- 63 strut (brace, angle brace)
- 64 frame timber (yoke)
- 65 strap
- 66 reinforcement binding
- 67 cross strut (strut)
- 68 reinforcement
- 69 distribution steel
- 70 stirrup
- 71 projecting reinforcement (*Am.* connection rebars)
- 72 concrete (heavy concrete)
- 73 column box
- 74 bolted frame timber (bolted yoke)
- 75 nut (thumb nut)
- 76 shutter board (shuttering board)
- 77-89 tools
- 77 bending iron
- 78 adjustable service girder
- 79 adjusting screw
- 80 round bar reinforcement
- 81 distance piece (separator, spacer)
- 82 Torsteel
- 83 concrete tamper
- 84 mould (*Am.* mold) for concrete test cubes
- 85 concreter's tongs
- 86 sheeting support
- 87 hand shears
- 88 immersion vibrator (concrete vibrator)
- 89 vibrating cylinder (vibrating head, vibrating poker)

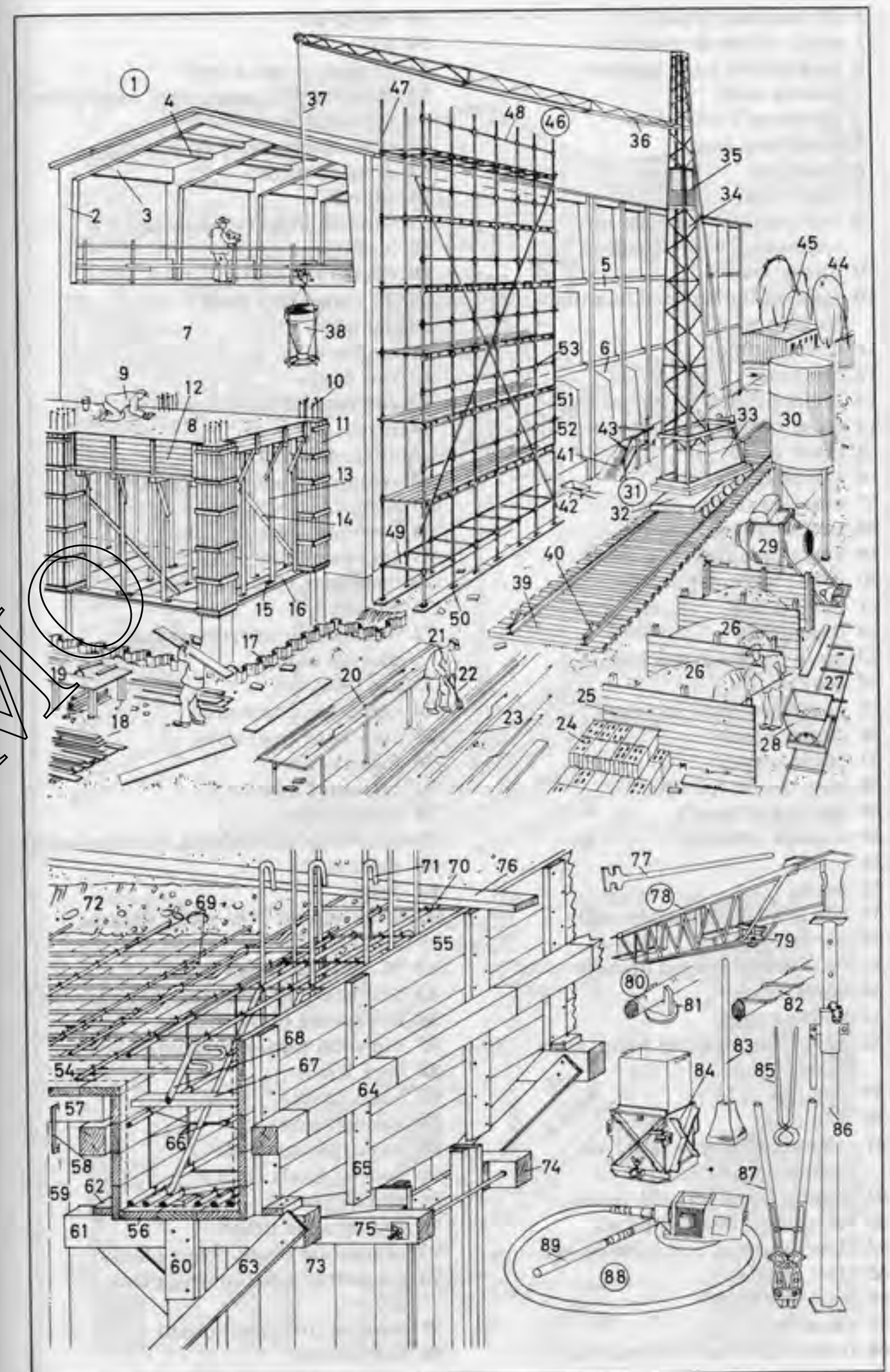

- 1-59 carpenter's yard
 1 stack of boards (planks)
 2 long timber (*Am.* lumber)
 3 sawing shed
 4 carpenter's workshop
 5 workshop door
 6 handcart
 7 roof truss
 8 tree [used for topping out ceremony], with wreath
 9 timber wall
 10 squared timber (building timber, scantlings)
 11 drawing floor
 12 carpenter
 13 safety helmet
 14 cross-cut saw, a chain saw
 15 chain guide
 16 saw chain
 17 mortiser (chain cutter)
 18 trestle (horse)
 19 beam mounted on a trestle
 20 set of carpenter's tools
 21 electric drill
 22 dowel hole
 23 mark for the dowel hole
 24 beams
 25 post (stile, stud, quarter)
 26 corner brace
 27 brace (strut)
 28 base course (plinth)
 29 house wall (wall)
 30 window opening
 31 reveal
 32 jamb
 33 window ledge (window sill)
 34 cornice
 35 roundwood (round timber)
 36 floorboards
 37 hoisting rope
 38 ceiling joist (ceiling beam, main beam)
 39 wall joist
 40 wall plate
 41 trimmer (trimmer joist, *Am.* header, header joist)
 42 dragon beam (dragon piece)
 43 false floor (inserted floor)
 44 floor filling of breeze, loam, etc.
 45 fillet (cleat)
 46 stair well (well)
 47 chimney
 48 framed partition (framed wall)
 49 wall plate
 50 girt
 51 window jamb, a jamb
 52 corner stile (corner strut, corner stud)
 53 principal post
 54 brace (strut) with skew notch
 55 nogging piece
 56 sill rail
 57 window lintel (window head)
 58 head (head rail)
 59 filled-in panel (bay, pan)
 60-82 carpenter's tools
 60 hand saw
 61 bucksaw
 62 saw blade
 63 compass saw (keyhole saw)
 64 plane
 65 auger (gimlet)
 66 screw clamp (cramp, holdfast)
 67 mallet
 68 two-handed saw
 69 try square
 70 broad axe (*Am.* broadax)
 71 chisel
 72 mortise axe (mortice axe, *Am.* mortise ax)
 73 axe (*Am.* ax)
 74 carpenter's hammer
 75 claw head (nail claw)
 76 folding rule
 77 carpenter's pencil
 78 iron square
 79 drawknife (drawshave, drawing knife)
 80 shaving
 81 bevel
 82 mitre square (*Am.* miter square, miter angle)
 83-96 building timber
 83 undressed timber (*Am.* rough lumber)
 84 heartwood (duramen)
 85 sapwood (sap, alburnum)
 86 bark (rind)
 87 baulk (balk)
 88 halved timber
 89 wane (waney edge)
 90 quarter baulk (balk)
 91 plank (board)
 92 end-grained timber
 93 heartwood plank (heart plank)
 94 unsquared (untrimmed) plank (board)
 95 squared (trimmed) board
 96 slab (offcut)

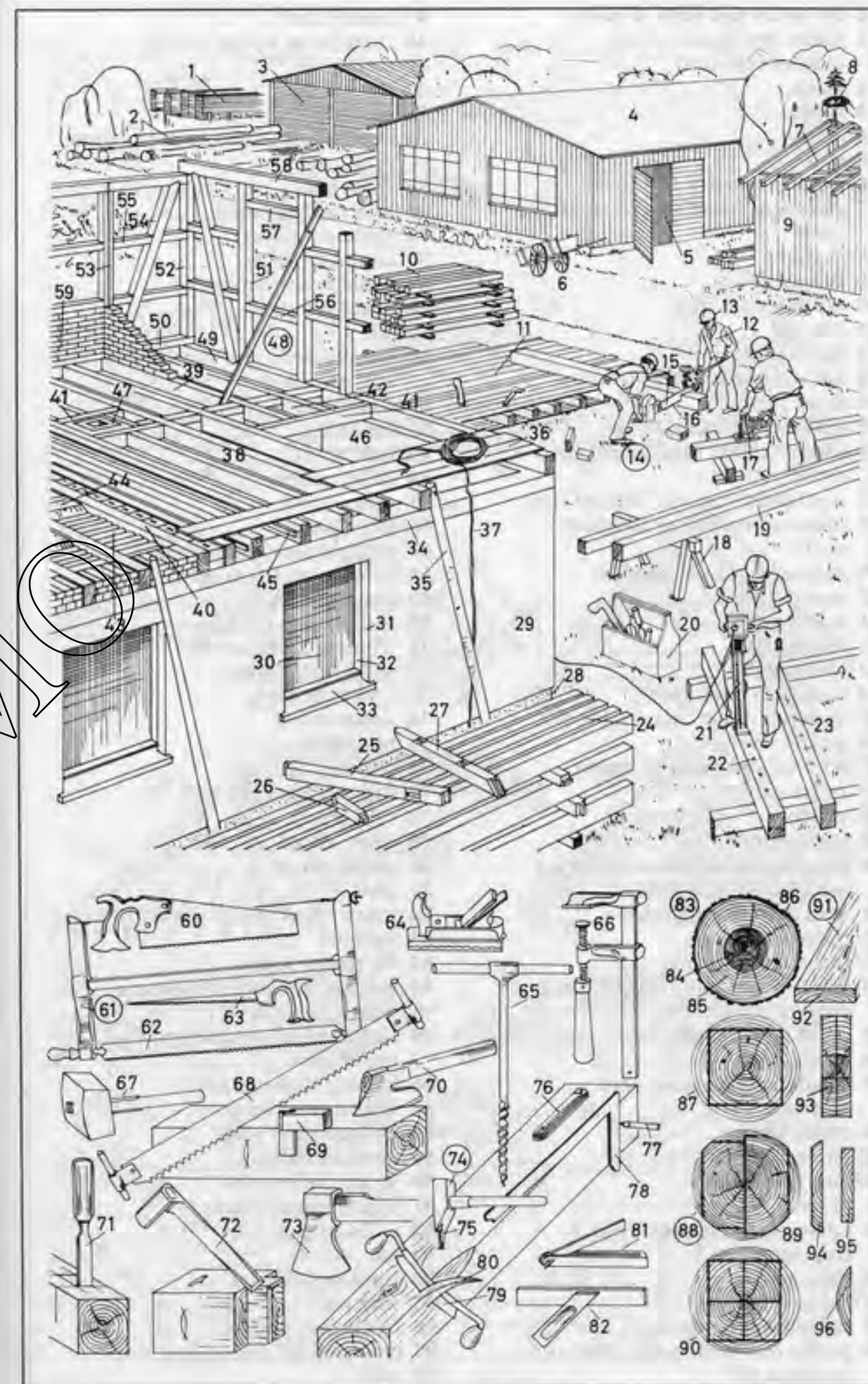

- 1-26 styles and parts of roofs
- 1 gable roof (saddle roof, saddleback roof)
- 2 ridge
- 3 verge
- 4 eaves
- 5 gable
- 6 dormer window (dormer)
- 7 pent roof (shed roof, lean-to roof)
- 8 skylight
- 9 fire gable
- 10 hip (hipped) roof
- 11 hip end
- 12 hip (arris)
- 13 hip (hipped) dormer window
- 14 ridge turret
- 15 valley (roof valley)
- 16 hipped-gable roof (jerkin head roof)
- 17 partial-hip (partial-hipped) end
- 18 mansard roof (*Am.* gambrel roof)
- 19 mansard dormer window
- 20 sawtooth roof
- 21 north light
- 22 broach roof
- 23 eyebrow
- 24 conical broach roof
- 25 imperial dome (imperial roof)
- 26 weather vane
- 27-83 roof structures of timber
- 27 rafter roof
- 28 rafter
- 29 roof beam
- 30 diagonal tie (cross tie, sprocket piece, cocking piece)
- 31 arris fillet (tilting fillet)
- 32 outer wall
- 33 beam head
- 34 collar beam roof (trussed-rafter roof)
- 35 collar beam (collar)
- 36 rafter
- 37 strutted collar beam roof structure
- 38 collar beams
- 39 purlin
- 40 post (stile, stud)
- 41 brace
- 42 unstrutted (king pin) roof structure
- 43 ridge purlin
- 44 inferior purlin
- 45 rafter head (rafter end)
- 46 purlin roof with queen post and pointing sill
- 47 pointing sill
- 48 ridge beam (ridge board)
- 49 simple tie
- 50 double tie
- 51 purlin
- 52 purlin roof structure with queen post
- 53 tie beam
- 54 joist (ceiling joist)
- 55 principal rafter
- 56 common rafter
- 57 angle brace (angle tie)
- 58 brace (strut)
- 59 ties
- 60 hip (hipped) roof with purlin roof structure
- 61 jack rafter
- 62 hip rafter
- 63 jack rafter
- 64 valley rafter
- 65 queen truss
- 66 main beam
- 67 summer (summer beam)
- 68 queen post (truss post)
- 69 brace (strut)
- 70 collar beam (collar)
- 71 trimmer (*Am.* header)
- 72 solid-web girder
- 73 lower chord
- 74 upper chord
- 75 boarding
- 76 purlin
- 77 supporting outer wall
- 78 roof truss
- 79 lower chord
- 80 upper chord
- 81 post
- 82 brace (strut)
- 83 support
- 84-98 timber joints
- 84 mortise (mortice) and tenon joint
- 85 forked mortise (mortice) and tenon joint
- 86 halving (halved) joint
- 87 simple scarf joint
- 88 oblique scarf joint
- 89 dovetail halving
- 90 single skew notch
- 91 double skew notch
- 92 wooden nail
- 93 pin
- 94 clout nail (clout)
- 95 wire nail
- 96 hardwood wedges
- 97 cramp iron (timber dog, dog)
- 98 bolt

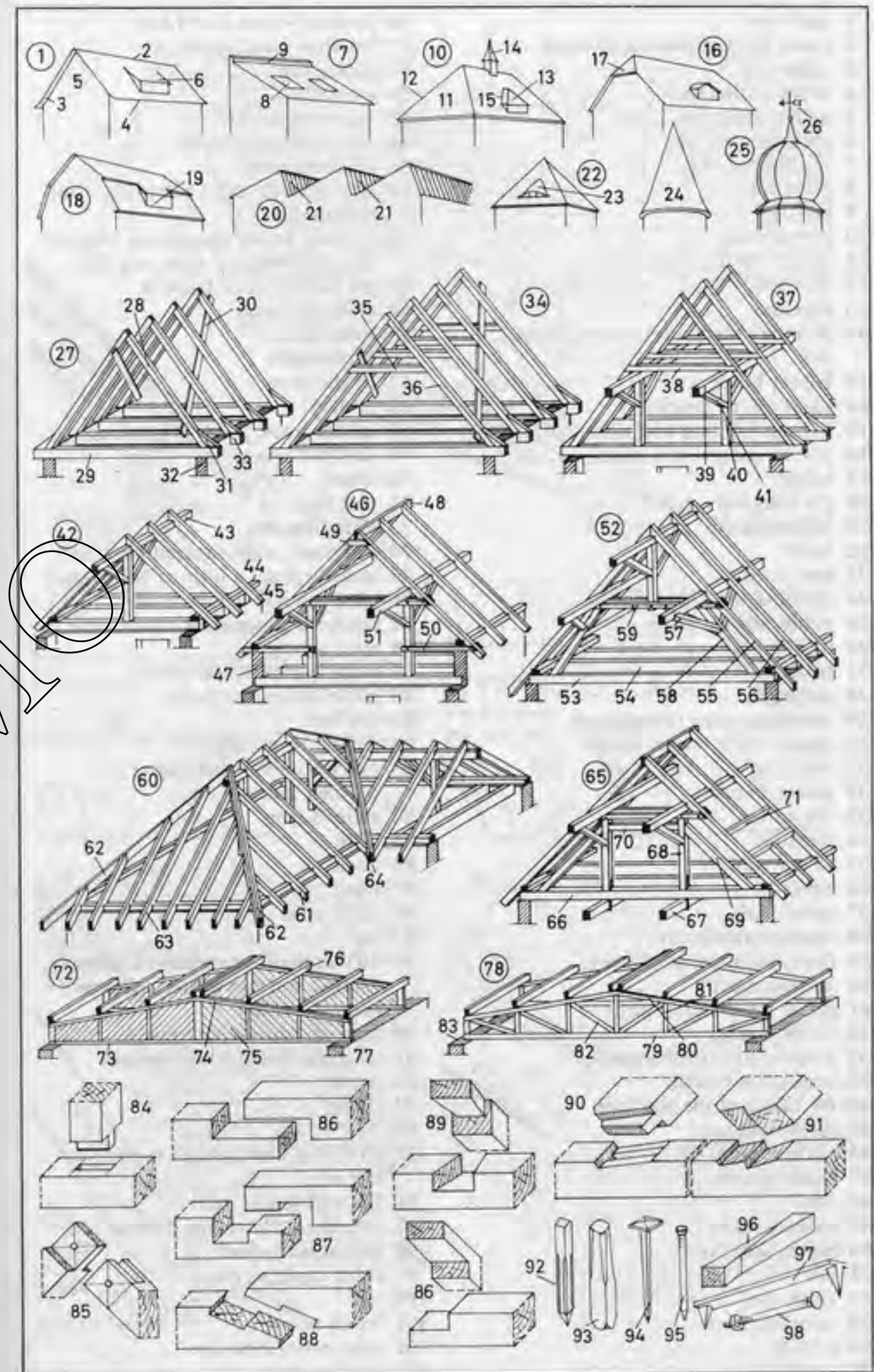

- 1 tiled roof
- 2 plain-tile double-lap roofing
- 3 ridge tile
- 4 ridge course tile
- 5 under-ridge tile
- 6 plain (plane) tile
- 7 ventilating tile
- 8 ridge tile
- 9 hip tile
- 10 hipped end
- 11 valley (roof valley)
- 12 skylight
- 13 chimney
- 14 chimney flashing, made of sheet zinc
- 15 ladder hook
- 16 snow guard bracket
- 17 battens (slating and tiling battens)
- 18 batten gauge (Am. gage)
- 19 rafter
- 20 tile hammer
- 21 lath axe (Am. ax)
- 22 hod
- 23 hod hook
- 24 opening (hatch)
- 25 gable (gable end)
- 26 toothed lath
- 27 soffit
- 28 gutter
- 29 rainwater pipe (downpipe)
- 30 swan's neck (swan-neck)
- 31 pipe clip
- 32 gutter bracket
- 33 tile cutter
- 34 scaffold
- 35 safety wall
- 36 eaves
- 37 outer wall
- 38 exterior rendering
- 39 frost-resistant brickwork
- 40 inferior purlin
- 41 rafter head (rafter end)
- 42 eaves fascia
- 43 double lath (tilting lath)
- 44 insulating boards
- 45-60 tiles and tile roofings
- 45 split-tiled roof
- 46 plain (plane) tile
- 47 ridge course
- 48 slip
- 49 eaves course
- 50 plain-tiled roof
- 51 nib
- 52 ridge tile
- 53 pantiled roof
- 54 pantile
- 55 pointing

- 56 Spanish-tiled roof (Am. mission-tiled roof)
- 57 under tile
- 58 over tile
- 59 interlocking tile
- 60 flat interlocking tile
- 61-89 slate roof
- 61 roof boards (roof boarding, roof sheathing)
- 62 roofing paper (sheathing paper); also: roofing felt (Am. rag felt)
- 63 cat ladder (roof ladder)
- 64 coupling hook
- 65 ridge hook
- 66 roof trestle
- 67 trestle rope
- 68 knot
- 69 ladder hook
- 70 scaffold board
- 71 slater
- 72 nail bag
- 73 slate hammer
- 74 slate nail, a galvanized wire nail
- 75 slater's shoe, a bast or hemp shoe
- 76 eaves course (eaves joint)
- 77 corner bottom slate
- 78 roof course
- 79 ridge course (ridge joint)
- 80 gable slate
- 81 tail line
- 82 valley (roof valley)
- 83 box gutter (trough gutter, parallel gutter)
- 84 slater's iron
- 85 slate
- 86 back
- 87 head
- 88 front edge
- 89 tail
- 90-103 asphalt-impregnated paper roofing and corrugated asbestos cement roofing
- 90 asphalt-impregnated paper roof
- 91 width [parallel to the gutter]
- 92 gutter
- 93 ridge
- 94 join
- 95 width [at right angles to the gutter]
- 96 felt nail (clout nail)
- 97 corrugated asbestos cement roof
- 98 corrugated sheet
- 99 ridge capping piece
- 100 lap
- 101 wood screw
- 102 rust-proof zinc cup
- 103 lead washer

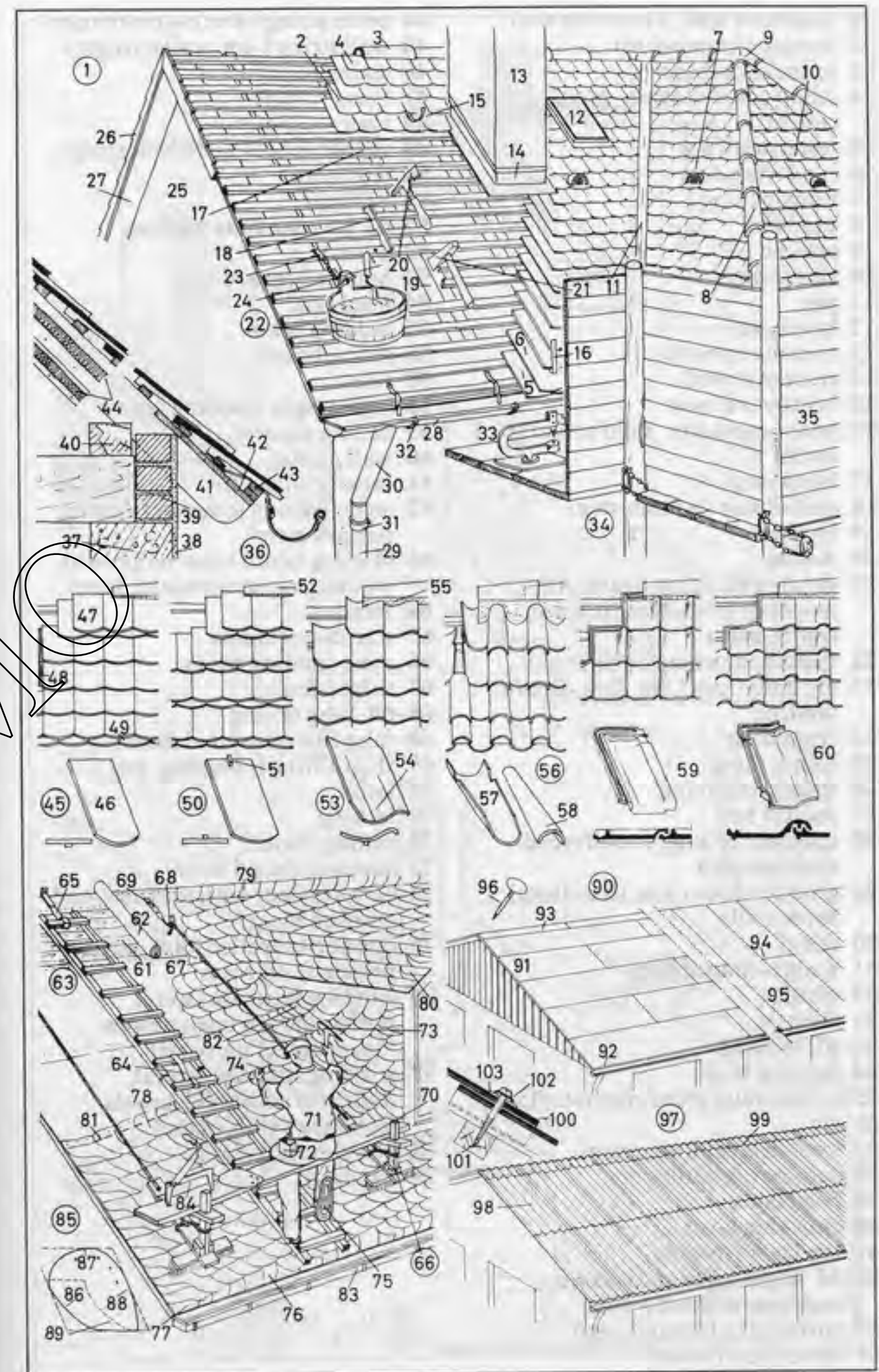

- 1 basement wall, a concrete wall
- 2 footing (foundation)
- 3 foundation base
- 4 damp course (damp-proof course)
- 5 waterproofing
- 6 rendering coat
- 7 brick paving
- 8 sand bed
- 9 ground
- 10 shuttering
- 11 peg
- 12 hardcore
- 13 oversite concrete
- 14 cement screed
- 15 brickwork base
- 16 basement stairs, solid concrete stairs
- 17 block step
- 18 curtail step (bottom step)
- 19 top step
- 20 nosing
- 21 skirting (skirting board, *Am.* mopboard, washboard, scrub board, base)
- 22 balustrade of metal bars
- 23 ground-floor (*Am.* first-floor) landing
- 24 front door
- 25 foot scraper
- 26 flagstone paving
- 27 mortar bed
- 28 concrete ceiling, a reinforced concrete slab
- 29 ground-floor (*Am.* first-floor) brick wall
- 30 ramp
- 31 wedge-shaped step
- 32 tread
- 33 riser
- 34-41 landing
- 34 landing beam
- 35 ribbed reinforced concrete floor
- 36 rib
- 37 steel-bar reinforcement
- 38 subfloor (blind floor)
- 39 level layer
- 40 finishing layer
- 41 top layer (screed)
- 42-44 dog-legged staircase, a staircase without a well
- 42 curtail step (bottom step)
- 43 newel post (newel)
- 44 outer string (*Am.* outer stringer)
- 45 wall string (*Am.* wall stringer)
- 46 staircase bolt
- 47 tread
- 48 riser
- 49 wreath piece (wreathed string)
- 50 balustrade
- 51 baluster
- 52-62 intermediate landing
- 52 wreath
- 53 handrail (guard rail)
- 54 head post
- 55 landing beam
- 56 lining board
- 57 fillet
- 58 lightweight building board
- 59 ceiling plaster
- 60 wall plaster
- 61 false ceiling
- 62 strip flooring (overlay flooring, parquet strip)
- 63 skirting board (*Am.* mopboard, washboard, scrub board, base)
- 64 beading
- 65 staircase window
- 66 main landing beam
- 67 fillet (cleat)
- 68-69 false ceiling
- 68 false floor (inserted floor)
- 69 floor filling (plugging, pug)
- 70 laths
- 71 lathing
- 72 ceiling plaster
- 73 subfloor (blind floor)
- 74 parquet floor with tongued-and-grooved blocks
- 75 quarter-newelled (*Am.* quarter-neweled) staircase
- 76 winding staircase (spiral staircase) with open newels (open-newel staircase)
- 77 winding staircase (spiral staircase) with solid newels (solid-newel staircase)
- 78 newel (solid newel)
- 79 handrail

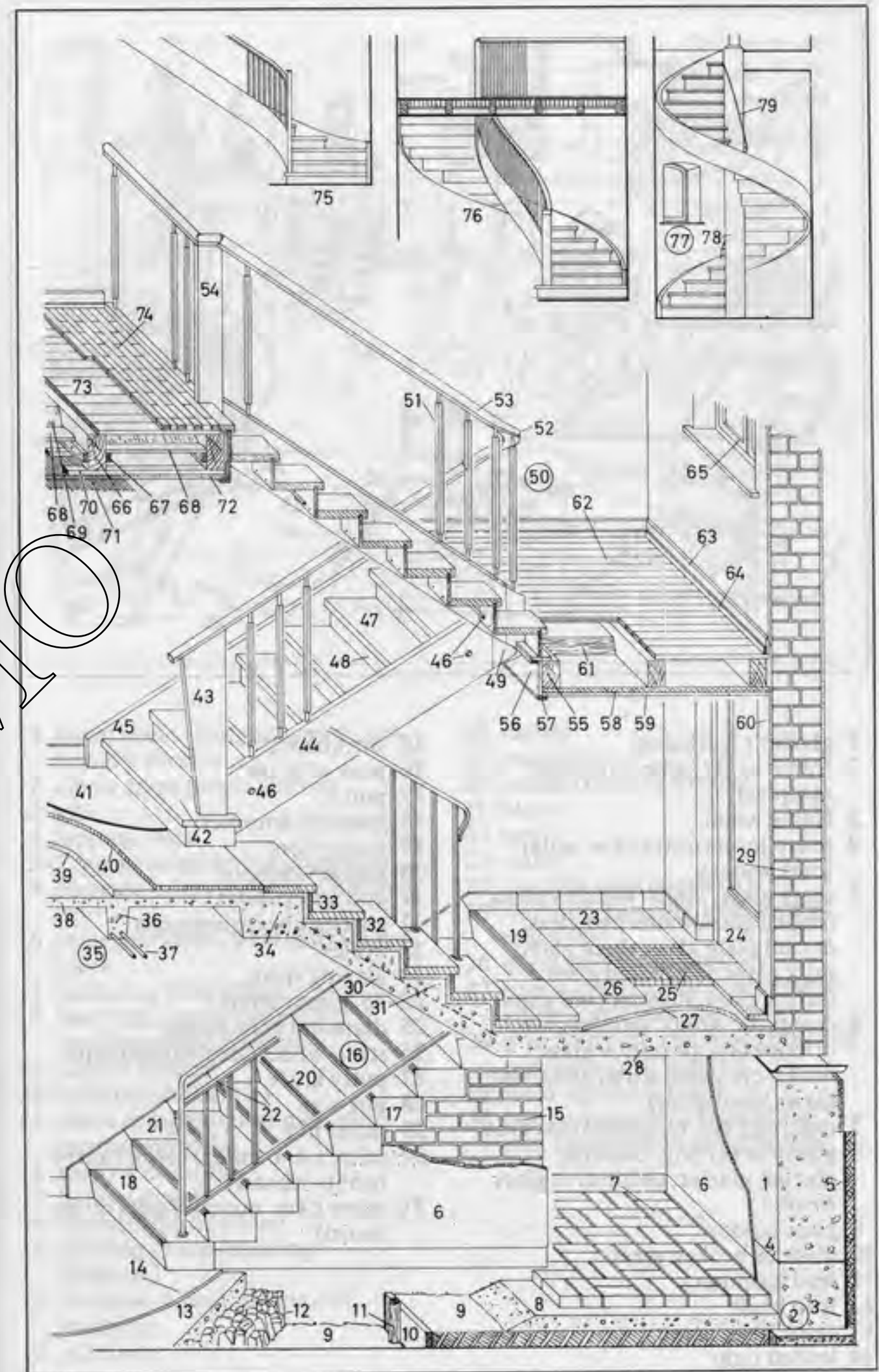

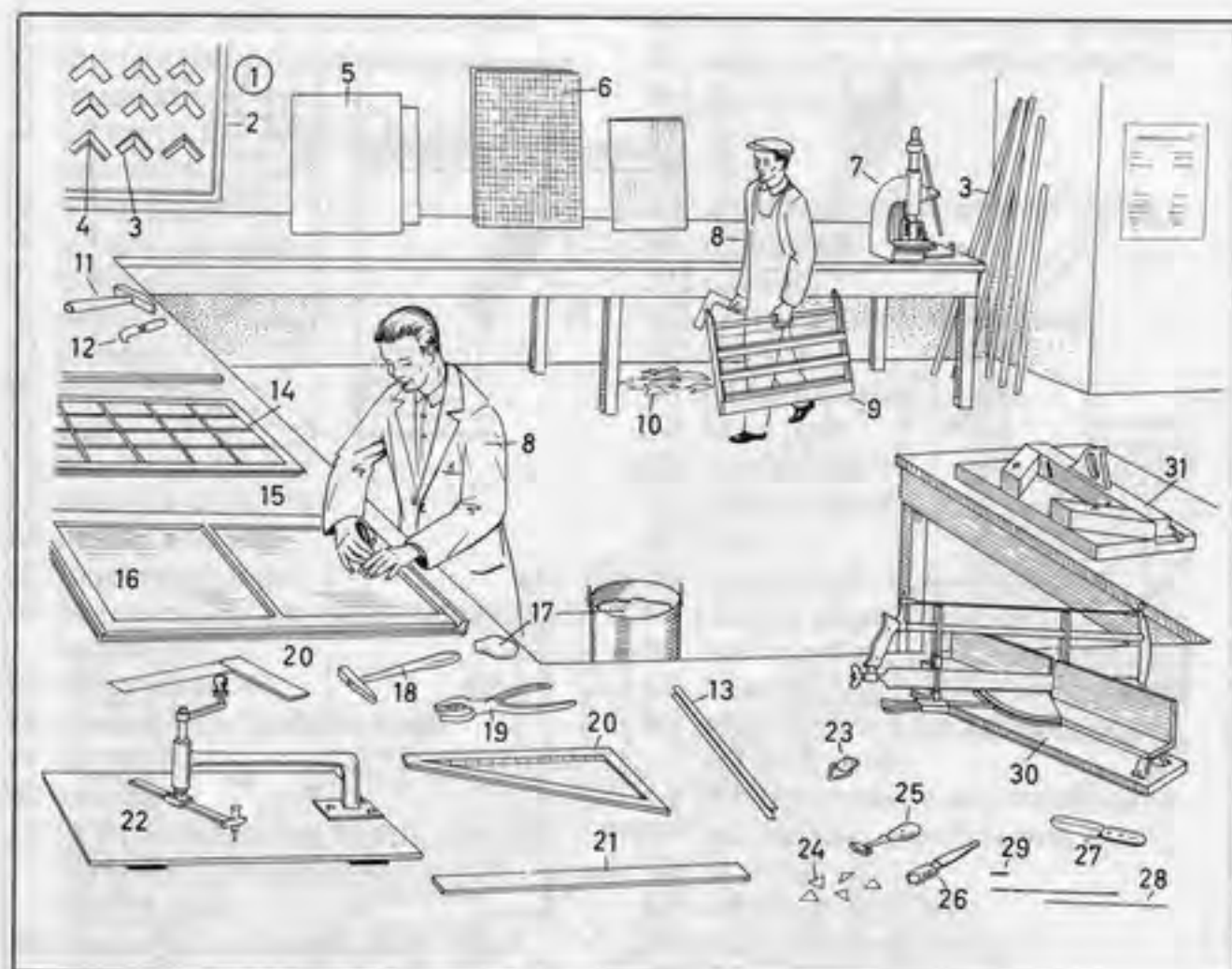

- | | |
|--|---|
| 1 glazier's workshop | 15 workbench |
| 2 frame wood samples (frame samples) | 16 pane of glass |
| 3 frame wood | 17 putty |
| 4 mitre joint (mitre, <i>Am.</i> miter joint, miter) | 18 glazier's hammer |
| 5 sheet glass; <i>kinds</i> : window glass, frosted glass, patterned glass, crystal plate glass, thick glass, milk glass, laminated glass (safety glass, shatterproof glass) | 19 glass pliers |
| 6 cast glass; <i>kinds</i> : stained glass, ornamental glass, raw glass, bull's-eye glass, wired glass, line glass (lined glass) | 20 glazier's square |
| 7 mitring (<i>Am.</i> mitering) machine | 21 glazier's rule |
| 8 glassworker (e.g. building glazier, glazier, decorative glass worker) | 22 glazier's beam compass |
| 9 glass holder | 23 eyelet |
| 10 piece of broken glass | 24 glazing sprig |
| 11 lead hammer | 25-26 glass cutters |
| 12 lead knife | 25 diamond glass cutter |
| 13 came (lead came) | 26 steel-wheel (steel) glass cutter |
| 14 leaded light | 27 putty knife |
| | 28 pin wire |
| | 29 panel pin |
| | 30 mitre (<i>Am.</i> miter) block (mitre box) [with saw] |
| | 31 mitre (<i>Am.</i> miter) shoot (mitre board) |

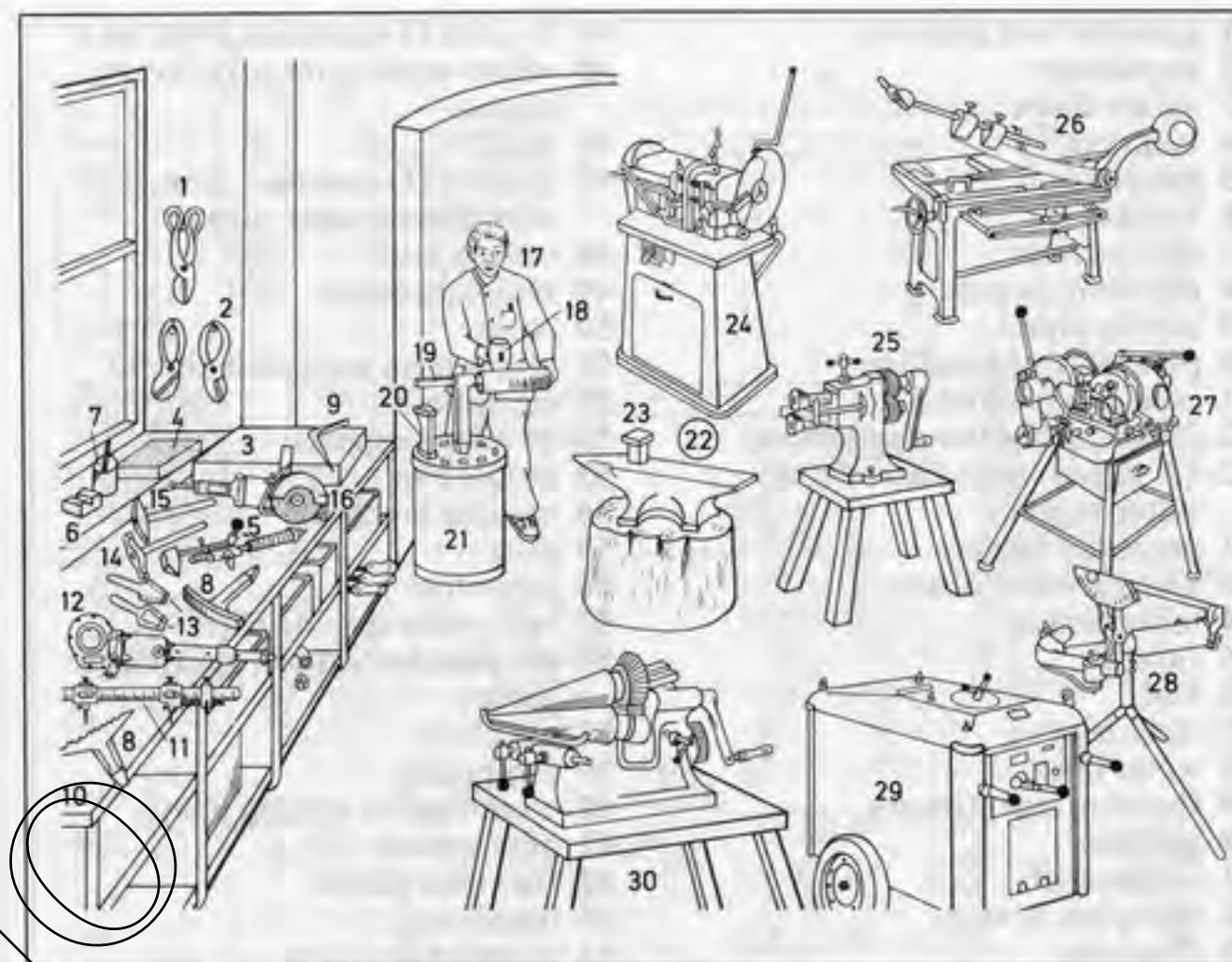

- | | |
|---|---|
| 1 metal shears (tinner's snips, <i>Am.</i> tinner's shears) | 18 mallet |
| 2 elbow snips (angle shears) | 19 mandrel |
| 3 gib | 20 socket (tinner's socket) |
| 4 lapping plate | 21 block |
| 5-7 propane soldering apparatus | 22 anvil |
| 5 propane soldering iron, a hatchet iron | 23 stake |
| 6 soldering stone, a sal-ammoniac block | 24 circular saw (buzz saw) |
| 7 soldering fluid (flux) | 25 flanging, swaging, and wiring machine |
| 8 beading iron for forming reinforcement beading | 26 sheet shears (guillotine) |
| 9 angled reamer | 27 screw-cutting machine (thread-cutting machine, die stocks) |
| 10 workbench (bench) | 28 pipe-bending machine (bending machine, pipe bender) |
| 11 beam compass (trammel, <i>Am.</i> beam trammel) | 29 welding transformer |
| 12 electric hand die | 30 bending machine (rounding machine) for shaping funnels |
| 13 hollow punch | |
| 14 chamfering hammer | |
| 15 beading swage (beading hammer) | |
| 16 abrasive-wheel cutting-off machine | |
| 17 plumber | |

- 1 gas fitter and plumber
- 2 stepladder
- 3 safety chain
- 4 stopcock
- 5 gas meter
- 6 bracket
- 7 service riser
- 8 distributing pipe
- 9 supply pipe
- 10 pipe-cutting machine
- 11 pipe repair stand
- 12-25 gas and water appliances
- 12-13 geyser, an instantaneous water heater
- 12 gas water heater
- 13 electric water heater
- 14 toilet cistern
- 15 float
- 16 bell
- 17 flush pipe
- 18 water inlet
- 19 flushing lever (lever)
- 20 radiator
- 21 radiator rib
- 22 two-pipe system
- 23 flow pipe
- 24 return pipe
- 25 gas heater
- 26-37 plumbing fixtures
- 26 trap (anti-syphon trap)
- 27 mixer tap (Am. mixing faucet) for washbasins
- 28 hot tap
- 29 cold tap
- 30 extendible shower attachment
- 31 water tap (pillar tap) for washbasins
- 32 spindle top
- 33 shield
- 34 draw-off tap (Am. faucet)
- 35 supatap
- 36 swivel tap
- 37 flushing valve
- 38-52 fittings
- 38 joint with male thread
- 39 reducing socket (reducing coupler)
- 40 elbow screw joint (elbow coupling)
- 41 reducing socket (reducing coupler) with female thread
- 42 screw joint
- 43 coupler (socket)

- 44 T-joint (T-junction joint, tee)
- 45 elbow screw joint with female thread
- 46 bend
- 47 T-joint (T-junction joint, tee) with female taper thread
- 48 ceiling joint
- 49 reducing elbow
- 50 cross
- 51 elbow joint with male thread
- 52 elbow joint
- 53-57 pipe supports
- 53 saddle clip
- 54 spacing bracket
- 55 plug
- 56 pipe clips
- 57 two-piece spacing clip
- 58-86 plumber's tools, gas fitter's tools
- 58 gas pliers
- 59 footprints
- 60 combination cutting pliers
- 61 pipe wrench
- 62 flat-nose pliers
- 63 nipple key
- 64 round-nose pliers
- 65 pincers
- 66 adjustable S-wrench
- 67 screw wrench
- 68 shifting spanner
- 69 screwdriver
- 70 compass saw (keyhole saw)
- 71 hacksaw frame
- 72 hand saw
- 73 soldering iron
- 74 blowlamp (blowtorch) [for soldering]
- 75 sealing tape
- 76 tin-lead solder
- 77 club hammer
- 78 hammer
- 79 spirit level
- 80 steel-leg vice (Am. vise)
- 81 pipe vice (Am. vise)
- 82 pipe-bending machine
- 83 former (template)
- 84 pipe cutter
- 85 hand die
- 86 screw-cutting machine (thread-cutting machine)

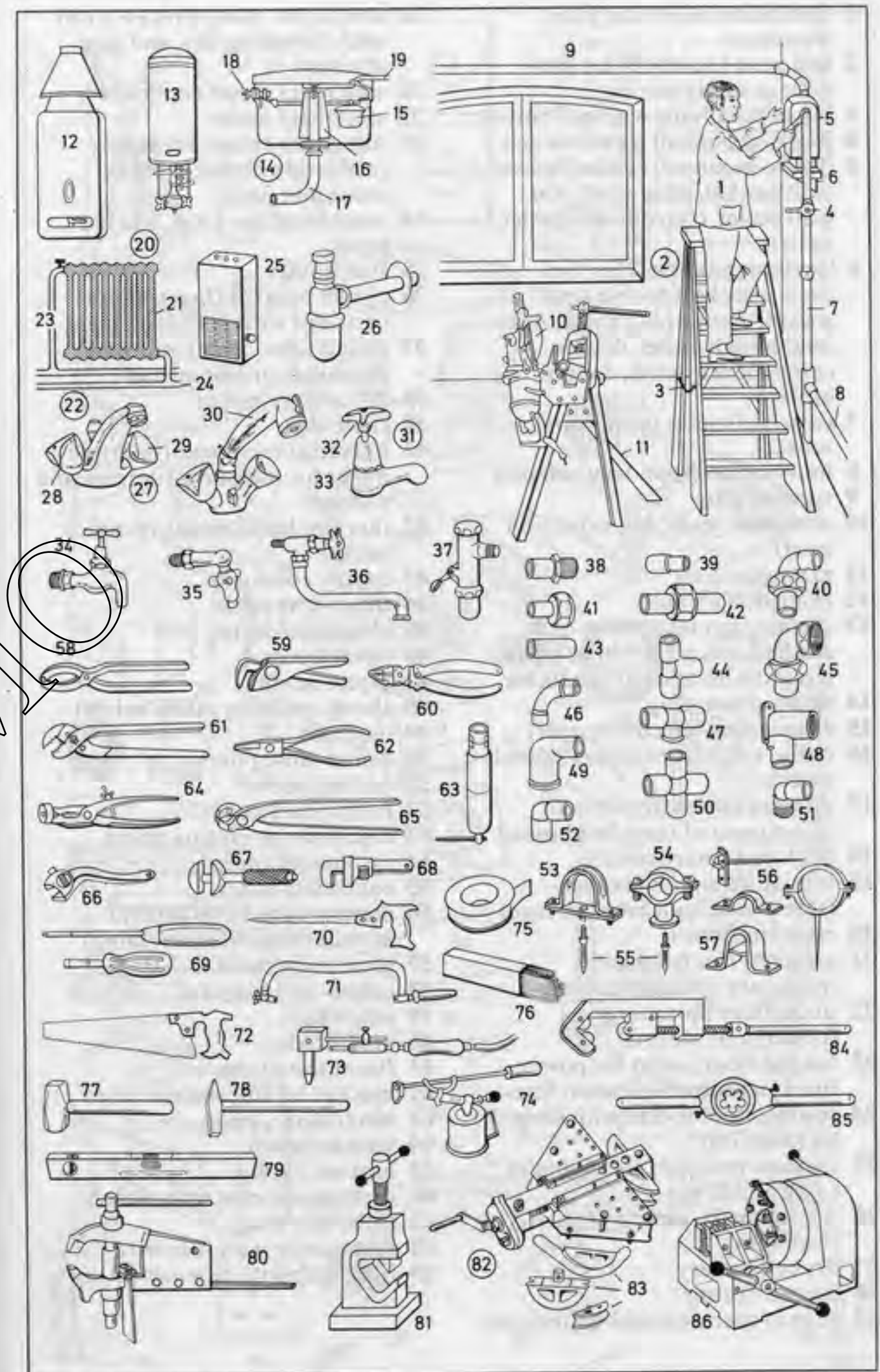

- 1 electrician (electrical fitter, wireman)
- 2 bell push (doorbell) for low-voltage safety current
- 3 house telephone with call button
- 4 [flush-mounted] rocker switch
- 5 [flush-mounted] earthed socket (wall socket, plug point, *Am.* wall outlet, convenience outlet, outlet)
- 6 [surface-mounted] earthed double socket (double wall socket, double plug point, *Am.* double wall outlet, double convenience outlet, double outlet)
- 7 switched socket (switch and socket)
- 8 four-socket (four-way) adapter
- 9 earthed plug
- 10 extension lead (*Am.* extension cord)
- 11 extension plug
- 12 extension socket
- 13 surface-mounted three-pole earthed socket [for three-phase circuit] with neutral conductor
- 14 three-phase plug
- 15 electric bell (electric buzzer)
- 16 pull-switch (cord-operated wall switch)
- 17 dimmer switch [for smooth adjustment of lamp brightness]
- 18 drill-cast rotary switch
- 19 miniature circuit breaker (screw-in circuit breaker, fuse)
- 20 resetting button
- 21 set screw [for fuses and miniature circuit breakers]
- 22 underfloor mounting (underfloor sockets)
- 23 hinged floor socket for power lines and communication lines
- 24 sunken floor socket with hinged lid (snap lid)
- 25 surface-mounted socket outlet (plug point) box
- 26 pocket torch, a torch (*Am.* flashlight)
- 27 dry cell battery
- 28 contact spring
- 29 strip of thermoplastic connectors
- 30 steel draw-in wire (draw wire) with threading key, and ring attached
- 31 electricity meter cupboard
- 32 electricity meter
- 33 miniature circuit breakers (miniature circuit breaker consumer unit)
- 34 insulating tape (*Am.* friction tape)
- 35 fuse holder
- 36 circuit breaker (fuse), a fuse cartridge with fusible element
- 37 colour (*Am.* color) indicator [showing current rating]
- 38-39 contact maker
- 40 cable clip
- 41 universal test meter (multiple meter for measuring current and voltage)
- 42 thermoplastic moisture-proof cable
- 43 copper conductor
- 44 three-core cable
- 45 electric soldering iron
- 46 screwdriver
- 47 pipe wrench
- 48 shock-resisting safety helmet
- 49 tool case
- 50 round-nose pliers
- 51 cutting pliers
- 52 junior hacksaw
- 53 combination cutting pliers
- 54 insulated handle
- 55 continuity tester
- 56 electric light bulb (general service lamp, filament lamp)
- 57 glass bulb (bulb)
- 58 coiled-coil filament
- 59 screw base
- 60 lampholder
- 61 fluorescent tube
- 62 bracket for fluorescent tubes
- 63 electrician's knife
- 64 wire strippers
- 65 bayonet fitting
- 66 three-pin socket with switch
- 67 three-pin plug
- 68 fuse carrier with fuse wire
- 69 light bulb with bayonet fitting

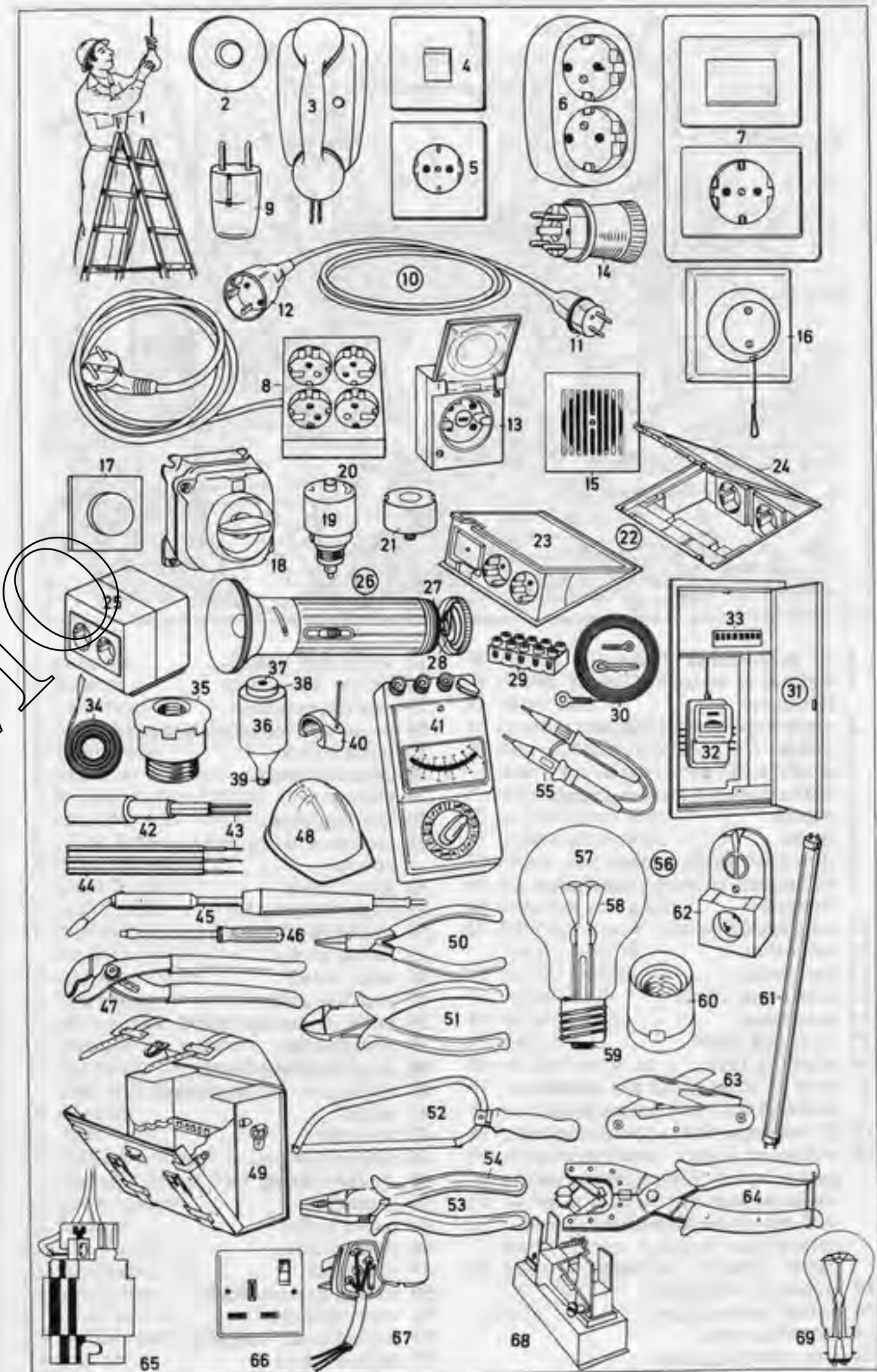

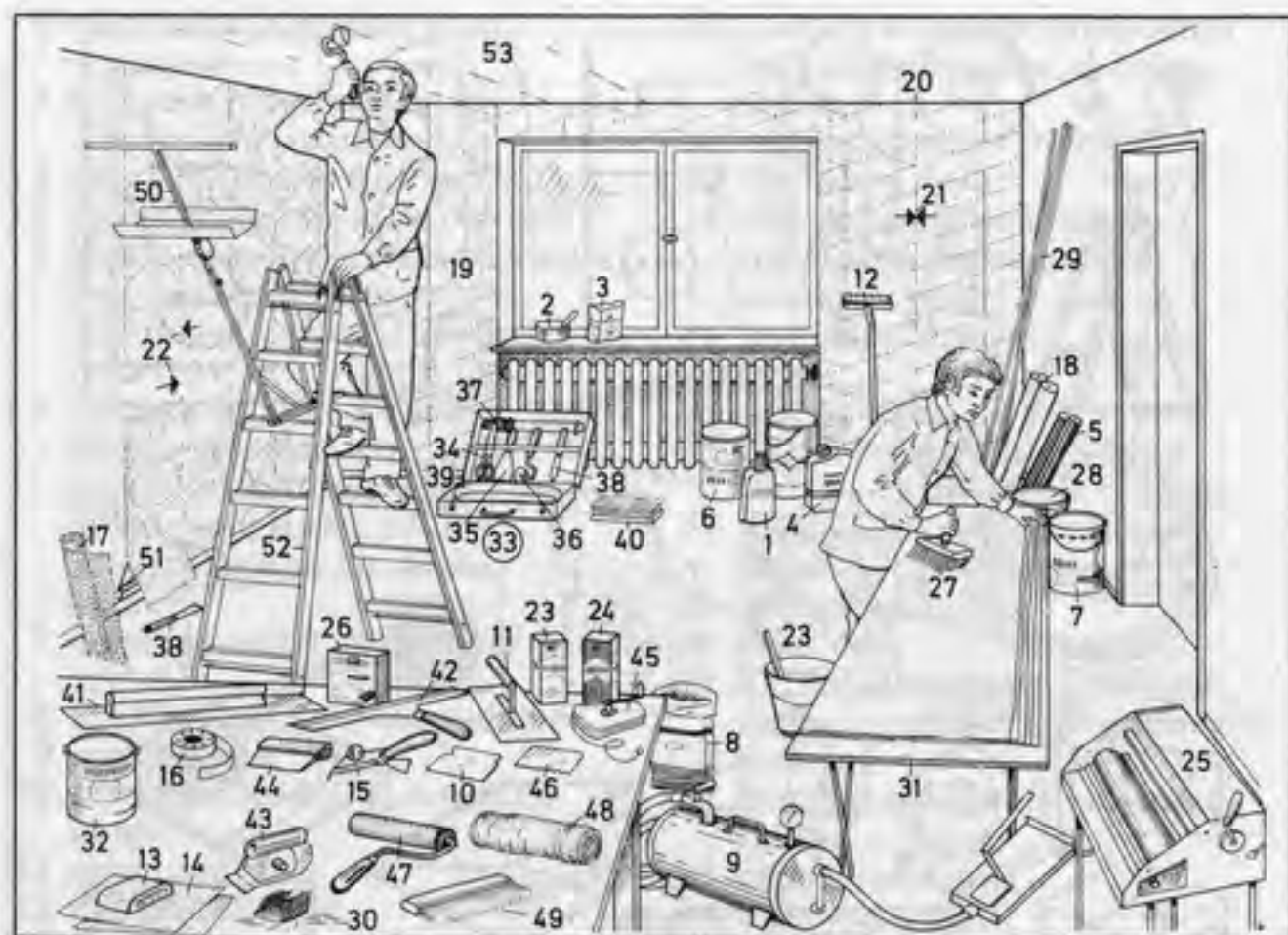
**1-17 preparation of surfaces**

- 1 wallpaper-stripping liquid (stripper)
- 2 plaster (plaster of Paris)
- 3 filler
- 4 glue size (size)
- 5 lining paper, a backing paper
- 6 primer
- 7 fluate
- 8 shredded lining paper
- 9 wallpaper-stripping machine (stripper)
- 10 scraper
- 11 smoother
- 12 perforator
- 13 sandpaper block
- 14 sandpaper
- 15 stripping knife
- 16 masking tape
- 17 strip of sheet metal [on which wallpaper is laid for cutting]
- 18-53 **wallpapering** (paper hanging)
- 18 wallpaper (*kinds*: wood pulp paper, wood chip paper, fabric wallhangings, synthetic wallpaper, metallic paper, natural (e.g. wood or cork) paper, tapestry wallpaper)
- 19 length of wallpaper
- 20 butted paper edges
- 21 matching edge
- 22 non-matching edge

- 23 wallpaper paste
- 24 heavy-duty paste
- 25 pasting machine
- 26 paste [for the pasting machine]
- 27 paste brush
- 28 emulsion paste
- 29 picture rail
- 30 beading pins
- 31 pasteboard (paperhanger's bench)
- 32 gloss finish
- 33 paperhanging kit
- 34 shears (bull-nosed scissors)
- 35 filling knife
- 36 seam roller
- 37 hacking knife
- 38 knife (trimming knife)
- 39 straightedge
- 40 paperhanging brush
- 41 wallpaper-cutting board
- 42 cutter
- 43 trimmer
- 44 plastic spatula
- 45 chalked string
- 46 spreader
- 47 paper roller
- 48 flannel cloth
- 49 dry brush
- 50 ceiling paperhanger
- 51 overlap angle
- 52 paperhanger's trestles
- 53 ceiling paper

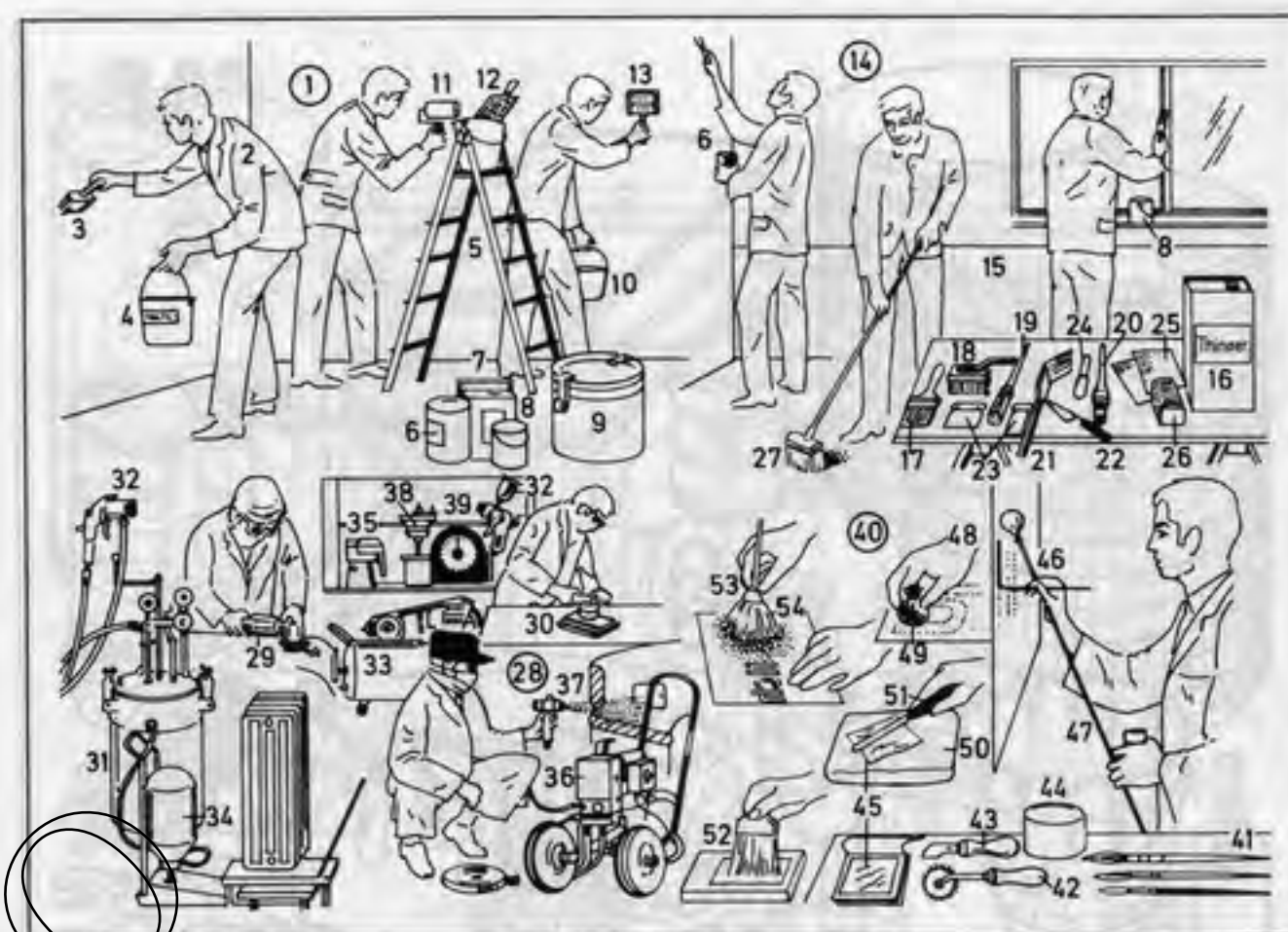

- 1 painting
- 2 painter
- 3 paintbrush
- 4 emulsion paint (emulsion)
- 5 stepladder
- 6 can (tin) of paint
- 7-8 cans (tins) of paint
- 7 can (tin) with fixed handle
- 8 paint kettle
- 9 drum of paint
- 10 paint bucket
- 11 paint roller
- 12 grill [for removing excess paint from the roller]
- 13 stippling roller
- 14 **varnishing**
- 15 oil-painted dado
- 16 canister for thinner
- 17 flat brush for larger surfaces (flat wall brush)
- 18 stippler
- 19 fitch
- 20 cutting-in brush
- 21 radiator brush (flay brush)
- 22 paint scraper
- 23 scraper
- 24 putty knife
- 25 sandpaper
- 26 sandpaper block
- 27 floor brush
- 28 sanding and spraying
- 29 grinder

- 30 sander
- 31 pressure pot
- 32 spray gun
- 33 compressor (air compressor)
- 34 flow coating machine for flow coating radiators, etc.
- 35 hand spray
- 36 airless spray unit
- 37 airless spray gun
- 38 efflux viscometer
- 39 seconds timer
- 40 **lettering and gilding**
- 41 lettering brush (signwriting brush, pencil)
- 42 tracing wheel
- 43 stencil knife
- 44 oil gold size
- 45 gold leaf
- 46 outline drawing
- 47 mahlstick
- 48 pouncing
- 49 pounce bag
- 50 gilder's cushion
- 51 gilder's knife
- 52 sizing gold leaf
- 53 filling in the letters with stipple paint
- 54 gilder's mop

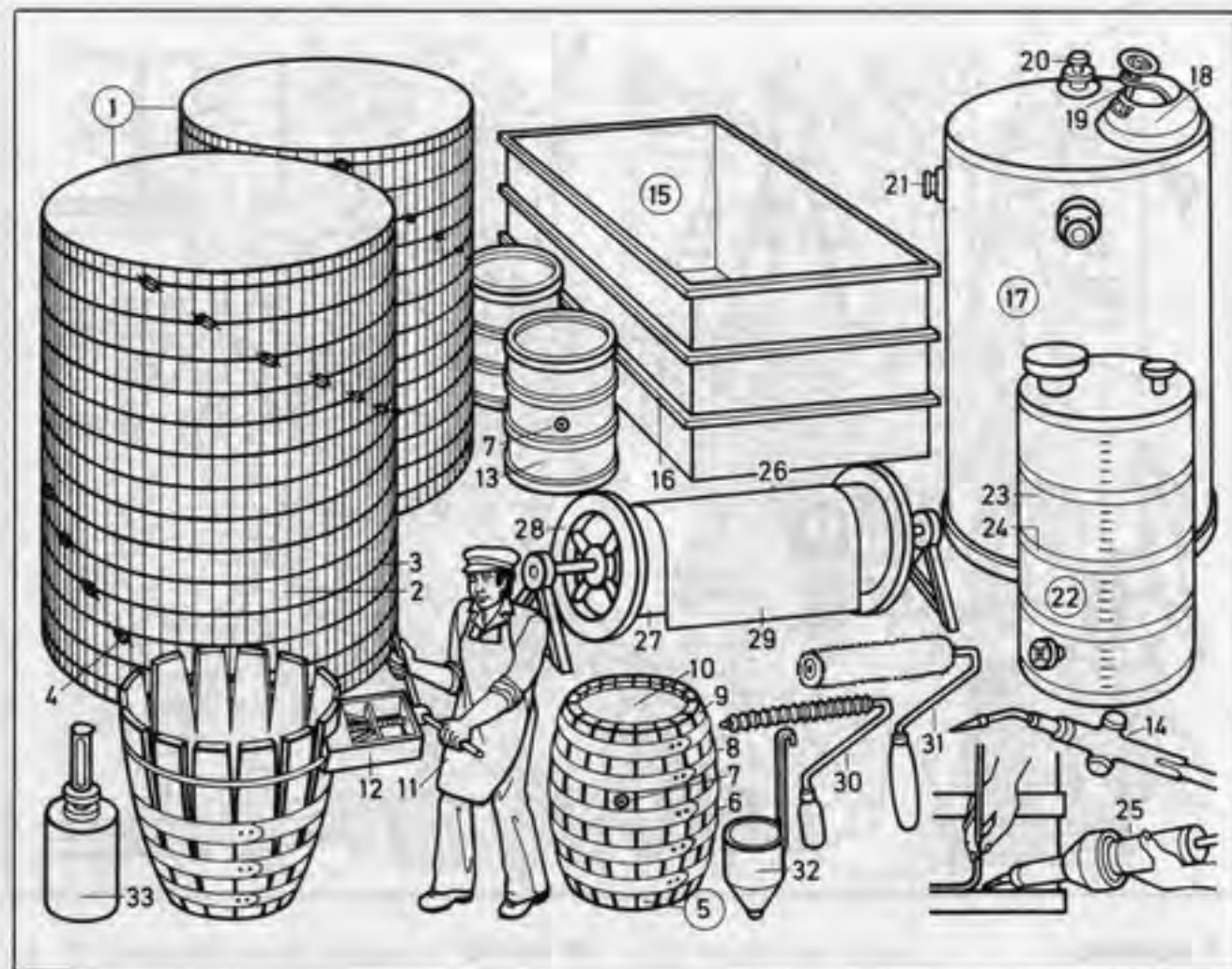

1-33 cooper's and tank construction engineer's workshops

- 1 tank
- 2 circumference made of staves (staved circumference)
- 3 iron rod
- 4 turnbuckle
- 5 barrel (cask)
- 6 body of barrel (of cask)
- 7 bunghole
- 8 band (hoop) of barrel
- 9 barrel stave
- 10 barrelhead (heading)
- 11 cooper
- 12 trusser
- 13 drum
- 14 gas welding torch
- 15 staining vat, made of thermoplastics
- 16 iron reinforcing bands
- 17 storage container, made of glass fibre (*Am.* glass fiber) reinforced polyester resin
- 18 manhole

- 19 manhole cover with handwheel
- 20 flange mount
- 21 flange-type stopcock
- 22 measuring tank
- 23 shell (circumference)
- 24 shrink ring
- 25 hot-air gun
- 26 roller made of glass fibre (*Am.* glass fiber) reinforced synthetic resin
- 27 cylinder
- 28 flange
- 29 glass cloth
- 30 grooved roller
- 31 lambskin roller
- 32 ladle for testing viscosity
- 33 measuring vessel for hardener

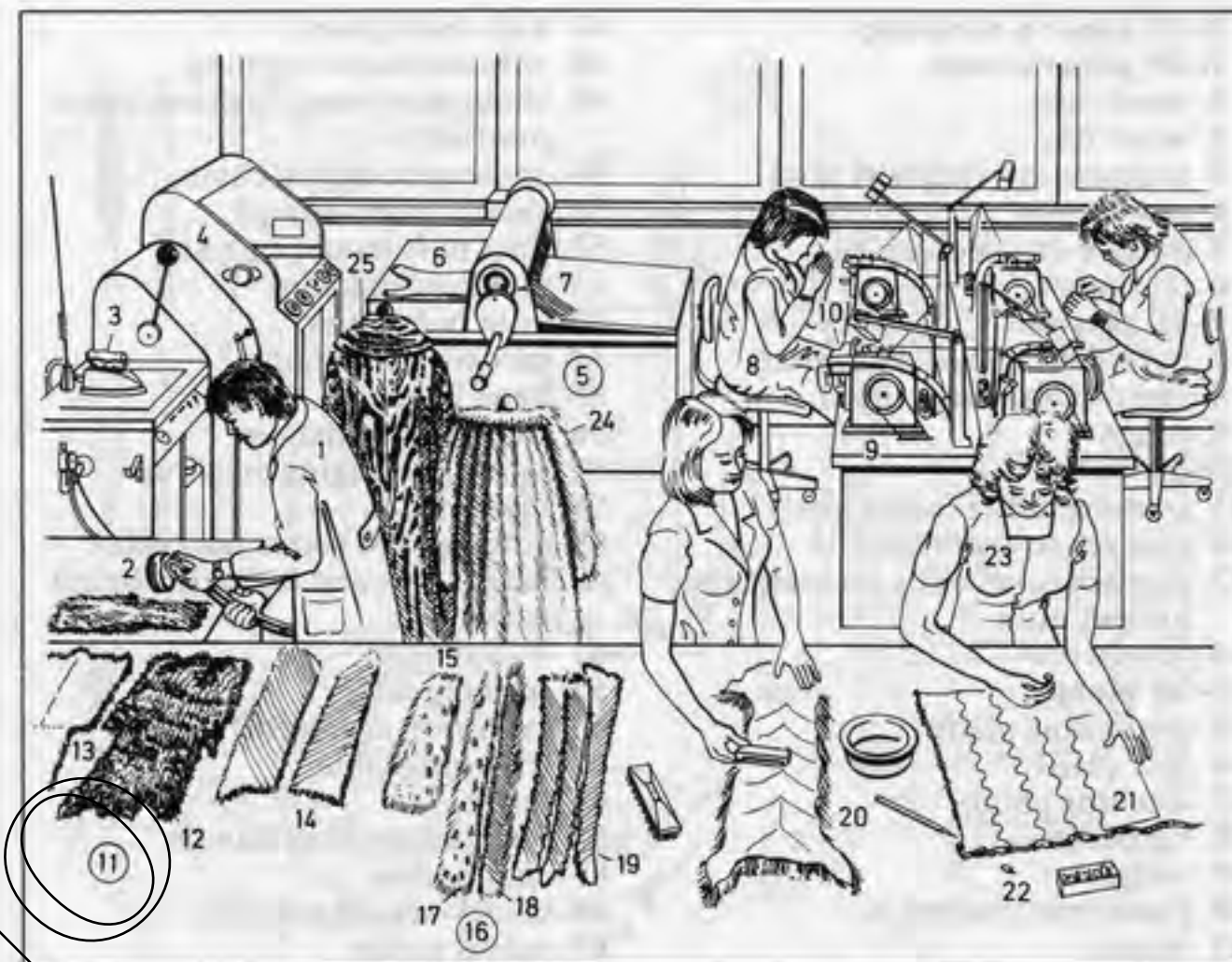

1-25 furrier's workroom

- 1 furrier
- 2 steam spray gun
- 3 steam iron
- 4 beating machine
- 5 cutting machine for letting out furskins
- 6 uncut furskin
- 7 let-out strips (let-out sections)
- 8 fur worker
- 9 fur-sewing machine
- 10 blower for letting out
- 11-21 furskins
- 11 mink skin
- 12 fur side
- 13 leather side
- 14 cut furskin
- 15 lynx skin before letting out
- 16 let-out lynx skin
- 17 fur side
- 18 leather side
- 19 let-out mink skin
- 20 lynx fur, sewn together (sewn)
- 21 broadtail

- 22 fur marker
- 23 fur worker
- 24 mink coat
- 25 ocelot coat

- 1-73 joiner's workshop
 1-28 joiner's tools
 1 wood rasp
 2 wood file
 3 compass saw (keyhole saw)
 4 saw handle
 5 [square-headed] mallet
 6 try square
 7-11 chisels
 7 bevelled-edge chisel (chisel)
 8 mortise (mortice) chisel
 9 gouge
 10 handle
 11 framing chisel (cant chisel)
 12 glue pot in water bath
 13 glue pot (glue well), an insert for joiner's glue
 14 handscrew
 15-28 planes
 15 smoothing plane
 16 jack plane
 17 tothing plane
 18 handle (toat)
 19 wedge
 20 plane iron (cutter)
 21 mouth
 22 sole
 23 side
 24 stock (body)
 25 rebate (rabbet) plane
 26 router plane (old woman's tooth)
 27 spokeshave
 28 compass plane
 29-37 woodworker's bench
 29 foot
 30 front vice (Am. vise)
 31 vice (Am. vise) handle
 32 vice (Am. vise) screw
 33 jaw
 34 bench top
 35 well
 36 bench stop (bench holdfast)
 37 tail vice (Am. vise)
 38 cabinet maker (joiner)
 39 trying plane
 40 shavings
 41 wood screw
 42 saw set
 43 mitre (Am. miter) box
 44 tenon saw
 45 thicknesser (thicknessing machine)
 46 thicknessing table with rollers
 47 kick-back guard
 48 chip-extractor opening
 49 chain mortising machine (chain mortiser)
 50 endless mortising chain
 51 clamp (work clamp)
 52 knot hole moulding (Am. molding) machine
 53 knot hole cutter
 54 quick-action chuck
 55 hand lever
 56 change-gear handle
 57 sizing and edging machine
 58 main switch
 59 circular-saw (buzz saw) blade
 60 height (rise and fall) adjustment wheel
 61 V-way
 62 framing table
 63 extension arm (arm)
 64 trimming table
 65 fence
 66 fence adjustment handle
 67 clamp lever
 68 board-sawing machine
 69 swivel motor
 70 board support
 71 saw carriage
 72 pedal for raising the transport rollers
 73 block board

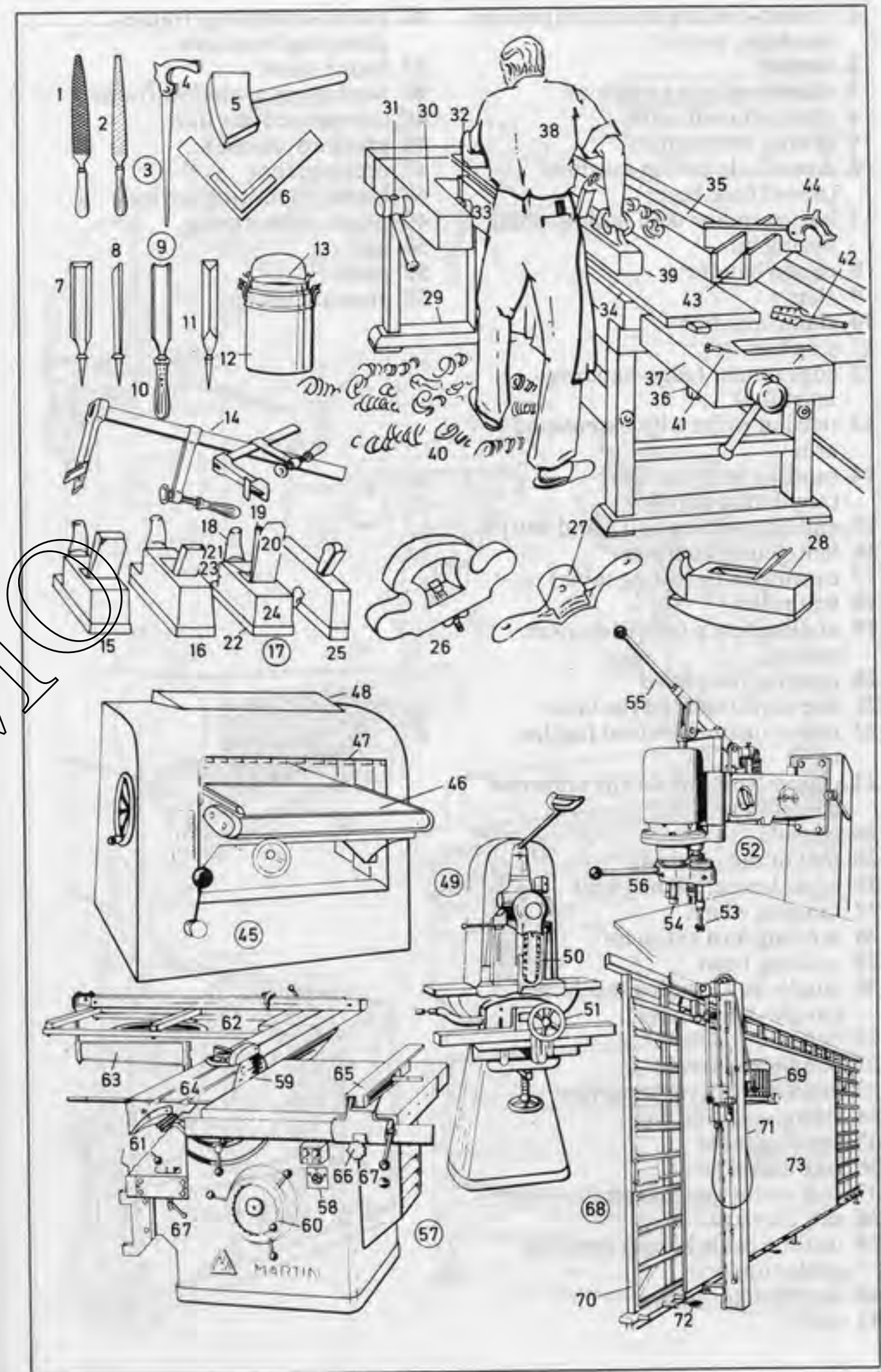

- | | |
|---|--|
| 1 veneer-peeling machine (peeling machine, peeler) | 42 frame-cramping (frame-clamping) machine |
| 2 veneer | 43 frame stand |
| 3 veneer-splicing machine | 44 workpiece, a window frame |
| 4 nylon-thread cop | 45 compressed-air line |
| 5 sewing mechanism | 46 pressure cylinder |
| 6 dowel hole boring machine (dowel hole borer) | 47 pressure foot |
| 7 boring motor with hollow-shaft boring bit | 48 frame-mounting device |
| 8 clamp handle | 49 rapid-veneer press |
| 9 clamp | 50 bed |
| 10 clamping shoe | 51 press |
| 11 stop bar | 52 pressure piston |
| 12 edge sander (edge-sanding machine) | |
| 13 tension roller with extension arm | |
| 14 sanding belt regulator (regulating handle) | |
| 15 endless sanding belt (sand belt) | |
| 16 belt-tensioning lever | |
| 17 canting table (tilting table) | |
| 18 belt roller | |
| 19 angling fence for mitres (Am. miters) | |
| 20 opening dust hood | |
| 21 rise adjustment of the table | |
| 22 rise adjustment wheel for the table | |
| 23 clamping screw for the table rise adjustment | |
| 24 console | |
| 25 foot of the machine | |
| 26 edge-veneering machine | |
| 27 sanding wheel | |
| 28 sanding dust extractor | |
| 29 splicing head | |
| 30 single-belt sanding machine (single-belt sander) | |
| 31 belt guard | |
| 32 bandwheel cover | |
| 33 extractor fan (exhaust fan) | |
| 34 frame-sanding pad | |
| 35 sanding table | |
| 36 fine adjustment | |
| 37 fine cutter and jointer | |
| 38 saw carriage | |
| 39 trailing cable hanger (trailing cable support) | |
| 40 air extractor pipe | |
| 41 rail | |

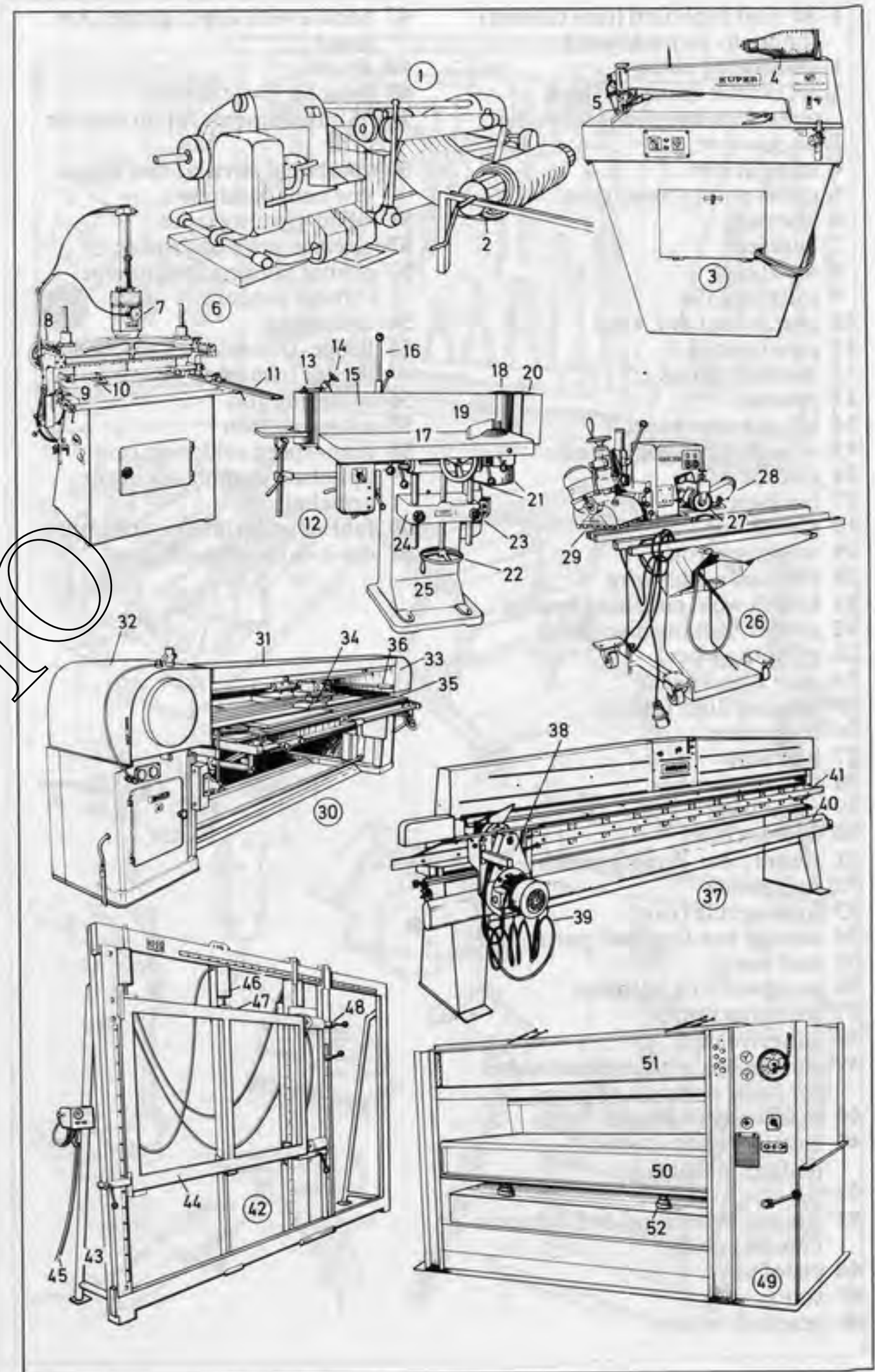

- 1-34 tool cupboard (tool cabinet) for do-it-yourself work
- 1 smoothing plane
 - 2 set of fork spanners (fork wrenches, open-end wrenches)
 - 3 hacksaw
 - 4 screwdriver
 - 5 cross-point screwdriver
 - 6 saw rasp
 - 7 hammer
 - 8 wood rasp
 - 9 roughing file
 - 10 small vice (*Am. vise*)
 - 11 pipe wrench
 - 12 multiple pliers
 - 13 pincers
 - 14 all-purpose wrench
 - 15 wire stripper and cutter
 - 16 electric drill
 - 17 hacksaw
 - 18 plaster cup
 - 19 soldering iron
 - 20 tin-lead solder wire
 - 21 lamb's wool polishing bonnet
 - 22 rubber backing disc (disk)
 - 23 grinding wheel
 - 24 wire wheel brush
 - 25 sanding discs (disks)
 - 26 try square
 - 27 hand saw
 - 28 universal cutter
 - 29 spirit level
 - 30 firmer chisel
 - 31 centre (*Am. center*) punch
 - 32 nail punch
 - 33 folding rule (rule)
 - 34 storage box for small parts
 - 35 tool box
 - 36 woodworking adhesive
 - 37 stripping knife
 - 38 adhesive tape
 - 39 storage box with compartments for nails, screws, and plugs
 - 40 machinist's hammer
 - 41 collapsible workbench (collapsible bench)
 - 42 jig
 - 43 electric percussion drill (electric hammer drill)
 - 44 pistol grip
 - 45 side grip
 - 46 gearshift switch
 - 47 handle with depth gauge (*Am. gage*)
 - 48 chuck
 - 49 twist bit (twist drill)
 - 50-55 attachments for an electric drill
 - 50 combined circular saw (buzz saw) and bandsaw
 - 51 wood-turning lathe
 - 52 circular saw attachment
 - 53 orbital sanding attachment (orbital sander)
 - 54 drill stand
 - 55 hedge-trimming attachment (hedge trimmer)
 - 56 soldering gun
 - 57 soldering iron
 - 58 high-speed soldering iron
 - 59 upholstery, upholstering an armchair
 - 60 fabric (material) for upholstery
 - 61 do-it-yourself enthusiast

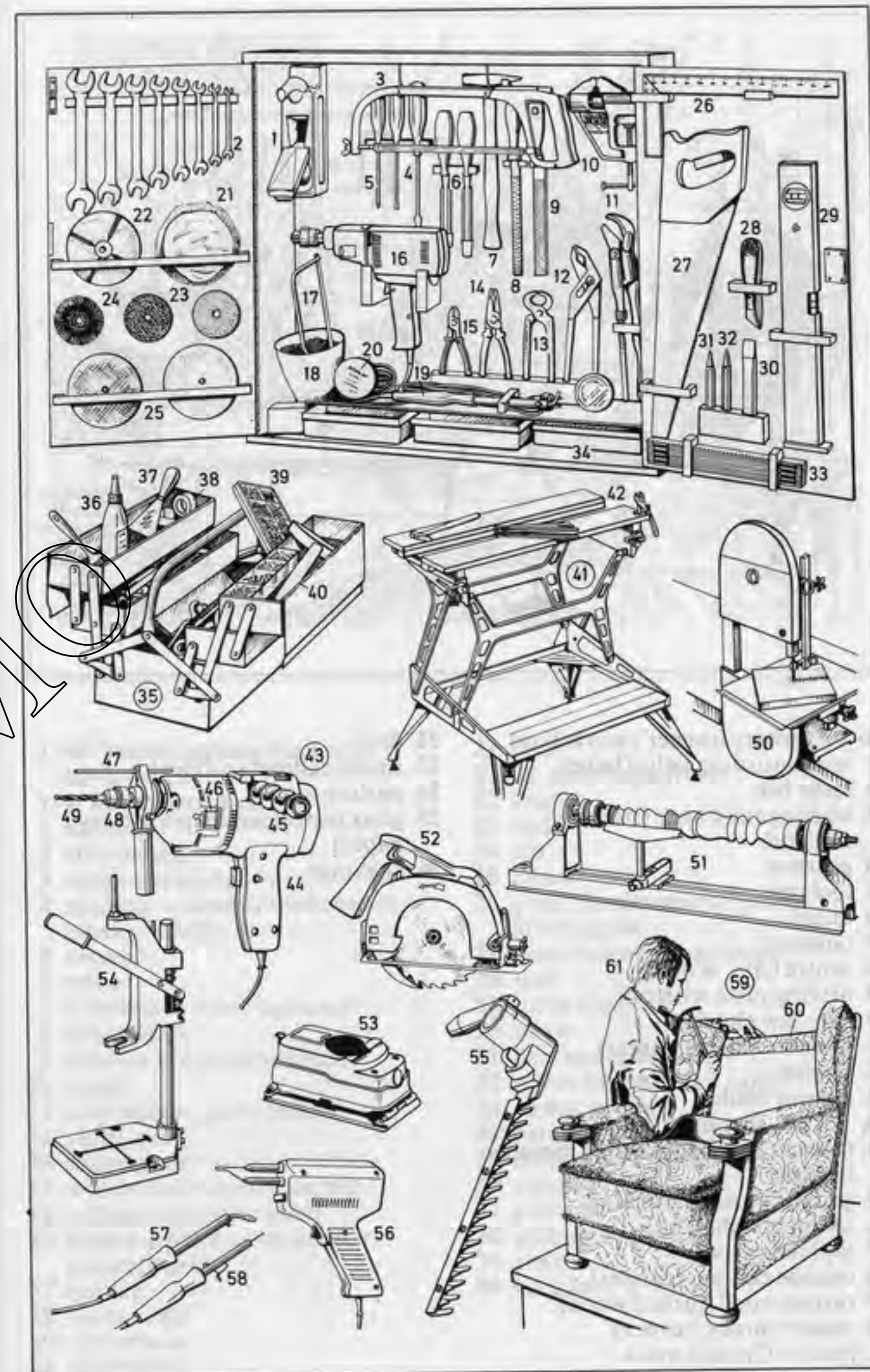

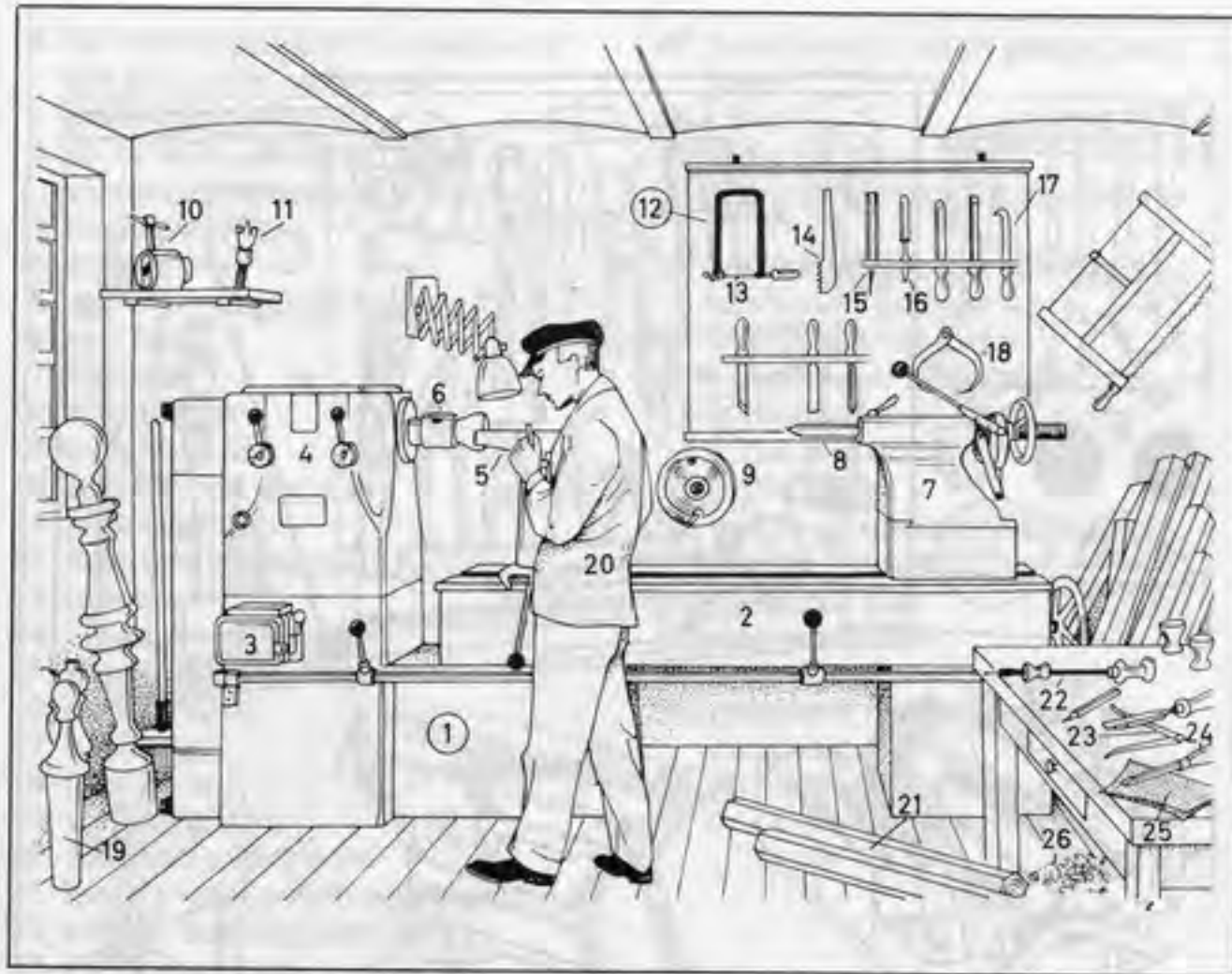

- 1-26 turnery (turner's workshop)**
- 1 wood-turning lathe (lathe)
 - 2 lathe bed
 - 3 starting resistance (starting resistor)
 - 4 gearbox
 - 5 tool rest
 - 6 chuck
 - 7 tailstock
 - 8 centre (*Am.* center)
 - 9 driving plate with pin
 - 10 two-jaw chuck
 - 11 live centre (*Am.* center)
 - 12 fretsaw
 - 13 fretsaw blade
 - 14, 15, 24 turning tools
 - 14 thread chaser, for cutting threads in wood
 - 15 gouge, for rough turning
 - 16 spoon bit (shell bit)
 - 17 hollowing tool
 - 18 outside calliper (caliper)
 - 19 turned work (turned wood)
 - 20 master turner (turner)
 - 21 [piece of] rough wood
 - 22 drill
 - 23 inside calliper (caliper)
 - 24 parting tool
 - 25 glass paper (sandpaper, emery paper)
 - 26 shavings



- 1-40 basket making (basketry, basketwork)**
- 1-4 weaves (strokes)
 - 1 randing
 - 2 rib randing
 - 3 oblique randing
 - 4 randing, a piece of wickerwork (screen work)
 - 5 weaver
 - 6 stake
 - 7 workboard; *also*: lapboard
 - 8 screw block
 - 9 hole for holding the block
 - 10 stand
 - 11 chip basket (spale basket)
 - 12 chip (spale)
 - 13 soaking tub
 - 14 willow stakes (osier stakes)
 - 15 willow rods (osier rods)
 - 16 basket, a piece of wickerwork (basketwork)
 - 17 border
 - 18 woven side
 - 19 round base
 - 20 woven base
 - 21 slath
 - 22-24 covering a frame
 - 22 frame
 - 23 end
 - 24 rib
 - 25 upsett
 - 26 grass; *kinds*: esparto grass, alfalfa grass
 - 27 rush (bulrush, reed mace)
 - 28 reed
 - 29 raffia (bast)
 - 30 straw
 - 31 bamboo cane
 - 32 rattan (ratan) chair cane
 - 33 basket maker
 - 34 bending tool
 - 35 cutting point (bodkin)
 - 36 rapping iron
 - 37 pincers
 - 38 picking knife
 - 39 shave
 - 40 hacksaw

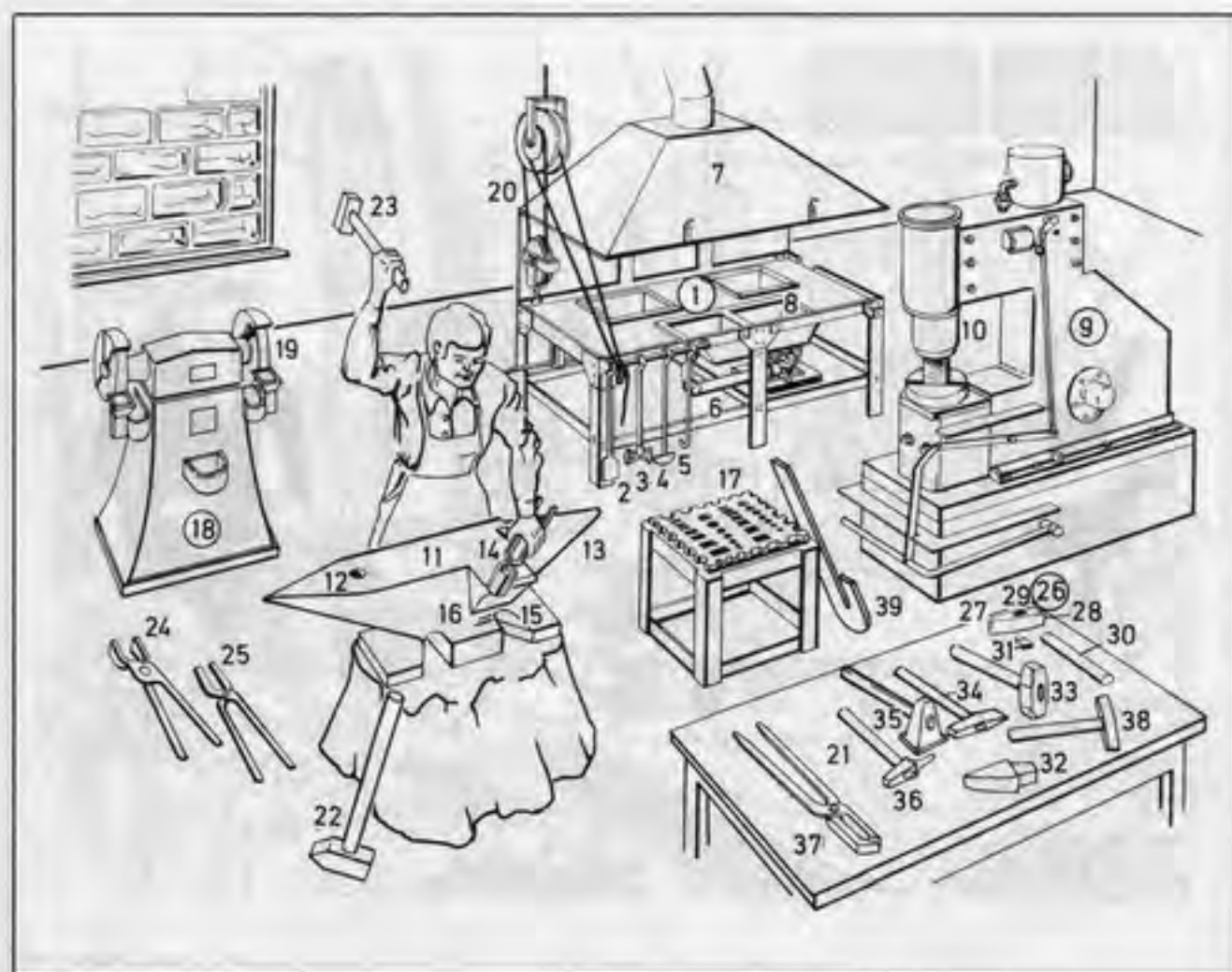

1-8 hearth (forge) with blacksmith's fire

- 1 hearth (forge)
- 2 shovel (slice)
- 3 swab
- 4 rake
- 5 poker
- 6 blast pipe (tue iron)
- 7 chimney (cowl, hood)
- 8 water trough (quenching trough, bosh)
- 9 power hammer
- 10 ram (tup)
- 11-16 anvil**
- 11 anvil
- 12 flat beak (beck, bick)
- 13 round beak (beck, bick)
- 14 auxiliary table
- 15 foot
- 16 upsetting block
- 17 swage block
- 18 tool-grinding machine (tool grinder)
- 19 grinding wheel
- 20 block and tackle

21 workbench (bench)
22-39 blacksmith's tools

- 22 sledge hammer
- 23 blacksmith's hand hammer
- 24 flat tongs
- 25 round tongs
- 26 parts of the hammer
- 27 peen (pane, pein)
- 28 face
- 29 eye
- 30 haft
- 31 cotter punch
- 32 hardy (hardie)
- 33 set hammer
- 34 sett (set, sate)
- 35 flat-face hammer (flatter)
- 36 round punch
- 37 angle tongs
- 38 blacksmith's chisel (scaling hammer, chipping hammer)
- 39 moving iron (bending iron)

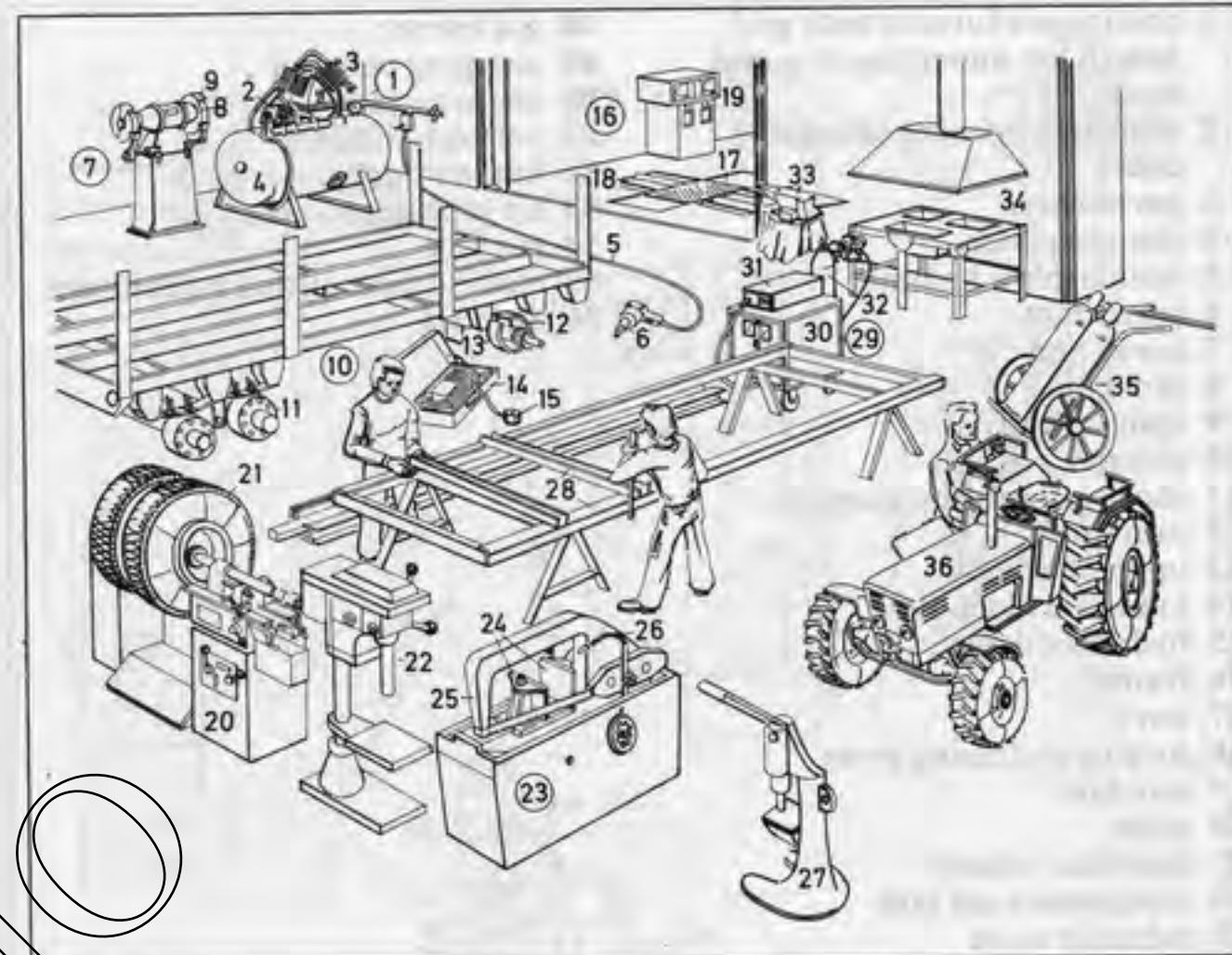

- 1 compressed-air system
- 2 electric motor
- 3 compressor
- 4 compressed-air tank
- 5 compressed-air line
- 6 percussion screwdriver
- 7 pedestal grinding machine (floor grinding machine)
- 8 grinding wheel
- 9 guard
- 10 trailer
- 11 brake drum
- 12 brake shoe
- 13 brake lining
- 14 testing kit
- 15 pressure gauge (*Am. gage*)
- 16 brake-testing equipment, a rolling road
- 17 pit
- 18 braking roller
- 19 meter (recording meter)
- 20 precision lathe for brake drums
- 21 lorry wheel
- 22 boring mill

- 23 power saw, a hacksaw (power hacksaw)
- 24 vice (*Am. vise*)
- 25 saw frame
- 26 coolant supply pipe
- 27 riveting machine
- 28 trailer frame (chassis) under construction
- 29 inert-gas welding equipment
- 30 rectifier
- 31 control unit
- 32 CO₂ cylinder
- 33 anvil
- 34 hearth (forge) with blacksmith's fire
- 35 trolley for gas cylinders
- 36 vehicle under repair, a tractor

- 1 continuous furnace with grid hearth for annealing of round stock
- 2 discharge opening (discharge door)
- 3 gas burners
- 4 charging door
- 5 counterblow hammer
- 6 upper ram
- 7 lower ram
- 8 ram guide
- 9 hydraulic drive
- 10 column
- 11 short-stroke drop hammer
- 12 ram (tup)
- 13 upper die block
- 14 lower die block
- 15 hydraulic drive
- 16 frame
- 17 anvil
- 18 forging and sizing press
- 19 standard
- 20 table
- 21 disc (disk) clutch
- 22 compressed-air pipe
- 23 solenoid valve
- 24 air-lift gravity hammer (air-lift drop hammer)
- 25 drive motor
- 26 hammer (tup)
- 27 foot control (foot pedal)
- 28 preshaped (blocked) workpiece
- 29 hammer guide
- 30 hammer cylinder
- 31 anvil
- 32 mechanical manipulator to move the workpiece in hammer forging
- 33 dogs
- 34 counterweight
- 35 hydraulic forging press
- 36 crown
- 37 cross head
- 38 upper die block
- 39 lower die block
- 40 anvil
- 41 hydraulic piston
- 42 pillar guide
- 43 rollover device
- 44 burden chain (chain sling)
- 45 crane hook
- 46 workpiece
- 47 gas furnace (gas-fired furnace)

- 48 gas burner
- 49 charging opening
- 50 chain curtain
- 51 vertical-lift door
- 52 hot-air duct
- 53 air preheater
- 54 gas pipe
- 55 electric door-lifting mechanism
- 56 air blast

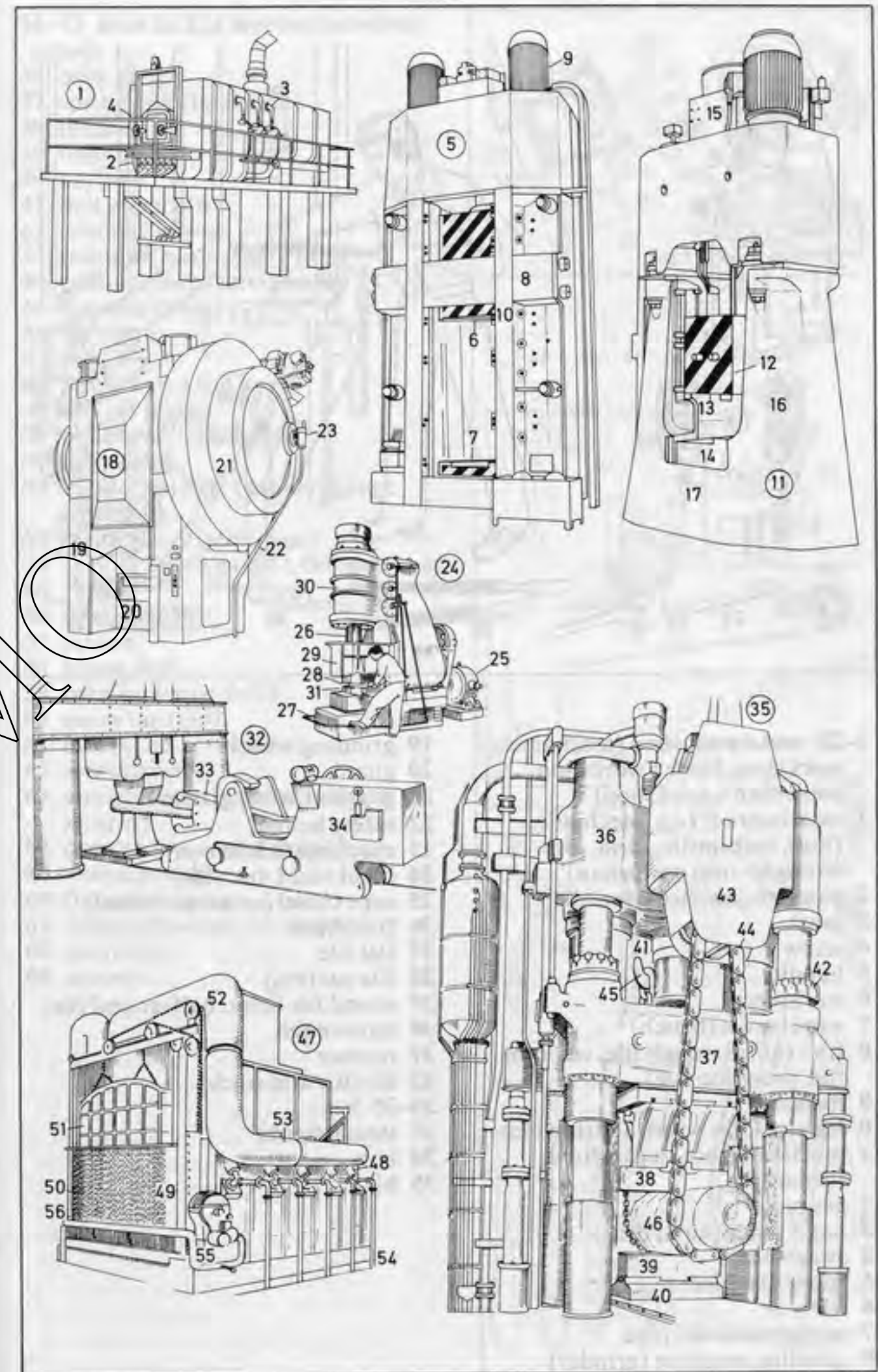

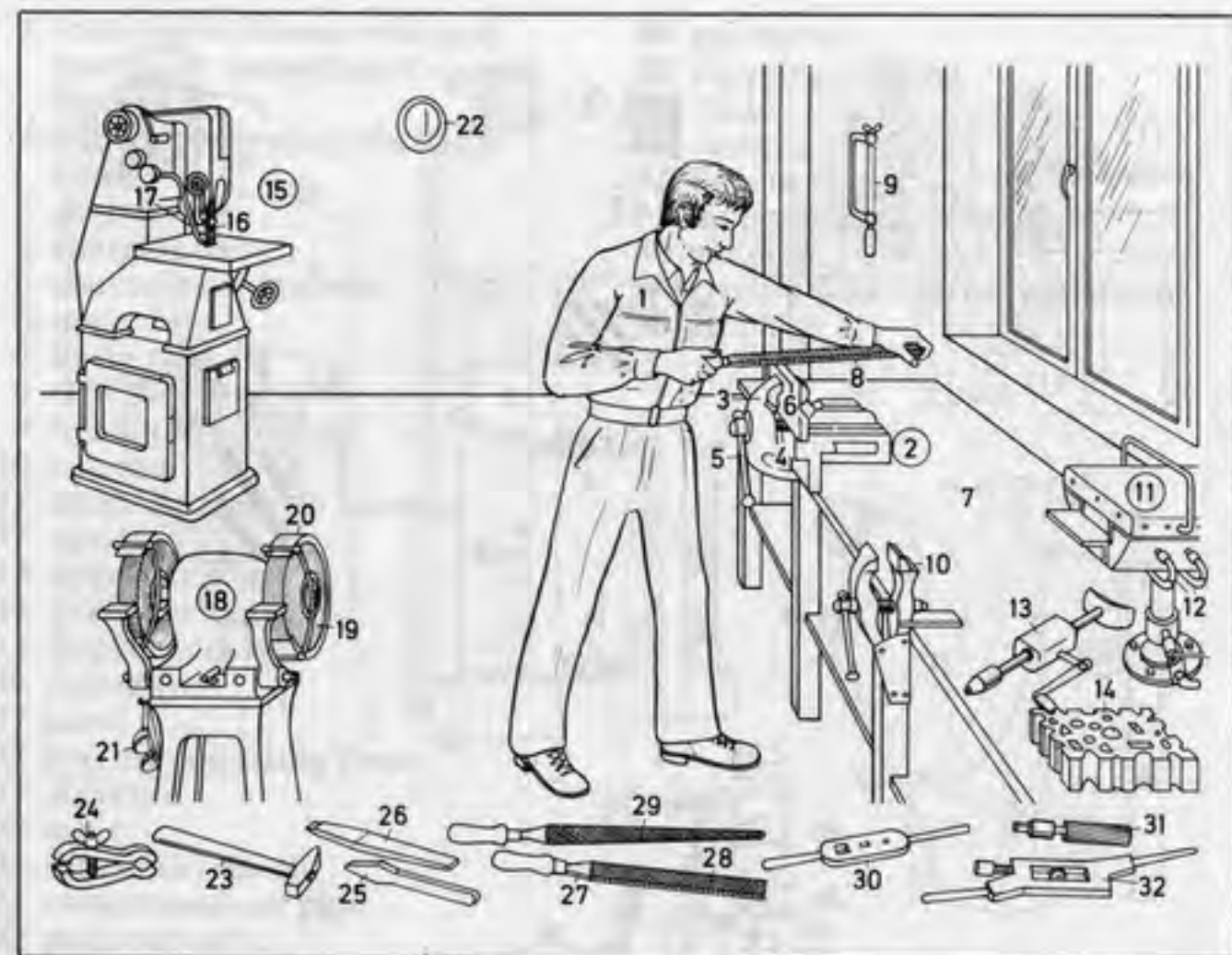

1-22 metalwork shop (mechanic's workshop, fitter's workshop, locksmith's workshop)

- 1 metalworker (e.g. mechanic, fitter, locksmith; *form. also:* wrought-iron craftsman)
- 2 parallel-jaw vice (*Am. vise*)
- 3 jaw
- 4 screw
- 5 handle
- 6 workpiece
- 7 workbench (bench)
- 8 files (*kinds:* rough file, smooth file, precision file)
- 9 hacksaw
- 10 leg vice (*Am. vise*), a spring vice
- 11 muffle furnace, a gas-fired furnace
- 12 gas pipe
- 13 hand brace (hand drill)
- 14 swage block
- 15 filing machine
- 16 file
- 17 compressed-air pipe
- 18 grinding machine (grinder)

- 19 grinding wheel
- 20 guard
- 21 goggles (safety glasses)
- 22 safety helmet
- 23 machinist's hammer
- 24 hand vice (*Am. vise*)
- 25 cape chisel (cross-cut chisel)
- 26 flat chisel
- 27 flat file
- 28 file cut (cut)
- 29 round file (*also:* half-round file)
- 30 tap wrench
- 31 reamer
- 32 die (die and stock)
- 33-35 key**
- 33 stem (shank)
- 34 bow
- 35 bit

36-43 door lock, a mortise (mortice) lock

- 36 back plate
- 37 spring bolt (latch bolt)
- 38 tumbler
- 39 bolt
- 40 keyhole
- 41 bolt guide pin
- 42 tumbler spring
- 43 follower, with square hole
- 44 cylinder lock (safety lock)
- 45 cylinder (plug)
- 46 spring
- 47 pin
- 48 safety key, a flat key
- 49 lift-off hinge
- 50 hook-and-ride band
- 51 strap hinge
- 52 vernier calliper (caliper) gauge (*Am. gage*)
- 53 feeler gauge (*Am. gage*)
- 54 vernier depth gauge (*Am. gage*)
- 55 vernier
- 56 straightedge
- 57 square
- 58 breast drill
- 59 twist bit (twist drill)
- 60 screw tap (tap)
- 61 halves of a screw die
- 62 screwdriver
- 63 scraper (*also:* pointed triangle scraper)
- 64 centre (*Am. center*) punch
- 65 round punch
- 66 flat-nose pliers
- 67 detachable-jaw cut nippers
- 68 gas pliers
- 69 pincers

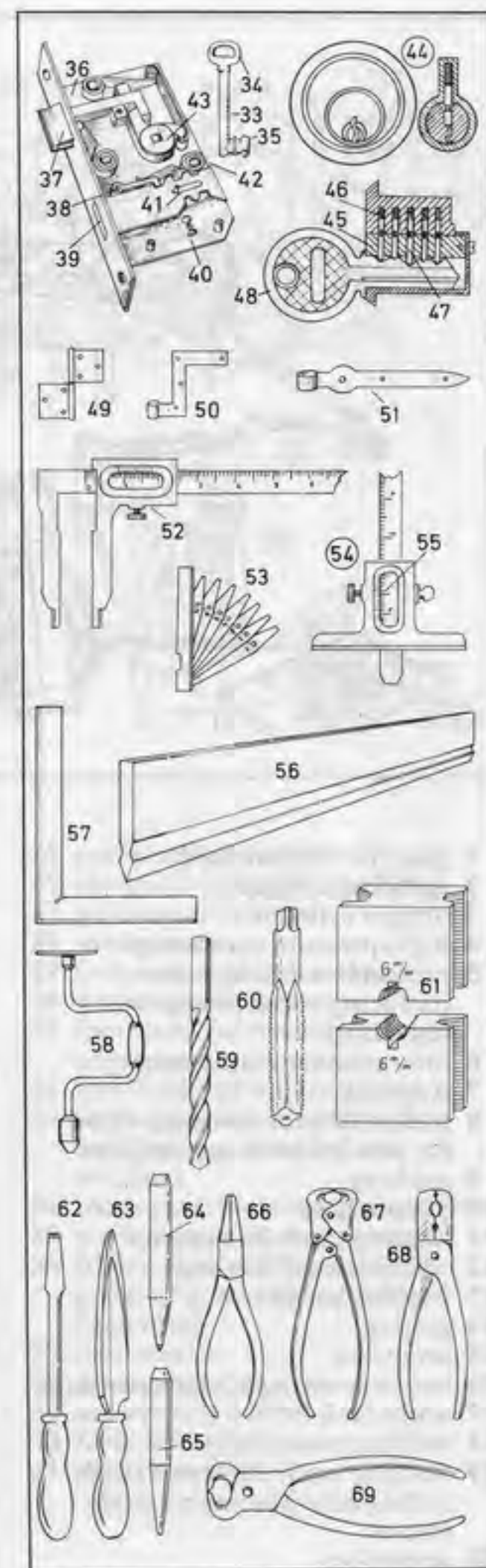

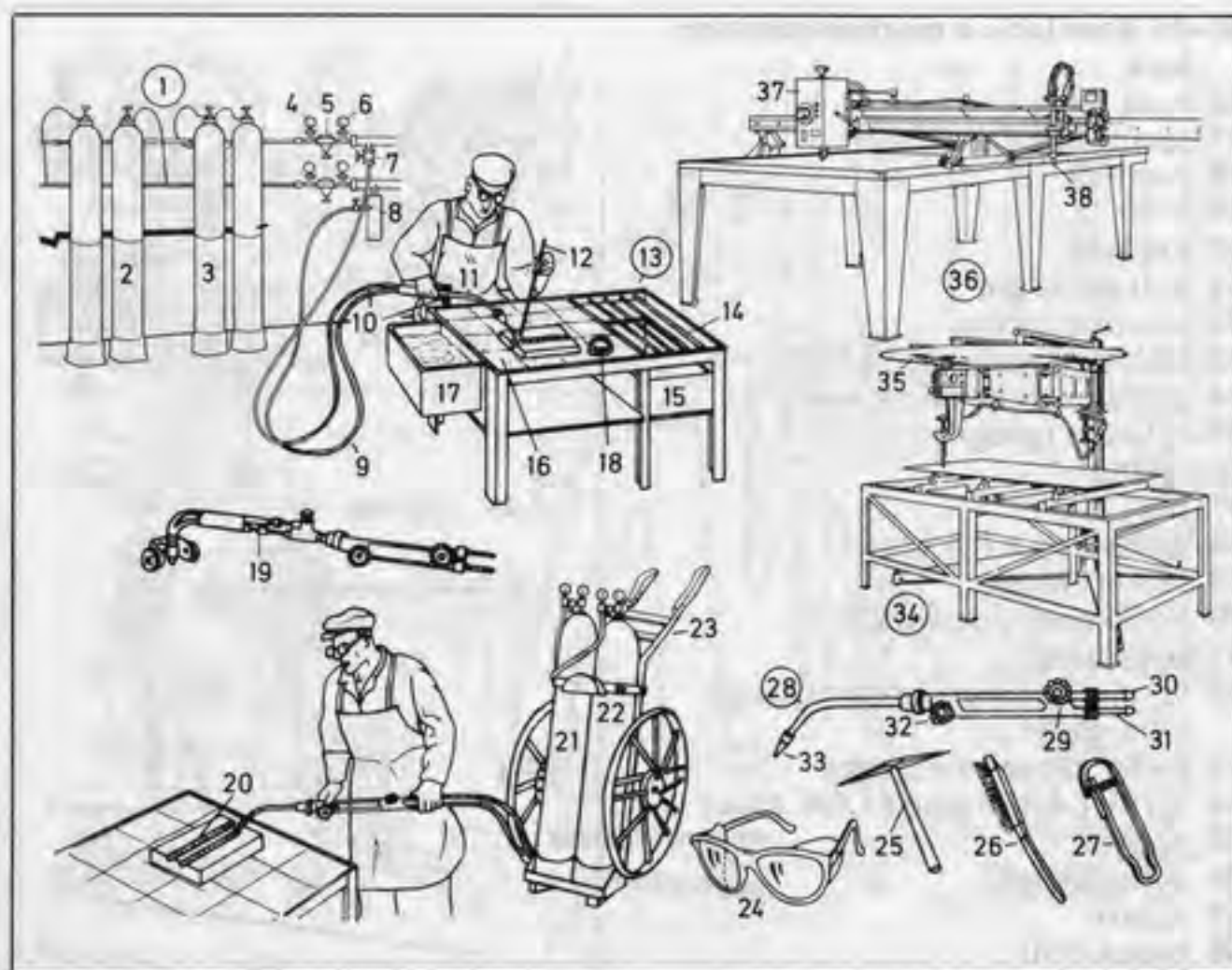

- 1 gas cylinder manifold
- 2 acetylene cylinder
- 3 oxygen cylinder
- 4 high-pressure manometer
- 5 pressure-reducing valve (reducing valve, pressure regulator)
- 6 low-pressure manometer
- 7 stopcock
- 8 hydraulic back-pressure valve for low-pressure installations
- 9 gas hose
- 10 oxygen hose
- 11 welding torch (blowpipe)
- 12 welding rod (filler rod)
- 13 welding bench
- 14 grating
- 15 scrap box
- 16 bench covering of chamotte slabs
- 17 water tank
- 18 welding paste (flux)
- 19 welding torch (blowpipe) with cutting attachment and guide tractor
- 20 workpiece

- 21 oxygen cylinder
- 22 acetylene cylinder
- 23 cylinder trolley
- 24 welding goggles
- 25 chipping hammer
- 26 wire brush
- 27 torch lighter (blowpipe lighter)
- 28 welding torch (blowpipe)
- 29 oxygen control
- 30 oxygen connection
- 31 gas connection (acetylene connection)
- 32 gas control (acetylene control)
- 33 welding nozzle
- 34 cutting machine
- 35 circular template
- 36 universal cutting machine
- 37 tracing head
- 38 cutting nozzle

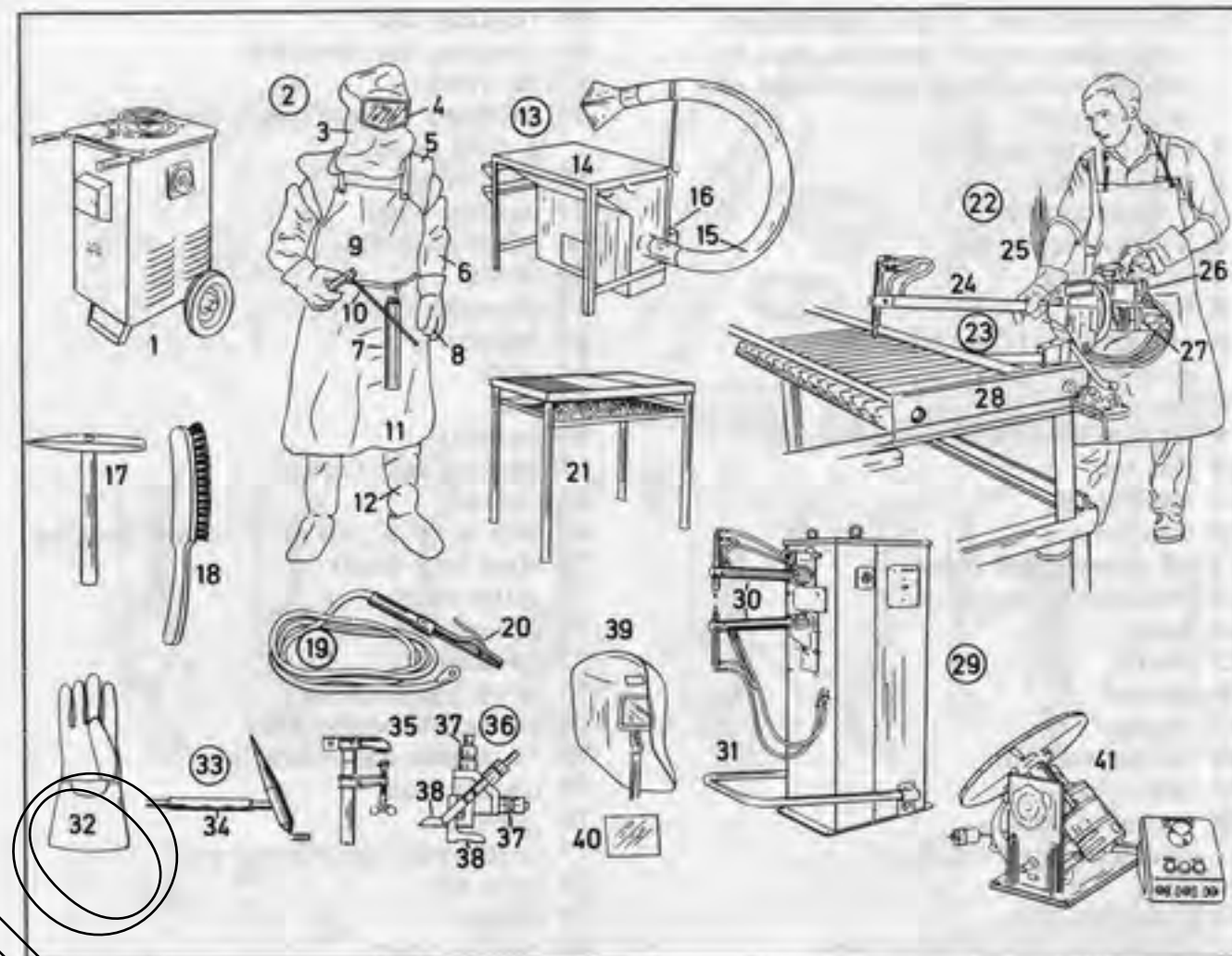

- 1 welding transformer
- 2 arc welder
- 3 arc welding helmet
- 4 flip-up window
- 5 shoulder guard
- 6 protective sleeve
- 7 electrode case
- 8 three-fingered welding glove
- 9 electrode holder
- 10 electrode
- 11 leather apron
- 12 shin guard
- 13 welding table with fume extraction equipment
- 14 table top
- 15 movable extractor duct
- 16 extractor support
- 17 chipping hammer
- 18 wire brush
- 19 welding lead
- 20 electrode holder
- 21 welding bench
- 22 spot welding
- 23 spot welding electrode holder
- 24 electrode arm

- 25 power supply (lead)
- 26 electrode-pressure cylinder
- 27 welding transformer
- 28 workpiece
- 29 foot-operated spot welder
- 30 welder electrode arms
- 31 foot pedal for welding pressure adjustment
- 32 five-fingered welding glove
- 33 inert-gas torch for inert-gas welding (gas-shielded arc welding)
- 34 inert-gas (shielding-gas) supply
- 35 work clamp (earthing clamp)
- 36 fillet gauge (*Am. gage*) (weld gauge) [for measuring throat thickness]
- 37 micrometer
- 38 measuring arm
- 39 arc welding helmet
- 40 filter lens
- 41 small turntable

[material: steel, brass, aluminium (Am. aluminum), plastics, etc.; in the following, steel was chosen as an example]

- 1 angle iron (angle)
- 2 leg (flange)
- 3-7 steel girders
- 3 T-iron (tee-iron)
- 4 vertical leg
- 5 flange
- 6 H-girder (H-beam)
- 7 E-channel (channel iron)
- 8 round bar
- 9 square iron (Am. square stock)
- 10 flat bar
- 11 strip steel
- 12 iron wire
- 13-50 screws and bolts
- 13 hexagonal-head bolt
- 14 head
- 15 shank
- 16 thread
- 17 washer
- 18 hexagonal nut
- 19 split pin
- 20 rounded end
- 21 width of head (of flats)
- 22 stud
- 23 point (end)
- 24 castle nut (castellated nut)
- 25 hole for the split pin
- 26 cross-head screw, a sheet-metal screw (self-tapping screw)
- 27 hexagonal socket head screw
- 28 countersunk-head bolt
- 29 catch
- 30 locknut (locking nut)
- 31 bolt (pin)
- 32 collar-head bolt
- 33 set collar (integral collar)
- 34 spring washer (washer)
- 35 round nut, an adjusting nut
- 36 cheese-head screw, a slotted screw
- 37 tapered pin
- 38 screw slot (screw slit, screw groove)
- 39 square-head bolt
- 40 grooved pin, a cylindrical pin
- 41 T-head bolt
- 42 wing nut (fly nut, butterfly nut)
- 43 rag bolt
- 44 barb
- 45 wood screw
- 46 countersunk head
- 47 wood screw thread
- 48 grub screw
- 49 pin slot (pin slit, pin groove)
- 50 round end
- 51 nail (wire nail)
- 52 head
- 53 shank
- 54 point

- 55 roofing nail
- 56 riveting (lap riveting)
- 57-60 rivet
- 57 set head (swage head, die head), a rivet head
- 58 rivet shank
- 59 closing head
- 60 pitch of rivets
- 61 shaft
- 62 chamfer (bevel)
- 63 journal
- 64 neck
- 65 seat
- 66 keyway
- 67 conical seat (cone)
- 68 thread
- 69 ball bearing, an antifriction bearing
- 70 steel ball (ball)
- 71 outer race
- 72 inner race
- 73-74 keys
- 73 sunk key (feather)
- 74 gib (gib-headed key)
- 75-76 needle roller bearing
- 75 needle cage
- 76 needle
- 77 castle nut (castellated nut)
- 78 split pin
- 79 casing
- 80 casing cover
- 81 grease nipple (lubricating nipple)
- 82-96 gear wheels, cog wheels
- 82 stepped gear wheel
- 83 cog (tooth)
- 84 space between teeth
- 85 keyway (key seat, key slot)
- 86 bore
- 87 herringbone gear wheel
- 88 spokes (arms)
- 89 helical gearing (helical spur wheel)
- 90 sprocket
- 91 bevel gear wheel (bevel wheel)
- 92-93 spiral tothing
- 92 pinion
- 93 crown wheel
- 94 epicyclic gear (planetary gear)
- 95 internal tothing
- 96 external tothing
- 97-107 absorption dynamometer
- 97 shoe brake (check brake, block brake)
- 98 brake pulley
- 99 brake shaft (brake axle)
- 100 brake block (brake shoe)
- 101 pull rod
- 102 brake magnet
- 103 brake weight
- 104 band brake
- 105 brake band
- 106 brake lining
- 107 adjusting screw, for even application of the brake

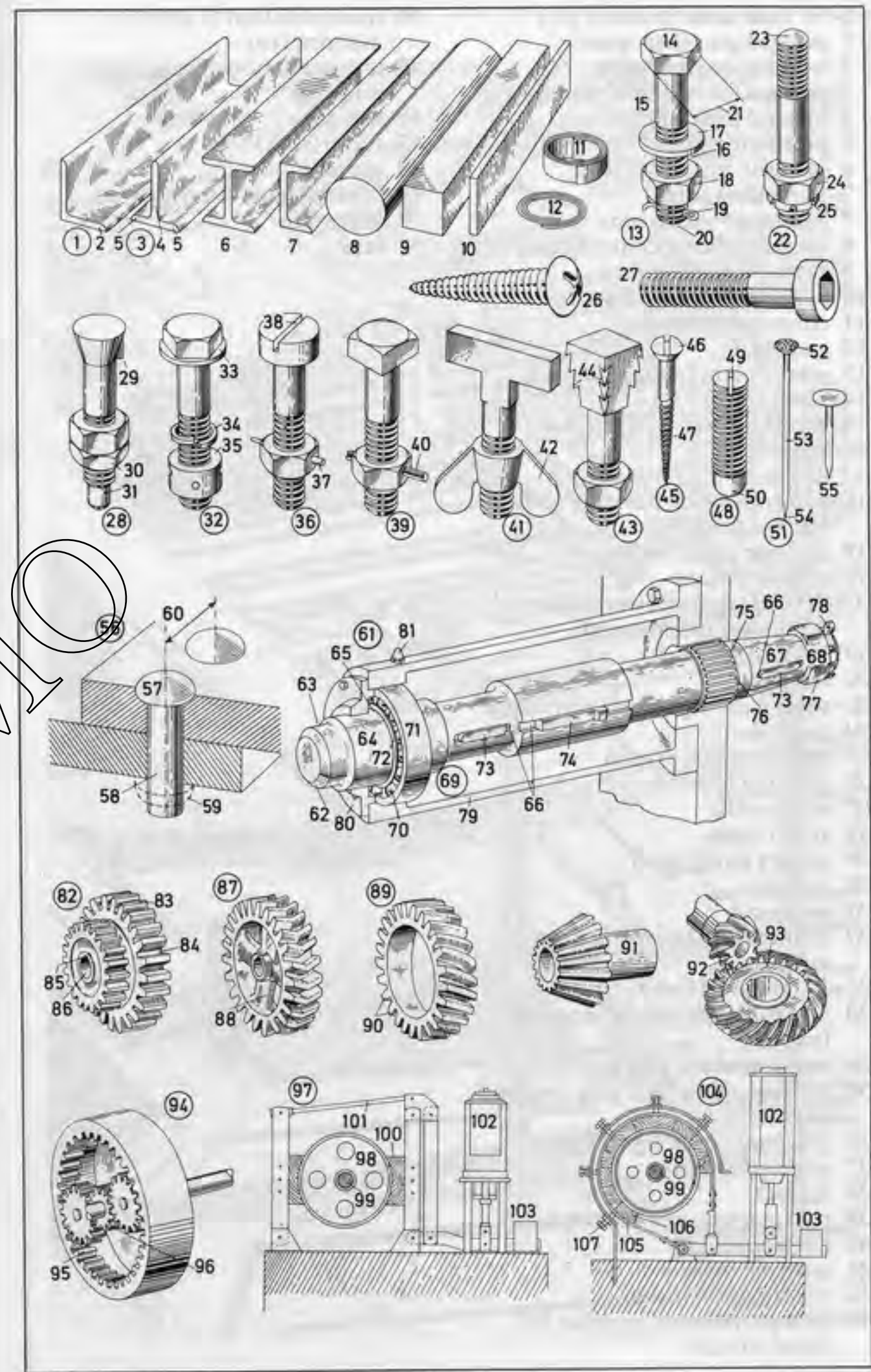

- 1-51 coal mine (colliery, pit)
- 1 pithead gear (headgear)
- 2 winding engine house
- 3 pithead frame (head frame)
- 4 pithead building
- 5 processing plant
- 6 sawmill
- 7-11 coking plant
- 7 battery of coke ovens
- 8 larry car (larry, charging car)
- 9 coking coal tower
- 10 coke-quenching tower
- 11 coke-quenching car
- 12 gasometer
- 13 power plant (power station)
- 14 water tower
- 15 cooling tower
- 16 mine fan
- 17 depot
- 18 administration building (office building, offices)
- 19 tip heap (spoil heap)
- 20 cleaning plant
- 21-51 underground workings (underground mining)
- 21 ventilation shaft
- 22 fan drift
- 23 cage-winding system with cages
- 24 main shaft
- 25 skip-winding system
- 26 winding inset
- 27 staple shaft
- 28 spiral chute
- 29 gallery along seam
- 30 lateral
- 31 cross-cut
- 32 tunnelling (*Am.* tunneling) machine
- 33-37 longwall faces
- 33 horizontal ploughed longwall face
- 34 horizontal cut longwall face
- 35 vertical pneumatic pick longwall face
- 36 diagonal ram longwall face
- 37 goaf (gob, waste)
- 38 air lock
- 39 transportation of men by cars
- 40 belt conveying
- 41 raw coal bunker
- 42 charging conveyor
- 43 transportation of supplies by monorail car

- 44 transportation of men by monorail car
- 45 transportation of supplies by mine car
- 46 drainage
- 47 sump (sink)
- 48 capping
- 49 [layer of] coal-bearing rock
- 50 coal seam
- 51 fault

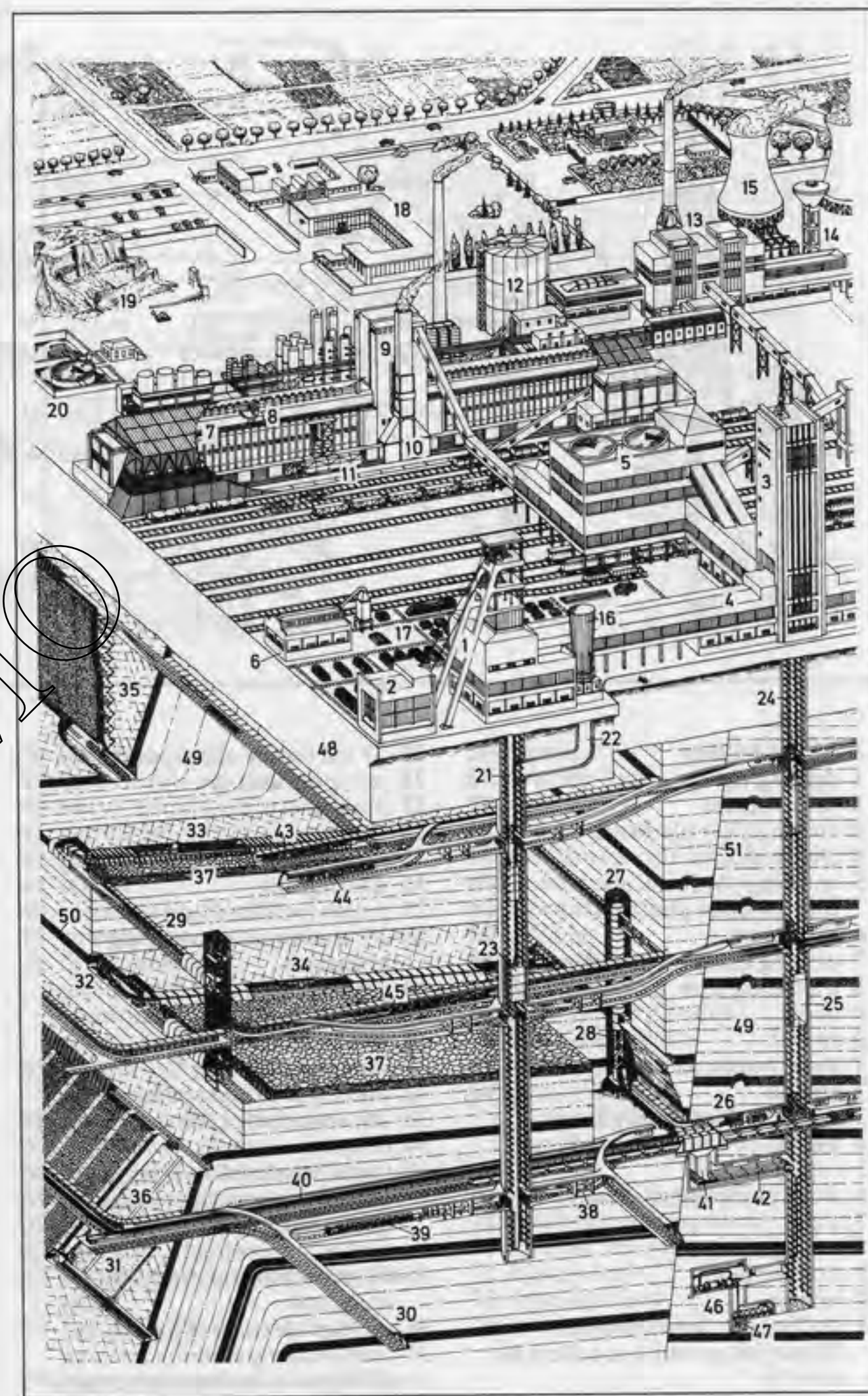

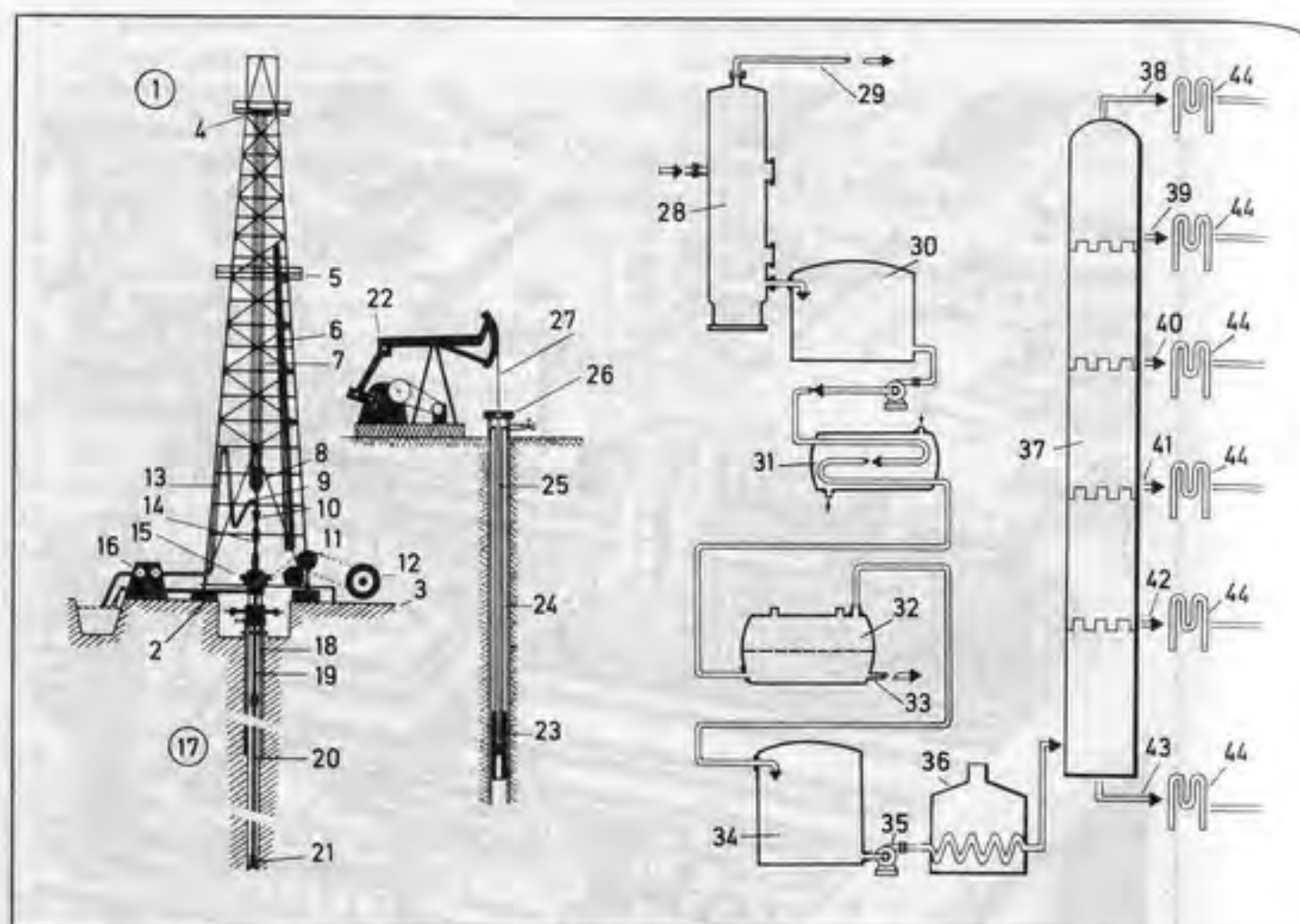
**1-21 oil drilling**

- 1 drilling rig
- 2 substructure
- 3 crown safety platform
- 4 crown blocks
- 5 working platform, an intermediate platform
- 6 drill pipes
- 7 drilling cable (drilling line)
- 8 travelling (*Am.* traveling) block
- 9 hook
- 10 swivel
- 11 draw works, a hoist
- 12 engine
- 13 standpipe and rotary hose
- 14 kelly
- 15 rotary table
- 16 slush pump (mud pump)
- 17 well
- 18 casing
- 19 drilling pipe
- 20 tubing
- 21 drilling bit; *kinds:* fishtail (blade) bit, rock (*Am.* roller) bit, core bit

22-27 oil (crude oil) production

- 22 pumping unit (pump)
- 23 plunger
- 24 tubing
- 25 sucker rods (pumping rods)
- 26 stuffing box
- 27 polish (polished) rod

28-35 treatment of crude oil [diagram]

- 28 gas separator
- 29 gas pipe (gas outlet)
- 30 wet oil tank (wash tank)
- 31 water heater
- 32 water and brine separator
- 33 salt water pipe (salt water outlet)
- 34 oil tank
- 35 trunk pipeline for oil [to the refinery or transport by tanker lorry (*Am.* tank truck), oil tanker, or pipeline]

36-64 processing of crude oil [diagram]

- 36 oil furnace (pipe still)
- 37 fractionating column (distillation column) with trays

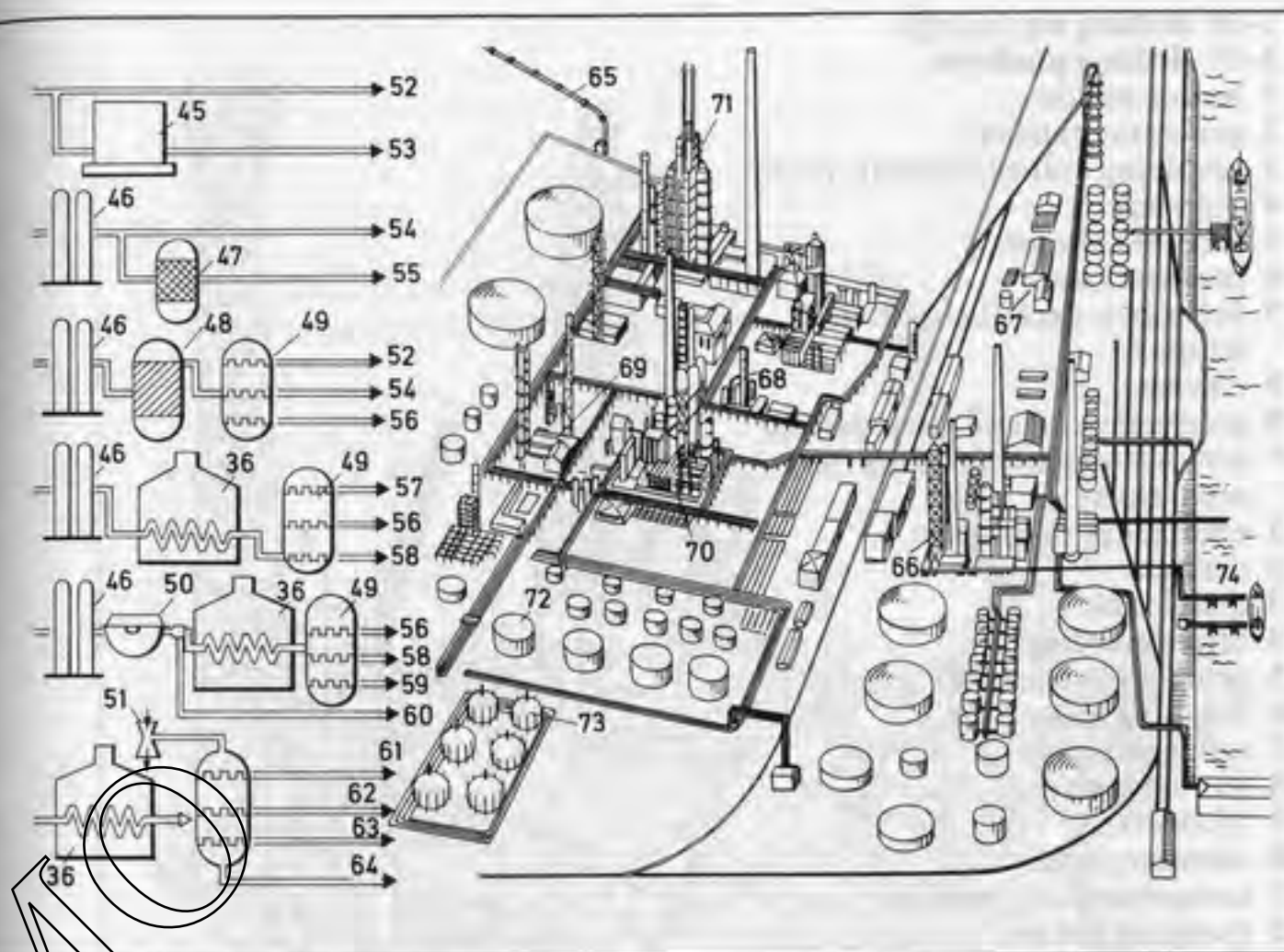

- 38 top gases (tops)
- 39 light distillation products
- 40 heavy distillation products
- 41 petroleum
- 42 gas oil component
- 43 residue
- 44 condenser (cooler)
- 45 compressor
- 46 desulphurizing (desulphurization, *Am.* desulfurizing, desulfurization) plant
- 47 reformer (hydroformer, platformer)
- 48 catalytic cracker (cat cracker)
- 49 distillation column
- 50 de-waxing (wax separation)
- 51 vacuum equipment
- 52-64 oil products
- 52 fuel gas
- 53 liquefied petroleum gas (liquid gas)
- 54 regular grade petrol (*Am.* gasoline)
- 55 super grade petrol (*Am.* gasoline)

- 56 diesel oil
- 57 aviation fuel
- 58 light fuel oil
- 59 heavy fuel oil
- 60 paraffin (paraffin oil, kerosene)
- 61 spindle oil
- 62 lubricating oil
- 63 cylinder oil
- 64 bitumen
- 65-74 oil refinery
- 65 pipeline (oil pipeline)
- 66 distillation plants
- 67 lubricating oil refinery
- 68 desulphurizing (desulphurization, *Am.* desulfurizing, desulfurization) plant
- 69 gas-separating plant
- 70 catalytic cracking plant
- 71 catalytic reformer
- 72 storage tank
- 73 spherical tank
- 74 tanker terminal

- 1-39 drilling rig (oil rig)
 1-37 drilling platform
- 1 power station
 - 2 generator exhausts
 - 3 revolving crane (pedestal crane)
 - 4 piperack
 - 5 turbine exhausts
 - 6 materials store
 - 7 helicopter deck (heliport deck, heliport)
 - 8 elevator
 - 9 production oil and gas separator
 - 10 test oil and gas separators (test separators)
 - 11 emergency flare stack
 - 12 derrick
 - 13 diesel tank
 - 14 office building
 - 15 cement storage tanks
 - 16 drinking water tank
 - 17 salt water tank
 - 18 jet fuel tanks
 - 19 lifeboats
 - 20 elevator shaft
 - 21 compressed-air reservoir
 - 22 pumping station
 - 23 air compressor
 - 24 air lock
 - 25 seawater desalination plant
 - 26 inlet filters for diesel fuel
 - 27 gas cooler
 - 28 control panel for the separators
 - 29 toilets (lavatories)
 - 30 workshop
 - 31 pig trap [the 'pig' is used to clean the oil pipeline]
 - 32 control room
 - 33 accommodation modules (accommodation)
 - 34 high-pressure cementing pumps
 - 35 lower deck
 - 36 middle deck
 - 37 top deck (main deck)
 - 38 substructure
 - 39 mean sea level

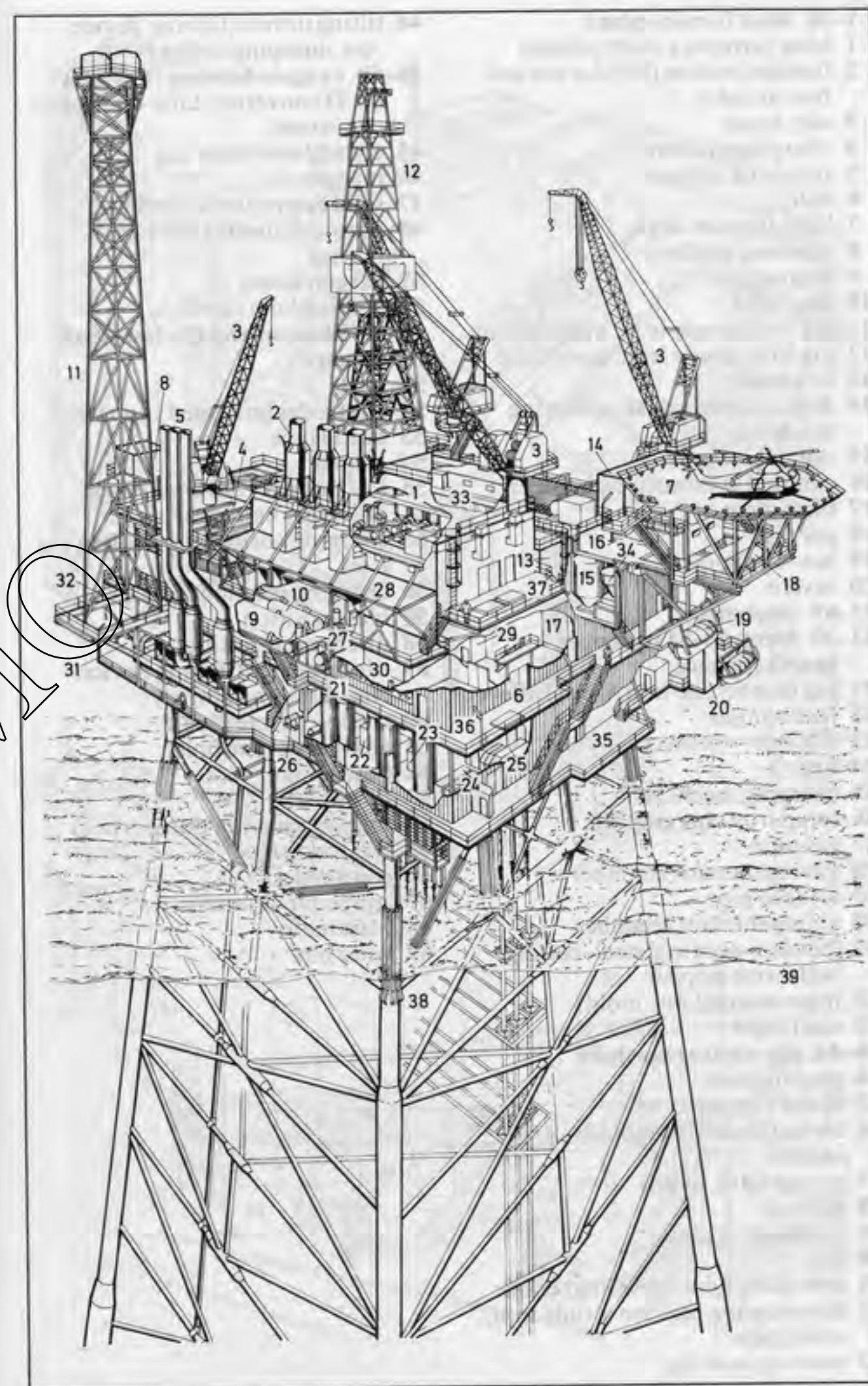

- 1-20 blast furnace plant**
- 1 blast furnace, a shaft furnace
 - 2 furnace incline (lift) for ore and flux or coke
 - 3 skip hoist
 - 4 charging platform
 - 5 receiving hopper
 - 6 bell
 - 7 blast furnace shaft
 - 8 smelting section
 - 9 slag escape
 - 10 slag ladle
 - 11 pig iron (crude iron, iron) runout
 - 12 pig iron (crude iron, iron) ladle
 - 13 downtake
 - 14 dust catcher, a dust-collecting machine
 - 15 hot-blast stove
 - 16 external combustion chamber
 - 17 blast main
 - 18 gas pipe
 - 19 hot-blast pipe
 - 20 tuyère
- 21-69 steelworks**
- 21-30 Siemens-Martin open-hearth furnace**
- 21 pig iron (crude iron, iron) ladle
 - 22 feed runner
 - 23 stationary furnace
 - 24 hearth
 - 25 charging machine
 - 26 scrap iron charging box
 - 27 gas pipe
 - 28 gas regenerator chamber
 - 29 air feed pipe
 - 30 air regenerator chamber
 - 31 [bottom-pouring] steel-casting ladle with stopper
 - 32 ingot mould (*Am.* mold)
 - 33 steel ingot
- 34-44 pig-casting machine**
- 34 pouring end
 - 35 metal runner
 - 36 series (strand) of moulds (*Am.* molds)
 - 37 mould (*Am.* mold)
 - 38 catwalk
 - 39 discharging chute
 - 40 pig
 - 41 travelling (*Am.* traveling) crane
 - 42 top-pouring pig iron (crude iron, iron) ladle
 - 43 pouring ladle lip
- 44 tilting device (tipping device, *Am.* dumping device)**
- 45-50 oxygen-blowing converter (L-D converter, Linz-Donawitz converter)**
- 45 conical converter top
 - 46 mantle
 - 47 solid converter bottom
 - 48 fireproof lining (refractory lining)
 - 49 oxygen lance
 - 50 tapping hole (tap hole)
- 51-54 Siemens electric low-shaft furnace**
- 51 feed
 - 52 electrodes [arranged in a circle]
 - 53 bustle pipe
 - 54 runout
- 55-69 Thomas converter (basic Bessemer converter)**
- 55 charging position for molten pig iron
 - 56 charging position for lime
 - 57 blow position
 - 58 discharging position
 - 59 tilting device (tipping device, *Am.* dumping device)
 - 60 crane-operated ladle
 - 61 auxiliary crane hoist
 - 62 lime bunker
 - 63 downpipe
 - 64 tipping car (*Am.* dump truck)
 - 65 scrap iron feed
 - 66 control desk
 - 67 converter chimney
 - 68 blast main
 - 69 wind box

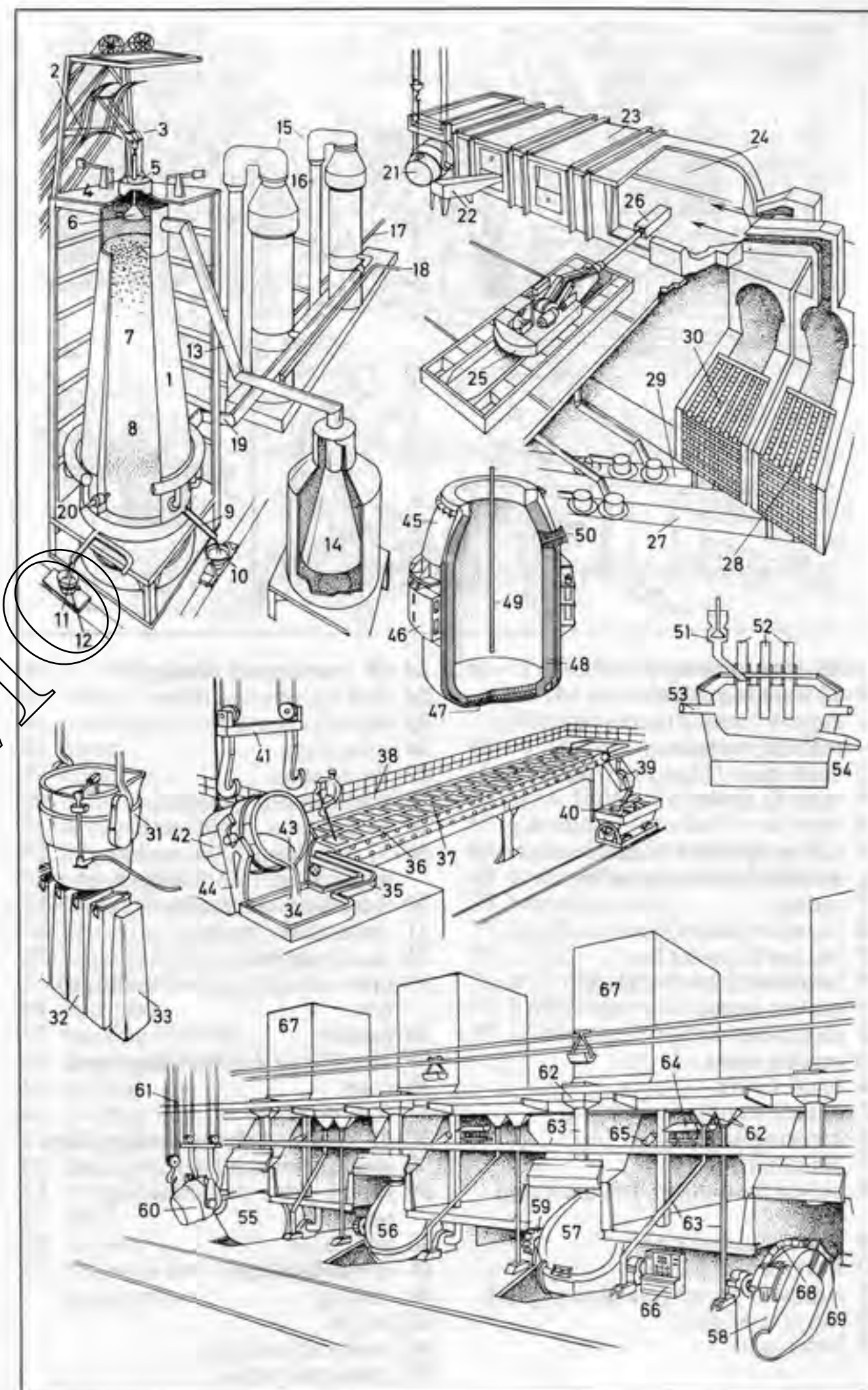

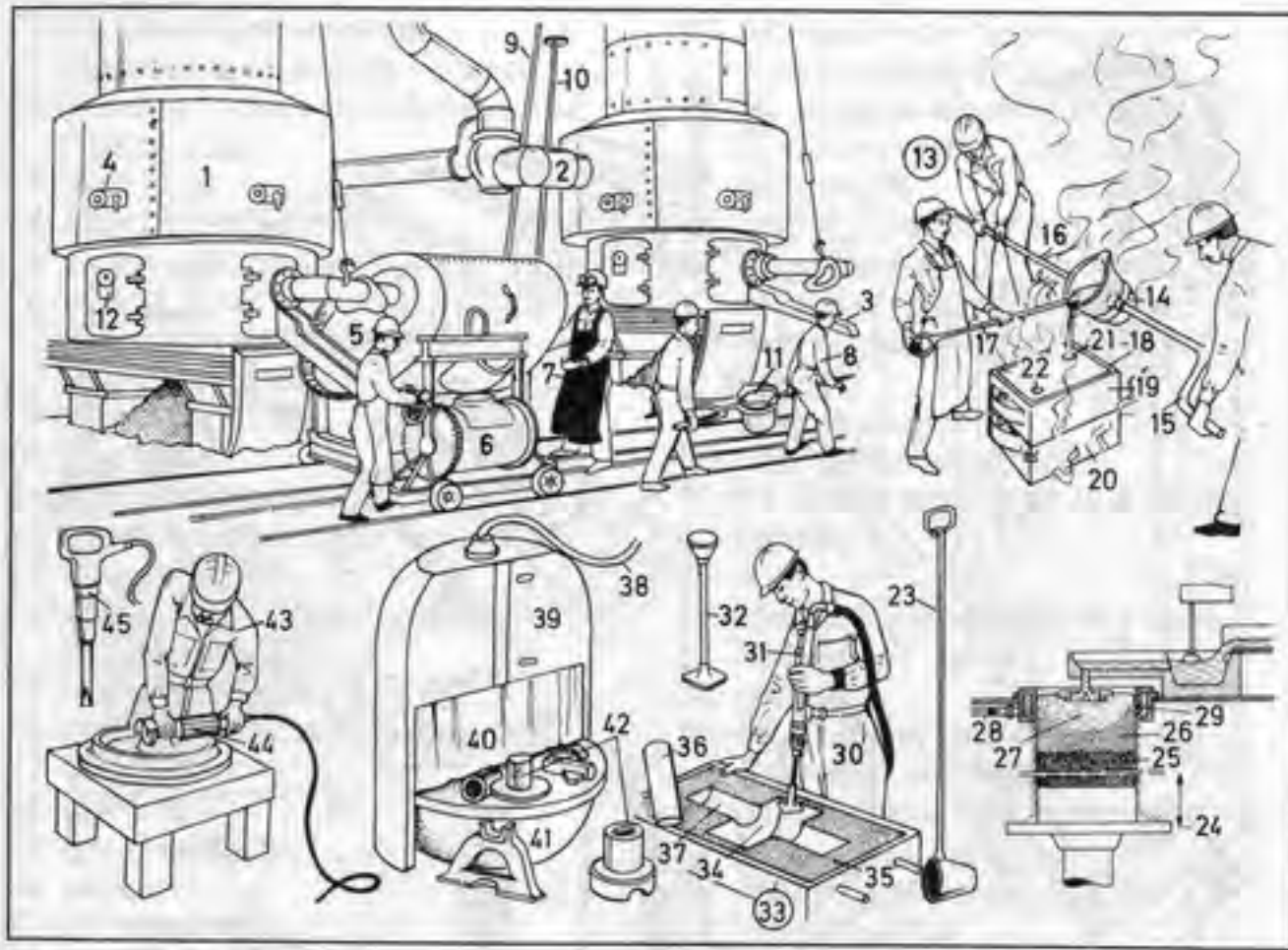

1-45 iron foundry

1-12 melting plant

- 1 cupola furnace (cupola), a melting furnace
- 2 blast main (blast inlet, blast pipe)
- 3 tapping spout
- 4 spyhole
- 5 tilting-type hot-metal receiver
- 6 mobile drum-type ladle
- 7 melter
- 8 founder (caster)
- 9 tap bar (tapping bar)
- 10 bott stick (*Am.* bot stick)
- 11 molten iron
- 12 slag spout
- 13 casting team
- 14 hand shank
- 15 double handle (crutch)
- 16 carrying bar
- 17 skimmer rod
- 18 closed moulding (*Am.* molding) box
- 19 upper frame (cope)
- 20 lower frame (drag)
- 21 runner (runner gate, down-gate)
- 22 riser (riser gate)
- 23 hand ladle

24-29 continuous casting

- 24 sinking pouring floor
- 25 solidifying pig
- 26 solid stage
- 27 liquid stage
- 28 water-cooling system
- 29 mould (*Am.* mold) wall
- 30-37 **moulding** (*Am.* molding) department (*moulding shop*)
- 30 moulder (*Am.* molder)
- 31 pneumatic rammer
- 32 hand rammer
- 33 open moulding (*Am.* molding) box
- 34 pattern
- 35 moulding (*Am.* molding) sand
- 36 core
- 37 core print
- 38-45 **cleaning shop** (*fettling shop*)
- 38 steel grit or sand delivery pipe
- 39 rotary-table shot-blasting machine
- 40 grit guard
- 41 revolving table
- 42 casting
- 43 fettler
- 44 pneumatic grinder
- 45 pneumatic chisel

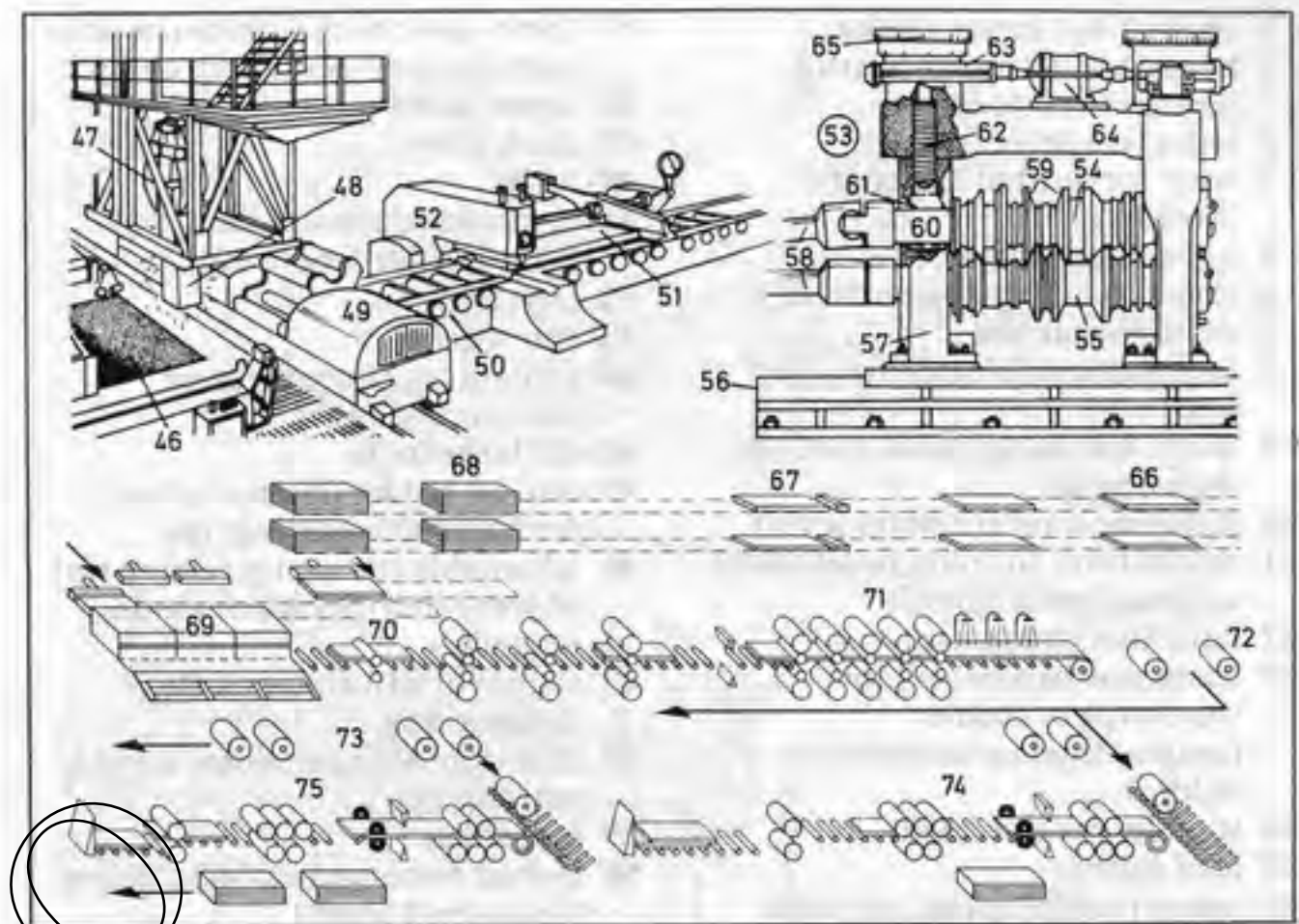

46-75 rolling mill

- 46 soaking pit
- 47 soaking pit crane
- 48 ingot
- 49 ingot tipper
- 50 blooming train (roller path)
- 51 workpiece
- 52 bloom shears
- 53 two-high mill
- 54-55 **set of rolls** (set of rollers)
- 54 upper roll (upper roller)
- 55 lower roll (lower roller)
- 56-60 **roll stand**
- 56 base plate
- 57 housing (frame)
- 58 coupling spindle
- 59 groove
- 60 roll bearing
- 61-65 **adjusting equipment**
- 61 chock
- 62 main screw
- 63 gear
- 64 motor
- 65 indicator for rough and fine adjustment

66-75 continuous rolling mill train for the manufacture of strip [diagram]

- 66-68 processing of semi-finished product
- 66 semi-finished product
- 67 gas cutting installation
- 68 stack of finished steel sheets
- 69 continuous reheating furnaces
- 70 blooming train
- 71 finishing train
- 72 coiler
- 73 collar bearing for marketing
- 74 5 mm shearing train
- 75 10 mm shearing train

- 1 centre (*Am.* center) lathe
- 2 headstock with gear control (geared headstock)
- 3 reduction drive lever
- 4 lever for normal and coarse threads
- 5 speed change lever
- 6 leadscrew reverse-gear lever
- 7 change-gear box
- 8 feed gearbox (Norton tumbler gear)
- 9 levers for changing the feed and thread pitch
- 10 feed gear lever (tumbler lever)
- 11 switch lever for right or left hand action of main spindle
- 12 lathe foot (footpiece)
- 13 leadscrew handwheel for traversing of saddle (longitudinal movement of saddle)
- 14 tumbler reverse lever
- 15 feed screw
- 16 apron (saddle apron, carriage apron)
- 17 lever for longitudinal and transverse motion
- 18 drop (dropping) worm (feed trip, feed tripping device) for engaging feed mechanisms
- 19 lever for engaging half nut of leadscrew (lever for clasp nut engagement)
- 20 lathe spindle
- 21 tool post
- 22 top slide (tool slide, tool rest)
- 23 cross slide
- 24 bed slide
- 25 coolant supply pipe
- 26 tailstock centre (*Am.* center)
- 27 barrel (tailstock barrel)
- 28 tailstock barrel clamp lever
- 29 tailstock
- 30 tailstock barrel adjusting handwheel
- 31 lathe bed
- 32 leadscrew
- 33 feed shaft
- 34 reverse shaft for right and left hand motion and engaging and disengaging
- 35 four-jaw chuck (four-jaw independent chuck)
- 36 gripping jaw

- 37 three-jaw chuck (three-jaw self-centring, self-centering, chuck)
- 38 turret lathe
- 39 cross slide
- 40 turret
- 41 combination toolholder (multiple turning head)
- 42 top slide
- 43 star wheel
- 44 coolant tray for collecting coolant and swarf
- 45-53 lathe tools
- 45 tool bit holder (clamp tip tool) for adjustable cutting tips
- 46 adjustable cutting tip (clamp tip) of cemented carbide or oxide ceramic
- 47 shapes of adjustable oxide ceramic tips
- 48 lathe tool with cemented carbide cutting edge
- 49 tool shank
- 50 brazed cemented carbide cutting tip (cutting edge)
- 51 internal facing tool (boring tool) for corner work
- 52 general-purpose lathe tool
- 53 parting (parting-off) tool
- 54 lathe carrier
- 55 driving (driver) plate
- 56-72 measuring instruments
- 56 plug gauge (*Am.* gage)
- 57 'GO' gauging (*Am.* gaging) member (end)
- 58 'NOT GO' gauging (*Am.* gaging) member (end)
- 59 calliper (caliper, snap) gauge (*Am.* gage)
- 60 'GO' side
- 61 'NOT GO' side
- 62 micrometer
- 63 measuring scale
- 64 graduated thimble
- 65 frame
- 66 spindle (screwed spindle)
- 67 vernier calliper (caliper) gauge (*Am.* gage)
- 68 depth gauge (*Am.* gage) attachment rule
- 69 vernier scale
- 70 outside jaws
- 71 inside jaws
- 72 vernier depth gauge (*Am.* gage)

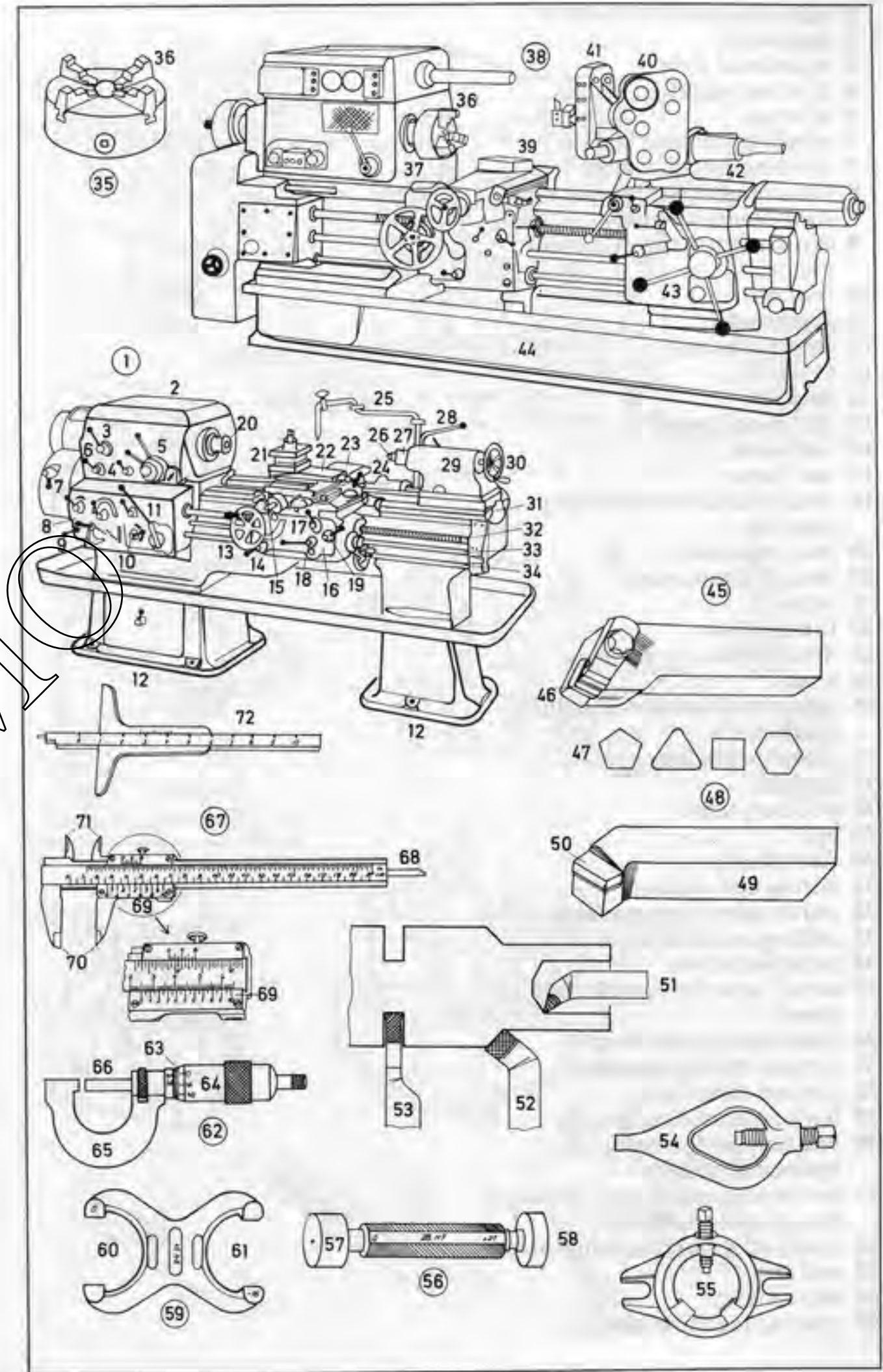

- 1 universal grinding machine
- 2 headstock
- 3 wheelhead slide
- 4 grinding wheel
- 5 tailstock
- 6 grinding machine bed
- 7 grinding machine table
- 8 two-column planing machine (two-column planer)
- 9 drive motor, a direct current motor
- 10 column
- 11 planer table
- 12 cross slide (rail)
- 13 tool box
- 14 hacksaw
- 15 clamping device
- 16 saw blade
- 17 saw frame
- 18 radial (radial-arm) drilling machine
- 19 bed (base plate)
- 20 block for workpiece
- 21 pillar
- 22 lifting motor
- 23 drill spindle
- 24 arm
- 25 horizontal boring and milling machine
- 26 movable headstock
- 27 spindle
- 28 auxiliary table
- 29 bed
- 30 fixed steady
- 31 boring mill column
- 32 universal milling machine
- 33 milling machine table
- 34 table feed drive
- 35 switch lever for spindle rotation speed
- 36 control box (control unit)
- 37 vertical milling spindle
- 38 vertical drive head
- 39 horizontal milling spindle
- 40 end support for steadying horizontal spindle
- 41 machining centre (*Am. center*), a rotary-table machine
- 42 rotary (circular) indexing table
- 43 end mill
- 44 machine tap
- 45 shaping machine (shaper)

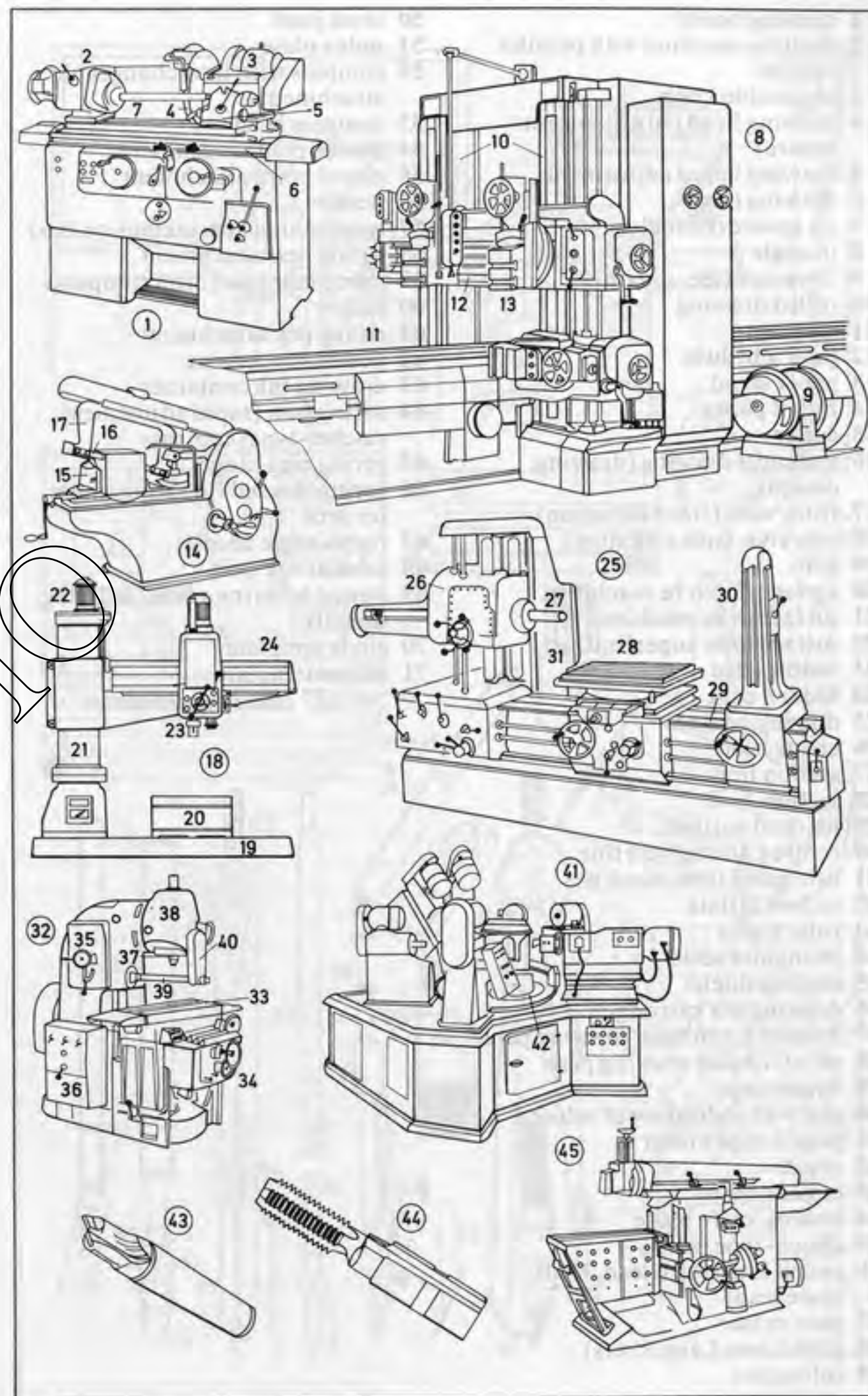

DEMO

- 1 drawing board
- 2 drafting machine with parallel motion
- 3 adjustable knob
- 4 drawing head (adjustable set square)
- 5 drawing board adjustment
- 6 drawing table
- 7 set square (triangle)
- 8 triangle
- 9 T-square (tee-square)
- 10 rolled drawing
- 11 diagram
- 12 time schedule
- 13 paper stand
- 14 roll of paper
- 15 cutter
- 16 technical drawing (drawing, design)
- 17 front view (front elevation)
- 18 side view (side elevation)
- 19 plan
- 20 surface not to be machined
- 21 surface to be machined
- 22 surface to be superfinished
- 23 visible edge
- 24 hidden edge
- 25 dimension line
- 26 arrow head
- 27 section line
- 28 section A-B
- 29 hatched surface
- 30 centre (*Am.* center) line
- 31 title panel (title block)
- 32 technical data
- 33 ruler (rule)
- 34 triangular scale
- 35 erasing shield
- 36 drawing ink cartridge
- 37 holders for tubular drawing pens
- 38 set of tubular drawing pens
- 39 hygrometer
- 40 cap with indication of nib size
- 41 pencil-type eraser
- 42 eraser
- 43 erasing knife
- 44 erasing knife blade
- 45 clutch-type pencil
- 46 pencil lead (refill lead, refill, spare lead)
- 47 glass eraser
- 48 glass fibres (*Am.* fibers)
- 49 ruling pen
- 50 cross joint
- 51 index plate
- 52 compass with interchangeable attachments
- 53 compass head
- 54 needle point attachment
- 55 pencil point attachment
- 56 needle
- 57 lengthening arm (extension bar)
- 58 ruling pen attachment
- 59 pump compass (drop compass)
- 60 piston
- 61 ruling pen attachment
- 62 pencil attachment
- 63 drawing ink container
- 64 spring bow (rapid adjustment, ratchet-type) compass
- 65 spring ring hinge
- 66 spring-loaded fine adjustment for arcs
- 67 right-angle needle
- 68 tubular ink unit
- 69 stencil lettering guide (lettering stencil)
- 70 circle template
- 71 ellipse template

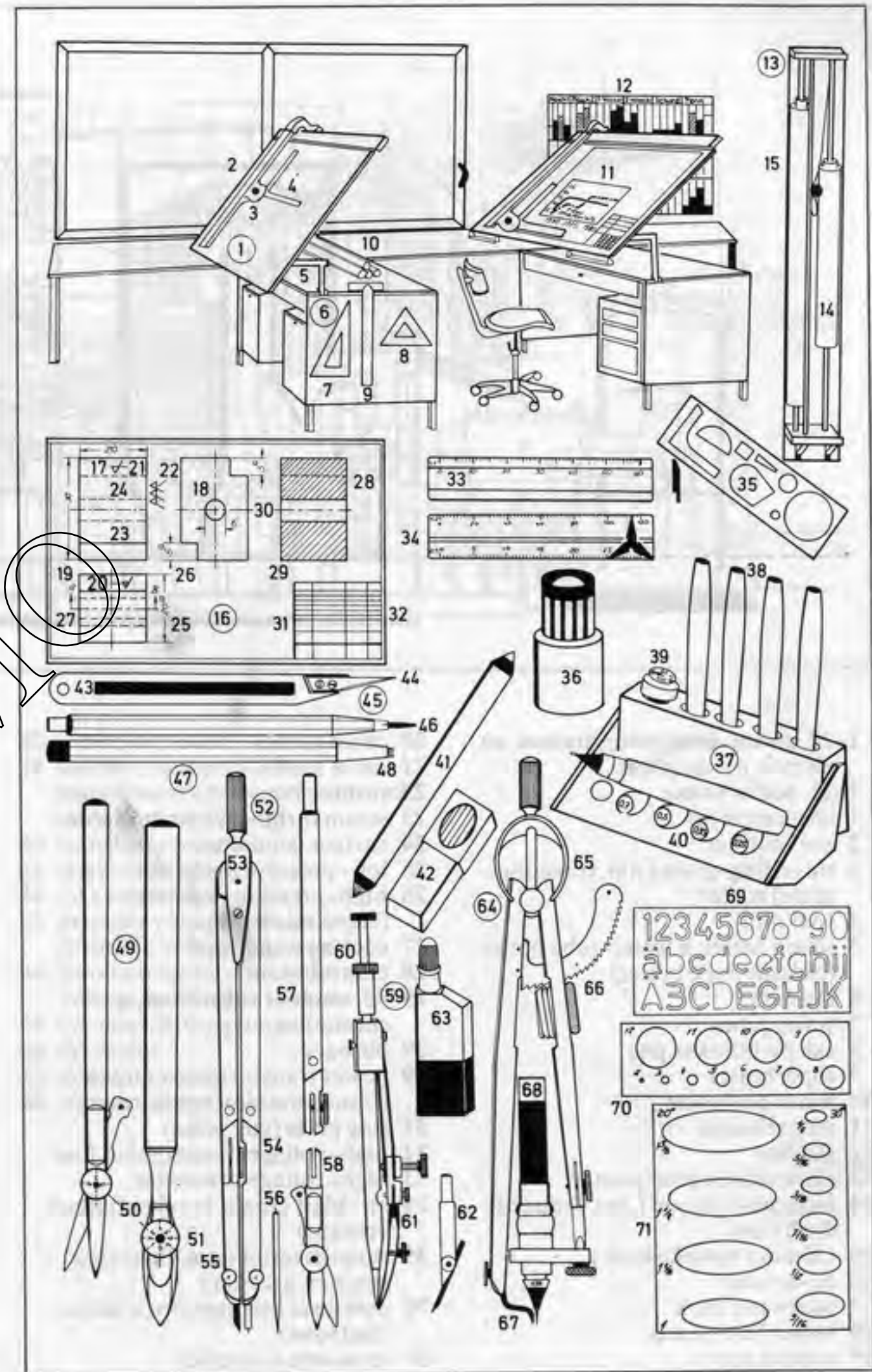

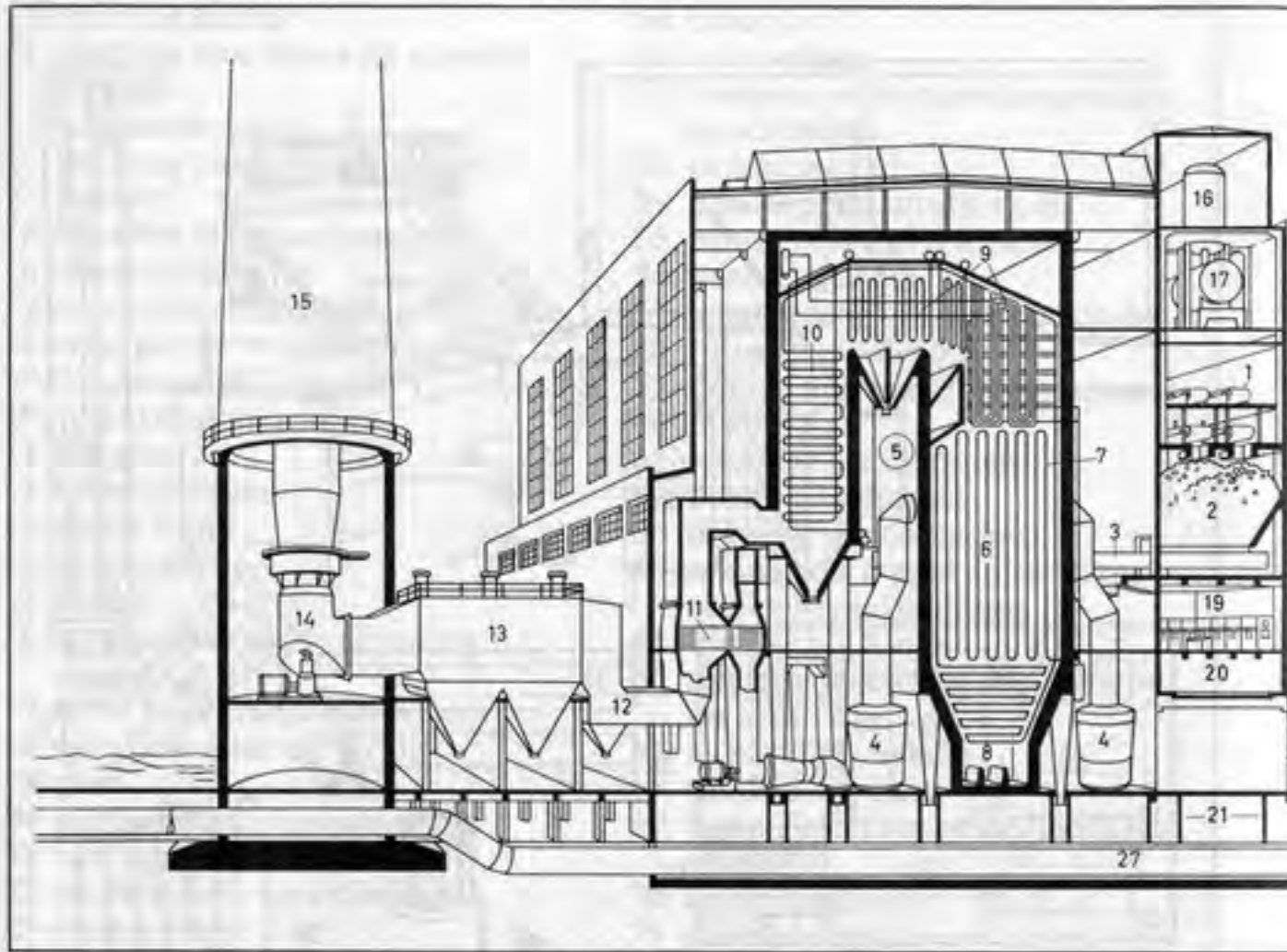

- 1-28 steam-generating station, an electric power plant
- 1-21 boiler house
- 1 coal conveyor
- 2 coal bunker
- 3 travelling-grate (*Am.* traveling-grate) stoker
- 4 coal mill
- 5 steam boiler, a water-tube boiler (radiant-type boiler)
- 6 burners
- 7 water pipes
- 8 ash pit (clinker pit)
- 9 superheater
- 10 water preheater
- 11 air preheater
- 12 gas flue
- 13 electrostatic precipitator
- 14 induced-draught (*Am.* induced-draft) fan
- 15 chimney (smokestack)
- 16 de-aerator
- 17 feedwater tank
- 18 boiler feed pump
- 19 control room

- 20 cable tunnel
- 21 cable vault
- 22 turbine house
- 23 steam turbine with alternator
- 24 surface condenser
- 25 low-pressure preheater
- 26 high-pressure preheater (economizer)
- 27 cooling water pipe
- 28 control room
- 29-35 outdoor substation, a substation
- 29 busbars
- 30 power transformer, a mobile (transportable) transformer
- 31 stay poles (guy poles)
- 32 high-voltage transmission line
- 33 high-voltage conductor
- 34 air-blast circuit breaker (circuit breaker)
- 35 surge diverter (*Am.* lightning arrester, arrester)
- 36 overhead line support, a lattice steel tower
- 37 cross arm (traverse)

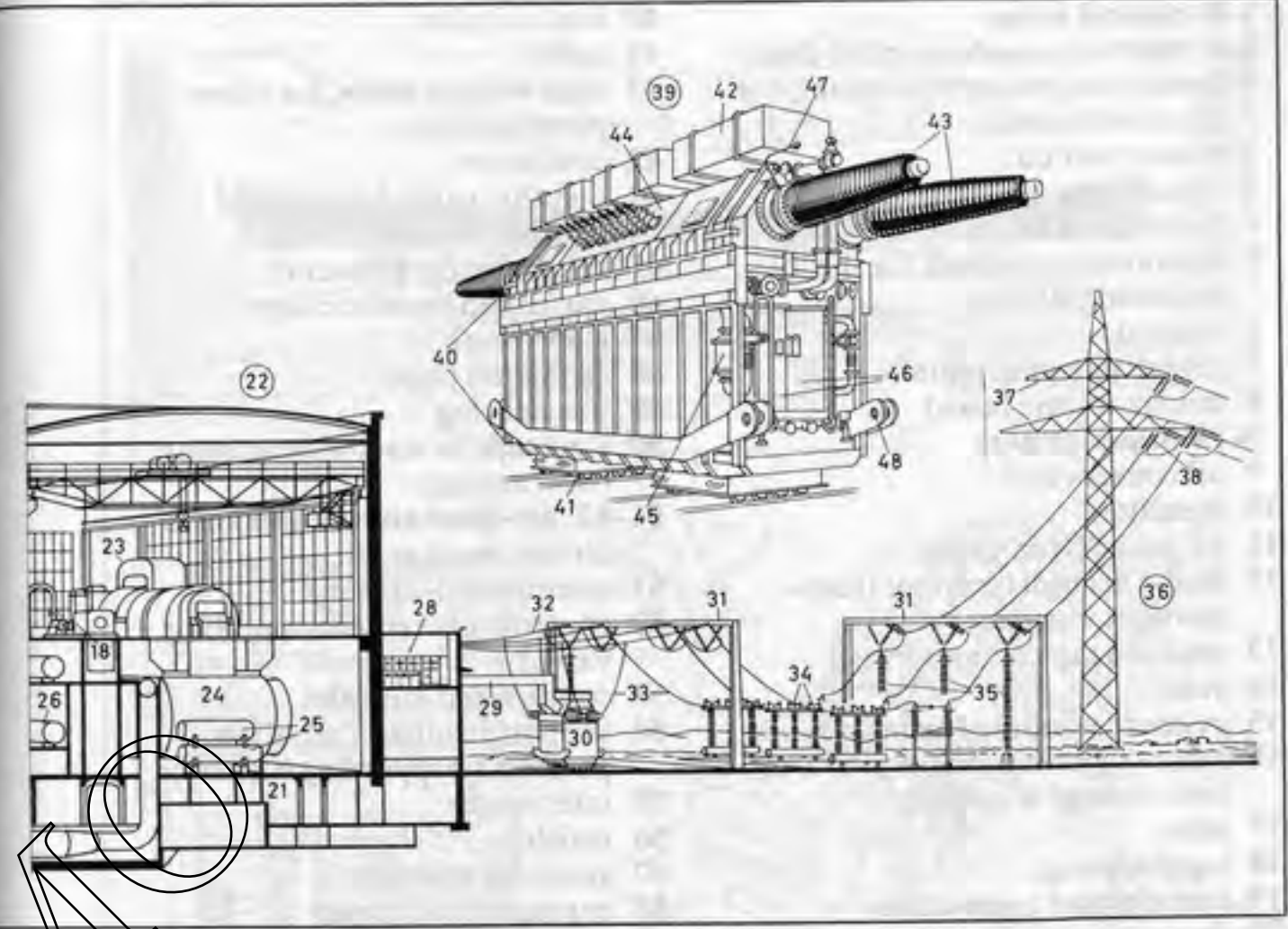

- 38 strain insulator
- 39 mobile (transportable) transformer (power transformer, transformer)
- 40 transformer tank
- 41 bogie (*Am.* truck)
- 42 oil conservator
- 43 primary voltage terminal (primary voltage bushing)
- 44 low-voltage terminals (low-voltage bushings)
- 45 oil-circulating pump
- 46 oil cooler
- 47 arcing horn
- 48 transport lug

- 1-8 control room
- 1-6 control console (control desk)
- 1 control board (control panel) for the alternators
- 2 master switch
- 3 signal light
- 4 feeder panel
- 5 monitoring controls for the switching systems
- 6 controls
- 7 revertive signal panel
- 8 matrix mimic board
- 9-18 transformer
- 9 oil conservator
- 10 breather
- 11 oil gauge (Am. gage)
- 12 feed-through terminal (feed-through insulator)
- 13 on-load tap changer
- 14 yoke
- 15 primary winding (primary)
- 16 secondary winding (secondary, low-voltage winding)
- 17 core
- 18 tap (tapping)
- 19 transformer connection
- 20 star connection (star network, Y-connection)
- 21 delta connection (mesh connection)
- 22 neutral point
- 23-30 steam turbine, a turbogenerator unit
- 23 high-pressure cylinder
- 24 medium-pressure cylinder
- 25 low-pressure cylinder
- 26 three-phase generator (generator)
- 27 hydrogen cooler
- 28 leakage steam path
- 29 jet nozzle
- 30 turbine monitoring panel with measuring instruments
- 31 automatic voltage regulator
- 32 synchro
- 33 cable box
- 34 conductor
- 35 feed-through terminal (feed-through insulator)
- 36 core
- 37 casing
- 38 filling compound (filler)
- 39 lead sheath

- 40 lead-in tube
- 41 cable
- 42 high voltage cable, for three-phase current
- 43 conductor
- 44 metallic paper (metallized paper)
- 45 tracer (tracer element)
- 46 varnished-cambric tape
- 47 lead sheath
- 48 asphalted paper
- 49 jute serving
- 50 steel tape or steel wire armour (Am. armor)
- 51-62 air-blast circuit breaker, a circuit breaker
- 51 compressed-air tank
- 52 control valve (main operating valve)
- 53 compressed-air inlet
- 54 support insulator, a hollow porcelain supporting insulator
- 55 interrupter
- 56 resistor
- 57 auxiliary contacts
- 58 current transformer
- 59 voltage transformer (potential transformer)
- 60 operating mechanism housing
- 61 arcing horn
- 62 spark gap

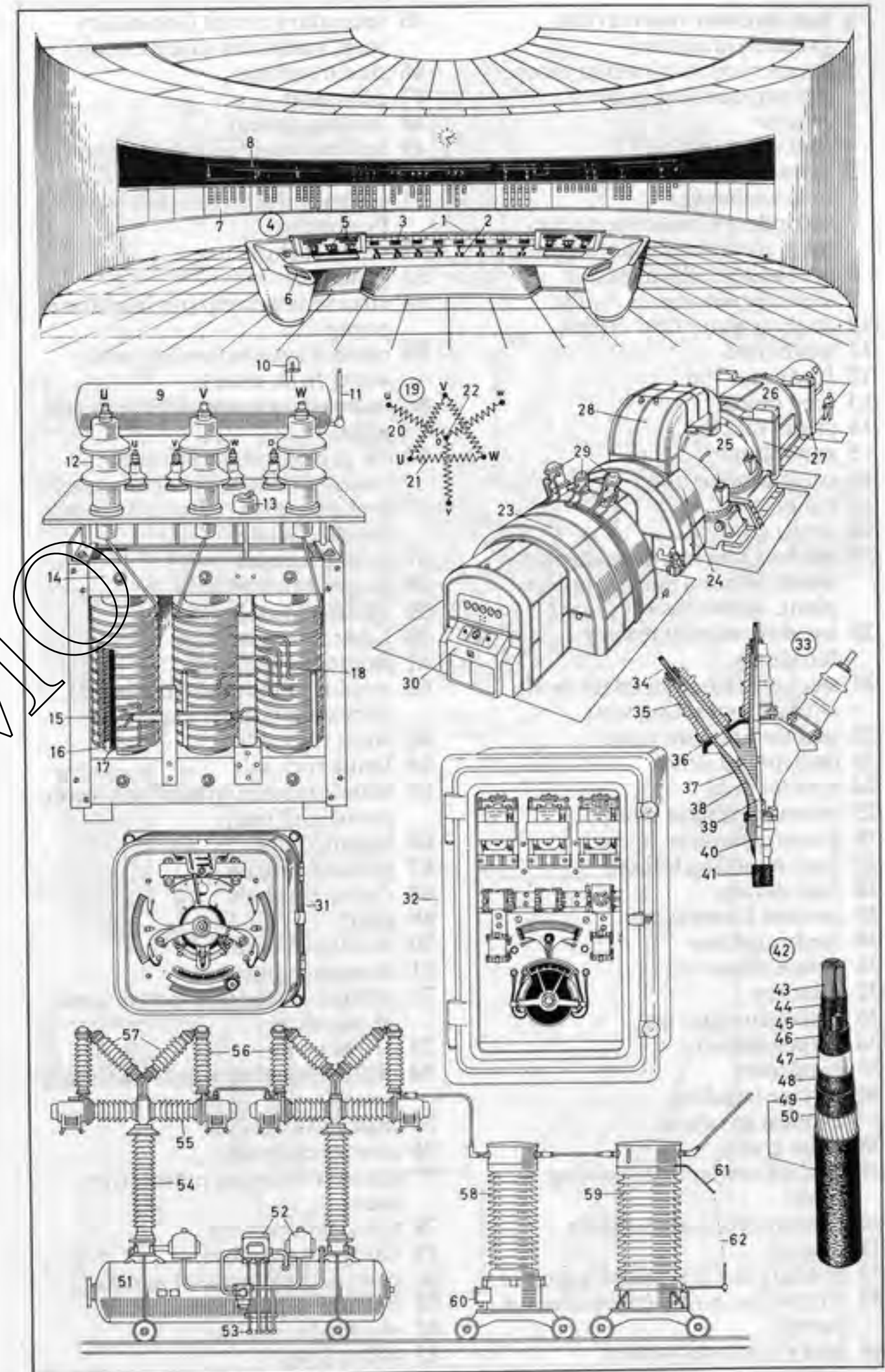

- 1 fast-breeder reactor (fast breeder) [diagram]
- 2 primary circuit (primary loop, primary sodium system)
- 3 reactor
- 4 fuel rods (fuel pins)
- 5 primary sodium pump
- 6 heat exchanger
- 7 secondary circuit (secondary loop, secondary sodium system)
- 8 secondary sodium pump
- 9 steam generator
- 10 cooling water flow circuit
- 11 steam line
- 12 feedwater line
- 13 feed pump
- 14 steam turbine
- 15 generator
- 16 transmission line
- 17 condenser
- 18 cooling water
- 19 nuclear reactor, a pressurized-water reactor (nuclear power plant, atomic power plant)
- 20 concrete shield (reactor building)
- 21 steel containment (steel shell) with air extraction vent
- 22 reactor pressure vessel
- 23 control rod drive
- 24 control rods
- 25 primary coolant pump
- 26 steam generator
- 27 fuel-handling hoists
- 28 fuel storage
- 29 coolant flow passage
- 30 feedwater line
- 31 prime steam line
- 32 manway
- 33 turbogenerator set
- 34 turbogenerator
- 35 condenser
- 36 service building
- 37 exhaust gas stack
- 38 polar crane
- 39 cooling tower, a dry cooling tower
- 40 pressurized-water system
- 41 reactor
- 42 primary circuit (primary loop)
- 43 circulation pump (recirculation pump)
- 44 heat exchanger (steam generator)
- 45 secondary circuit (secondary loop, feedwater steam circuit)
- 46 steam turbine
- 47 generator
- 48 cooling system
- 49 boiling water system [diagram]
- 50 reactor
- 51 steam and recirculation water flow paths
- 52 steam turbine
- 53 generator
- 54 circulation pump (recirculation pump)
- 55 coolant system (cooling with water from river)
- 56 radioactive waste storage in salt mine
- 57-68 geological structure of abandoned salt mine converted for disposal of radioactive waste (nuclear waste)
- 57 Lower Keuper
- 58 Upper Muschelkalk
- 59 Middle Muschelkalk
- 60 Lower Muschelkalk
- 61 Bunter downthrow
- 62 residue of leached (lixiviated) Zechstein (Upper Permian)
- 63 Aller rock salt
- 64 Leine rock salt
- 65 Stassfurt seam (potash salt seam, potash salt bed)
- 66 Stassfurt salt
- 67 grenzanhydrite
- 68 Zechstein shale
- 69 shaft
- 70 minehead buildings
- 71 storage chamber
- 72 storage of medium-active waste in salt mine
- 73 511 m level
- 74 protective screen (anti-radiation screen)
- 75 lead glass window
- 76 storage chamber
- 77 drum containing radioactive waste
- 78 television camera
- 79 charging chamber
- 80 control desk (control panel)
- 81 upward ventilator
- 82 shielded container
- 83 490 m level

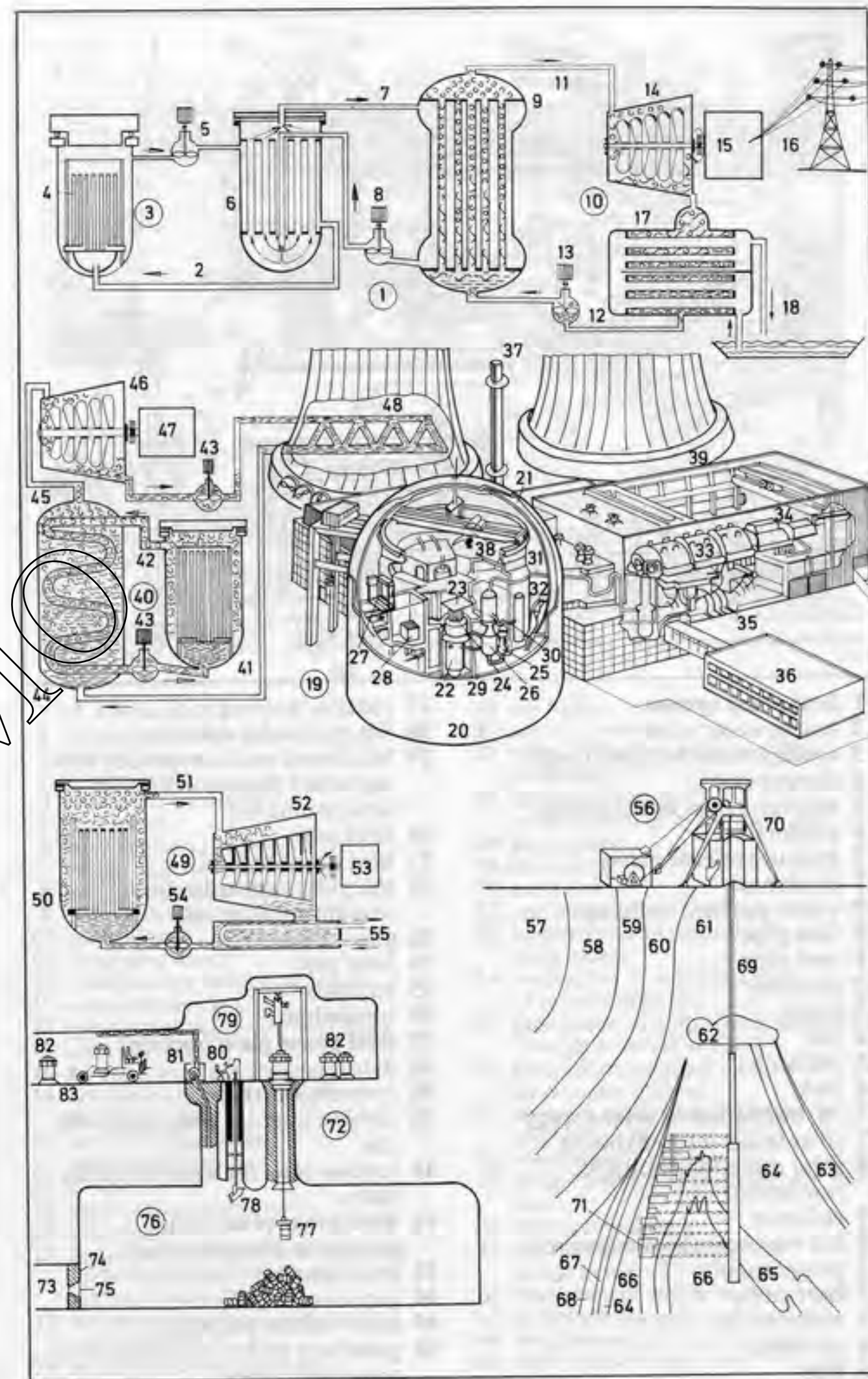

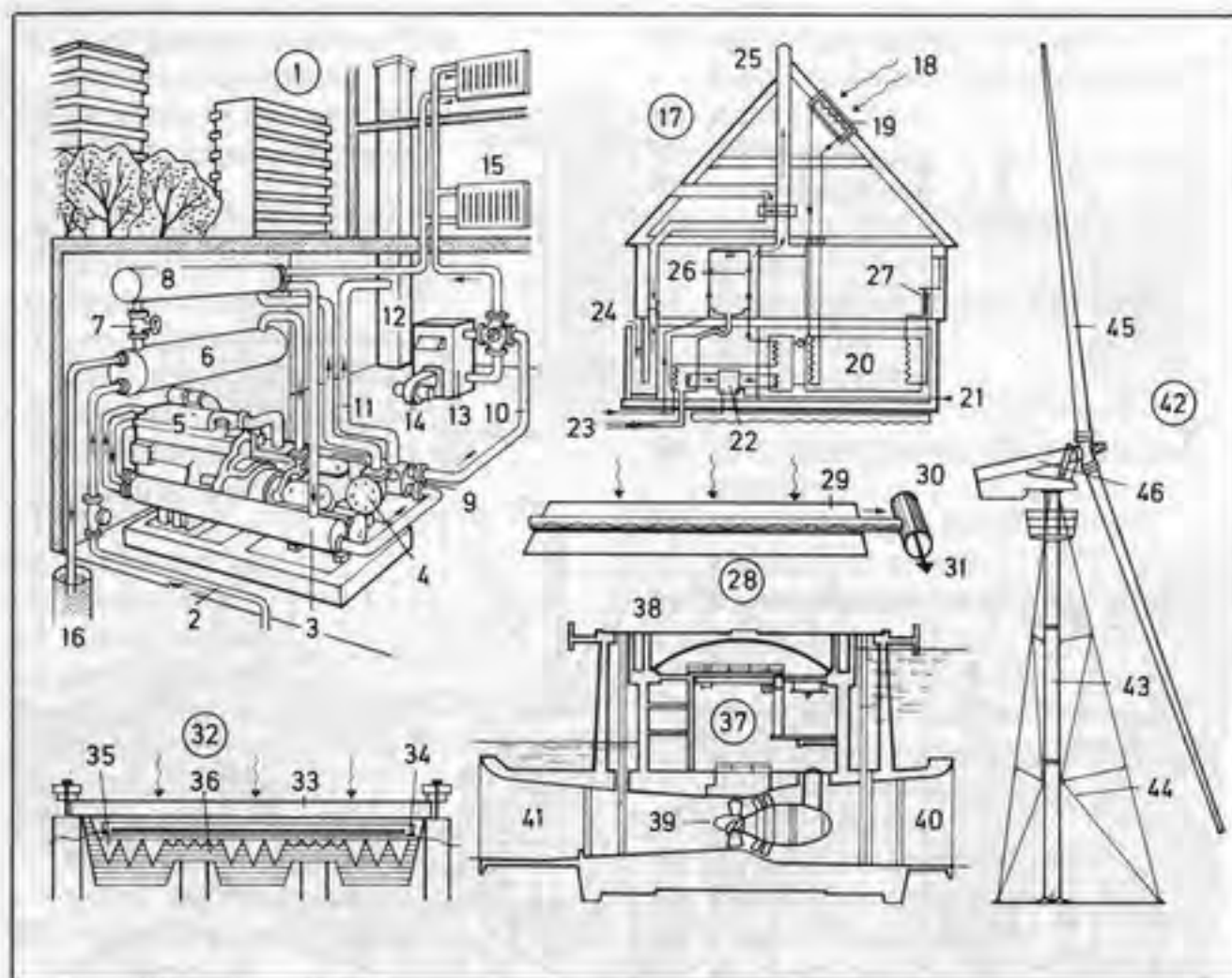

- 1 heat pump system
- 2 source water inlet
- 3 cooling water heat exchanger
- 4 compressor
- 5 natural-gas or diesel engine
- 6 evaporator
- 7 pressure release valve
- 8 condenser
- 9 waste-gas heat exchanger
- 10 flow pipe
- 11 vent pipe
- 12 chimney
- 13 boiler
- 14 fan
- 15 radiator
- 16 sink
- 17-36 utilization of solar energy
- 17 solar (solar-heated) house
- 18 solar radiation (sunlight, insolation)
- 19 collector
- 20 hot reservoir (heat reservoir)
- 21 power supply
- 22 heat pump
- 23 water outlet
- 24 air supply
- 25 flue
- 26 hot water supply
- 27 radiator heating
- 28 flat plate solar collector
- 29 blackened receiver surface with asphalted aluminium (Am. aluminum) foil
- 30 steel tube
- 31 heat transfer fluid
- 32 flat plate solar collector, containing solar cell
- 33 glass cover
- 34 solar cell
- 35 air ducts
- 36 insulation
- 37 tidal power plant [section]
- 38 dam
- 39 reversible turbine
- 40 turbine inlet for water from the sea
- 41 turbine inlet for water from the basin
- 42 wind power plant (wind generator, aerogenerator)
- 43 truss tower
- 44 guy wire
- 45 rotor blades (propeller)
- 46 generator with variable pitch for power regulation

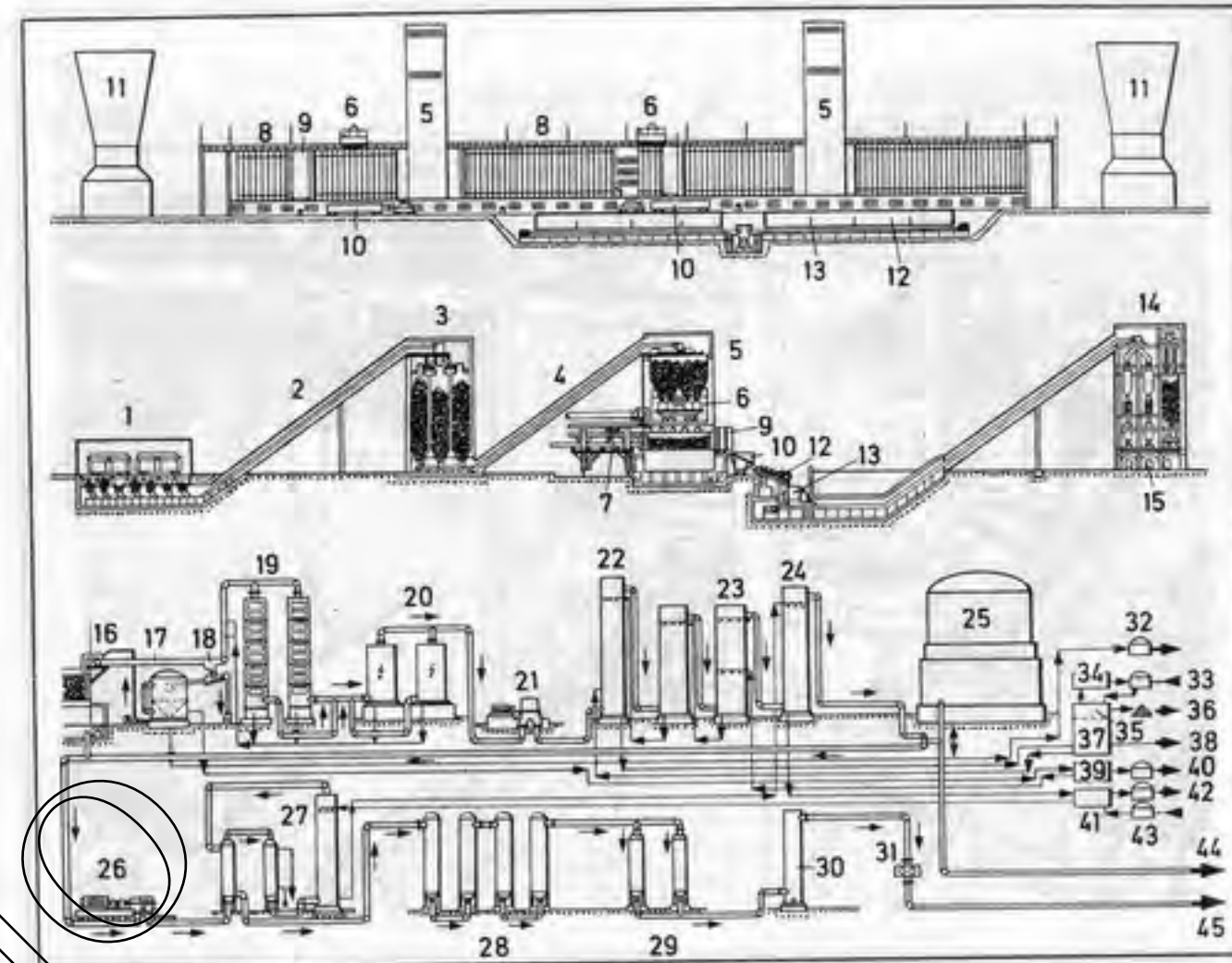

- 1-15 coking plant
- 1 dumping of coking coal
- 2 belt conveyor
- 3 service bunker
- 4 coal tower conveyor
- 5 coal tower
- 6 larry car (larry, charging car)
- 7 pusher ram
- 8 battery of coke ovens
- 9 coke guide
- 10 quenching car, with engine
- 11 quenching tower
- 12 coke loading bay (coke wharf)
- 13 coke side bench
- 14 screening of lump coal and culm
- 15 coke loading
- 16-45 coke-oven gas processing
- 16 discharge (release) of gas from the coke ovens
- 17 gas-collecting main
- 18 coal tar extraction
- 19 gas cooler
- 20 electrostatic precipitator
- 21 gas extractor
- 22 hydrogen sulphide (Am. hydrogen sulfide) scrubber (hydrogen sulphide wet collector)
- 23 ammonia scrubber (ammonia wet collector)
- 24 benzene (benzol) scrubber
- 25 gas holder
- 26 gas compressor
- 27 debenzoling by cooler and heat exchanger
- 28 desulphurization (Am. desulfurization) of pressure gas
- 29 gas cooling
- 30 gas drying
- 31 gas meter
- 32 crude tar tank
- 33 sulphuric acid (Am. sulfuric acid) supply
- 34 production of sulphuric acid (Am. sulfuric acid)
- 35 production of ammonium sulphate (Am. ammonium sulfate)
- 36 ammonium sulphate (Am. ammonium sulfate)
- 37 recovery plant for recovering the scrubbing agents
- 38 waste water discharge
- 39 phenol extraction from the gas water
- 40 crude phenol tank
- 41 production of crude benzol (crude benzene)
- 42 crude benzol (crude benzene) tank
- 43 scrubbing oil tank
- 44 low-pressure gas main
- 45 high-pressure gas main

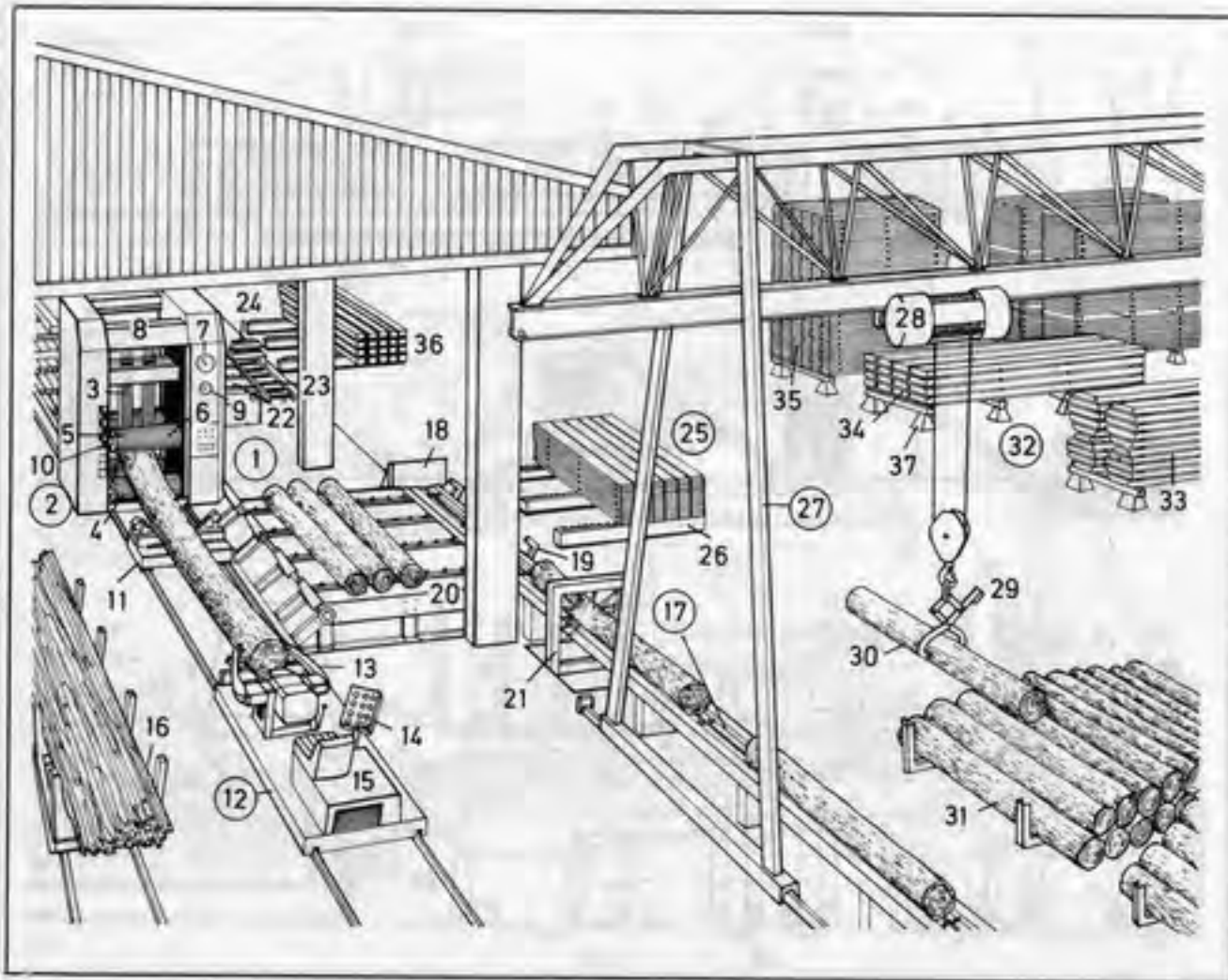

- | | |
|---|---|
| 1 sawmill | 23 roller table |
| 2 vertical frame saw (<i>Am.</i> gang mill) | 24 undercut swing saw |
| 3 saw blades | 25 piling |
| 4 feed roller | 26 roller trestles |
| 5 guide roller | 27 gantry crane |
| 6 fluting (grooving, grooves) | 28 crane motor |
| 7 oil pressure gauge (<i>Am.</i> gage) | 29 pivoted log grips |
| 8 saw frame | 30 roundwood (round timber) |
| 9 feed indicator | 31 log dump |
| 10 log capacity scale | 32 squared timber store |
| 11 auxiliary carriage | 33 sawn logs |
| 12 carriage | 34 planks |
| 13 log grips | 35 boards (planks) |
| 14 remote control panel | 36 squared timber |
| 15 carriage motor | 37 stack bearer |
| 16 truck for splinters (splints) | 38 automatic cross-cut chain saw |
| 17 endless log chain (<i>Am.</i> jack chain) | 39 log grips |
| 18 stop plate | 40 feed roller |
| 19 log-kicker arms | 41 chain-tensioning device |
| 20 cross conveyor | 42 saw-sharpening machine |
| 21 washer (washing machine) | 43 grinding wheel (teeth grinder) |
| 22 cross chain conveyor for sawn timber | 44 feed pawl |
| | 45 depth adjustment for the teeth grinder |

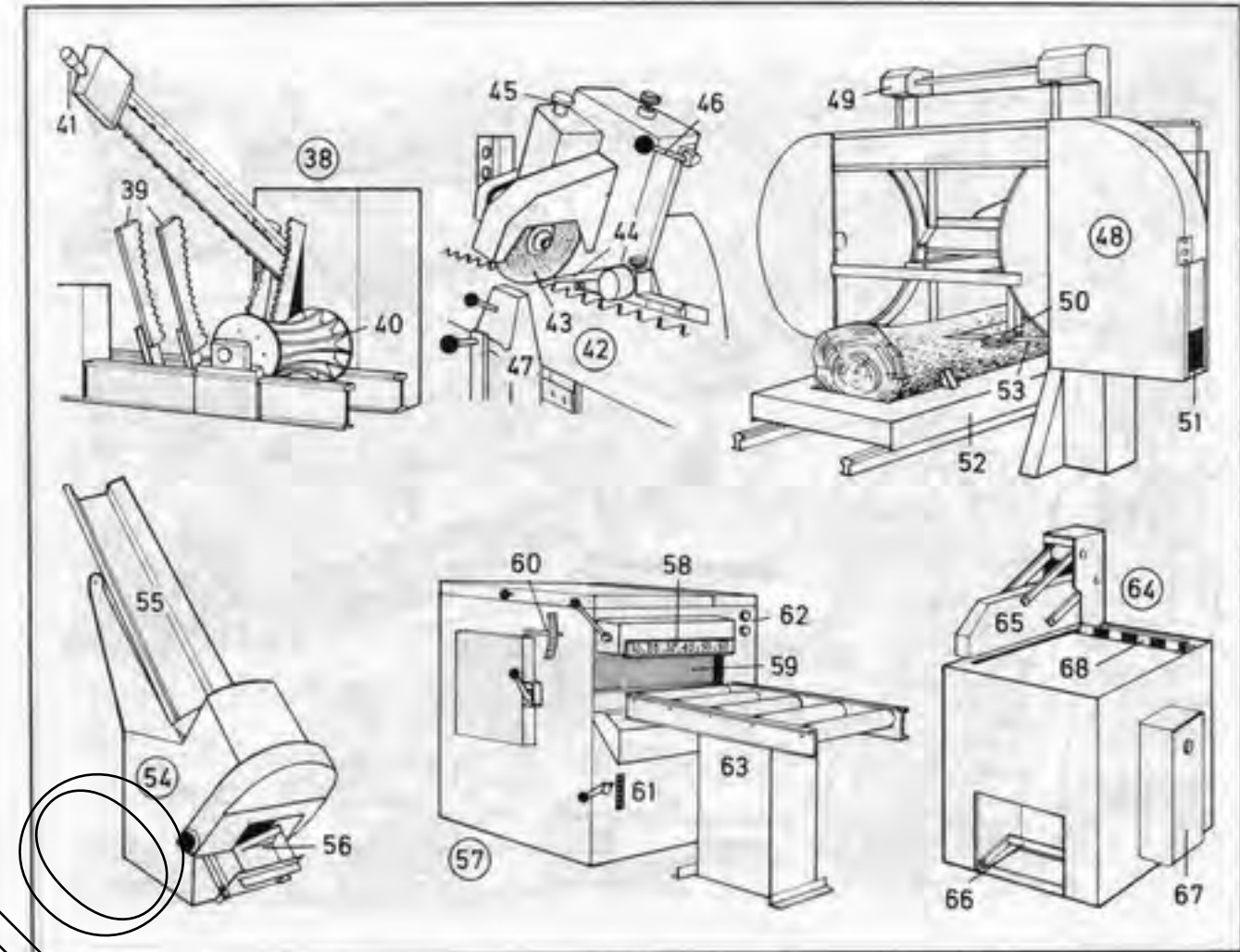

- | | |
|---|---|
| 46 lifter (lever) for the grinder chuck | 65 automatic hold-down with protective hood |
| 47 holding device for the saw blade | 66 foot switch |
| 48 horizontal bandsaw for sawing logs | 67 distribution board (panelboard) |
| 49 height adjustment | 68 length stop |
| 50 chip remover | |
| 51 chip extractor | |
| 52 carriage | |
| 53 bandsaw blade | |
| 54 automatic blocking saw | |
| 55 feed channel | |
| 56 discharge opening | |
| 57 twin edger (double edger) | |
| 58 breadth scale (width scale) | |
| 59 kick-back guard | |
| 60 height scale | |
| 61 in-feed scale | |
| 62 indicator lamps | |
| 63 feed table | |
| 64 undercut swing saw | |

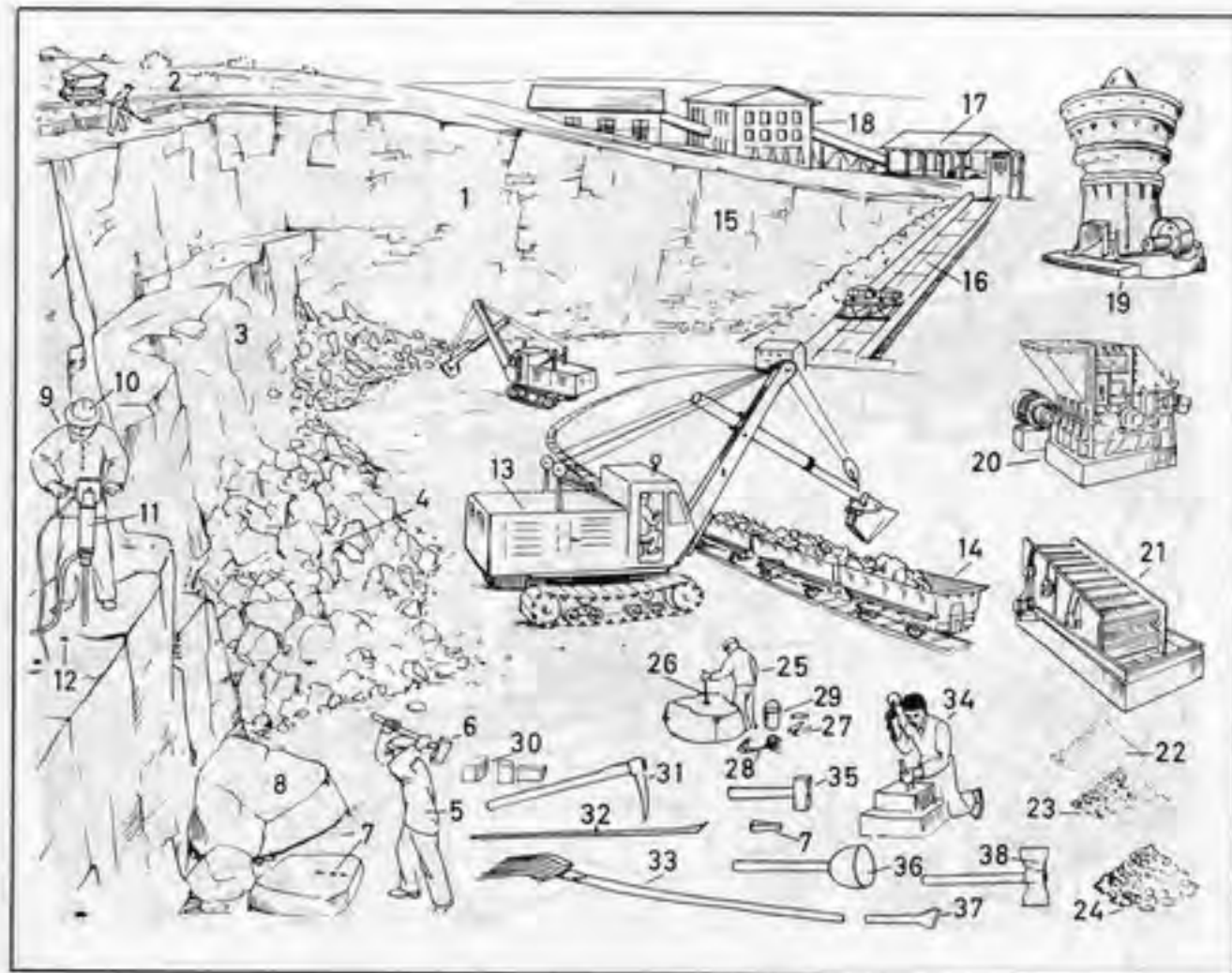

- | | |
|---|--|
| 1 quarry, an open-cast working | 21 vibrating screen |
| 2 overburden | 22 screenings (fine dust) |
| 3 working face | 23 stone chippings |
| 4 loose rock pile (blasted rock) | 24 crushed stone |
| 5 quarryman (quarrier), a quarry worker | 25 shot firer |
| 6 sledge hammer | 26 measuring rod |
| 7 wedge | 27 blasting cartridge |
| 8 block of stone | 28 fuse (blasting fuse) |
| 9 driller | 29 plugging sand (stemming sand) bucket |
| 10 safety helmet | 30 dressed stone |
| 11 hammer drill (hard-rock drill) | 31 pick |
| 12 borehole | 32 crowbar (pinch bar) |
| 13 universal excavator | 33 fork |
| 14 large-capacity truck | 34 stonemason |
| 15 rock face | 35-38 stonemason's tools |
| 16 inclined hoist | 35 stonemason's hammer |
| 17 primary crusher | 36 mallet |
| 18 stone-crushing plant | 37 drove chisel (drove, boaster, broad chisel) |
| 19 coarse rotary (gyratory) crusher; <i>sim.</i> : fine rotary (gyratory) crusher | 38 dressing axe (<i>Am.</i> ax) |
| 20 hammer crusher (impact crusher) | |

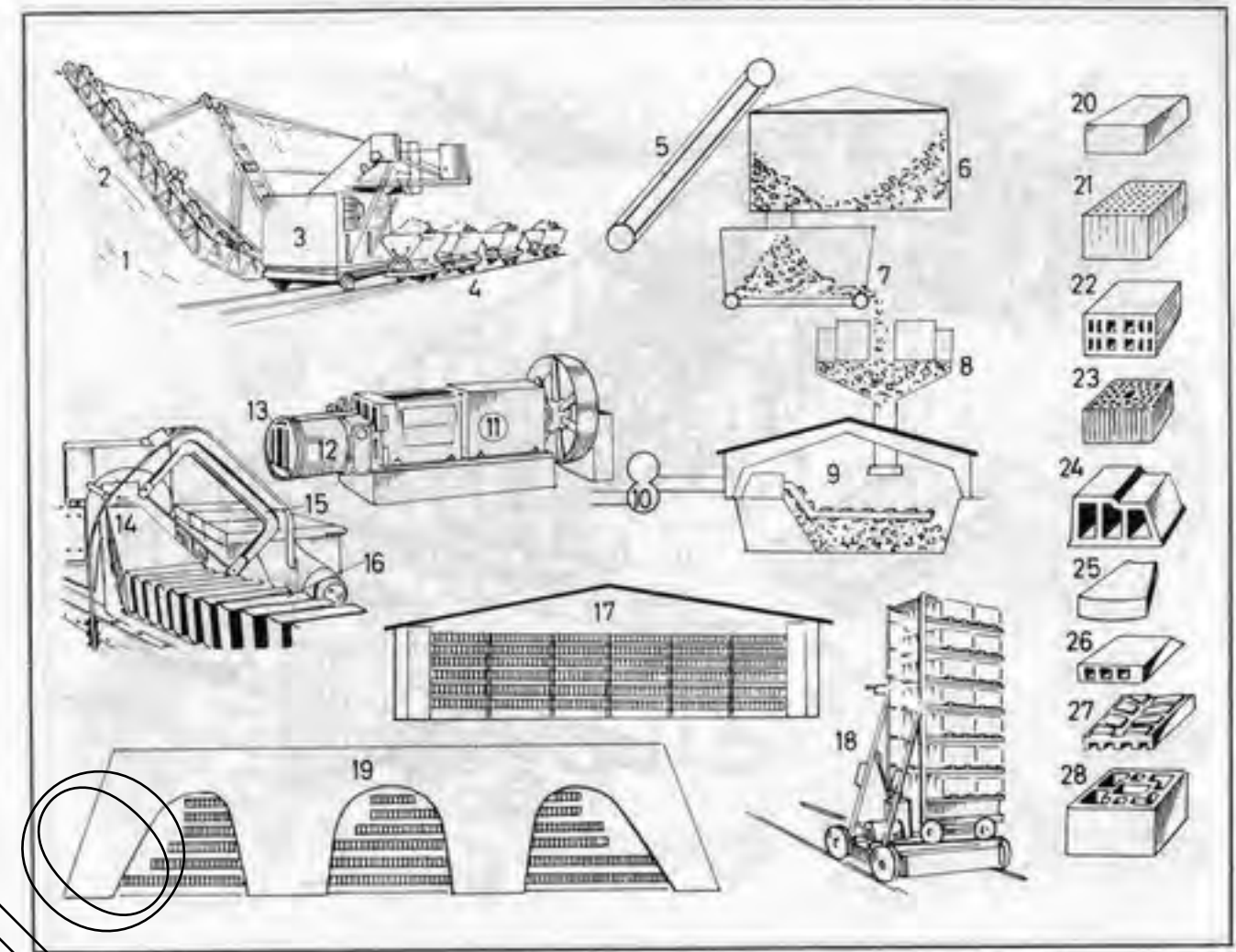

- | | |
|--|--|
| 1 clay pit | 20 solid brick (building brick) |
| 2 loam, an impure clay (raw clay) | 21-22 perforated bricks and hollow blocks |
| 3 overburden excavator, a large-scale excavator | 21 perforated brick with vertical perforations |
| 4 narrow-gauge (<i>Am.</i> narrow-gauge) track system | 22 hollow clay block with horizontal perforations |
| 5 inclined hoist | 23 hollow clay block with vertical perforations |
| 6 soring chambers | 24 floor brick |
| 7 box feeder (feeder) | 25 compass brick (radial brick, radiating brick) |
| 8 edge runner mill (edge mill, pan grinding mill) | 26 hollow flooring block |
| 9 rolling plant | 27 paving brick |
| 10 double-shaft trough mixer (mixer) | 28 cellular brick [for fireplaces] (chimney brick) |
| 11 extrusion press (brick-pressing machine) | |
| 12 vacuum chamber | |
| 13 die | |
| 14 clay column | |
| 15 cutter (brick cutter) | |
| 16 unfired brick (green brick) | |
| 17 drying shed | |
| 18 mechanical finger car (stacker truck) | |
| 19 circular kiln (brick kiln) | |

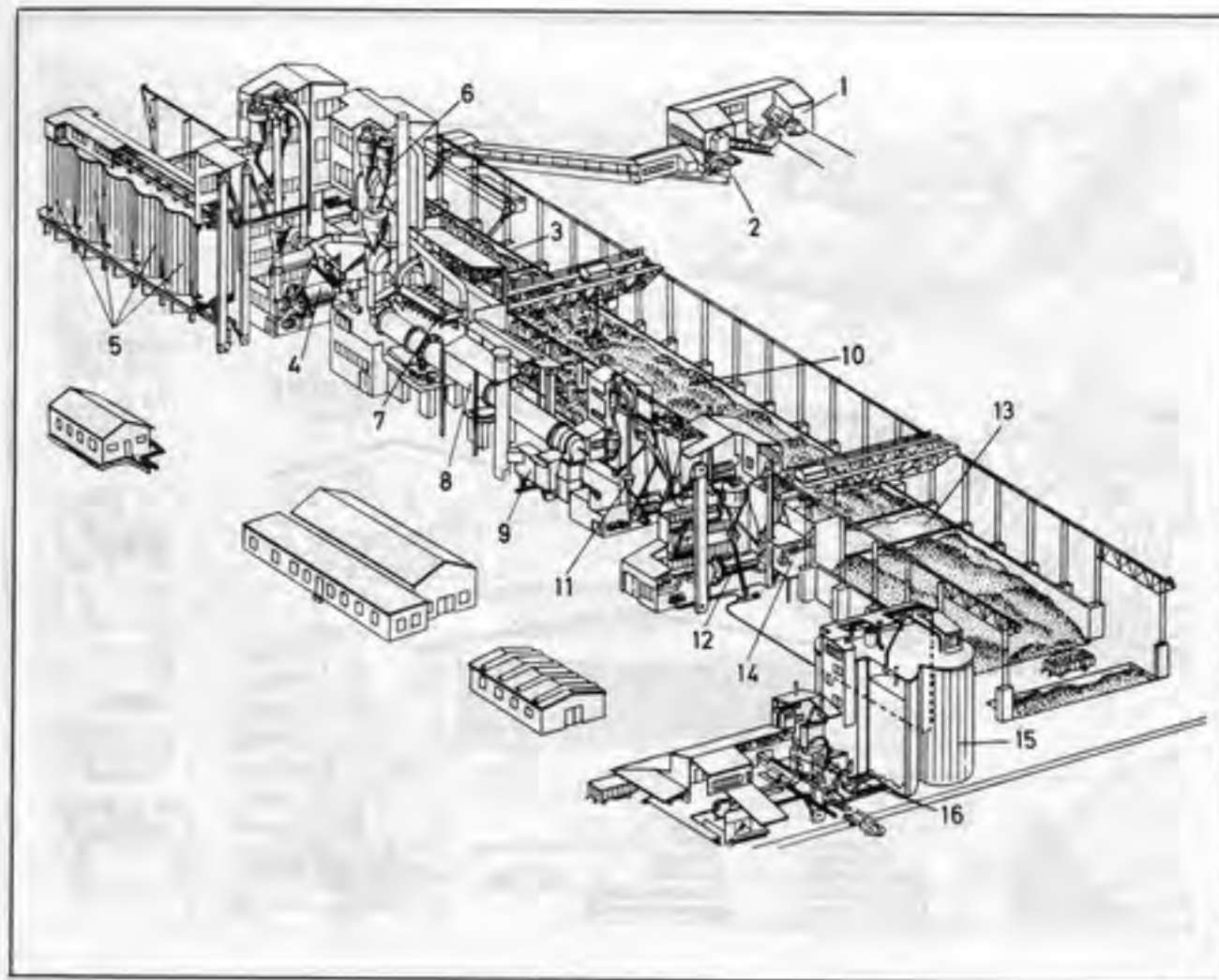

- 1 raw materials (limestone, clay, and marl)
- 2 hammer crusher (hammer mill)
- 3 raw material store
- 4 raw mill for simultaneously grinding and drying the raw materials with exhaust gas from the heat exchanger
- 5 raw meal silos
- 6 heat exchanger (cyclone heat exchanger)
- 7 dust collector (an electrostatic precipitator) for the heat exchanger exhaust from the raw mill
- 8 rotary kiln
- 9 clinker cooler
- 10 clinker store
- 11 primary air blower
- 12 cement-grinding mill
- 13 gypsum store
- 14 gypsum crusher
- 15 cement silo
- 16 cement-packing plant

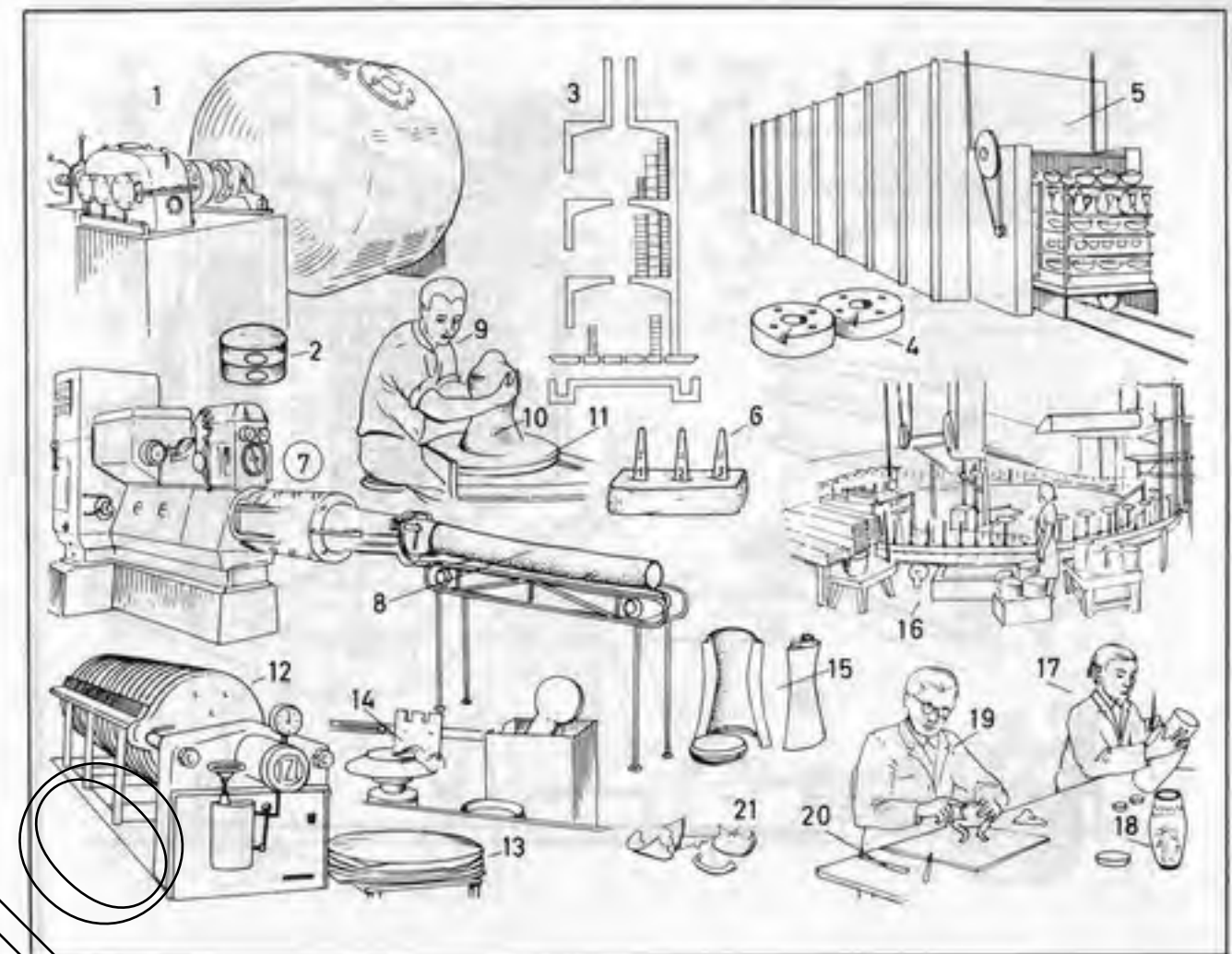

- 1 grinding cylinder (ball mill) for the preparation of the raw material in water
- 2 sample sagger (saggar, seggar), with aperture for observing the firing process
- 3 bottle kiln (beehive kiln) [diagram]
- 4 firing mould (*Am. mold*)
- 5 tunnel kiln
- 6 Seger cone (pyrometric cone, *Am. Orton cone*) for measuring high temperatures
- 7 de-airing pug mill (de-airing pug press), an extrusion press
- 8 clay column
- 9 thrower throwing a ball (bat) of clay
- 10 slug of clay
- 11 turntable; *sim.*: potter's wheel
- 12 filter press
- 13 filter cake
- 14 jiggering, with a profiling tool; *sim.*: jollying
- 15 plaster mould (*Am. mold*) for slip casting
- 16 turntable glazing machine
- 17 porcelain painter (*china painter*)
- 18 hand-painted vase
- 19 repairer
- 20 pallet (modelling, *Am. modeling, tool*)
- 21 shards (sherds, potsherds)

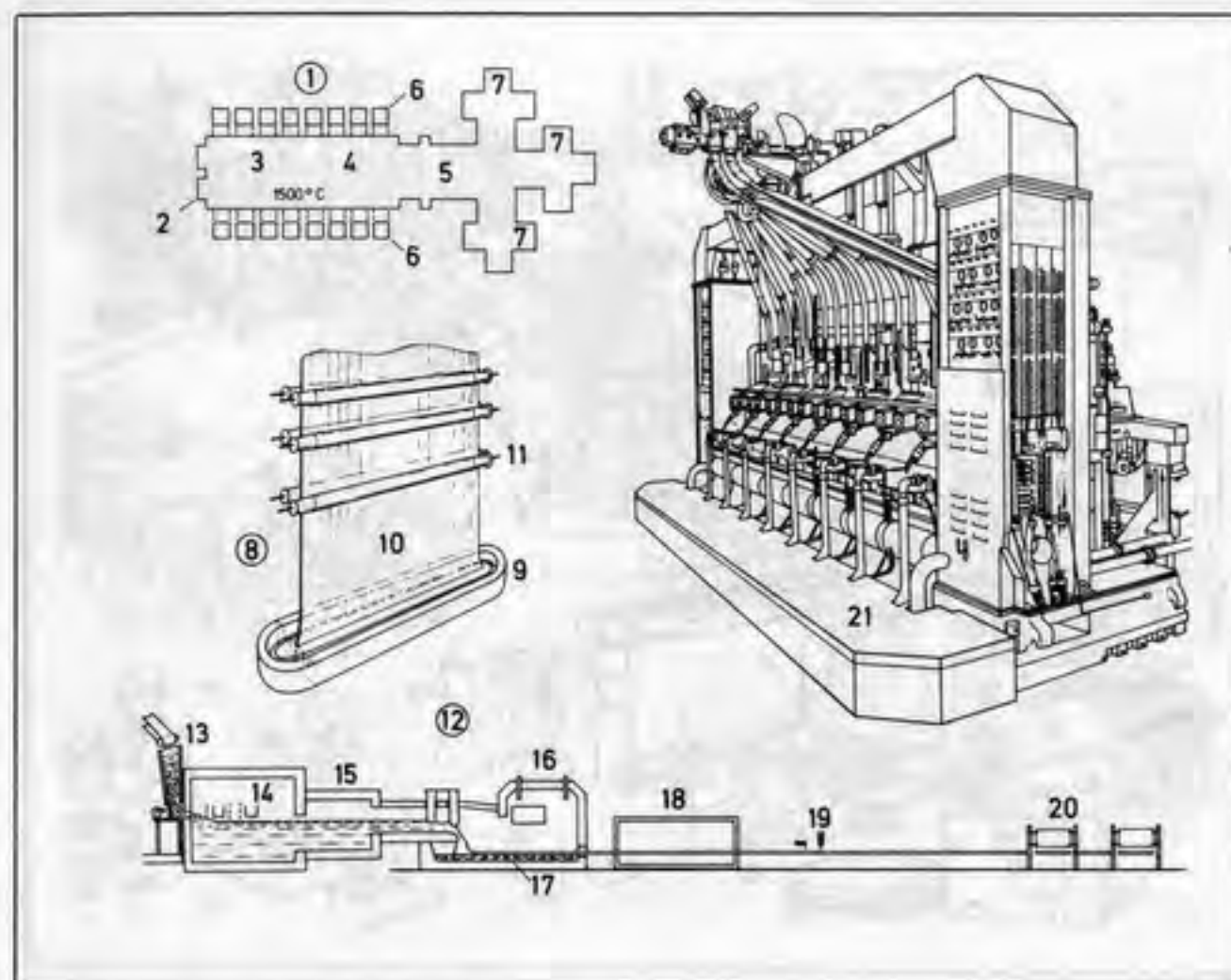

1-20 sheet glass production (flat glass production)

- 1 glass furnace (tank furnace) for the Fourcault process [diagram]
- 2 filling end, for feeding in the batch (frit)
- 3 melting bath
- 4 refining bath (fining bath)
- 5 working baths (working area)
- 6 burners
- 7 drawing machines
- 8 Fourcault glass-drawing machine
- 9 slot
- 10 glass ribbon (ribbon of glass, sheet of glass) being drawn upwards
- 11 rollers (drawing rolls)
- 12 float glass process
- 13 batch (frit) feeder (funnel)
- 14 melting bath
- 15 cooling tank
- 16 float bath in a protective inert-gas atmosphere
- 17 molten tin

- 18 annealing lehr
- 19 automatic cutter
- 20 stacking machines
- 21 IS (individual-section) machine, a bottle-making machine
- 22-37 blowing processes
- 22 blow-and-blow process
- 23 introduction of the gob of molten glass
- 24 first blowing
- 25 suction
- 26 transfer from the parison mould (*Am. mold*) to the blow mould (*Am. mold*)
- 27 reheating
- 28 blowing (suction, final shaping)
- 29 delivery of the completed vessel
- 30 press-and-blow process
- 31 introduction of the gob of molten glass
- 32 plunger
- 33 pressing
- 34 transfer from the press mould (*Am. mold*) to the blow mould (*Am. mold*)

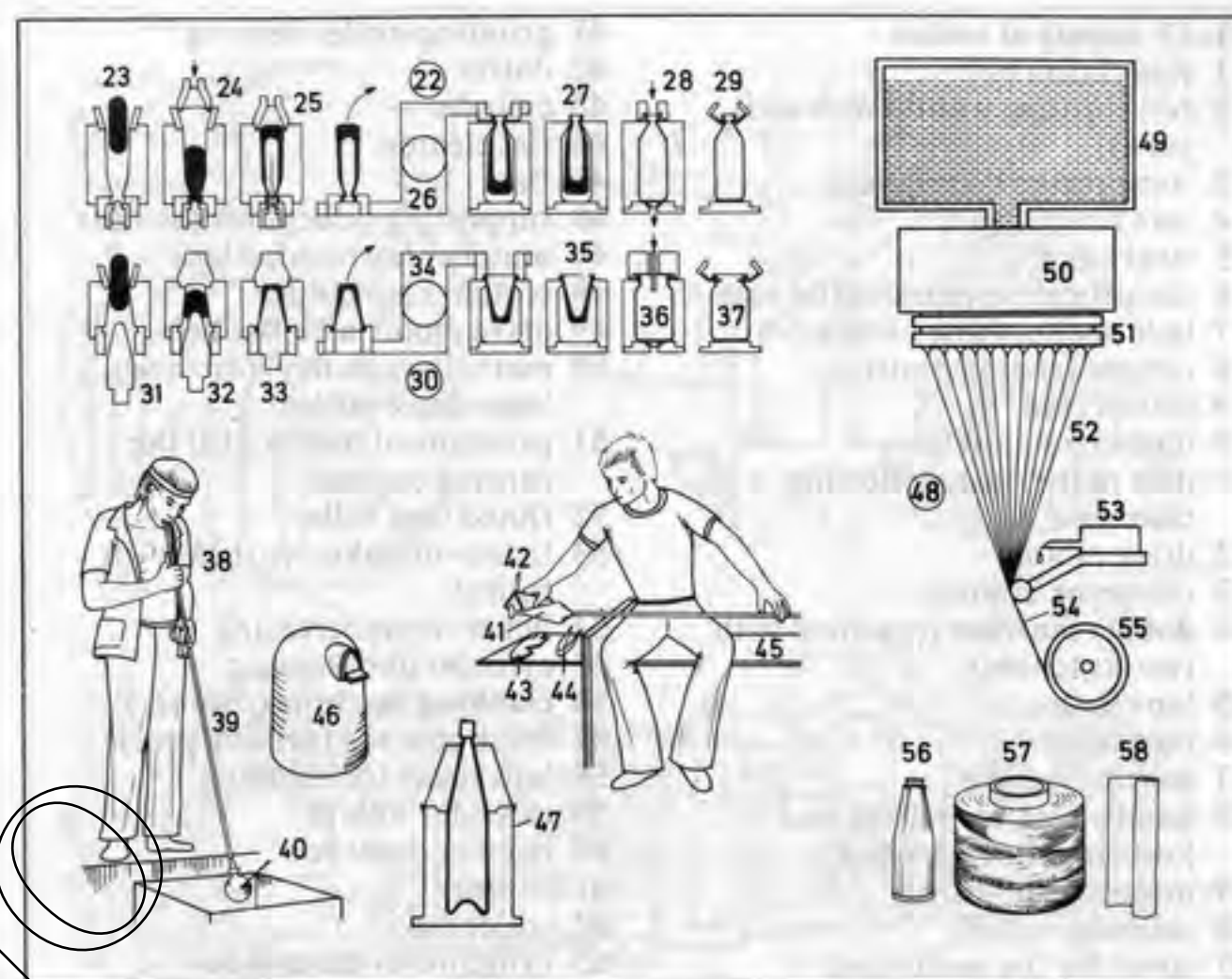

- 35 reheating
- 36 blowing (suction, final shaping)
- 37 delivery of the completed vessel
- 38-47 glassmaking (glassblowing, glassblowing by hand, glass forming)
- 38 glassmaker (glassblower)
- 39 blowing iron
- 40 gob
- 41 hand-blown goblet
- 42 clappers for shaping the base (foot) of the goblet
- 43 trimming tool
- 44 tongs
- 45 glassmaker's chair (gaffer's chair)
- 46 covered glasshouse pot
- 47 mould (*Am. mold*), into which the parison is blown
- 48-55 production of glass fibre (*Am. glass fiber*)
- 48 continuous filament process
- 49 glass furnace
- 50 bushing containing molten glass
- 51 bushing tips

- 52 glass filaments
- 53 sizing
- 54 strand (thread)
- 55 spool
- 56-58 glass fibre (*Am. glass fiber*) products
- 56 glass yarn (glass thread)
- 57 sleeved glass yarn (glass thread)
- 58 glass wool

- 1-13 supply of cotton
- 1 ripe cotton boll
 - 2 full cop (cop wound with weft yarn)
 - 3 compressed cotton bale
 - 4 jute wrapping
 - 5 steel band
 - 6 identification mark of the bale
 - 7 bale opener (bale breaker)
 - 8 cotton-feeding brattice
 - 9 cotton feed
 - 10 dust extraction fan
 - 11 duct to the dust-collecting chamber
 - 12 drive motor
 - 13 conveyor brattice
 - 14 double scutcher (machine with two scutchers)
 - 15 lap cradle
 - 16 rack head
 - 17 starting handle
 - 18 handwheel, for raising and lowering the rack head
 - 19 movable lap-turner
 - 20 calender rollers
 - 21 cover for the perforated cylinders
 - 22 dust escape flue (dust discharge flue)
 - 23 drive motors (beater drive motors)
 - 24 beater driving shaft
 - 25 three-blade beater (Kirschner beater)
 - 26 grid [for impurities to drop]
 - 27 pedal roller (pedal cylinder)
 - 28 control lever for the pedal roller, a pedal lever
 - 29 variable change-speed gear
 - 30 cone drum box
 - 31 stop and start levers for the hopper
 - 32 wooden hopper delivery roller
 - 33 hopper feeder
 - 34 carding machine (card, carding engine)
 - 35 card can (carding can), for receiving the coiled sliver
 - 36 can holder
 - 37 calender rollers
 - 38 carded sliver (card sliver)
 - 39 vibrating doffer comb
 - 40 start-stop lever
 - 41 grinding-roller bearing
 - 42 doffer
 - 43 cylinder
 - 44 flat clearer
 - 45 flats
 - 46 supporting pulleys for the flats
 - 47 scutcher lap (carded lap)
 - 48 scutcher lap holder
 - 49 drive motor with flat belt
 - 50 main drive pulley (fast-and-loose drive pulley)
 - 51 principle of the card (of the carding engine)
 - 52 fluted feed roller
 - 53 licker-in (taker-in, licker-in roller)
 - 54 licker-in undercasing
 - 55 cylinder undercasing
 - 56 combing machine (comber)
 - 57 drive gearbox (driving gear)
 - 58 laps ready for combing
 - 59 calender rollers
 - 60 comber draw box
 - 61 counter
 - 62 coiler top
 - 63 principle of the comber
 - 64 lap
 - 65 bottom nipper
 - 66 top nipper
 - 67 top comb
 - 68 combing cylinder
 - 69 plain part of the cylinder
 - 70 needed part of the cylinder
 - 71 detaching rollers
 - 72 carded and combed sliver

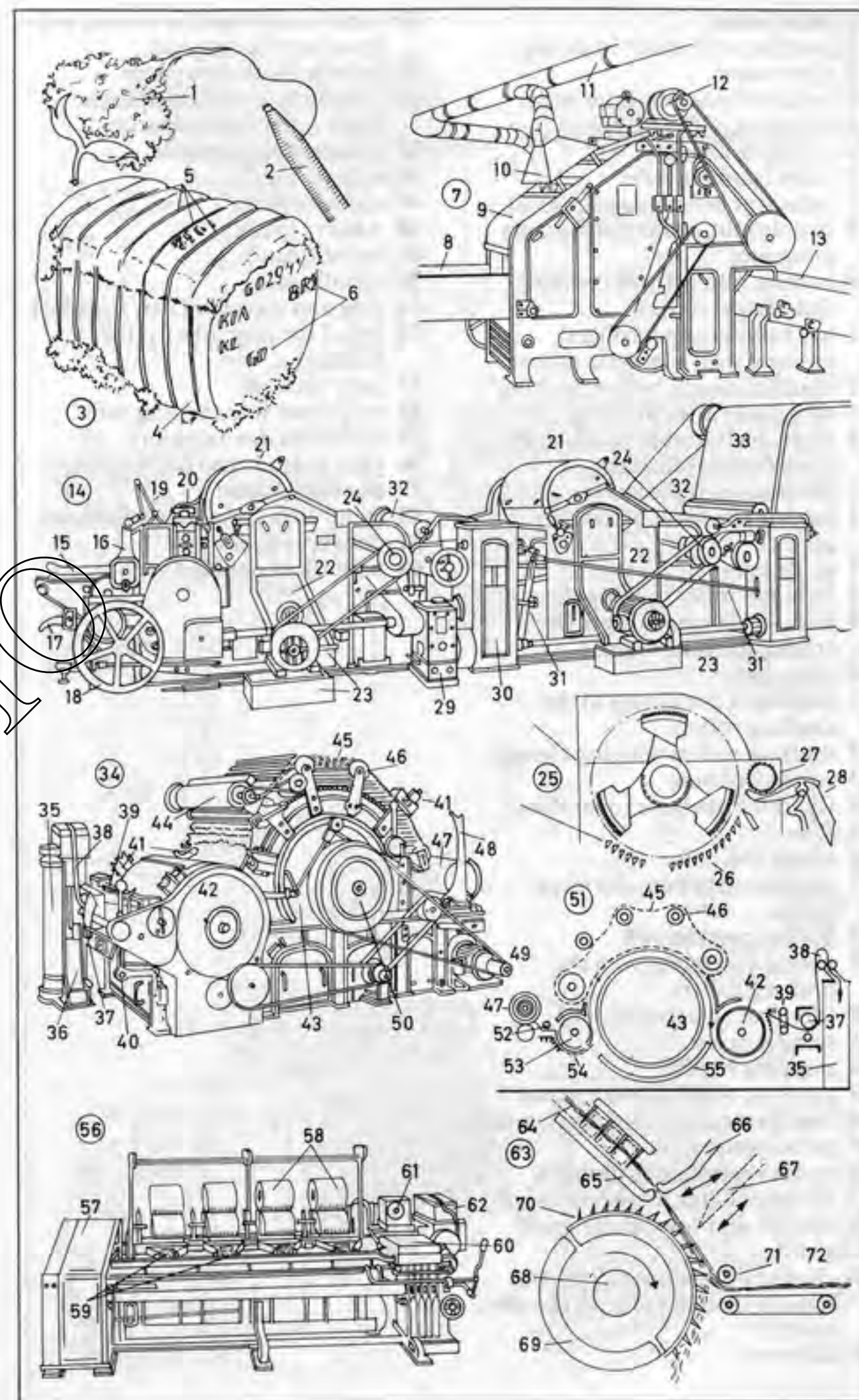

- 1 draw frame
- 2 gearbox with built-in motor
- 3 sliver cans
- 4 broken thread detector roller
- 5 doubling of the slivers
- 6 stopping handle
- 7 draw frame cover
- 8 indicator lamps (signal lights)
- 9 simple four-roller draw frame [diagram]
- 10 bottom rollers (lower rollers), fluted steel rollers
- 11 top rollers (upper rollers) covered with synthetic rubber
- 12 doubled slivers before drafting
- 13 thin sliver after drafting
- 14 high-draft system (high-draft draw frame) [diagram]
- 15 feeding-in of the sliver
- 16 leather apron (composition apron)
- 17 guide bar
- 18 light top roller (guide roller)
- 19 high-draft speed frame (fly frame, slubbing frame)
- 20 sliver cans
- 21 feeding of the slivers to the drafting rollers
- 22 drafting rollers with top clearers
- 23 roving bobbins
- 24 fly frame operator (operative)
- 25 flyer
- 26 frame end plate
- 27 intermediate yarn-forming frame
- 28 bobbin creel (creel)
- 29 roving emerging from the drafting rollers
- 30 lifter rail (separating rail)
- 31 spindle drive
- 32 stopping handle
- 33 gearbox, with built-on motor
- 34 ring frame (ring spinning frame)
- 35 three-phase motor
- 36 motor base plate (bedplate)
- 37 lifting bolt [for motor removal]
- 38 control gear for spindle speed
- 39 gearbox
- 40 change wheels for varying the spindle speed [to change the yarn count]
- 41 full creel

- 42 shafts and levers for raising and lowering the ring rail
- 43 spindles with separators
- 44 suction box connected to the front roller underclearers
- 45 standard ring spindle
- 46 spindle shaft
- 47 roller bearing
- 48 wharve (pulley)
- 49 spindle catch
- 50 spindle rail
- 51 ring and traveller (*Am. traveler*)
- 52 top of the ring tube (of the bobbin)
- 53 yarn (thread)
- 54 ring fitted into the ring rail
- 55 traveller (*Am. traveler*)
- 56 yarn wound onto the bobbin
- 57 doubling frame
- 58 creel, with cross-wound cheeses
- 59 delivery rollers
- 60 bobbins of doubled yarn

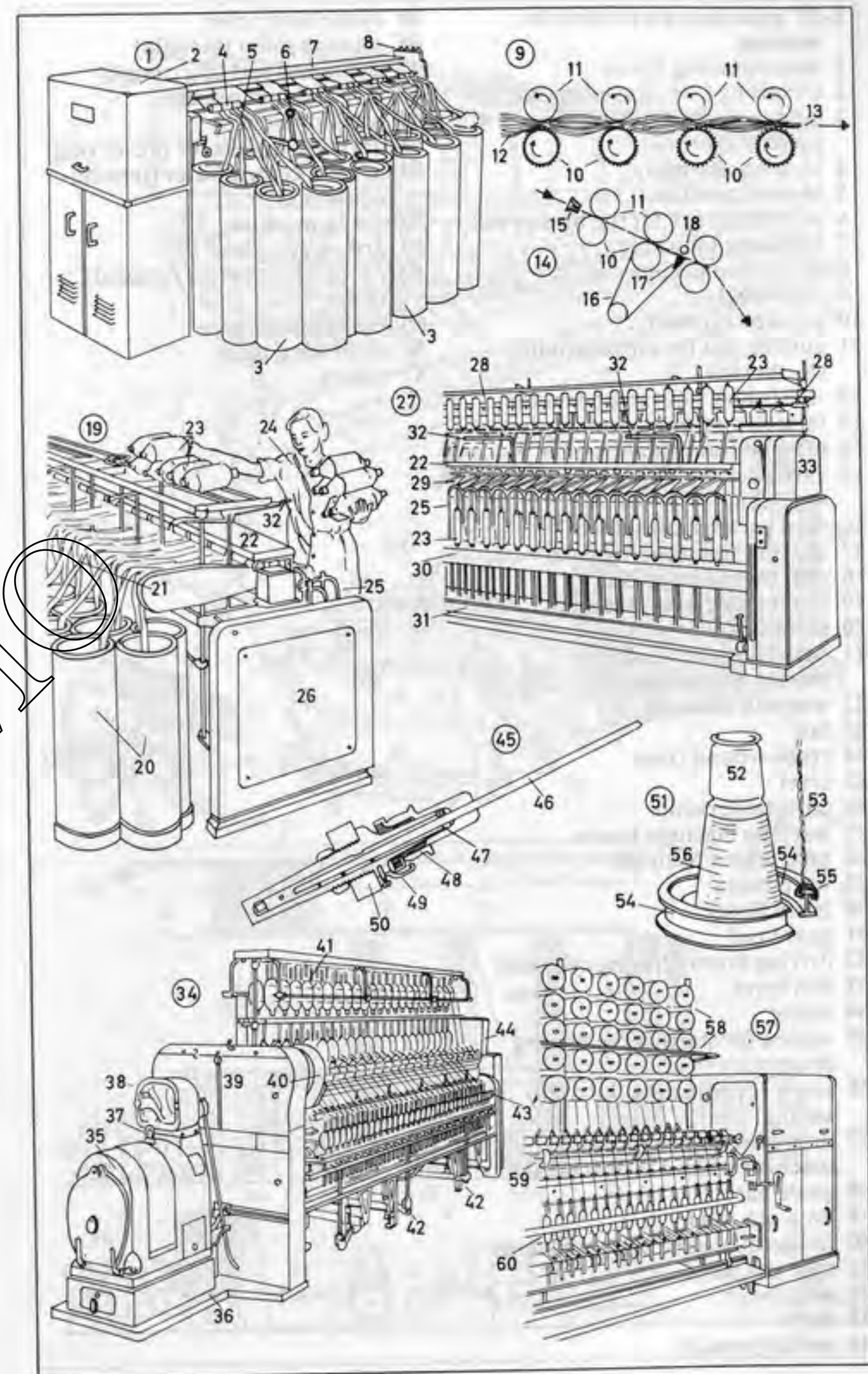

- 1-57 processes preparatory to weaving
- 1 cone-winding frame
- 2 travelling (*Am.* traveling) blower
- 3 guide rail, for the travelling (*Am.* traveling) blower
- 4 blowing assembly
- 5 blower aperture
- 6 superstructure for the blower rail
- 7 full-cone indicator
- 8 cross-wound cone
- 9 cone creel
- 10 grooved cylinder
- 11 guiding slot for cross-winding the threads
- 12 side frame, housing the motor
- 13 tension and slub-catching device
- 14 off-end framing with filter
- 15 yarn package, a ring tube or mule cop
- 16 yarn package container
- 17 starting and stopping lever
- 18 self-threading guide
- 19 broken thread stop motion
- 20 thread clearer
- 21 weighting disc (disk) for tensioning the thread
- 22 warping machine
- 23 fan
- 24 cross-wound cone
- 25 creel
- 26 adjustable comb
- 27 warping machine frame
- 28 yarn length recorder
- 29 warp beam
- 30 beam flange
- 31 guard rail
- 32 driving drum (driving cylinder)
- 33 belt drive
- 34 motor
- 35 release for starting the driving drum
- 36 screw for adjusting the comb setting
- 37 drop pins, for stopping the machine when a thread breaks
- 38 guide bar
- 39 drop pin rollers
- 40 indigo dying and sizing machine
- 41 take-off stand
- 42 warp beam
- 43 warp
- 44 wetting trough

- 45 immersion roller
- 46 squeeze roller (mangle)
- 47 dye liquor padding trough
- 48 air oxidation passage
- 49 washing trough
- 50 drying cylinders for pre-drying
- 51 tension compensator (tension equalizer)
- 52 sizing machine
- 53 drying cylinders
- 54 *for cotton: stenter; for wool: tenter*
- 55 beaming machine
- 56 sized warp beam
- 57 rollers

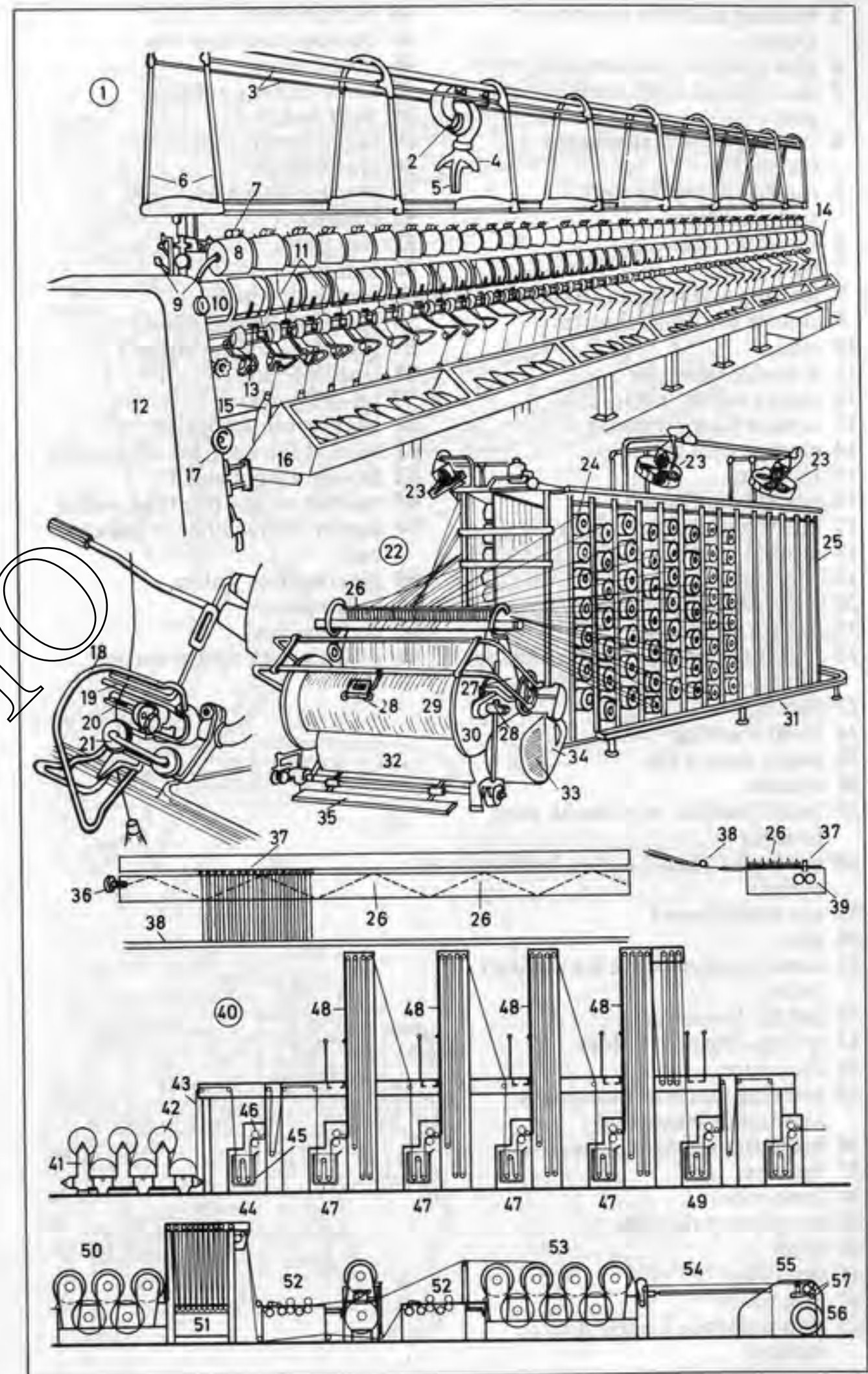

- 1 weaving machine (automatic loom)
- 2 pick counter (tachometer)
- 3 shaft (heald shaft, heald frame guide)
- 4 shafts (heald shafts, heald frames)
- 5 rotary battery for weft replenishment
- 6 sley (slay) cap
- 7 weft pirn
- 8 starting and stopping handle
- 9 shuttle box, with shuttles
- 10 reed
- 11 selvage (selvage)
- 12 cloth (woven fabric)
- 13 temple (cloth temple)
- 14 electric weft feeler
- 15 flywheel
- 16 breast beam board
- 17 picking stick (pick stick)
- 18 electric motor
- 19 cloth take-up motion
- 20 cloth roller (fabric roller)
- 21 can for empty pirns
- 22 lug strap, for moving the picking stick
- 23 fuse box
- 24 loom framing
- 25 metal shuttle tip
- 26 shuttle
- 27 heald (heddle, wire heald, wire heddle)
- 28 eye (eyelet, heald eyelet, heddle eyelet)
- 29 eye (shuttle eye)
- 30 pirn
- 31 metal contact sleeve for the weft feeler
- 32 slot for the feeler
- 33 spring-clip pirn holder
- 34 drop wire
- 35 weaving machine (automatic loom) [side elevation]
- 36 heald shaft guiding wheels
- 37 backrest
- 38 lease rods
- 39 warp (warp thread)
- 40 shed
- 41 sley (slay)
- 42 race board
- 43 stop rod blade for the stop motion
- 44 bumper steel
- 45 bumper steel stop rod
- 46 breast beam
- 47 cloth take-up roller
- 48 warp beam
- 49 beam flange
- 50 crankshaft
- 51 crankshaft wheel
- 52 connector
- 53 sley (slay)
- 54 lam rods
- 55 camshaft wheel
- 56 camshaft (tappet shaft)
- 57 tappet (shedding tappet)
- 58 treadle lever
- 59 let-off motion
- 60 beam motion control
- 61 rope of the warp let-off motion
- 62 let-off weight lever
- 63 control weight [for the treadle]
- 64 picker with leather or bakelite pad
- 65 picking stick buffer
- 66 picking cam
- 67 picking bowl
- 68 picking stick return spring

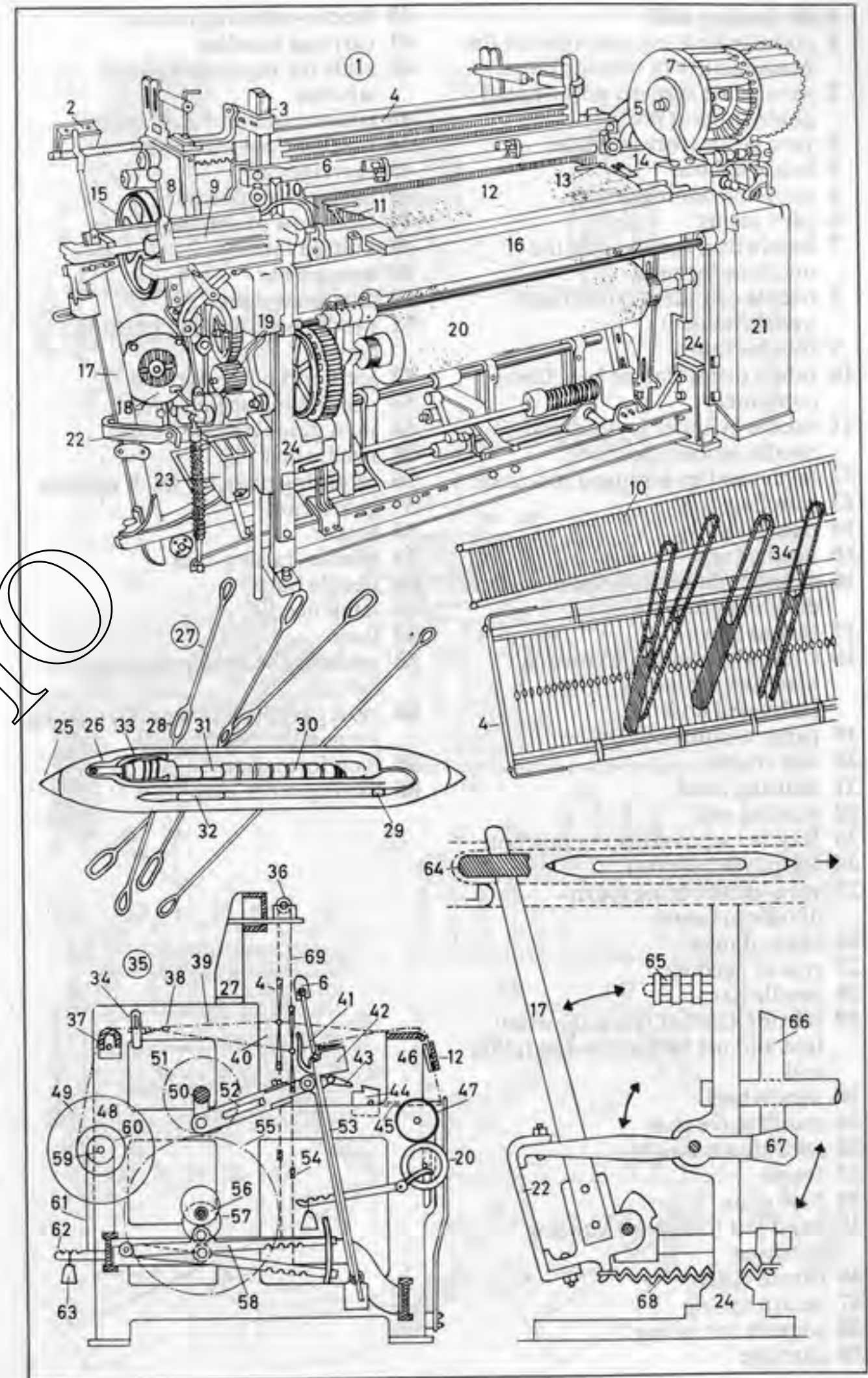

DEMO

- 1-66 hosiery mill
- 1 circular knitting machine for the manufacture of tubular fabric
 - 2 yarn guide support post (thread guide support post)
 - 3 yarn guide (thread guide)
 - 4 bottle bobbin
 - 5 yarn-tensioning device
 - 6 yarn feeder
 - 7 handwheel for rotating the machine by hand
 - 8 needle cylinder (cylindrical needle holder)
 - 9 tubular fabric
 - 10 fabric drum (fabric box, fabric container)
 - 11 needle cylinder (cylindrical needle holder) [section]
 - 12 latch needles arranged in a circle
 - 13 cam housing
 - 14 needle cams
 - 15 needle trick
 - 16 cylinder diameter (also diameter of tubular fabric)
 - 17 thread (yarn)
 - 18 Cotton's patent flat knitting machine for ladies' fully-fashioned hose
 - 19 pattern control chain
 - 20 side frame
 - 21 knitting head
 - 22 starting rod
 - 23 Raschel warp-knitting machine
 - 24 warp (warp beam)
 - 25 yarn-distributing (yarn-dividing) beam
 - 26 beam flange
 - 27 row of needles
 - 28 needle bar
 - 29 fabric (Raschel fabric) [curtain lace and net fabrics] on the fabric roll
 - 30 handwheel
 - 31 motor drive gear
 - 32 take-down weight
 - 33 frame
 - 34 base plate
 - 35 hand flat (flat-bed) knitting machine
 - 36 thread (yarn)
 - 37 return spring
 - 38 support for springs
 - 39 carriage
 - 40 feeder-selecting device
 - 41 carriage handles
 - 42 scale for regulating size of stitches
 - 43 course counter (tachometer)
 - 44 machine control lever
 - 45 carriage rail
 - 46 back row of needles
 - 47 front row of needles
 - 48 knitted fabric
 - 49 tension bar
 - 50 tension weight
 - 51 needle bed showing knitting action
 - 52 teeth of knock-over bit
 - 53 needles in parallel rows
 - 54 yarn guide (thread guide)
 - 55 needle bed
 - 56 retaining plate for latch needles
 - 57 guard cam
 - 58 sinker
 - 59 needle-raising cam
 - 60 needle butt
 - 61 latch needle
 - 62 loop
 - 63 pushing the needle through the fabric
 - 64 yarn guide (thread guide) placing yarn in the needle hook
 - 65 loop formation
 - 66 casting off of loop

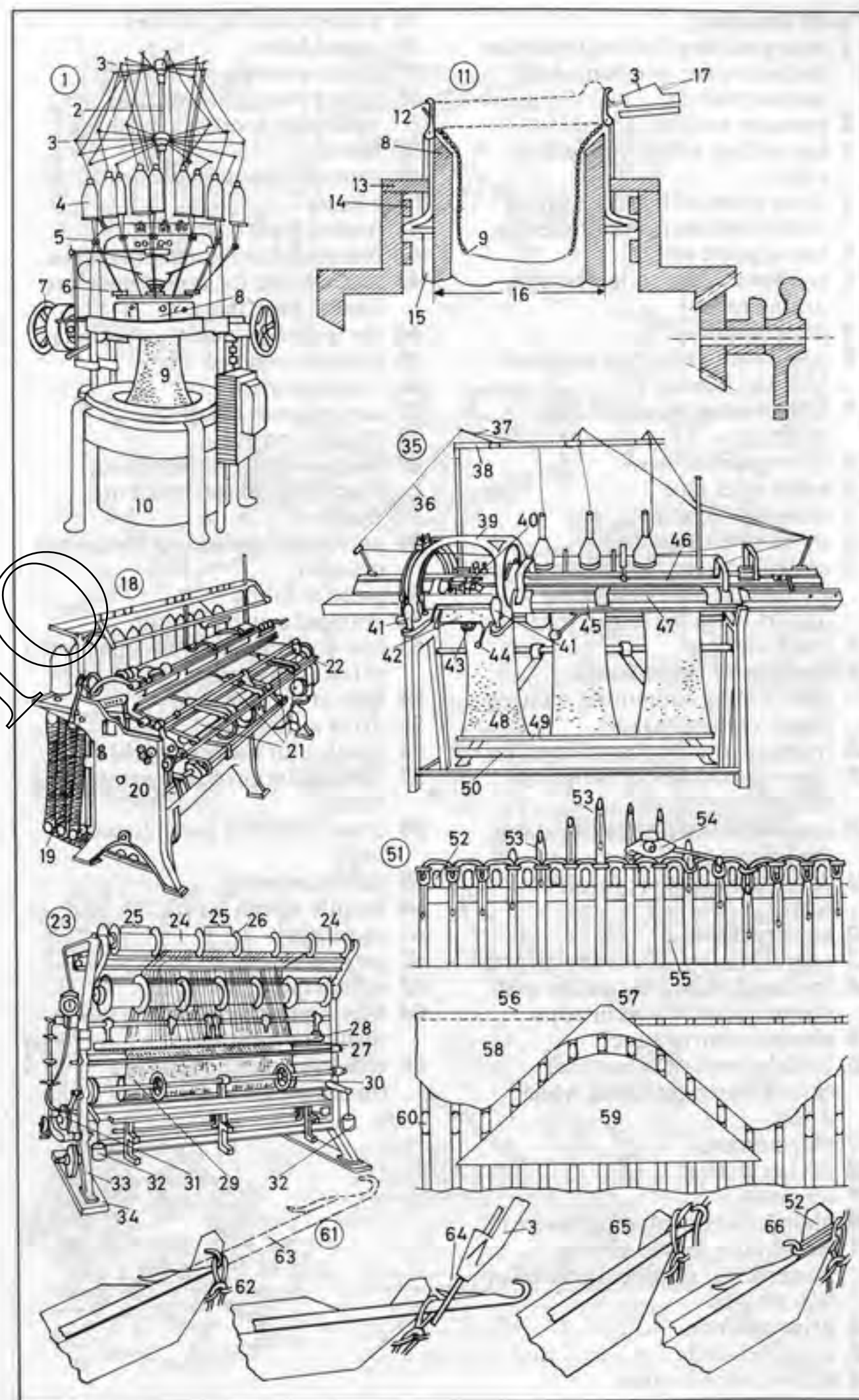

1-65 finishing

- | | |
|--|---|
| 1 rotary milling (fulling) machine for felting the woollen (<i>Am.</i> woolen) fabric | 35 plaiter (cuttling device) |
| 2 pressure weights | 36 raised fabric |
| 3 top milling roller (top fulling roller) | 37 plaiting-down platform |
| 4 drive wheel of bottom milling roller (bottom fulling roller) | 38 rotary press (calendering machine), for press finishing |
| 5 fabric guide roller | 39 fabric |
| 6 bottom milling roller (bottom fulling roller) | 40 control buttons and control wheels |
| 7 draft board | 41 heated press bowl |
| 8 open-width scouring machine for finer fabrics | 42 rotary cloth-shearing machine |
| 9 fabric being drawn off the machine | 43 suction slot, for removing loose fibres (<i>Am.</i> fibers) |
| 10 drive gearbox | 44 doctor blade (cutting cylinder) |
| 11 water inlet pipe | 45 protective guard |
| 12 drawing-in roller | 46 rotating brush |
| 13 scroll-opening roller | 47 curved scray entry |
| 14 pendulum-type hydro-extractor (centrifuge), for extracting liquors from the fabric | 48 treadle control |
| 15 machine base | 49 [non-shrinking] decatizing (decatizing) fabric-finishing machine |
| 16 casing over suspension | 50 perforated decatizing (decatizing) cylinder |
| 17 outer casing containing rotating cage (rotating basket) | 51 piece of fabric |
| 18 hydro-extractor (centrifuge) lid | 52 cranked control handle |
| 19 stop-motion device (stopping device) | 53 ten-colour (<i>Am.</i> ten-color) roller printing machine |
| 20 automatic starting and braking device | 54 base of the machine |
| 21 <i>for cotton: stenter; for wool: tenter</i> | 55 drive motor |
| 22 air-dry fabric | 56 blanket [of rubber or felt] |
| 23 operator's (operative's) platform | 57 fabric after printing (printed fabric) |
| 24 feeding of fabric by guides onto stenter (tenter) pins or clips | 58 electric control panel (control unit) |
| 25 electric control panel | 59 screen printing |
| 26 initial overfeed to produce shrink-resistant fabric when dried | 60 mobile screen frame |
| 27 thermometer | 61 squeegee |
| 28 drying section | 62 pattern stencil |
| 29 air outlet | 63 screen table |
| 30 plaiter (fabric-plaiting device) | 64 fabric gummed down on table ready for printing |
| 31 wire-roller fabric-raising machine for producing raised or nap surface | 65 screen printing operator (operative) |
| 32 drive gearbox | |
| 33 unraised cloth | |
| 34 wire-covered rollers | |

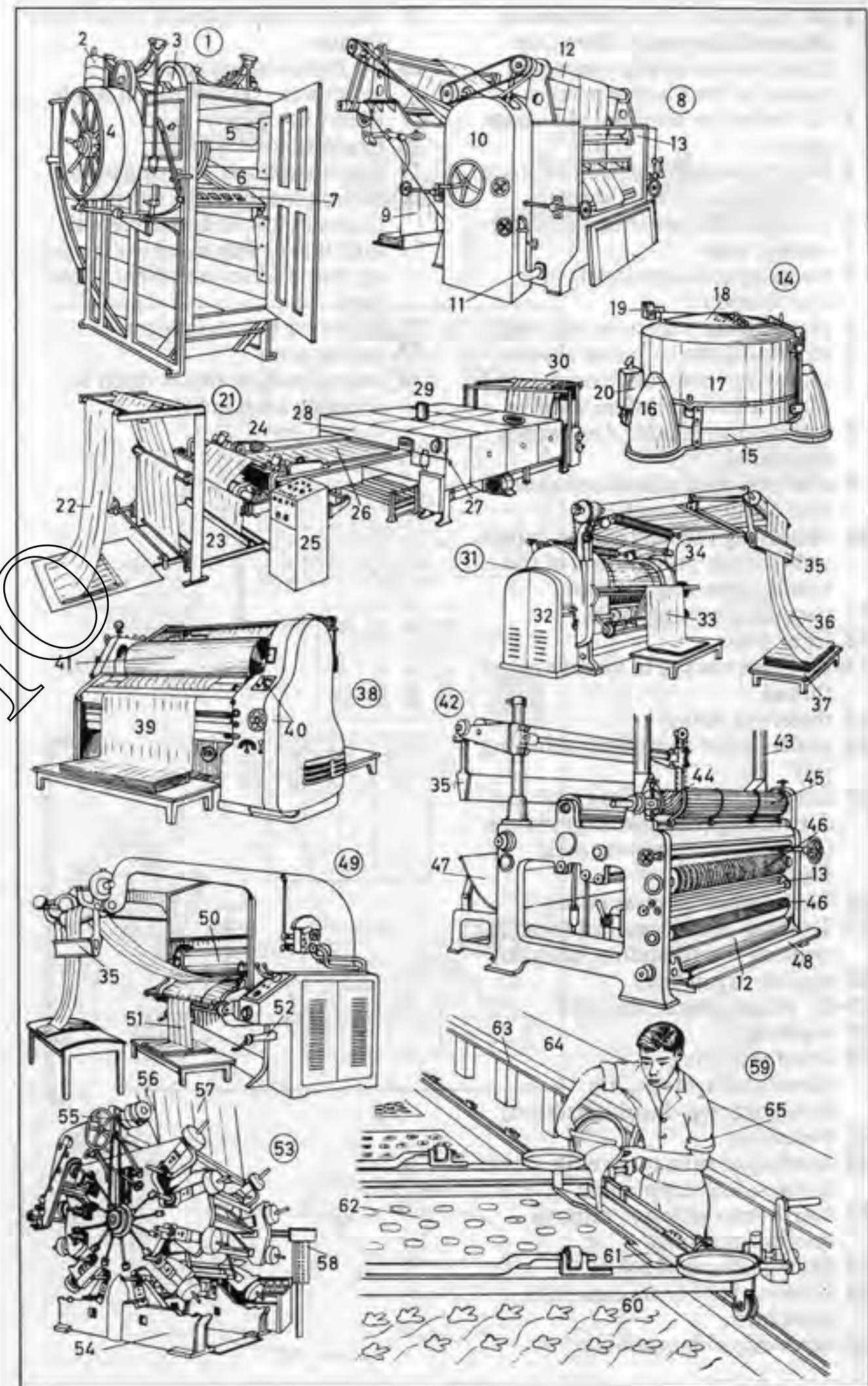

- 1-34 manufacture of **continuous filament and staple fibre** (*Am. fiber*) **viscose rayon yarns** by means of the viscose process
- 1-12 from raw material to viscose rayon
- 1 basic material [beech and spruce cellulose in form of sheets]
- 2 mixing cellulose sheets
- 3 caustic soda
- 4 steeping cellulose sheets in caustic soda
- 5 pressing out excess caustic soda
- 6 shredding the cellulose sheets
- 7 maturing (controlled oxidation) of the alkali-cellulose crumbs
- 8 carbon disulphide (*Am. carbon disulfide*)
- 9 conversion of alkali-cellulose into cellulose xanthate
- 10 dissolving the xanthate in caustic soda for the preparation of the viscose spinning solution
- 11 vacuum ripening tanks
- 12 filter press
- 13-27 from viscose to viscose rayon thread
- 13 metering pump
- 14 multi-holed spinneret (spinning jet)
- 15 coagulating (spinning) bath for converting (coagulating) viscose (viscous solution) into solid filaments
- 16 Godet wheel, a glass pulley
- 17 Topham centrifugal pot (box) for twisting the filaments into yarn
- 18 viscose rayon cake
- 19-27 processing of the cake
- 19 washing
- 20 desulphurizing (desulphurizing, *Am. desulfurizing, desulfurization*)
- 21 bleaching
- 22 treating of cake to give filaments softness and suppleness
- 23 hydro-extraction to remove surplus moisture
- 24 drying in heated room
- 25 winding yarn from cake into cone form
- 26 cone-winding machine

- 27 viscose rayon yarn on cone ready for use
- 28-34 from viscose spinning solution to viscose rayon staple fibre (*Am. fiber*)
- 28 filament tow
- 29 overhead spray washing plant
- 30 cutting machine for cutting filament tow to desired length
- 31 multiple drying machine for cut-up staple fibre (*Am. fiber*) layer (lap)
- 32 conveyor belt (conveyor)
- 33 baling press
- 34 bale of viscose rayon ready for dispatch (despatch)

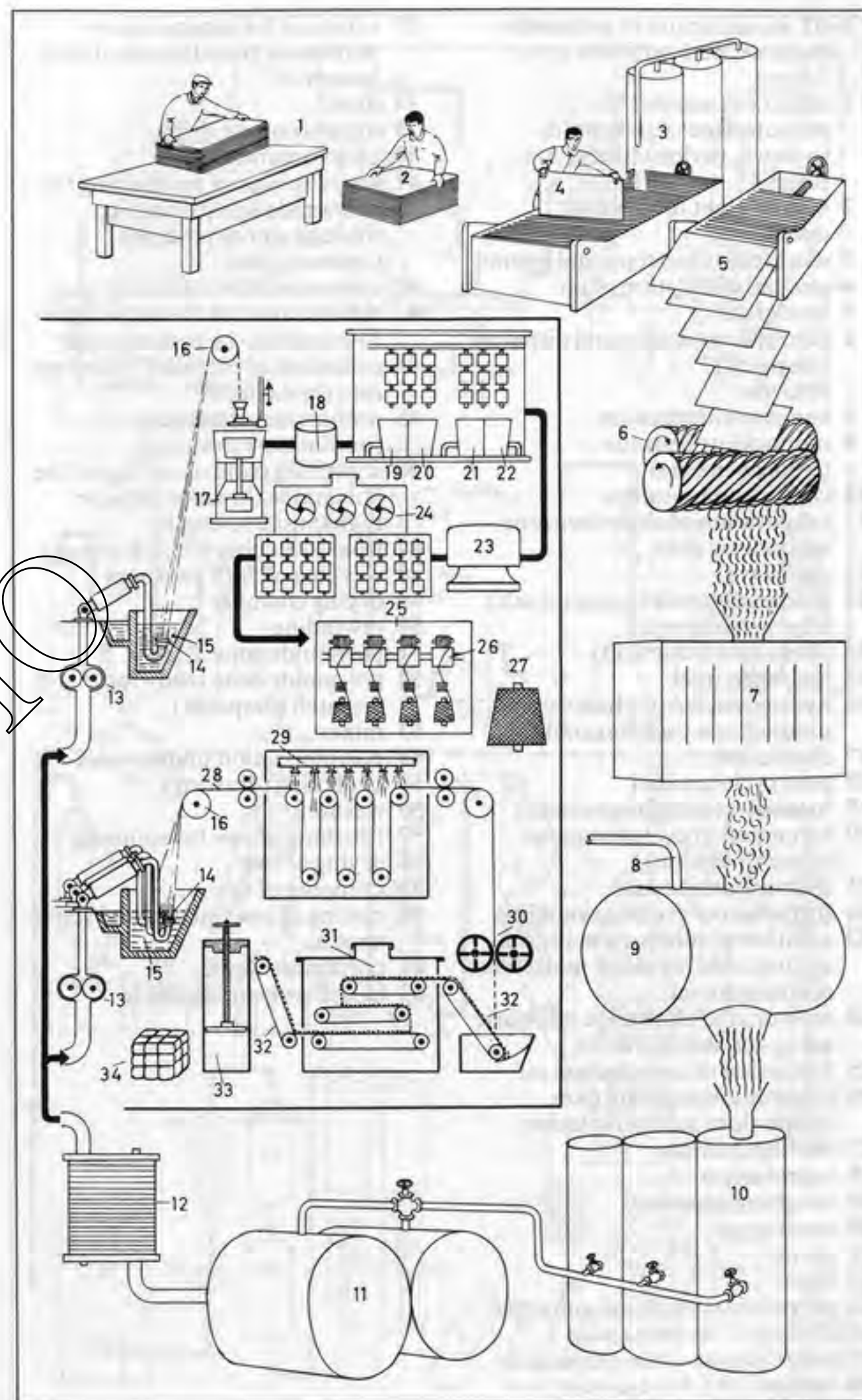

- 1-62 manufacture of polyamide (nylon 6, perlon) fibres (*Am. fibers*)
- 1 coal [raw material for manufacture of polyamide (nylon 6, perlon) fibres (*Am. fibers*)]
 - 2 coking plant for dry coal distillation
 - 3 extraction of coal tar and phenol
 - 4 gradual distillation of tar
 - 5 condenser
 - 6 benzene extraction and dispatch (despatch)
 - 7 chlorine
 - 8 benzene chlorination
 - 9 monochlorobenzene (chlorobenzene)
 - 10 caustic soda solution
 - 11 evaporation of chlorobenzene and caustic soda
 - 12 autoclave
 - 13 sodium chloride (common salt), a by-product
 - 14 phenol (carbolic acid)
 - 15 hydrogen inlet
 - 16 hydrogenation of phenol to produce raw cyclohexanol
 - 17 distillation
 - 18 pure cyclohexanol
 - 19 oxidation (dehydrogenation)
 - 20 formation of cyclohexanone (pimehinketone)
 - 21 hydroxylamine inlet
 - 22 formation of cyclohexanoxime
 - 23 addition of sulphuric acid (*Am. sulfuric acid*) to effect molecular rearrangement
 - 24 ammonia to neutralize sulphuric acid (*Am. sulfuric acid*)
 - 25 formation of caprolactam oil
 - 26 ammonium sulphate (*Am. ammonium sulfate*) solution
 - 27 cooling cylinder
 - 28 caprolactam
 - 29 weighing apparatus
 - 30 melting pot
 - 31 pump
 - 32 filter
 - 33 polymerization in the autoclave
 - 34 cooling of the polyamide
 - 35 solidification of the polyamide
 - 36 vertical lift (*Am. elevator*)
 - 37 extractor for separating the polyamide from the remaining lactam oil
 - 38 drier
 - 39 dry polyamide chips
 - 40 chip container
 - 41 top of spinneret for melting the polyamide and forcing it through spinneret holes (spinning jets)
 - 42 spinneret holes (spinning jets)
 - 43 solidification of the polyamide filaments in the cooling tower
 - 44 collection of extruded filaments into thread form
 - 45 preliminary stretching (preliminary drawing)
 - 46 stretching (cold-drawing) of the polyamide thread to achieve high tensile strength
 - 47 final stretching (final drawing)
 - 48 washing of yarn packages
 - 49 drying chamber
 - 50 rewinding
 - 51 polyamide cone
 - 52 polyamide cone ready for dispatch (despatch)
 - 53 mixer
 - 54 polymerization under vacua
 - 55 stretching (drawing)
 - 56 washing
 - 57 finishing of tow for spinning
 - 58 drying of tow
 - 59 crimping of tow
 - 60 cutting of tow into normal staple lengths
 - 61 polyamide staple
 - 62 bale of polyamide staple

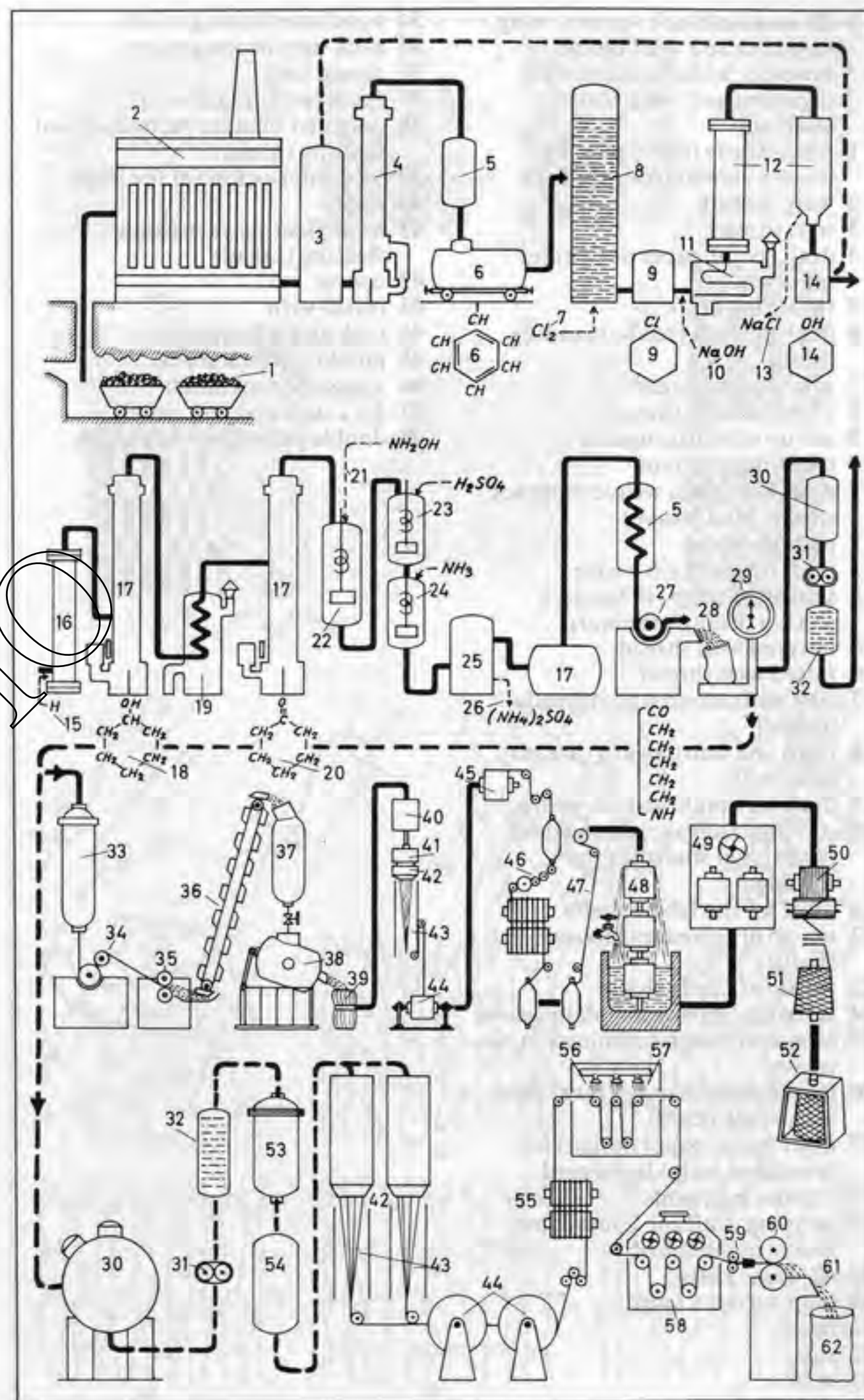

- 1-29 weaves [black squares: warp thread raised, weft thread lowered; white squares: weft thread raised, warp thread lowered]
- 1 plain weave (tabby weave) [weave viewed from above]
- 2 warp thread
- 3 weft thread
- 4 draft (point paper design) for plain weave
- 5 threading draft
- 6 denting draft (reed-threading draft)
- 7 raised warp thread
- 8 lowered warp thread
- 9 tie-up of shafts in pairs
- 10 treadling diagram
- 11 draft for basket weave (hopsack weave, matt weave)
- 12 pattern repeat
- 13 draft for warp rib weave
- 14 section of warp rib fabric, a section through the warp
- 15 lowered weft thread
- 16 raised weft thread
- 17 first and second warp threads [raised]
- 18 third and fourth warp threads [lowered]
- 19 draft for combined rib weave
- 20 selvedge (selvage) thread draft (additional shafts for the selvage)
- 21 draft for the fabric shafts
- 22 tie-up of selvage (selvage) shafts
- 23 tie-up of fabric shafts
- 24 selvedge (selvage) in plain weave
- 25 section through combination rib weave
- 26 thread interlacing of reversible warp-faced cord
- 27 draft (point paper design) for reversible warp-faced cord
- 28 interlacing points
- 29 weaving draft for honeycomb weave in the fabric
- 30-48 basic knits
- 30 loop, an open loop
- 31 head
- 32 side
- 33 neck

- 34 head interlocking point
- 35 neck interlocking point
- 36 closed loop
- 37 mesh [with inlaid yarn]
- 38 diagonal floating yarn (diagonal floating thread)
- 39 loop interlocking at the head
- 40 float
- 41 loose floating yarn (loose floating thread)
- 42 course
- 43 inlaid yarn
- 44 tuck and miss stitch
- 45 pulled-up tuck stitch
- 46 staggered tuck stitch
- 47 2 x 2 tuck and miss stitch
- 48 double pulled-up tuck stitch

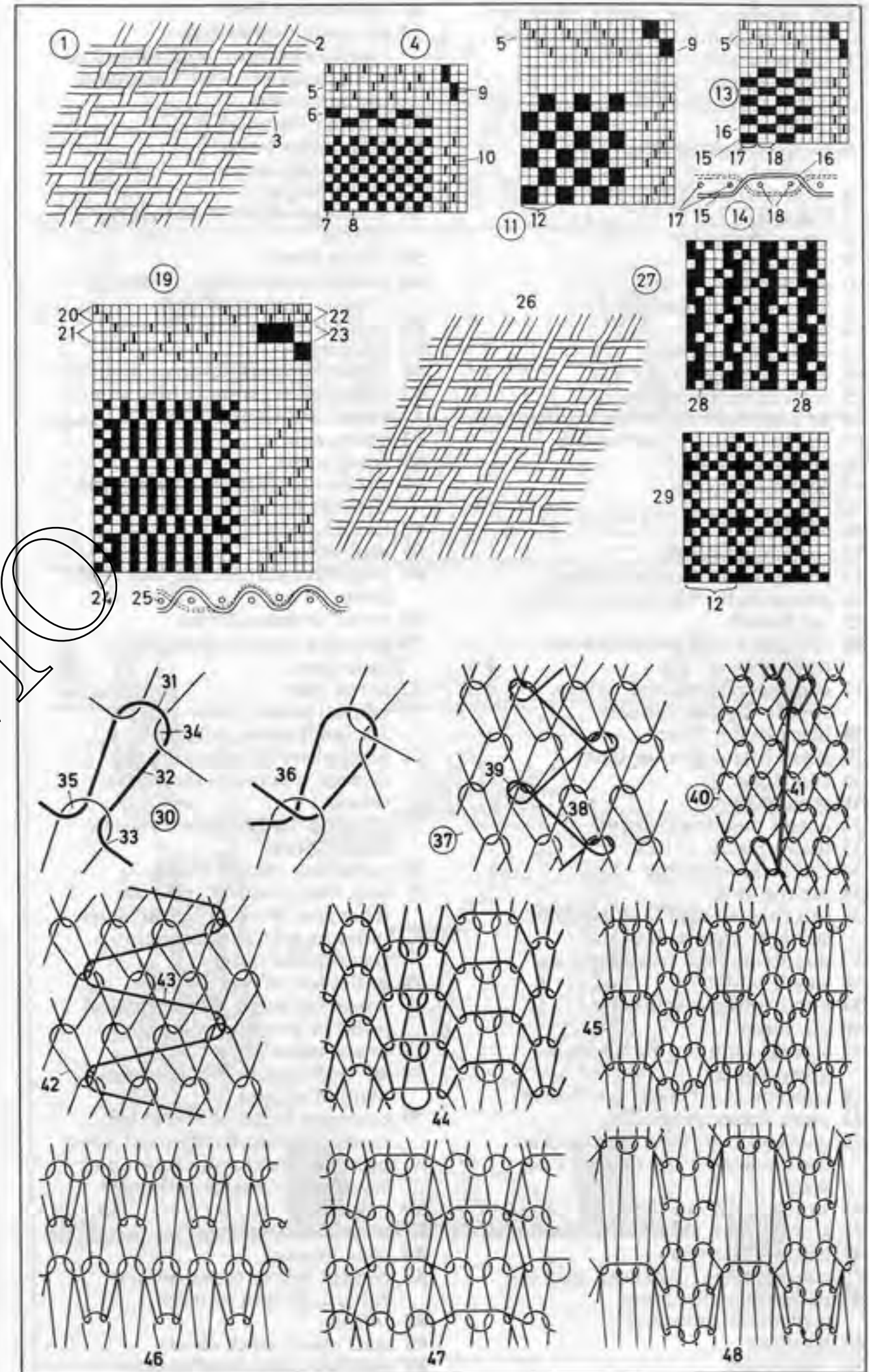

- 1-52 sulphate (*Am.* sulfate) pulp mill (kraft pulp mill) [in diagram form]
- 1 chippers with dust extractor
- 2 rotary screen (riffler)
- 3 chip packer (chip distributor)
- 4 blower
- 5 disintegrator (crusher, chip crusher)
- 6 dust-settling chamber
- 7 digester
- 8 liquor preheater
- 9 control tap
- 10 swing pipe
- 11 blow tank (diffuser)
- 12 blow valve
- 13 blow pit (diffuser)
- 14 turpentine separator
- 15 centralized separator
- 16 jet condenser (injection condenser)
- 17 storage tank for condensate
- 18 hot water tank
- 19 heat exchanger
- 20 filter
- 21 presorter
- 22 centrifugal screen
- 23 rotary sorter (rotary strainer)
- 24 concentrator (thickener, decker)
- 25 vat (chest)
- 26 collecting tank for backwater (low box)
- 27 conical refiner (cone refiner, Jordan, Jordan refiner)
- 28 black liquor filter
- 29 black liquor storage tank
- 30 condenser
- 31 separators
- 32 heater (heating element)
- 33 liquor pump
- 34 heavy liquor pump
- 35 mixing tank
- 36 salt cake storage tank (sodium sulphate storage tank)
- 37 dissolving tank (dissolver)
- 38 steam heater
- 39 electrostatic precipitator
- 40 air pump
- 41 storage tank for the uncleared green liquor
- 42 concentrator (thickener, decker)
- 43 green liquor preheater
- 44 concentrator (thickener, decker) for the weak wash liquor (wash water)
- 45 storage tank for the weak liquor
- 46 storage tank for the cooking liquor
- 47 agitator (stirrer)
- 48 concentrator (thickener, decker)
- 49 causticizing agitators (causticizing stirrers)
- 50 classifier
- 51 lime slaker
- 52 reconverted lime
- 53-65 groundwood mill (mechanical pulp mill) [diagram]
- 53 continuous grinder (continuous chain grinder)
- 54 strainer (knotter)
- 55 pulp water pump
- 56 centrifugal screen
- 57 screen (sorter)
- 58 secondary screen (secondary sorter)
- 59 rejects chest
- 60 conical refiner (cone refiner, Jordan, Jordan refiner)
- 61 pulp-drying machine (pulp machine)
- 62 concentrator (thickener, decker)
- 63 waste water pump (white water pump, pulp water pump)
- 64 steam pipe
- 65 water pipe
- 66 continuous grinder (continuous chain grinder)
- 67 feed chain
- 68 groundwood
- 69 reduction gear for the feed chain drive
- 70 stone-dressing device
- 71 grinding stone (grindstone, pulpstone)
- 72 spray pipe
- 73 conical refiner (cone refiner, Jordan, Jordan refiner)
- 74 handwheel for adjusting the clearance between the knives (blades)
- 75 rotating bladed cone (rotating bladed plug)
- 76 stationary bladed shell (chemical wood pulp, chemical pulp) or groundwood pulp (mechanical pulp)
- 78 outlet for refined cellulose (chemical wood pulp, chemical pulp) or groundwood pulp (mechanical pulp)
- 79-86 stuff (stock) preparation plant [diagram]
- 79 conveyor belt (conveyor) for loading cellulose (chemical wood pulp, chemical pulp) or groundwood pulp (mechanical pulp)
- 80 pulper
- 81 dump chest
- 82 cone breaker
- 83 conical refiner (cone refiner, Jordan, Jordan refiner)
- 84 refiner
- 85 stuff chest (stock chest)
- 86 machine chest (stuff chest)

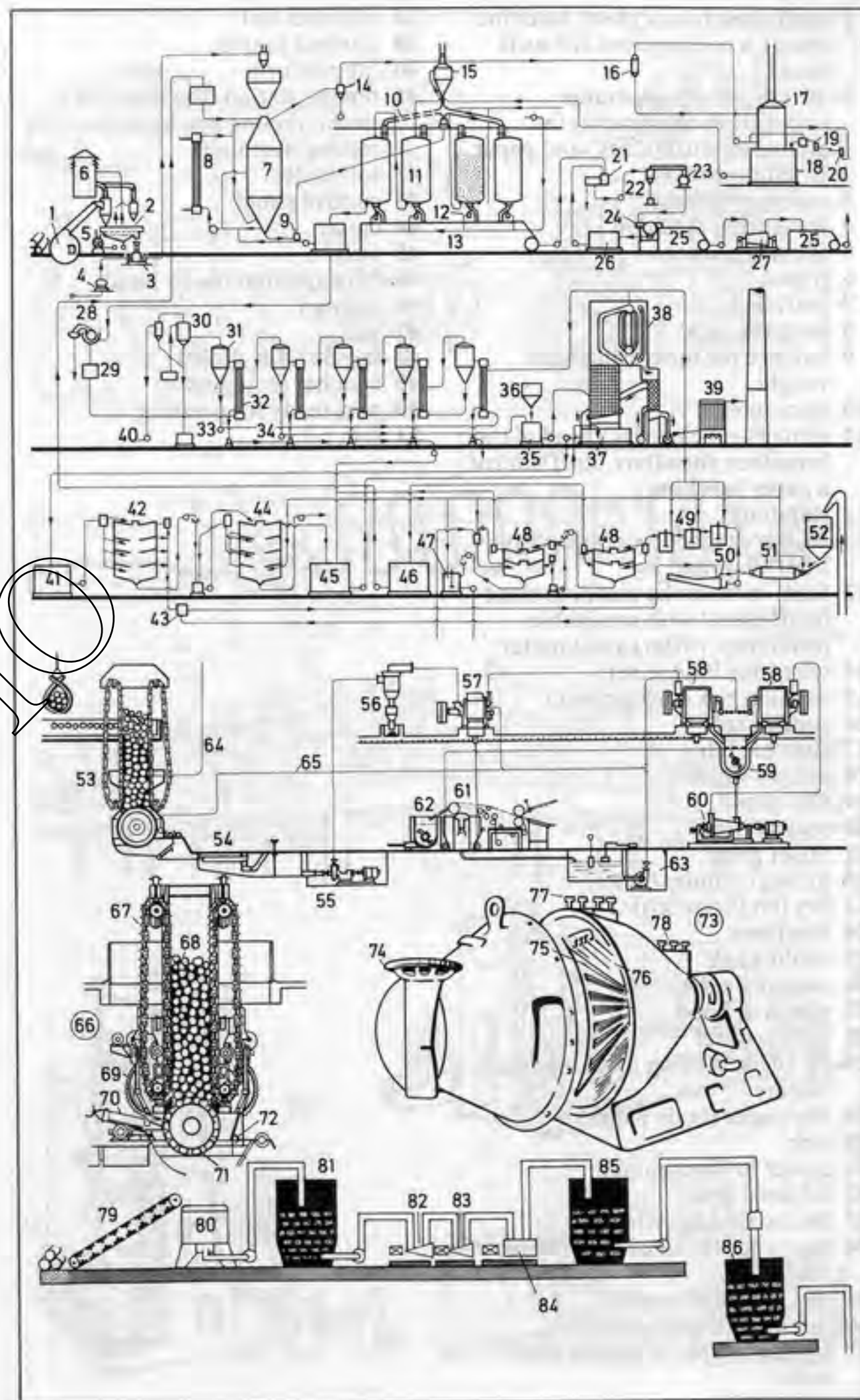

- | | | | |
|-------|---|-------|---|
| 1 | stuff chest (stock chest, machine chest), a mixing chest for stuff (stock) | 38 | calender roll |
| 2-10 | laboratory apparatus (laboratory equipment) for analysing stuff (stock) and paper | 39 | unwind station |
| 2 | Erlenmeyer flask | 40 | lift platform |
| 3 | volumetric flask | 41 | rewind station (rewinder, re-reeler, reeling machine, re-reeling machine) |
| 4 | measuring cylinder | 42 | roll cutter |
| 5 | Bunsen burner | 43 | control panel |
| 6 | tripod | 44 | cutter |
| 7 | petri dish | 45 | web |
| 8 | test tube rack | 46-51 | papermaking by hand |
| 9 | balance for measuring basis weight | 46 | vatman |
| 10 | micrometer | 47 | vat |
| 11 | centrifugal cleaners ahead of the breastbox (headbox, stuff box) of a paper machine | 48 | mould (<i>Am. mold</i>) |
| 12 | standpipe | 49 | coucher (couchman) |
| 13-28 | paper machine (production line) [diagram] | 50 | post ready for pressing |
| 13 | feed-in from the machine chest (stuff chest) with sand table (sand trap, riffler) and knotter | 51 | felt |
| 14 | wire (machine wire) | | |
| 15 | vacuum box (suction box) | | |
| 16 | suction roll | | |
| 17 | first wet felt | | |
| 18 | second wet felt | | |
| 19 | first press | | |
| 20 | second press | | |
| 21 | offset press | | |
| 22 | drying cylinder (drier) | | |
| 23 | dry felt (drier felt) | | |
| 24 | size press | | |
| 25 | cooling roll | | |
| 26 | calender rolls | | |
| 27 | machine hood | | |
| 28 | delivery reel | | |
| 29-35 | blade coating machine (blade coater) | | |
| 29 | raw paper (body paper) | | |
| 30 | web | | |
| 31 | coater for the top side | | |
| 32 | infrared drier | | |
| 33 | heated drying cylinder | | |
| 34 | coater for the underside (wire side) | | |
| 35 | reel of coated paper | | |
| 36 | calender (Super-calender) | | |
| 37 | hydraulic system for the press rolls | | |

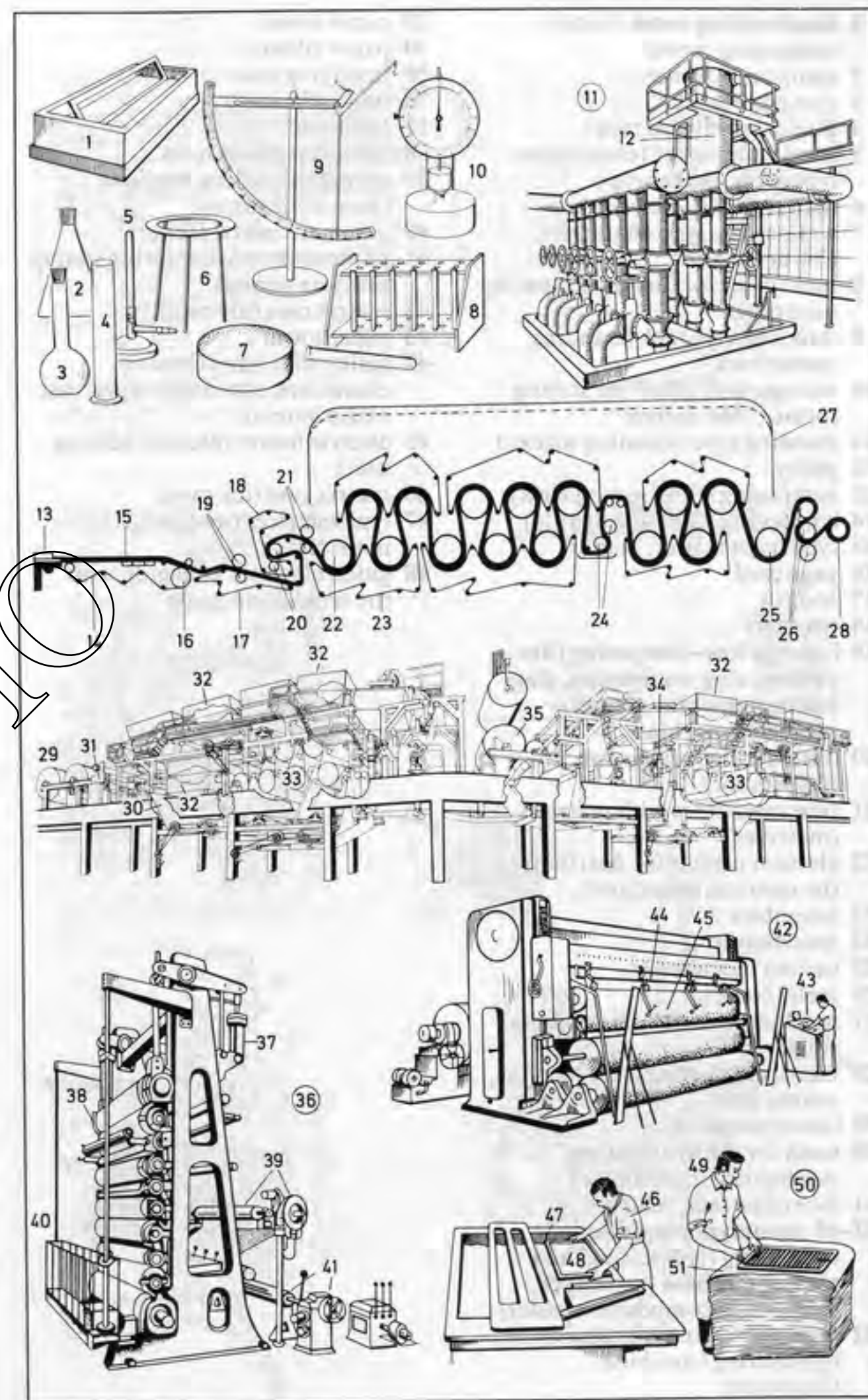

- 1 hand-setting room (hand-composing room)
- 2 composing frame
- 3 case (typecase)
- 4 case cabinet (case rack)
- 5 hand compositor (compositor, typesetter, maker-up)
- 6 manuscript (typescript)
- 7 sorts, types (type characters, characters)
- 8 rack (case) for furniture (spacing material)
- 9 standing type rack (standing matter rack)
- 10 storage shelf (shelf for storing formes, *Am.* forms)
- 11 standing type (standing matter)
- 12 galley
- 13 composing stick (setting stick)
- 14 composing rule (setting rule)
- 15 type (type matter, matter)
- 16 page cord
- 17 bodkin
- 18 tweezers
- 19 Linotype line-composing (line-casting, slug-composing, slug-casting) machine, a multi-magazine machine
- 20 distributing mechanism (distributor)
- 21 type magazines with matrices (matrixes)
- 22 elevator carrier for distributing the matrices (matrixes)
- 23 assembler
- 24 spacebands
- 25 casting mechanism
- 26 metal feeder
- 27 machine-set matter (cast lines, slugs)
- 28 matrices (matrixes) for hand-setting (sorts)
- 29 Linotype matrix
- 30 teeth for the distributing mechanism (distributor)
- 31 face (type face, matrix)
- 32-45 monotype single-unit composing (typesetting) and casting machine (monotype single-unit composition caster)
- 32 monotype standard composing (typesetting) machine (keyboard)
- 33 paper tower
- 34 paper ribbon
- 35 justifying scale
- 36 unit indicator
- 37 keyboard
- 38 compressed-air hose
- 39 monotype casting machine (monotype caster)
- 40 automatic metal feeder
- 41 pump compression spring (pump pressure spring)
- 42 matrix case (die case)
- 43 paper tower
- 44 galley with types (letters, characters, cast single types, cast single letters)
- 45 electric heater (electric heating unit)
- 46 matrix case (die case)
- 47 type matrices (matrixes) (letter matrixes)
- 48 guide block for engaging with the cross-slide guide

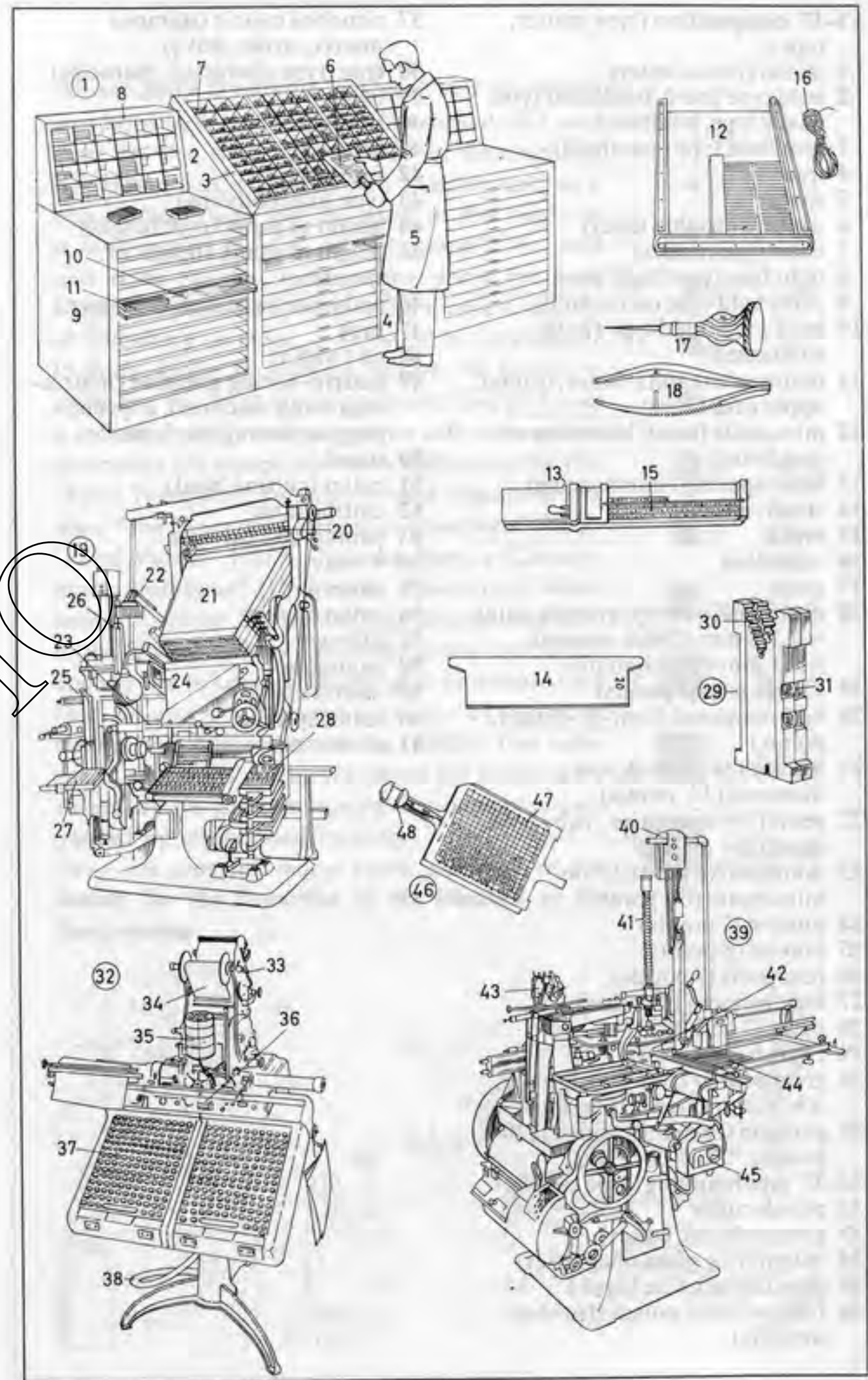

- 1-17 **composition** (type matter, type)
- 1 initial (initial letter)
- 2 bold type (bold, boldfaced type, heavy type, boldface)
- 3 semibold type (semibold)
- 4 line
- 5 space
- 6 ligature (double letter)
- 7 italic type (italics)
- 8 light face type (light face)
- 9 extra bold type (extra bold)
- 10 bold condensed type (bold condensed)
- 11 majuscule (capital letter, capital, upper case letter)
- 12 minuscule (small letter, lower case letter)
- 13 letter spacing (interspacing)
- 14 small capitals
- 15 break
- 16 indention
- 17 space
- 18 **type sizes** [one typographic point = 0.376 mm (Didot system), 0.351 mm (Pica system)]
- 19 six-to-pica (2 points)
- 20 half nonpareil (four-to-pica) (3 points)
- 21 brilliant (4 points); *sim.*: diamond (4½ points)
- 22 pearl (5 points); *sim.*: ruby (*Am.* agate) (5½ points)
- 23 nonpareil (6 points); *sim.*: minionette (6½ points)
- 24 minion (7 points)
- 25 bavier (8 points)
- 26 bourgeois (9 points)
- 27 long primer (10 points)
- 28 pica (12 points)
- 29 english (14 points)
- 30 great primer (two-line bavier, *Am.* Columbian) (16 points)
- 31 paragon (two-line primer) (20 points)
- 32-37 **typefounding** (type casting)
- 32 punch cutter
- 33 graver (burin, cutter)
- 34 magnifying glass (magnifier)
- 35 punch blank (die blank)
- 36 finished steel punch (finished steel die)

- 37 punched matrix (stamped matrix, strike, drive)
- 38 **type** (type character, character)
- 39 head
- 40 shoulder
- 41 counter
- 42 face (type face)
- 43 type line (bodyline)
- 44 height to paper (type height)
- 45 height of shank (height of shoulder)
- 46 body size (type size, point size)
- 47 nick
- 48 set (width)
- 49 **matrix-boring machine** (matrix-engraving machine), a special-purpose boring machine
- 50 stand
- 51 cutter (cutting head)
- 52 cutting table
- 53 pantograph carriage
- 54 V-way
- 55 pattern
- 56 pattern table
- 57 follower
- 58 pantograph
- 59 matrix clamp
- 60 cutter spindle
- 61 drive motor

1 Alfred John Dodsley, essayist and journalist, 4 was born in Wenlock on the 5th August 1841 and died on the 4th October 1920 in Birmingham. His father was a journeyman thatcher and as a 5 boy Dodsley was sent to work in the fields as a bird-scarer. Having taught himself to read and write fluently — for many years the only 6 books he possessed were a Bible and a volume of Tillotson's sermons — he went to Shrewsbury to study. Living in extreme poverty he began to write for the EAST HEREFORDSHIRE GAZETTE and a collection of his essays together with some poems on country life was published in 1868 under the title "Rural Thoughts". Among his most popular works were "The Diary of a Derbyshire Shepherd" (1872), 7 "Rural Verses" (1879), "Leaves from a Countryman's Notebook" (1893) and "Memoirs of Nineteenth Century Shropshire", published posthumously. Dodsley also contributed many articles on country life to London papers and championed 13 the cause of the agricultural worker during the depression of the 1880's. The latter 11 years of his life were embittered by controversy 12 raised by his protests against the unemployment caused by mechanised farming. 15

16— He was for many years president of the Society for the Protection of the Liberties of the Farm-worker. 10 17

- 19
- 20 (18)
- 21 N n
- 22 N n
- 23 N n
- 24 N n
- 25 N n
- 26 N n
- 27 N n
- 28 N n
- 29 N n
- 30 N n
- 31 N n

DEMO

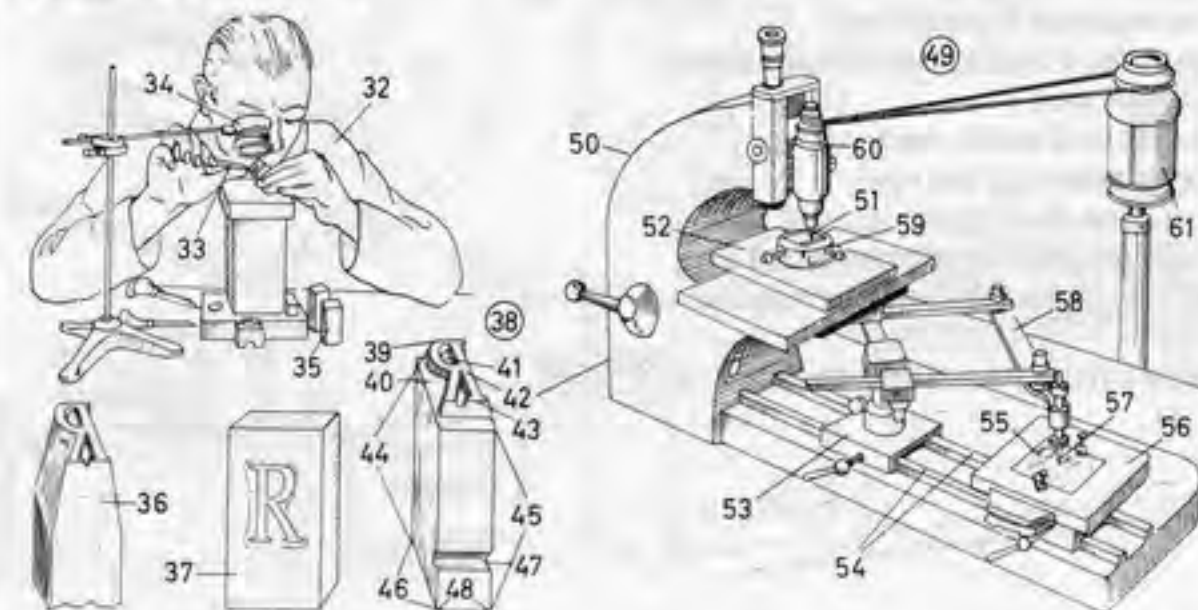

176 Composing Room (Case Room) III (Phototypesetting, Photocomposition, Photosetting, Filmsetting)

- 1 keyboard console (keyboard unit) for phototypesetting
- 2 keyboard
- 3 manuscript (copy)
- 4 keyboard operator
- 5 tape punch (perforator)
- 6 punched tape (punch tape)
- 7 filmsetter
- 8 punched tape (punch tape)
- 9 exposure control device
- 10 typesetting computer
- 11 memory unit (storage unit)
- 12 punched tape (punch tape)
- 13 punched tape (punch tape) reader
- 14 photo-unit (photographic unit) for computer-controlled typesetting (composition)
- 15 punched tape (punch tape) reader
- 16 type matrices (matrixes) (letter matrices)
- 17 matrix case (film matrix case)
- 18 guide block
- 19 synchronous motor
- 20 type disc (disk) (matrix disc)
- 21 mirror assembly
- 22 optical wedge
- 23 lens
- 24 mirror system
- 25 film
- 26 flash tubes
- 27 matrix drum
- 28 automatic film copier
- 29 central processing unit of a photocomposition system (photosetting system) for newspaper typesetting
- 30 punched tape (punch tape) input (input unit)
- 31 keyboard send-receive teleprinter (Teletype)
- 32 on-line disc (disk) storage unit
- 33 alphanumeric (alphameric) disc (disk) store (alphanumeric disc file)
- 34 disc (disk) stack (disc pack)

Composing Room (Case Room) III (Phototypesetting, 176 Photocomposition, Photosetting, Filmsetting)

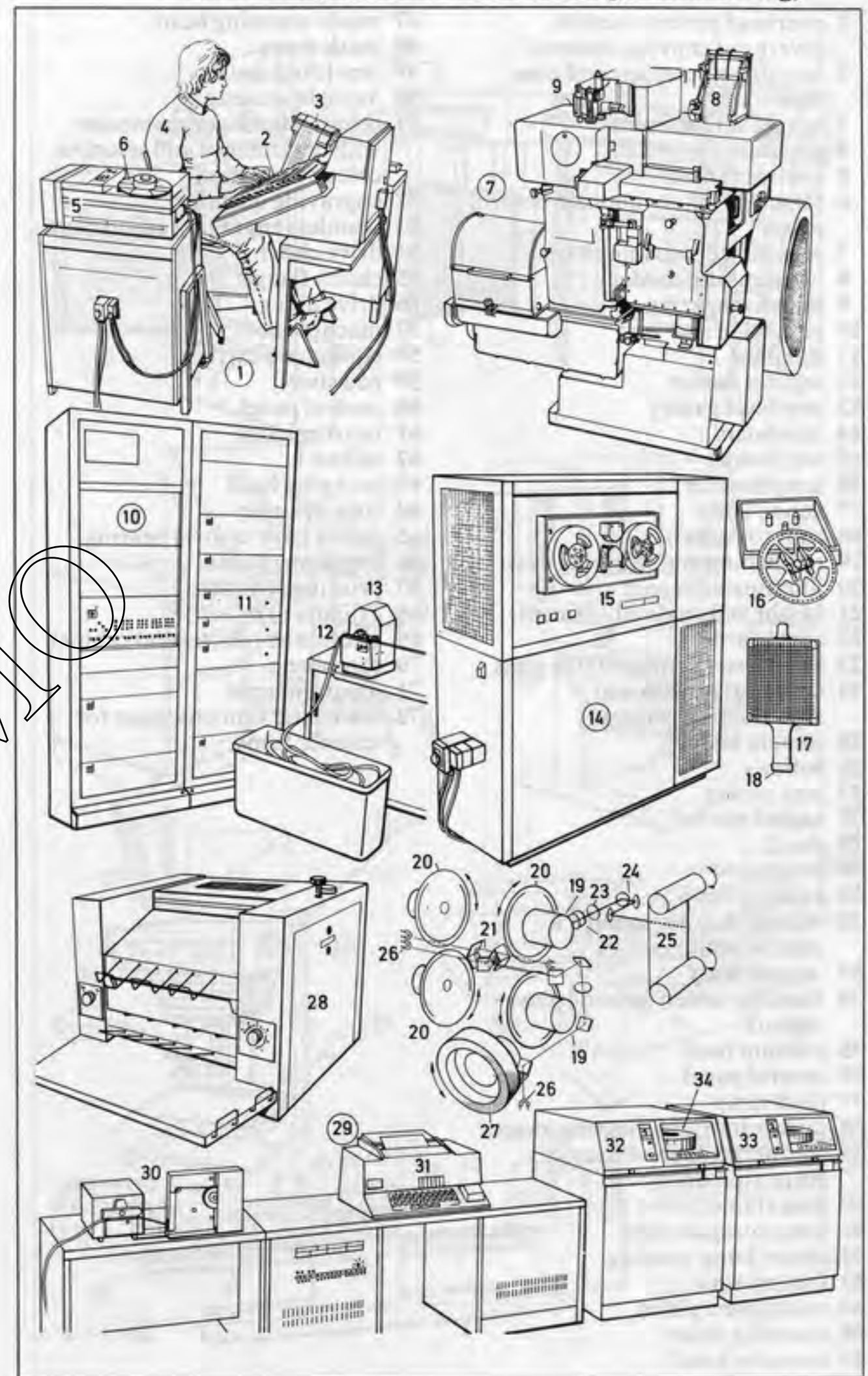

- 1 overhead process camera (overhead copying camera)
- 2 focusing screen (ground glass screen)
- 3 hinged screen holder
- 4 graticule
- 5 control console
- 6 hinged bracket-mounted control panel
- 7 percentage focusing charts
- 8 vacuum film holder
- 9 screen magazine
- 10 bellows
- 11 standard
- 12 register device
- 13 overhead gantry
- 14 copyboard
- 15 copyholder
- 16 lamp bracket
- 17 xenon lamp
- 18 copy (original)
- 19 retouching and stripping desk
- 20 illuminated screen
- 21 height and angle adjustment
- 22 copyboard
- 23 linen tester, a magnifying glass
- 24 universal process and reproduction camera
- 25 camera body
- 26 bellows
- 27 lens carrier
- 28 angled mirror
- 29 stand
- 30 copyboard
- 31 halogen lamp
- 32 vertical process camera, a compact camera
- 33 camera body
- 34 focusing screen (ground glass screen)
- 35 vacuum back
- 36 control panel
- 37 flash lamp
- 38 mirror for right-reading images
- 39 scanner (colour, *Am.* color, correction unit)
- 40 base frame
- 41 lamp compartment
- 42 xenon lamp housing
- 43 feed motors
- 44 transparency arm
- 45 scanning drum
- 46 scanning head
- 47 mask-scanning head
- 48 mask drum
- 49 recording space
- 50 daylight cassette
- 51 colour (*Am.* color) computer with control unit and selective colour correction
- 52 engraving machine
- 53 seamless engraving adjustment
- 54 drive clutch
- 55 clutch flange
- 56 drive unit
- 57 machine bed
- 58 equipment carrier
- 59 bed slide
- 60 control panel
- 61 bearing block
- 62 tailstock
- 63 scanning head
- 64 copy cylinder
- 65 centre (*Am.* center) bearing
- 66 engraving system
- 67 printing cylinder
- 68 cylinder arm
- 69 electronics (electronic) cabinet
- 70 computers
- 71 program input
- 72 automatic film processor for scanner films

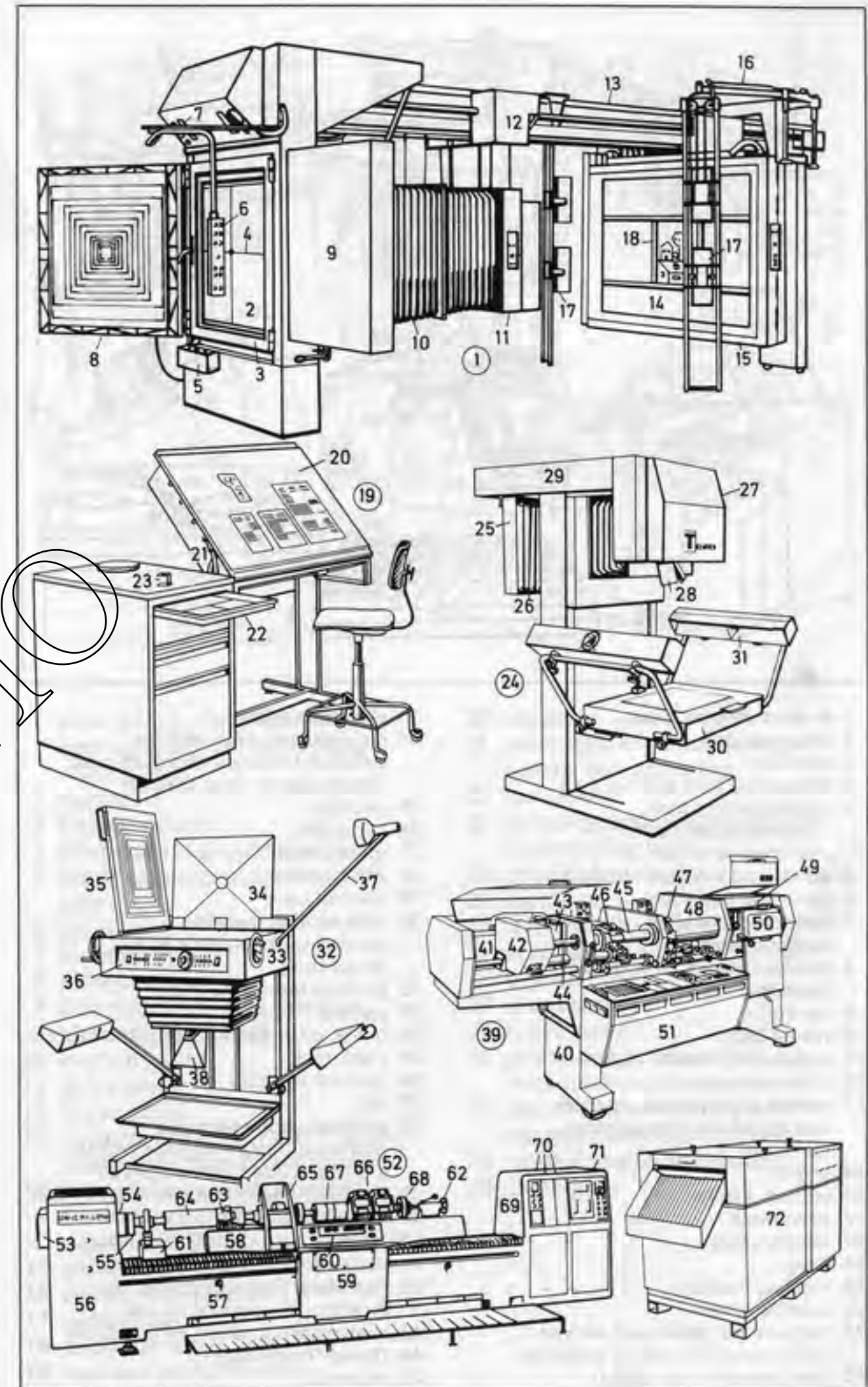

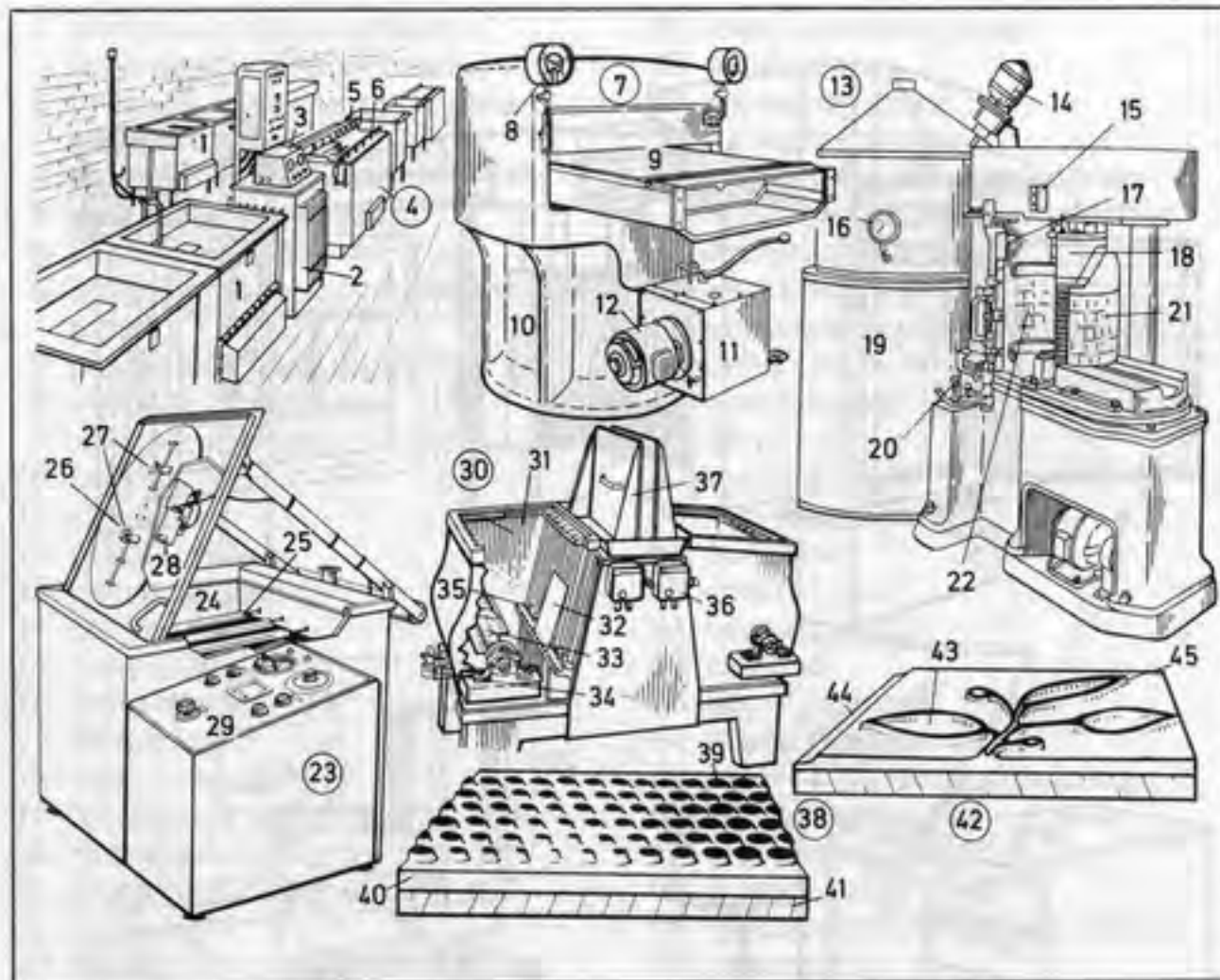

1-6 electrotyping plant

- 1 cleaning tank
- 2 rectifier
- 3 measuring and control unit
- 4 electroplating tank (electroplating bath, electroplating vat)
- 5 anode rod (copper anodes)
- 6 plate rod (cathode)
- 7 hydraulic moulding (*Am.* moulding) press
- 8 pressure gauge (*Am.* gage) (manometer)
- 9 apron
- 10 round base
- 11 hydraulic pressure pump
- 12 drive motor
- 13 curved plate casting machine (curved electrotype casting machine)
- 14 motor
- 15 control knobs
- 16 pyrometer
- 17 mouth piece
- 18 core
- 19 melting furnace
- 20 starting lever
- 21 cast curved plate (cast curved electrotype) for rotary printing
- 22 fixed mould (*Am.* mold)

23 etching machine

- 24 etching tank with etching solution (etchant, mordant) and filming agent (film former)
- 25 paddles
- 26 turntable
- 27 plate clamp
- 28 drive motor
- 29 control unit
- 30 twin etching machine
- 31 etching tank (etching bath) [in section]
- 32 photoprinted zinc plate
- 33 paddle
- 34 outlet cock (drain cock, *Am.* faucet)
- 35 plate rack
- 36 control switches
- 37 lid
- 38 half-tone photoengraving (half-tone block, half-tone plate), a block (plate, printing plate)
- 39 dot (half-tone dot), a printing element
- 40 etched zinc plate
- 41 block mount (block mounting, plate mount, plate mounting)
- 42 line block (line engraving, line etching, line plate, line cut)
- 43 non-printing, deep-etched areas
- 44 flange (bevel edge)
- 45 sidewall

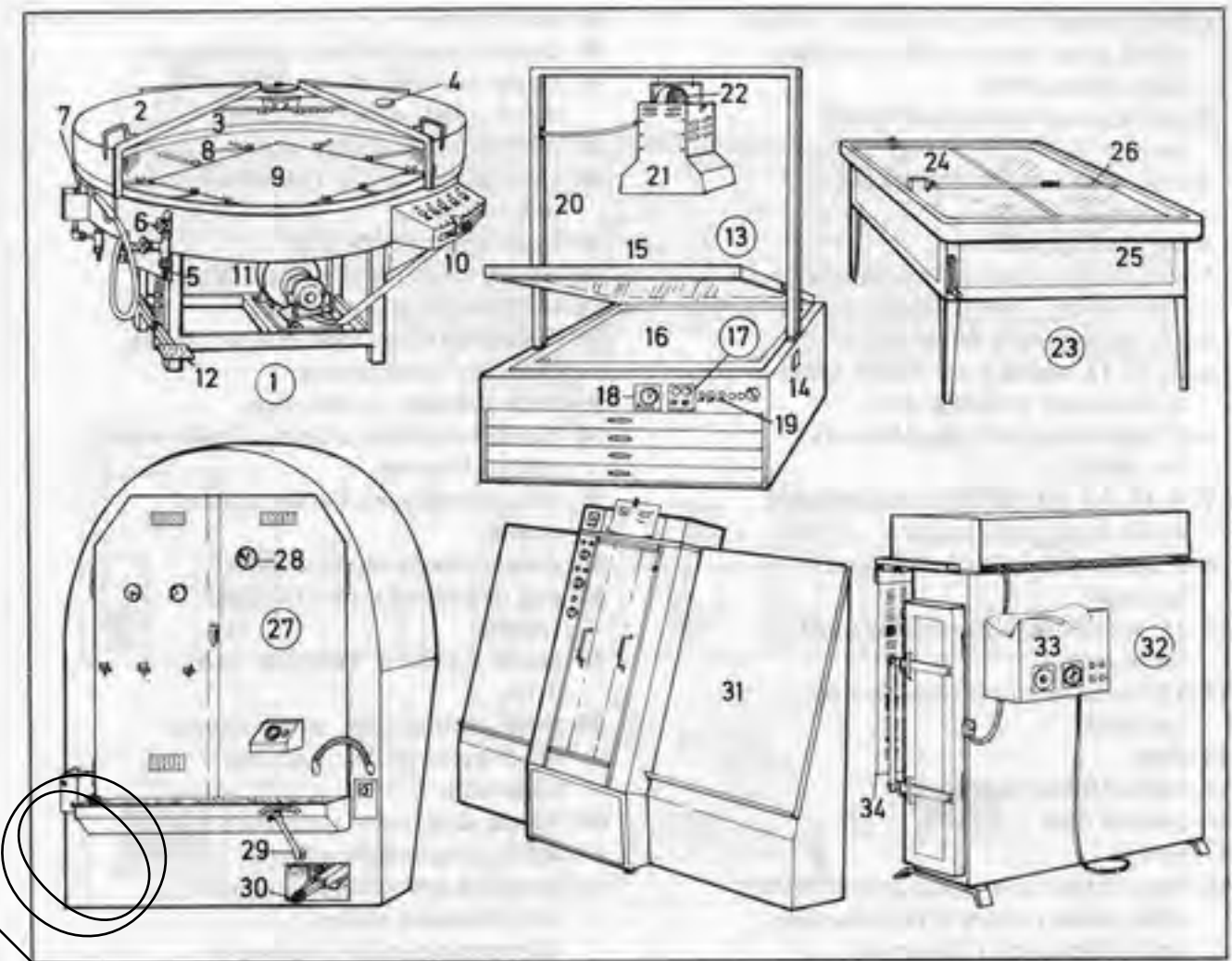

1 plate whirler (whirler, plate-coating machine) for coating offset plates

- 2 sliding lid
- 3 electric heater
- 4 temperature gauge (*Am.* gage)
- 5 water connection for the spray unit
- 6 spray unit
- 7 hand spray
- 8 plate clamps
- 9 zinc plate (*also*: magnesium plate, copper plate)
- 10 control panel
- 11 drive motor
- 12 brake pedal
- 13 vacuum printing frame (vacuum frame, printing-down frame)
- 14 base of the vacuum printing frame (vacuum frame, printing-down frame)
- 15 plate glass frame
- 16 coated offset plate
- 17 control panel
- 18 exposure timer
- 19 vacuum pump switch

20 support

- 21 point light exposure lamp, a quartz-halogen lamp
- 22 fan blower
- 23 stripping table (make-up table) for stripping films
- 24 crystal glass screen
- 25 light box
- 26 straightedge rules
- 27 vertical plate-drying cabinet
- 28 hygrometer
- 29 speed control
- 30 brake pedal
- 31 processing machine for presensitized plates
- 32 burning-in oven for glue-enamel plates (diaz plates)
- 33 control box (control unit)
- 34 diazo plate

- 1 four-colour (*Am.* four-color) rotary offset press (rotary offset machine, web-offset press)
- 2 roll of unprinted paper (blank paper)
- 3 reel stand (carrier for the roll of unprinted paper)
- 4 forwarding rolls
- 5 side margin control (margin control, side control, side lay control)
- 6-13 inking units (inker units)
- 6, 8, 10, 12 inking units (inker units) in the upper printing unit
- 6-7 perfecting unit (double unit) for yellow
- 7, 9, 11, 13 inking units (inker units) in the lower printing unit
- 8-9 perfecting unit (double unit) for cyan
- 10-11 perfecting unit (double unit) for magenta
- 12-13 perfecting unit (double unit) for black
- 14 drier
- 15 folder (folder unit)
- 16 control desk
- 17 sheet
- 18 four-colour (*Am.* four-color) rotary offset press (rotary offset machine, web-offset press) [diagram]
- 19 reel stand
- 20 side margin control (margin control, side control, side lay control)
- 21 inking rollers (ink rollers, inkers)
- 22 ink duct (ink fountain)
- 23 damping rollers (dampening rollers, dampers, dampeners)
- 24 blanket cylinder
- 25 plate cylinder
- 26 route of the paper (of the web)
- 27 drier
- 28 chilling rolls (cooling rollers, chill rollers)
- 29 folder (folder unit)
- 30 four-colour (*Am.* four-color) sheet-fed offset machine (offset press) [diagram]
- 31 sheet feeder (feeder)
- 32 feed table (feed board)
- 33 route of the sheets through swing-grippers to the feed drum
- 34 feed drum
- 35 impression cylinder
- 36 transfer drums (transfer cylinders)
- 37 blanket cylinder
- 38 plate cylinder
- 39 damping unit (dampening unit)
- 40 inking units (inker units)
- 41 printing unit
- 42 delivery cylinder
- 43 chain delivery

- 44 delivery pile
- 45 delivery unit (delivery mechanism)
- 46 single-colour (*Am.* single-color) offset press (offset machine)
- 47 pile of paper (sheets, printing paper)
- 48 sheet feeder (feeder), an automatic pile feeder
- 49 feed table (feed board)
- 50 inking rollers (ink rollers, inkers)
- 51 inking units (inker units)
- 52 damping rollers (dampening rollers, dampers, dampeners)
- 53 plate cylinder, a zinc plate
- 54 blanket cylinder, a steel cylinder with rubber blanket
- 55 pile delivery unit for the printed sheets
- 56 gripper bar, a chain gripper
- 57 pile of printed paper (printed sheets)
- 58 guard for the V-belt (vee-belt) drive
- 59 single-colour (*Am.* single-color) offset press (offset machine) [diagram]
- 60 inking unit (inker unit) with inking rollers (ink rollers, inkers)
- 61 damping unit (dampening unit) with damping rollers (dampening rollers, dampers, dampeners)
- 62 plate cylinder
- 63 blanket cylinder
- 64 impression cylinder
- 65 delivery cylinders with grippers
- 66 drive wheel
- 67 feed table (feed board)
- 68 sheet feeder (feeder)
- 69 pile of unprinted paper (blank paper, unprinted sheets, blank sheets)
- 70 small sheet-fed offset press
- 71 inking unit (inker unit)
- 72 suction feeder
- 73 pile feeder
- 74 instrument panel (control panel) with counter, pressure gauge (*Am.* gage), air regulator, and control switch for the sheet feeder (feeder)
- 75 flat-bed offset press (offset machine) ('Mailänder' proofing press, proof press)
- 76 inking unit (inker unit)
- 77 inking rollers (ink rollers, inkers)
- 78 bed (press bed, type bed, forme bed, *Am.* form bed)
- 79 cylinder with rubber blanket
- 80 starting and stopping lever for the printing unit
- 81 impression-setting wheel (impression-adjusting wheel)

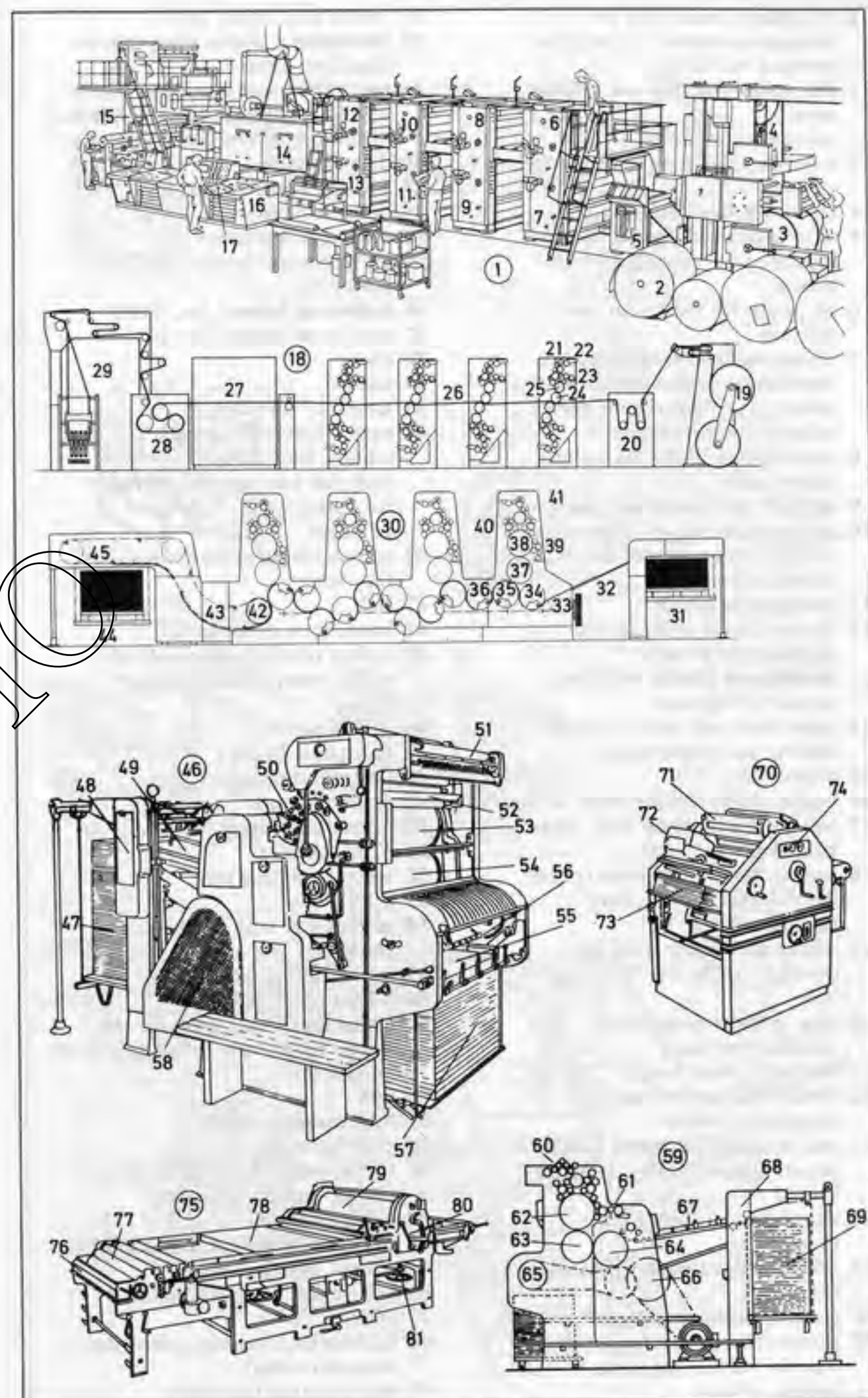

DEMO

- 1-65 presses (machines) for letterpress printing (letterpress printing machines)
- 1 two-revolution flat-bed cylinder press
- 2 impression cylinder
- 3 lever for raising or lowering the cylinder
- 4 feed table (feed board)
- 5 automatic sheet feeder (feeder) [operated by vacuum and air blasts]
- 6 air pump for the feeder and delivery
- 7 inking unit (inker unit) with distributing rollers (distributor rollers, distributors) and forme rollers (*Am. form rollers*)
- 8 ink slab (ink plate) inking unit (inker unit)
- 9 delivery pile for printed paper
- 10 sprayer (anti set-off apparatus, anti set-off spray) for dusting the printed sheets
- 11 interleaving device
- 12 foot pedal for starting and stopping the press
- 13 platen press (platen machine, platen) [in section]
- 14 paper feed and delivery (paper feeding and delivery unit)
- 15 platen
- 16 toggle action (toggle-joint action)
- 17 bed (type bed, press bed, forme bed, *Am. form bed*)
- 18 forme rollers (*Am. form rollers*) (forme-inking, *Am. form-inking, rollers*)
- 19 inking unit (inker unit) for distributing the ink (printing ink)
- 20 stop-cylinder press (stop-cylinder machine)
- 21 feed table (feed board)
- 22 feeder mechanism (feeding apparatus, feeder)
- 23 pile of unprinted paper (blank paper, unprinted sheets, blank sheets)
- 24 guard for the sheet feeder (feeder)
- 25 pile of printed paper (printed sheets)
- 26 control mechanism
- 27 forme rollers (*Am. form rollers*) (forme-inking, *Am. form-inking, rollers*)

- 28 inking unit (inker unit)
- 29 [Heidelberg] platen press (platen machine, platen)
- 30 feed table (feed board) with pile of unprinted paper (blank paper, unprinted sheets, blank sheets)
- 31 delivery table
- 32 starting and stopping lever
- 33 delivery blower
- 34 spray gun (sprayer)
- 35 air pump for vacuum and air blasts
- 36 locked-up forme (*Am. form*)
- 37 type (type matter, matter)
- 38 chase
- 39 quoin
- 40 length of furniture
- 41 rotary letterpress press (rotary letterpress machine, web-fed letterpress machine) for newspapers of up to 16 pages
- 42 slitters for dividing the width of the web
- 43 web
- 44 impression cylinder
- 45 jockey roller (compensating roller, compensator, tension roller)
- 46 roll of paper
- 47 automatic brake
- 48 first printing unit
- 49 perfecting unit
- 50 inking unit (inker unit)
- 51 plate cylinder
- 52 second printing unit
- 53 former
- 54 tachometer with sheet counter
- 55 folder (folder unit)
- 56 folded newspaper
- 57 inking unit (inker unit) for the rotary press (web-fed press) [in section]
- 58 web
- 59 impression cylinder
- 60 plate cylinder
- 61 forme rollers (*Am. form rollers*) (forme-inking, *Am. form-inking, rollers*)
- 62 distributing rollers (distributor rollers, distributors)
- 63 lifter roller (ductor, ductor roller)
- 64 duct roller (fountain roller, ink fountain roller)
- 65 ink duct (ink fountain)

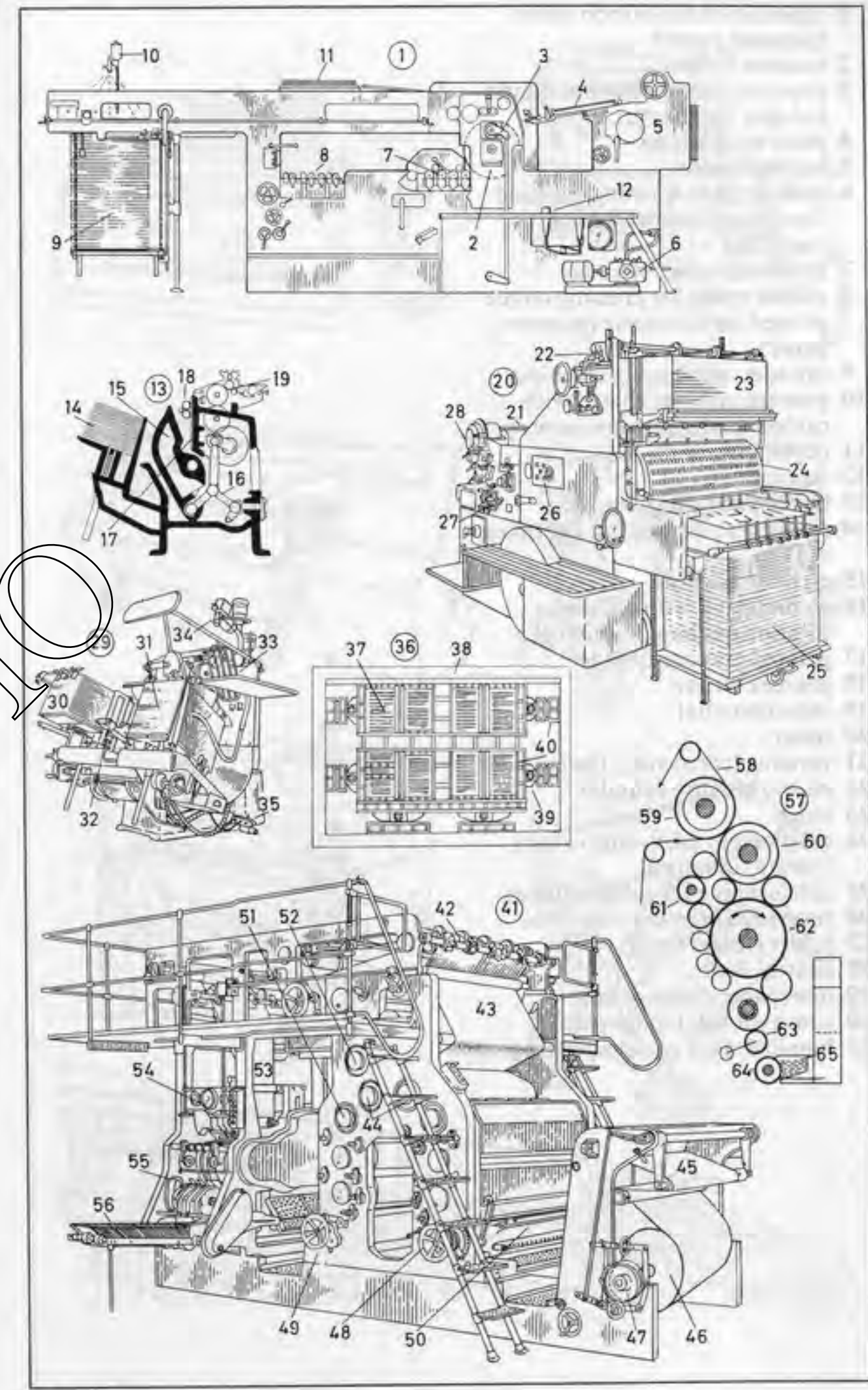

- 1 exposure of the carbon tissue (pigment paper)
- 2 vacuum frame
- 3 exposing lamp, a bank of quartz-halogen lamps
- 4 point source lamp
- 5 heat extractor
- 6 carbon tissue transfer machine (laydown machine, laying machine)
- 7 polished copper cylinder
- 8 rubber roller for pressing on the printed carbon tissue (pigment paper)
- 9 cylinder-processing machine
- 10 gravure cylinder coated with carbon tissue (pigment paper)
- 11 developing tank
- 12 staging
- 13 developed cylinder
- 14 retoucher painting out (stopping out)
- 15 etching machine
- 16 etching tank with etching solution (etchant, mordant)
- 17 printed gravure cylinder
- 18 gravure etcher
- 19 calculator dial
- 20 timer
- 21 revising (correcting) the cylinder
- 22 etched gravure cylinder
- 23 ledge
- 24 multicolour (*Am.* multicolor) rotogravure press
- 25 exhaust pipe for solvent fumes
- 26 reversible printing unit
- 27 folder (folder unit)
- 28 control desk
- 29 newspaper delivery unit
- 30 conveyor belt (conveyor)
- 31 bundled stack of newspapers

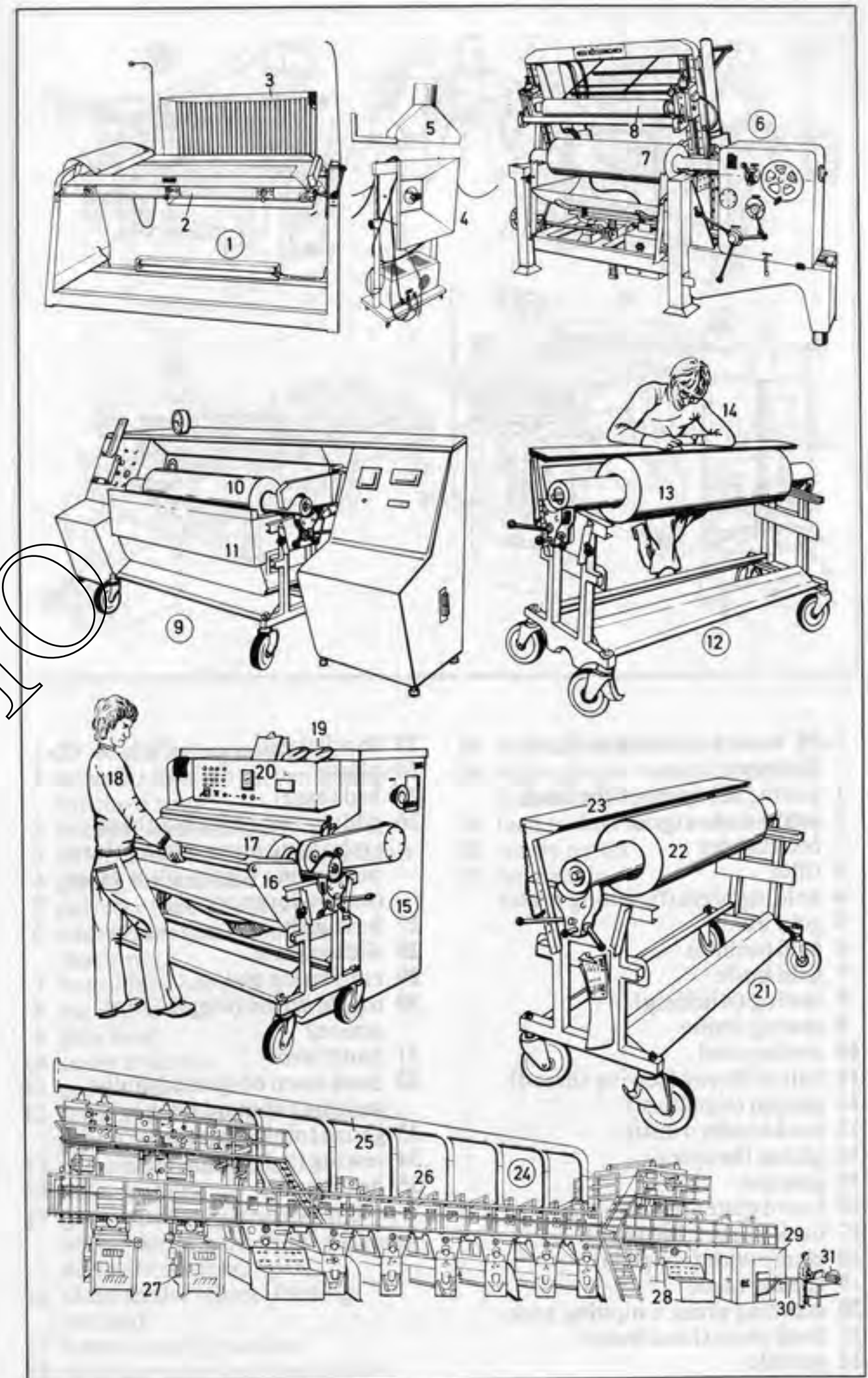

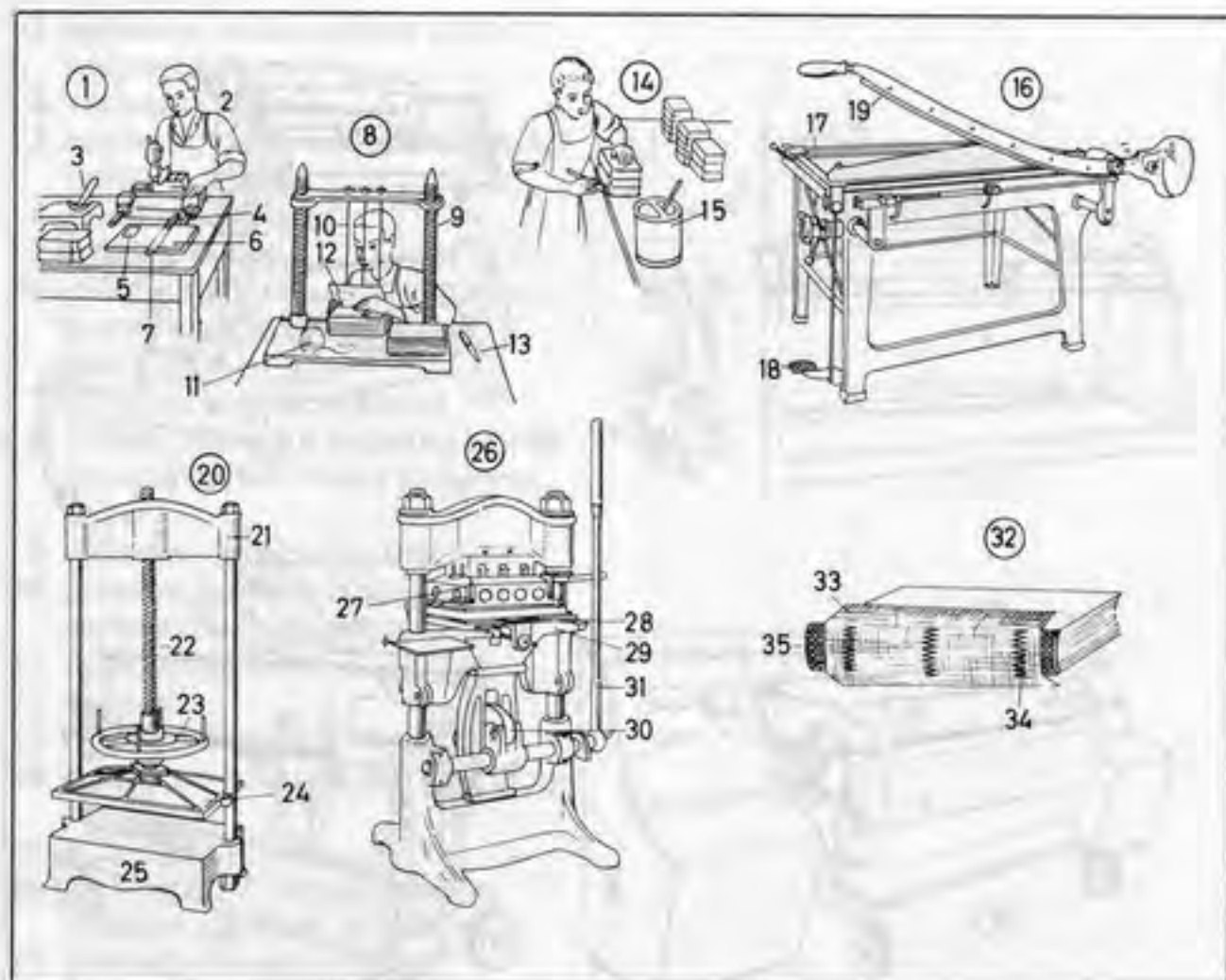

1-35 hand bookbinding (hand bindery)

- 1 gilding the spine of the book
- 2 gold finisher (gilder), a bookbinder
- 3 fillet
- 4 holding press (finishing press)
- 5 gold leaf
- 6 gold cushion
- 7 gold knife
- 8 sewing (stitching)
- 9 sewing frame
- 10 sewing cord
- 11 ball of thread (sewing thread)
- 12 section (signature)
- 13 bookbinder's knife
- 14 gluing the spine
- 15 glue pot
- 16 board cutter (guillotine)
- 17 back gauge (*Am.* gage)
- 18 clamp with foot pedal
- 19 cutting blade
- 20 standing press, a nipping press
- 21 head piece (head beam)
- 22 spindle
- 23 handwheel
- 24 platen
- 25 bed (base)
- 26 gilding (gold blocking) and embossing press, a hand-lever press; *sim.*: toggle-joint press (toggle-lever press)
- 27 heating box
- 28 sliding plate
- 29 embossing platen
- 30 toggle action (toggle-joint action)
- 31 hand lever
- 32 book sewn on gauze (mull, scrim) (unbound book)
- 33 gauze (mull, scrim)
- 34 sewing (stitching)
- 35 headband

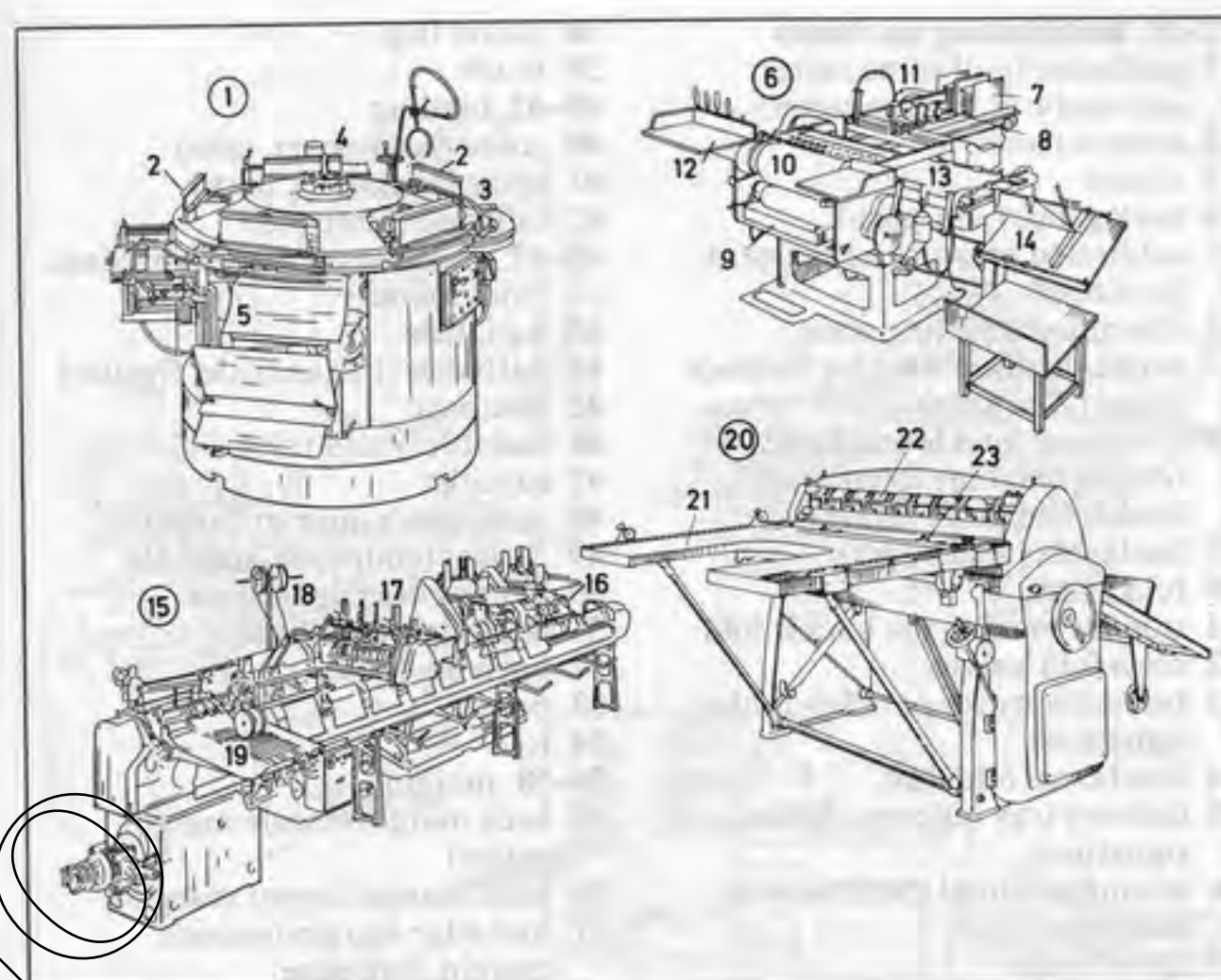

1-23 bookbinding machines

- 1 adhesive binder (perfect binder) for short runs
- 2 manual feed station
- 3 cutoff knife and roughing station
- 4 gluing mechanism
- 5 delivery (book delivery)
- 6 case maker (case-making machine)
- 7 board feed hopper
- 8 pickup sucker
- 9 glue tank
- 10 cover cylinder
- 11 picker head
- 12 feed table for covering materials [linen, paper, leather]
- 13 pressing mechanism
- 14 delivery table
- 15 gang stitcher (gathering and wire-stitching machine, gatherer and wire stitcher)
- 16 sheet feeder (sheet-feeding station)
- 17 folder-feeding station
- 18 stitching wire feed mechanism
- 19 delivery table
- 20 rotary board cutter (rotary board-cutting machine)
- 21 feed table with cut-out section
- 22 rotary cutter
- 23 feed guide

1-35 bookbinding machines

- 1 guillotine (guillotine cutter, automatic guillotine cutter)
- 2 control panel
- 3 clamp
- 4 back gauge (*Am. gage*)
- 5 calibrated pressure adjustment [to clamp]
- 6 illuminated cutting scale
- 7 single-hand control for the back gauge (*Am. gage*)
- 8 combined buckle and knife folding machine (combined buckle and knife folder)
- 9 feed table (feed board)
- 10 fold plates
- 11 stop for making the buckle fold
- 12 cross fold knives
- 13 belt delivery for parallel-folded signatures
- 14 third cross fold unit
- 15 delivery tray for cross-folded signatures
- 16 sewing machine (book-sewing machine)
- 17 spool holder
- 18 thread cop (thread spool)
- 19 gauze roll holder (mull roll holder, scrim roll holder)
- 20 gauze (mull, scrim)
- 21 needle cylinder with sewing needles
- 22 sewn book
- 23 delivery
- 24 reciprocating saddle
- 25 sheet feeder (feeder)
- 26 feed hopper
- 27 casing-in machine
- 28 joint and side pasting attachment
- 29 blade
- 30 preheater unit
- 31 gluing machine for whole-surface, stencil, edge, and strip gluing
- 32 glue tank
- 33 glue roller
- 34 feed table
- 35 delivery
- 36 **book**
- 37 dust jacket (dust cover, bookjacket, wrapper), a publisher's wrapper

- 38 jacket flap
- 39 blurb
- 40-42 **binding**
- 40 cover (book cover, case)
- 41 spine (backbone, back)
- 42 tailband (footband)
- 43-47 preliminary matter (prelims, front matter)
- 43 half-title
- 44 half-title (bastard title, fly title)
- 45 title page
- 46 full title (main title)
- 47 subtitle
- 48 publisher's imprint (imprint)
- 49 fly leaf (endpaper, endleaf)
- 50 handwritten dedication
- 51 bookplate (ex libris)
- 52 open book
- 53 page
- 54 fold
- 55-58 **margin**
- 55 back margin (inside margin, gutter)
- 56 head margin (upper margin)
- 57 fore edge margin (outside margin, fore edge)
- 58 tail margin (foot margin, tail, foot)
- 59 type area
- 60 chapter heading
- 61 asterisk
- 62 footnote
- 63 page number
- 64 double-column page
- 65 column
- 66 running title (running head)
- 67 caption
- 68 marginal note (side note)
- 69 signature (signature code)
- 70 attached bookmark (attached bookmarker)
- 71 loose bookmark (loose bookmarker)

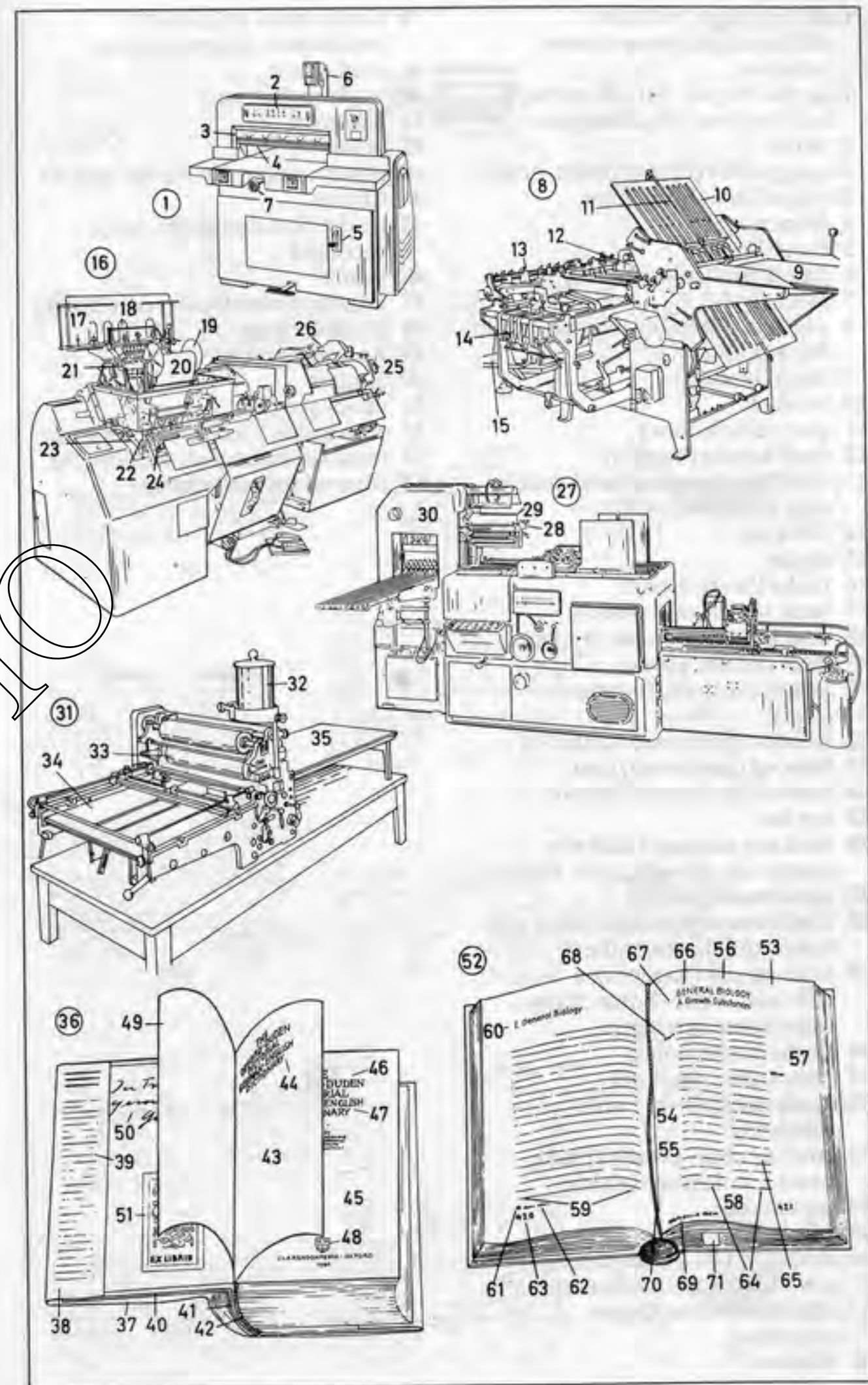

- 1-54 carriages (vehicles, conveyances, horse-drawn vehicles)
- 1-3, 26-39, 45, 51-54 carriages and coaches (coach wagons)
- 1 berlin
- 2 waggonette (*larger*: brake, break)
- 3 coupé; *sim.*: brougham
- 4 front wheel
- 5 coach body
- 6 dashboard (splashboard)
- 7 footboard
- 8 coach box (box, coachman's seat, driver's seat)
- 9 lamp (lantern)
- 10 window
- 11 door (coach door)
- 12 door handle (handle)
- 13 footboard (carriage step, coach step, step, footpiece)
- 14 fixed top
- 15 spring
- 16 brake (brake block)
- 17 back wheel (rear wheel)
- 18 dogcart, a one-horse carriage
- 19 shafts (thills, poles)
- 20 lackey (lacquey, footman)
- 21 livery
- 22 braided (gallooned) collar
- 23 braided (gallooned) coat
- 24 braided (gallooned) sleeve
- 25 top hat
- 26 hackney carriage (hackney coach, cab, growler, *Am.* hack)
- 27 stableman (groom)
- 28 coach horse (carriage horse, cab horse, thill horse, thiller)
- 29 hansom cab (hansom), a cabriolet, a one-horse chaise (one-horse carriage)
- 30 shafts (thills, poles)
- 31 reins (rein, *Am.* line)
- 32 coachman (driver) with inverness
- 33 covered char-a-banc (brake, break), a pleasure vehicle
- 34 gig (chaise)
- 35 barouche
- 36 landau, a two-horse carriage; *sim.*: landaulet, landalette
- 37 omnibus (horse-drawn omnibus)
- 38 phaeton
- 39 Continental stagecoach (mailcoach, diligence); *also*: road coach
- 40 mailcoach driver
- 41 posthorn
- 42 hood
- 43 post horses (relay horses, relays)
- 44 tilbury
- 45 troika (Russian three-horse carriage)
- 46 leader
- 47 wheeler (wheelhorse, pole horse)
- 48 English buggy
- 49 American buggy
- 50 tandem
- 51 vis-à-vis
- 52 collapsible hood (collapsible top)
- 53 mailcoach (English stagecoach)
- 54 covered (closed) chaise

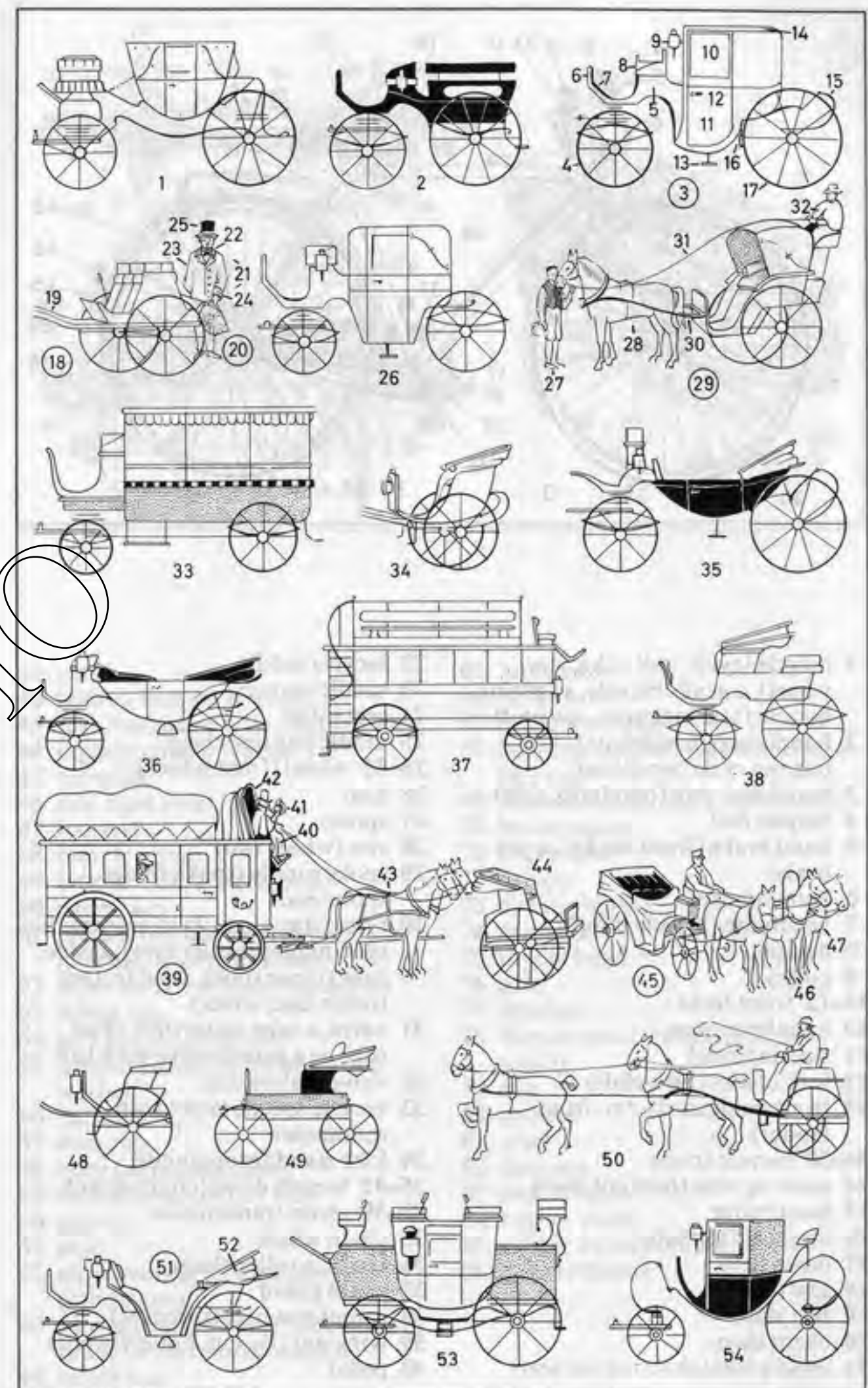

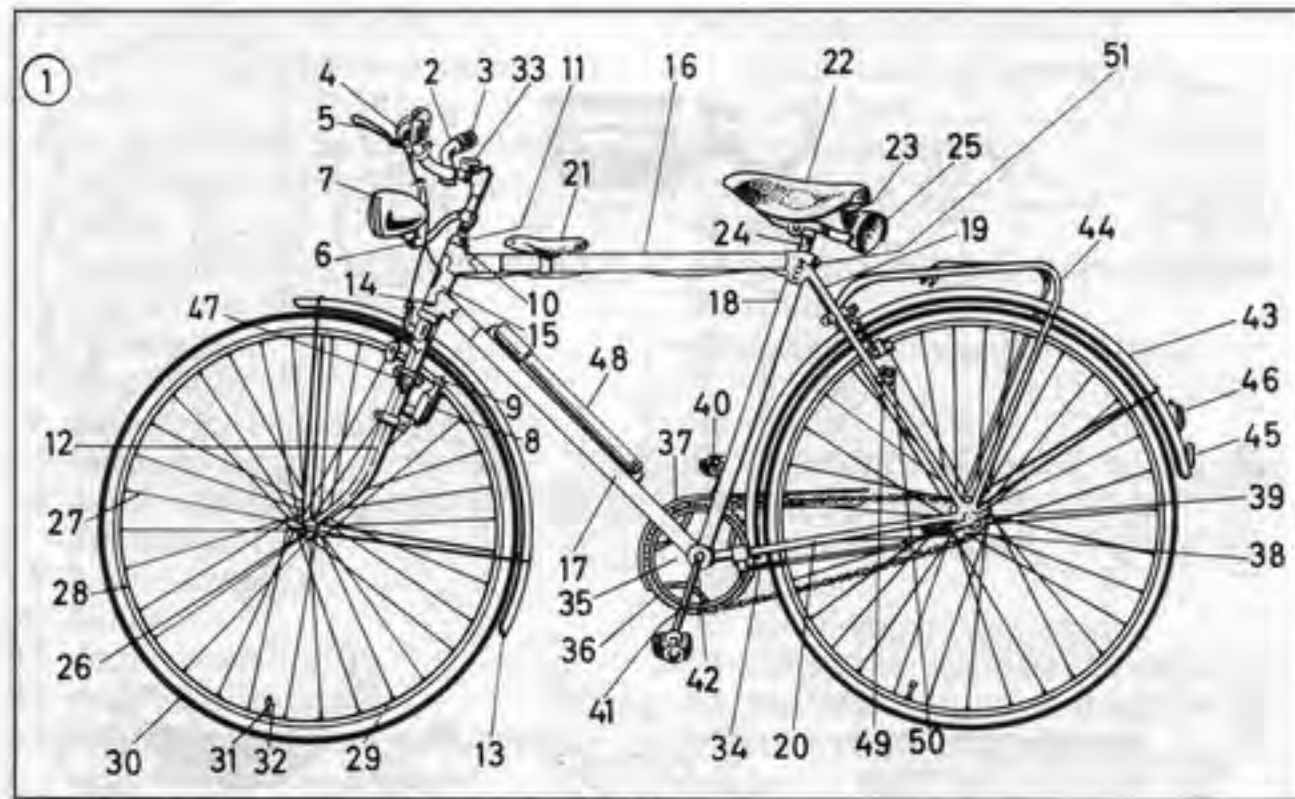

- 1 bicycle (cycle, *coll.* bike, *Am.* wheel), a gent's bicycle, a touring bicycle (touring cycle, roadster)
- 2 handlebar (handlebars), a touring cycle handlebar
- 3 handlebar grip (handgrip, grip)
- 4 bicycle bell
- 5 hand brake (front brake), a rim brake
- 6 lamp bracket
- 7 headlamp (bicycle lamp)
- 8 dynamo
- 9 pulley
- 10-12 front forks
- 10 handlebar stem
- 11 steering head
- 12 fork blades (fork ends)
- 13 front mudguard (*Am.* front fender)
- 14-20 bicycle frame
- 14 steering tube (fork column)
- 15 head badge
- 16 crossbar (top tube)
- 17 down tube
- 18 seat tube
- 19 seat stays
- 20 chain stays
- 21 child's seat (child carrier seat)

- 22 bicycle saddle
- 23 saddle springs
- 24 seat pillar
- 25 saddle bag (tool bag)
- 26-32 wheel (front wheel)
- 26 hub
- 27 spoke
- 28 rim (wheel rim)
- 29 spoke nipple (spoke flange, spoke end)
- 30 tyres (*Am.* tires) (tyre, pneumatic tyre, high-pressure tyre); *inside*: tube (inner tube), *outside*: tyre (outer case, cover)
- 31 valve, a tube valve with valve tube or a patent valve with ball
- 32 valve sealing cap
- 33 bicycle speedometer with milometer
- 34 kick stand (prop stand)
- 35-42 bicycle drive (chain drive)
- 35-39 chain transmission
- 35 chain wheel
- 36 chain, a roller chain
- 37 chain guard
- 38 sprocket wheel (sprocket)
- 39 wing nut (fly nut, butterfly nut)
- 40 pedal

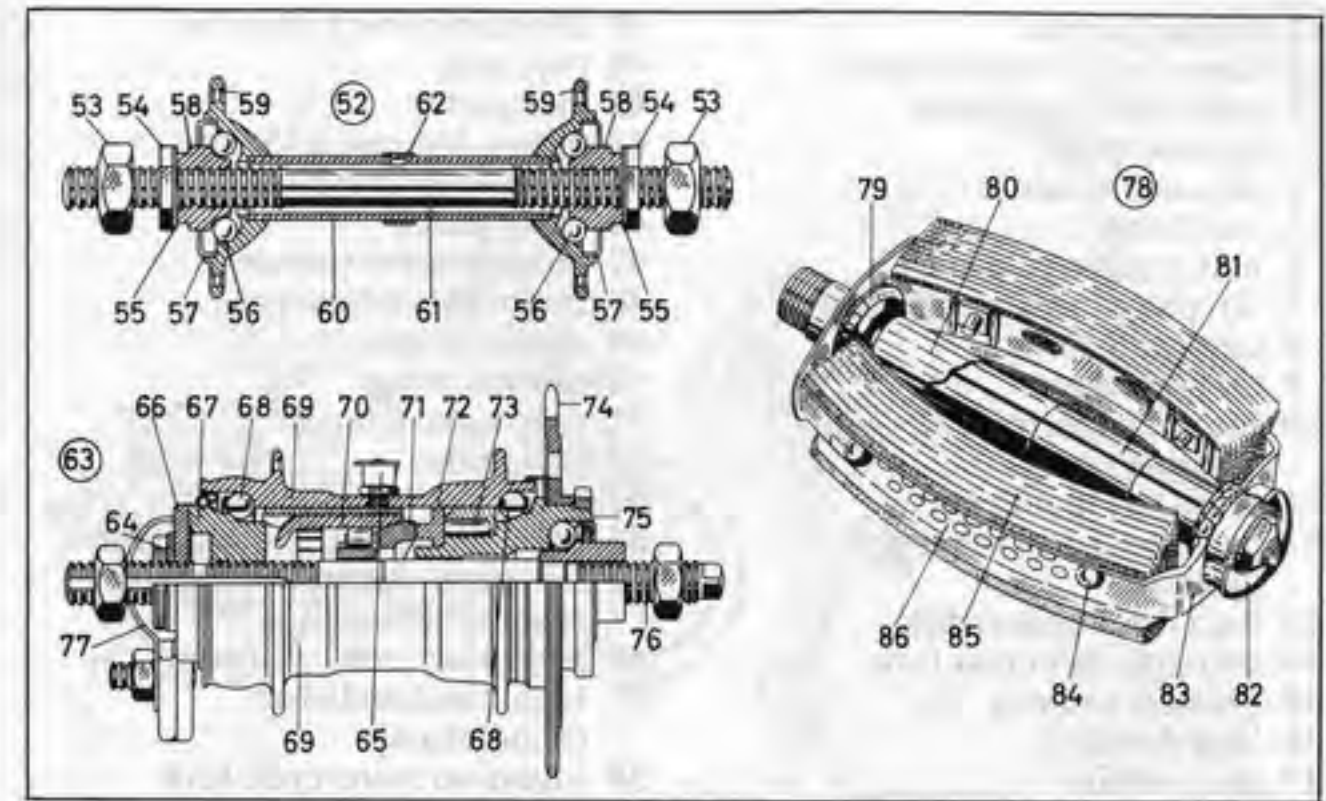

- 41 crank
- 42 bottom bracket bearing
- 43 rear mudguard (*Am.* rear fender)
- 44 luggage carrier (carrier)
- 45 reflector
- 46 rear light (rear lamp)
- 47 footrest
- 48 bicycle pump
- 49 bicycle lock, a wheel lock
- 50 patent key
- 51 cycle serial number (factory number, frame number)
- 52 front hub (front hub assembly)
- 53 wheel nut
- 54 locknut (locking nut)
- 55 washer (slotted cone adjusting washer)
- 56 ball bearing
- 57 dust cap
- 58 cone (adjusting cone)
- 59 centre (*Am.* center) hub
- 60 spindle
- 61 axle
- 62 clip covering lubrication hole (lubricator)
- 63 free-wheel hub with back-pedal brake (with coaster brake)
- 64 safety nut

- 65 lubricator
- 66 brake arm
- 67 brake arm cone
- 68 bearing cup with ball bearings in ball race
- 69 hub shell (hub body, hub barrel)
- 70 brake casing
- 71 brake cone
- 72 driver
- 73 driving barrel
- 74 sprocket
- 75 thread head
- 76 axle
- 77 bracket
- 78 bicycle pedal (pedal, reflector pedal)
- 79 cup
- 80 spindle
- 81 axle
- 82 dust cap
- 83 pedal frame
- 84 rubber stud
- 85 rubber block (rubber tread)
- 86 glass reflector

- | | |
|---|---|
| 1 folding bicycle | 41 telescopic shock absorber |
| 2 hinge (<i>also</i> : locking lever) | 42 twin seat |
| 3 adjustable handlebar
(handlebars) | 43 kickstarter |
| 4 adjustable saddle | 44 pillion footrest, a footrest |
| 5 stabilizers | 45 handlebar (handlebars) |
| 6 motor-assisted bicycle | 46 chain guard |
| 7 air-cooled two-stroke engine | 47 motor scooter (scooter) |
| 8 telescopic forks | 48 removable side panel |
| 9 tubular frame | 49 tubular frame |
| 10 fuel tank (petrol tank, <i>Am.</i>
gasoline tank) | 50 metal fairings |
| 11 semi-rise handlebars | 51 prop stand (stand) |
| 12 two-speed gear-change
(gearshift) | 52 foot brake |
| 13 high-back polo saddle | 53 horn (hooter) |
| 14 swinging-arm rear fork | 54 hook for handbag or briefcase |
| 15 upswept exhaust | 55 foot gear-change control (foot
gearshift control) |
| 16 heat shield | 56 high-riser; <i>sim.</i> : Chopper |
| 17 drive chain | 57 high-rise handlebar
(handlebars) |
| 18 crash bar (roll bar) | 58 imitation motorcycle fork |
| 19 speedometer (<i>coll. speedo</i>) | 59 banana saddle |
| 20 battery-powered moped, an
electrically-powered vehicle | 60 chrome bracket |
| 21 swivel saddle | |
| 22 battery compartment | |
| 23 wire basket | |
| 24 touring moped (moped) | |
| 25 pedal crank (pedal drive, starter
pedal) | |
| 26 single-cylinder two-stroke
engine | |
| 27 spark-plug cap | |
| 28 fuel tank (petrol tank, <i>Am.</i>
gasoline tank) | |
| 29 moped headlamp (front lamp) | |
| 30-35 handlebar fittings | |
| 30 twist grip throttle control
(throttle twist grip) | |
| 31 twist grip (gear-change,
gearshift) | |
| 32 clutch lever | |
| 33 hand brake lever | |
| 34 speedometer (<i>coll. speedo</i>) | |
| 35 rear-view mirror (mirror) | |
| 36 front wheel drum brake (drum
brake) | |
| 37 Bowden cables (brake cables) | |
| 38 stop and tail light unit | |
| 39 light motorcycle with kickstarter | |
| 40 housing for instruments with
speedometer and electronic rev
counter (revolution counter) | |

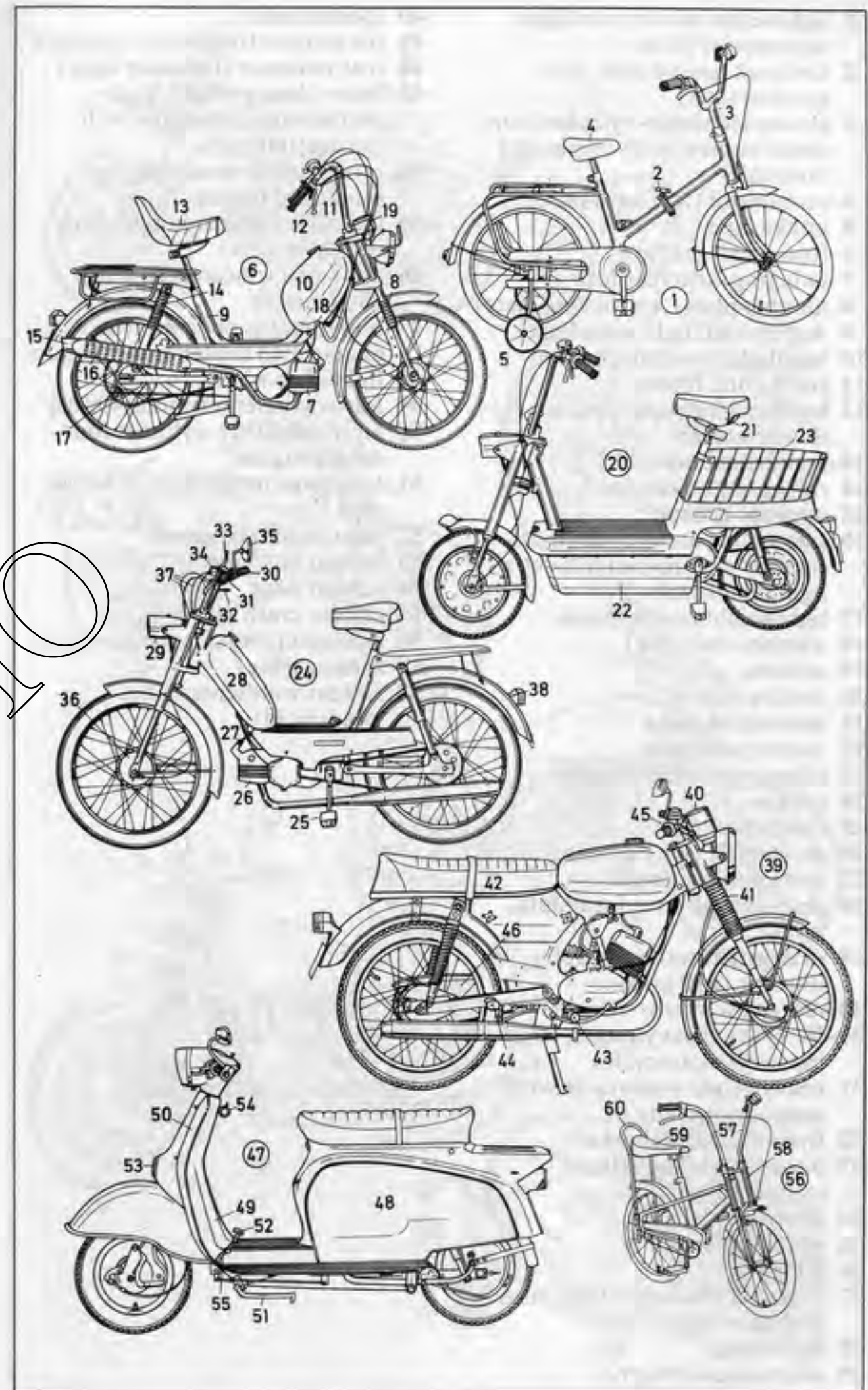

- 1 lightweight motorcycle (light motorcycle) [50 cc]
- 2 fuel tank (petrol tank, *Am.* gasoline tank)
- 3 air-cooled single-cylinder four-stroke engine (with overhead camshaft)
- 4 carburettor (*Am.* carburetor)
- 5 intake pipe
- 6 five-speed gearbox
- 7 swinging-arm rear fork
- 8 number plate (*Am.* license plate)
- 9 stop and tail light (rear light)
- 10 headlight (headlamp)
- 11 front drum brake
- 12 brake cable (brake line), a Bowden cable
- 13 rear drum brake
- 14 racing-style twin seat
- 15 upswept exhaust
- 16 scrambling motorcycle (cross-country motorcycle) [125 cc], a light motorcycle
- 17 lightweight cradle frame
- 18 number disc (disk)
- 19 solo seat
- 20 cooling ribs
- 21 motorcycle stand
- 22 motorcycle chain
- 23 telescopic shock absorber
- 24 spokes
- 25 rim (wheel rim)
- 26 motorcycle tyre (*Am.* tire)
- 27 tyre (*Am.* tire) tread
- 28 gear-change lever (gearshift lever)
- 29 twist grip throttle control (throttle twist grip)
- 30 rear-view mirror (mirror)
- 31-58 heavy (heavyweight, large-capacity) motorcycles
- 31 heavyweight motorcycle with water-cooled engine
- 32 front disc (disk) brake
- 33 disc (disk) brake calliper (caliper)
- 34 floating axle
- 35 water cooler
- 36 oil tank
- 37 indicator (indicator light, turn indicator light)
- 38 kickstarter
- 39 water-cooled engine
- 40 speedometer
- 41 rev counter (revolution counter)
- 42 rear indicator (indicator light)
- 43 heavy (heavyweight, high-performance) machine with fairing [1000 cc]
- 44 integrated streamlining, an integrated fairing
- 45 indicator (indicator light, turn indicator light)
- 46 anti-mist windscreen (*Am.* windshield)
- 47 horizontally-opposed twin engine with cardan transmission
- 48 light alloy wheel
- 49 four-cylinder machine [400 cc]
- 50 air-cooled four-cylinder four-stroke engine
- 51 four-pipe megaphone exhaust pipe
- 52 electric starter button
- 53 sidecar machine
- 54 sidecar body
- 55 sidecar crash bar
- 56 sidelight (*Am.* sidemarker lamp)
- 57 sidecar wheel
- 58 sidecar windscreen (*Am.* windshield)

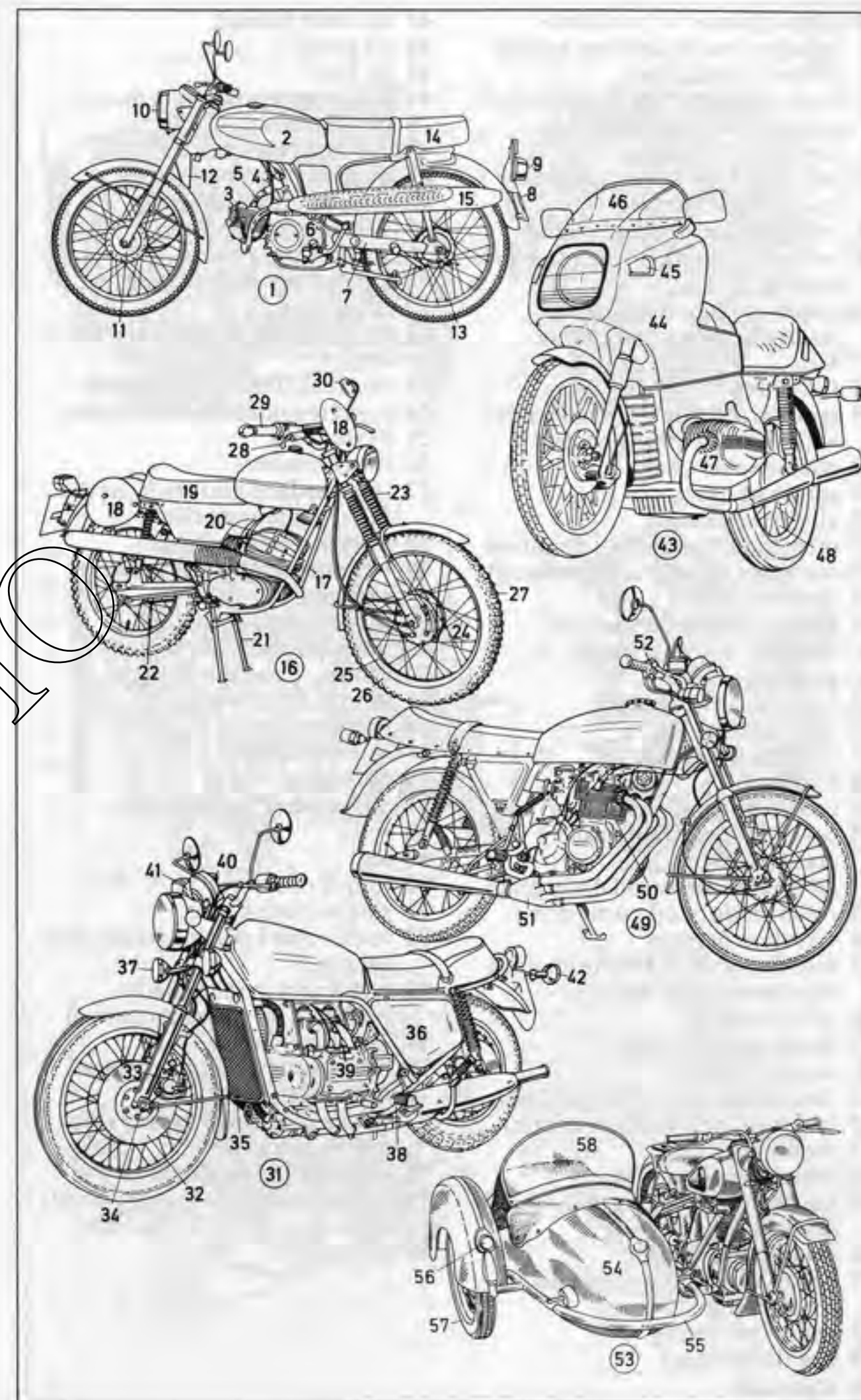

- 1 eight-cylinder V (vee) fuel-injection spark-ignition engine (Otto-cycle engine)
- 2 cross-section of spark-ignition engine (Otto-cycle internal combustion engine)
- 3 sectional view of five-cylinder in-line diesel engine
- 4 cross-section of diesel engine
- 5 two-rotor Wankel engine (rotary engine)
- 6 single-cylinder two-stroke internal combustion engine
- 7 fan
- 8 fan clutch for viscous drive
- 9 ignition distributor (distributor) with vacuum timing control
- 10 double roller chain
- 11 camshaft bearing
- 12 air-bleed duct
- 13 oil pipe for camshaft lubrication
- 14 camshaft, an overhead camshaft
- 15 venturi throat
- 16 intake silencer (absorption silencer, *Am.* absorption muffler)
- 17 fuel pressure regulator
- 18 inlet manifold
- 19 cylinder crankcase
- 20 flywheel
- 21 connecting rod (piston rod)
- 22 cover of crankshaft bearing
- 23 crankshaft
- 24 oil bleeder screw (oil drain plug)
- 25 roller chain of oil pump drive
- 26 vibration damper
- 27 distributor shaft for the ignition distributor (distributor)
- 28 oil filler neck
- 29 diaphragm spring
- 30 control linkage
- 31 fuel supply pipe (*Am.* fuel line)
- 32 fuel injector (injection nozzle)
- 33 rocker arm
- 34 rocker arm mounting
- 35 spark plug (sparking plug) with suppressor
- 36 exhaust manifold
- 37 piston with piston rings and oil scraper ring
- 38 engine mounting
- 39 dog flange (dog)
- 40 crankcase
- 41 oil sump (sump)
- 42 oil pump
- 43 oil filter
- 44 starter motor (starting motor)
- 45 cylinder head
- 46 exhaust valve
- 47 dipstick
- 48 cylinder head gasket
- 49 double bushing chain
- 50 warm-up regulator
- 51 tapered needle for idling adjustment
- 52 fuel pressure pipe (fuel pressure line)
- 53 fuel leak line (drip fuel line)
- 54 injection nozzle (spray nozzle)
- 55 heater plug
- 56 thrust washer
- 57 intermediate gear shaft for the injection pump drive
- 58 injection timer unit
- 59 vacuum pump (low-pressure regulator)
- 60 cam for vacuum pump
- 61 water pump (coolant pump)
- 62 cooling water thermostat
- 63 thermo time switch
- 64 fuel hand pump
- 65 injection pump
- 66 glow plug
- 67 oil pressure limiting valve
- 68 rotor
- 69 seal
- 70 torque converter
- 71 single-plate clutch
- 72 multi-speed gearing (multi-step gearing)
- 73 port liners in the exhaust manifold for emission control
- 74 disc (disk) brake
- 75 differential gear (differential)
- 76 generator
- 77 foot gear-change control (foot gearshift control)
- 78 dry multi-plate clutch
- 79 cross-draught (*Am.* cross-draft) carburettor (*Am.* carburetor)
- 80 cooling ribs

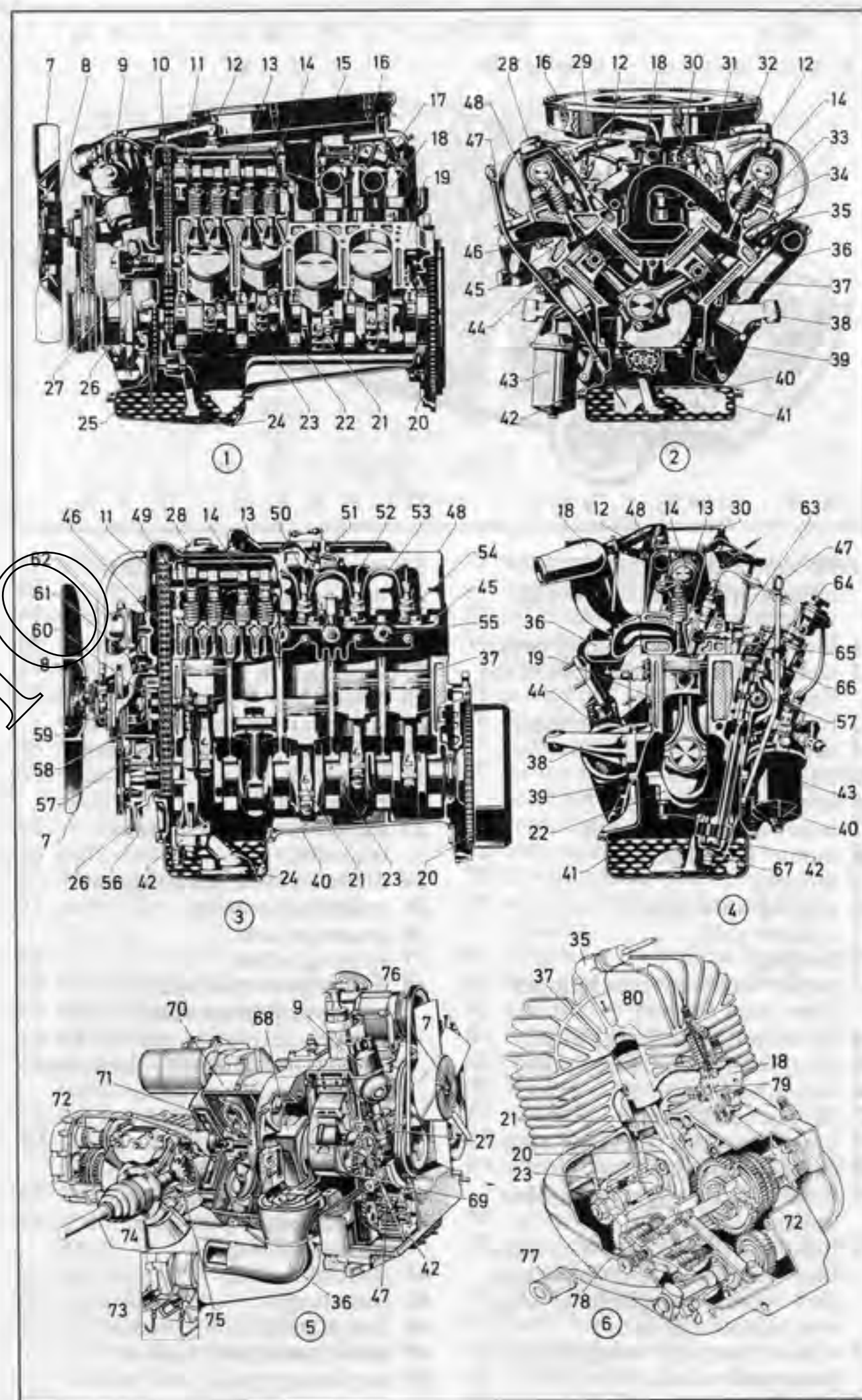

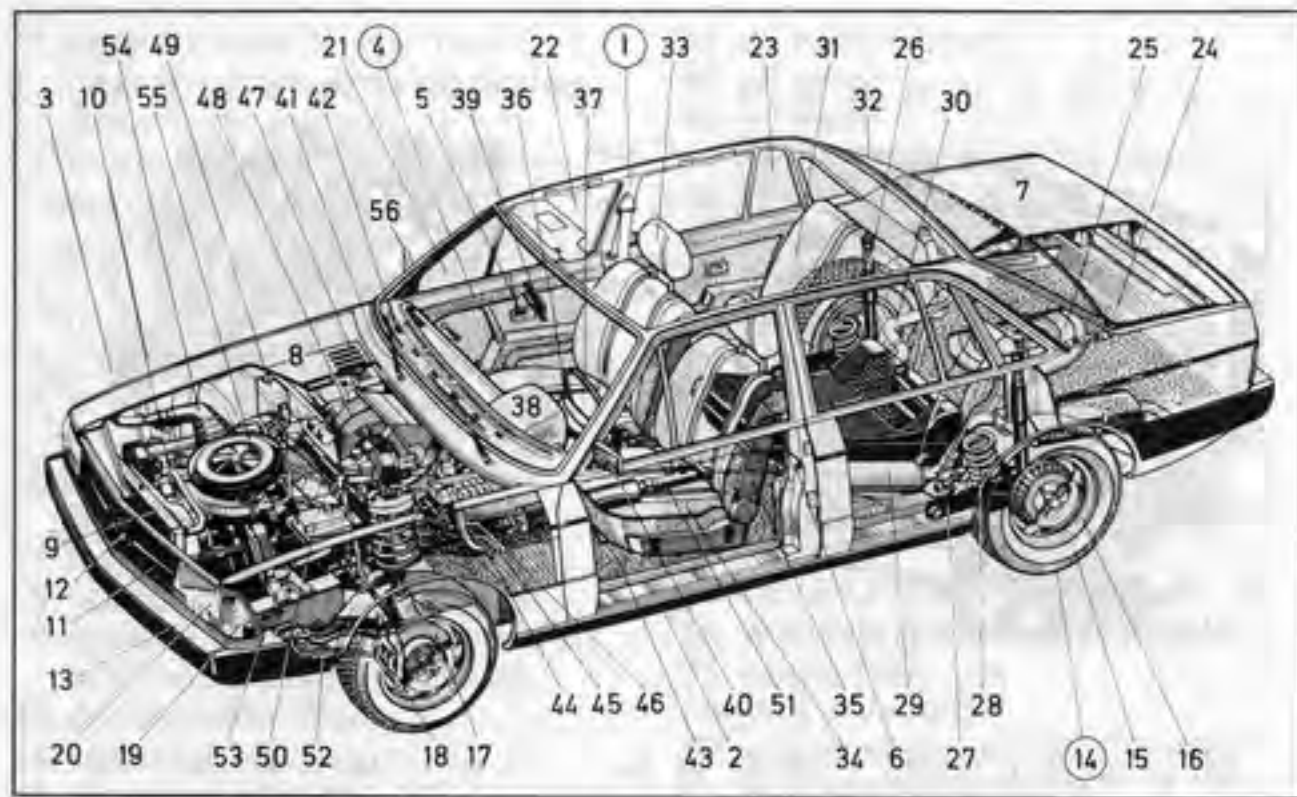

- 1-56 motor car (car, *Am. automobile, auto*), a passenger vehicle
- 1 monocoque body (unitary body)
- 2 chassis, the understructure of the body
- 3 front wing (*Am. front fender*)
- 4 car door
- 5 door handle
- 6 door lock
- 7 boot lid (*Am. trunk lid*)
- 8 bonnet (*Am. hood*)
- 9 radiator
- 10 cooling water pipe
- 11 radiator grill
- 12 badging
- 13 rubber-covered front bumper (*Am. front fender*)
- 14 car wheel, a disc (disk) wheel
- 15 car tyre (*Am. automobile tire*)
- 16 rim (wheel rim)
- 17-18 disc (disk) brake
- 17 brake disc (disk) (braking disc)
- 18 calliper (caliper)
- 19 front indicator light (front turn indicator light)
- 20 headlight (headlamp) with main beam (high beam), dipped beam (low beam), sidelight (side lamp, *Am. sidemarker lamp*)
- 21 windscreen (*Am. windshield*), a panoramic windscreen
- 22 crank-operated car window
- 23 quarter light (quarter vent)
- 24 boot (*Am. trunk*)
- 25 spare wheel
- 26 damper (shock absorber)
- 27 trailing arm
- 28 coil spring
- 29 silencer (*Am. muffler*)
- 30 automatic ventilation system
- 31 rear seats
- 32 rear window
- 33 adjustable headrest (head restraint)
- 34 driver's seat, a reclining seat
- 35 reclining backrest
- 36 passenger seat
- 37 steering wheel
- 38 centre (*Am. center*) console containing speedometer (*coll. speedo*), revolution counter (*rev counter, tachometer*), clock, fuel gauge (*Am. gage*), water temperature gauge, oil temperature gauge
- 39 inside rear-view mirror
- 40 left-hand wing mirror
- 41 windscreen wiper (*Am. windshield wiper*)
- 42 defroster vents
- 43 carpeting
- 44 clutch pedal (*coll. clutch*)
- 45 brake pedal (*coll. brake*)
- 46 accelerator pedal (*coll. accelerator*)

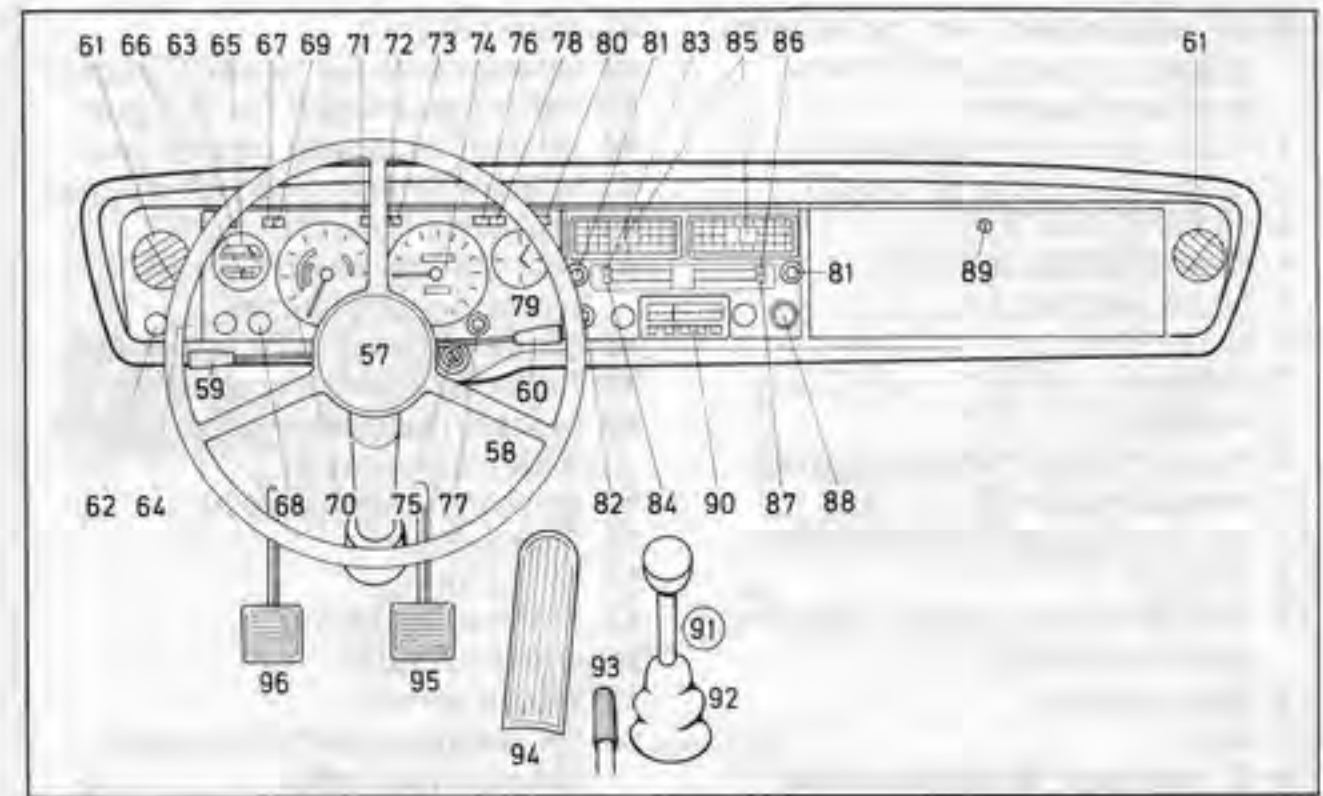

- 47 inlet vent
- 48 blower fan
- 49 brake fluid reservoir
- 50 battery
- 51 exhaust pipe
- 52 front running gear with front wheel drive
- 53 engine mounting
- 54 intake silencer (*Am. intake muffler*)
- 55 air filter (air cleaner)
- 56 right-hand wing mirror
- 57-90 dashboard (fascia panel)
- 57 controlled-collapse steering column
- 58 steering wheel spoke
- 59 indicator and dimming switch
- 60 wiper/washer switch and horn
- 61 side window blower
- 62 sidelight, headlight, and parking light switch
- 63 fog lamp warning light
- 64 fog headlamp and rear lamp switch
- 65 fuel gauge (*Am. gage*)
- 66 water temperature gauge (*Am. gage*)
- 67 warning light for rear fog lamp
- 68 hazard flasher switch
- 69 main beam warning light
- 70 electric rev counter (revolution counter)
- 71 fuel warning light
- 72 warning light for the hand brake and dual-circuit brake system
- 73 oil pressure warning light
- 74 speedometer (*coll. speedo*) with trip mileage recorder
- 75 starter and steering lock
- 76 warning lights for turn indicators and hazard flashers
- 77 switch for the courtesy light and reset button for the trip mileage recorder
- 78 ammeter
- 79 electric clock
- 80 warning light for heated rear window
- 81 switch for the leg space ventilation
- 82 rear window heating switch
- 83 ventilation switch
- 84 temperature regulator
- 85 fresh-air inlet and control
- 86 fresh-air regulator
- 87 warm-air regulator
- 88 cigar lighter
- 89 glove compartment (glove box) lock
- 90 car radio
- 91 gear lever (gearshift lever, floor-type gear-change)
- 92 leather gaiter
- 93 hand brake lever
- 94 accelerator pedal
- 95 brake pedal
- 96 clutch pedal

- 1-15 carburettor (Am. carburetor), a down-draught (Am. down-draft) carburettor
- 1 idling jet (slow-running jet)
- 2 idling air jet (idle air bleed)
- 3 air correction jet
- 4 compensating airstream
- 5 main airstream
- 6 choke flap
- 7 plunger
- 8 venturi
- 9 throttle valve (butterfly valve)
- 10 emulsion tube
- 11 idle mixture adjustment screw
- 12 main jet
- 13 fuel inlet (Am. gasoline inlet) (inlet manifold)
- 14 float chamber
- 15 float
- 16-27 pressure-feed lubricating system
- 16 oil pump
- 17 oil sump
- 18 sump filter
- 19 oil cooler
- 20 oil filter
- 21 main oil gallery (drilled gallery)
- 22 crankshaft drilling (crankshaft tributary, crankshaft bleed)
- 23 crankshaft bearing (main bearing)
- 24 camshaft bearing
- 25 connecting-rod bearing
- 26 gudgeon pin (piston pin)
- 27 bleed
- 28-47 four-speed synchromesh gearbox
- 28 clutch pedal
- 29 crankshaft
- 30 drive shaft (propeller shaft)
- 31 starting gear ring
- 32 sliding sleeve for 3rd and 4th gear
- 33 synchronizing cone
- 34 helical gear wheel for 3rd gear
- 35 sliding sleeve for 1st and 2nd gear
- 36 helical gear wheel for 1st gear
- 37 lay shaft
- 38 speedometer drive
- 39 helical gear wheel for speedometer drive
- 40 main shaft
- 41 gearshift rods
- 42 selector fork for 1st and 2nd gear
- 43 helical gear wheel for 2nd gear
- 44 selector head with reverse gear
- 45 selector fork for 3rd and 4th gear
- 46 gear lever (gearshift lever)
- 47 gear-change pattern (gearshift pattern, shift pattern)
- 48-55 disc (disk) brake [assembly]
- 48 brake disc (disk) (braking disc)
- 49 calliper (caliper), a fixed calliper with friction pads
- 50 servo cylinder (servo unit)
- 51 brake shoes
- 52 brake lining
- 53 outlet to brake line
- 54 wheel cylinder
- 55 return spring
- 56-59 steering gear (worm-and-nut steering gear)
- 56 steering column
- 57 worm gear sector
- 58 steering drop arm
- 59 worm
- 60-64 water-controlled heater
- 60 air intake
- 61 heat exchanger (heater box)
- 62 blower fan
- 63 flap valve
- 64 defroster vent
- 65-71 live axle (rigid axle)
- 65 propeller shaft
- 66 trailing arm
- 67 rubber bush
- 68 coil spring
- 69 damper (shock absorber)
- 70 Panhard rod
- 71 stabilizer bar
- 72-84 MacPherson strut unit
- 72 body-fixing plate
- 73 upper bearing
- 74 suspension spring
- 75 piston rod
- 76 suspension damper
- 77 rim (wheel rim)
- 78 stub axle
- 79 steering arm
- 80 track-rod ball-joint
- 81 trailing link arm
- 82 bump rubber (rubber bonding)
- 83 lower bearing
- 84 lower suspension arm

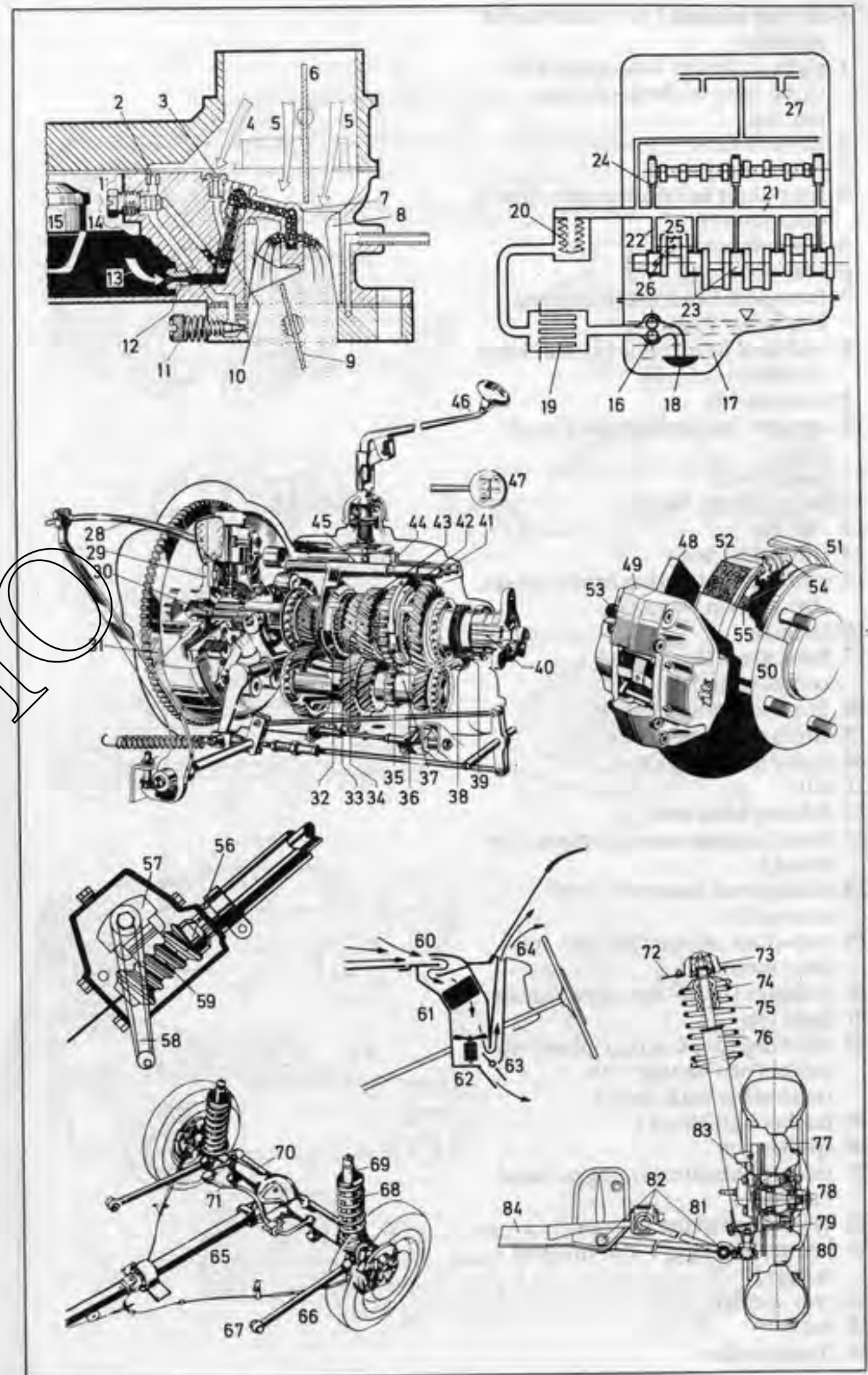

- 1-36 car models (*Am. automobile models*)
- 1 eight-cylinder limousine with three rows of three-abreast seating
 - 2 driver's door
 - 3 rear door
 - 4 four-door saloon car (*Am. four-door sedan*)
 - 5 front door
 - 6 rear door
 - 7 front seat headrest (front seat head restraint)
 - 8 rear seat headrest (rear seat head restraint)
 - 9 convertible
 - 10 convertible (collapsible) hood (top)
 - 11 bucket seat
 - 12 buggy (dune buggy)
 - 13 roll bar
 - 14 fibre glass body
 - 15 estate car (shooting brake, estate, *Am. station wagon*)
 - 16 tailgate
 - 17 boot space (luggage compartment)
 - 18 three-door hatchback
 - 19 small three-door car
 - 20 rear door (tailgate)
 - 21 sill
 - 22 folding back seat
 - 23 boot (luggage compartment, *Am. trunk*)
 - 24 sliding roof (sunroof, steel sunroof)
 - 25 two-door saloon car (*Am. two-door sedan*)
 - 26 roadster (hard-top), a two-seater
 - 27 hard top
 - 28 sporting coupé, a two-plus-two coupé (two-seater with removable back seats)
 - 29 fastback (liftback)
 - 30 spoiler rim
 - 31 integral headrest (integral head restraint)
 - 32 GT car (gran turismo car)
 - 33 integral bumper (*Am. integral fender*)
 - 34 rear spoiler
 - 35 back
 - 36 front spoiler

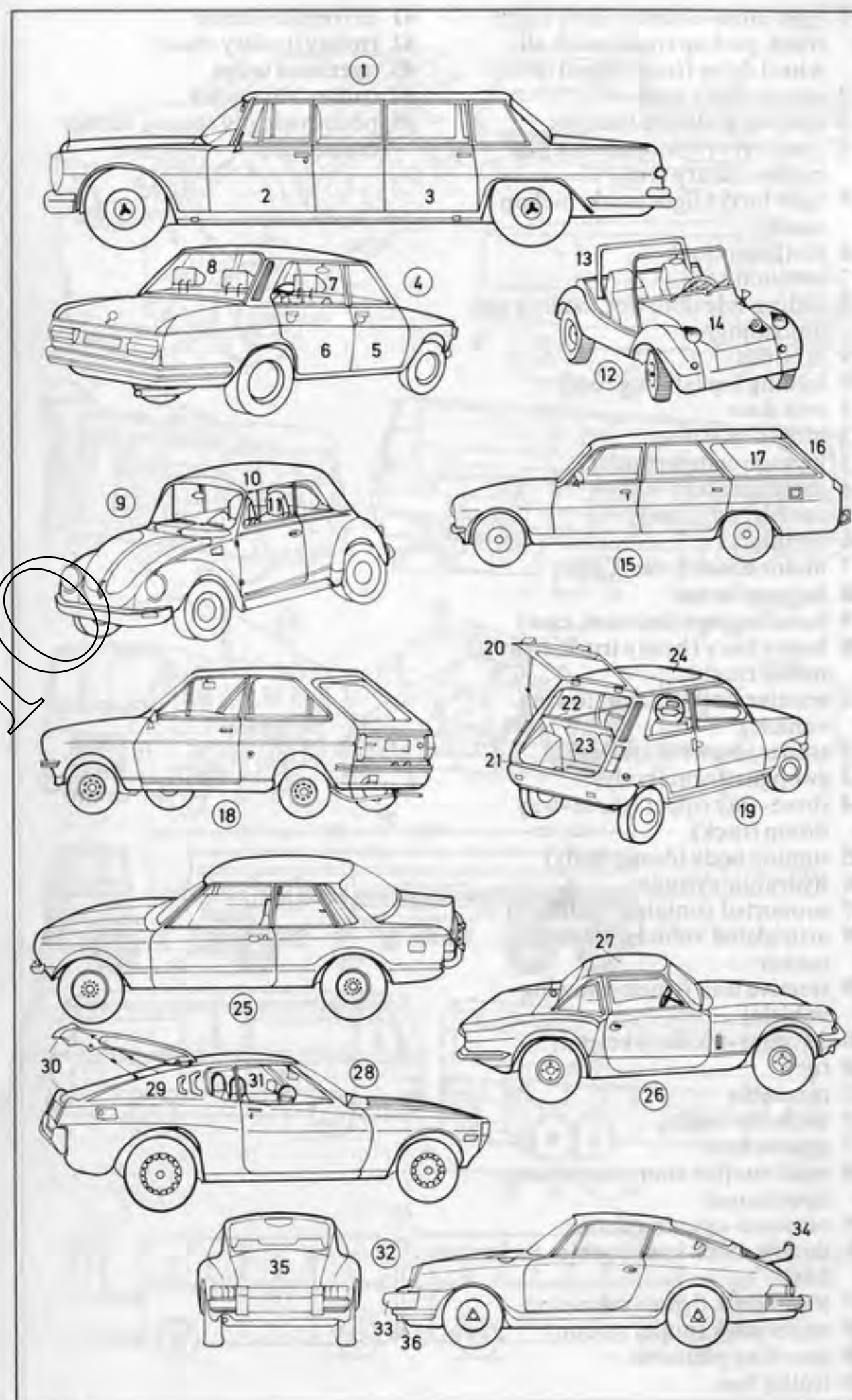

- 1 light cross-country lorry (light truck, pickup truck) with all-wheel drive (four-wheel drive)
- 2 cab (driver's cab)
- 3 loading platform (body)
- 4 spare tyre (Am. spare tire), a cross-country tyre
- 5 light lorry (light truck, pickup truck)
- 6 platform truck
- 7 medium van
- 8 sliding side door [for loading and unloading]
- 9 minibus
- 10 folding top (sliding roof)
- 11 rear door
- 12 hinged side door
- 13 luggage compartment
- 14 passenger seat
- 15 cab (driver's cab)
- 16 air inlet
- 17 motor coach (coach, bus)
- 18 luggage locker
- 19 hand luggage (suitcase, case)
- 20 heavy lorry (heavy truck, heavy motor truck)
- 21 tractive unit (tractor, towing vehicle)
- 22 trailer (drawbar trailer)
- 23 swop platform (body)
- 24 three-way tipper (three-way dump truck)
- 25 tipping body (dump body)
- 26 hydraulic cylinder
- 27 supported container platform
- 28 articulated vehicle, a vehicle tanker
- 29 tractive unit (tractor, towing vehicle)
- 30-33 semi-trailer (skeletal)
- 30 tank
- 31 turntable
- 32 undercarriage
- 33 spare wheel
- 34 midi bus [for short-route town operations]
- 35 outward-opening doors
- 36 double-deck bus (double-decker bus)
- 37 lower deck (lower saloon)
- 38 upper deck (upper saloon)
- 39 boarding platform
- 40 trolley bus

- 41 current collector
- 42 trolley (trolley shoe)
- 43 overhead wires
- 44 trolley bus trailer
- 45 pneumatically sprung rubber connection

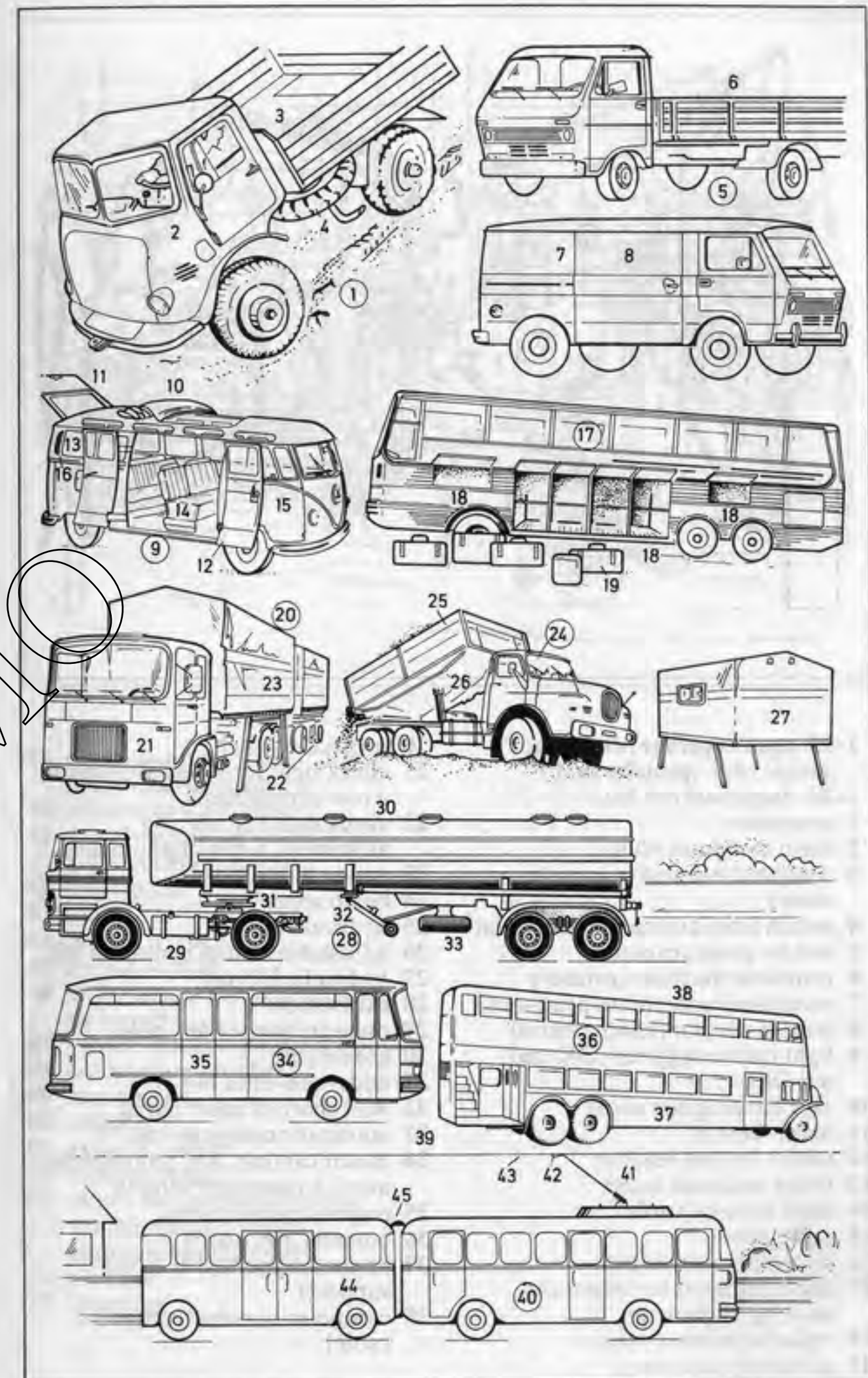



- 1-55 agent's garage (distributor's garage, Am. specialty shop)
- 1-23 diagnostic test bay
- 1 computer
- 2 main computer plug
- 3 computer harness (computer cable)
- 4 switch from automatic to manual
- 5 slot for program cards
- 6 print-out machine (printer)
- 7 condition report (data print-out)
- 8 master selector (hand control)
- 9 light read-out [green: OK; red: not OK]
- 10 rack for program cards
- 11 mains button
- 12 switch for fast readout
- 13 firing sequence insert
- 14 shelf for used cards
- 15 cable boom
- 16 oil temperature sensor
- 17 test equipment for wheel and steering alignment
- 18 right-hand optic plate
- 19 actuating transistors
- 20 projector switch
- 21 check light for wheel alignment, a row of photocells
- 22 check light for steering alignment, a row of photocells
- 23 power screwdriver
- 24 beam setter
- 25 hydraulic lift
- 26 adjustable arm of hydraulic lift
- 27 hydraulic lift pad
- 28 excavation
- 29 pressure gauge (Am. gage)
- 30 grease gun
- 31 odds-and-ends box
- 32 wall chart [of spare parts]
- 33 automatic computer test
- 34 motor car (car, Am. automobile, auto), a passenger vehicle
- 35 engine compartment
- 36 bonnet (Am. hood)
- 37 bonnet support (Am. hood support)
- 38 computer harness (computer cable)

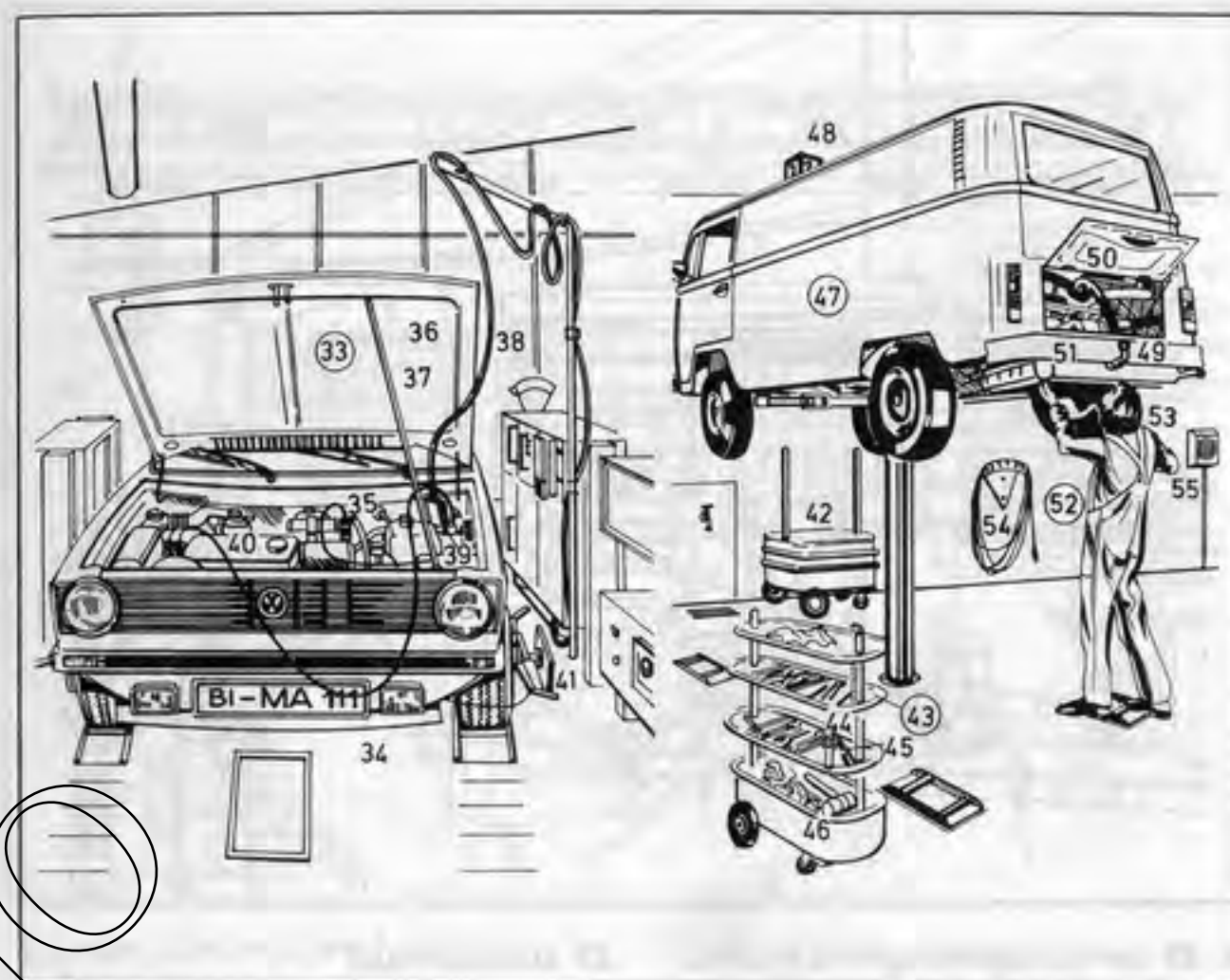

- 39 main computer socket; also: multi-outlet socket
- 40 oil temperature sensor
- 41 wheel mirror for visual wheel and steering alignment
- 42 tool trolley
- 43 tools
- 44 impact wrench
- 45 torque wrench
- 46 body hammer (roughing-out hammer)
- 47 vehicle under repair, a minibus
- 48 car location number
- 49 rear engine
- 50 tailgate
- 51 exhaust system
- 52 exhaust repair
- 53 motor car mechanic (motor vehicle mechanic, Am. automotive mechanic)
- 54 air hose
- 55 intercom

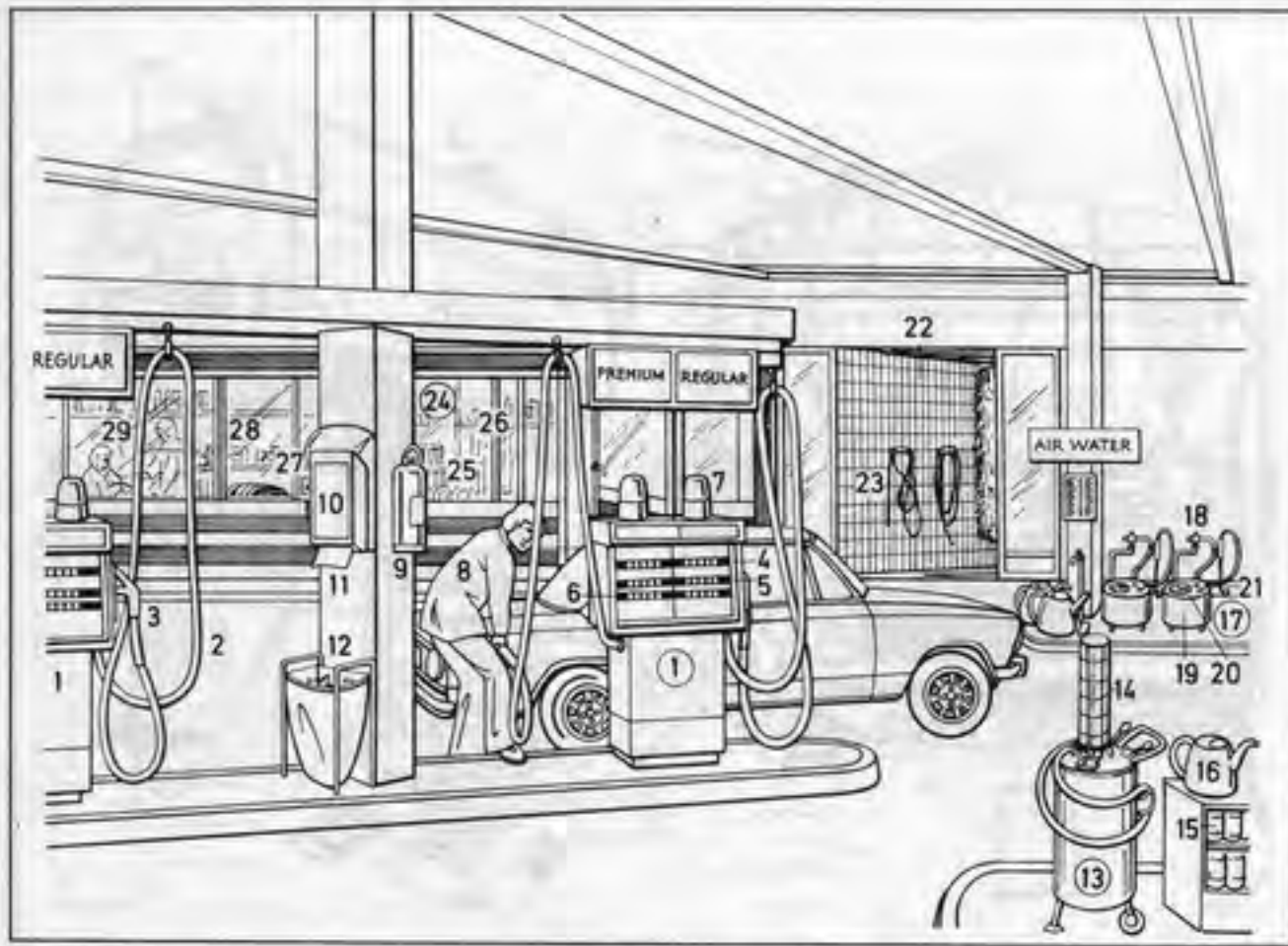

- 1-29 service station (petrol station, filling station, *Am.* gasoline station, gas station), a self-service station
- 1 petrol (*Am.* gasoline) pump (blending pump) for regular and premium grade petrol (*Am.* gasoline) (*sim.*: for derv)
- 2 hose (petrol pump, *Am.* gasoline pump, hose)
- 3 nozzle
- 4 cash readout
- 5 volume read-out
- 6 price display
- 7 indicator light
- 8 driver using self-service petrol pump (*Am.* gasoline pump)
- 9 fire extinguisher
- 10 paper-towel dispenser
- 11 paper towel
- 12 litter receptacle
- 13 two-stroke blending pump
- 14 meter
- 15 engine oil
- 16 oil can
- 17 tyre pressure gauge (*Am.* tire pressure gage)
- 18 air hose
- 19 static air tank
- 20 pressure gauge (*Am.* gage) (manometer)
- 21 air filler neck
- 22 repair bay (repair shop)
- 23 car-wash hose, a hose (hosepipe)
- 24 accessory shop
- 25 petrol can (*Am.* gasoline can)
- 26 rain cape
- 27 car tyres (*Am.* automobile tires)
- 28 car accessories
- 29 cash desk (console)

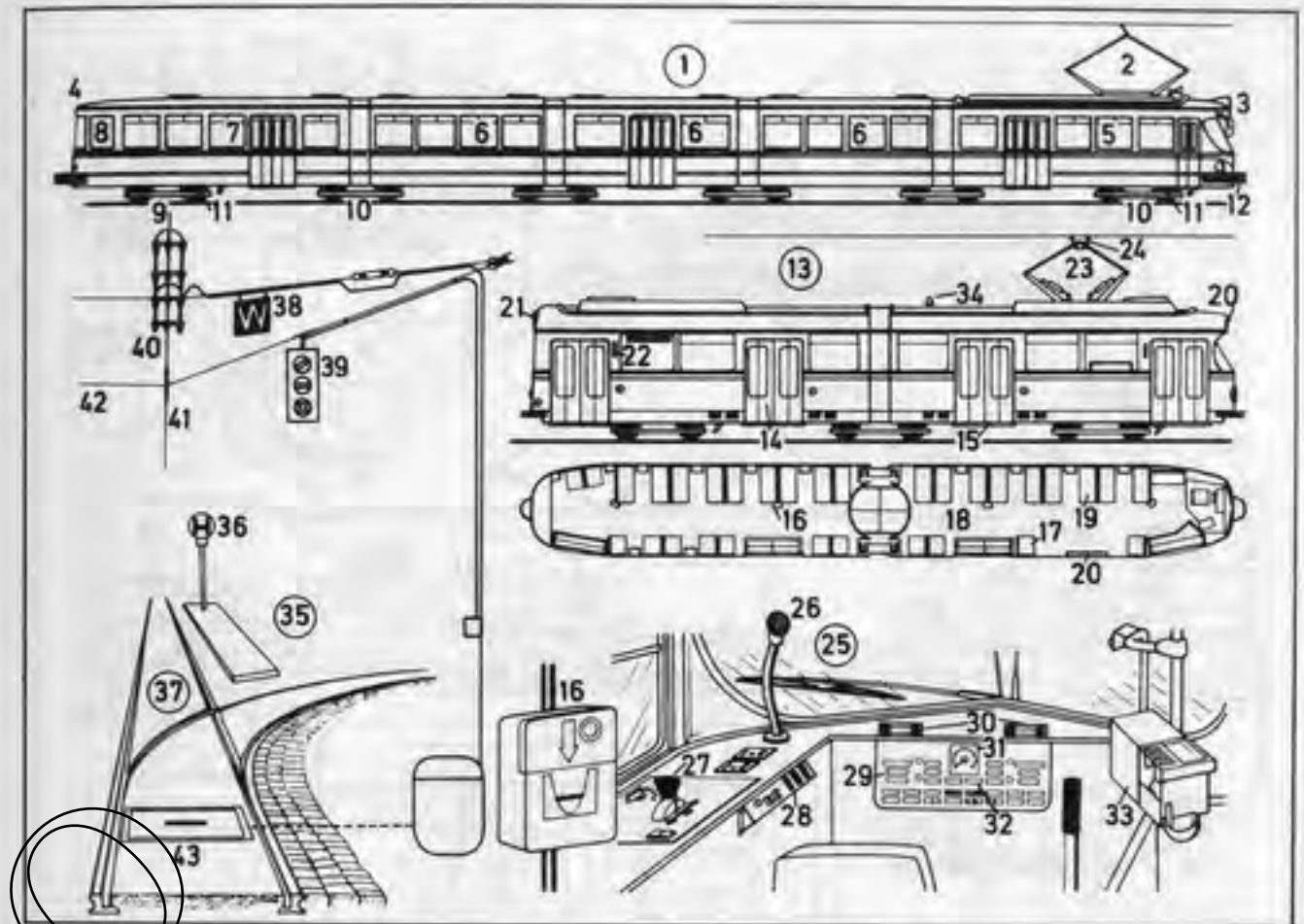

- 1 twelve-axle articulated railcar for interurban rail service
- 2 current collector
- 3 head of the railcar
- 4 rear of the railcar
- 5 carriage A containing the motor
- 6 carriage B (*also*: carriages C and D)
- 7 carriage E containing the motor
- 8 rear controller
- 9 bogie
- 10 carrying bogie
- 11 wheel guard
- 12 bumper (*Am.* fender)
- 13 six-axle articulated railcar ('Mannheim' type) for tram (*Am.* streetcar, trolley) and urban rail services
- 14 entrance and exit door, a double folding door
- 15 step
- 16 ticket-cancelling machine
- 17 single seat
- 18 standing room portion
- 19 double seat
- 20 route (number) and destination sign
- 21 route sign (number sign)
- 22 indicator (indicator light)
- 23 pantograph (current collector)
- 24 carbon or aluminium (*Am.* aluminum) alloy trolley shoes
- 25 driver's position
- 26 microphone
- 27 controller
- 28 radio equipment (radio communication set)
- 29 dashboard
- 30 dashboard lighting
- 31 speedometer
- 32 buttons controlling doors, windscreen wipers, internal and external lighting
- 33 ticket counter with change machine
- 34 radio antenna
- 35 tram stop (*Am.* streetcar stop, trolley stop)
- 36 tram stop sign (*Am.* streetcar stop sign, trolley stop sign)
- 37 electric change points
- 38 points signal (switch signal)
- 39 points change indicator
- 40 trolley wire contact point
- 41 trolley wire (overhead contact wire)
- 42 overhead cross wire
- 43 electric (*also*: electrohydraulic, electromechanical) points mechanism

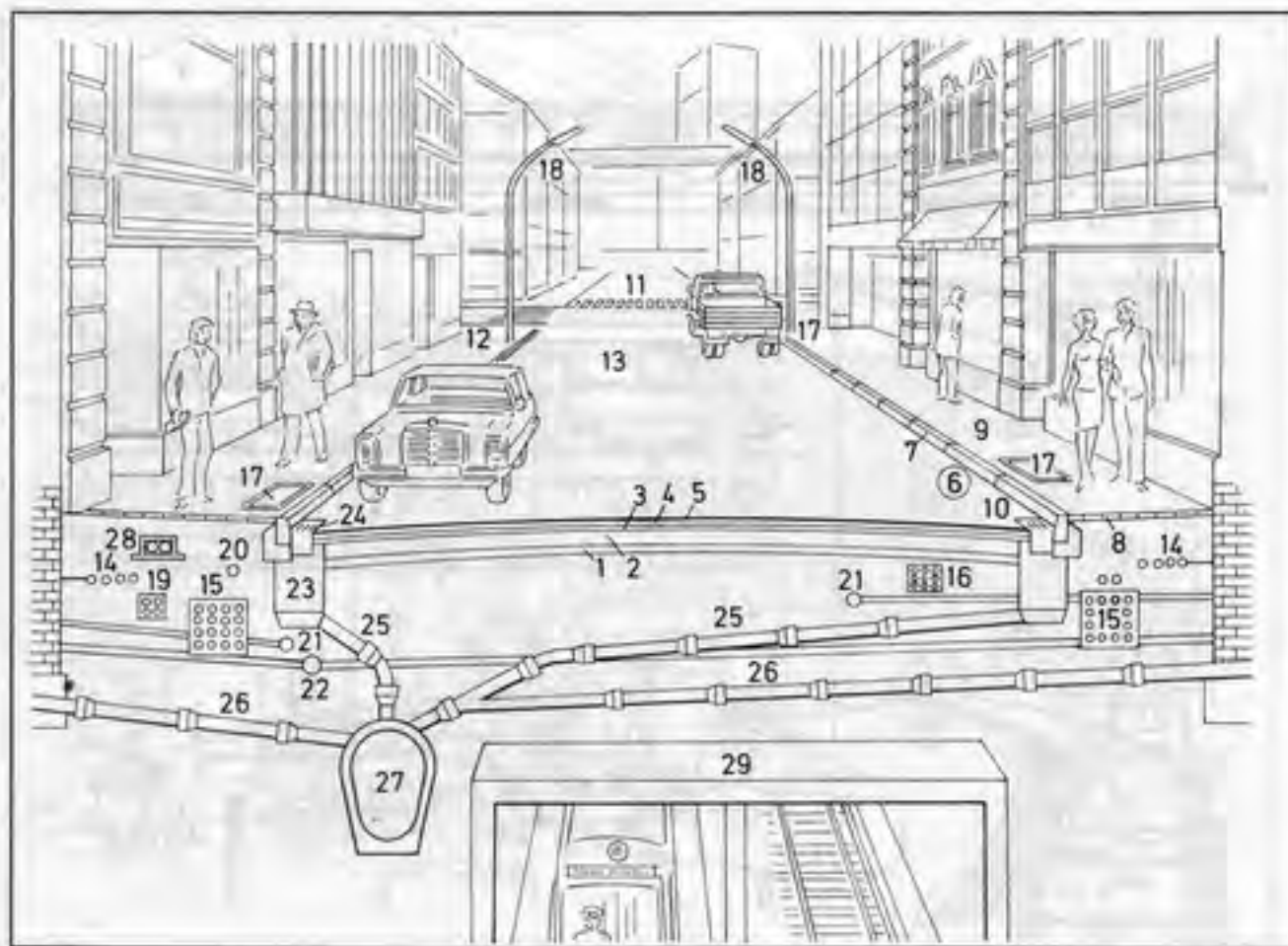

1-5 road layers

- 1 anti-frost layer
- 2 bituminous sub-base course
- 3 base course
- 4 binder course
- 5 bituminous surface
- 6 kerb (curb)
- 7 kerbstone (curbstone)
- 8 paving (pavement)
- 9 pavement (*Am.* sidewalk, walkway)
- 10 gutter
- 11 pedestrian crossing (zebra crossing, *Am.* crosswalk)
- 12 street corner
- 13 street
- 14 electricity cables
- 15 telephone cables
- 16 telephone cable pipeline
- 17 cable manhole with cover (with manhole cover)
- 18 lamp post with lamp
- 19 electricity cables for technical installations
- 20 subscribers' (*Am.* customers') telephone lines

- 21 gas main
- 22 water main
- 23 drain
- 24 drain cover
- 25 drain pipe
- 26 waste pipe
- 27 combined sewer
- 28 district heating main
- 29 underground tunnel

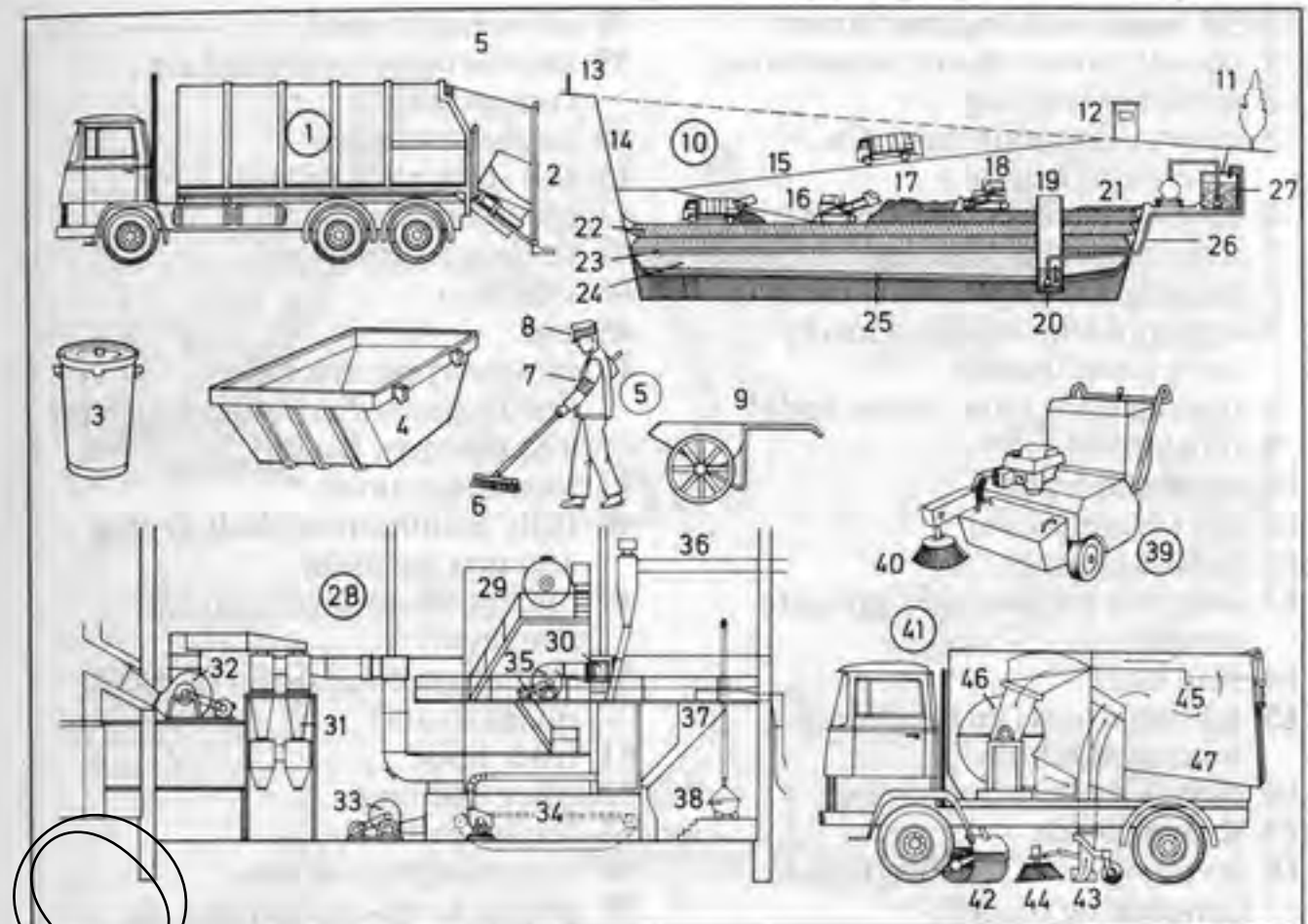

- 1 refuse collection vehicle (*Am.* garbage truck)
- 2 dustbin-tipping device (*Am.* garbage can dumping device), a dust-free emptying system
- 3 dustbin (*Am.* garbage can, trash can)
- 4 refuse container (*Am.* garbage container)
- 5 road sweeper (*Am.* street sweeper)
- 6 broom
- 7 fluorescent armband
- 8 cap with fluorescent band
- 9 road sweeper's (*Am.* street sweeper's) barrow
- 10 controlled tip (*Am.* sanitary landfill, sanitary fill)
- 11 screen
- 12 weigh office
- 13 fence
- 14 embankment
- 15 access ramp
- 16 bulldozer
- 17 refuse (*Am.* garbage)
- 18 bulldozer for dumping and compacting
- 19 pump shaft
- 20 waste water pump
- 21 porous cover
- 22 compacted and decomposed refuse
- 23 gravel filter layer
- 24 morainic filter layer
- 25 drainage layer
- 26 drain pipe
- 27 water tank
- 28 refuse (*Am.* garbage) incineration unit
- 29 furnace
- 30 oil-firing system
- 31 separation plant
- 32 extraction fan
- 33 low-pressure fan for the grate
- 34 continuous feed grate
- 35 fan for the oil-firing system
- 36 conveyor for separately incinerated material
- 37 coal feed conveyor
- 38 truck for carrying fuller's earth
- 39 mechanical sweeper
- 40 circular broom
- 41 road-sweeping lorry (street-cleaning lorry, street cleaner)
- 42 cylinder broom
- 43 suction port
- 44 feeder broom
- 45 air flow
- 46 fan
- 47 dust collector

1-54 road-building machinery

- 1 shovel (power shovel, excavator)
- 2 machine housing
- 3 caterpillar mounting (*Am.* caterpillar tractor)
- 4 digging bucket arm (dipper stick)
- 5 digging bucket (bucket)
- 6 digging bucket (bucket) teeth
- 7 tipper (dump truck), a heavy lorry (*Am.* truck)
- 8 tipping body (*Am.* dump body)
- 9 reinforcing rib
- 10 extended front
- 11 cab (driver's cab)
- 12 bulk material
- 13 concrete scraper, an aggregate scraper
- 14 skip hoist
- 15 mixing drum (mixer drum), a mixing machine
- 16 caterpillar hauling scraper
- 17 scraper blade
- 18 levelling (*Am.* leveling) blade (smoothing blade)
- 19 grader (motor grader)
- 20 scarifier (ripper, road ripper, rooter)
- 21 grader levelling (*Am.* leveling) blade (grader ploughshare, *Am.* plowshare)
- 22 blade-slewing gear (slew turntable)
- 23 light railway (narrow-gauge, *Am.* narrow-gage, railway)
- 24 light railway (narrow-gauge, *Am.* narrow-gage) diesel locomotive
- 25 trailer wagon (wagon truck, skip)
- 26 tamper (rammer); *heavier*: frog
- 27 guide rods
- 28 bulldozer
- 29 bulldozer blade
- 30 pushing frame
- 31 road-metal spreading machine (macadam spreader, stone spreader)
- 32 tamping beam
- 33 sole-plate
- 34 side stop
- 35 side of storage bin
- 36 three-wheeled roller, a road roller
- 37 roller

- 38 all-weather roof
- 39 mobile diesel-powered air compressor
- 40 oxygen cylinder
- 41 self-propelled gritter
- 42 spreading flap
- 43 surface finisher
- 44 side stop
- 45 bin
- 46 tar-spraying machine (bituminous distributor) with tar and bitumen heater
- 47 tar storage tank
- 48 fully automatic asphalt drying and mixing plant
- 49 bucket elevator (elevating conveyor)
- 50 asphalt-mixing drum (asphalt mixer drum)
- 51 filler hoist
- 52 filler opening
- 53 binder injector
- 54 mixed asphalt outlet
- 55 typical cross-section of a bituminous road
- 56 grass verge
- 57 crossfall
- 58 asphalt surface (bituminous layer, bituminous coating)
- 59 base (base course)
- 60 gravel sub-base course (hardcore sub-base course, Telford base), an anti-frost layer
- 61 sub-drainage
- 62 perforated cement pipe
- 63 drainage ditch
- 64 soil covering

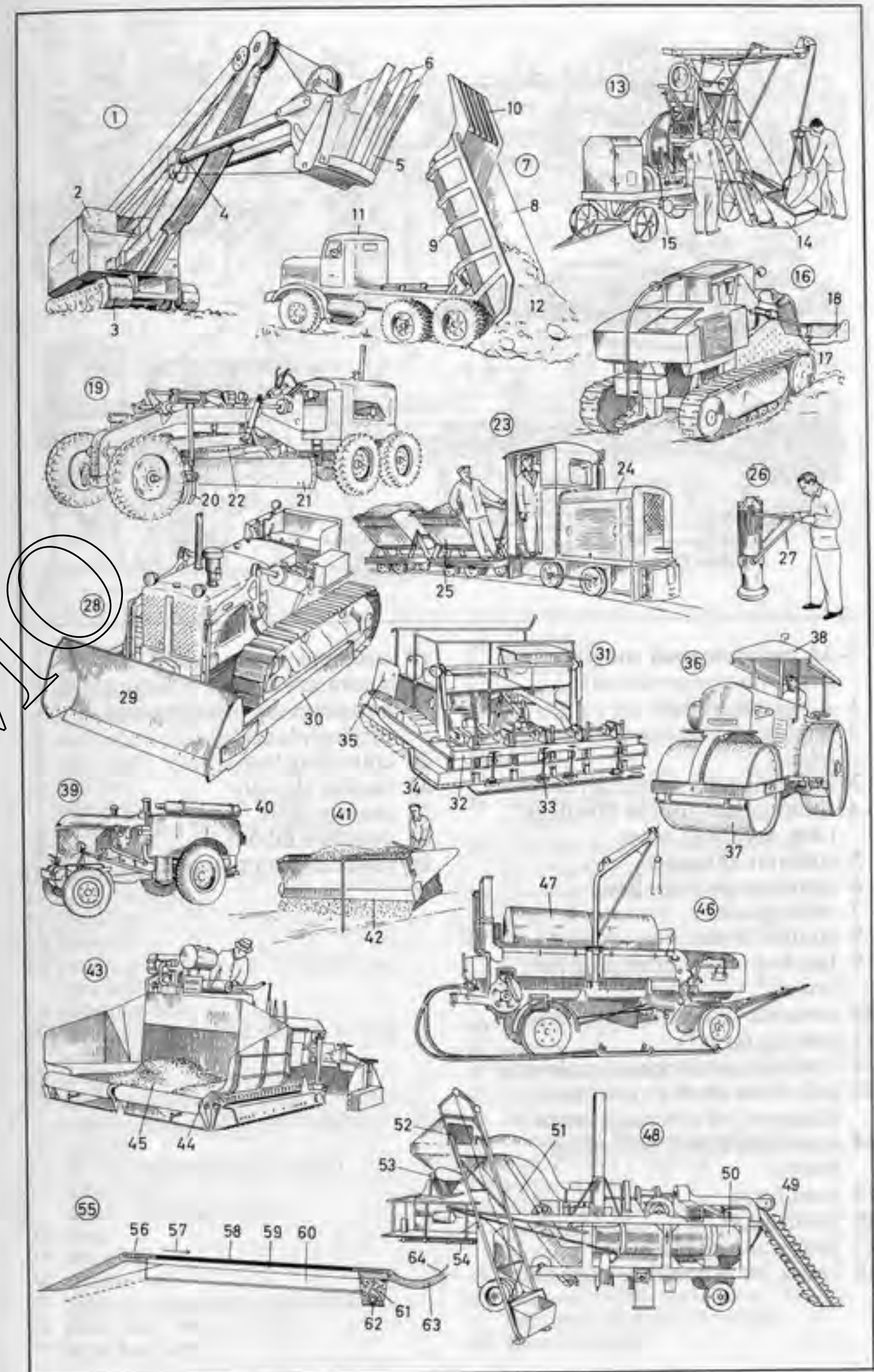

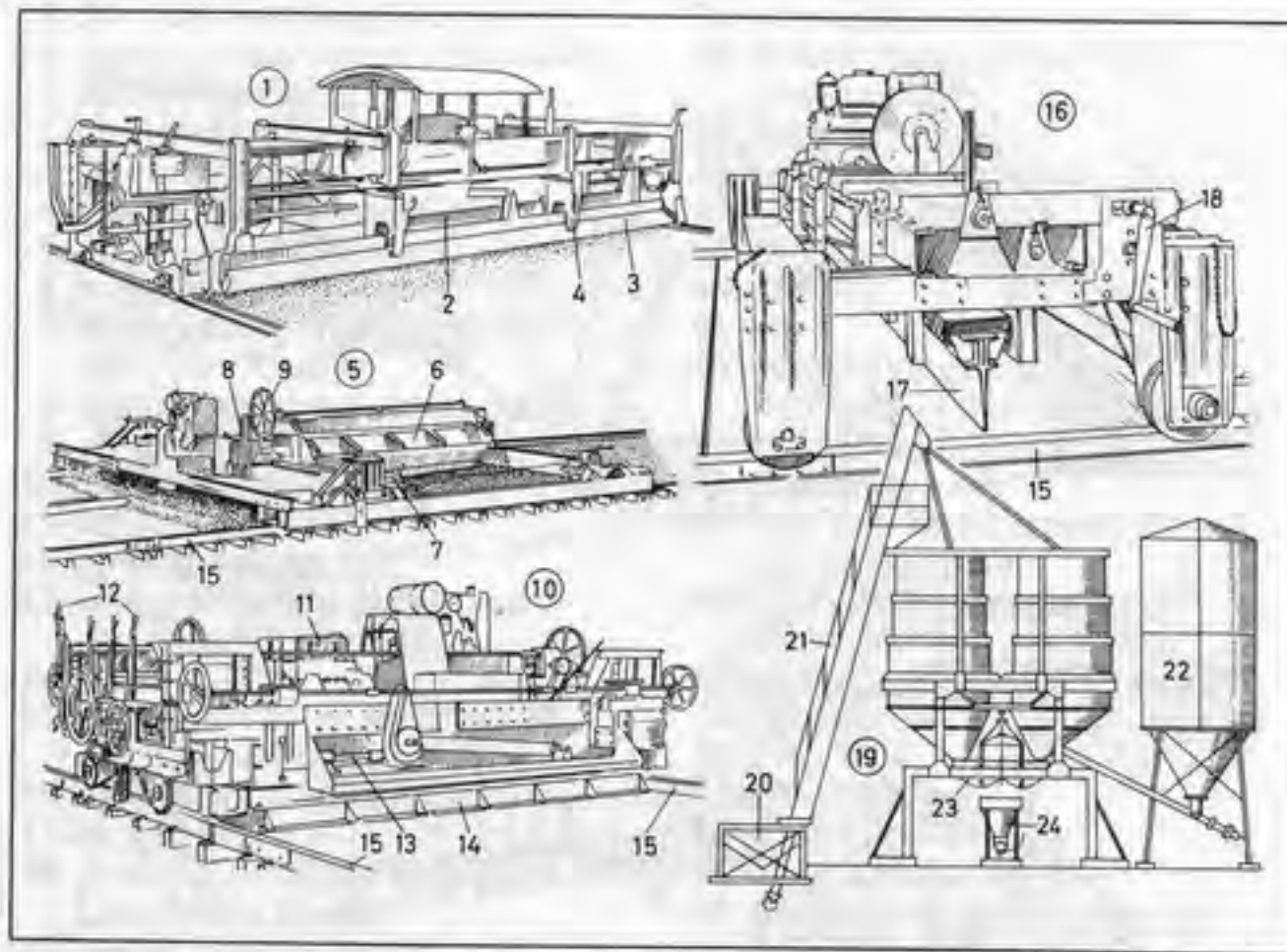

1-24 concrete road construction
(highway construction)

19 concrete-mixing plant, a stationary central mixing plant, an automatic batching and mixing plant

- 1 subgrade grader
- 2 tamping beam (consolidating beam)
- 3 levelling (*Am.* leveling) beam
- 4 roller guides for the levelling (*Am.* leveling) beam
- 5 concrete spreader
- 6 concrete spreader box
- 7 cable guides
- 8 control levers
- 9 handwheel for emptying the boxes
- 10 concrete-vibrating compactor
- 11 gearing (gears)
- 12 control levers (operating levers)
- 13 axle drive shaft to vibrators (tamper) of vibrating beam
- 14 screeding board (screeding beam)
- 15 road form
- 16 joint cutter
- 17 joint-cutting blade
- 18 crank for propelling machine

- 19 concrete-mixing plant, a stationary central mixing plant, an automatic batching and mixing plant
- 20 collecting bin
- 21 bucket elevator
- 22 cement store
- 23 concrete mixer
- 24 concrete pump hopper

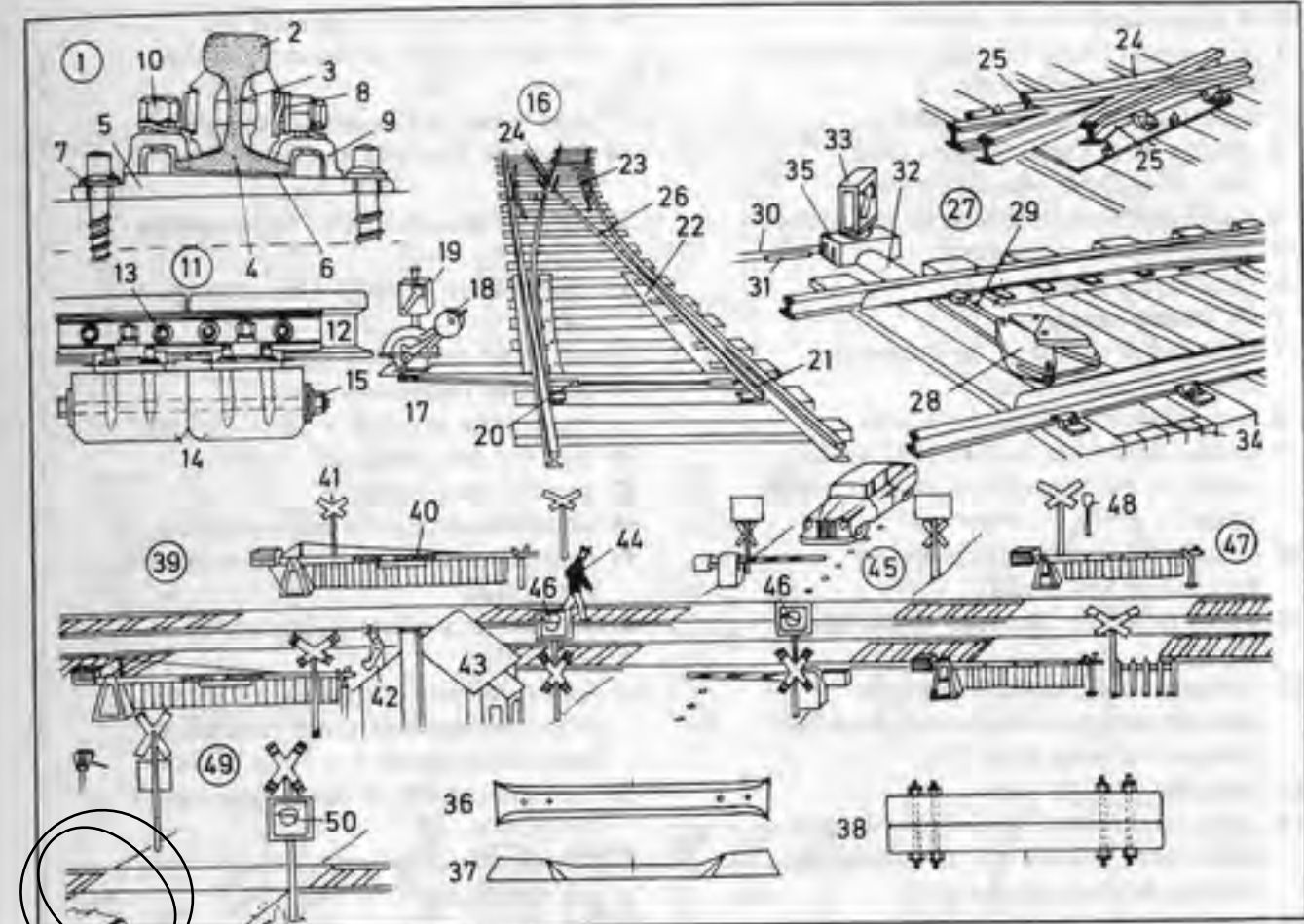

- 1-38 line (track)
- 1 rail
- 2 rail head
- 3 web (rail web)
- 4 rail foot (rail bottom)
- 5 sole-plate (base plate)
- 6 cushion
- 7 coach screw (coach bolt)
- 8 lock washers (spring washers)
- 9 rail clip (clip)
- 10 T-head bolt
- 11 rail joint (joint)
- 12 fishplate
- 13 fishbolt
- 14 coupled sleeper (*Am.* coupled tie, coupled crosstie)
- 15 coupling bolt
- 16 manually-operated points (switch)
- 17 switch stand
- 18 weight
- 19 points signal (switch signal, points signal lamp, switch signal lamp)
- 20 pull rod
- 21 switch blade (switch tongue)
- 22 slide chair
- 23 check rail (guard rail)
- 24 frog
- 25 wing rail
- 26 closure rail
- 27 remote-controlled points (switch)
- 28 point lock (switch lock)
- 29 stretcher bar

- 30 point wire
- 31 turnbuckle
- 32 channel
- 33 electrically illuminated points signal (switch signal)
- 34 trough
- 35 points motor with protective casing
- 36 steel sleeper (*Am.* steel tie, steel crosstie)
- 37 concrete sleeper (*Am.* concrete tie, concrete crosstie)
- 38 coupled sleeper (*Am.* coupled tie, coupled crosstie)
- 39-50 level crossings (*Am.* grade crossings)
- 39 protected level crossing (*Am.* protected grade crossing)
- 40 barrier (gate)
- 41 warning cross (*Am.* crossbuck)
- 42 crossing keeper (*Am.* gateman)
- 43 crossing keeper's box (*Am.* gateman's box)
- 44 linesman (*Am.* trackwalker)
- 45 half-barrier crossing
- 46 warning light
- 47 intercom-controlled crossing; *sim.*: telephone-controlled crossing
- 48 intercom system
- 49 unprotected level crossing (*Am.* unprotected grade crossing)
- 50 warning light

DEMO

203 Railway Line (Am. Railroad Track) II (Signalling Equipment)

- 1-6 stop signals (main signals)
- 1 stop signal (main signal), a semaphore signal in 'stop' position
- 2 signal arm (semaphore arm)
- 3 electric stop signal (colour light, Am. color light, signal) at 'stop'
- 4 signal position: 'proceed at low speed'
- 5 signal position: 'proceed'
- 6 substitute signal
- 7-24 distant signals
- 7 semaphore signal at 'be prepared to stop at next signal'
- 8 supplementary semaphore arm
- 9 colour light (Am. color light) distant signal at 'be prepared to stop at next signal'
- 10 signal position: 'be prepared to proceed at low speed'
- 11 signal position: 'proceed main signal ahead'
- 12 semaphore signal with indicator plate showing a reduction in braking distance of more than 5%
- 13 triangle (triangle sign)
- 14 colour light (Am. color light) distant signal with indicator light for showing reduced braking distance
- 15 supplementary white light
- 16 distant signal indicating 'be prepared to stop at next signal' (yellow light)
- 17 second distant signal (distant signal with supplementary light, without indicator plate)
- 18 distant signal with speed indicator
- 19 distant speed indicator
- 20 distant signal with route indicator
- 21 route indicator
- 22 distant signal without supplementary arm in position: 'be prepared to stop at next signal'
- 23 distant signal without supplementary arm in 'be prepared to proceed' position
- 24 distant signal identification plate
- 25-44 supplementary signals
- 25 stop board for indicating the stopping point at a control point
- 26-29 approach signs
- 26 approach sign 100 m from distant signal
- 27 approach sign 175 m from distant signal
- 28 approach sign 250 m from distant signal
- 29 approach sign at a distance of 5% less than the braking distance on the section
- 30 chequered sign indicating stop signals (main signals) not positioned immediately to the right of or over the line (track)

- 31-32 stop boards to indicate the stopping point of the front of the train
- 33 stop board (be prepared to stop)
- 34-35 snow plough (Am. snowplow) signs
- 34 'raise snow-plough (Am. snowplow)' sign
- 35 'lower snow-plough (Am. snowplow)' sign
- 36-44 speed restriction signs
- 36-38 speed restriction sign [maximum speed $3 \times 10 = 30$ kph]
- 36 sign for day running
- 37 speed code number
- 38 illuminated sign for night running
- 39 commencement of temporary speed restriction
- 40 termination of temporary speed restriction
- 41 speed restriction sign for a section with a permanent speed restriction [maximum speed $5 \times 10 = 50$ kph]
- 42 commencement of permanent speed restriction
- 43 speed restriction warning sign [only on main lines]
- 44 speed restriction sign [only on main lines]
- 45-52 points signals (switch signals)
- 45-48 single points (single switches)
- 45 route straight ahead (main line)
- 46 [right] branch
- 47 [left] branch
- 48 branch [seen from the frog]
- 49-52 double crossover
- 49 route straight ahead from left to right
- 50 route straight ahead from right to left
- 51 turnout to the left from the left
- 52 turnout to the right from the right
- 53 manually-operated signal box (Am. signal tower, switch tower)
- 54 lever mechanism
- 55 points lever (switch lever) [blue], a lock lever
- 56 signal lever [red]
- 57 catch
- 58 route lever
- 59 block instruments
- 60 block section panel
- 61 electrically-operated signal box (Am. signal tower, switch tower)
- 62 points (switch) and signal knobs
- 63 lock indicator panel
- 64 track and signal indicator
- 65 track diagram control layout
- 66 track diagram control panel (domino panel)
- 67 push buttons
- 68 routes
- 69 intercom system

Railway Line (Am. Railroad Track) II 203 (Signalling Equipment)

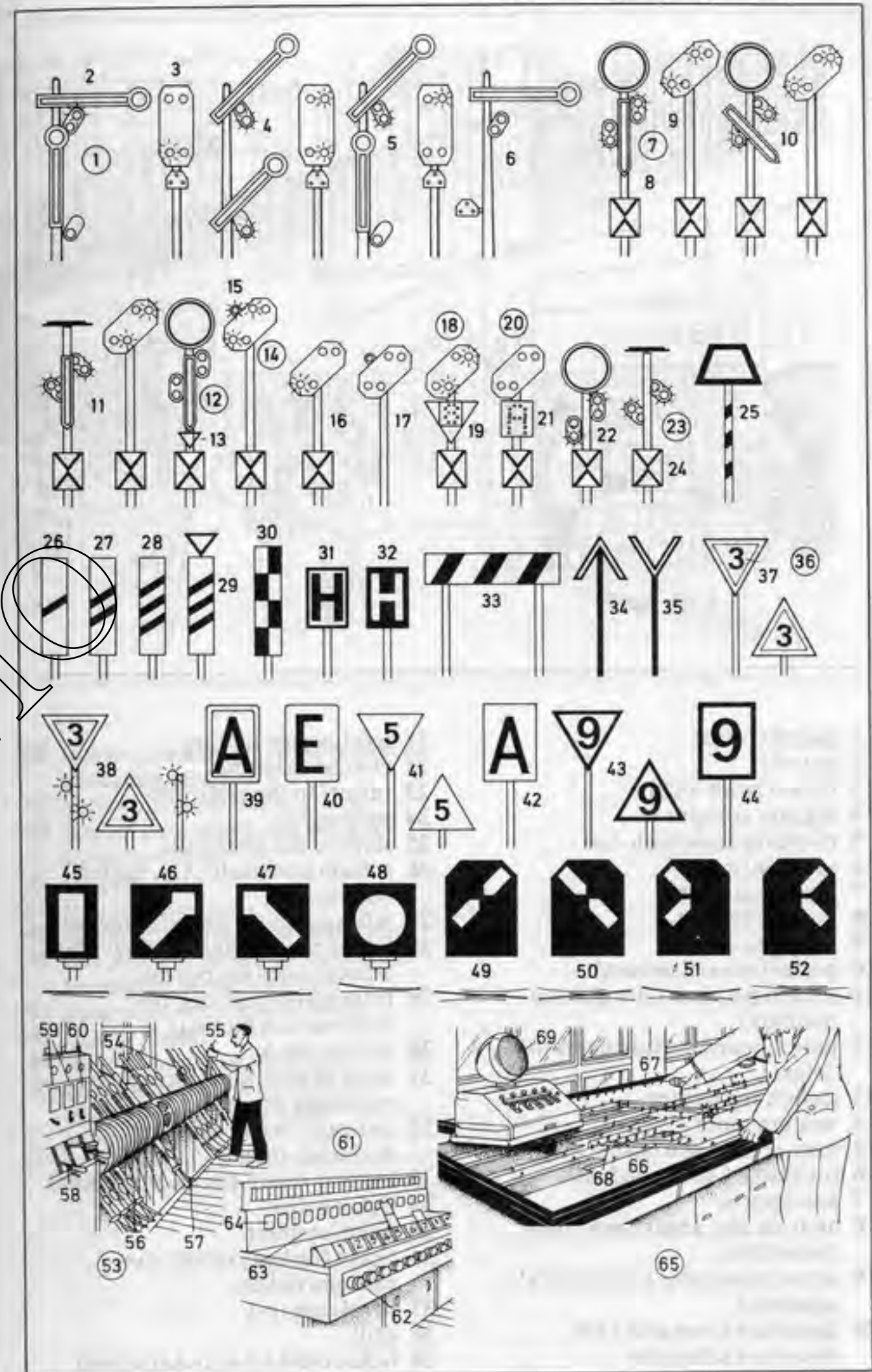



- 1 parcels office
- 2 parcels
- 3 basket [with lock]
- 4 luggage counter
- 5 platform scale with dial
- 6 suitcase (case)
- 7 luggage sticker
- 8 luggage receipt
- 9 luggage clerk
- 10 poster (advertisement)
- 11 station post box (*Am.* station mailbox)
- 12 notice board indicating train delays
- 13 station restaurant
- 14 waiting room
- 15 map of the town (street map)
- 16 timetable (*Am.* schedule)
- 17 hotel porter
- 18 arrivals and departures board (timetable)
- 19 arrival timetable (*Am.* arrival schedule)
- 20 departure timetable (*Am.* departure schedule)

- 21 left luggage lockers
- 22 change machine
- 23 tunnel to the platforms
- 24 passengers
- 25 steps to the platforms
- 26 station bookstall (*Am.* station bookstand)
- 27 left luggage office (left luggage)
- 28 travel centre (*Am.* center); also: accommodation bureau
- 29 information office (*Am.* information bureau)
- 30 station clock
- 31 bank branch with foreign exchange counter
- 32 indicator board showing exchange rates
- 33 railway map (*Am.* railroad map)
- 34 ticket office
- 35 ticket counter
- 36 ticket (railway ticket, *Am.* railroad ticket)
- 37 revolving tray
- 38 grill
- 39 ticket clerk (*Am.* ticket agent)



- 40 ticket-printing machine (ticket-stamping machine)
- 41 hand-operated ticket printer
- 42 pocket timetable (*Am.* pocket train schedule)
- 43 luggage rest
- 44 first aid station
- 45 Travellers' (*Am.* Travelers') Aid
- 46 telephone box (telephone booth, telephone kiosk, call box)
- 47 cigarettes and tobacco kiosk
- 48 flower stand
- 49 railway information clerk
- 50 official timetable (official railway guide, *Am.* train schedule)

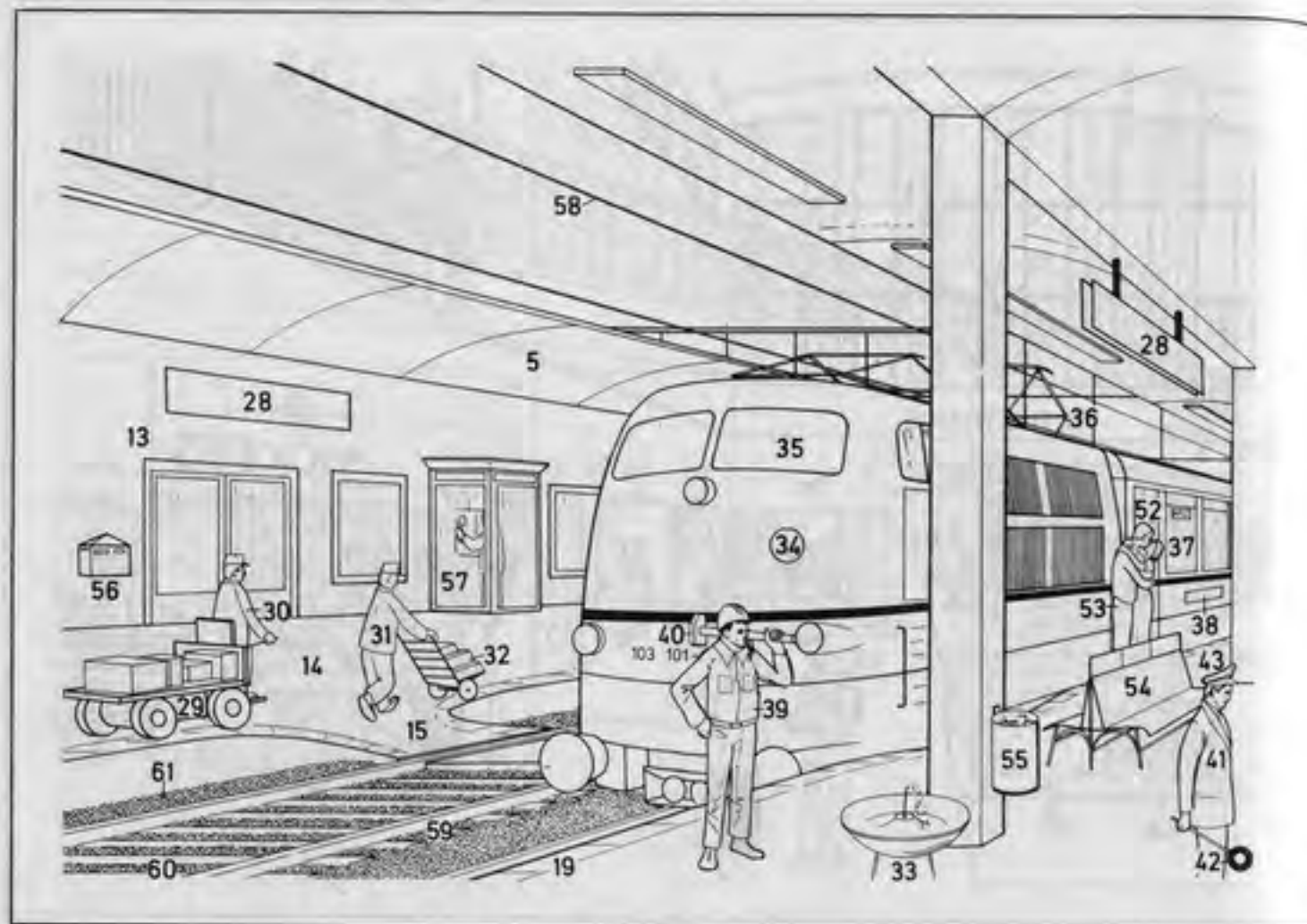

- 1 platform
- 2 steps to the platform
- 3 bridge to the platforms
- 4 platform number
- 5 platform roofing
- 6 passengers
- 7-12 luggage
- 7 suitcase (case)
- 8 luggage label
- 9 hotel sticker
- 10 travelling (*Am.* traveling) bag
- 11 hat box
- 12 umbrella, a walking-stick umbrella
- 13 main building; *also*: offices
- 14 platform
- 15 crossing
- 16 news trolley
- 17 news vendor (*Am.* news dealer)
- 18 reading matter for the journey
- 19 edge of the platform
- 20 railway policeman (*Am.* railroad policeman)
- 21 destination board
- 22 destination indicator
- 23 departure time indicator
- 24 delay indicator
- 25 suburban train, a railcar
- 26 special compartment
- 27 platform loudspeaker
- 28 station sign
- 29 electric trolley (electric truck)
- 30 loading foreman
- 31 porter (*Am.* redcap)
- 32 barrow
- 33 drinking fountain
- 34 electric Trans-Europe Express; *also*: Intercity train
- 35 electric locomotive, an express locomotive
- 36 collector bow (sliding bow)
- 37 secretarial compartment
- 38 destination board
- 39 wheel tapper
- 40 wheel-tapping hammer
- 41 station foreman
- 42 signal
- 43 red cap

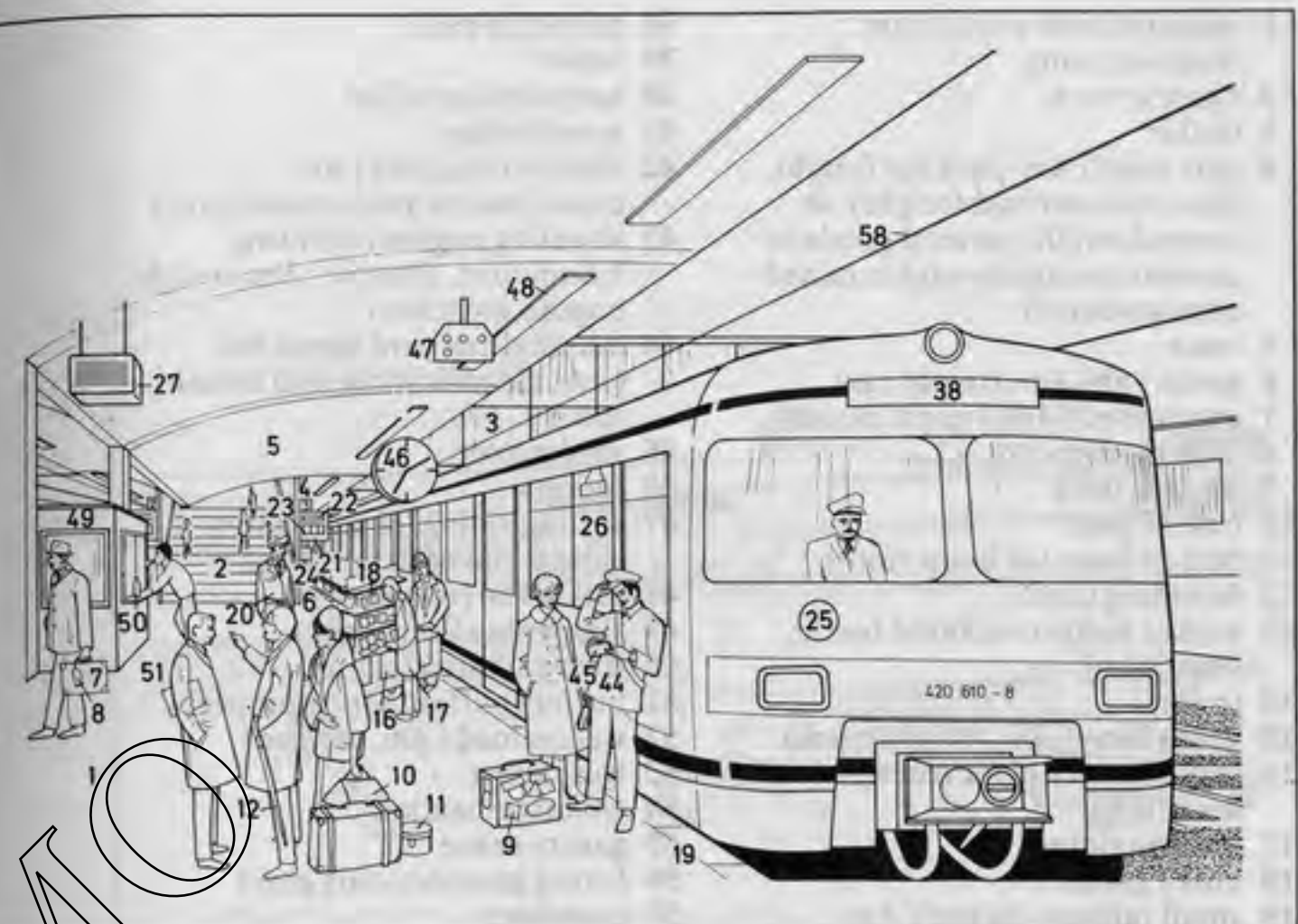

- 44 inspector
- 45 pocket timetable (*Am.* pocket train schedule)
- 46 platform clock
- 47 starting signal
- 48 platform lighting
- 49 refreshment kiosk
- 50 beer bottle
- 51 newspaper
- 52 parting kiss
- 53 embrace
- 54 platform seat
- 55 litter bin (*Am.* litter basket)
- 56 platform post box (*Am.* platform mailbox)
- 57 platform telephone
- 58 trolley wire (overhead contact wire)
- 59-61 track
- 59 rail
- 60 sleeper (*Am.* tie, crosstie)
- 61 ballast (bed)

- | | |
|---|---|
| 1 ramp (vehicle ramp); <i>sim.</i> :
livestock ramp | 38 rail (slide rail) |
| 2 electric truck | 39 roller |
| 3 trailer | 40 weighbridge office |
| 4 part loads (<i>Am.</i> package freight,
less-than-carload freight); <i>in</i>
<i>general traffic</i> : general goods in
general consignments (in mixed
consignments) | 41 weighbridge |
| 5 crate | 42 marshalling yard (<i>Am.</i>
classification yard, switch yard) |
| 6 goods van (<i>Am.</i> freight car) | 43 shunting engine (shunting
locomotive, shunter, <i>Am.</i> switch
engine, switcher) |
| 7 goods shed (<i>Am.</i> freight house) | 44 marshalling yard signal box
(<i>Am.</i> classification yard switch
tower) |
| 8 loading strip | 45 yardmaster |
| 9 loading dock | 46 hump |
| 10 bale of peat | 47 sorting siding (classification
siding, classification track) |
| 11 bale of linen (of linen cloth) | 48 rail brake (retarder) |
| 12 fastening (cord) | 49 slipper brake (slipper) |
| 13 wicker bottle (wickered bottle,
demijohn) | 50 storage siding (siding) |
| 14 trolley | 51 buffer (buffers, <i>Am.</i> bumper) |
| 15 goods lorry (<i>Am.</i> freight truck) | 52 wagon load (<i>Am.</i> carload) |
| 16 forklift truck (fork truck,
forklift) | 53 warehouse |
| 17 loading siding | 54 container station |
| 18 bulky goods | 55 gantry crane |
| 19 small railway-owned (<i>Am.</i>
railroad-owned) container | 56 lifting gear (hoisting gear) |
| 20 showman's caravan (<i>sim.</i> : circus
caravan) | 57 container |
| 21 flat wagon (<i>Am.</i> flat freight car) | 58 container wagon (<i>Am.</i> container
car) |
| 22 loading gauge (<i>Am.</i> gage) | 59 semi-trailer |
| 23 bale of straw | |
| 24 flat wagon (<i>Am.</i> flatcar) with
side stakes | |
| 25 fleet of lorries (<i>Am.</i> trucks) | |
| 26-39 goods shed (<i>Am.</i> freight
house) | |
| 26 goods office (forwarding office,
<i>Am.</i> freight office) | |
| 27 part-load goods (<i>Am.</i> package
freight) | |
| 28 forwarding agent (<i>Am.</i> freight
agent, shipper) | |
| 29 loading foreman | |
| 30 consignment note (waybill) | |
| 31 weighing machine | |
| 32 pallet | |
| 33 porter | |
| 34 electric cart (electric truck) | |
| 35 trailer | |
| 36 loading supervisor | |
| 37 goods shed door (<i>Am.</i> freight
house door) | |

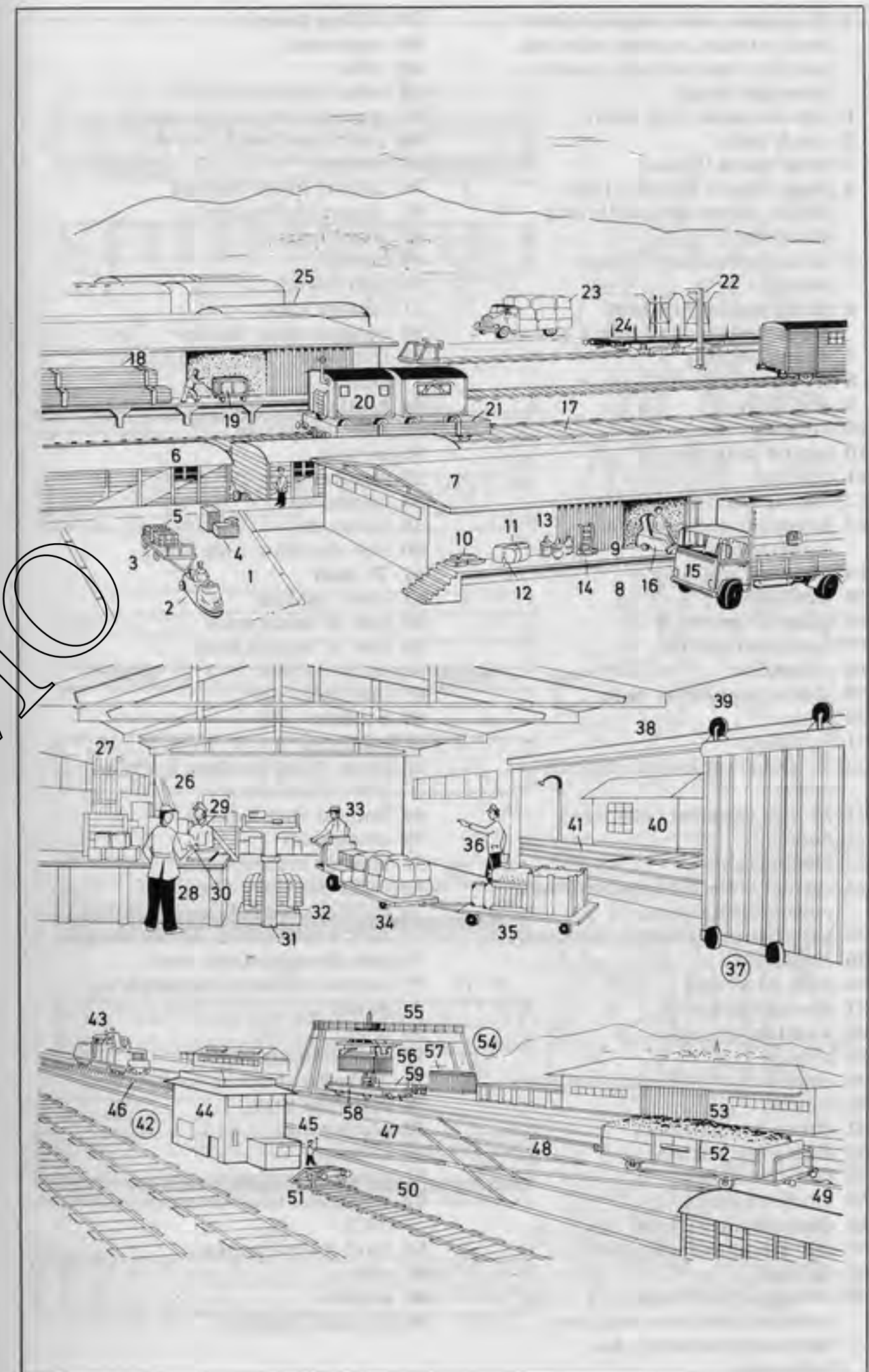

- 1-21 express train coach (express train carriage, express train car, corridor compartment coach), a passenger coach
- 1 side elevation (side view)
- 2 coach body
- 3 underframe (frame)
- 4 bogie (truck) with steel and rubber suspension and shock absorbers
- 5 battery containers (battery boxes)
- 6 steam and electric heat exchanger for the heating system
- 7 sliding window
- 8 rubber connecting seal
- 9 ventilator
- 10-21 plan
- 10 second-class section
- 11 corridor
- 12 folding seat (tip-up seat)
- 13 passenger compartment (compartment)
- 14 compartment door
- 15 washroom
- 16 toilet (lavatory, WC)
- 17 first-class section
- 18 swing door
- 19 sliding connecting door
- 20 door
- 21 vestibule
- 22-32 dining car (restaurant car, diner)
- 22-25 side elevation (side view)
- 22 door
- 23 loading door
- 24 current collector for supplying power during stops
- 25 battery boxes (battery containers)
- 26-32 plan
- 26 staff washroom
- 27 storage cupboard
- 28 washing-up area
- 29 kitchen
- 30 electric oven with eight hotplates
- 31 counter
- 32 dining compartment
- 33 dining car kitchen
- 34 chef (head cook)
- 35 kitchen cabinet
- 36 sleeping car (sleeper)
- 37 side elevation (side view)
- 38-42 plan
- 38 two-seat twin-berth compartment (two-seat two-berth compartment, *Am. bedroom*)
- 39 folding doors
- 40 washstand
- 41 office
- 42 toilet (lavatory, WC)
- 43 express train compartment
- 44 upholstered reclining seat
- 45 armrest
- 46 ashtray in the armrest
- 47 adjustable headrest
- 48 antimacassar
- 49 mirror
- 50 coat hook
- 51 luggage rack
- 52 compartment window
- 53 fold-away table (pull-down table)
- 54 heating regulator
- 55 litter receptacle
- 56 curtain
- 57 footrest
- 58 corner seat
- 59 open car
- 60 side elevation (side view)
- 61-72 plan
- 61 open carriage
- 62 row of single seats
- 63 row of double seats
- 64 reclining seat
- 65 seat upholstery
- 66 backrest
- 67 headrest
- 68 down-filled headrest cushion with nylon cover
- 69 armrest with ashtray
- 70 cloakroom
- 71 luggage compartment
- 72 toilet (lavatory, WC)
- 73 buffet car (quick-service buffet car), a self-service restaurant car, a self-service restaurant car
- 74 side elevation (side view)
- 75 current collector for supplying power
- 76 plan
- 77 dining compartment
- 78-79 buffet (buffet compartment)
- 78 customer area
- 79 serving area
- 80 kitchen
- 81 staff compartment
- 82 staff toilet (staff lavatory, staff WC)
- 83 food compartments
- 84 plates
- 85 cutlery
- 86 till (cash register)

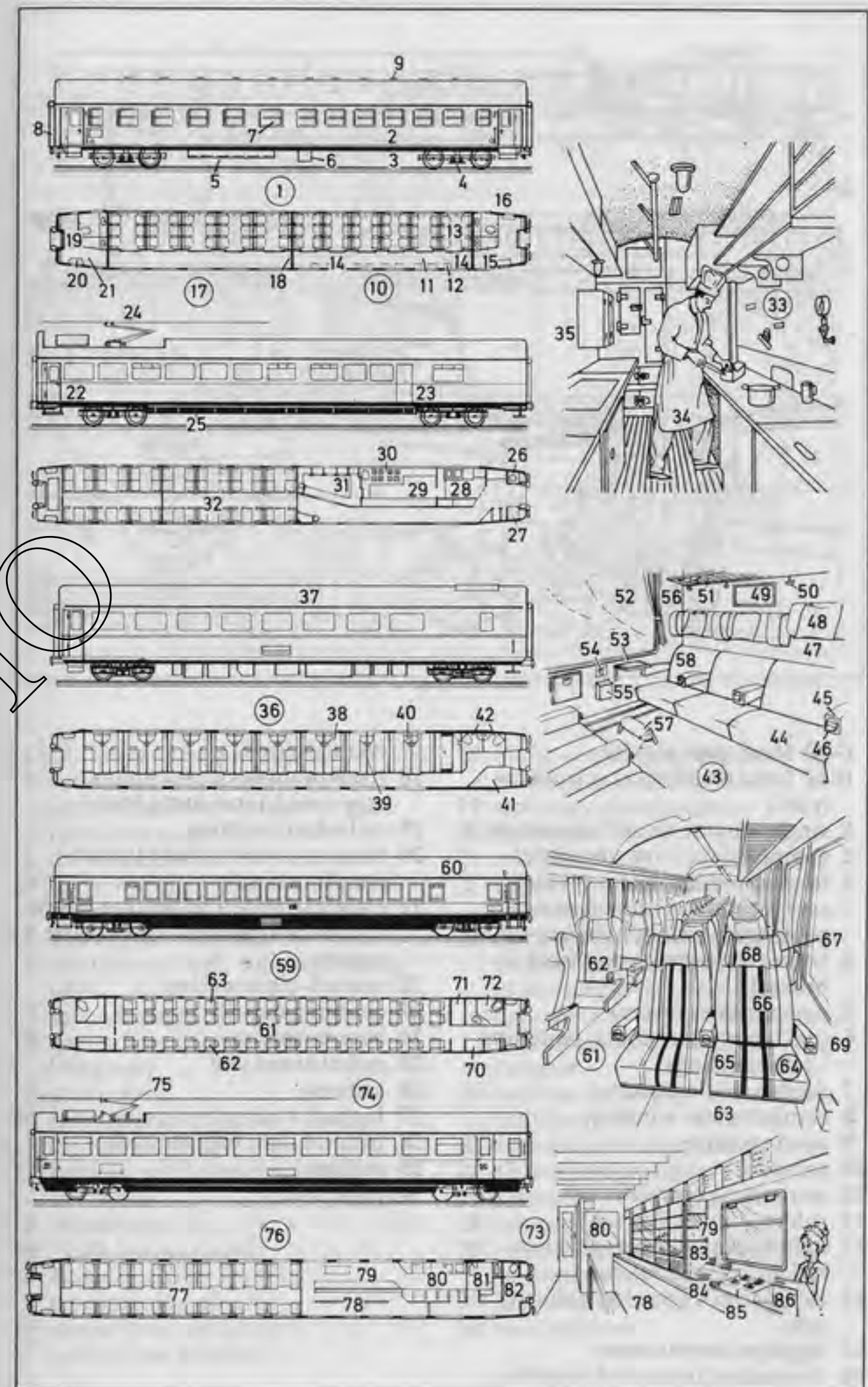

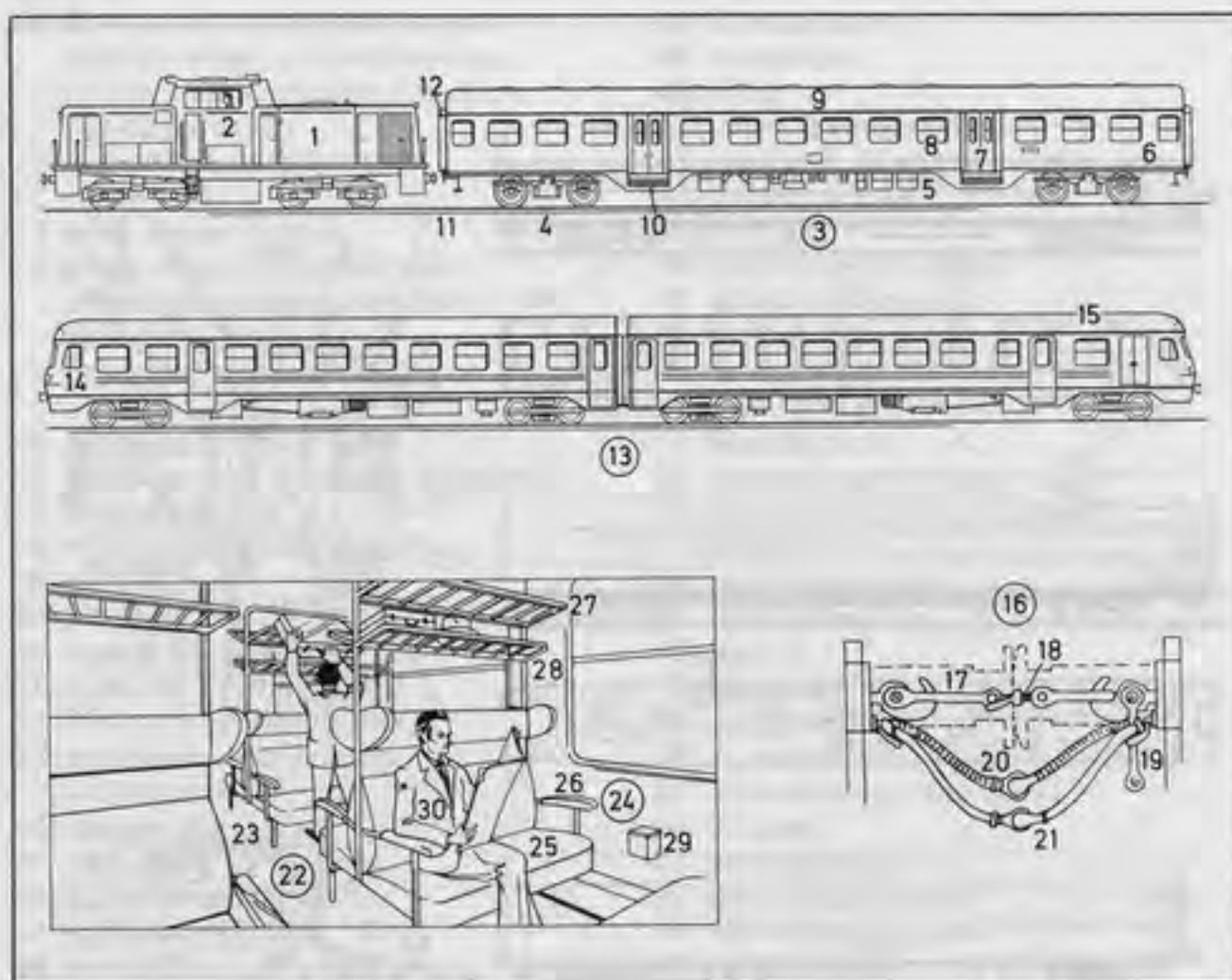
**1-30 local train service****1-12 local train (short-distance train)**

- 1 single-engine diesel locomotive
- 2 engine driver (*Am.* engineer)
- 3 four-axled coach (four-axled car) for short-distance routes, a passenger coach (passenger car)
- 4 bogie (truck) [with disc (disk) brakes]
- 5 underframe (frame)
- 6 coach body with metal panelling (*Am.* paneling)
- 7 double folding doors
- 8 compartment window
- 9 open carriage
- 10 entrance
- 11 connecting corridor
- 12 rubber connecting seal
- 13 light railcar, a short-distance railcar, a diesel railcar
- 14 cab (driver's cab, *Am.* engineer's cab)
- 15 luggage compartment
- 16 connecting hoses and coupling

- 17 coupling link
- 18 tensioning device (coupling screw with tensioning lever)
- 19 unlinked coupling
- 20 heating coupling hose (steam coupling hose)
- 21 coupling hose (connecting hose) for the compressed-air braking system
- 22 second-class section
- 23 central gangway
- 24 compartment
- 25 upholstered seat
- 26 armrest
- 27 luggage rack
- 28 hat and light luggage rack
- 29 ashtray
- 30 passenger

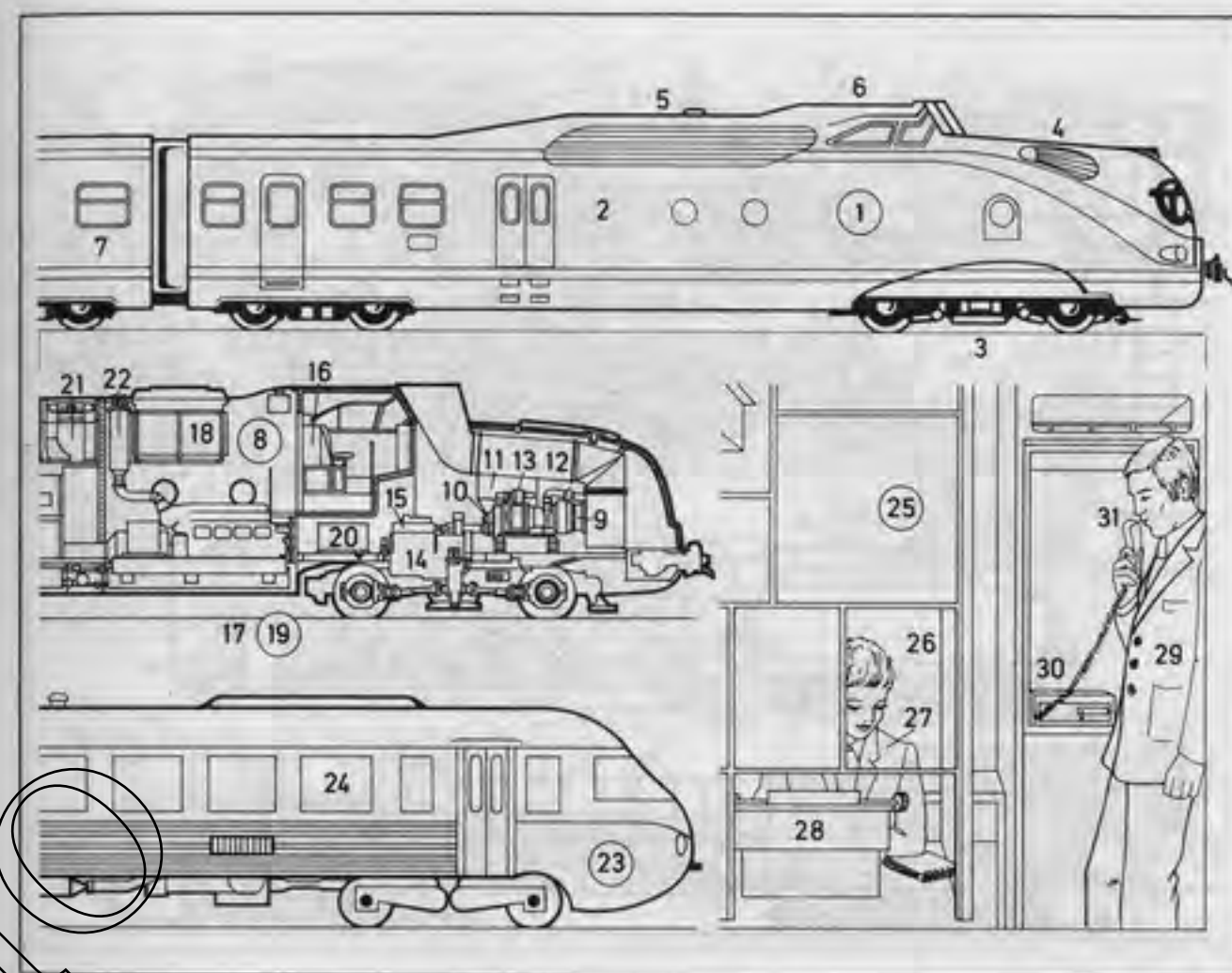
**1-22 Trans-Europe Express**

- 1 German Federal Railway trainset, a diesel trainset or gas turbine trainset
- 2 driving unit
- 3 drive wheel unit
- 4 main engine
- 5 diesel generator unit
- 6 cab (driver's cab, *Am.* engineer's cab)
- 7 second coach
- 8 gas turbine driving unit [diagram]
- 9 gas turbine
- 10 turbine transmission
- 11 air intake
- 12 exhaust with silencers (*Am.* mufflers)
- 13 dynastarter
- 14 Voith transmission
- 15 heat exchanger for the transmission oil
- 16 gas turbine controller
- 17 gas turbine fuel tank

- 18 oil-to-air cooling unit for transmission and turbine
- 19 auxiliary diesel engine
- 20 fuel tank
- 21 cooling unit
- 22 exhaust with silencers (*Am.* mufflers)
- 23 **Société Nationale des Chemins de Fer Français (SNCF)** experimental trainset with six-cylinder underfloor diesel engine and twin-shaft gas turbine
- 24 turbine unit with silencers (*Am.* mufflers)
- 25 secretarial compartment
- 26 typing compartment
- 27 secretary
- 28 typewriter
- 29 travelling (*Am.* traveling) salesman
- 30 dictating machine
- 31 microphone

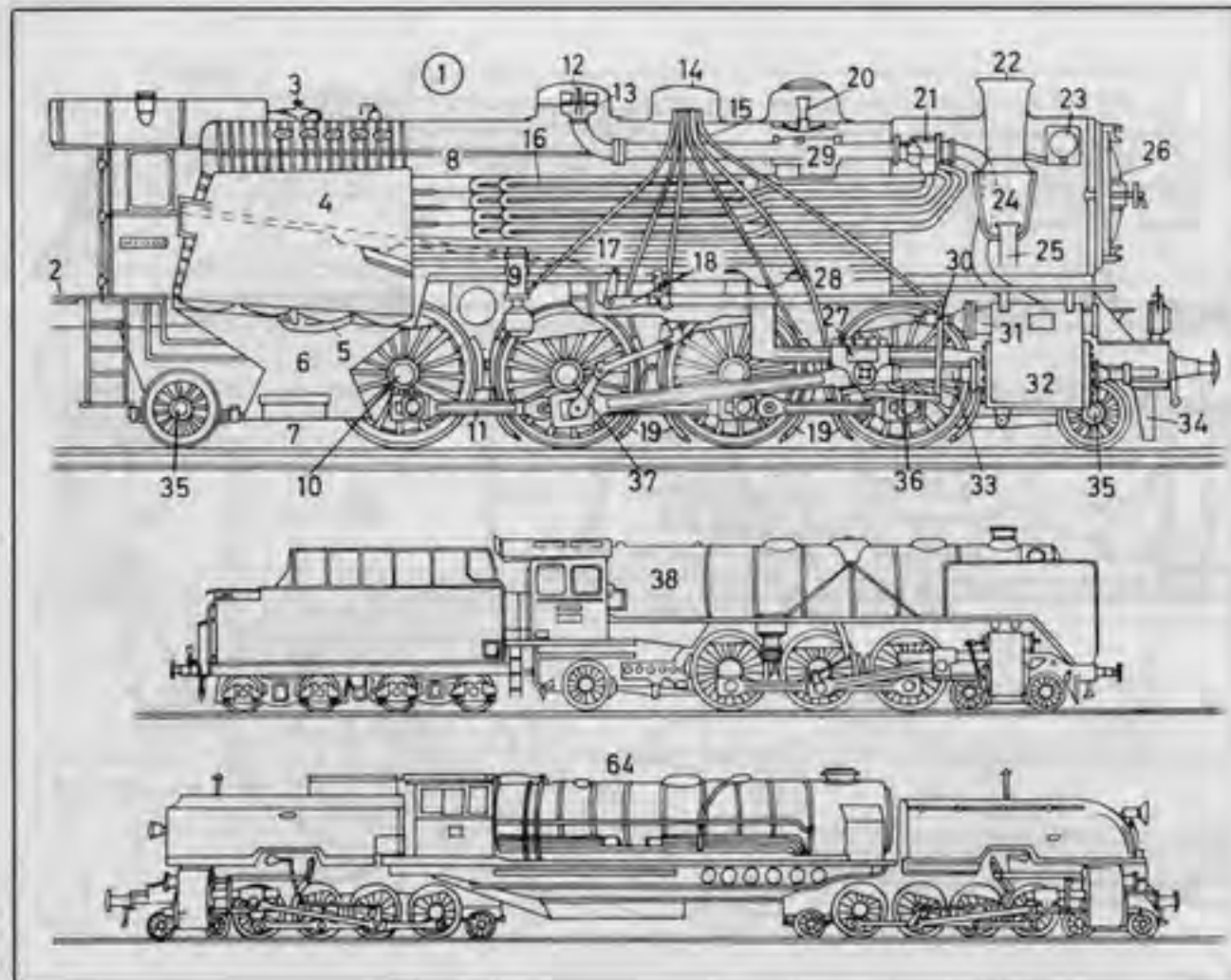

- 1-69 steam locomotives
2-37 locomotive boiler and driving gear
- 2 tender platform with coupling
 - 3 safety valve for excess boiler pressure
 - 4 firebox
 - 5 drop grate
 - 6 ashpan with damper doors
 - 7 bottom door of the ashpan
 - 8 smoke tubes (flue tubes)
 - 9 feed pump
 - 10 axle bearing
 - 11 connecting rod
 - 12 steam dome
 - 13 regulator valve (regulator main valve)
 - 14 sand dome
 - 15 sand pipes (sand tubes)
 - 16 boiler (boiler barrel)
 - 17 fire tubes or steam tubes
 - 18 reversing gear (steam reversing gear)
 - 19 sand pipes
 - 20 feed valve
 - 21 steam collector
 - 22 chimney (smokestack, smoke outlet and waste steam exhaust)
 - 23 feedwater preheater (feedwater heater, economizer)
 - 24 spark arrester
 - 25 blast pipe
 - 26 smokebox door
 - 27 cross head
 - 28 mud drum
 - 29 top feedwater tray
 - 30 combination lever
 - 31 steam chest
 - 32 cylinder
 - 33 piston rod with stuffing box (packing box)
 - 34 guard iron (rail guard, *Am.* pilot, cowcatcher)
 - 35 carrying axle (running axle, dead axle)
 - 36 coupled axle
 - 37 driving axle
 - 38 express locomotive with tender

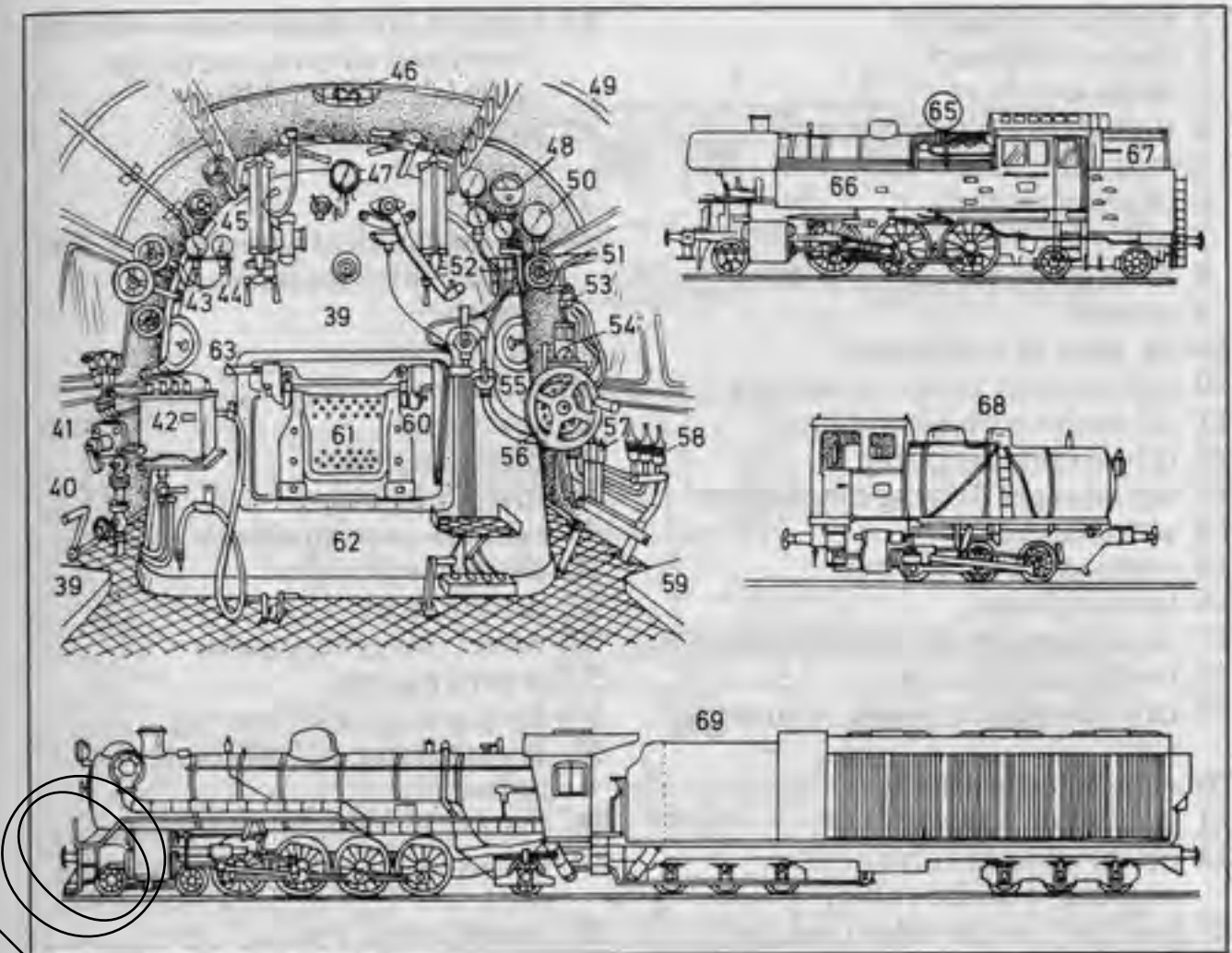

- 39-63 cab (driver's cab, *Am.* engineer's cab)
- 39 fireman's seat
 - 40 drop grate lever
 - 41 line steam injector
 - 42 automatic lubricant pump (automatic lubricator)
 - 43 preheater pressure gauge (*Am.* gage)
 - 44 carriage heating pressure gauge (*Am.* gage)
 - 45 water gauge (*Am.* gage)
 - 46 light
 - 47 boiler pressure gauge (*Am.* gage)
 - 48 distant-reading temperature gauge (*Am.* gage)
 - 49 cab (driver's cab, *Am.* engineer's cab)
 - 50 brake pressure gauge (*Am.* gage)
 - 51 whistle valve handle
 - 52 driver's timetable (*Am.* engineer's schedule)
 - 53 driver's brake valve (*Am.* engineer's brake valve)
 - 54 speed recorder (tachograph)
 - 55 sanding valve
 - 56 reversing wheel
 - 57 emergency brake valve
 - 58 release valve
 - 59 driver's seat (*Am.* engineer's seat)
 - 60 firehole shield
 - 61 firehole door
 - 62 vertical boiler
 - 63 firedoor handle handgrip
 - 64 articulated locomotive (Garratt locomotive)
 - 65 tank locomotive
 - 66 water tank
 - 67 fuel tender
 - 68 steam storage locomotive (fireless locomotive)
 - 69 condensing locomotive (locomotive with condensing tender)

- 1 electric locomotive
- 2 current collector
- 3 main switch
- 4 high-tension transformer
- 5 roof cable
- 6 traction motor
- 7 inductive train control system
- 8 main air reservoir
- 9 whistle
- 10-18 plan of locomotive
- 10 transformer with tap changer
- 11 oil cooler with blower
- 12 oil-circulating pump
- 13 tap changer driving mechanism
- 14 air compressor
- 15 traction motor blower
- 16 terminal box
- 17 capacitors for auxiliary motors
- 18 commutator cover
- 19 cab (driver's cab, *Am.* engineer's cab)
- 20 controller handwheel
- 21 dead man's handle
- 22 driver's brake valve (*Am.* engineer's brake valve)
- 23 ancillary brake valve (auxiliary brake valve)
- 24 pressure gauge (*Am.* gage)
- 25 bypass switch for the dead man's handle
- 26 tractive effort indicator
- 27 train heating voltage indicator
- 28 contact wire voltage indicator (overhead wire voltage indicator)
- 29 high-tension voltage indicator
- 30 on/off switch for the current collector
- 31 main switch
- 32 sander switch (sander control)
- 33 anti-skid brake switch
- 34 visual display for the ancillary systems
- 35 speedometer
- 36 running step indicator
- 37 clock
- 38 controls for the inductive train control system
- 39 cab heating switch
- 40 whistle lever

- 41 contact wire maintenance vehicle (overhead wire maintenance vehicle), a diesel railcar
- 42 work platform (working platform)
- 43 ladder
- 44-54 mechanical equipment of the contact wire maintenance vehicle
- 44 air compressor
- 45 blower oil pump
- 46 generator
- 47 diesel engine
- 48 injection pump
- 49 silencer (*Am.* muffler)
- 50 change-speed gear
- 51 cardan shaft
- 52 wheel flange lubricator
- 53 reversing gear
- 54 torque converter bearing
- 55 accumulator railcar (battery railcar)
- 56 battery box (battery container)
- 57 cab (driver's cab, *Am.* engineer's cab)
- 58 second-class seating arrangement
- 59 toilet (lavatory, WC)
- 60 fast electric multiple-unit train
- 61 front railcar
- 62 driving trailer car

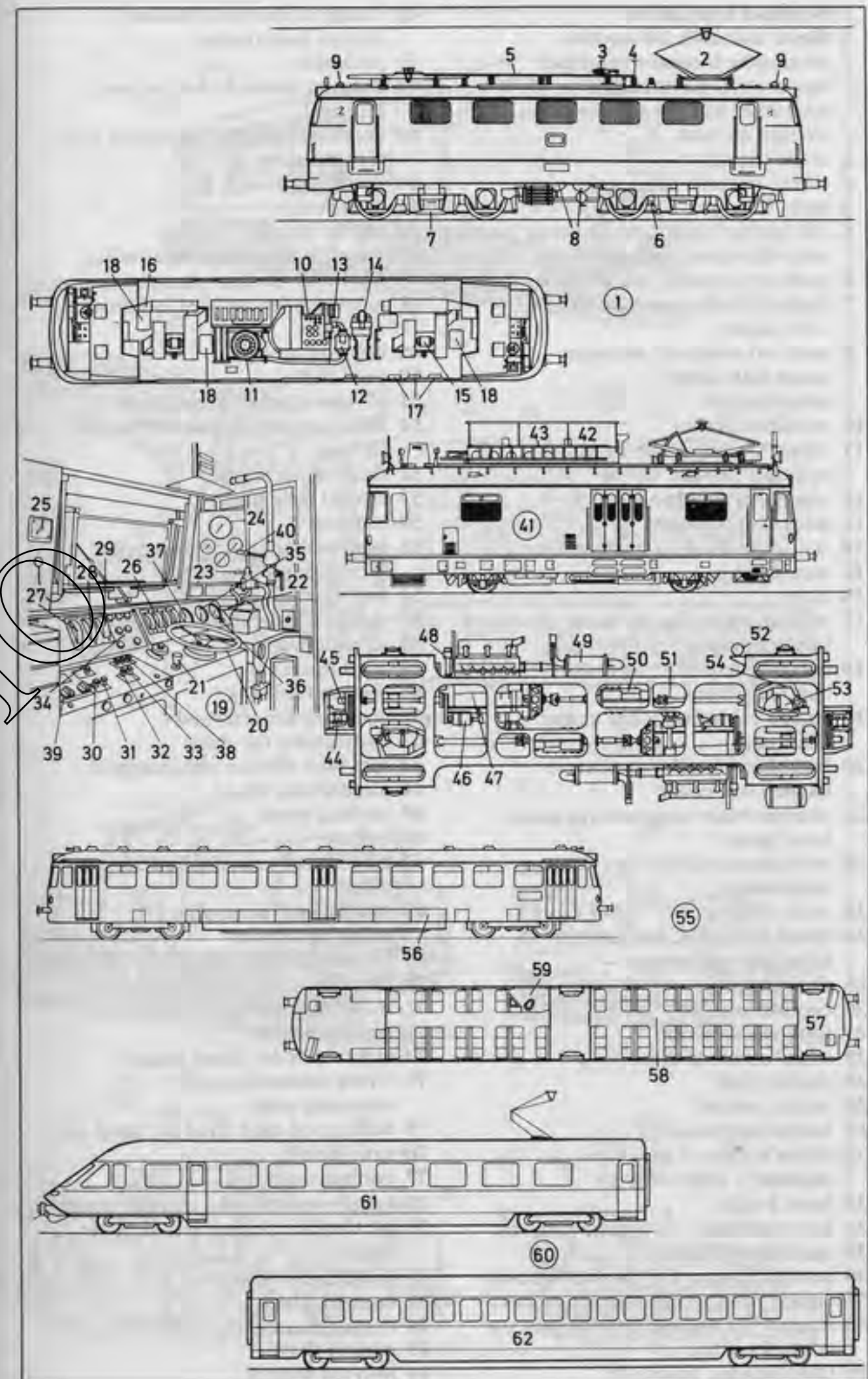

- 1-84 diesel locomotives
- 1 diesel-hydraulic locomotive, a mainline locomotive (diesel locomotive) for medium passenger and goods service (freight service)
- 2 bogie (truck)
- 3 wheel and axle set
- 4 main fuel tank
- 5 cab (driver's cab, *Am.* engineer's cab) of a diesel locomotive
- 6 main air pressure gauge (*Am.* gage)
- 7 brake cylinder pressure gauge (*Am.* gage)
- 8 main air reservoir pressure gauge (*Am.* gage)
- 9 speedometer
- 10 auxiliary brake
- 11 driver's brake valve (*Am.* engineer's brake valve)
- 12 controller handwheel
- 13 dead man's handle
- 14 inductive train control system
- 15 signal lights
- 16 clock
- 17 voltage meter for the train heating system
- 18 current meter for the train heating system
- 19 engine oil temperature gauge (*Am.* gage)
- 20 transmission oil temperature gauge (*Am.* gage)
- 21 cooling water temperature gauge (*Am.* gage)
- 22 revolution counter (rev counter, tachometer)
- 23 radio telephone
- 24 diesel-hydraulic locomotive [plan and elevation]
- 25 diesel engine
- 26 cooling unit
- 27 fluid transmission
- 28 wheel and axle drive
- 29 cardan shaft
- 30 starter motor
- 31 instrument panel
- 32 driver's control desk (*Am.* engineer's control desk)
- 33 hand brake
- 34 air compressor with electric motor
- 35 equipment locker
- 36 heat exchanger for transmission oil
- 37 engine room ventilator
- 38 magnet for the inductive train control system
- 39 train heating generator

- 40 casing of the train heating system transformer
- 41 preheater
- 42 exhaust silencer (*Am.* exhaust muffler)
- 43 auxiliary heat exchanger for the transmission oil
- 44 hydraulic brake
- 45 tool box
- 46 starter battery
- 47 diesel-hydraulic locomotive for light and medium shunting service
- 48 exhaust silencer (*Am.* exhaust muffler)
- 49 bell and whistle
- 50 yard radio
- 51-67 elevation of locomotive
- 51 diesel engine with supercharged turbine
- 52 fluid transmission
- 53 output gear box
- 54 radiator
- 55 heat exchanger for the engine lubricating oil
- 56 fuel tank
- 57 main air reservoir
- 58 air compressor
- 59 sand boxes
- 60 reserve fuel tank
- 61 auxiliary air reservoir
- 62 hydrostatic fan drive
- 63 seat with clothes compartment
- 64 hand brake wheel
- 65 cooling water
- 66 ballast
- 67 engine and transmission control wheel
- 68 small diesel locomotive for shunting service
- 69 exhaust casing
- 70 horn
- 71 main air reservoir
- 72 air compressor
- 73 eight-cylinder diesel engine
- 74 Voith transmission with reversing gear
- 75 heating oil tank (fuel oil tank)
- 76 sand box
- 77 cooling unit
- 78 header tank for the cooling water
- 79 oil bath air cleaner (oil bath air filter)
- 80 hand brake wheel
- 81 control wheel
- 82 coupling
- 83 cardan shaft
- 84 louvred shutter

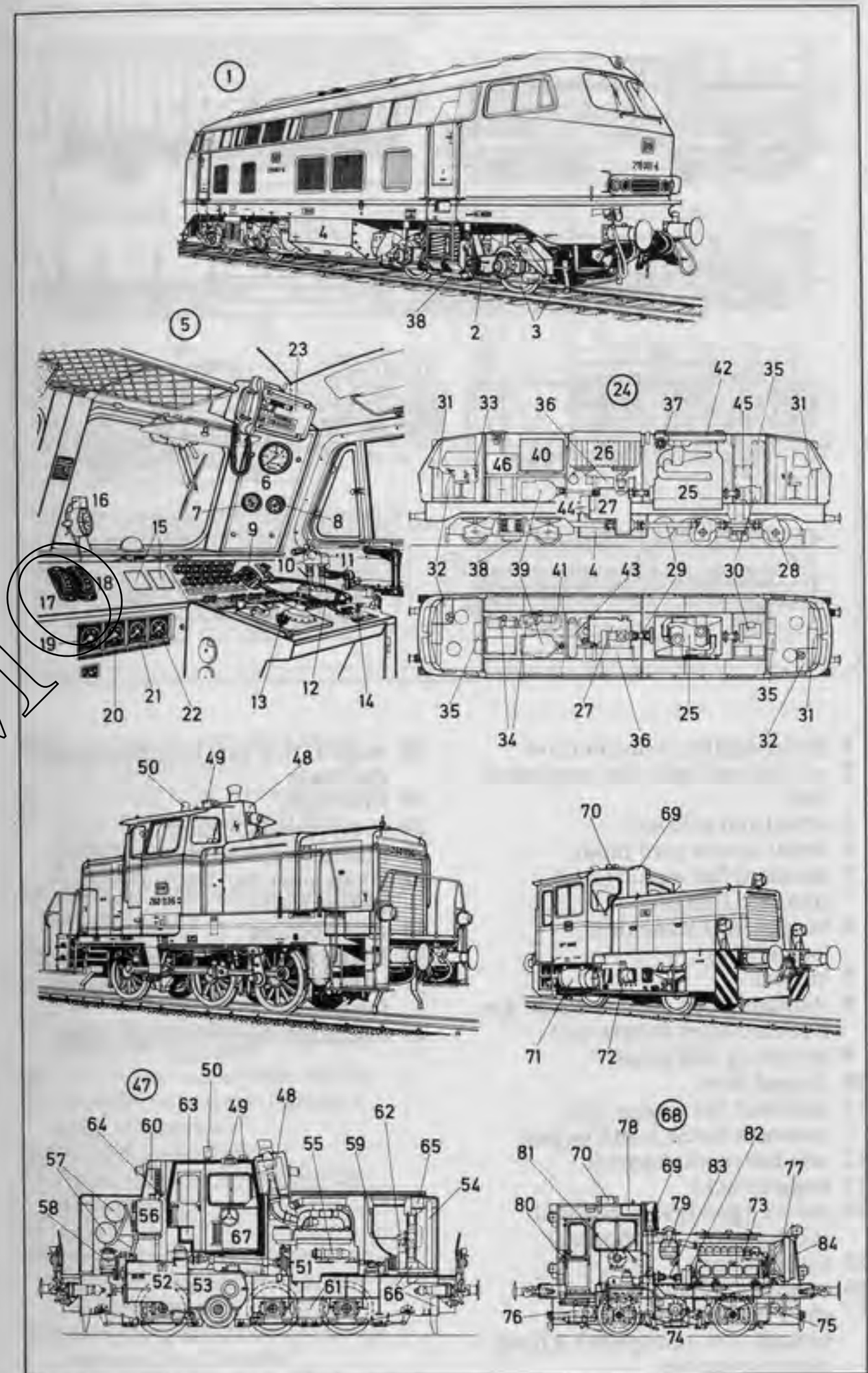

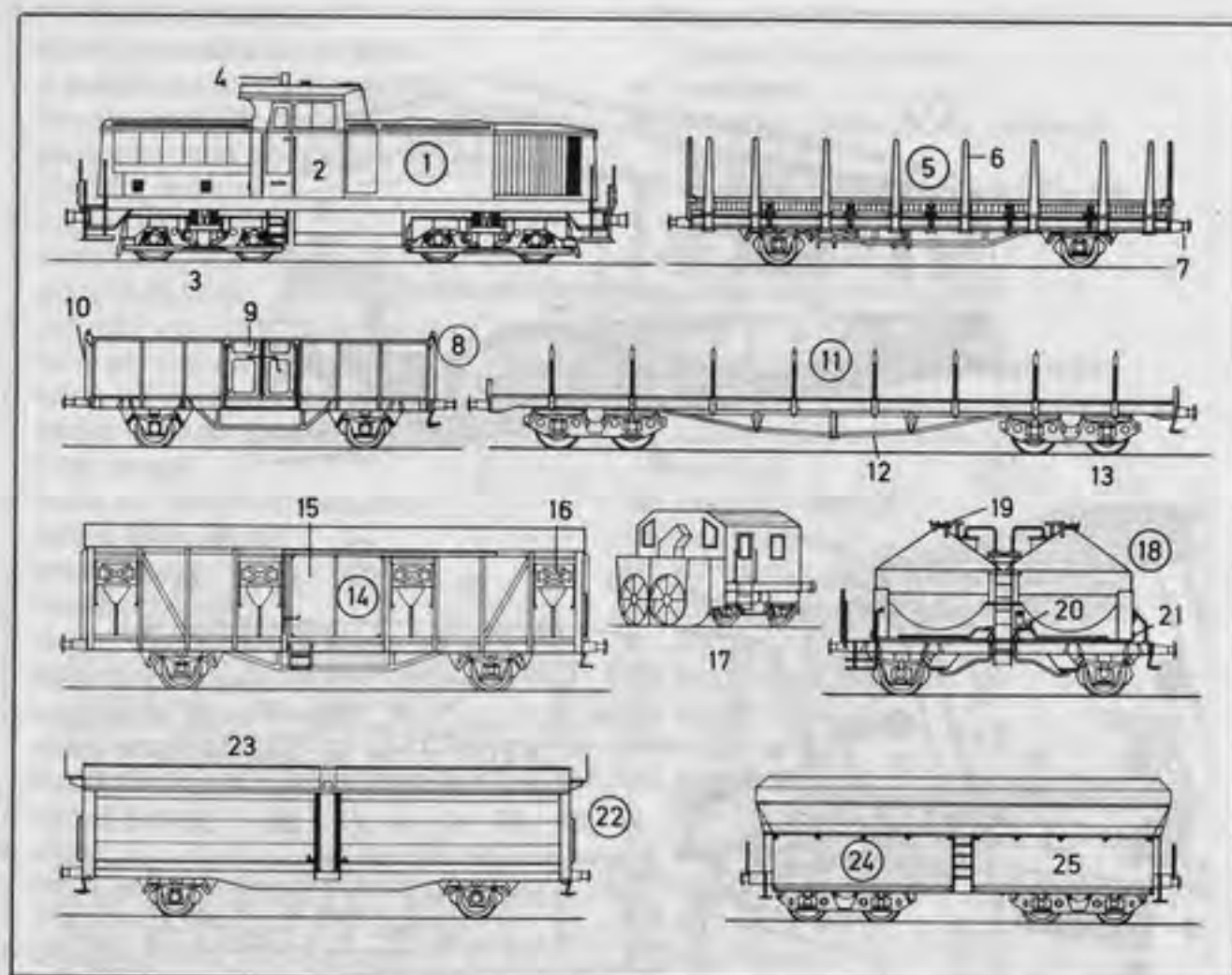

- | | |
|---|---|
| 1 diesel-hydraulic locomotive | 18 wagon (<i>Am. car</i>) with pneumatic discharge |
| 2 cab (driver's cab, <i>Am. engineer's cab</i>) | 19 filler hole |
| 3 wheel and axle set | 20 compressed-air supply |
| 4 aerial for the yard radio | 21 discharge connection valve |
| 5 standard flat wagon (<i>Am. standard flatcar</i>) | 22 goods van (<i>Am. boxcar</i>) with sliding roof |
| 6 hinged steel stanchion (<i>stanchion</i>) | 23 roof opening |
| 7 buffers | 24 bogie open self-discharge wagon (<i>Am. bogie open self-discharge freight car</i>) |
| 8 standard open goods wagon (<i>Am. standard open freight car</i>) | 25 discharge flap (discharge door) |
| 9 revolving side doors | |
| 10 hinged front | |
| 11 standard flat wagon (<i>Am. standard flatcar</i>) with bogies | |
| 12 sole bar reinforcement | |
| 13 bogie (<i>truck</i>) | |
| 14 covered goods van (covered goods wagon, <i>Am. boxcar</i>) | |
| 15 sliding door | |
| 16 ventilation flap | |
| 17 snow blower (rotary snow plough, <i>Am. snowplow</i>), a track-clearing vehicle | |

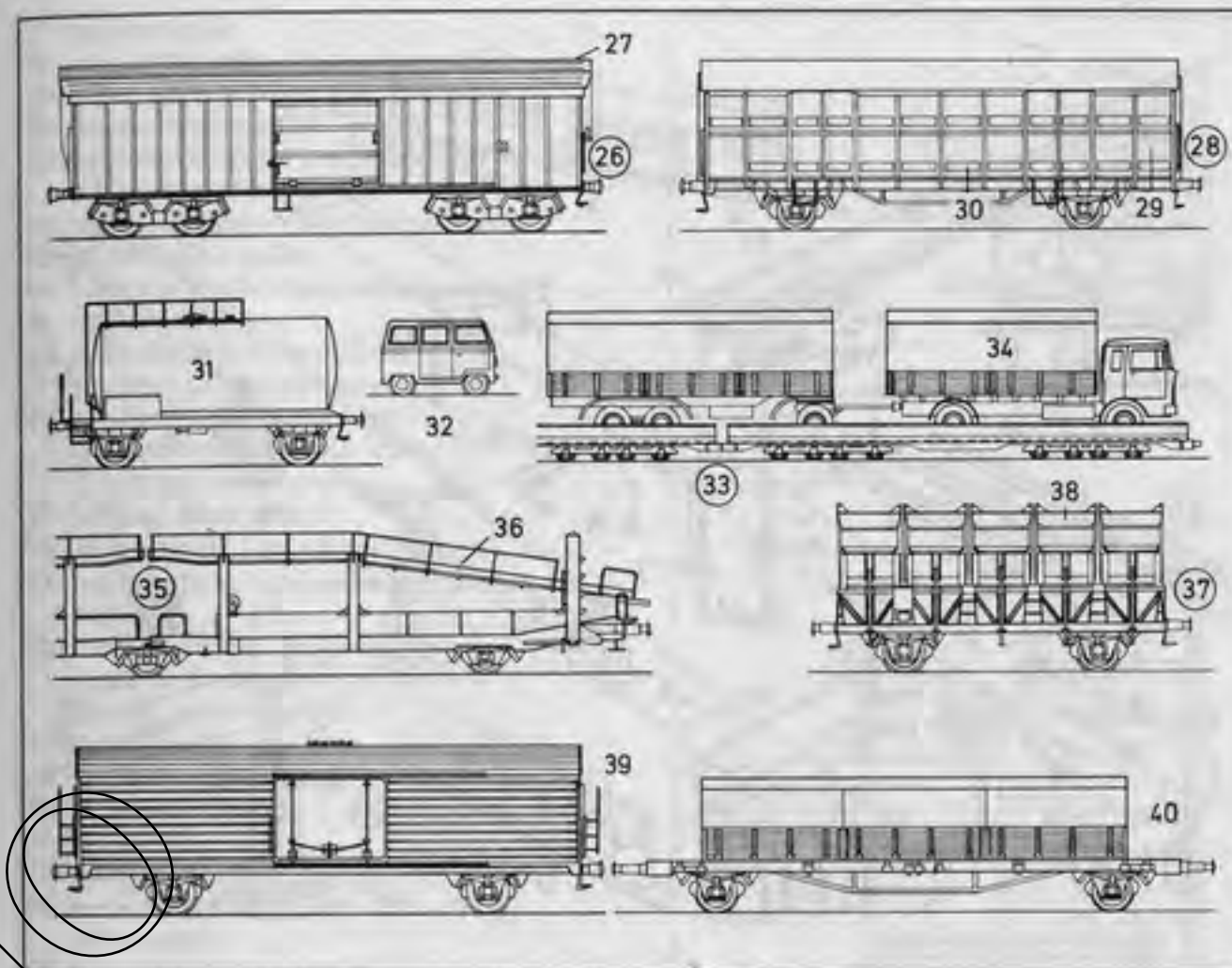

- | |
|---|
| 26 bogie wagon with swivelling (<i>Am. swiveling</i>) roof |
| 27 swivelling (<i>Am. swiveling</i>) roof |
| 28 large-capacity wagon (<i>Am. large-capacity car</i>) for small livestock |
| 29 sidewall with ventilation flaps (<i>slatted wall</i>) |
| 30 ventilation flap |
| 31 tank wagon (<i>Am. tank car</i>) |
| 32 track inspection railcar |
| 33 open special wagons (<i>Am. open special freight cars</i>) |
| 34 lorry (<i>Am. truck</i>) with trailer |
| 35 two-tier car carrier (<i>double-deck car carrier</i>) |
| 36 hinged upper deck |
| 37 tipper wagon (<i>Am. dump car</i>) with skips |
| 38 skip |
| 39 general-purpose refrigerator wagon (<i>refrigerator van, Am. refrigerator car</i>) |
| 40 interchangeable bodies for flat wagons (<i>Am. flatcars</i>) |

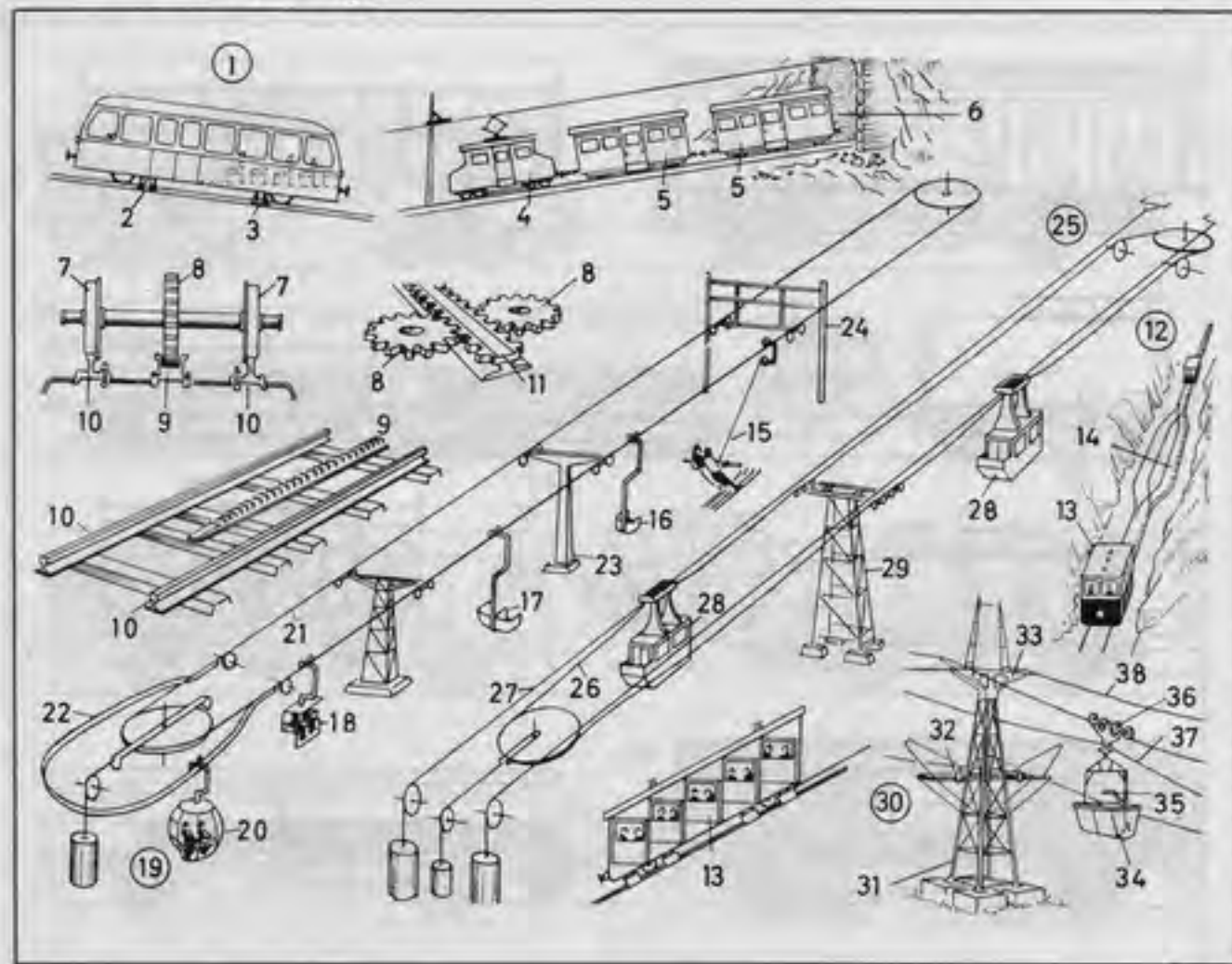

- 1-14 mountain railways (*Am. mountain railroads*)
- 1 adhesion railcar
- 2 drive
- 3 emergency brake
- 4-5 rack mountain railway (rack-and-pinion railway, cog railway, *Am. cog railroad, rack railroad*)
- 4 electric rack railway locomotive (*Am. electric rack railroad locomotive*)
- 5 rack railway coach (rack railway trailer, *Am. rack railroad car*)
- 6 tunnel
- 7-11 rack railways (rack-and-pinion railways, *Am. rack railroads*) [systems]
- 7 running wheel (carrying wheel)
- 8 driving pinion
- 9 rack [with teeth machined on top edge]
- 10 rail
- 11 rack [with teeth on both outer edges]
- 12 funicular railway (funicular, cable railway)
- 13 funicular railway car
- 14 haulage cable
- 15-38 cableways (ropeways, cable suspension lines)
- 15-24 single-cable ropeways (single-cable suspension lines), endless ropeways
- 15 drag lift

- 16-18 chair lift
- 16 lift chair, a single chair
- 17 double lift chair, a two-seater chair
- 18 double chair (two-seater chair) with coupling
- 19 gondola cableway, an endless cableway
- 20 gondola (cabin)
- 21 endless cable, a suspension (supporting) and haulage cable
- 22 U-rail
- 23 single-pylon support
- 24 gantry support
- 25 double-cable ropeway (double-cable suspension line), a suspension line with balancing cabins
- 26 haulage cable
- 27 suspension cable (supporting cable)
- 28 cabin
- 29 intermediate support
- 30 cableway (ropeway, suspension line), a double-cable ropeway (double-cable suspension line)
- 31 pylon
- 32 haulage cable roller
- 33 cable guide rail (suspension cable bearing)
- 34 skip, a tipping bucket (*Am. dumping bucket*)
- 35 stop
- 36 pulley cradle

- 37 haulage cable
- 38 suspension cable (supporting cable)
- 39 valley station (lower station)
- 40 tension weight shaft
- 41 tension weight for the suspension cable (supporting cable)
- 42 tension weight for the haulage cable
- 43 tension cable pulley
- 44 suspension cable (supporting cable)
- 45 haulage cable
- 46 balance cable (lower cable)
- 47 auxiliary cable (emergency cable)
- 48 auxiliary-cable tensioning mechanism (emergency-cable tensioning mechanism)
- 49 haulage cable rollers
- 50 spring buffer (*Am. spring bumper*)
- 51 valley station platform (lower station platform)
- 52 cabin (cableway gondola, ropeway gondola, suspension line gondola), a large-capacity cabin
- 53 pulley cradle
- 54 suspension gear
- 55 stabilizer
- 56 guide rail
- 57 top station (upper station)
- 58 suspension cable guide (supporting cable guide)
- 59 suspension cable anchorage (supporting cable anchorage)
- 60 haulage cable rollers
- 61 haulage cable guide wheel
- 62 haulage cable driving pulley
- 63 main drive
- 64 standby drive
- 65 control room
- 66 cabin pulley cradle
- 67 main pulley cradle
- 68 double cradle
- 69 two-wheel cradle
- 70 running wheels
- 71 suspension cable brake (supporting cable brake), an emergency brake in case of haulage cable failure
- 72 suspension gear bolt
- 73 haulage cable sleeve
- 74 balance cable sleeve (lower cable sleeve)
- 75 derailment guard
- 76 cable supports (ropeway supports, suspension line supports, intermediate supports)
- 77 pylon, a framework support
- 78 tubular steel pylon, a tubular steel support
- 79 suspension cable guide rail (supporting cable guide rail, support guide rail)
- 80 support truss, a frame for work on the cable
- 81 base of the support

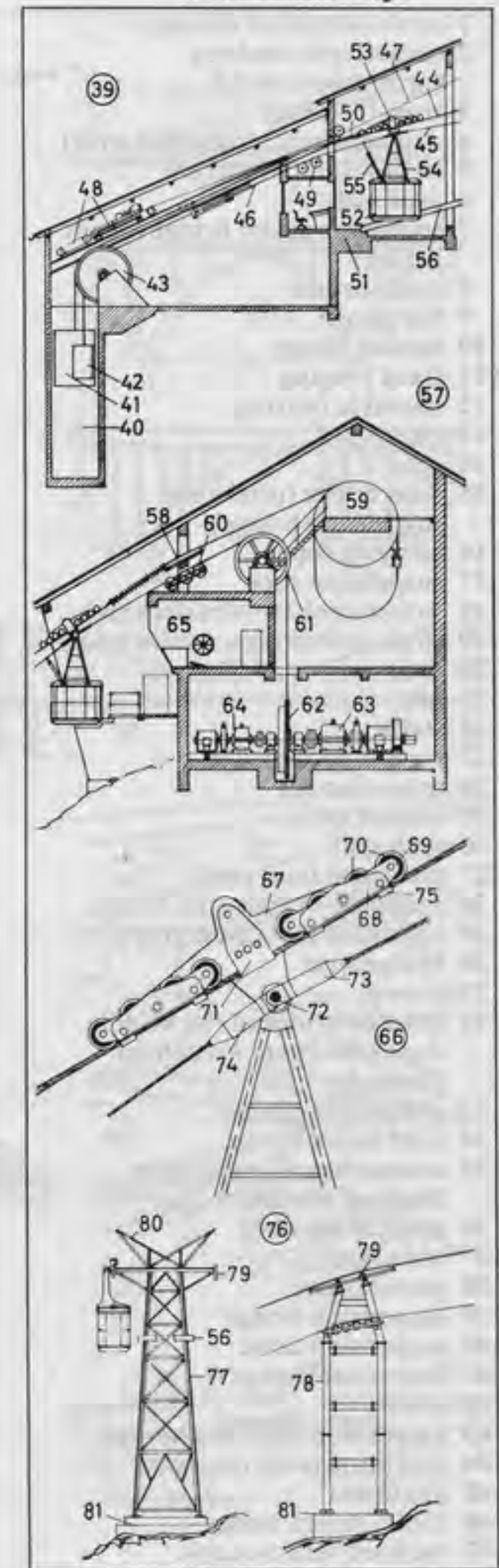

- 1 cross-section of a bridge
- 2 orthotropic roadway (orthotropic deck)
- 3 truss (bracing)
- 4 diagonal brace (diagonal strut)
- 5 hollow tubular section
- 6 deck slab
- 7 solid-web girder bridge (beam bridge)
- 8 road surface
- 9 top flange
- 10 bottom flange
- 11 fixed bearing
- 12 movable bearing
- 13 clear span
- 14 span
- 15 rope bridge (primitive suspension bridge)
- 16 carrying rope
- 17 suspension rope
- 18 woven deck (woven decking)
- 19 stone arch bridge, a solid bridge
- 20 arch
- 21 pier
- 22 statue
- 23 trussed arch bridge
- 24 truss element
- 25 trussed arch
- 26 arch span
- 27 abutment (end pier)
- 28 spandrel-braced arch bridge
- 29 abutment (abutment pier)
- 30 bridge strut
- 31 crown
- 32 covered bridge of the Middle Ages (the *Ponte Vecchio* in Florence)
- 33 goldsmiths' shops
- 34 steel lattice bridge
- 35 counterbrace (crossbrace, diagonal member)
- 36 vertical member
- 37 truss joint
- 38 portal frame
- 39 suspension bridge
- 40 suspension cable
- 41 suspender (hanger)
- 42 tower
- 43 suspension cable anchorage
- 44 tied beam [with roadway]
- 45 abutment
- 46 cable-stayed bridge
- 47 inclined tension cable

- 48 inclined cable anchorage
- 49 reinforced concrete bridge
- 50 reinforced concrete arch
- 51 inclined cable system (multiple cable system)
- 52 flat bridge, a plate girder bridge
- 53 stiffener
- 54 pier
- 55 bridge bearing
- 56 cutwater
- 57 straits bridge, a bridge built of precast elements
- 58 precast construction unit
- 59 viaduct
- 60 valley bottom
- 61 reinforced concrete pier
- 62 scaffolding
- 63 lattice swing bridge
- 64 turntable
- 65 pivot pier
- 66 pivoting half (pivoting section, pivoting span, movable half) of bridge
- 67 flat swing bridge
- 68 middle section
- 69 pivot
- 70 parapet (handrailing)

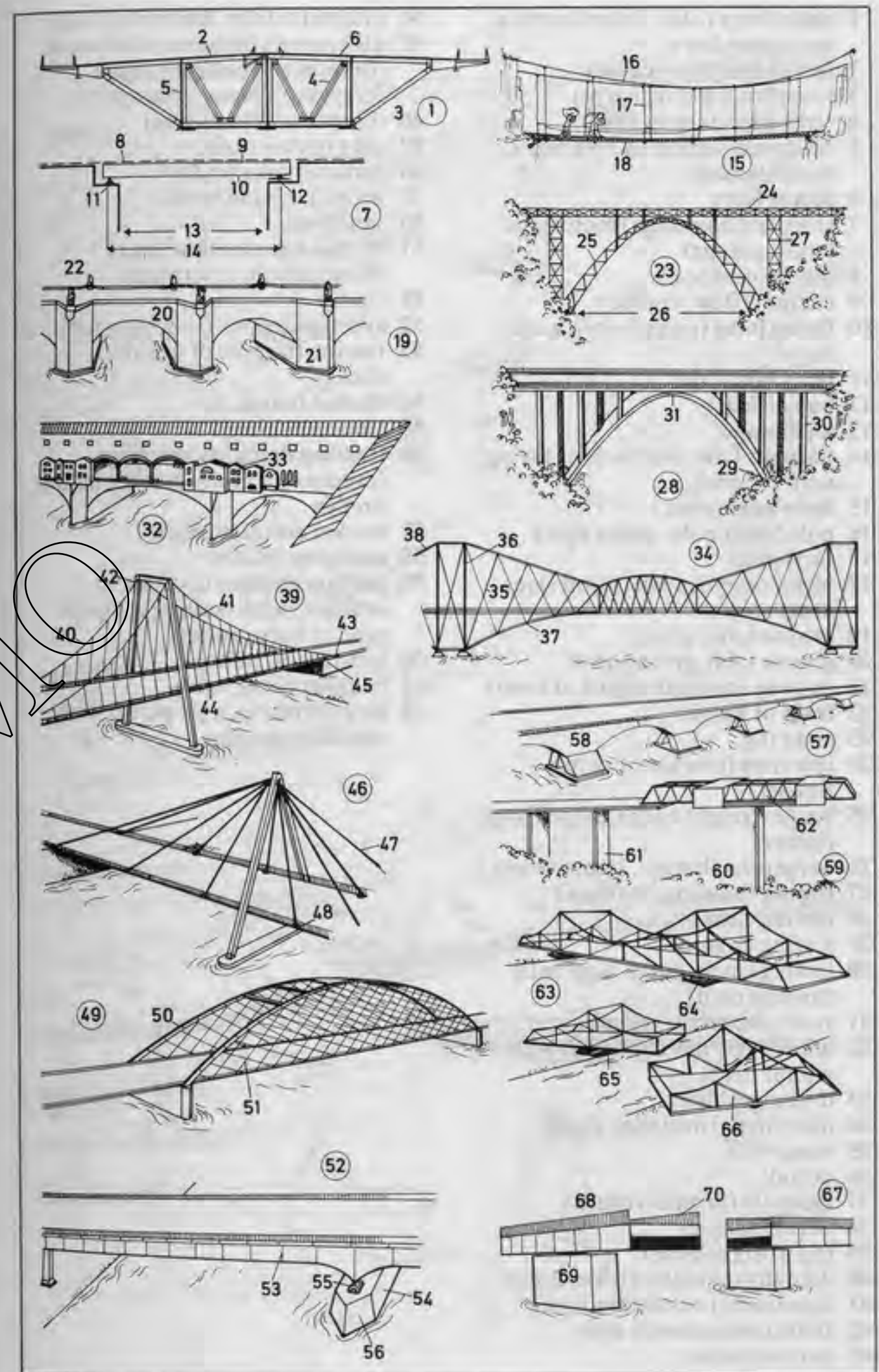

- 1 cable ferry (also: chain ferry), a passenger ferry
- 2 ferry rope (ferry cable)
- 3 river branch (river arm)
- 4 river island (river islet)
- 5 collapsed section of riverbank, flood damage
- 6 motor ferry
- 7 ferry landing stage (motorboat landing stage)
- 8 pile foundations
- 9 current (flow, course)
- 10 flying ferry (river ferry), a car ferry
- 11 ferry boat
- 12 buoy (float)
- 13 anchorage
- 14 harbour (*Am.* harbor) for laying up river craft
- 15 ferry boat (punt)
- 16 pole (punt pole, quant pole)
- 17 ferryman
- 18 blind river branch (blind river arm)
- 19 groyne (*Am.* groin)
- 20 groyne (*Am.* groin) head
- 21 fairway (navigable part of river)
- 22 train of barges
- 23 river tug
- 24 tow rope (tow line, towing hawser)
- 25 barge (freight barge, cargo barge, lighter)
- 26 bargeman (bargee, lighterman)
- 27 towing (hauling, haulage)
- 28 towing mast
- 29 towing engine
- 30 towing track; *form.*: tow path (towing path)
- 31 river after river training
- 32 dike (dyke, main dike, flood wall, winter dike)
- 33 drainage ditch
- 34 dike (dyke) drainage sluice
- 35 wing wall
- 36 outfall
- 37 drain (infiltration drain)
- 38 berm (berme)
- 39 top of dike (dyke)
- 40 dike (dyke) batter (dike slope)
- 41 flood bed (inundation area)
- 42 flood containment area
- 43 current meter

- 44 kilometre (*Am.* kilometer) sign
- 45 dikereeve's (dykereeve's) house (dikereeve's cottage); also: ferryman's house (cottage)
- 46 dikereeve (dykereeve)
- 47 dike (dyke) ramp
- 48 summer dike (dyke)
- 49 levee (embankment)
- 50 sandbags
- 51-55 bank protection (bank stabilization, revetment)
- 51 riprap
- 52 alluvial deposit (sand deposit)
- 53 fascine (bundle of wooden sticks)
- 54 wicker fences
- 55 stone pitching
- 56 floating dredging machine (dredger), a multi-bucket ladder dredge
- 57 bucket elevator chain
- 58 dredging bucket
- 59 suction dredger (hydraulic dredger) with trailing suction pipe or barge sucker
- 60 centrifugal pump
- 61 back scouring valve
- 62 suction pump, a jet pump with scouring nozzles

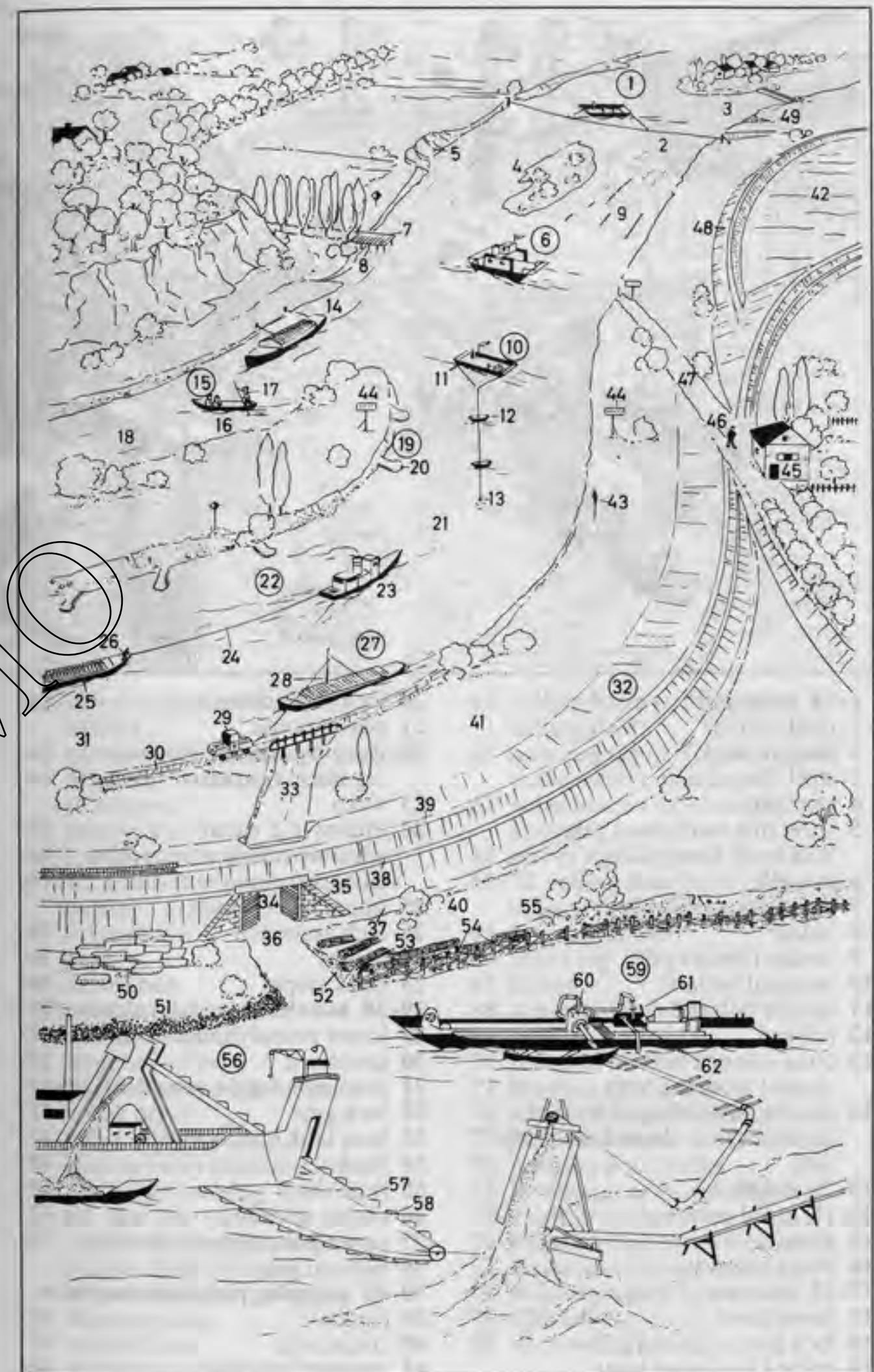

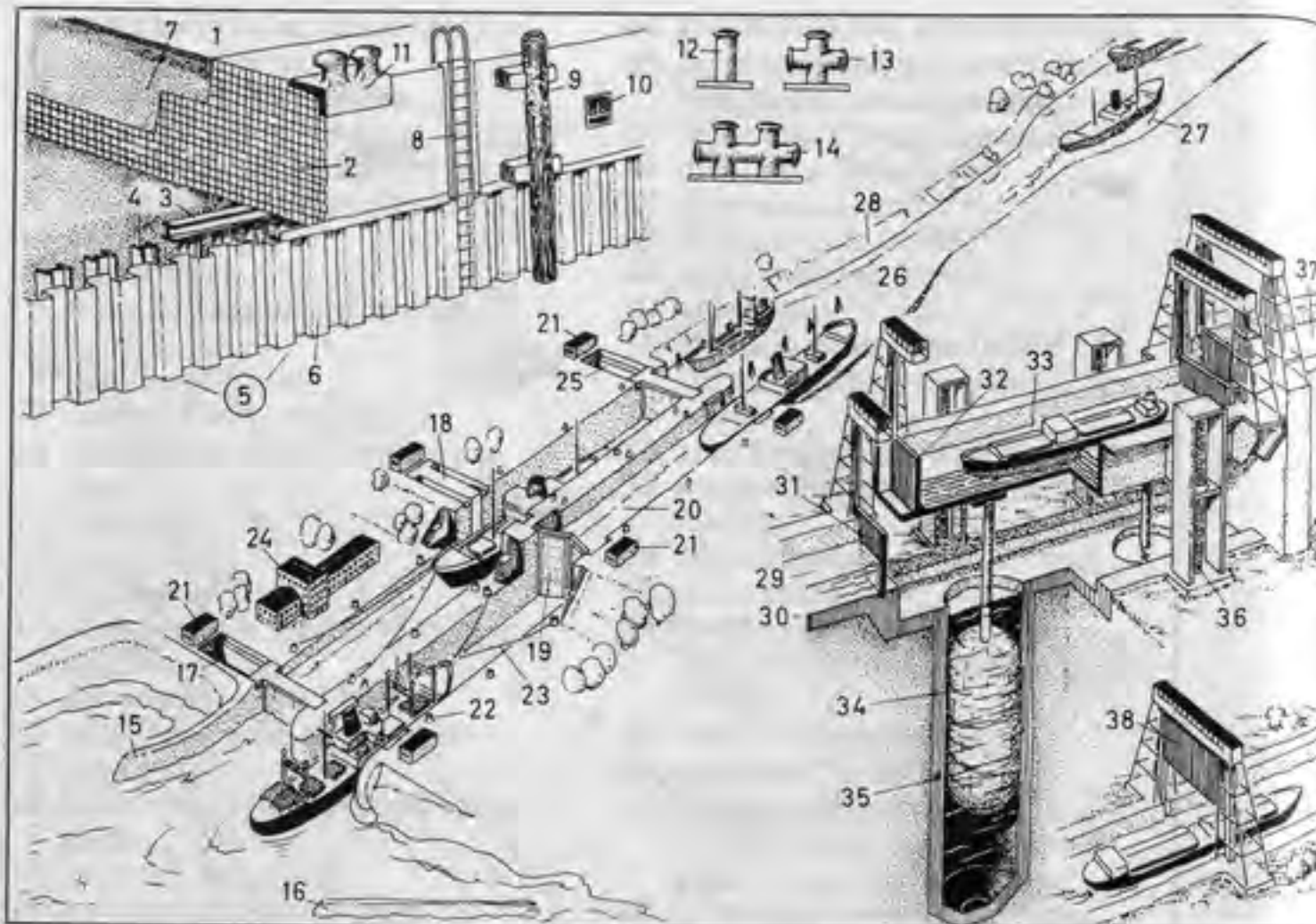

- 1-14 quay wall**
- 1 road surface
- 2 body of wall
- 3 steel sleeper
- 4 steel pile
- 5 sheet pile wall (sheet pile bulkhead, sheetpiling)
- 6 box pile
- 7 backfilling (filling)
- 8 ladder
- 9 fender (fender pile)
- 10 recessed bollard
- 11 double bollard
- 12 bollard
- 13 cross-shaped bollard (cross-shaped mooring bitt)
- 14 double cross-shaped bollard (double cross-shaped mooring bitt)
- 15-28 canal**
- 15-16 canal entrance
- 15 mole
- 16 breakwater
- 17-25 staircase of locks
- 17 lower level
- 18 lock gate, a sliding gate
- 19 mitre (*Am.* miter) gate
- 20 lock (lock chamber)
- 21 power house
- 22 warping capstan (hauling capstan), a capstan
- 23 warp
- 24 offices (e.g. canal administration, river police, customs)
- 25 upper level (head)
- 26 lock approach
- 27 lay-by
- 28 bank slope
- 29-38 boat lift (*Am.* boat elevator)**
- 29 lower pound (lower reach)
- 30 canal bed
- 31 pound lock gate, a vertical gate
- 32 lock gate
- 33 boat tank (caisson)
- 34 float
- 35 float shaft
- 36 lifting spindle
- 37 upper pound (upper reach)
- 38 vertical gate
- 39-46 pumping plant and reservoir**
- 39 forebay
- 40 surge tank
- 41 pressure pipeline

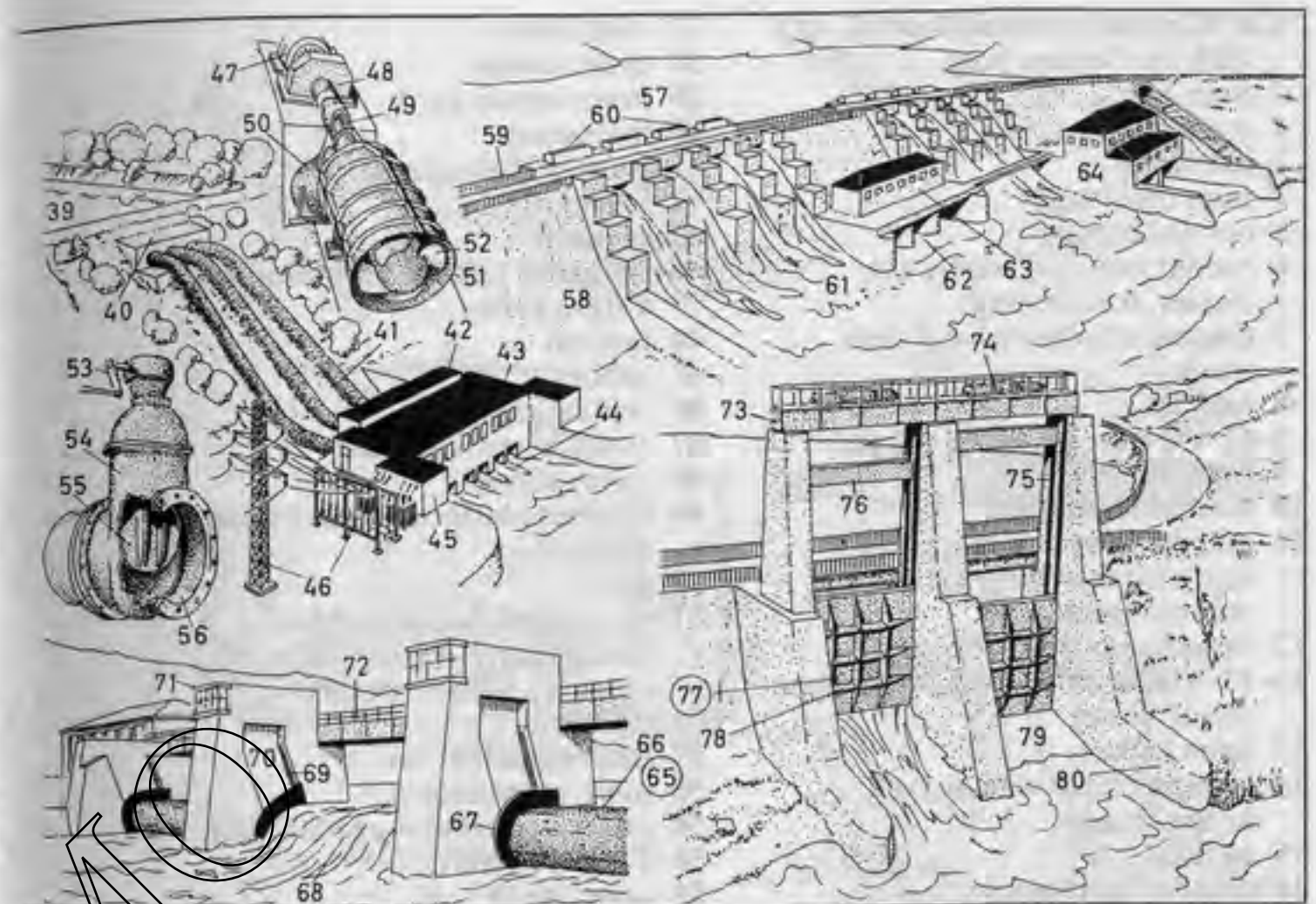

- 42 valve house (valve control house)
- 43 turbine house (pumping station)
- 44 discharge structure (outlet structure)
- 45 control station
- 46 transformer station
- 47-52 axial-flow pump (propeller pump)**
- 47 drive motor
- 48 gear
- 49 drive shaft
- 50 pressure pipe
- 51 suction head
- 52 impeller wheel
- 53-56 sluice valve (sluice gate)**
- 53 crank drive
- 54 valve housing
- 55 sliding valve (sliding gate)
- 56 discharge opening
- 57-64 dam (barrage)**
- 57 reservoir (storage reservoir, impounding reservoir, impounded reservoir)
- 58 masonry dam
- 59 crest of dam
- 60 spillway (overflow spillway)
- 61 stilling basin (stilling box, stilling pool)
- 62 scouring tunnel (outlet tunnel, waste water outlet)
- 63 valve house (valve control house)
- 64 power station
- 65-72 rolling dam (weir), a barrage; other system: shutter weir**
- 65 roller, a barrier
- 66 roller top
- 67 flange
- 68 submersible roller
- 69 rack track
- 70 recess
- 71 hoisting gear cabin
- 72 service bridge (walkway)
- 73-80 sluice dam**
- 73 hoisting gear bridge
- 74 hoisting gear (winding gear)
- 75 guide groove
- 76 counterweight (counterpoise)
- 77 sluice gate (floodgate)
- 78 reinforcing rib
- 79 dam sill (weir sill)
- 80 wing wall

- 1-6 Germanic rowing boat [ca. AD 400], the Nydam boat
- 1 stern post
- 2 steersman
- 3 oarsman
- 4 stem post (stem)
- 5 oar, for rowing
- 6 rudder (steering oar), a side rudder, for steering
- 7 dugout, a hollowed-out tree trunk
- 8 paddle
- 9-12 trireme, a Roman warship
- 9 ram
- 10 forecastle (fo'c'sle)
- 11 grapple (grapnel, grappling iron), for fastening the enemy ship alongside
- 12 three banks (tiers) of oars
- 13-17 Viking ship (longship, dragon ship) [Norse]
- 13 helm (tiller)
- 14 awning crutch with carved horses' heads
- 15 awning
- 16 dragon figurehead
- 17 shield
- 18-26 cog (Hansa cog, Hansa ship)
- 18 anchor cable (anchor rope, anchor hawser)
- 19 forecastle (fo'c'sle)
- 20 bowsprit
- 21 furled (brailed-up) square sail
- 22 town banner (city banner)
- 23 aftercastle (sterncastle)
- 24 rudder, a stem rudder
- 25 elliptical stern (round stern)
- 26 wooden fender
- 27-43 caravel (carvel) ['Santa Maria' 1492]
- 27 admiral's cabin
- 28 spanker boom
- 29 mizzen (mizen, mutton spanker, lateen spanker), a lateen sail
- 30 lateen yard
- 31 mizzen (mizen) mast
- 32 lashing
- 33 mainsail (main course), a square sail
- 34 bonnet, a removable strip of canvas
- 35 bowline
- 36 bunt line (martinet)

- 37 main yard
- 38 main topsail
- 39 main topsail yard
- 40 mainmast
- 41 foresail (fore course)
- 42 foremast
- 43 spritsail
- 44-50 galley [15th to 18th century], a slave galley
- 44 lantern
- 45 cabin
- 46 central gangway
- 47 slave driver with whip
- 48 galley slaves
- 49 covered platform in the forepart of the ship
- 50 gun
- 51-60 ship of the line (line-of-battle ship) [18th to 19th century], a three-decker
- 51 jib boom
- 52 fore topgallant sail
- 53 main topgallant sail
- 54 mizzen (mizen) topgallant sail
- 55-57 gilded stern
- 55 upper stern
- 56 stern gallery
- 57 quarter gallery, a projecting balcony with ornamental portholes
- 58 lower stern
- 59 gunports for broadside fire
- 60 gunport shutter

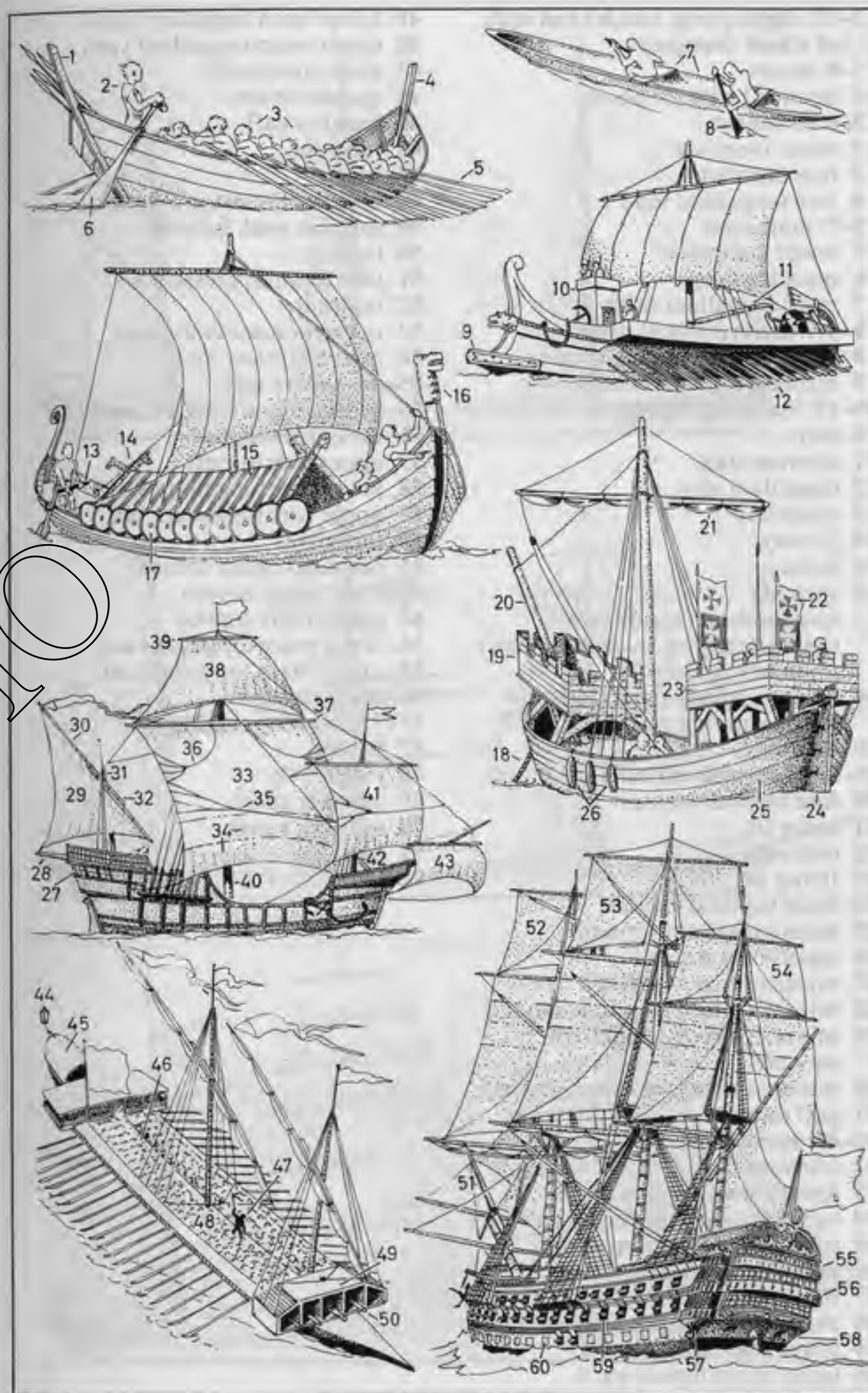

- 1-72 rigging (rig, tackle) and sails of a bark (barque)**
- 1-9 masts**
- 1 bowsprit with jib boom
2-4 foremast
2 lower foremast
3 fore topmast
4 fore topgallant mast
5-7 mainmast
5 lower mainmast
6 main topmast
7 main topgallant mast
8-9 mizzen (mizen) mast
8 lower mizzen (lower mizen)
9 mizzen (mizen) topmast
- 10-19 standing rigging**
- 10 stay
11 topmast stay
12 topgallant stay
13 royal stay
14 jib stay
15 bobstay
16 shrouds
17 fore topmast rigging (main topmast rigging, mizzen (mizen) topmast rigging)
18 fore topgallant rigging (main topgallant rigging)
19 backstays
- 20-31 fore-and-aft sails**
- 20 fore topmast staysail
21 inner jib
22 outer jib
23 flying jib
24 main topmast staysail
25 main topgallant staysail
26 main royal staysail
27 mizzen (mizen) staysail
28 mizzen (mizen) topmast staysail
29 mizzen (mizen) topgallant staysail
30 mizzen (mizen, spanker, driver)
31 gaff topsail
- 32-45 spars**
- 32 foreyard
33 lower fore topsail yard
34 upper fore topsail yard
35 lower fore topgallant yard
36 upper fore topgallant yard
37 fore royal yard
38 main yard
39 lower main topsail yard
40 upper main topsail yard
41 lower main topgallant yard
42 upper main topgallant yard
43 main royal yard
44 spanker boom
45 spanker gaff
46 footrope
47 lifts
48 spanker boom topping lift
49 spanker peak halyard
- 50 foretop**
- 51 fore topmast crosstrees**
- 52 maintop**
- 53 main topmast crosstrees**
- 54 mizzen (mizen) top**
- 55-66 square sails**
- 55 foresail (fore course)
56 lower fore topsail
57 upper fore topsail
58 lower fore topgallant sail
59 upper fore topgallant sail
60 fore royal
61 mainsail (main course)
62 lower main topsail
63 upper main topsail
64 lower main topgallant sail
65 upper main topgallant sail
66 main royal sail
- 67-71 running rigging**
- 67 braces
68 sheets
69 spanker sheet
70 spanker vang
71 bunt line
72 reef

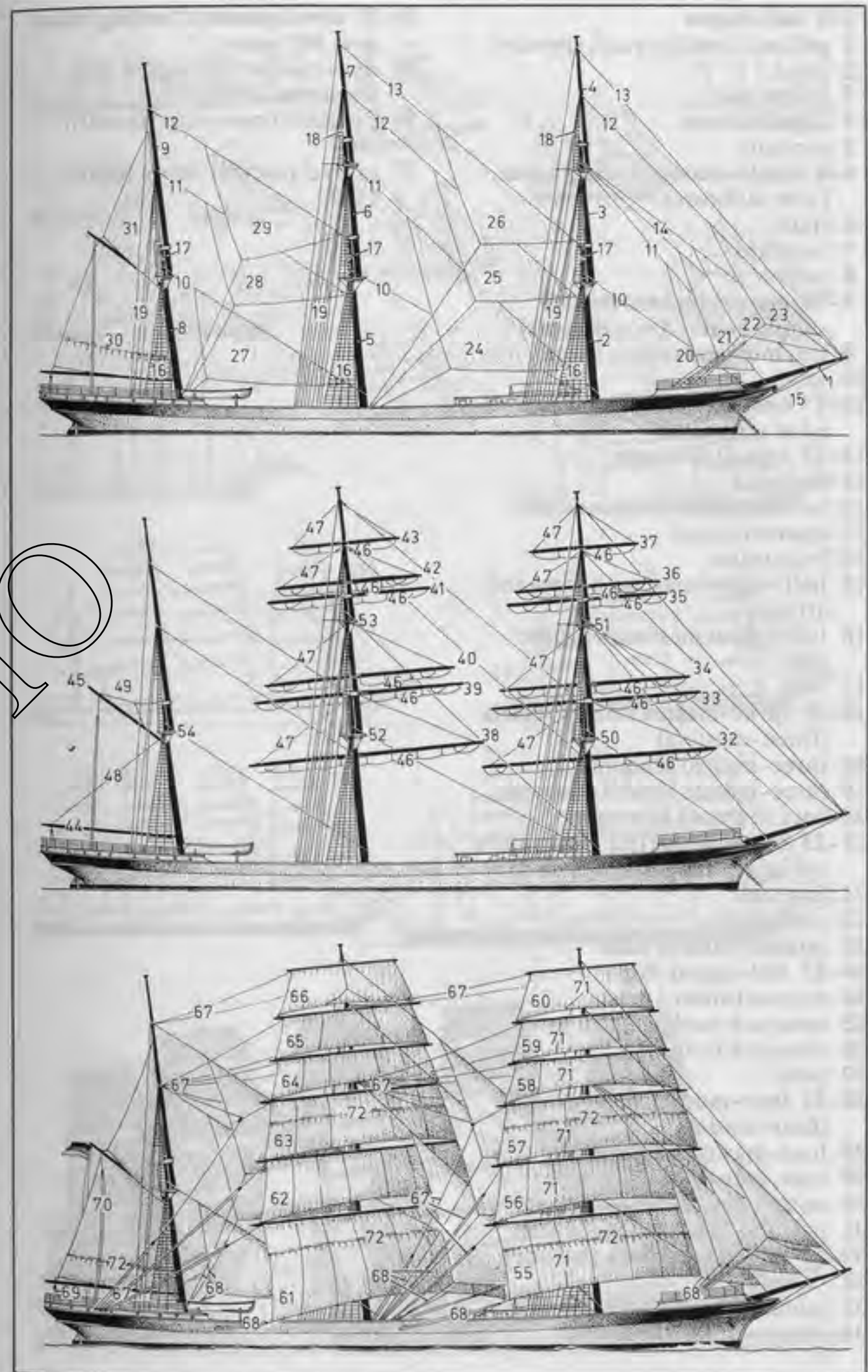

- 1-5 sail shapes
 1 gaffsail (*small*: trysail, spencer)
 2 jib
 3 lateen sail
 4 lugsail
 5 spritsail
 6-8 single-masted sailing boats
 (*Am.* sailboats)
 6 tjalk
 7 leeboard
 8 cutter
 9-10 mizzen (mizen) masted sailing boats (*Am.* sailboats)
 9 ketch-rigged sailing barge
 10 yawl
 11-17 two-masted sailing boats
 (*Am.* sailboats)
 11 topsail schooner
 11 mainsail
 12 boom foresail
 13 square foresail
 14 brigantine
 15 half-rigged mast with fore-and-aft sails
 16 full-rigged mast with square sails
 17 brig
 18-27 three-masted sailing vessels
 (three-masters)
 18 three-masted schooner
 19 three-masted topsail schooner
 20 bark (barque) schooner
 21-23 bark (barque) [cf. illustration of rigging and sails in plate 219]
 21 foremast
 22 mainmast
 23 mizzen (mizen) mast
 24-27 full-rigged ship
 24 mizzen (mizen) mast
 25 crossjack yard (crojack yard)
 26 crossjack (crojack)
 27 ports
 28-31 four-masted sailing ships
 (four-masters)
 28 four-masted schooner
 29 four-masted bark (barque)
 30 mizzen (mizen) mast
 31 four-masted full-rigged ship
 32-34 five-masted bark (barque)
 32 skysail
 33 middle mast
 34 mizzen (mizen) mast

- 35-37 development of sailing ships
 over 400 years
 35 five-masted full-rigged ship
 'Preussen' 1902-10
 36 English clipper ship 'Spindrift'
 1867
 37 caravel (carvel) 'Santa Maria'
 1492

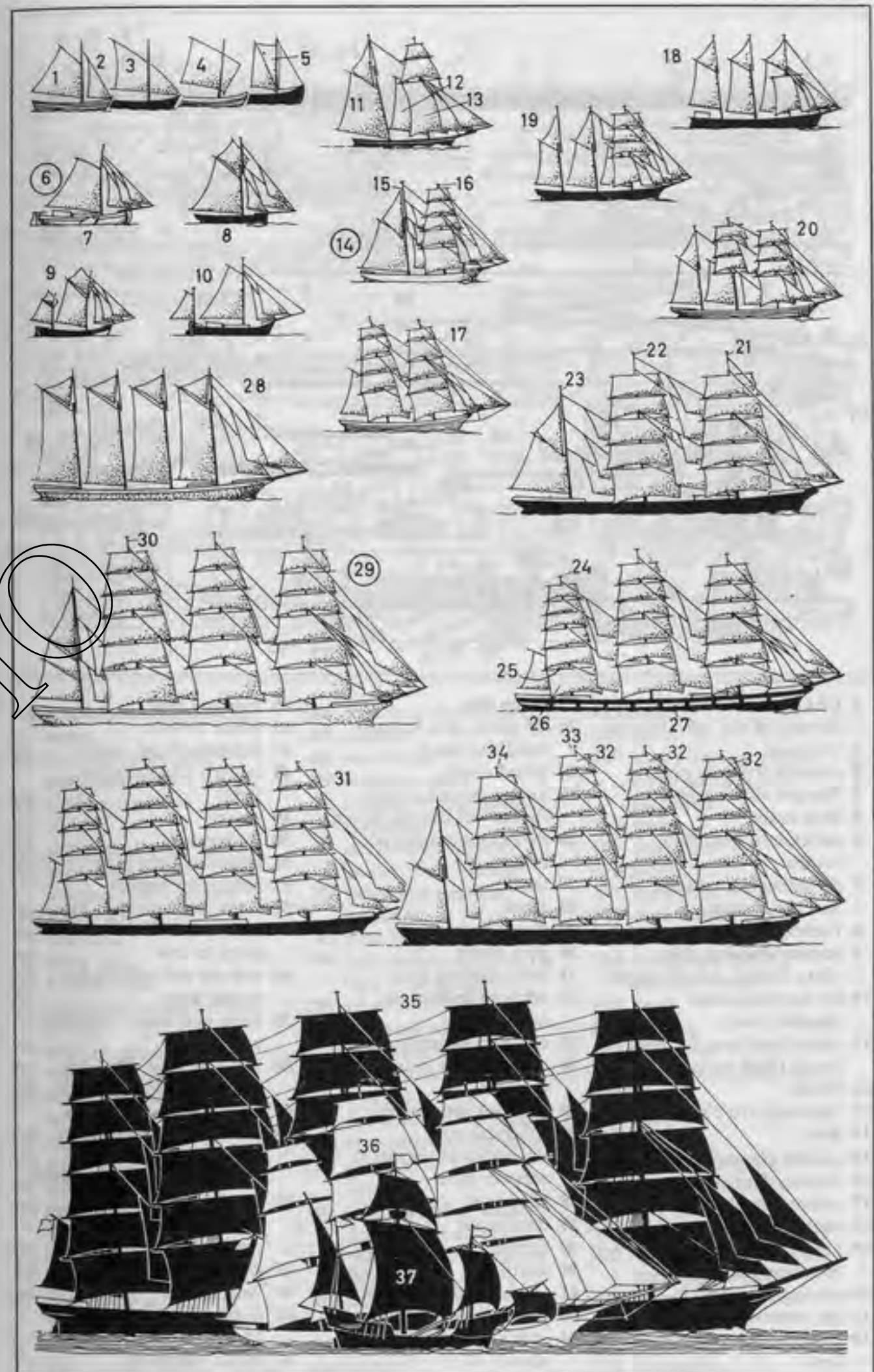

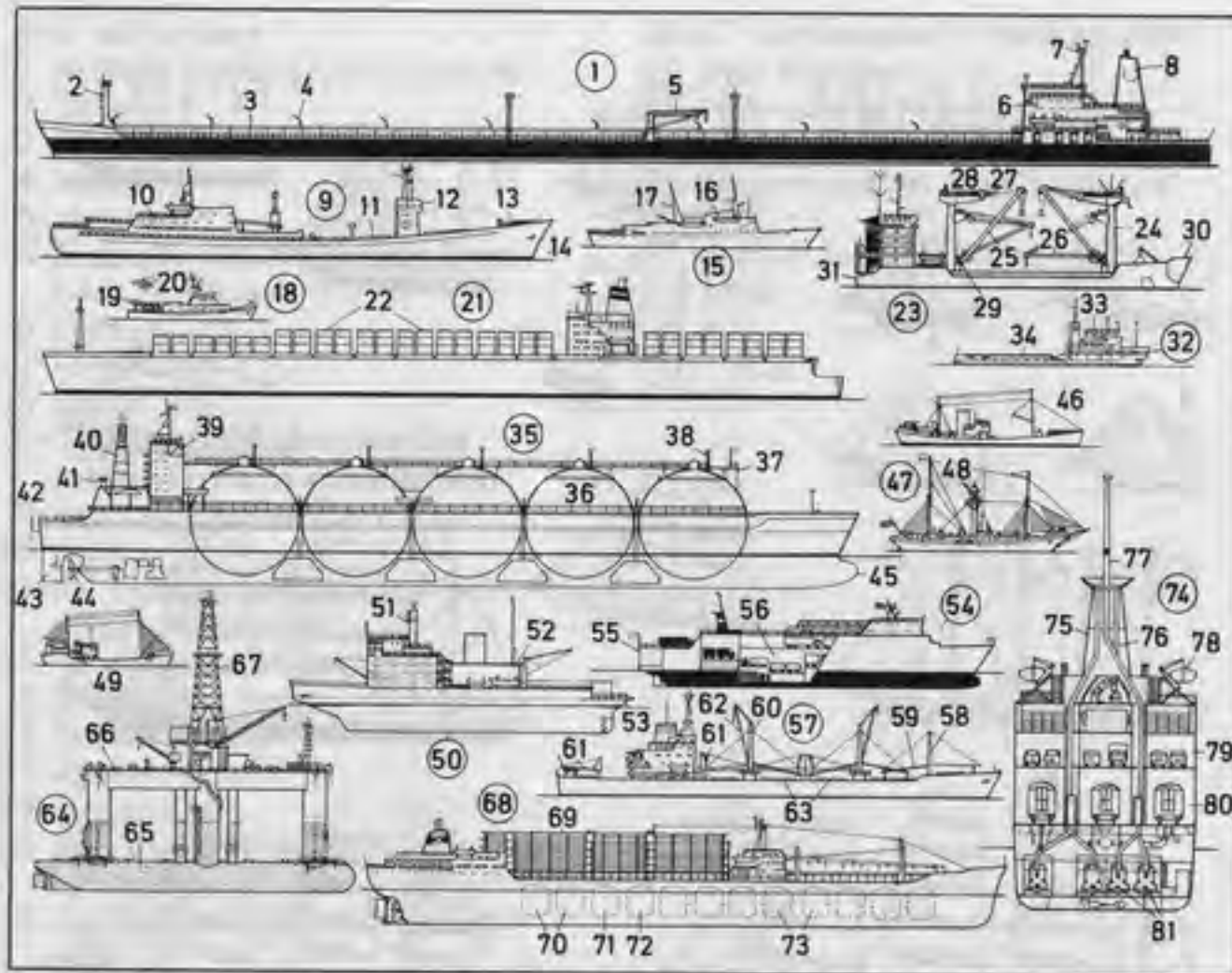

- 1 ULCC (ultra large crude carrier) of the 'all-aft' type
- 2 foremast
- 3 catwalk with the pipes
- 4 fire gun (fire nozzle)
- 5 deck crane
- 6 deckhouse with the bridge
- 7 aft signal (signalling) and radar mast
- 8 funnel
- 9 nuclear research ship 'Otto Hahn', a bulk carrier
- 10 aft superstructure (engine room)
- 11 cargo hatchway for bulk goods (bulk cargoes)
- 12 bridge
- 13 forecastle (fo'c'sle)
- 14 stem
- 15 seaside pleasure boat
- 16 dummy funnel
- 17 exhaust mast
- 18 rescue cruiser
- 19 helicopter platform (working deck)
- 20 rescue helicopter
- 21 all-container ship
- 22 containers stowed on deck
- 23 cargo ship
- 24-29 cargo gear (cargo handling gear)
- 24 bipod mast
- 25 jumbo derrick boom (heavy-lift derrick boom)
- 26 derrick boom (cargo boom)
- 27 tackle
- 28 block
- 29 thrust bearing
- 30 bow doors
- 31 stern loading door
- 32 offshore drilling rig supply vessel
- 33 compact superstructure with ramp
- 34 loading deck (working deck)
- 35 liquefied-gas tanker
- 36 spherical tank
- 37 navigational television receiver mast
- 38 vent mast
- 39 deckhouse
- 40 funnel
- 41 ventilator
- 42 transom stern (transom)
- 43 rudder blade (rudder)
- 44 ship's propeller (ship's screw)
- 45 bulbous bow
- 46 steam trawler
- 47 lightship (light vessel)
- 48 lantern (characteristic light)
- 49 smack
- 50 ice breaker
- 51 steaming light mast
- 52 helicopter hangar
- 53 stern towing point, for gripping the bow of ships in tow
- 54 roll-on-roll-off (ro-ro) trailer ferry
- 55 stern port (stern opening) with ramp
- 56 heavy vehicle lifts (Am. heavy vehicle elevators)
- 57 multi-purpose freighter
- 58 ventilator-type samson (samson) post (ventilator-type king post)
- 59 derrick boom (cargo boom, cargo gear, cargo-handling gear)
- 60 derrick mast
- 61 deck crane
- 62 jumbo derrick boom (heavy-lift derrick boom)
- 63 cargo hatchway
- 64 semisubmersible drilling vessel
- 65 floating vessel with machinery
- 66 drilling platform
- 67 derrick
- 68 cattleship (cattle vessel)
- 69 superstructure for transporting livestock
- 70 fresh water tanks
- 71 fuel tank
- 72 dung tank
- 73 fodder tanks
- 74 train ferry [cross section]
- 75 funnel
- 76 exhaust pipes
- 77 mast
- 78 ship's lifeboat hanging at the davit
- 79 car deck
- 80 main deck (train deck)
- 81 main engines



- 82 passenger liner (liner, ocean liner)
- 83 stem
- 84 funnel with lattice casing
- 85 flag dressing (rainbow dressing, string of flags extending over mastheads, e.g., on the maiden voyage)
- 86 trawler, a factory ship
- 87 gallows
- 88 stern ramp
- 89 container ship
- 90 loading bridge (loading platform)
- 91 sea ladder (Jacob's ladder, rope ladder)
- 92 barge and push tug assembly
- 93 push tug
- 94 tug-pushed dumb barge (tug-pushed lighter)
- 95 pilot boat
- 96 combined cargo and passenger liner
- 97 passengers disembarking by boat
- 98 accommodation ladder
- 99 coaster (coasting vessel)
- 100 customs or police launch
- 101-128 excursion steamer (pleasure steamer)
- 101-106 lifeboat launching gear
- 101 davit
- 102 wire rope span
- 103 lifeline
- 104 tackle
- 105 block
- 106 fall
- 107 ship's lifeboat (ship's boat) covered with tarpaulin
- 108 stem
- 109 passenger
- 110 steward
- 111 deck-chair
- 112 deck hand
- 113 deck bucket
- 114 boatswain (bo's'n, bo'sun, bosun)
- 115 tunic
- 116 awning
- 117 stanchion
- 118 ridge rope (jackstay)
- 119 lashing
- 120 bulwark
- 121 guard rail
- 122 handrail (top rail)
- 123 companion ladder (companionway)
- 124 lifebelt (lifebuoy)
- 125 lifebuoy light (lifebelt light, signal light)
- 126 officer of the watch (watchkeeper)
- 127 reefer (Am. pea jacket)
- 128 binoculars

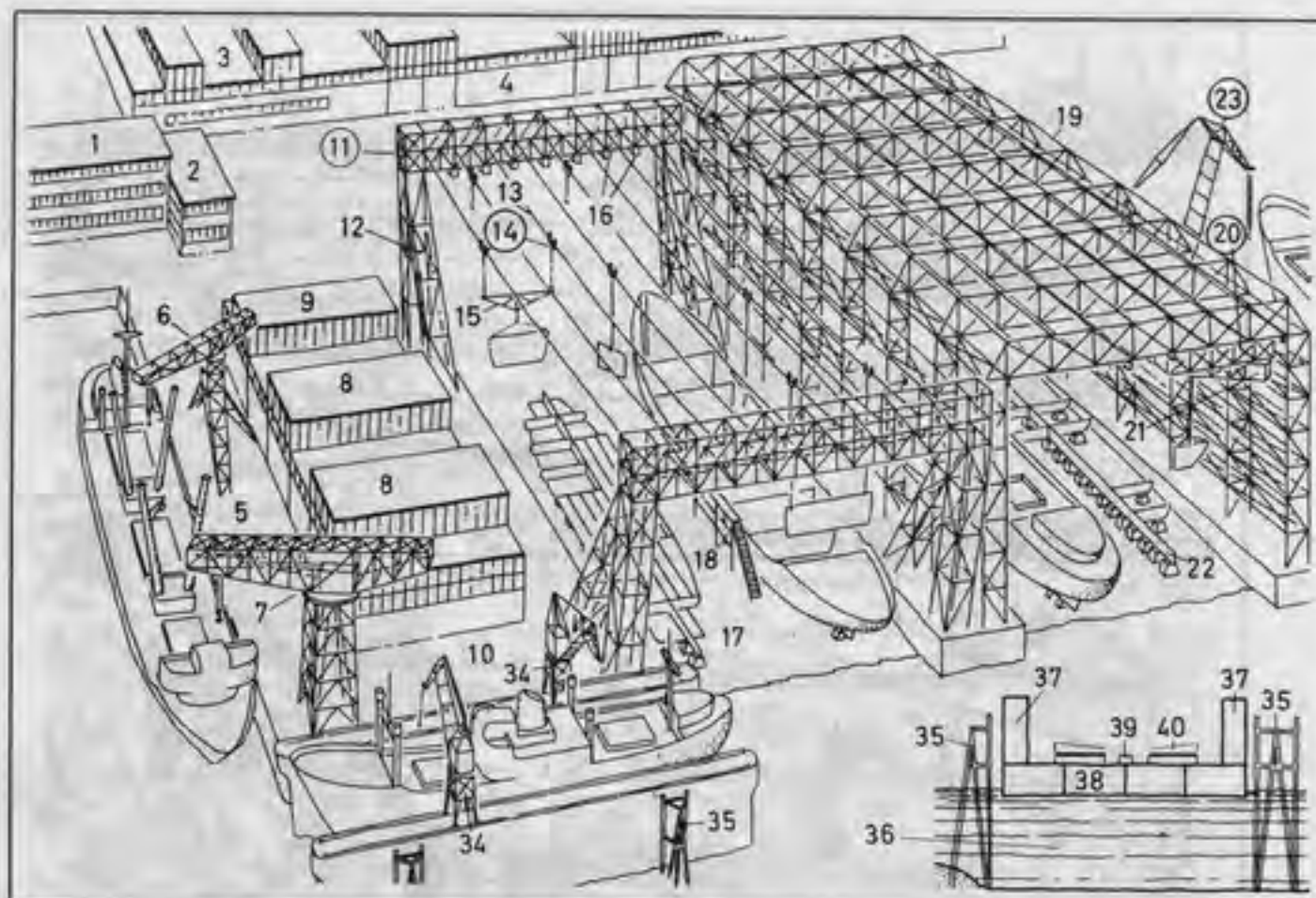

1-43 shipyard (shipbuilding yard, dockyard, *Am.* navy yard)

- 1 administrative offices
- 2 ship-drawing office
- 3-4 shipbuilding sheds
- 3 mould (*Am.* mold) loft
- 4 erection shop
- 5-9 fitting-out quay
- 5 quay
- 6 tripod crane
- 7 hammer-headed crane
- 8 engineering workshop
- 9 boiler shop
- 10 repair quay
- 11-26 slipways (slips, building berths, building slips, stocks)
- 11-18 cable crane berth, a slipway (building berth)
- 11 slipway portal
- 12 bridge support
- 13 crane cable
- 14 crab (jenny)
- 15 cross piece
- 16 crane driver's cabin (crane driver's cage)
- 17 slipway floor
- 18 staging, a scaffold

- 19-21 frame slipway
- 19 slipway frame
- 20 overhead travelling (*Am.* traveling) crane (gantry crane)
- 21 slewing crab
- 22 keel in position
- 23 luffing jib crane, a slipway crane
- 24 crane rails (crane track)
- 25 gantry crane
- 26 gantry (bridge)
- 27 trestles (supports)
- 28 crab (jenny)
- 29 hull frames in position
- 30 ship under construction
- 31-33 dry dock
- 31 dock floor (dock bottom)
- 32 dock gates (caisson)
- 33 pumping station (power house)
- 34-43 floating dock (pontoon dock)
- 34 dock crane (dockside crane), a jib crane
- 35 fender pile
- 36-43 working of docks
- 36 dock basin
- 37-38 dock structure
- 37 side tank (side wall)
- 38 bottom tank (bottom pontoon)
- 39 keel block

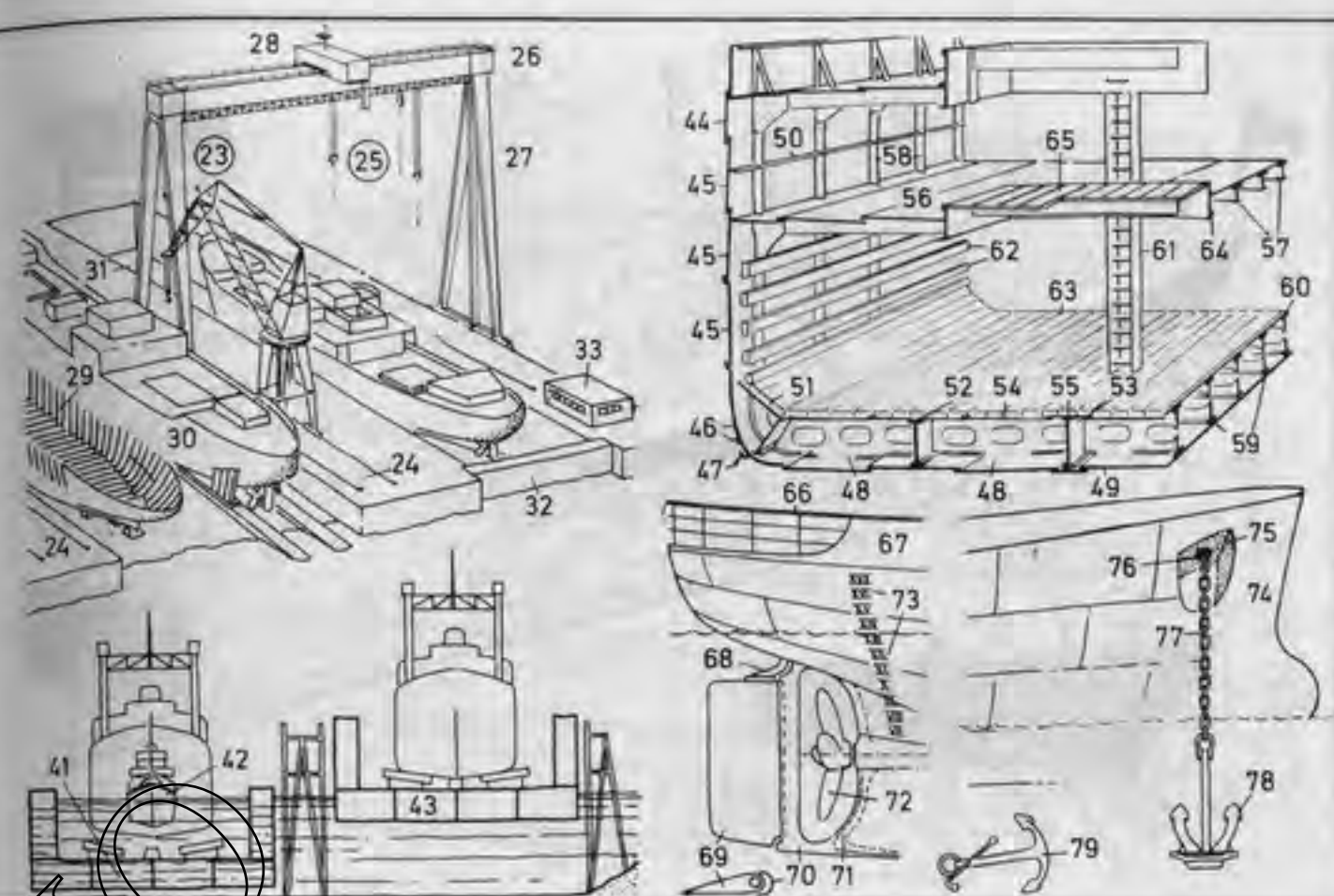

- 40 bilge block (bilge shore, side support)
- 41-43 docking a ship
- 41 flooded floating dock
- 42 tug towing the ship
- 43 emptied (pumped-out) dock
- 44-61 structural parts of the ship
- 44-56 longitudinal structure
- 44-49 shell (shell plating, skin)
- 44 sheer strake
- 45 side strake
- 46 bilge strake
- 47 bilge keel
- 48 bottom plating
- 49 flat plate keel (keel plate)
- 50 stringer (side stringer)
- 51 tank margin plate
- 52 longitudinal side girder
- 53 centre (*Am.* center) plate girder (centre girder, keelson, vertical keel)
- 54 tank top plating (tank top, inner bottom plating)
- 55 centre (*Am.* center) strake
- 56 deck plating
- 57 deck beam
- 58 frame (rib)
- 59 floor plate

- 60 cellular double bottom
- 61 hold pillar (pillar)
- 61, 63 dunnage
- 62 side battens (side ceiling, spar ceiling)
- 63 ceiling (floor ceiling)
- 64-65 hatchway
- 64 hatch coaming
- 65 hatch cover (hatchboard)
- 66-72 stern
- 66 guard rail
- 67 bulwark
- 68 rudder stock
- 69-70 Oertz rudder
- 69 rudder blade (rudder)
- 70-71 stern frame
- 70 rudder post
- 71 propeller post (screw post)
- 72 ship's propeller (ship's screw)
- 73 draught (draft) marks
- 74-79 bow
- 74 stem, a bulbous stem (bulbous bow)
- 75 hawse
- 76 hawse pipe
- 77 anchor cable (chain cable)
- 78 stockless anchor (patent anchor)
- 79 stocked anchor

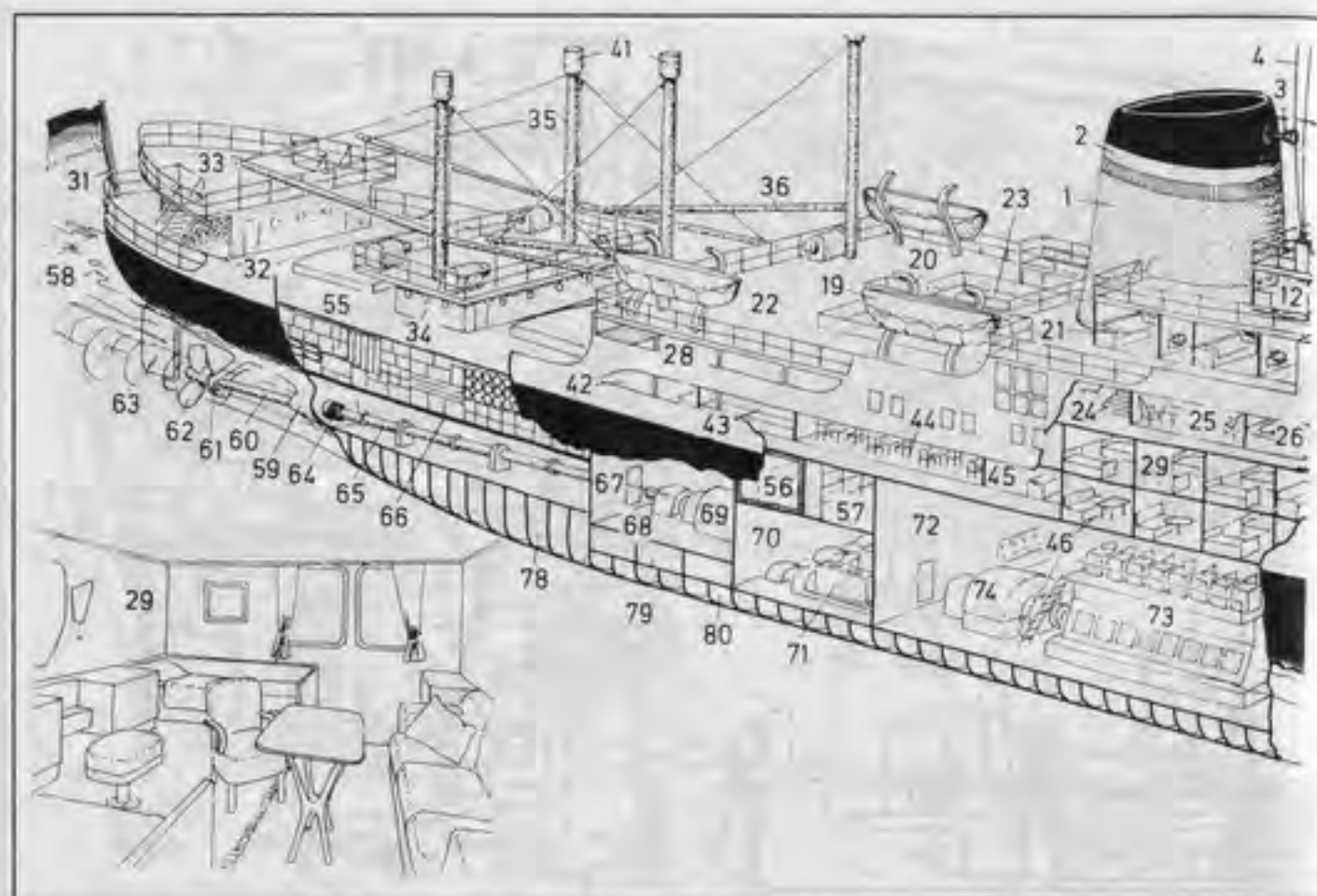

- 1-71 combined cargo and passenger ship [of the older type]**
- 1 funnel
 - 2 funnel marking
 - 3 siren (fog horn)
 - 4-11 compass platform** (compass bridge, compass flat, monkey bridge)
 - 4 antenna lead-in (antenna down-lead)
 - 5 radio direction finder (RDF) antenna (direction finder antenna, rotatable loop antenna, aural null loop antenna)
 - 6 magnetic compass (mariner's compass)
 - 7 morse lamp (signalling, *Am.* signaling, lamp)
 - 8 radar antenna (radar scanner)
 - 9 code flag signal
 - 10 code flag halyards
 - 11 triatic stay (signal stay)
 - 12-18 bridge deck** (bridge)
 - 12 radio room
 - 13 captain's cabin
 - 14 navigating bridge
 - 15 starboard sidelight [green; port sidelight red]

- 16 wing of bridge
- 17 shelter (weather cloth, dodger)
- 18 wheelhouse
- 19-21 boat deck**
- 19 ship's lifeboat
- 20 davit
- 21 officer's cabin
- 22-27 promenade deck**
- 22 sun deck (lido deck)
- 23 swimming pool
- 24 companion ladder (companionway)
- 25 library (ship's library)
- 26 lounge
- 27 promenade
- 28-30 A-deck**
- 28 semi-enclosed deck space
- 29 double-berth cabin, a cabin
- 30 de luxe cabin
- 31 ensign staff
- 32-42 B-deck** (main deck)
- 32 after deck
- 33 poop
- 34 deckhouse
- 35 samson (sampson) post (king post)
- 36 derrick boom (cargo boom)

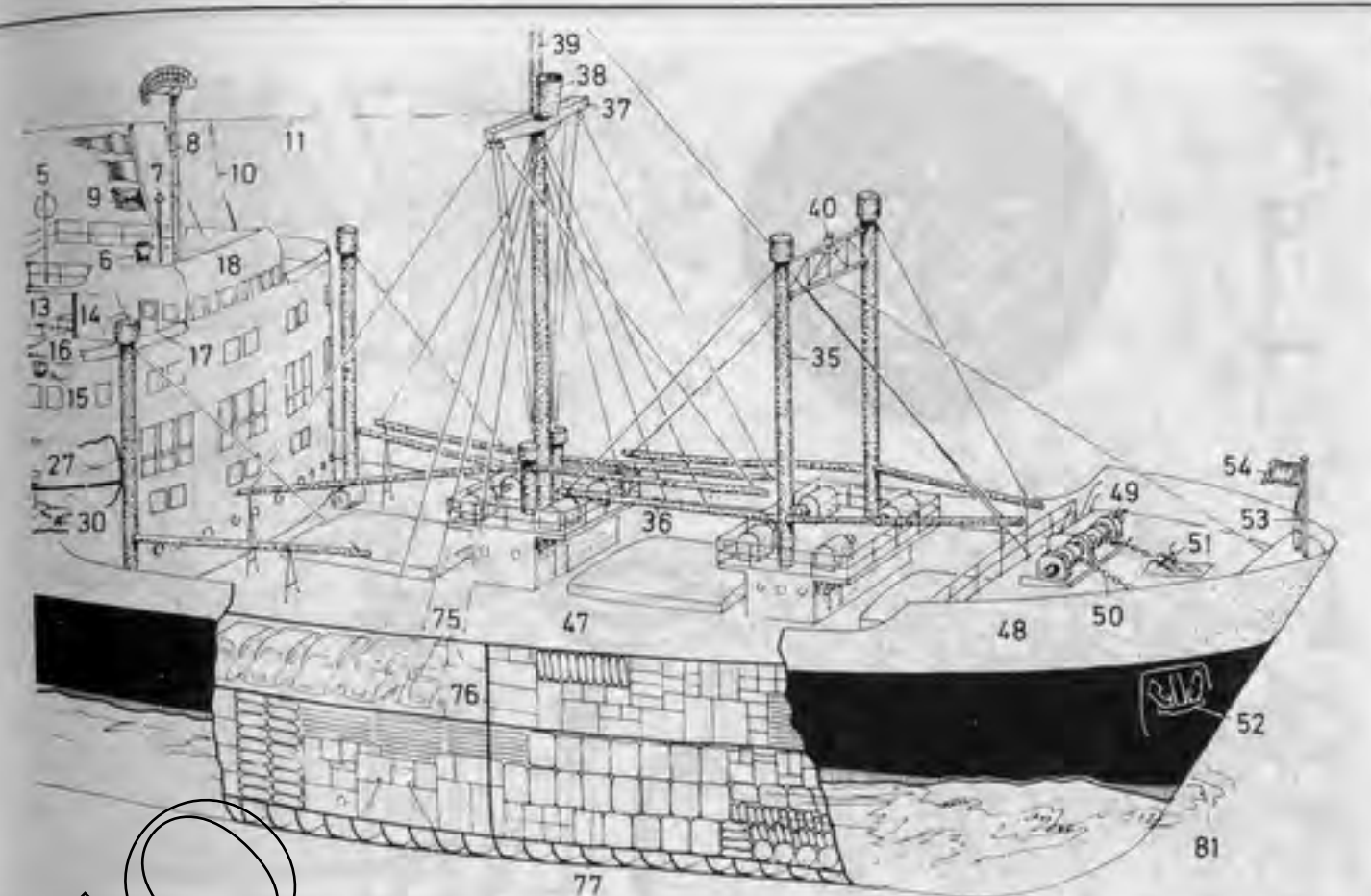

- 37 crosstrees (spreader)
- 38 crow's nest
- 39 topmast
- 40 forward steaming light
- 41 ventilator lead
- 42 galley (caboose, cookroom, ship's kitchen)
- 43 ship's pantry
- 44 dining room
- 45 purser's office
- 46 single-berth cabin
- 47 foredeck
- 48 forecastle (fo'c'sle)
- 49-51 ground tackle**
- 49 windlass
- 50 anchor cable (chain cable)
- 51 compressor (chain compressor)
- 52 anchor
- 53 jackstaff
- 54 jack
- 55 after holds
- 56 cold storage room (insulated hold)
- 57 store room
- 58 wake
- 59 shell bossing (shaft bossing)
- 60 tail shaft (tail end shaft)

- 61 shaft strut (strut, spectacle frame, propeller strut, propeller bracket)
- 62 three-blade ship's propeller (ship's screw)
- 63 rudder blade (rudder)
- 64 stuffing box
- 65 propeller shaft
- 66 shaft alley (shaft tunnel)
- 67 thrust block
- 68-74 diesel-electric drive**
- 68 electric engine room
- 69 electric motor
- 70 auxiliary engine room
- 71 auxiliary engines
- 72 main engine room
- 73 main engine, a diesel engine
- 74 generator
- 75 forward holds
- 76 tween deck
- 77 cargo
- 78 ballast tank (deep tank) for water ballast
- 79 fresh water tank
- 80 fuel tank
- 81 bow wave

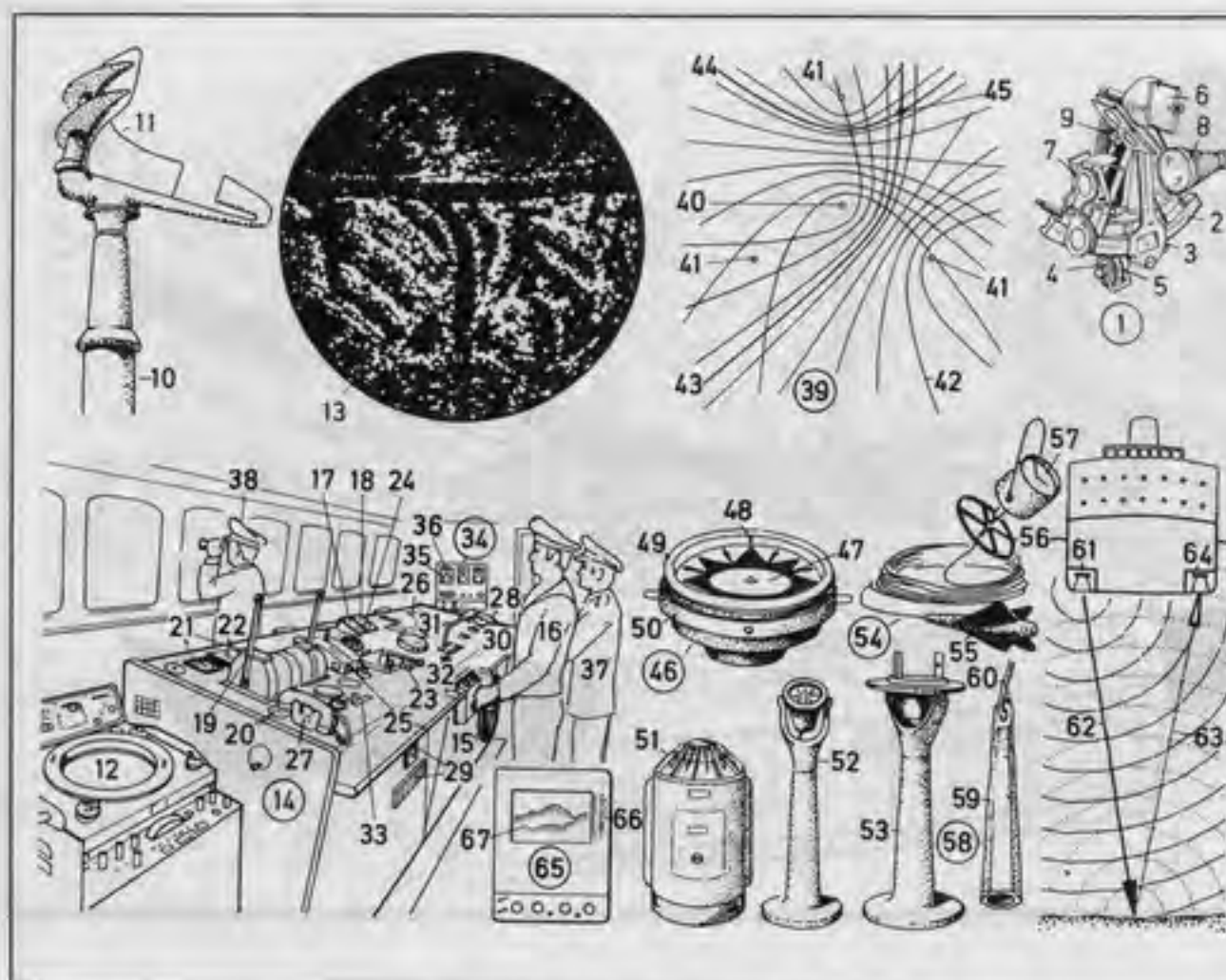

- | | | |
|--|---|--|
| 1 sextant | 20 propeller pitch indicator | 35 rough focusing indicator |
| 2 graduated arc | 21 main engine revolution indicator | 36 fine focusing indicator |
| 3 index bar (index arm) | 22 ship's speedometer (log) | 37 navigating officer |
| 4 decimal micrometer | 23 control switch for bow thruster (bow maneuvering, <i>Am.</i> maneuvering, propeller) | 38 captain |
| 5 vernier | 24 echo recorder (depth recorder, echograph) | 39 Decca navigation system |
| 6 index mirror | 25 engine telegraph (engine order telegraph) | 40 master station |
| 7 horizon glass (horizon mirror) | 26 controls for the anti-rolling system (for the stabilizers) | 41 slave station |
| 8 telescope | 27 local battery telephone | 42 null hyperbola |
| 9 grip (handgrip) | 28 shipping traffic radio telephone | 43 hyperbolic position line 1 |
| 10-13 radar equipment (radar apparatus) | 29 navigation light indicator panel (running light indicator panel) | 44 hyperbolic position line 2 |
| 10 radar pedestal | 30 microphone for ship's address system | 45 position (fix, ship fix) |
| 11 revolving radar reflector | 31 gyro compass (gyroscopic compass), a compass repeater | 46-53 compasses |
| 12 radar display unit (radar screen) | 32 control button for the ship's siren (ship's fog horn) | 46 liquid compass (fluid compass, spirit compass, wet compass), a magnetic compass |
| 13 radar image (radar picture) | 33 main engine overload indicator | 47 compass card |
| 14-38 wheelhouse | 34 detector indicator unit for fixing the ship's position | 48 lubber's line (lubber's mark, lubber's point) |
| 14 steering and control position | | 49 compass bowl |
| 15 ship's wheel for controlling the rudder mechanism | | 50 gimbal ring |
| 16 helmsman (<i>Am.</i> wheelsman) | | 51-53 gyro compass (gyroscopic compass, gyro compass unit) |
| 17 rudder angle indicator | | 51 master compass (master gyro compass) |
| 18 automatic pilot (autopilot) | | 52 compass repeater (gyro repeater) |
| 19 control lever for the variable-pitch propeller (reversible propeller, feathering propeller, feathering screw) | | 53 compass repeater with pelorus |
| | | 54 patent log (screw log, mechanical log, towing log, taffrail log, speedometer) |



- | | | |
|---|--|---|
| 54 rotator | 74 light and bell buoy | 94 can buoy |
| 55 governor | 75 bell | 95 port hand buoys (port hand marks) [red] |
| 56 log clock | 76 conical buoy | 96 starboard hand buoys (starboard hand marks) [black] |
| 57-67 leads | 77 can buoy | 97 shoals (shallows, shallow water, <i>Am.</i> flats) outside the fairway |
| 58 hand lead | 78 topmark | 98 middle of the fairway (mid-channel) |
| 59 lead (lead sinker) | 79 spar buoy | 99 starboard markers (inverted broom) |
| 60 leadline | 80 topmark buoy | 100 port markers [upward-pointing broom] |
| 61-67 echo sounder (echo sounding machine) | 81 lightship (light vessel) | 101-102 range lights (leading lights) |
| 61 sound transmitter | 82 lantern mast (lantern tower) | 101 lower range light (lower leading light) |
| 62 sound wave (sound impulse) | 83 beam of light | 102 higher range light (higher leading light) |
| 63 echo (sound echo, echo signal) | 84-102 fairway markings (channel markings) | 103 lighthouse |
| 64 echo receiver (hydrophone) | 85 wreck to starboard | 104 radar antenna (radar scanner) |
| 65 echograph (echo sounding machine recorder) | 86 wreck to port | 105 lantern (characteristic light) |
| 66 depth scale | 87 shoals (shallows, shallow water, <i>Am.</i> flats) | 106 radio direction finder (RDF) antenna |
| 67 echogram (depth recording, depth reading) | 88 middle ground to port [beginning of the middle ground; topmark: red cylinder above red ball] | 107 machinery and observation platform (machinery and observation deck) |
| 68-108 sea marks (floating navigational marks) for buoyage and lighting systems | 89 division (bifurcation) | 108 living quarters |
| 68-83 fairway marks (channel marks) | 90 convergence (confluence) [end of the middle ground; topmark: red St. Antony's cross above red ball] | |
| 68 light and whistle buoy | 91 middle ground | |
| 69 light (warning light) | 92 main fairway (main navigable channel) | |
| 70 whistle | 93 secondary fairway (secondary navigable channel) | |
| 71 buoy | | |
| 72 mooring chain | | |
| 73 sinker (mooring sinker) | | |

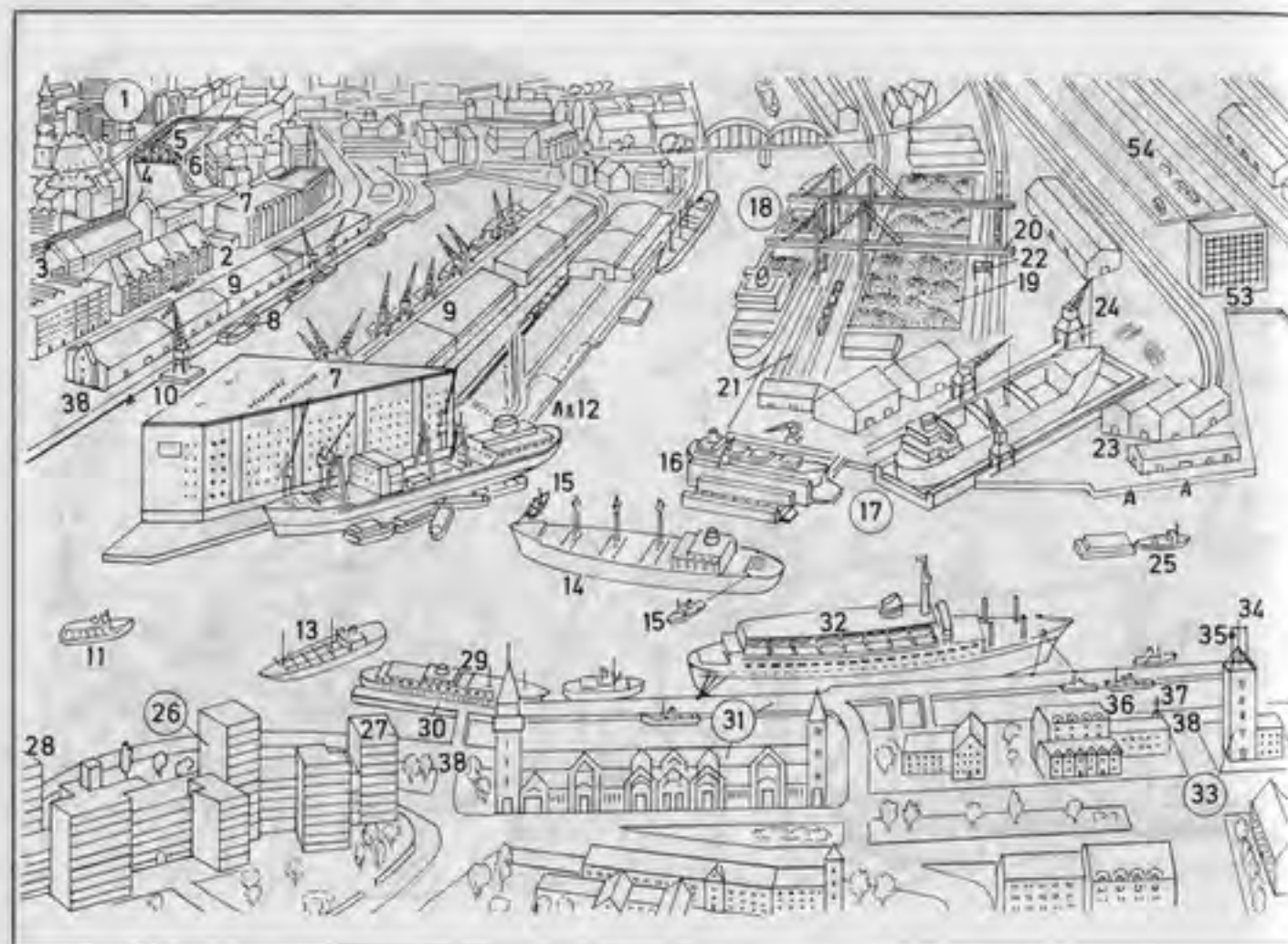

- | | |
|--|---|
| 1 dock area | 21 quayside railway |
| 2 free port (foreign trade zone) | 22 weighing bunker |
| 3 free zone frontier (free zone enclosure) | 23 warehouse |
| 4 customs barrier | 24 quayside crane |
| 5 customs entrance | 25 launch and lighter |
| 6 port custom house | 26 port hospital |
| 7 entrepôt | 27 quarantine wing |
| 8 barge (dumb barge, lighter) | 28 Institute of Tropical Medicine |
| 9 break-bulk cargo transit shed (general cargo transit shed, package cargo transit shed) | 29 excursion steamer (pleasure steamer) |
| 10 floating crane | 30 jetty |
| 11 harbour (Am. harbor) ferry (ferryboat) | 31 passenger terminal |
| 12 fender (dolphin) | 32 liner (passenger liner, ocean liner) |
| 13 bunkering boat | 33 meteorological office, a weather station |
| 14 break-bulk carrier (general cargo ship) | 34 signal mast (signalling mast) |
| 15 tug | 35 storm signal |
| 16 floating dock (pontoon dock) | 36 port administration offices |
| 17 dry dock | 37 tide level indicator |
| 18 coal wharf | 38 quayside road (quayside roadway) |
| 19 coal bunker | 39 roll-on roll-off (ro-ro) system (roll-on roll-off operation) |
| 20 transporter loading bridge | 40 gantry |

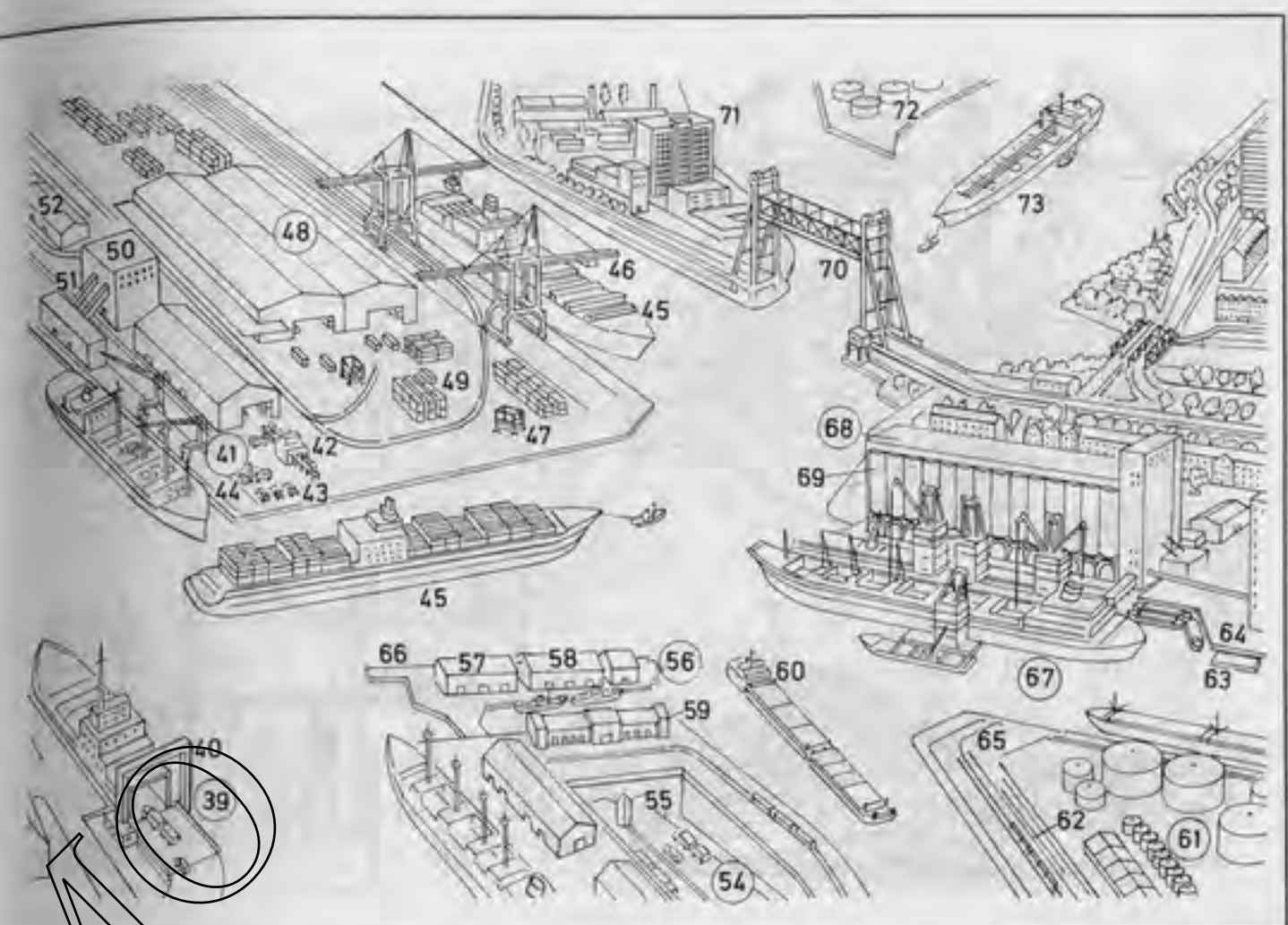

- | | |
|---|------------------------------------|
| 41 truck-to-truck system (truck-to-truck operation) | 61 tank farm |
| 42 foil-wrapped unit loads | 62 railway siding |
| 43 pallets | 63 landing pontoon (landing stage) |
| 44 forklift truck (fork truck, forklift) | 64 quay |
| 45 container ship | 65 breakwater (mole) |
| 46 transporter container-loading bridge | 66 pier (jetty), a quay extension |
| 47 container carrier truck | 67 bulk carrier |
| 48 container terminal (container berth) | 68 silo |
| 49 unit load | 69 silo cylinder |
| 50 cold store | 70 lift bridge |
| 51 conveyor belt (conveyor) | 71 industrial plant |
| 52 fruit storage shed (fruit warehouse) | 72 storage tanks |
| 53 office building | 73 tanker |
| 54 urban motorway (Am. freeway) | |
| 55 harbour (Am. harbor) tunnels | |
| 56 fish dock | |
| 57 fish market | |
| 58 auction room | |
| 59 fish-canning factory | |
| 60 push tow | |

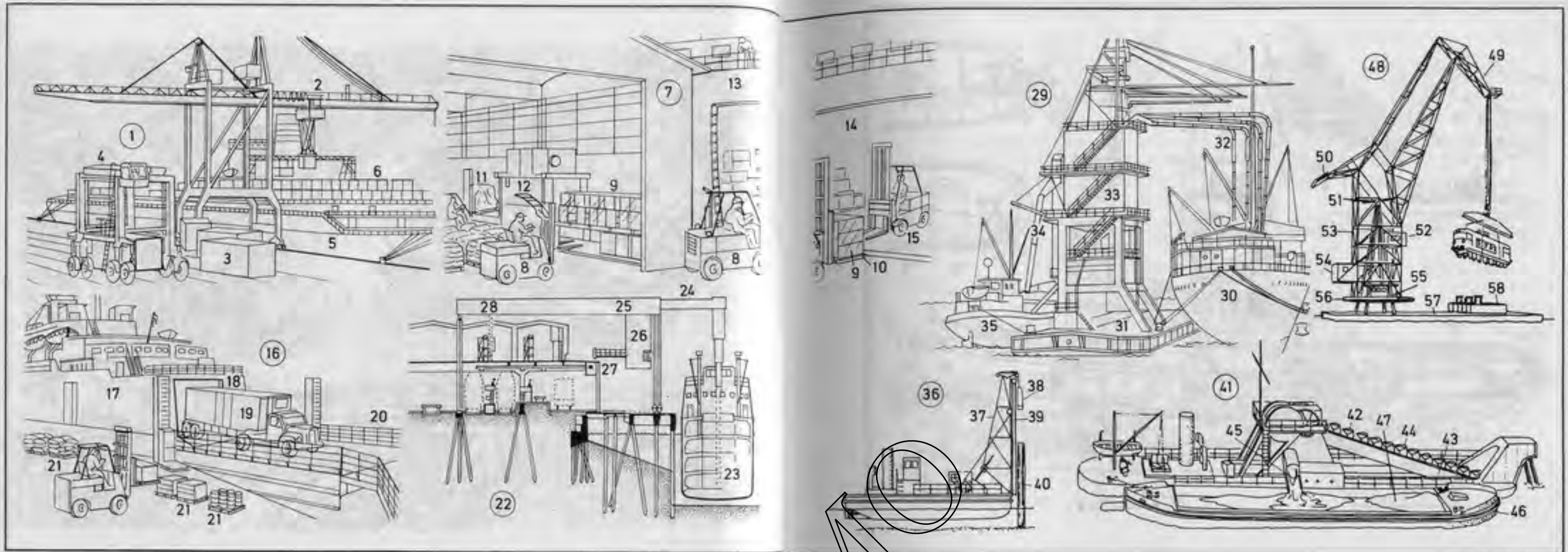

- 1 container terminal (container berth), a modern cargo-handling berth
- 2 transporter container-loading bridge (loading bridge); *sim.*: transtainer crane (transtainer)
- 3 container
- 4 truck (carrier)
- 5 all-container ship
- 6 containers stowed on deck
- 7 truck-to-truck handling (horizontal cargo handling with pallets)
- 8 forklift truck (fork truck, forklift)
- 9 unitized foil-wrapped load (unit load)
- 10 flat pallet, a standard pallet
- 11 unitized break-bulk cargo
- 12 heat sealing machine
- 13 break-bulk carrier (general cargo ship)
- 14 cargo hatchway
- 15 receiving truck on board ship
- 16 multi-purpose terminal

- 17 roll-on roll-off ship (ro-ro-ship)
- 18 stern port (stern opening)
- 19 driven load, a lorry (*Am.* truck)
- 20 ro-ro depot
- 21 unitized load (unitized package)
- 22 banana-handling terminal [section]
- 23 seaward tumbler
- 24 jib
- 25 elevator bridge
- 26 chain sling
- 27 lighting station
- 28 shore-side tumbler for loading trains and lorries (*Am.* trucks)
- 29 bulk cargo handling
- 30 bulk carrier
- 31 floating bulk-cargo elevator
- 32 suction pipes
- 33 receiver
- 34 delivery pipe
- 35 bulk transporter barge
- 36 floating pile driver
- 37 pile driver frame
- 38 pile hammer

- 39 driving guide rail
- 40 pile
- 41 bucket dredger, a dredger
- 42 bucket chain
- 43 bucket ladder
- 44 dredger bucket
- 45 chute
- 46 hopper barge
- 47 spoil
- 48 floating crane
- 49 jib (boom)
- 50 counterweight (counterpoise)
- 51 adjusting spindle
- 52 crane driver's cabin (crane driver's cage)
- 53 crane framework
- 54 winch house
- 55 control platform
- 56 turntable
- 57 pontoon, a pram
- 58 engine superstructure (engine mounting)

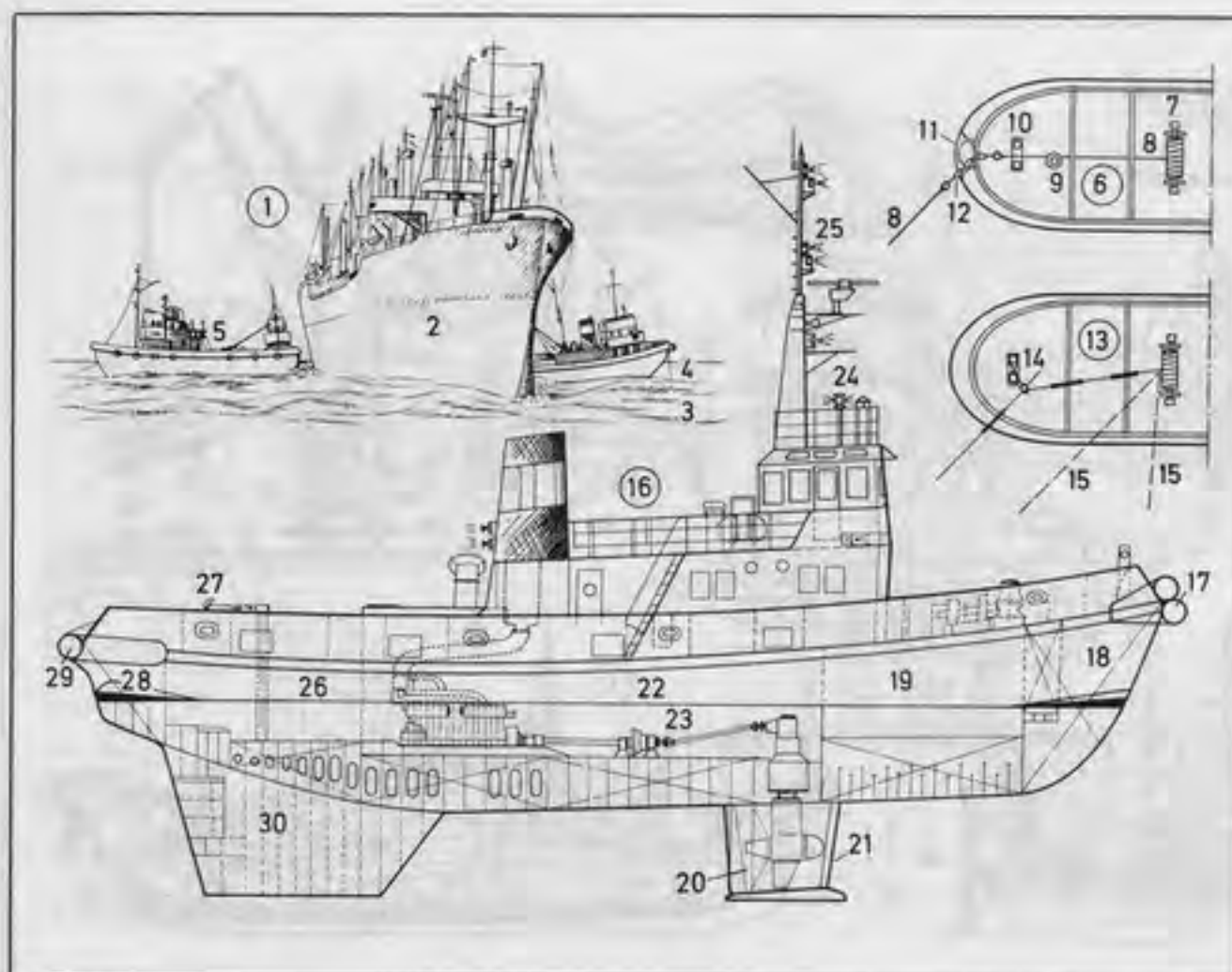

- 1 salvaging (salving) of a ship run aground
- 2 ship run aground (damaged vessel)
- 3 sandbank; *also*: quicksand
- 4 open sea
- 5 tug (salvage tug)
- 6-15 towing gear
- 6 towing gear for towing at sea
- 7 towing winch (towing machine, towing engine)
- 8 tow rope (tow line, towing hawser)
- 9 tow rope guide
- 10 cross-shaped bollard
- 11 hawse hole
- 12 anchor cable (chain cable)
- 13 towing gear for work in harbours (*Am.* harbors)
- 14 guest rope
- 15 position of the tow rope (tow line, towing hawser)
- 16 tug (salvage tug) [vertical elevation]
- 17 bow fender (pudding fender)
- 18 forepeak
- 19 living quarters
- 20 Schottel propeller
- 21 Kort vent
- 22 engine and propeller room
- 23 clutch coupling
- 24 compass platform (compass bridge, compass flat, monkey bridge)
- 25 fire-fighting equipment
- 26 stowage
- 27 tow hook
- 28 afterpeak
- 29 stern fender
- 30 main manoeuvring (*Am.* maneuvering) keel

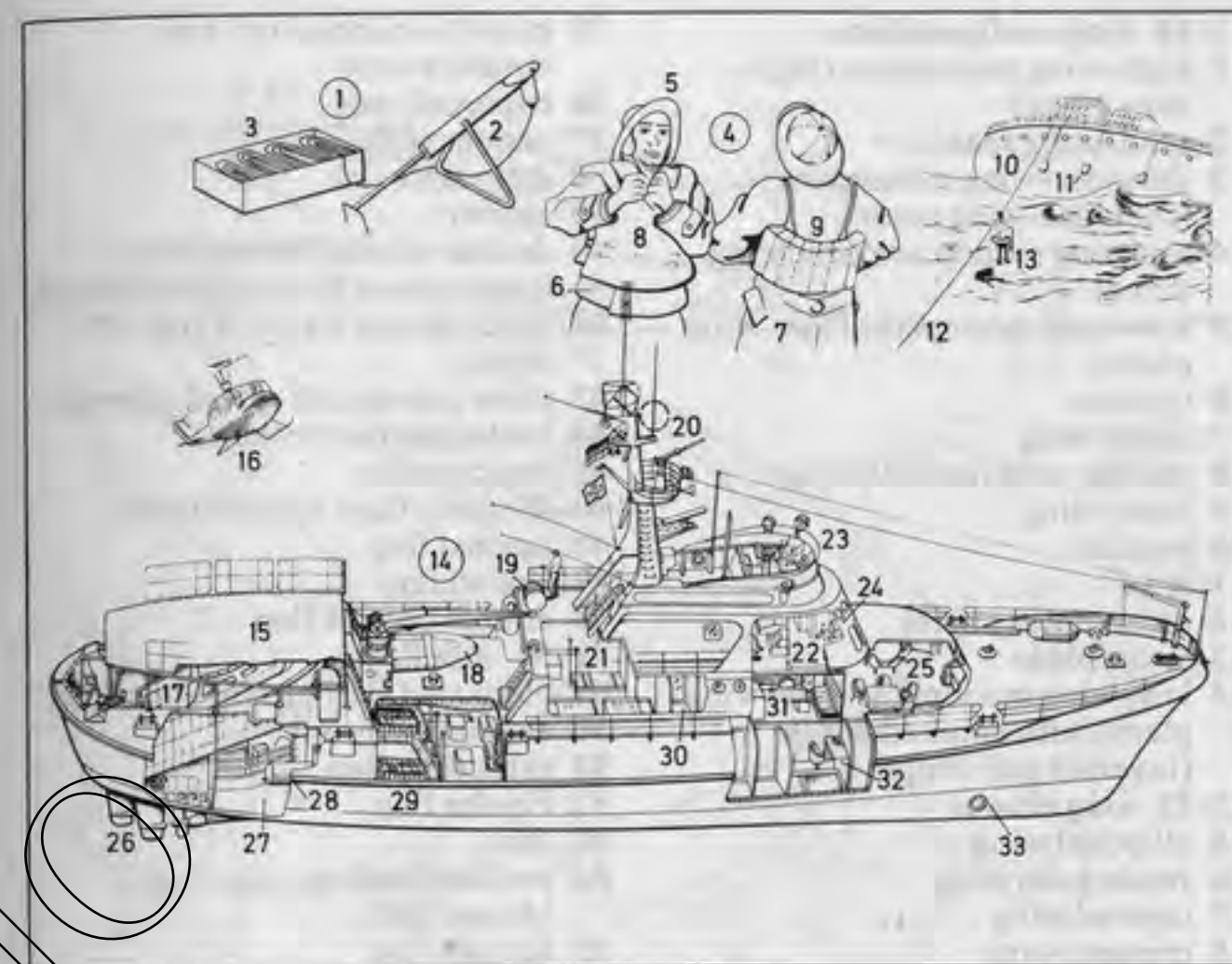

- 1 rocket apparatus (rocket gun, line-throwing gun)
- 2 life rocket (rocket)
- 3 rocket line (whip line)
- 4 oilskins
- 5 sou'wester (southwester)
- 6 oilskin jacket
- 7 oilskin coat
- 8 inflatable life jacket
- 9 cork life jacket (cork life preserver)
- 10 stranded ship (damaged vessel)
- 11 oil bag, for trickling oil on the water surface
- 12 lifeline
- 13 breeches buoy
- 14 rescue cruiser
- 15 helicopter landing deck
- 16 rescue helicopter
- 17 daughter boat
- 18 inflatable boat (inflatable dinghy)
- 19 life raft
- 20 fire-fighting equipment for fires at sea
- 21 hospital unit with operating cabin and exposure bath
- 22 navigating bridge
- 23 upper tier of navigating bridge
- 24 lower tier of navigating bridge
- 25 messroom
- 26 rudders and propeller (screw)
- 27 stowage
- 28 foam can
- 29 side engines
- 30 shower
- 31 coxswain's cabin
- 32 crew member's single-berth cabin
- 33 bow propeller

- 1-14 wing configurations**
- 1 high-wing monoplane (high-wing plane)
 - 2 span (wing span)
 - 3 shoulder-wing monoplane (shoulder-wing plane)
 - 4 midwing monoplane (midwing plane)
 - 5 low-wing monoplane (low-wing plane)
 - 6 triplane
 - 7 upper wing
 - 8 middle wing (central wing)
 - 9 lower wing
 - 10 biplane
 - 11 strut
 - 12 cross bracing wires
 - 13 sesquiplane
 - 14 low-wing monoplane (low-wing plane) with cranked wings (inverted gull wings)
- 15-22 wing shapes**
- 15 elliptical wing
 - 16 rectangular wing
 - 17 tapered wing
 - 18 crescent wing
 - 19 delta wing
 - 20 swept-back wing with semi-positive sweepback
 - 21 swept-back wing with positive sweepback
 - 22 ogival wing (ogee wing)
- 23-36 tail shapes (tail unit shapes, empennage shapes)**
- 23 normal tail (normal tail unit)
 - 24-25 vertical tail (vertical stabilizer and rudder)
 - 24 vertical stabilizer (vertical fin, tail fin)
 - 25 rudder
 - 26-27 horizontal tail
 - 26 tailplane (horizontal stabilizer)
 - 27 elevator
 - 28 cruciform tail (cruciform tail unit)
 - 29 T-tail (T-tail unit)
 - 30 lobe
 - 31 V-tail (vee-tail, butterfly tail)
 - 32 double tail unit (twin tail unit)
 - 33 end plate
 - 34 double tail unit (twin tail unit) of a twin-boom aircraft

- 35 raised horizontal tail with double booms
- 36 triple tail unit
- 37 system of flaps
- 38 extensible slat
- 39 spoiler
- 40 double-slotted Fowler flap
- 41 outer aileron (low-speed aileron)
- 42 inner spoiler (landing flap, lift dump)
- 43 inner aileron (all-speed aileron)
- 44 brake flap (air brake)
- 45 basic profile
- 46-48 plain flaps (simple flaps)
- 46 normal flap
- 47 slotted flap
- 48 double-slotted flap
- 49-50 split flaps
- 49 plain split flap (simple split flap)
- 50 zap flap
- 51 extending flap
- 52 Fowler flap
- 53 slat
- 54 profiled leading-edge flap (droop flap)
- 55 Krüger flap

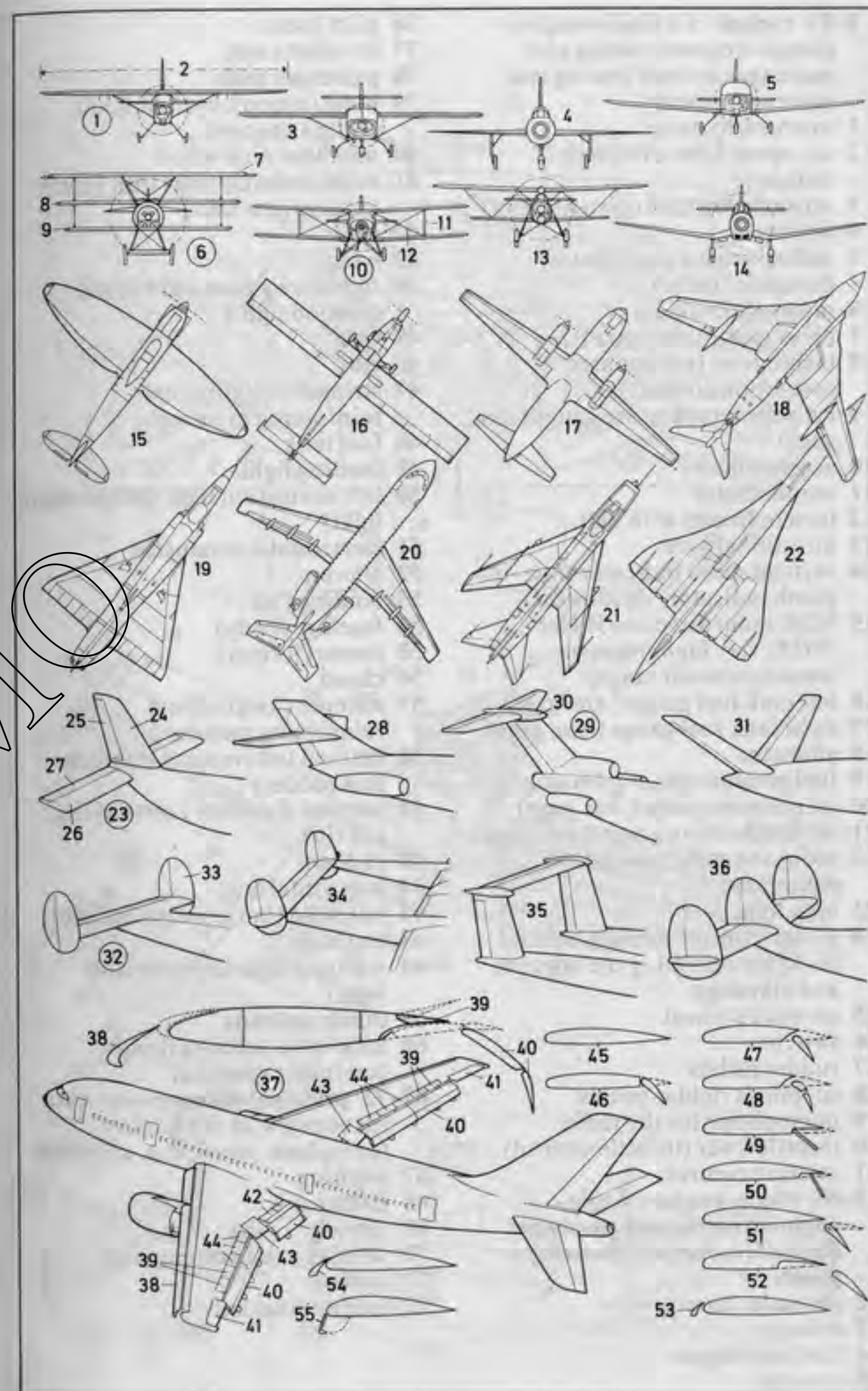

- 1-31 cockpit of a single-engine (single-engined) racing and passenger aircraft (racing and passenger plane)**
- 1 instrument panel
 - 2 air-speed (*Am.* airspeed) indicator
 - 3 artificial horizon (gyro horizon)
 - 4 altimeter
 - 5 radio compass (automatic direction finder)
 - 6 magnetic compass
 - 7 boost gauge (*Am.* gage)
 - 8 tachometer (rev counter, revolution counter)
 - 9 cylinder temperature gauge (*Am.* gage)
 - 10 accelerometer
 - 11 chronometer
 - 12 turn indicator with ball
 - 13 directional gyro
 - 14 vertical speed indicator (rate-of-climb indicator, variometer)
 - 15 VOR radio direction finder [*VOR: very high frequency omnidirectional range*]
 - 16 left tank fuel gauge (*Am.* gage)
 - 17 right tank fuel gauge (*Am.* gage)
 - 18 ammeter
 - 19 fuel pressure gauge (*Am.* gage)
 - 20 oil pressure gauge (*Am.* gage)
 - 21 oil temperature gauge (*Am.* gage)
 - 22 radio and radio navigation equipment
 - 23 map light
 - 24 wheel (control column, control stick) for operating the ailerons and elevators
 - 25 co-pilot's wheel
 - 26 switches
 - 27 rudder pedals
 - 28 co-pilot's rudder pedals
 - 29 microphone for the radio
 - 30 throttle lever (throttle control)
 - 31 mixture control
- 32-66 single-engine (single-engined) racing and passenger aircraft (racing and passenger plane)**
- 32 propeller (airscrew)
 - 33 spinner
 - 34 flat four engine
 - 35 cockpit
 - 36 pilot's seat
 - 37 co-pilot's seat
 - 38 passenger seats
 - 39 hood (canopy, cockpit hood, cockpit canopy)
 - 40 steerable nose wheel
 - 41 main undercarriage unit (main landing gear unit)
 - 42 step
 - 43 wing
 - 44 right navigation light (right position light)
 - 45 spar
 - 46 rib
 - 47 stringer (longitudinal reinforcing member)
 - 48 fuel tank
 - 49 landing light
 - 50 left navigation light (left position light)
 - 51 electrostatic conductor
 - 52 aileron
 - 53 landing flap
 - 54 fuselage (body)
 - 55 frame (former)
 - 56 chord
 - 57 stringer (longitudinal reinforcing member)
 - 58 vertical tail (vertical stabilizer and rudder)
 - 59 vertical stabilizer (vertical fin, tail fin)
 - 60 rudder
 - 61 horizontal tail
 - 62 tailplane (horizontal stabilizer)
 - 63 elevator
 - 64 warning light (anticollision light)
 - 65 dipole antenna
 - 66 long-wire antenna (long-conductor antenna)
- 67-72 principal manoeuvres (*Am.* maneuvers) of the aircraft (aeroplane, plane, *Am.* airplane)**
- 67 pitching
 - 68 lateral axis
 - 69 yawing
 - 70 vertical axis (normal axis)
 - 71 rolling
 - 72 longitudinal axis

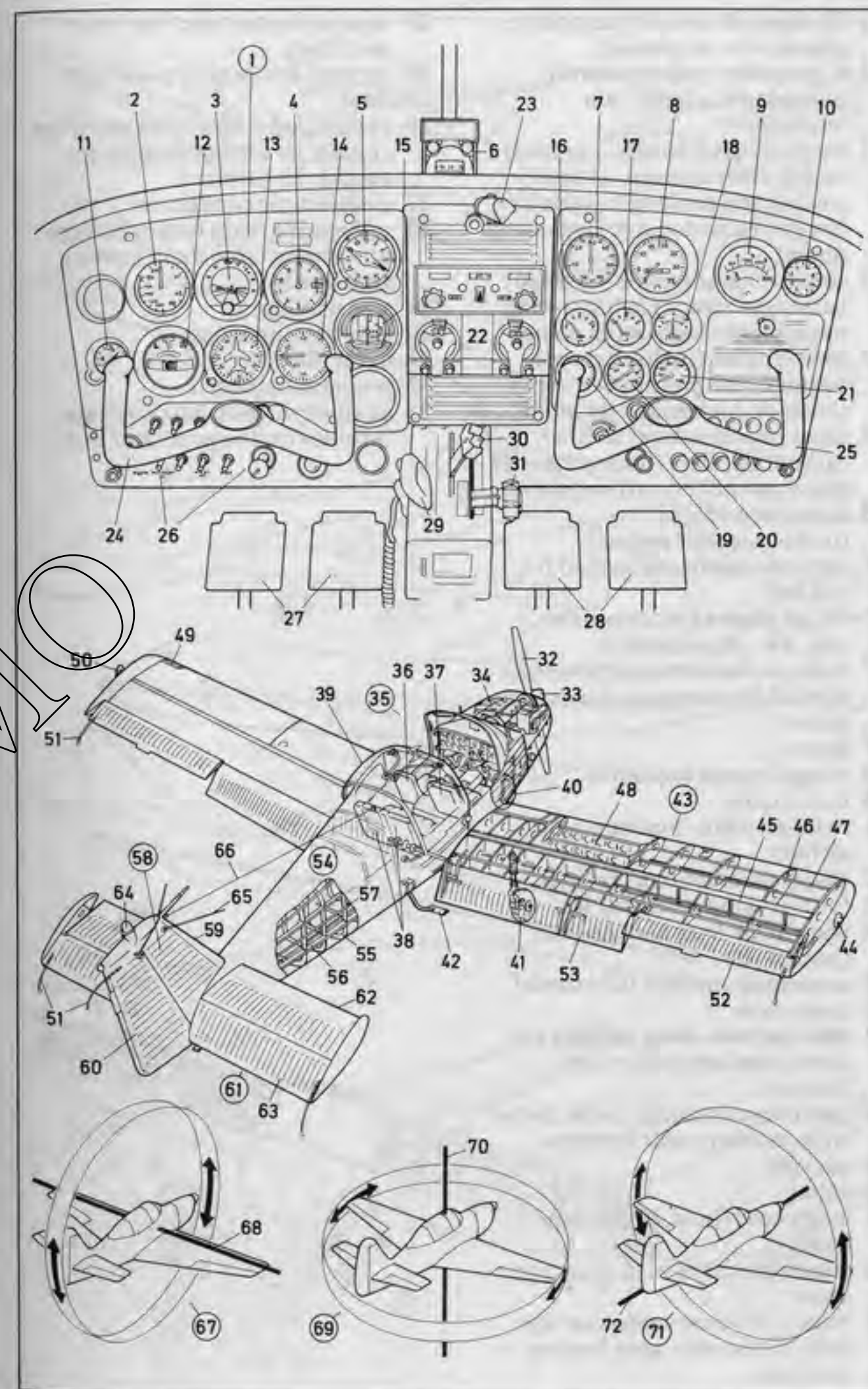

- 1-33 types of aircraft** (aeroplanes, planes, *Am.* airplanes)
- 1-6 propeller-driven aircraft** (aeroplanes, planes, *Am.* airplanes)
- 1** single-engine (single-engined) racing and passenger aircraft (racing and passenger plane), a low-wing monoplane (low-wing plane)
- 2** single-engine (single-engined) passenger aircraft, a high-wing monoplane (high-wing plane)
- 3** twin-engine (twin-engined) business and passenger aircraft (business and passenger plane)
- 4** short/medium haul airliner, a turboprop plane (turbopropeller plane, propeller-turbine plane)
- 5** turboprop engine (turbopropeller engine)
- 6** vertical stabilizer (vertical fin, tail fin)
- 7-33 jet planes** (jet aeroplanes, jets, *Am.* jet airplanes)
- 7** twin-jet business and passenger aircraft (business and passenger plane)
- 8** fence
- 9** wing-tip tank (tip tank)
- 10** rear engine
- 11** twin-jet short/medium haul airliner
- 12** tri-jet medium haul airliner
- 13** four-jet long haul airliner
- 14** wide-body long haul airliner (jumbo jet)
- 15** supersonic airliner [*Concorde*]
- 16** droop nose
- 17** twin-jet wide-body airliner for short/medium haul routes (airbus)
- 18** radar nose (radome, radar dome) with weather radar antenna
- 19** cockpit
- 20** galley
- 21** cargo hold (hold, underfloor hold)
- 22** passenger cabin with passenger seats
- 23** retractable nose undercarriage unit (retractable nose landing gear unit)
- 24** nose undercarriage flap (nose gear flap)
- 25** centre (*Am.* center) passenger door
- 26** engine pod with engine (turbojet engine, jet turbine engine, jet engine, jet turbine)
- 27** electrostatic conductors
- 28** retractable main undercarriage unit (retractable main landing gear unit)
- 29** side window
- 30** rear passenger door
- 31** toilet (lavatory, WC)
- 32** pressure bulkhead
- 33** auxiliary engine (auxiliary gas turbine) for the generator unit

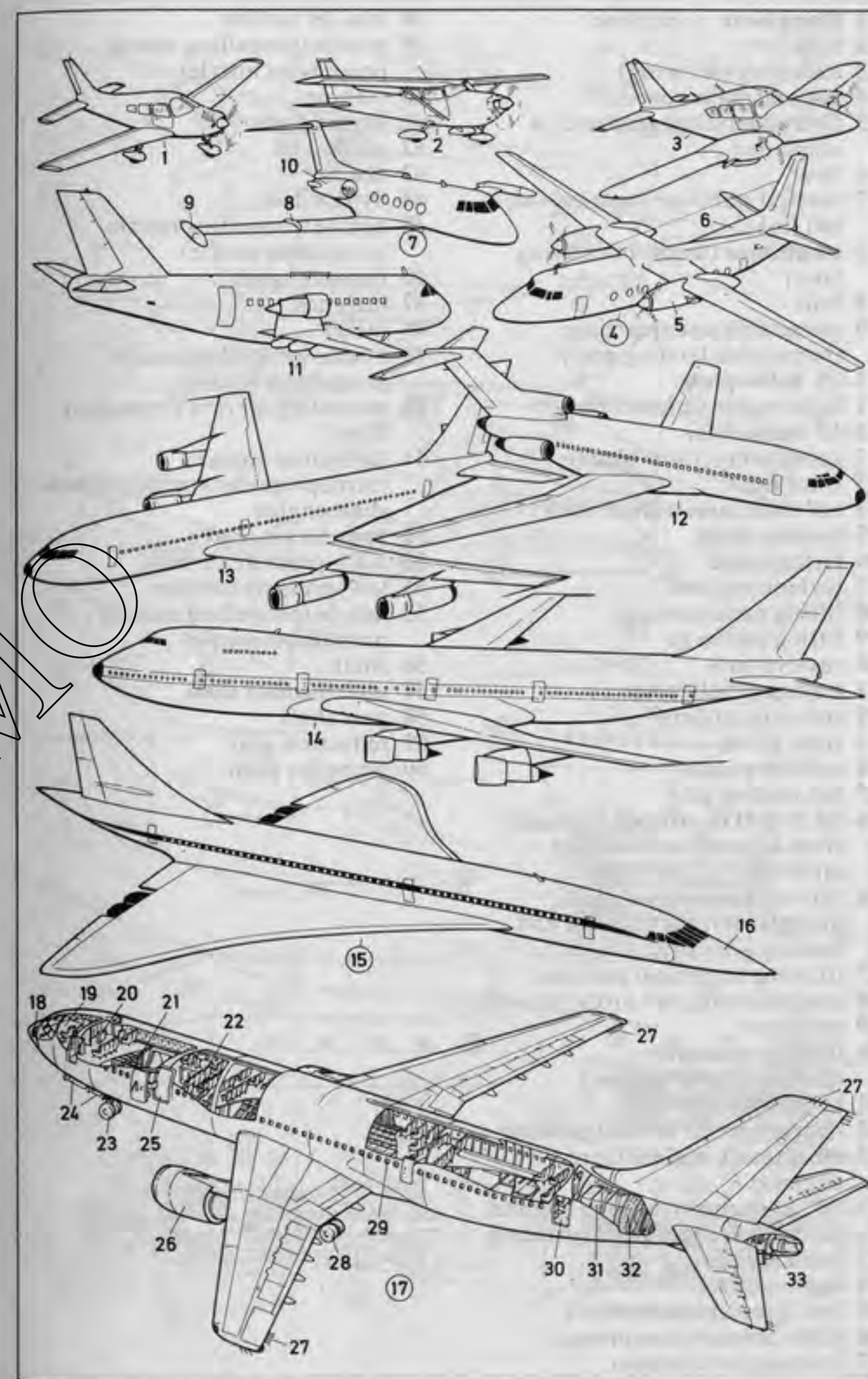

- 1 flying boat, a seaplane
- 2 hull
- 3 stub wing (sea wing)
- 4 tail bracing wires
- 5 floatplane (float seaplane), a seaplane
- 6 float
- 7 vertical stabilizer (vertical fin, tail fin)
- 8 amphibian (amphibian flying boat)
- 9 hull
- 10 retractable undercarriage (retractable landing gear)
- 11-25 helicopters
- 11 light multirole helicopter
- 12-13 main rotor
- 12 rotary wing (rotor blade)
- 13 rotor head
- 14 tail rotor (anti-torque rotor)
- 15 landing skids
- 16 flying crane
- 17 turbine engines
- 18 lifting undercarriage
- 19 lifting platform
- 20 reserve tank
- 21 transport helicopter
- 22 rotors in tandem
- 23 rotor pylon
- 24 turbine engine
- 25 tail loading gate
- 26-32 V/STOL aircraft (vertical/short take-off and landing aircraft)
- 26 tilt-wing aircraft, a VTOL aircraft (vertical take-off and landing aircraft)
- 27 tilt wing in vertical position
- 28 contrarotating tail propellers
- 29 gyrodyne
- 30 turboprop engine (turbopropeller engine)
- 31 convertiplane
- 32 tilting rotor in vertical position
- 33-60 aircraft engines (aero engines)
- 33-50 jet engines (turbojet engines, jet turbine engines, jet turbines)
- 33 front fan-jet
- 34 fan
- 35 low-pressure compressor
- 36 high-pressure compressor
- 37 combustion chamber

- 38 fan-jet turbine
- 39 nozzle (propelling nozzle, propulsion nozzle)
- 40 turbines
- 41 bypass duct
- 42 aft fan-jet
- 43 fan
- 44 bypass duct
- 45 nozzle (propelling nozzle, propulsion nozzle)
- 46 bypass engine
- 47 turbines
- 48 mixer
- 49 nozzle (propelling nozzle, propulsion nozzle)
- 50 secondary air flow (bypass air flow)
- 51 turboprop engine (turbopropeller engine), a twin-shaft engine
- 52 annular air intake
- 53 high-pressure turbine
- 54 low-pressure turbine
- 55 nozzle (propelling nozzle, propulsion nozzle)
- 56 shaft
- 57 intermediate shaft
- 58 gear shaft
- 59 reduction gear
- 60 propeller shaft

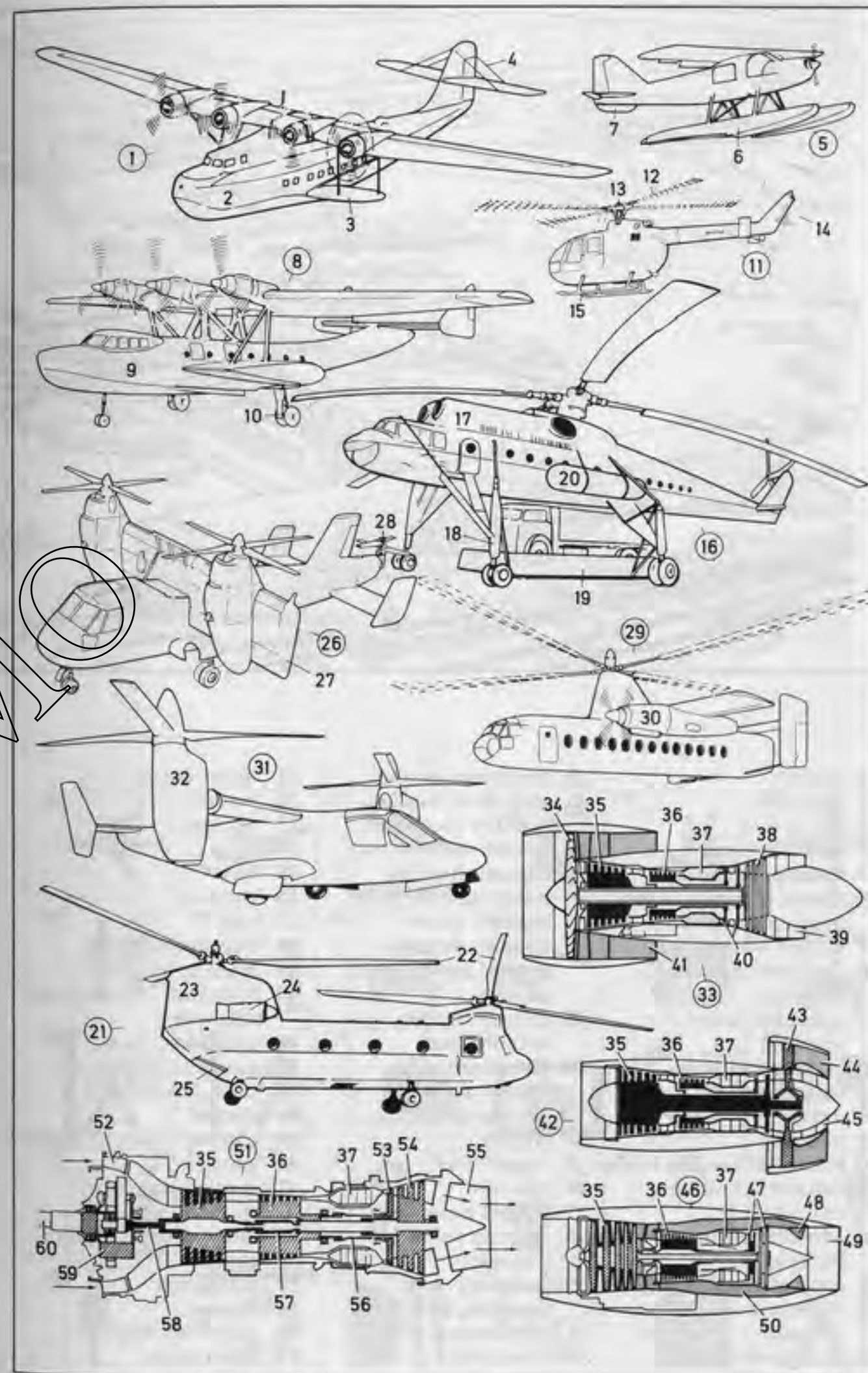



- | | | |
|---|---|---------------------------------------|
| 1 runway | 20 spectators' terrace | 31 'information' |
| 2 taxiway | 21 aircraft in loading position (nosed in) | 32 'taxis' |
| 3 apron | 22 service vehicles, e.g. baggage loaders, water tankers, galley loaders, toilet-cleaning vehicles, ground power units, tankers | 33 'car hire' |
| 4 apron taxiway | 23 aircraft tractor (aircraft tug) | 34 'trains' |
| 5 baggage terminal | 24-53 airport information symbols (pictographs) | 35 'buses' |
| 6 tunnel entrance to the baggage terminal | 24 'airport' | 36 'entrance' |
| 7 airport fire service | 25 'departures' | 37 'exit' |
| 8 fire appliance building | 26 'arrivals' | 38 'baggage retrieval' |
| 9 mail and cargo terminal | 27 'transit passengers' | 39 'luggage lockers' |
| 10 cargo warehouse | 28 'waiting room' ('lounge') | 40 'telephone - emergency calls only' |
| 11 assembly point | 29 'assembly point' ('meeting point', 'rendezvous point') | 41 'emergency exit' |
| 12 pier | 30 'spectators' terrace' | 42 'passport check' |
| 13 pierhead | | 43 'press facilities' |
| 14 passenger loading bridge | | 44 'doctor' |
| 15 departure building (terminal) | | 45 'chemist' (Am. 'druggist') |
| 16 administration building | | 46 'showers' |
| 17 control tower (tower) | | 47 'gentlemen's toilet' ('gentlemen') |
| 18 waiting room (lounge) | | 48 'ladies toilet' ('ladies') |
| 19 airport restaurant | | 49 'chapel' |
| | | 50 'restaurant' |
| | | 51 'change' |
| | | 52 'duty free shop' |
| | | 53 'hairdresser' |



- 1 Saturn V 'Apollo' booster (booster rocket) [overall view]
- 2 Saturn V 'Apollo' booster (booster rocket) [overall sectional view]
- 3 first rocket stage (S-IC)
- 4 F-1 engines
- 5 heat shield (thermal protection shield)
- 6 aerodynamic engine fairings
- 7 aerodynamic stabilizing fins
- 8 stage separation retro-rockets, 8 rockets arranged in 4 pairs
- 9 kerosene (RP-1) tank [capacity: 811,000 litres]
- 10 liquid oxygen (LOX, LO₂) supply lines
- 11 anti-vortex system (device for preventing the formation of vortices in the fuel)
- 12 liquid oxygen (LOX, LO₂) tank [capacity: 1,315,000 litres]
- 13 anti-slosh baffles
- 14 compressed-helium bottles (helium pressure bottles)
- 15 diffuser for gaseous oxygen
- 16 inter-tank connector (inter-tank section)
- 17 instruments and system-monitoring devices
- 18 second rocket stage (S-II)
- 19 J-2 engines
- 20 heat shield (thermal protection shield)
- 21 engine mounts and thrust structure
- 22 acceleration rockets for fuel acquisition
- 23 liquid hydrogen (LH₂) suction line
- 24 liquid oxygen (LOX, LO₂) tank [capacity: 1,315,000 litres]
- 25 standpipe
- 26 liquid hydrogen (LH₂) tank [capacity: 1,020,000 litres]
- 27 fuel level sensor
- 28 work platform (working platform)
- 29 cable duct
- 30 manhole
- 31 S-IC/S-II inter-stage connector (inter-stage section)
- 32 compressed-gas container (gas pressure vessel)
- 33 third rocket stage (S-IVB)
- 34 J-2 engine
- 35 nozzle (thrust nozzle)
- 36 S-II/S-IVB inter-stage connector (inter-stage section)
- 37 four second-stage (S-II) separation retro-rockets
- 38 attitude control rockets
- 39 liquid oxygen (LOX, LO₂) tank [capacity: 77,200 litres]
- 40 fuel line duct
- 41 liquid hydrogen (LH₂) tank [capacity: 253,000 litres]
- 42 measuring probes
- 43 compressed-helium tanks (helium pressure vessels)
- 44 tank vent
- 45 forward frame section
- 46 work platform (working platform)
- 47 cable duct
- 48 acceleration rockets for fuel acquisition
- 49 aft frame section
- 50 compressed-helium tanks (helium pressure vessels)
- 51 liquid hydrogen (LH₂) line
- 52 liquid oxygen (LOX, LO₂) line
- 53 24-panel instrument unit
- 54 LM hangar (lunar module hangar)
- 55 LM (lunar module)
- 56 Apollo SM (service module), containing supplies and equipment
- 57 SM (service module) main engine
- 58 fuel tank
- 59 nitrogen tetroxide tank
- 60 pressurized gas delivery system
- 61 oxygen tanks
- 62 fuel cells
- 63 manoeuvring (*Am.* maneuvering) rocket assembly
- 64 directional antenna assembly
- 65 space capsule (command section)
- 66 launch phase escape tower

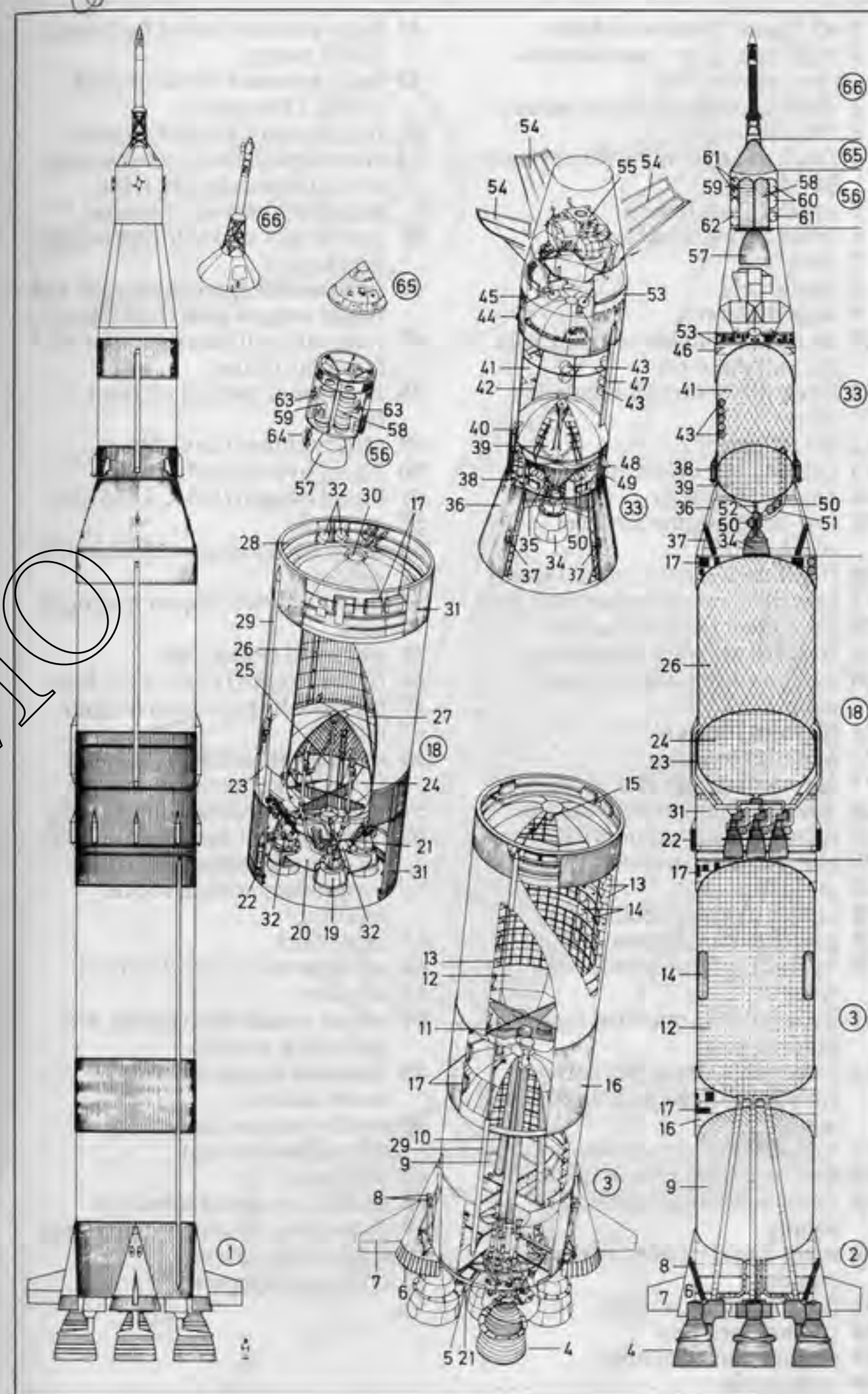

- 1-45 Space Shuttle-Orbiter**
- 1 twin-spar (two-spar, double-spar) vertical fin
 - 2 engine compartment structure
 - 3 fin post
 - 4 fuselage attachment [of payload bay doors]
 - 5 upper thrust mount
 - 6 lower thrust mount
 - 7 keel
 - 8 heat shield
 - 9 waist longeron
 - 10 integrally machined (integrally milled) main rib
 - 11 integrally stiffened light alloy skin
 - 12 lattice girder
 - 13 payload bay insulation
 - 14 payload bay door
 - 15 low-temperature surface insulation
 - 16 flight deck (crew compartment)
 - 17 captain's seat (commander's seat)
 - 18 pilot's seat (co-pilot's seat)
 - 19 forward pressure bulkhead
 - 20 carbon fibre reinforced nose cone
 - 21 forward fuel tanks
 - 22 avionics consoles
 - 23 automatic flight control panel
 - 24 upward observation windows
 - 25 forward observation windows
 - 26 entry hatch to payload bay
 - 27 air lock
 - 28 ladder to lower deck
 - 29 payload manipulator arm
 - 30 hydraulically steerable nose wheel
 - 31 hydraulically operated main landing gear
 - 32 removable (reusable) carbon fibre reinforced leading edge [of wing]
 - 33 movable elevon sections
 - 34 heat-resistant elevon structure
 - 35 main liquid hydrogen (LH₂) supply
 - 36 main liquid-fuelled rocket engine
 - 37 nozzle (thrust nozzle)
 - 38 coolant feed line
 - 39 engine control system
 - 40 heat shield
 - 41 high-pressure liquid hydrogen (LH₂) pump
 - 42 high-pressure liquid oxygen (LOX, LO₂) pump
 - 43 thrust vector control system
 - 44 electromechanically controlled orbital manoeuvring (*Am.* maneuvering) main engine
 - 45 nozzle fuel tanks (thrust nozzle fuel tanks)
 - 46 jettisonable liquid hydrogen and liquid oxygen tank (fuel tank)
 - 47 integrally stiffened annular rib (annular frame)
 - 48 hemispherical end rib (end frame)
 - 49 aft attachment to Orbiter
 - 50 liquid hydrogen (LH₂) line
 - 51 liquid oxygen (LOX, LO₂) line
 - 52 manhole
 - 53 surge baffle system (slosh baffle system)
 - 54 pressure line to liquid hydrogen tank
 - 55 electrical system bus
 - 56 liquid oxygen (LOX, LO₂) line
 - 57 pressure line to liquid oxygen tank
 - 58 recoverable solid-fuel rocket (solid rocket booster)
 - 59 auxiliary parachute bay
 - 60 compartment housing the recovery parachutes and the forward separation rocket motors
 - 61 cable duct
 - 62 aft separation rocket motors
 - 63 aft skirt
 - 64 swivel nozzle (swivelling, *Am.* swiveling, nozzle)
 - 65 **Spacelab** (space laboratory, space station)
 - 66 multi-purpose laboratory (orbital workshop)
 - 67 astronaut
 - 68 gimbal-mounted telescope
 - 69 measuring instrument platform
 - 70 spaceflight module
 - 71 crew entry tunnel

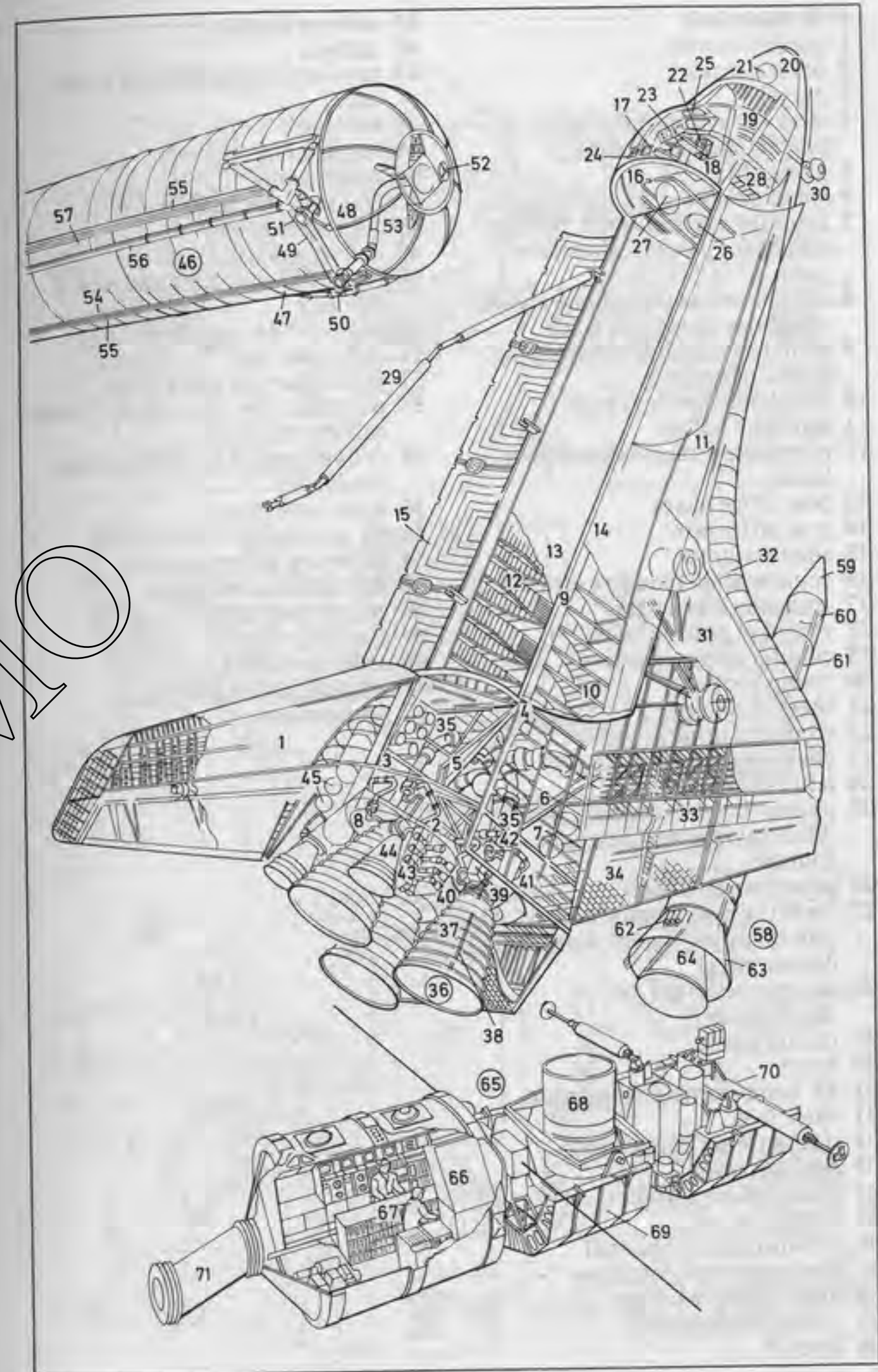

- 1-30 main hall
- 1 parcels counter
 - 2 parcels scales
 - 3 parcel
 - 4 stick-on address label with parcel registration slip
 - 5 glue pot
 - 6 small parcel
 - 7 franking machine (*Am.* postage meter) for parcel registration cards
 - 8 telephone box (telephone booth, telephone kiosk, call box)
 - 9 coin-box telephone (pay phone, public telephone)
 - 10 telephone directory rack
 - 11 directory holder
 - 12 telephone directory (telephone book)
 - 13 post office boxes
 - 14 post office box
 - 15 stamp counter
 - 16 counter clerk (counter officer)
 - 17 company messenger
 - 18 record of posting book
 - 19 counter stamp machine
 - 20 stamp book
 - 21 sheet of stamps
 - 22 security drawer
 - 23 change rack
 - 24 letter scales
 - 25 paying-in (*Am.* deposit), post office savings, and pensions counter
 - 26 accounting machine
 - 27 franking machine for money orders and paying-in slips (*Am.* deposit slips)
 - 28 change machine (*Am.* changemaker)
 - 29 receipt stamp
 - 30 hatch
 - 31-44 letter-sorting installation
 - 31 letter feed
 - 32 stacked letter containers
 - 33 feed conveyor
 - 34 intermediate stacker
 - 35 coding station
 - 36 pre-distributor channel
 - 37 process control computer
 - 38 distributing machine
 - 39 video coding station
 - 40 screen
 - 41 address display
 - 42 address
 - 43 post code (postal code, *Am.* zip code)
 - 44 keyboard
 - 45 handstamp
 - 46 roller stamp
 - 47 franking machine
 - 48 feed mechanism
 - 49 delivery mechanism
 - 50-55 postal collection and delivery
 - 50 postbox (*Am.* mailbox)
 - 51 collection bag
 - 52 post office van (mail van)
 - 53 postman (*Am.* mail carrier, letter carrier, mailman)
 - 54 delivery pouch (postman's bag, mailbag)
 - 55 letter-rate item
 - 56-60 postmarks
 - 56 postmark advertisement
 - 57 date stamp postmark
 - 58 charge postmark
 - 59 special postmark
 - 60 roller postmark
 - 61 stamp (postage stamp)
 - 62 perforations

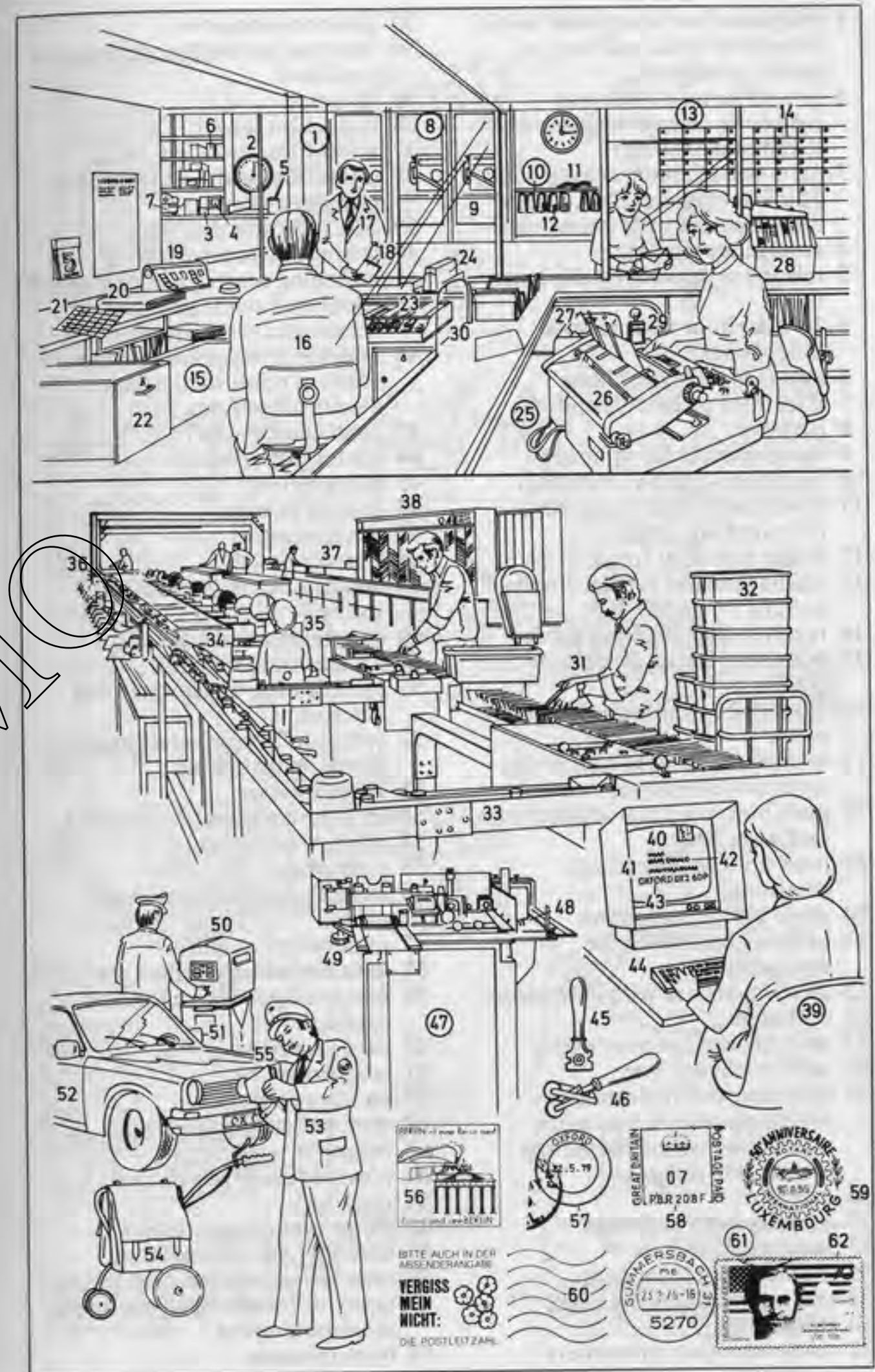

- 1 telephone box (telephone booth, telephone kiosk, call box), a public telephone
- 2 telephone user (*with own telephone*: telephone subscriber, telephone customer)
- 3 coin-box telephone (pay phone, public telephone) for local and long-distance calls (trunk calls)
- 4 emergency telephone
- 5 telephone directory (telephone book)
- 6-26 telephone instruments (telephones)
- 6 standard table telephone
- 7 telephone receiver (handset)
- 8 earpiece
- 9 mouthpiece (microphone)
- 10 dial (push-button keyboard)
- 11 finger plate (dial finger plate, dial wind-up plate)
- 12 finger stop (dial finger stop)
- 13 cradle (handset cradle, cradle switch)
- 14 receiver cord (handset cord)
- 15 telephone casing (telephone cover)
- 16 subscriber's (customer's) private meter
- 17 switchboard (exchange) for a system of extensions
- 18 push button for connecting main exchange lines
- 19 push buttons for calling extensions
- 20 push-button telephone
- 21 earthing button for the extensions
- 22-26 switchboard with extensions
- 22 exchange
- 23 switchboard operator's set
- 24 main exchange line
- 25 switching box (automatic switching system, automatic connecting system, switching centre, *Am. center*)
- 26 extension
- 27-41 telephone exchange
- 27 fault repair service
- 28 maintenance technician
- 29 testing board (testing desk)
- 30 telegraphy
- 31 teleprinter (teletypewriter)
- 32 paper tape
- 33 directory enquiries
- 34 information position (operator's position)
- 35 operator
- 36 microfilm reader
- 37 microfilm file
- 38 microfilm card with telephone numbers
- 39 date indicator display
- 40 testing and control station
- 41 switching centre (*Am. center*) for telephone, telex, and data transmission services
- 42 selector, a motor uniselector made of noble metals; *sim.*: electronic selector
- 43 contact arc (bank)
- 44 contact arm (wiper)
- 45 contact field
- 46 contact arm tag
- 47 electromagnet
- 48 selector motor
- 49 restoring spring (resetting spring)
- 50 communication links
- 51-52 satellite radio link
- 51 earth station with directional antenna
- 52 communications satellite with directional antenna
- 53 coastal station
- 54-55 intercontinental radio link
- 54 short-wave station
- 55 ionosphere
- 56 submarine cable (deep-sea cable)
- 57 underwater amplifier
- 58 data transmission (data services)
- 59 input/output device for data carriers
- 60 data processor
- 61 teleprinter
- 62-64 data carriers
- 62 punched tape (punch tape)
- 63 magnetic tape
- 64 punched card (punch card)
- 65 telex link
- 66 teleprinter (page printer)
- 67 dialling (*Am. dialing*) unit
- 68 telex tape (punched tape, punch tape) for transmitting the text at maximum speed
- 69 telex message
- 70 keyboard

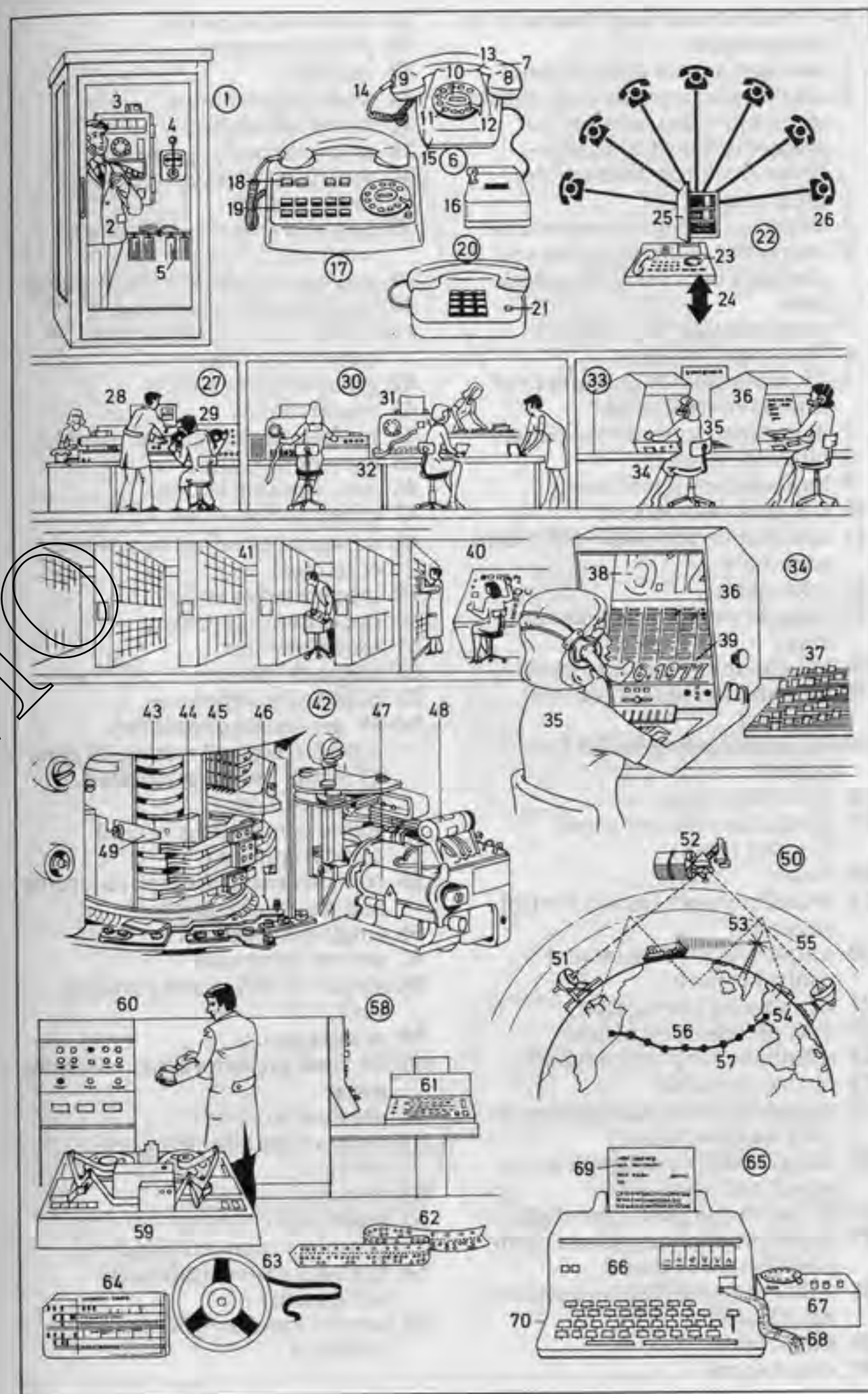

- 1-6 central recording channel of a radio station**
- 1 monitoring and control panel
 - 2 data display terminal (video data terminal, video monitor) for visual display of computer-controlled programmes (*Am.* programs)
 - 3 amplifier and mains power unit
 - 4 magnetic sound recording and playback deck for $\frac{1}{4}$ " magnetic tape
 - 5 magnetic tape, a $\frac{1}{4}$ " tape
 - 6 film spool holder
- 7-15 radio switching centre (*Am.* center) control room**
- 7 monitoring and control panel
 - 8 talkback speaker
 - 9 local-battery telephone
 - 10 talkback microphone
 - 11 data display terminal (video data terminal)
 - 12 teleprinter
 - 13 input keyboard for computer data
 - 14 telephone switchboard panel
 - 15 monitoring speaker (control speaker)
- 16-26 broadcasting centre (*Am.* center)**
- 16 recording room
 - 17 production control room (control room)
 - 18 studio
 - 19 sound engineer (sound control engineer)
 - 20 sound control desk (sound control console)
 - 21 newsreader (newscaster)
 - 22 duty presentation officer
 - 23 telephone for phoned reports
 - 24 record turntable
 - 25 recording room mixing console (mixing desk, mixer)
 - 26 sound technician (sound mixer, sound recordist)
- 27-53 television post-sync studio**
- 27 sound production control room (sound control room)
 - 28 dubbing studio (dubbing theatre, *Am.* theater)
 - 29 studio table
 - 30 visual signal
 - 31 electronic stopclock
 - 32 projection screen
 - 33 monitor
 - 34 studio microphone
 - 35 sound effects box
 - 36 microphone socket panel
 - 37 recording speaker (recording loudspeaker)
 - 38 control room window (studio window)
 - 39 producer's talkback microphone
 - 40 local-battery telephone
 - 41 sound control desk (sound control console)
 - 42 group selector switch
 - 43 visual display
 - 44 limiter display (clipper display)
 - 45 control modules
 - 46 pre-listening buttons
 - 47 slide control
 - 48 universal equalizer (universal corrector)
 - 49 input selector switch
 - 50 pre-listening speaker
 - 51 tone generator
 - 52 talkback speaker
 - 53 talkback microphone
- 54-59 pre-mixing room for transferring and mixing 16 mm, 17.5 mm, 35 mm perforated magnetic film**
- 54 sound control desk (sound control console)
 - 55 compact magnetic tape recording and playback equipment
 - 56 single playback deck
 - 57 central drive unit
 - 58 single recording and playback deck
 - 59 rewind bench
- 60-65 final picture quality checking room**
- 60 preview monitor
 - 61 programme (*Am.* program) monitor
 - 62 stopclock
 - 63 vision mixer (vision-mixing console, vision-mixing desk)
 - 64 talkback system (talkback equipment)
 - 65 camera monitor (picture monitor)

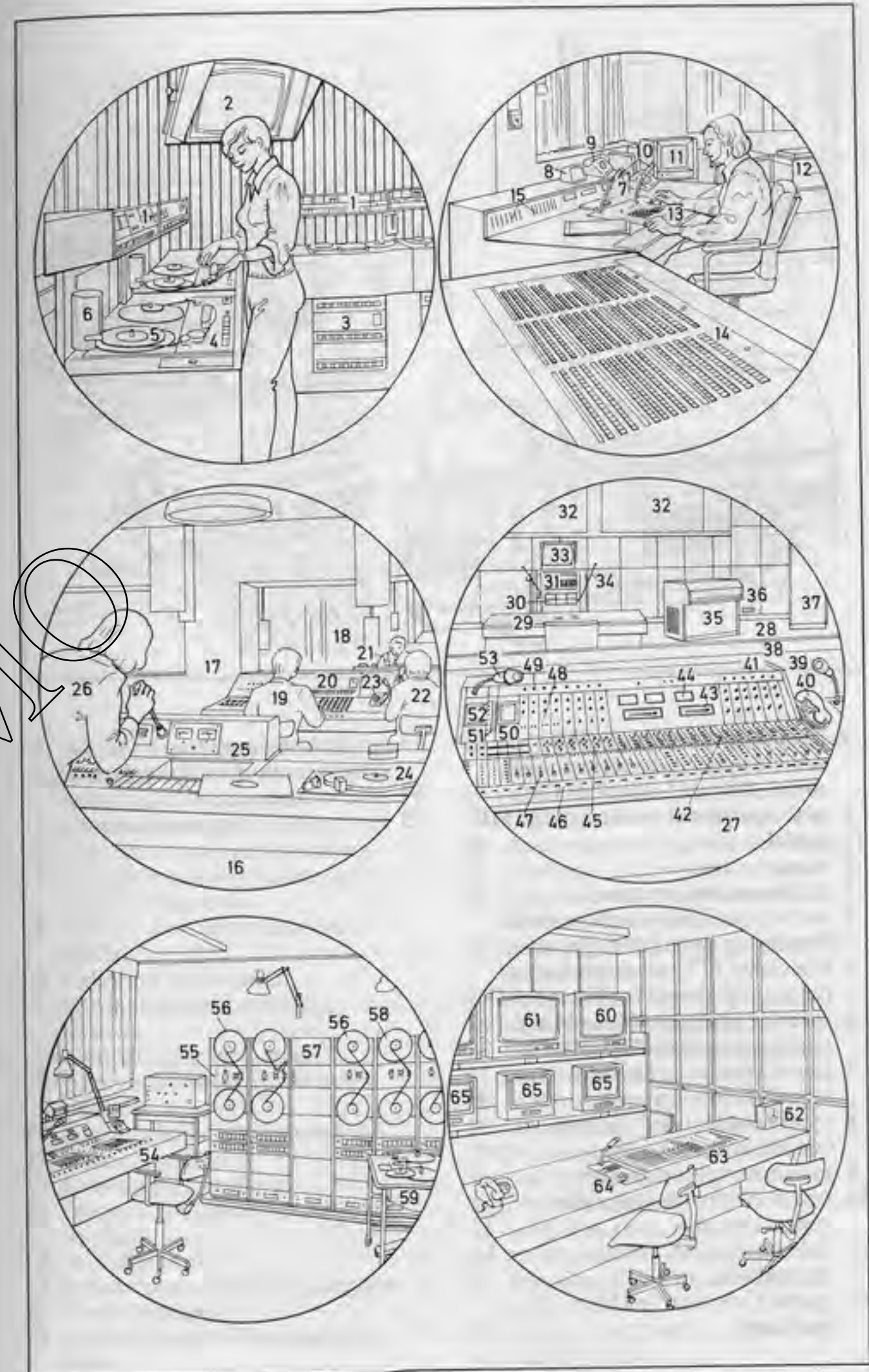

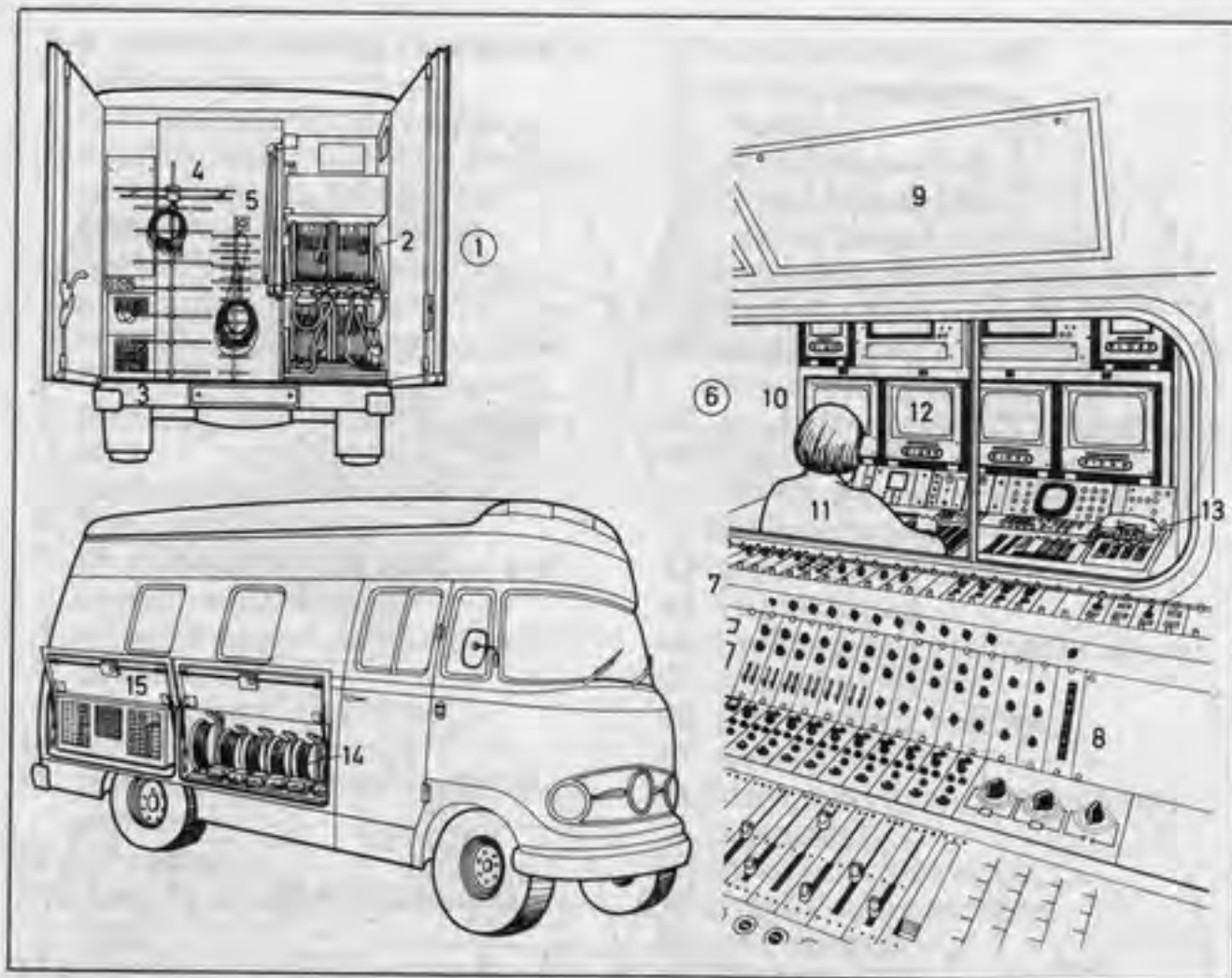

- 1-15 outside broadcast (OB) vehicle** (television OB van; also: sound OB van, radio OB van)
- 1 rear equipment section of the OB vehicle**
- 2 camera cable**
- 3 cable connection panel**
- 4 television (TV) reception aerial** (receiving aerial) for Channel I
- 5 television (TV) reception aerial** (receiving aerial) for Channel II
- 6 interior equipment (on-board equipment) of the OB vehicle**
- 7 sound production control room** (sound control room)
- 8 sound control desk** (sound control console)
- 9 monitoring loudspeaker**
- 10 vision control room** (video control room)
- 11 video controller** (vision controller)
- 12 camera monitor** (picture monitor)

- 13 on-board telephone** (intercommunication telephone)
- 14 microphone cable**
- 15 air-conditioning equipment**

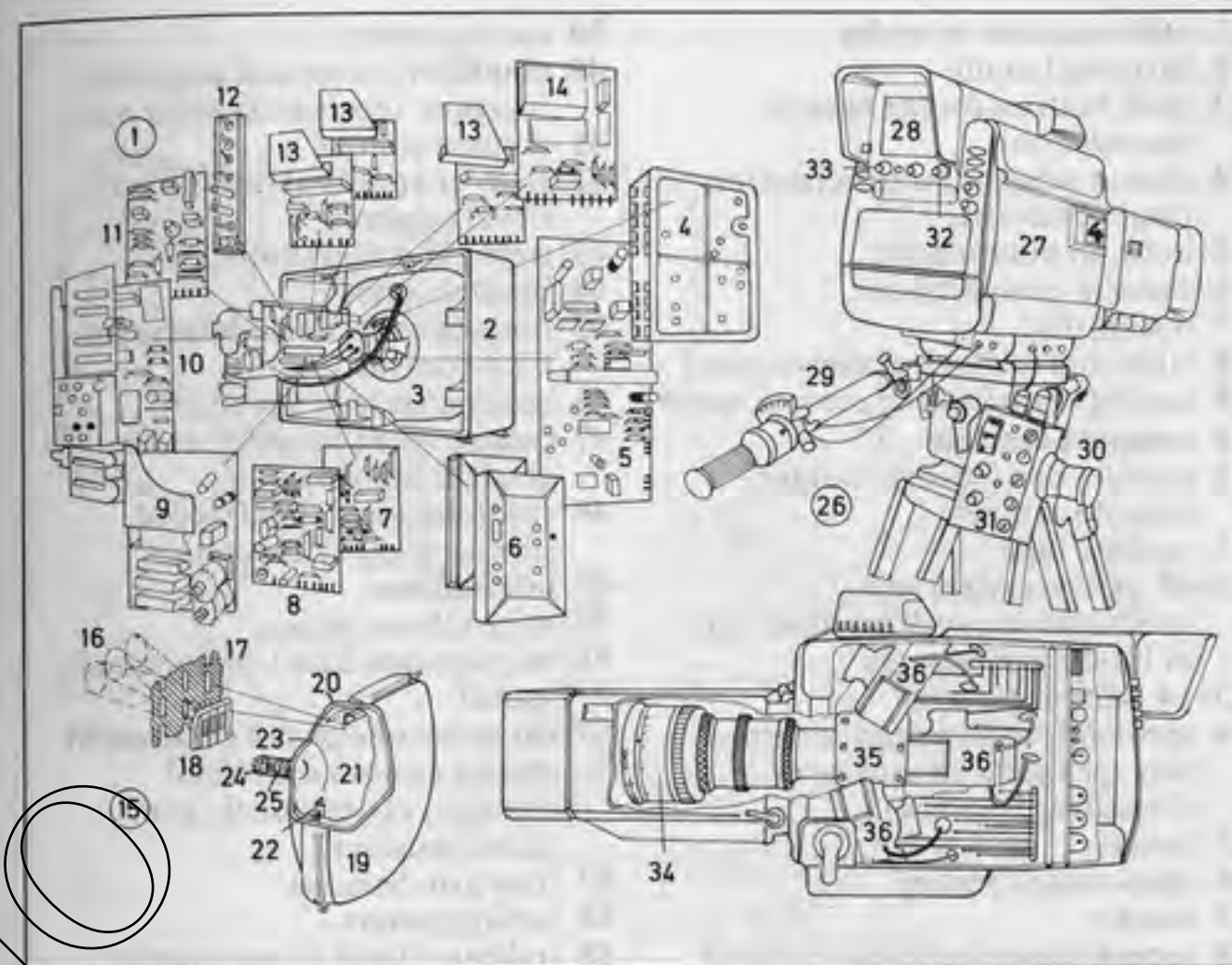

- 1 colour (Am. color) television (TV) receiver** (colour television set) of modular design
- 2 television cabinet**
- 3 television tube** (picture tube)
- 4 IF (intermediate frequency) amplifier module**
- 5 colour (Am. color) decoder module**
- 6 VHF and UHF tuner**
- 7 horizontal synchronizing module**
- 8 vertical deflection module**
- 9 horizontal linearity control module**
- 10 horizontal deflection module**
- 11 control module**
- 12 convergence module**
- 13 colour (Am. color) output stage module**
- 14 sound module**
- 15 colour (Am. color) picture tube**
- 16 electron beams**
- 17 shadow mask with elongated holes**

- 18 strip of fluorescent (luminescent, phosphorescent) material**
- 19 coating (film) of fluorescent material**
- 20 inner magnetic screen (screening)**
- 21 vacuum**
- 22 temperature-compensated shadow mask mount**
- 23 centring (centering) ring for the deflection system**
- 24 electron gun assembly**
- 25 rapid heat-up cathode**
- 26 television (TV) camera**
- 27 camera head**
- 28 camera monitor**
- 29 control arm** (control lever)
- 30 focusing adjustment**
- 31 control panel**
- 32 contrast control**
- 33 brightness control**
- 34 zoom lens**
- 35 beam-splitting prism** (beam splitter)
- 36 pickup unit** (colour, Am. color, pickup tube)

- 1 radio cassette recorder
- 2 carrying handle
- 3 push buttons for the cassette recorder unit
- 4 station selector buttons (station preset buttons)
- 5 built-in microphone
- 6 cassette compartment
- 7 tuning dial
- 8 slide control [for volume or tone]
- 9 tuning knob (tuning control, tuner)
- 10 compact cassette
- 11 cassette box (cassette holder, cassette cabinet)
- 12 cassette tape
- 13-48 stereo system (also: quadraphonic system) made up of Hi-Fi components
- 13-14 stereo speakers
- 14 speaker (loudspeaker), a three-way speaker with crossover (crossover network)
- 15 tweeter
- 16 mid-range speaker
- 17 woofer
- 18 record player (automatic record changer, auto changer)
- 19 record player housing (record player base)
- 20 turntable
- 21 tone arm
- 22 counterbalance (counterweight)
- 23 gimbal suspension
- 24 stylus pressure control (stylus force control)
- 25 anti-skate control
- 26 magnetic cartridge with (conical or elliptical) stylus, a diamond
- 27 tone arm lock
- 28 tone arm lift
- 29 speed selector (speed changer)
- 30 starter switch
- 31 treble control
- 32 dust cover
- 33 stereo cassette deck
- 34 cassette compartment
- 35-36 recording level meters (volume unit meters, VU meters)
- 35 left-channel recording level meter
- 36 right-channel recording level meter
- 37 tuner
- 38 VHF (FM) station selector buttons
- 39 tuning meter
- 40 amplifier; tuner and amplifier together: receiver (control unit)
- 41 volume control
- 42 four-channel balance control (level control)
- 43 treble and bass tuning
- 44 input selector
- 45 four-channel demodulator for CD4 records
- 46 quadra/stereo converter
- 47 cassette box (cassette holder, cassette cabinet)
- 48 record storage slots (record storage compartments)
- 49 microphone
- 50 microphone screen
- 51 microphone base (microphone stand)
- 52 three-in-one stereo component system (automatic record changer, cassette deck, and stereo receiver)
- 53 tone arm balance
- 54 tuning meters
- 55 indicator light for automatic FeO/CrO₂ tape switch-over
- 56 open-reel-type recorder, a two or four-track unit
- 57 tape reel (open tape reel)
- 58 open-reel tape (recording tape, 1/4" tape)
- 59 sound head housing with erasing head (erase head), recording head, and reproducing head (or: combined head)
- 60 tape deflector roller and end switch (limit switch)
- 61 recording level meter (VU meter)
- 62 tape speed selector
- 63 on/off switch
- 64 tape counter
- 65 stereo microphone sockets (stereo microphone jacks)
- 66 headphones (headset)
- 67 padded headband (padded headpiece)
- 68 membrane
- 69 earcups (earphones)
- 70 headphone cable plug, a standard multi-pin plug
- 71 headphone cable (headphone cord)

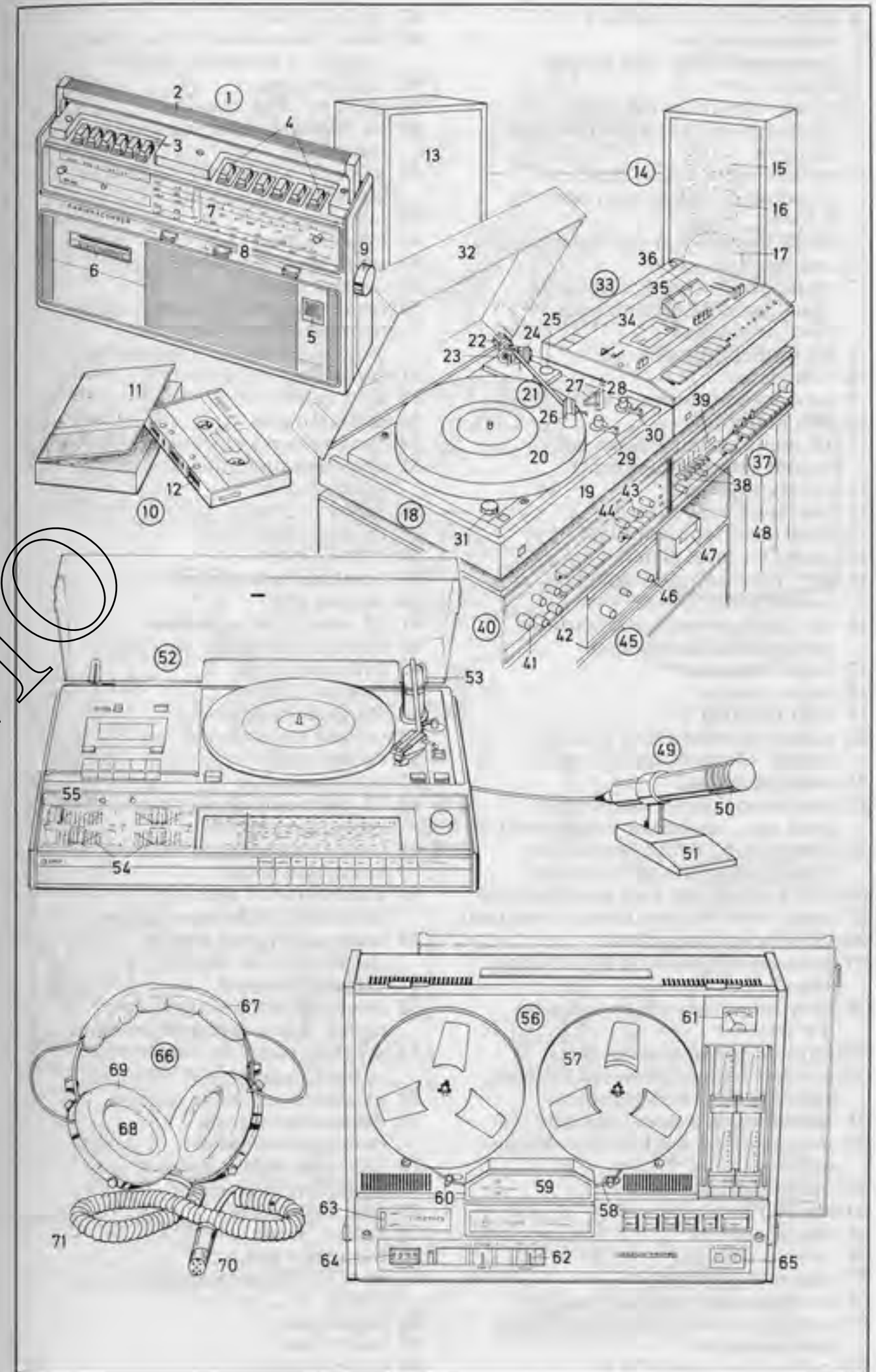

- 1 group instruction using a teaching machine
- 2 instructor's desk with central control unit
- 3 master control panel with individual displays and cross total counters
- 4 student input device (student response device) in the hand of a student
- 5 study step counter (progress counter)
- 6 overhead projector
- 7 apparatus for producing audio-visual learning programmes (Am. programs)
- 8-10 frame coding device
- 8 film viewer
- 9 memory unit (storage unit)
- 10 film perforator
- 11-14 audio coding equipment (sound coding equipment)
- 11 coding keyboard
- 12 two-track tape recorder
- 13 four-track tape recorder
- 14 recording level meter
- 15 PIP (programmed individual presentation) system
- 16 AV (audio-visual) projector for programmed instruction
- 17 audio cassette
- 18 video cassette
- 19 data terminal
- 20 telephone connection with the central data collection station
- 21 video telephone
- 22 conference circuit (conference hook-up, conference connection)
- 23 camera tube switch (switch for transmitting speaker's picture)
- 24 talk button (talk key, speaking key)
- 25 touch-tone buttons (touch-tone pad)
- 26 video telephone screen
- 27 infrared transmission of television sound
- 28 television receiver (television set, TV set)
- 29 infrared sound transmitter
- 30 cordless battery-powered infrared sound headphones (headset)
- 31 microfilming system [diagram]
- 32 magnetic tape station (data storage unit)
- 33 buffer storage
- 34 adapter unit
- 35 digital control
- 36 camera control
- 37 character storage
- 38 analogue (Am. analog) control
- 39 correction (adjustment) of picture tube geometry
- 40 cathode ray tube (CRT)
- 41 optical system
- 42 slide (transparency) of a form for mixing-in images of forms
- 43 flash lamp
- 44 universal film cassettes
- 45-84 demonstration and teaching equipment
- 45 demonstration model of a four-stroke engine
- 46 piston
- 47 cylinder head
- 48 spark plug (sparking plug)
- 49 contact breaker
- 50 crankshaft with balance weights (counterbalance weights) (counterbalanced crankshaft)
- 51 crankcase
- 52 inlet valve
- 53 exhaust valve
- 54 coolant bores (cooling water bores)
- 55 demonstration model of a two-stroke engine
- 56 deflector piston
- 57 transfer port
- 58 exhaust port
- 59 crankcase scavenging
- 60 cooling ribs
- 61-67 models of molecules
- 61 ethylene molecule
- 62 hydrogen atom
- 63 carbon atom
- 64 formaldehyde atom
- 65 oxygen molecule
- 66 benzene ring
- 67 water molecule
- 68-72 electronic circuits made up of modular elements
- 68 logic element (logic module), an integrated circuit
- 69 plugboard for electronic elements (electronic modules)
- 70 linking (link-up, joining, connection) of modules
- 71 magnetic contact
- 72 assembly (construction) of a circuit, using magnetic modules
- 73 multiple meter for measuring current, voltage and resistance
- 74 measurement range selector
- 75 measurement scale (measurement dial)
- 76 indicator needle (pointer)
- 77 current/voltage meter
- 78 adjusting screw
- 79 optical bench
- 80 triangular rail
- 81 laser (teaching laser, instruction laser)
- 82 diaphragm
- 83 lens system
- 84 target (screen)

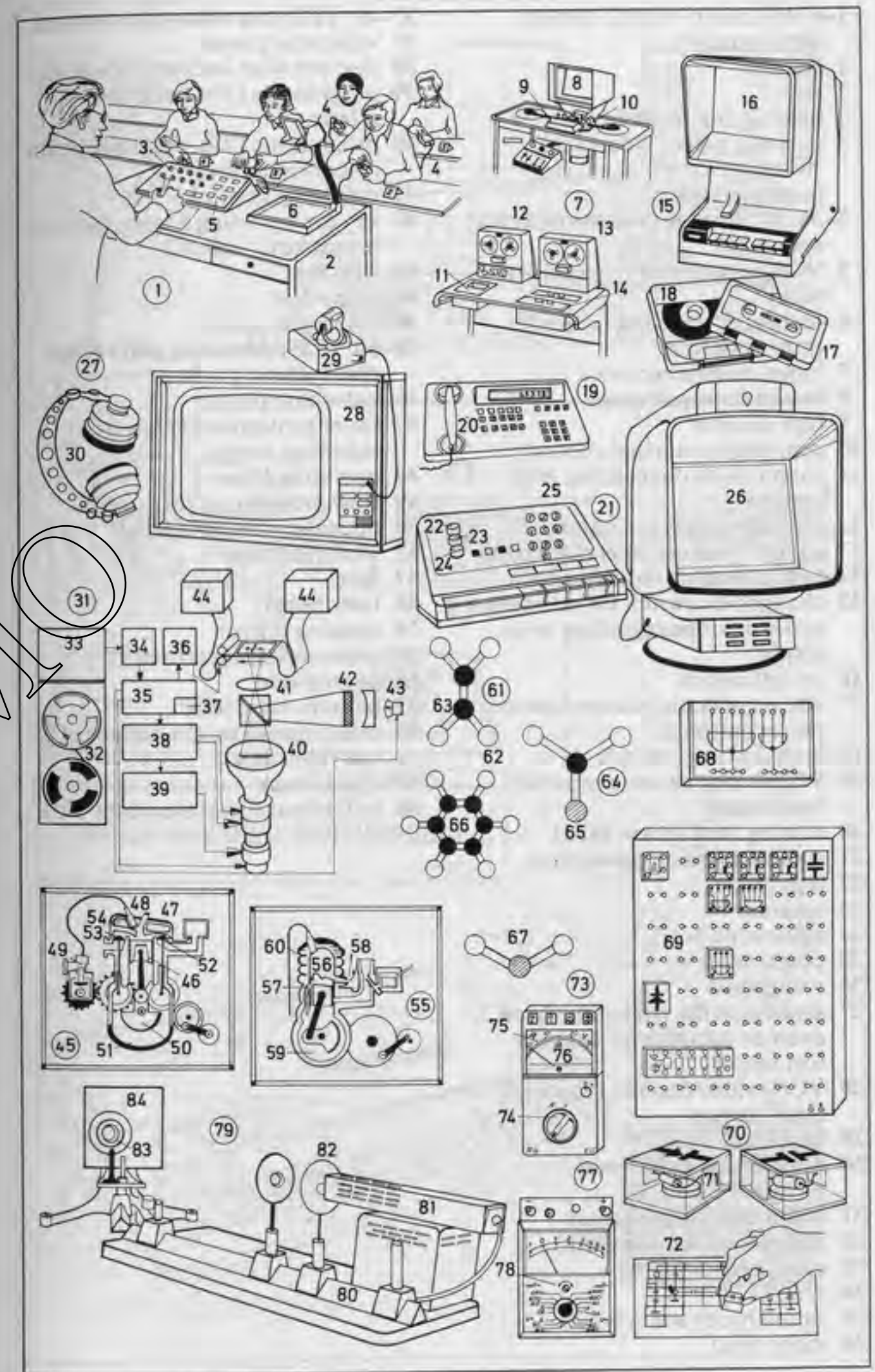

- 1-4 AV (audio-visual) camera with recorder
 1 camera
 2 lens
 3 built-in microphone
 4 portable video (videotape) recorder (for $\frac{1}{4}$ " open-reel magnetic tape)
 5-36 VCR (video cassette recorder) system
 5 VCR cassette (for $\frac{1}{2}$ " magnetic tape)
 6 domestic television receiver (also: monitor)
 7 video cassette recorder
 8 cassette compartment
 9 tape counter
 10 centring (centering) control
 11 sound (audio) recording level control
 12 recording level indicator
 13 control buttons (operating keys)
 14 tape threading indicator light
 15 changeover switch for selecting audio or video recording level display
 16 on/off switch
 17 station selector buttons (station preset buttons)
 18 built-in timer switch
 19 VCR (video cassette recorder) head drum
 20 erasing head (erase head)
 21 stationary guide (guide pin)
 22 tape guide
 23 capstan
 24 audio sync head
 25 pinch roller
 26 video head
 27 grooves in the wall of the head drum to promote air cushion formation
 28 VCR (video cassette recorder) track format
 29 tape feed
 30 direction of video head movement
 31 video track, a slant track
 32 sound track (audio track)
 33 sync track
 34 sync head
 35 sound head (audio head)
 36 video head

- 37-45 TED (television disc) system
 37 video disc player
 38 disc slot with inserted video disc
 39 programme (Am. program) selector
 40 programme (Am. program) scale (programme dial)
 41 operating key ('play')
 42 key for repeating a scene (scene-repeat key, 'select')
 43 stop key
 44 video disc
 45 video disc jacket
 46-60 VLP (video long play) video disc system
 46 video disc player
 47 cover projection (below it: scanning zone)
 48 operating keys
 49 slow motion control
 50 optical system [diagram]
 51 VLP video disc
 52 lens
 53 laser beam
 54 rotating mirror
 55 semi-reflecting mirror
 56 photodiode
 57 helium-neon laser
 58 video signals on the surface of the video disc
 59 signal track
 60 individual signal element ('pit')

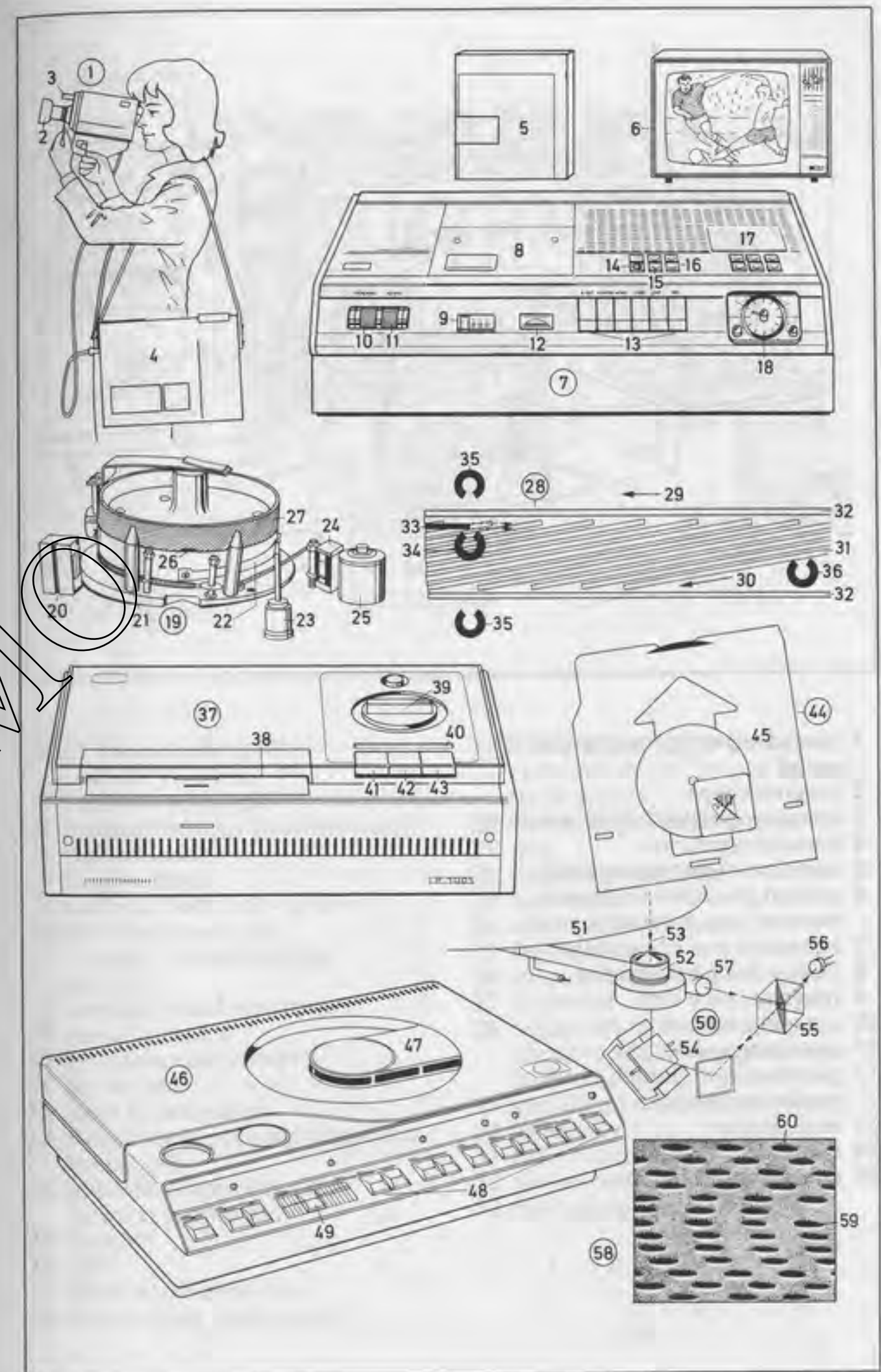

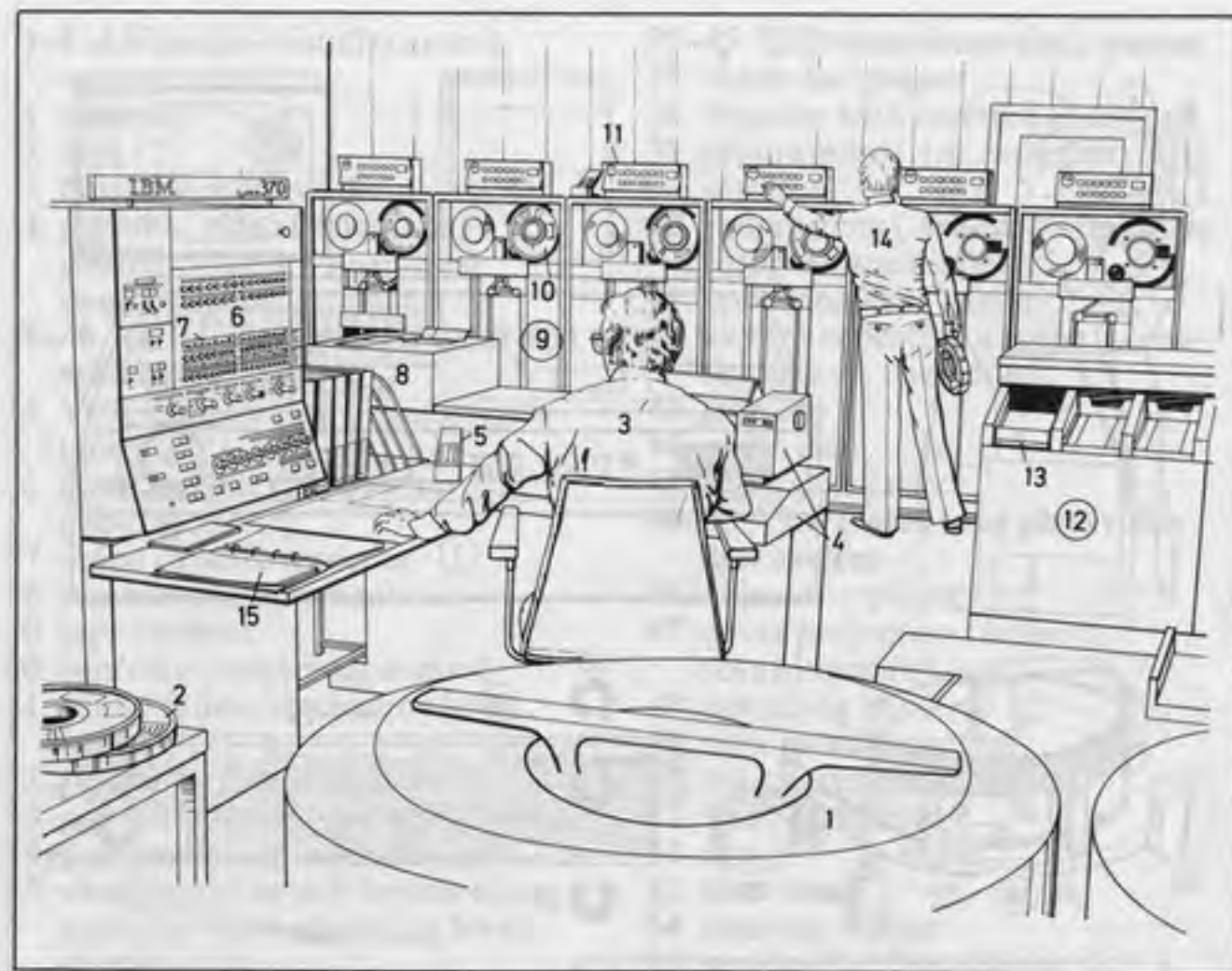

- 1 disc (disk) store (magnetic disc store)
- 2 magnetic tape
- 3 console operator (chief operator)
- 4 console typewriter
- 5 intercom (intercom system)
- 6 central processor with main memory and arithmetic unit
- 7 operation and error indicators
- 8 floppy disc (disk) reader
- 9 magnetic tape unit
- 10 magnetic tape reel
- 11 operating indicators
- 12 punched card (punch card) reader and punch
- 13 card stacker
- 14 operator
- 15 operating instructions

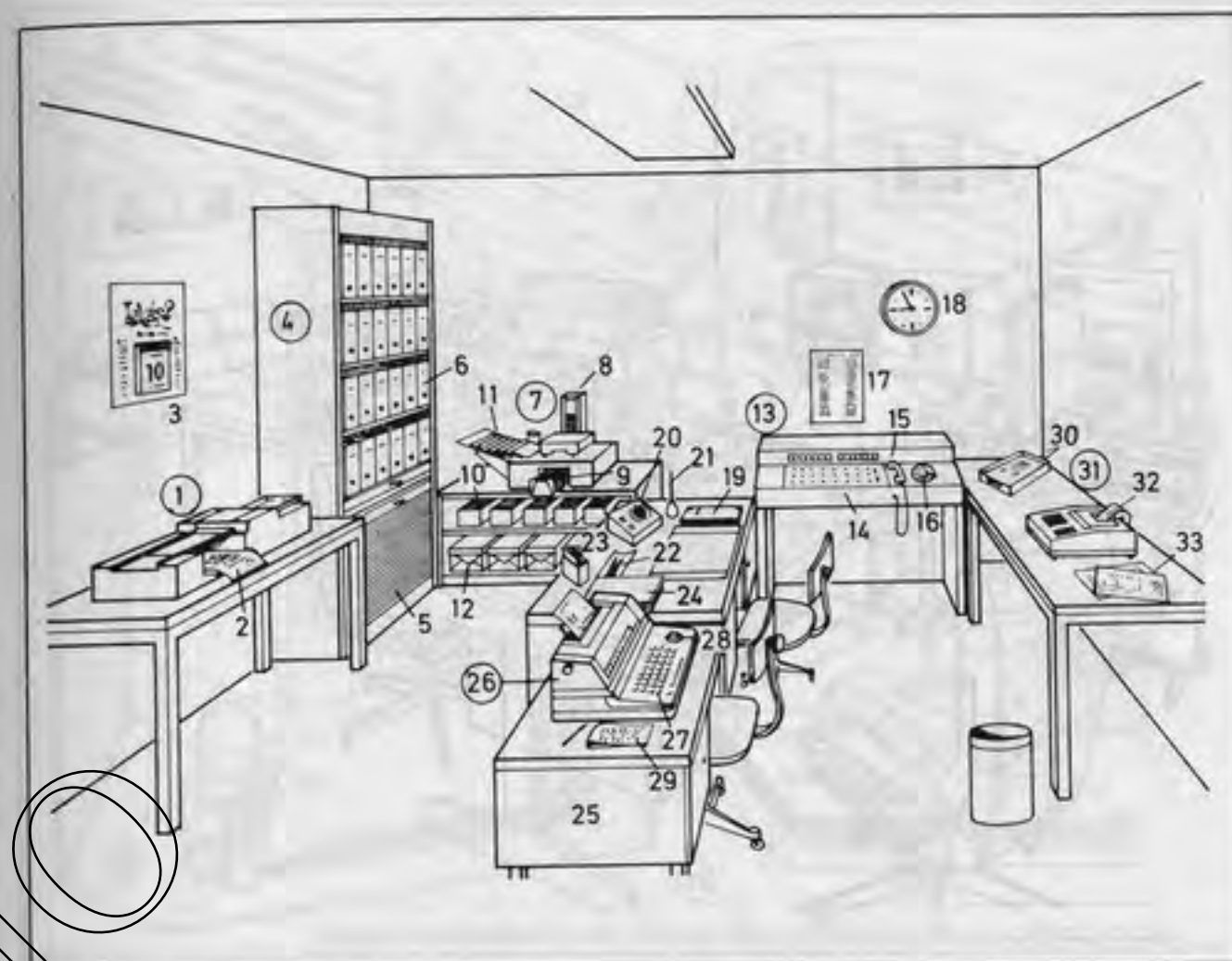

1-33 receptionist's office (secretary's office)

- 1 facsimile telegraph
- 2 transmitted copy (received copy)
- 3 wall calendar
- 4 filing cabinet
- 5 tambour door (roll-up door)
- 6 file (document file)
- 7 transfer-type addressing machine
- 8 vertical stencil magazine
- 9 stencil ejection
- 10 stencil storage drawer
- 11 paper feed
- 12 stock of notepaper
- 13 switchboard (internal telephone exchange)
- 14 push-button keyboard for internal connections
- 15 handset
- 16 dial
- 17 internal telephone list
- 18 master clock (main clock)
- 19 folder containing documents, correspondence, etc. for signing (to be signed)
- 20 intercom (office intercom)
- 21 pen
- 22 pen and pencil tray
- 23 card index
- 24 stack (set) of forms
- 25 typing desk
- 26 memory typewriter
- 27 keyboard
- 28 rotary switch for the main memory and the magnetic tape loop
- 29 shorthand pad (Am. steno pad)
- 30 letter tray
- 31 office calculator
- 32 printer
- 33 business letter

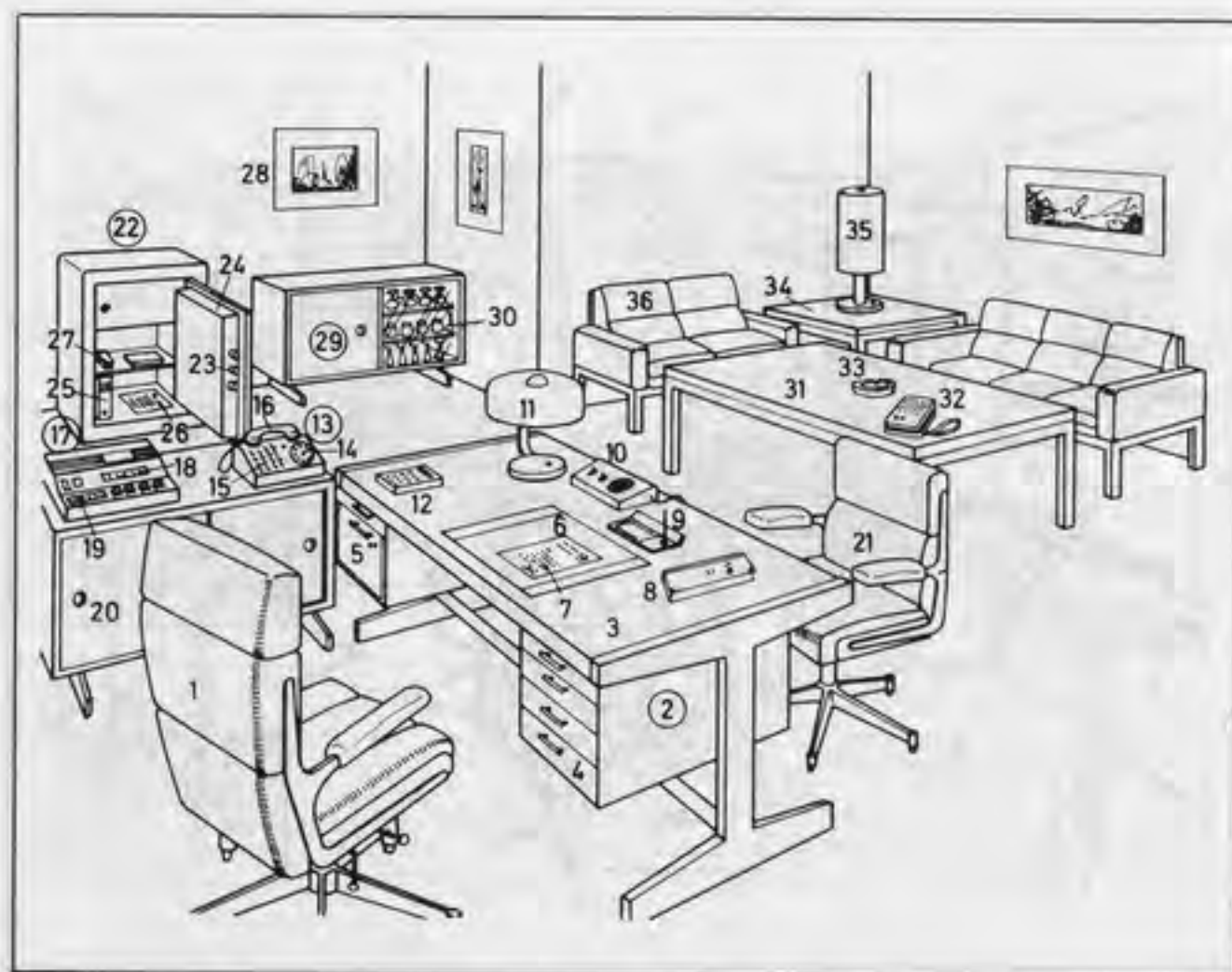
**1-36 executive's office**

- 1 swivel chair
- 2 desk
- 3 writing surface (desk top)
- 4 desk drawer
- 5 cupboard (storage area) with door
- 6 desk mat (blotter)
- 7 business letter
- 8 appointments diary
- 9 desk set
- 10 intercom (office intercom)
- 11 desk lamp
- 12 pocket calculator (electronic calculator)
- 13 telephone, an executive-secretary system
- 14 dial; *also*: push-button keyboard
- 15 call buttons
- 16 receiver (telephone receiver)
- 17 dictating machine
- 18 position indicator
- 19 control buttons (operating keys)
- 20 cabinet

- 21 visitor's chair
- 22 safe
- 23 bolts (locking mechanism)
- 24 armour (*Am.* armor) plating
- 25 confidential documents
- 26 patent
- 27 petty cash
- 28 picture
- 29 bar (drinks cabinet)
- 30 bar set
- 31-36 conference grouping
- 31 conference table
- 32 pocket-sized dictating machine (micro cassette recorder)
- 33 ashtray
- 34 corner table
- 35 table lamp
- 36 two-seater sofa [part of the conference grouping]

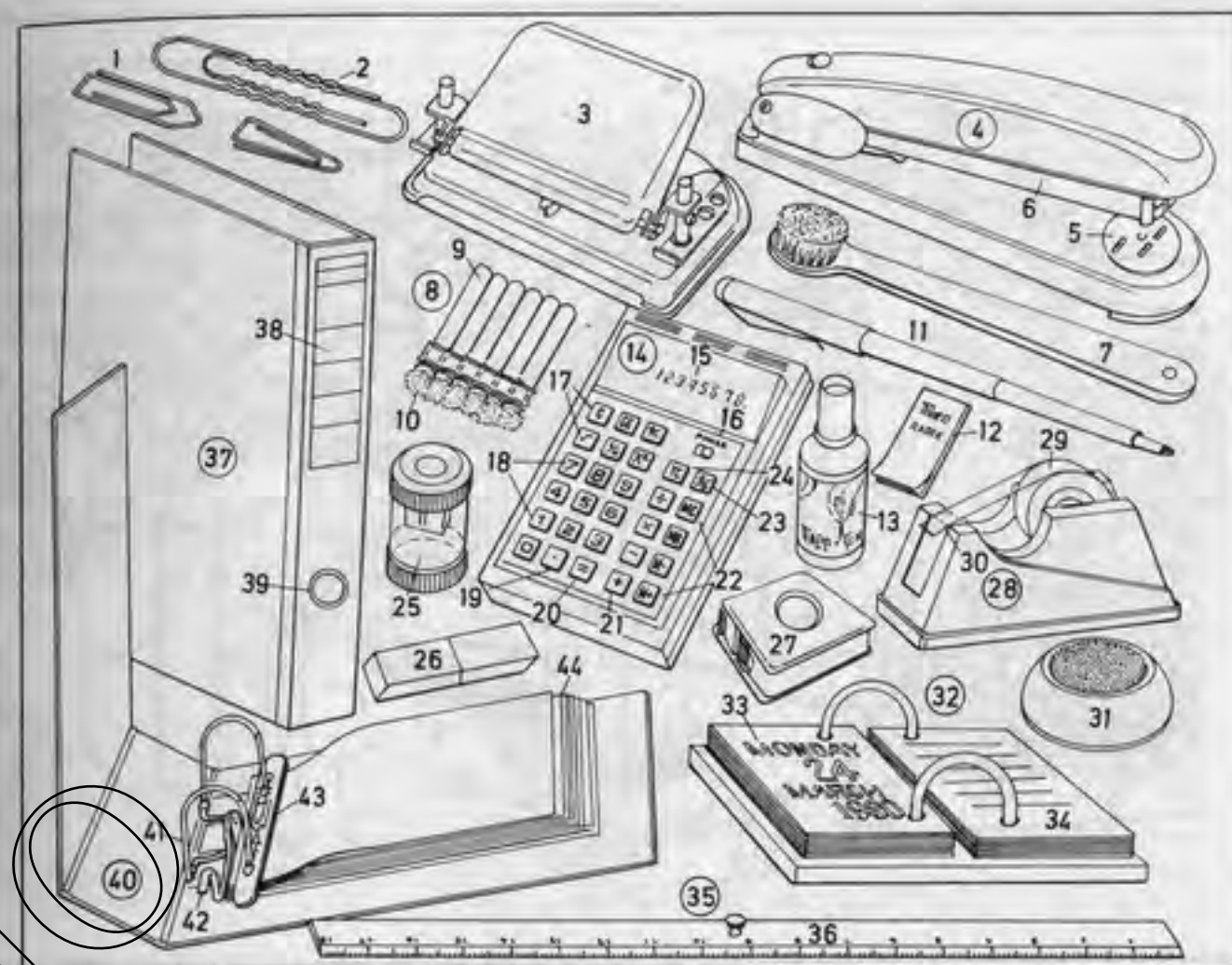

- 1-44 office equipment (office supplies, office materials)
- 1, 2 paper clips
- 3 punch
- 4 stapler (stapling machine)
- 5 anvil
- 6 spring-loaded magazine
- 7 type-cleaning brush for typewriters
- 8 type cleaner (type-cleaning kit)
- 9 fluid container (fluid reservoir)
- 10 cleaning brush
- 11 felt tip pen
- 12 correcting paper [for typing errors]
- 13 correcting fluid [for typing errors]
- 14 electronic pocket calculator
- 15 eight-digit fluorescent display
- 16 on/off switch
- 17 function keys
- 18 number keys
- 19 decimal key
- 20 'equals' key
- 21 instruction keys (command keys)
- 22 memory keys
- 23 percent key (percentage key)

- 24 π -key (pi-key) for mensuration of circles
- 25 pencil sharpener
- 26 typewriter rubber
- 27 adhesive tape dispenser
- 28 adhesive tape holder (roller-type adhesive tape dispenser)
- 29 roll of adhesive tape
- 30 tear-off edge
- 31 moistener
- 32 desk diary
- 33 date sheet (calendar sheet)
- 34 memo sheet
- 35 ruler
- 36 centimetre and millimetre (*Am.* centimeter and millimeter) graduations
- 37 file (document file)
- 38 spine label (spine tag)
- 39 finger hole
- 40 arch board file
- 41 arch unit
- 42 release lever (locking lever, release/lock lever)
- 43 compressor
- 44 bank statement (statement of account)

**1-48 open plan office**

- 1 partition wall (partition screen)
- 2 filing drawer with suspension file system
- 3 suspension file
- 4 file tab
- 5 file (document file)
- 6 filing clerk
- 7 clerical assistant
- 8 note for the files
- 9 telephone
- 10 filing shelves
- 11 clerical assistant's desk
- 12 office cupboard
- 13 plant stand (planter)
- 14 indoor plants (houseplants)
- 15 programmer
- 16 data display terminal (visual display unit)
- 17 customer service representative
- 18 customer
- 19 computer-generated design (computer-generated art)
- 20 sound-absorbing partition
- 21 typist
- 22 typewriter
- 23 filing drawer
- 24 customer card index
- 25 office chair, a swivel chair
- 26 typing desk
- 27 card index box
- 28 multi-purpose shelving
- 29 proprietor
- 30 business letter
- 31 proprietor's secretary
- 32 shorthand pad (*Am.* steno pad)
- 33 audio typist
- 34 dictating machine
- 35 earphone
- 36 statistics chart
- 37 pedestal containing a cupboard or drawers
- 38 sliding-door cupboard
- 39 office furniture arranged in an angular configuration
- 40 wall-mounted shelf
- 41 letter tray



- 42 wall calendar
- 43 data centre (*Am.* center)
- 44 calling up information on the data display terminal (visual display unit)
- 45 waste paper basket
- 46 sales statistics
- 47 EDP print-out, a continuous fan-fold sheet
- 48 connecting element

- 1 electric typewriter, a golf ball typewriter
- 2-6 keyboard
- 2 space bar
- 3 shift key
- 4 line space and carrier return key
- 5 shift lock
- 6 margin release key
- 7 tabulator key
- 8 tabulator clear key
- 9 on/off switch
- 10 striking force control (impression control)
- 11 ribbon selector
- 12 margin scale
- 13 left margin stop
- 14 right margin stop
- 15 golf ball (spherical typing element) bearing the types
- 16 ribbon cassette
- 17 paper bail with rollers
- 18 platen
- 19 typing opening (typing window)
- 20 paper release lever
- 21 carrier return lever
- 22 platen knob
- 23 line space adjuster
- 24 variable platen action lever
- 25 push-in platen variable
- 26 erasing table
- 27 transparent cover
- 28 exchange golf ball (exchange typing element)
- 29 type
- 30 golf ball cap (cap of typing element)
- 31 teeth
- 32 web-fed automatic copier
- 33 magazine for paper roll
- 34 paper size selection (format selection)
- 35 print quantity selection
- 36 contrast control
- 37 main switch (on/off switch)
- 38 start print button
- 39 document glass
- 40 transfer blanket
- 41 toner roll
- 42 exposure system
- 43 print delivery (copy delivery)
- 44 letter-folding machine
- 45 paper feed
- 46 folding mechanism
- 47 receiving tray
- 48 small offset press
- 49 paper feed
- 50 lever for inking the plate cylinder
- 51-52 inking unit (inker unit)
- 51 distributing roller (distributor)
- 52 ink roller (inking roller, fountain roller)
- 53 pressure adjustment
- 54 sheet delivery (receiving table)
- 55 printing speed adjustment
- 56 jogger for aligning the piles of sheets
- 57 pile of paper (pile of sheets)
- 58 folding machine
- 59 gathering machine (collating machine, assembling machine) for short runs
- 60 gathering station (collating station, assembling station)
- 61 adhesive binder (perfect binder) for hot adhesives
- 62 magnetic tape dictating machine
- 63 headphones (headset, earphones)
- 64 on/off switch
- 65 microphone cradle
- 66 foot control socket
- 67 telephone adapter socket
- 68 headphone socket (earphone socket, headset socket)
- 69 microphone socket
- 70 built-in loudspeaker
- 71 indicator lamp (indicator light)
- 72 cassette compartment
- 73 forward wind, rewind, and stop buttons
- 74 time scale with indexing marks
- 75 time scale stop

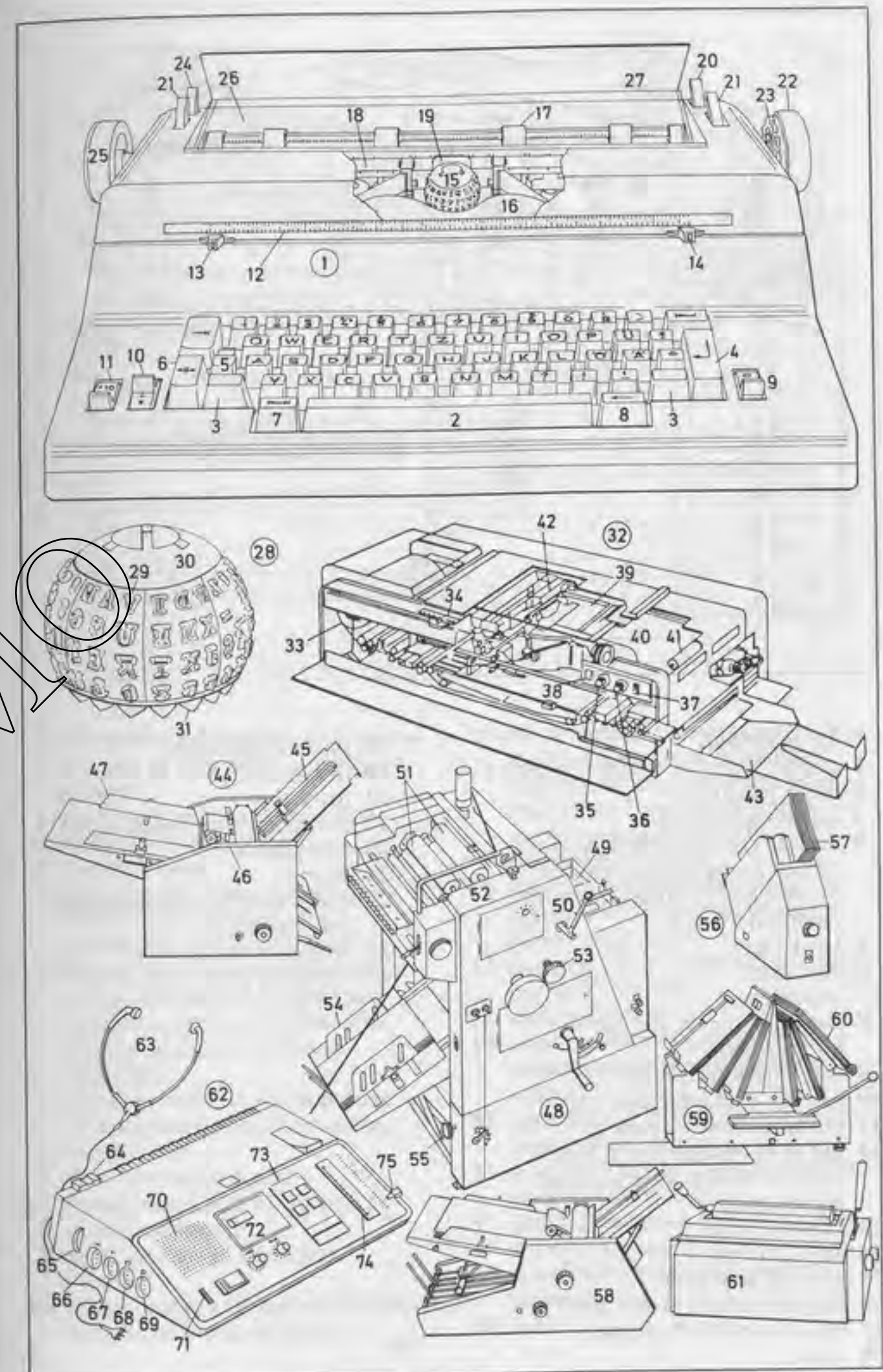

24

390 390
390 390

Pay to the order of 25
Smith, Jones & Robinson (Coventry) Ltd

For and on behalf of 26
Carnalhaus - Cartwright - Ltd

Authorized Signatory 27
C. Secretary

EXCHANGE FOR £8,000

At 16 days after sight pay this 13 First Bill of Exchange 14 to the Order of 17

(Second of same tenor and date unpaid)

Value Received 19 18 the sum of EIGHT THOUSAND SIX HUNDRED AND NO/100 POUNDS

To 20 Carnalhaus & Cartwright - Ltd, 21 For and on behalf of: 15
Salford House, King Street, Smith, Jones & Robinson (Coventry) Ltd, 14
Edmonton, LONDON

ACCEPTED 5 7 8 23
BY 22
Carnalhaus - Cartwright - Ltd
BARCLAYS BANK LTD
LOMBARD STREET - LONDON E.C.3

11

1000 DM DRESNER BANK 63701

12 13

DM 14

15 16

17

18

19

- 1-11 main hall
- 1 cashier's desk (cashier's counter)
- 2 teller (cashier)
- 3 bullet-proof glass
- 4 service counters (service and advice for savings accounts, private and company accounts, personal loans)
- 5 bank clerk
- 6 customer
- 7 brochures
- 8 stock list (price list, list of quotations)
- 9 information counter
- 10 foreign exchange counter
- 11 entrance to strong room
- 12 bill of exchange (bill); here: a draft, an acceptance (a bank acceptance)
- 13 place of issue
- 14 date of issue
- 15 place of payment
- 16 date of maturity (due date)
- 17 bill clause (draft clause)
- 18 value

- 19 payee (remittee)
- 20 drawee (payer)
- 21 drawer
- 22 domiciliation (paying agent)
- 23 acceptance
- 24 stamp
- 25 endorsement (indorsement, transfer entry)
- 26 endorsee (indorsee)
- 27 endorser (indorser)

- 1-10 stock exchange (exchange for the sale of securities, stocks, and bonds)
- 1 exchange hall (exchange floor)
- 2 market for securities
- 3 broker's post
- 4 sworn stockbroker (exchange broker, stockbroker, Am. specialist), an inside broker
- 5 kerbstone broker (kerbstoner, curbstoner, curbstoner, outside broker), a commercial broker dealing in unlisted securities
- 6 member of the stock exchange (stockjobber, Am. floor trader, room trader)
- 7 stock exchange agent (boardman), a bank employee
- 8 quotation board
- 9 stock exchange attendant (waiter)
- 10 telephone box (telephone booth, telephone kiosk, call box)

- 11-19 securities; kinds: share (Am. stock), fixed-income security, annuity, bond, debenture bond, municipal bond (corporation stock), industrial bond, convertible bond
- 11 share certificate (Am. stock certificate); here: bearer share (share warrant)
- 12 par (par value, nominal par, face par) of the share
- 13 serial number
- 14 page number of entry in bank's share register (bank's stock ledger)
- 15 signature of the chairman of the board of governors
- 16 signature of the chairman of the board of directors
- 17 sheet of coupons (coupon sheet, dividend coupon sheet)
- 18 dividend warrant (dividend coupon)
- 19 talon

- 1-28 coins (coin, coinage, metal money, specie, *Am.* hard money; kinds: gold, silver, nickel, copper, or aluminium, *Am.* aluminum, coins)
- 1 Athens: nugget-shaped tetradrachm (tetradrachmon, tetradrachma)
- 2 the owl (emblem of the city of Athens)
- 3 aureus of Constantine the Great
- 4 bracteate of Emperor Frederick I Barbarossa
- 5 Louis XIV louis-d'or
- 6 Prussia: 1 reichstaler (speciestaler) of Frederick the Great
- 7 Federal Republic of Germany: 5 Deutschmarks (DM); 1 DM = 100 pfennigs
- 8 obverse
- 9 reverse (subordinate side)
- 10 mint mark (mintage, exergue)
- 11 legend (inscription on the edge of a coin)
- 12 device (type), a provincial coat of arms
- 13 Austria: 25 schillings; 1 sch = 100 groschen
- 14 provincial coats of arms
- 15 Switzerland: 5 francs; 1 franc = 100 centimes
- 16 France: 1 franc = 100 centimes
- 17 Belgium: 100 francs
- 18 Luxembourg (Luxemburg): 1 franc
- 19 Netherlands: 2½ guilders; 1 guilder (florin, gulden) = 100 cents
- 20 Italy: 10 lire (sg. lira)
- 21 Vatican City: 10 lire (sg. lira)
- 22 Spain: 1 peseta = 100 céntimos
- 23 Portugal: 1 escudo = 100 centavos
- 24 Denmark: 1 krone = 100 öre
- 25 Sweden: 1 krona = 100 öre
- 26 Norway: 1 krone = 100 öre
- 27 Czechoslovakia: 1 koruna = 100 heller
- 28 Yugoslavia: 1 dinar = 100 paras
- 29-39 banknotes (*Am.* bills) (paper money, notes, treasury notes)

- 29 Federal Republic of Germany: 20 DM
- 30 bank of issue (bank of circulation)
- 31 watermark [a portrait]
- 32 denomination
- 33 USA: 1 dollar(\$1) = 100 cents
- 34 facsimile signatures
- 35 impressed stamp
- 36 serial number
- 37 United Kingdom of Great Britain and Northern Ireland: 1 pound sterling (£1) = 100 new pence (100 p.); (sg. new penny, new p.)
- 38 guilloched pattern
- 39 Greece: 1,000 drachmas (drachmae); 1 drachma = 100 lepta (sg. lepton)
- 40-44 striking of coins (coinage, mintage)
- 40-41 coining dies (minting dies)
- 40 upper die
- 41 lower die
- 42 collar
- 43 coin disc (disk) (flan, planchet, blank)
- 44 coining press (minting press)



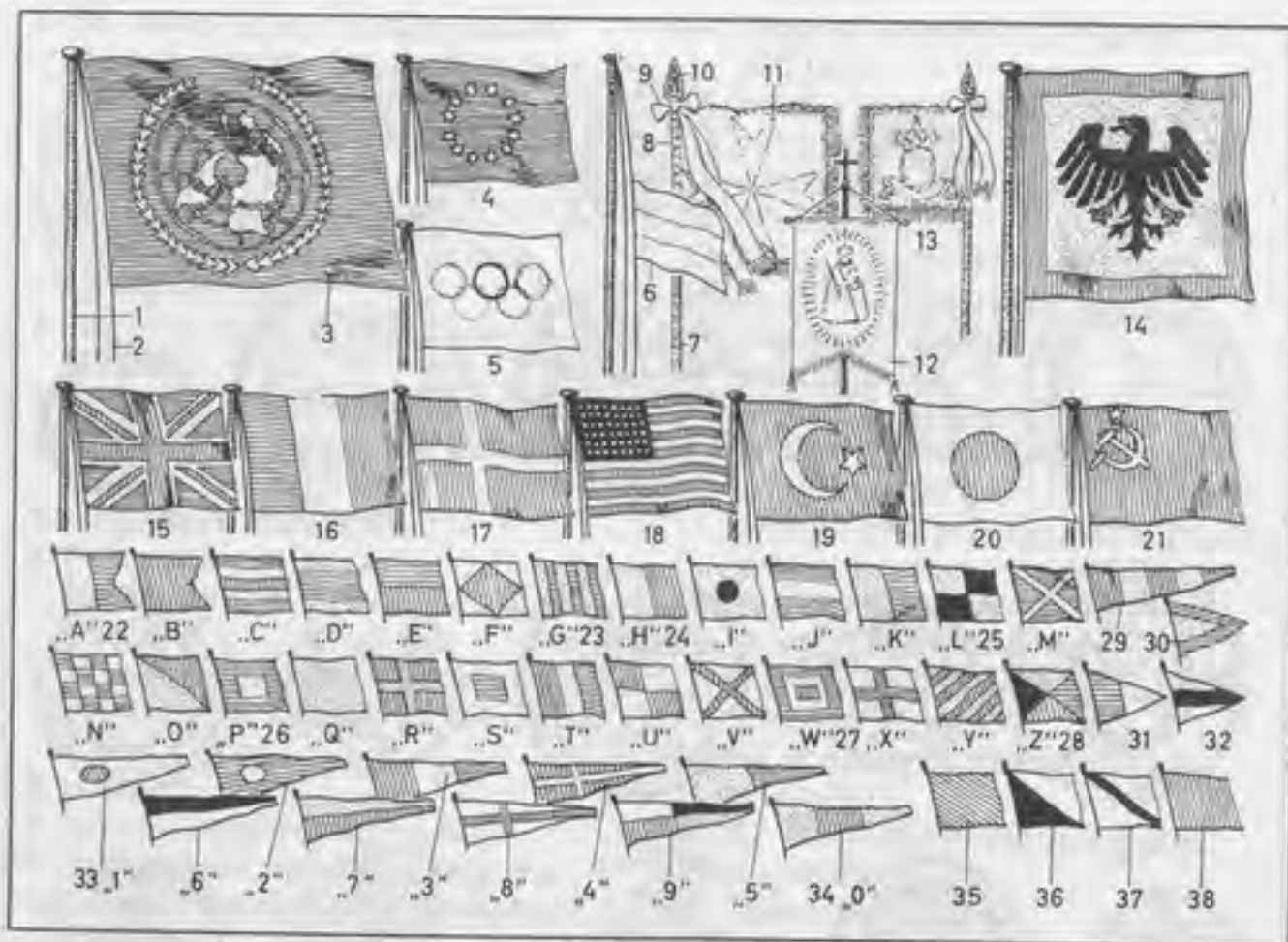

- 1-3 flag of the United Nations
 1 flagpole (flagstaff) with truck
 2 halyard (halliard, haulyard)
 3 bunting
 4 flag of the Council of Europe
 5 Olympic flag
 6 flag at half-mast (*Am.* at half-staff) [as a token of mourning]
 7-11 flag
 7 flagpole (flagstaff)
 8 ornamental stud
 9 streamer
 10 pointed tip of the flagpole
 11 bunting
 12 banner (gonfalon)
 13 cavalry standard (flag of the cavalry)
 14 standard of the German Federal President [ensign of head of state]
 15-21 national flags
 15 the Union Jack (Great Britain)
 16 the Tricolour (*Am.* Tricolor) (France)
 17 the Dannebrog (Dannebrog) (Denmark)
 18 the Stars and Stripes (Star-Spangled Banner) (USA)
 19 the Crescent (Turkey)
 20 the Rising Sun (Japan)
 21 the Hammer and Sickle (USSR)

- 22-34 signal flags, a hoist
 22-28 letter flags
 22 letter A, a burgee (swallow-tailed flag)
 23 G, pilot flag
 24 H ('pilot on board')
 25 L ('you should stop, I have something important to communicate')
 26 P, the Blue Peter ('about to set sail')
 27 W ('I require medical assistance')
 28 Z, an oblong pennant (oblong pendant)
 29 code pennant (code pendant), used in the International Signals Code
 30-32 substitute flags (repeaters), triangular flags (pennants, pendants)
 33-34 numeral pennants (numeral pendants)
 33 number 1
 34 number 0
 35-38 customs flags
 35 customs boat pennant (customs boat pendant)
 36 'ship cleared through customs'
 37 customs signal flag
 38 powder flag ['inflammable (flammable) cargo']

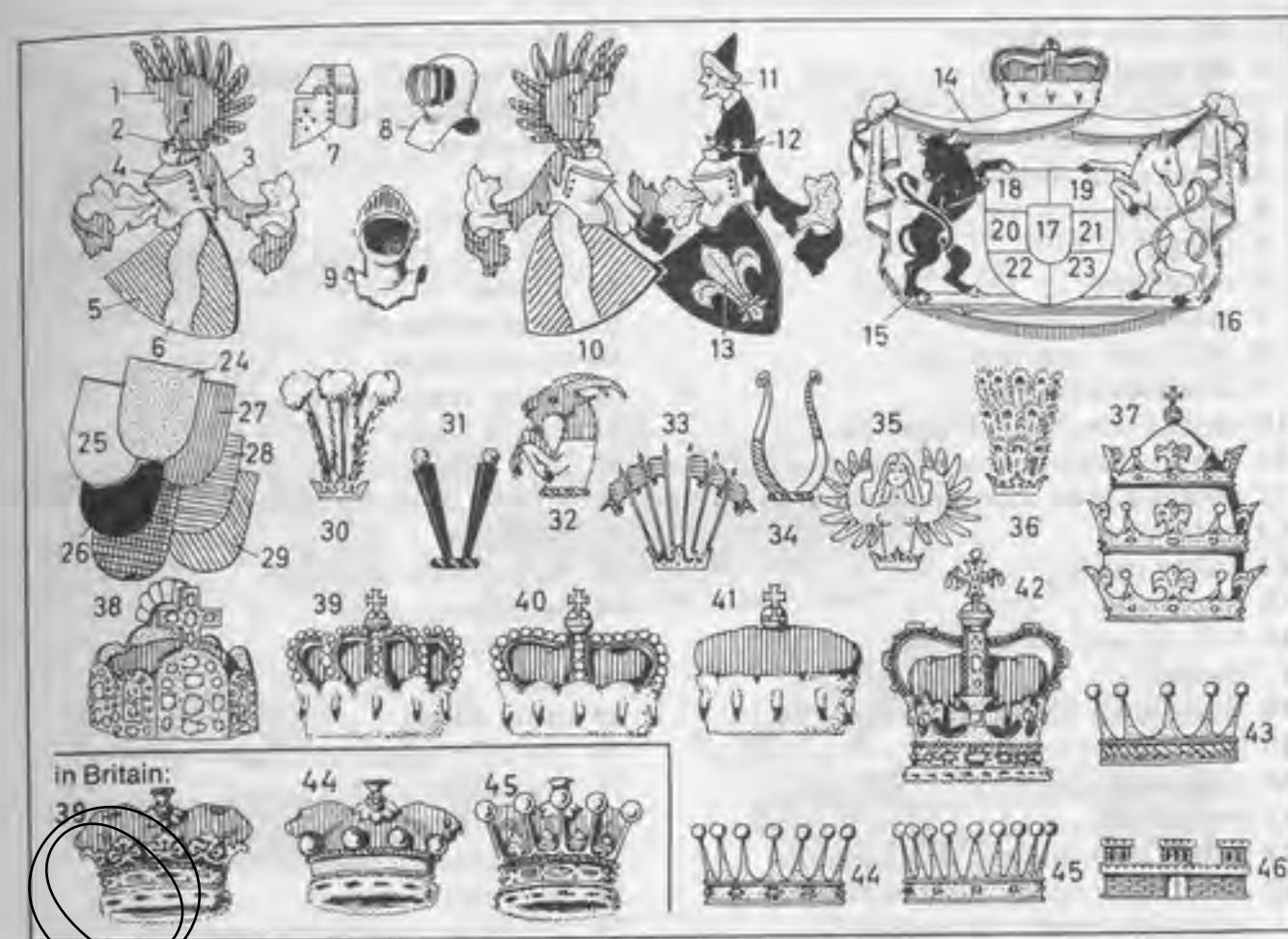

- 1-36 heraldry (blazonry)
 1, 21, 30-36 crests
 6 coat-of-arms (achievement of arms, hatchment, achievement)
 1 crest
 2 wreath of the colours (*Am.* colors)
 3 mantle (mantling)
 4, 7-9 helmets (helms)
 4 tilting helmet (jousting helmet)
 5 shield
 6 bend sinister wavy
 7 pot-helmet (pot-helm, heaume)
 8 barred helmet (grilled helmet)
 9 helmet affronty with visor open
 10-13 marital achievement (marshalled, *Am.* marshaled, coat-of-arms)
 10 arms of the baron (of the husband)
 11-13 arms of the family of the femme (of the wife)
 11 demi-man; *also*: demi-woman
 12 crest coronet
 13 fleur-de-lis
 14 mantling
 15-16 supporters (heraldic beasts)
 15 bull
 16 unicorn
 17-23 blazon
 17 inescutcheon (heart-shield)
 18-23 quarterings one to six
 18, 20, 22 dexter, right

- 18-19 chief
 19, 21, 23 sinister, left
 22-23 base
 24-29 tinctures
 24 or (gold) [yellow]
 25 argent (silver) [white]
 26 sable
 27 gules
 28 azure
 29 vert
 30 ostrich feathers (treble plume)
 31 truncheon
 32 demi-goat
 33 tournament pennons
 34 buffalo horns
 35 harpy
 36 plume of peacock's feathers
 37-46 crowns and coronets
 37 tiara (papal tiara)
 38 Imperial Crown [German, until 1806]
 39 ducal coronet (duke's coronet)
 40 prince's coronet
 41 elector's coronet
 42 English Royal Crown
 43-45 coronets of rank
 43 baronet's coronet
 44 baron's coronet (baronial coronet)
 45 count's coronet
 46 mauerkrone (mural crown) of a city crest

- 1-98 army weaponry
- 1-39 hand weapons
- 1 PI pistol
- 2 barrel
- 3 front sight (foresight)
- 4 hammer
- 5 trigger
- 6 pistol grip
- 7 magazine holder
- 8 MP2 sub-machine gun
- 9 shoulder rest (butt)
- 10 casing (mechanism casing)
- 11 barrel clamp (barrel-clamping nut)
- 12 cocking lever (cocking handle)
- 13 palm rest
- 14 safety catch
- 15 magazine
- 16 G3-A3 self-loading rifle
- 17 barrel
- 18 flash hider (flash eliminator)
- 19 palm rest
- 20 trigger mechanism
- 21 magazine
- 22 notch (sighting notch, rearsight)
- 23 front sight block (foresight block) with front sight (foresight)
- 24 rifle butt (butt)
- 25 44 mm anti-tank rocket launcher
- 26 rocket (projectile)
- 27 buffer
- 28 telescopic sight (telescope sight)
- 29 firing mechanism
- 30 cheek rest
- 31 shoulder rest (butt)
- 32 MG3 machine gun (Spandau)
- 33 barrel casing
- 34 gas regulator
- 35 belt-changing flap
- 36 rearsight
- 37 front sight block (foresight block) with front sight (foresight)
- 38 pistol grip
- 39 shoulder rest (butt)
- 40-95 heavy weapons
- 40 120 mm AM 50 mortar
- 41 barrel
- 42 bipod
- 43 gun carriage
- 44 buffer (buffer ring)
- 45 sight (sighting mechanism)
- 46 base plate
- 47 striker pad
- 48 traversing handle
- 49-74 artillery weapons mounted on self-propelled gun carriages
- 49 175 mm SFM 107 cannon
- 50 drive wheel
- 51 elevating piston
- 52 buffer (buffer recuperator)
- 53 hydraulic system
- 54 breech ring
- 55 spade
- 56 spade piston
- 57 155 mm M 109 G self-propelled gun
- 58 muzzle
- 59 fume extractor
- 60 barrel cradle
- 61 barrel recuperator
- 62 barrel clamp
- 63 light anti-aircraft (AA) machine gun
- 64 Honest John M 386 rocket launcher
- 65 rocket with warhead
- 66 launching ramp
- 67 elevating gear
- 68 jack
- 69 cable winch
- 70 110 SF rocket launcher
- 71 disposable rocket tubes
- 72 tube bins
- 73 turntable
- 74 fire control system
- 75 2.5 tonne construction vehicle
- 76 lifting arms (lifting device)
- 77 shovel
- 78 counterweight (counterpoise)
- 79-95 armoured (*Am. armored*) vehicles
- 79 M 113 armoured (*Am. armored*) ambulance
- 80 Leopard 1 A 3 tank
- 81 protection device
- 82 infrared laser rangefinder
- 83 smoke canisters (smoke dispensers)
- 84 armoured (*Am. armored*) turret
- 85 skirt
- 86 road wheel
- 87 track
- 88 anti-tank tank
- 89 fume extractor
- 90 protection device
- 91 armoured (*Am. armored*) personnel carrier
- 92 cannon
- 93 armoured (*Am. armored*) recovery vehicle
- 94 levelling (*Am. leveling*) and support shovel
- 95 jib
- 96 25 tonne all-purpose vehicle
- 97 drop windscreen (*Am. drop windshield*)
- 98 canvas cover

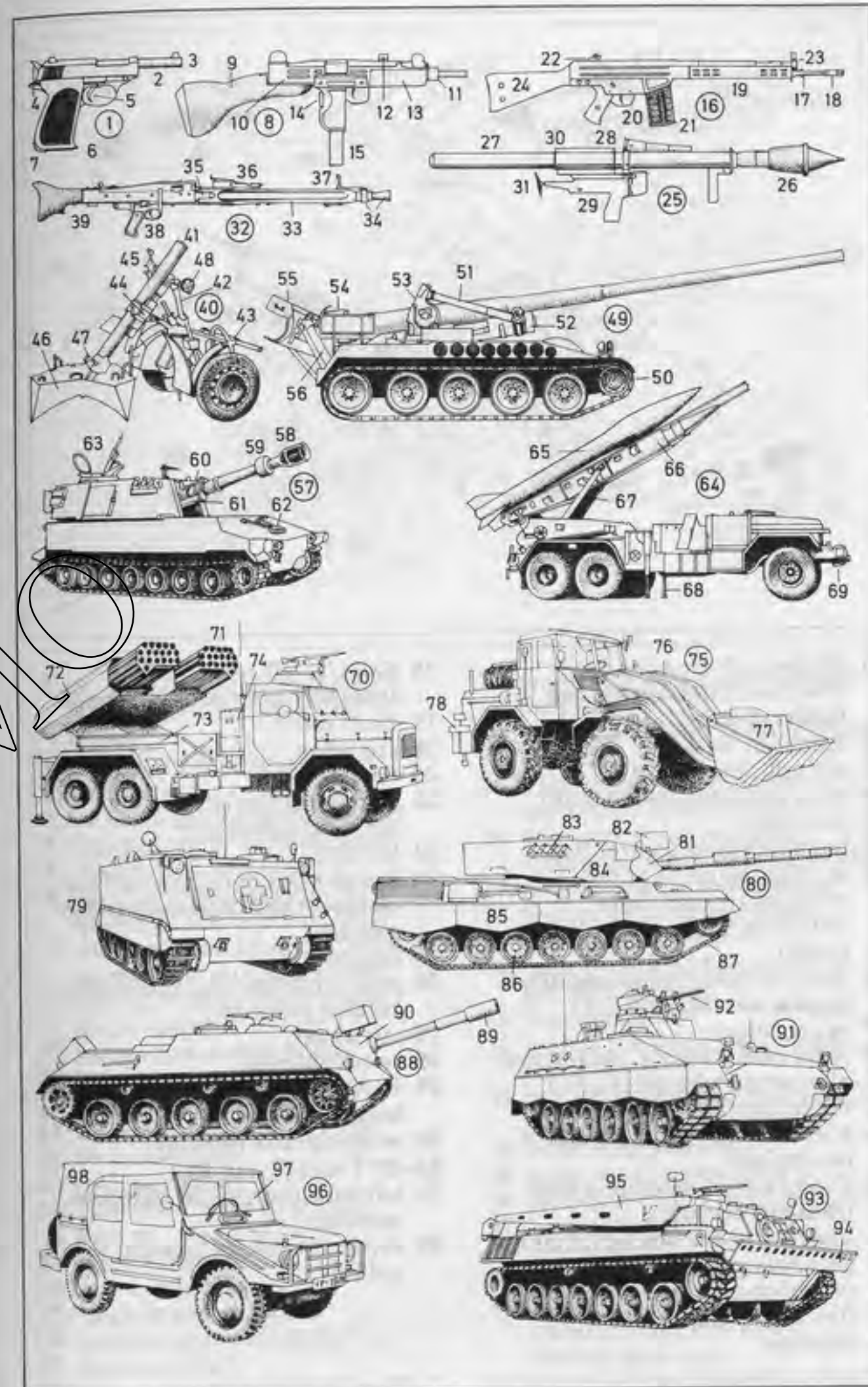



- 1 McDonnell-Douglas F-4F Phantom II interceptor and fighter-bomber
- 2 squadron marking
- 3 aircraft cannon
- 4 wing tank (underwing tank)
- 5 air intake
- 6 boundary layer control flap
- 7 in-flight refuelling (Am. refueling) probe (flight refuelling probe, air refuelling probe)
- 8 Panavia 2000 Tornado multirole combat aircraft (MRCA)
- 9 swing wing
- 10 radar nose (radome, radar dome)
- 11 pitot-static tube (pitot tube)
- 12 brake flap (air brake)
- 13 afterburner exhaust nozzles of the engines
- 14 C160 Transall medium-range transport aircraft
- 15 undercarriage housing (landing gear housing)
- 16 propeller-turbine engine (turboprop engine)
- 17 antenna

- 18 Bell UH-1D Iroquois light transport and rescue helicopter
- 19 main rotor
- 20 tail rotor
- 21 landing skids
- 22 stabilizing fins (stabilizing surfaces, stabilizers)
- 23 tail skid
- 24 Dornier DO 28 D-2 Skyservant transport and communications aircraft
- 25 engine pod
- 26 main undercarriage unit (main landing gear unit)
- 27 tail wheel
- 28 sword antenna
- 29 F-104 G Starfighter fighter-bomber
- 30 wing-tip tank (tip tank)
- 31-32 T-tail (T-tail unit)
- 31 tailplane (horizontal stabilizer, stabilizer)
- 32 vertical stabilizer (vertical fin, tail fin)

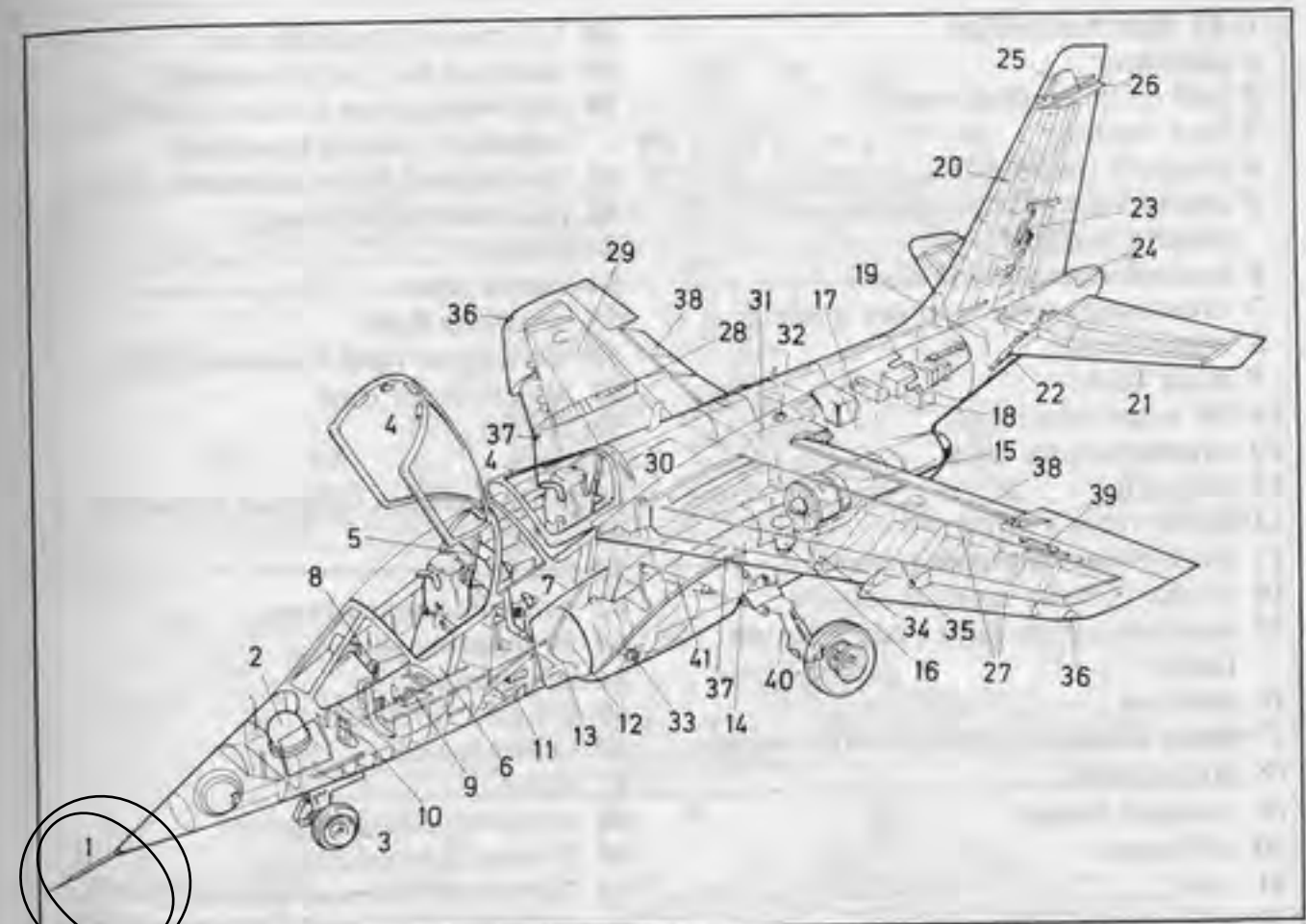

- 1-41 Dornier-Dassault-Breguet Alpha Jet Franco-German jet trainer
- 1 pitot-static tube (pitot tube)
- 2 oxygen tank
- 3 forward-retracting nose wheel
- 4 cockpit canopy (cockpit hood)
- 5 canopy jack
- 6 pilot's seat (student pilot's seat), an ejector seat (ejection seat)
- 7 observer's seat (instructor's seat), an ejector seat (ejection seat)
- 8 control column (control stick)
- 9 thrust lever
- 10 rudder pedals with brakes
- 11 front avionics bay
- 12 air intake to the engine
- 13 boundary layer control flap
- 14 air intake duct
- 15 turbine engine
- 16 reservoir for the hydraulic system
- 17 battery housing
- 18 rear avionics bay
- 19 baggage compartment
- 20 triple-spar tail construction
- 21 horizontal tail
- 22 servo-actuating mechanism for the elevator

- 23 servo-actuating mechanism for the rudder
- 24 brake chute housing (drag chute housing)
- 25 VHF (very high frequency) antenna (UHF antenna)
- 26 VOR (very high frequency omnidirectional range) antenna
- 27 twin-spar wing construction
- 28 former with integral spars
- 29 integral wing tanks
- 30 centre-section (Am. center-section) fuel tank
- 31 fuselage tanks
- 32 gravity fuelling (Am. fueling) point
- 33 pressure fuelling (Am. fueling) point
- 34 inner wing suspension
- 35 outer wing suspension
- 36 navigation lights (position lights)
- 37 landing lights
- 38 landing flap
- 39 aileron actuator
- 40 forward-retracting main undercarriage unit (main landing gear unit)
- 41 undercarriage hydraulic cylinder (landing gear hydraulic cylinder)

- 1-63 light battleships
 1 destroyer
 2 hull of flush-deck vessel
 3 bow (stem)
 4 flagstaff (jackstaff)
 5 anchor, a stockless anchor (patent anchor)
 6 anchor capstan (windlass)
 7 breakwater (*Am.* manger board)
 8 chine strake
 9 main deck
 10-28 superstructures
 10 superstructure deck
 11 life rafts
 12 cutter (ship's boat)
 13 davit (boat-launching crane)
 14 bridge (bridge superstructure)
 15 side navigation light (side running light)
 16 antenna
 17 radio direction finder (RDF) frame
 18 lattice mast
 19 forward funnel
 20 aft funnel
 21 cowl
 22 aft superstructure (poop)
 23 capstan
 24 companion ladder (companionway, companion hatch)
 25 ensign staff
 26 stern, a transom stern
 27 waterline
 28 searchlight
 29-37 armament
 29 100 mm gun turret
 30 four-barrel anti-submarine rocket launcher (missile launcher)
 31 40 mm twin anti-aircraft (AA) gun
 32 MM 38 anti-aircraft (AA) rocket launcher (missile launcher) in launching container
 33 anti-submarine torpedo tube
 34 depth-charge thrower
 35 weapon system radar
 36 radar antenna (radar scanner)
 37 optical rangefinder
 38 destroyer
 39 bower anchor
 40 propeller guard
 41 tripod lattice mast
 42 pole mast
 43 ventilator openings (ventilator grill)
 44 exhaust pipe
 45 ship's boat
 46 antenna
 47 radar-controlled 127 mm all-purpose gun in turret
 48 127 mm all-purpose gun
 49 launcher for Tartar missiles
 50 anti-submarine rocket (ASROC) launcher (missile launcher)
 51 fire control radar antennas
 52 radome (radar dome)
 53 frigate
 54 hawse pipe
 55 steaming light
 56 navigation light (running light)
 57 air extractor duct
 58 funnel
 59 cowl
 60 whip antenna (fishpole antenna)
 61 cutter
 62 stern light
 63 propeller guard boss
 64-91 fighting ships
 64 submarine
 65 flooded foredeck
 66 pressure hull
 67 turret
 68 retractable instruments
 69 E-boat (torpedo boat)
 70 76 mm all-purpose gun with turret
 71 missile-launching housing
 72 deckhouse
 73 40 mm anti-aircraft (AA) gun
 74 propeller guard moulding (*Am.* molding)
 75 143 class E-boat (143 class torpedo boat)
 76 breakwater (*Am.* manger board)
 77 radome (radar dome)
 78 torpedo tube
 79 exhaust escape flue
 80 mine hunter
 81 reinforced rubbing strake
 82 inflatable boat (inflatable dinghy)
 83 davit
 84 minesweeper
 85 cable winch
 86 towing winch (towing machine, towing engine)
 87 mine-sweeping gear (paravanes)
 88 crane (davit)
 89 landing craft
 90 bow ramp
 91 stern ramp
 92-97 auxiliaries
 92 tender
 93 servicing craft
 94 minelayer
 95 training ship
 96 deep-sea salvage tug
 97 fuel tanker (replenishing ship)

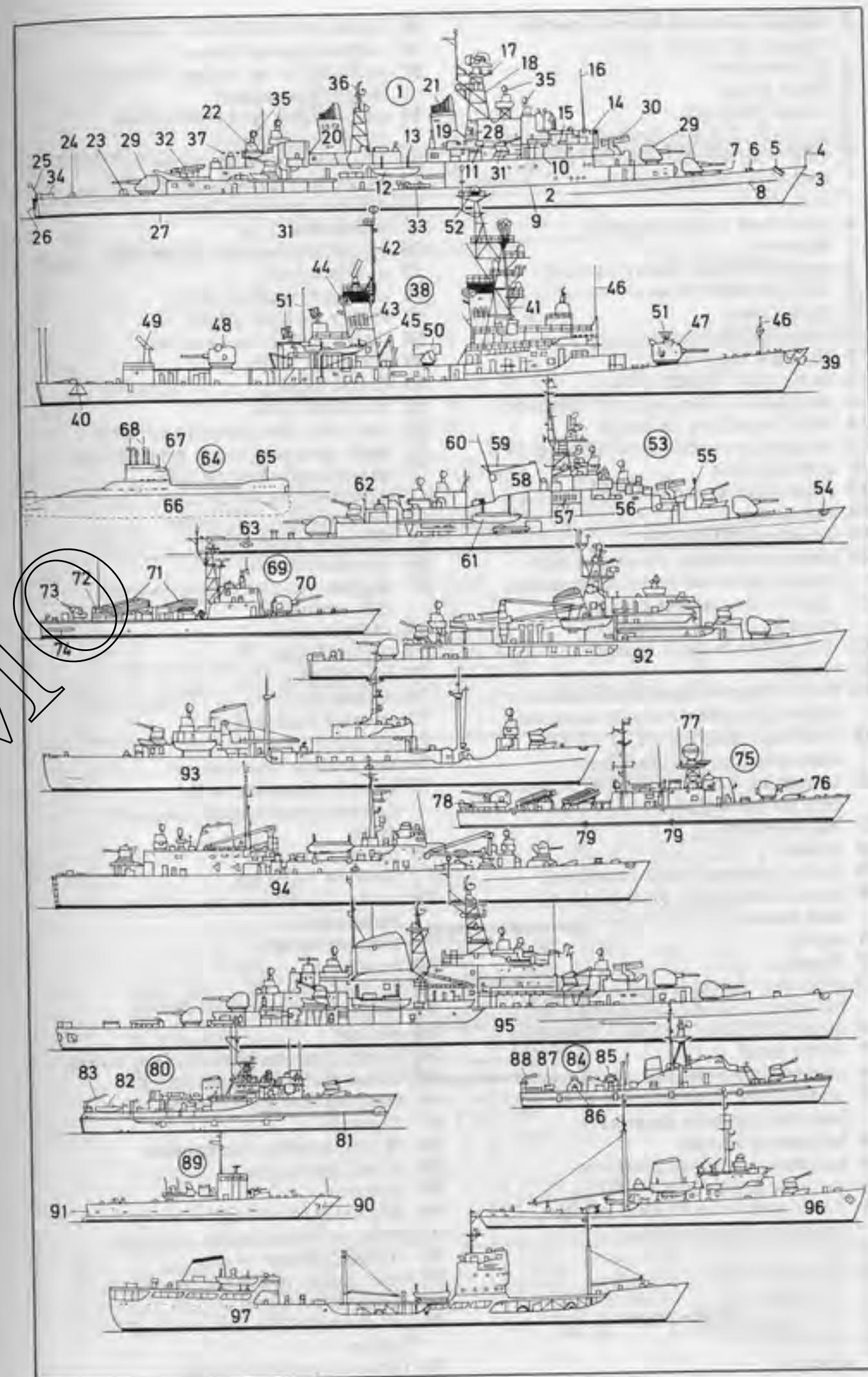

- 1 nuclear-powered aircraft carrier
"Nimitz ICVN 68" (USA)
- 2-11 body plan
- 2 flight deck
- 3 island (bridge)
- 4 aircraft lift (Am. aircraft elevator)
- 5 eight-barrel anti-aircraft (AA)
rocket launcher (missile
launcher)
- 6 pole mast (antenna mast)
- 7 antenna
- 8 radar antenna (radar scanner)
- 8 fully enclosed bow
- 10 deck crane
- 11 transom stern
- 12-20 deck plan
- 12 angle deck (flight deck)
- 13 aircraft lift (Am. aircraft elevator)
- 14 twin launching catapult
- 15 hinged (movable) baffle board
- 16 arrestor wire
- 17 emergency crash barrier
- 18 safety net
- 19 caisson (cofferdam)
- 20 eight-barrel anti-aircraft (AA)
rocket launcher (missile launcher)
- 21 "Kara" class rocket cruiser
(missile cruiser) (USSR)
- 22 hull of flush-deck vessel
- 23 sheer
- 24 twelve-barrel underwater salvo
rocket launcher (missile launcher)
- 25 twin anti-aircraft (AA) rocket
launcher (missile launcher)
- 26 launching housing for 4 short-range
rockets (missiles)
- 27 baffle board
- 28 bridge
- 29 radar antenna (radar scanner)
- 30 twin 76 mm anti-aircraft (AA)
gun turret
- 31 turret
- 32 funnel
- 33 twin anti-aircraft (AA) rocket
launcher (missile launcher)
- 34 automatic anti-aircraft (AA) gun
- 35 ship's boat
- 36 underwater 5-torpedo housing
- 37 underwater 6-salvo rocket
launcher (missile launcher)
- 38 helicopter hangar
- 39 helicopter landing platform
- 40 variable depth sonar (VDS)
- 41 "California" class rocket cruiser
(missile cruiser) (USA)
- 42 hull
- 43 forward turret
- 44 aft turret
- 45 forward superstructure
- 46 landing craft
- 47 antenna
- 48 radar antenna (radar scanner)
- 49 radome (radar dome)
- 50 surface-to-air rocket launcher
(missile launcher)
- 51 underwater rocket launcher
(missile launcher)
- 52 127 mm gun with turret
- 53 helicopter landing platform
- 54 nuclear-powered fleet
submarine
- 55-74 middle section [diagram]
- 55 pressure hull
- 56 auxiliary engine room
- 57 rotary turbine pump
- 58 steam turbine generator
- 59 propeller shaft
- 60 thrust block
- 61 reduction gear
- 62 high and low pressure turbine
- 63 high-pressure steam pipe for the
secondary water circuit
(auxiliary water circuit)
- 64 condenser
- 65 primary water circuit
- 66 heat exchanger
- 67 nuclear reactor casing (atomic
pile casing)
- 68 reactor core
- 69 control rods
- 70 lead screen
- 71 turret
- 72 snorkel (schnorkel)
- 73 air inlet
- 74 retractable instruments
- 75 patrol submarine with
conventional (diesel-electric)
drive
- 76 pressure hull
- 77 flooded foredeck
- 78 outer flap (outer doors) [for
torpedoes]
- 79 torpedo tube
- 80 bow bilge
- 81 anchor
- 82 anchor winch
- 83 battery
- 84 living quarters with folding bunks
- 85 commanding officer's cabin
- 86 main hatchway
- 87 flagstaff
- 88-91 retractable instruments
- 88 attack periscope
- 89 antenna
- 90 snorkel (schnorkel)
- 91 radar antenna (radar scanner)
- 92 exhaust outlet
- 93 heat space (hot-pipe space)
- 94 diesel generators
- 95 aft diving plane and vertical
rudder
- 96 forward vertical rudder

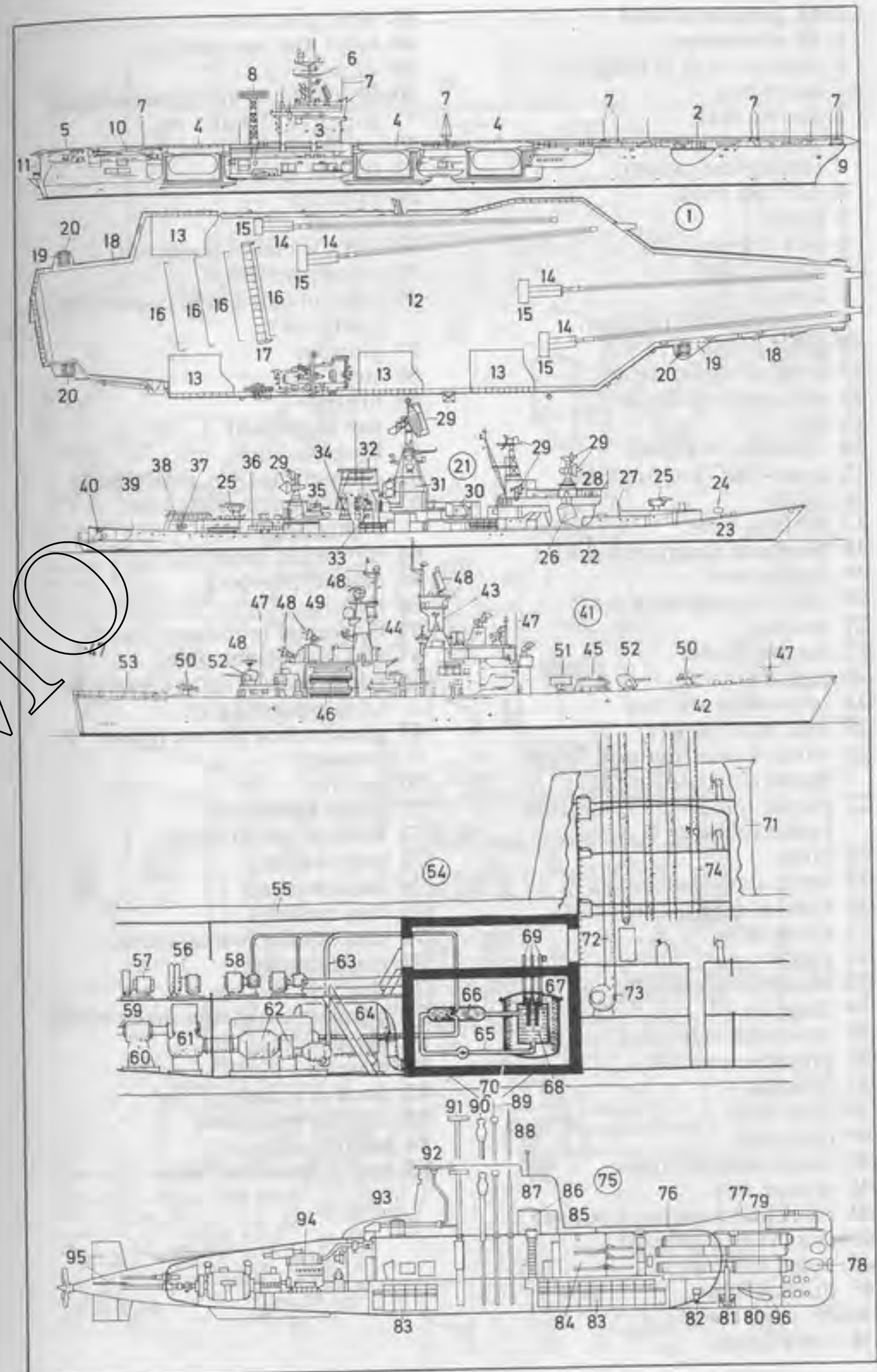

1-85 primary school

1-45 classroom

- 1 arrangement of desks in a horseshoe
- 2 double desk
- 3 pupils (children) in a group (sitting in a group)
- 4 exercise book
- 5 pencil
- 6 wax crayon
- 7 school bag
- 8 handle
- 9 school satchel (satchel)
- 10 front pocket
- 11 strap (shoulder strap)
- 12 pen and pencil case
- 13 zip
- 14 fountain pen (pen)
- 15 loose-leaf file (ring file)
- 16 reader
- 17 spelling book
- 18 notebook (exercise book)
- 19 felt tip pen
- 20 pupil raising her hand
- 21 teacher
- 22 teacher's desk
- 23 register
- 24 pen and pencil tray
- 25 desk mat (blotter)
- 26 window painting with finger paints (finger painting)
- 27 pupils' (children's) paintings (watercolours)
- 28 cross
- 29 three-part blackboard
- 30 bracket for holding charts
- 31 chalk ledge
- 32 chalk
- 33 blackboard drawing
- 34 diagram
- 35 reversible side blackboard
- 36 projection screen
- 37 triangle
- 38 protractor
- 39 divisions
- 40 blackboard compass
- 41 sponge tray
- 42 blackboard sponge (sponge)
- 43 classroom cupboard
- 44 map (wall map)
- 45 brick wall

- 46-85 craft room
- 46 workbench
- 47 vice (*Am. vise*)
- 48 vice (*Am. vise*) bar
- 49 scissors
- 50-52 working with glue (sticking paper, cardboard, etc.)
- 50 surface to be glued
- 51 tube of glue
- 52 tube cap
- 53 fretsaw
- 54 fretsaw blade (saw blade)
- 55 wood rasp (rasp)
- 56 piece of wood held in the vice (*Am. vise*)
- 57 glue pot
- 58 stool
- 59 brush
- 60 pan (dust pan)
- 61 broken china
- 62 enamelling (*Am. enameling*)
- 63 electric enamelling (*Am. enameling*) stove
- 64 unworked copper
- 65 enamel powder
- 66 hair sieve
- 67-80 pupils' (children's) work
- 67 clay models (models)
- 68 window decoration of coloured (*Am. colored*) glass
- 69 glass mosaic picture (glass mosaic)
- 70 mobile
- 71 paper kite (kite)
- 72 wooden construction
- 73 polyhedron
- 74 hand puppets
- 75 clay masks
- 76 cast candles (wax candles)
- 77 wood carving
- 78 clay jug
- 79 geometrical shapes made of clay
- 80 wooden toys
- 81 materials
- 82 stock of wood
- 83 inks for wood cuts
- 84 paintbrushes
- 85 bag of plaster of Paris



- 1-45 grammar school; also: upper band of a comprehensive school (*Am.* alternative school)
- 1-13 chemistry
- 1 chemistry lab (chemistry laboratory) with tiered rows of seats
- 2 chemistry teacher
- 3 demonstration bench (teacher's bench)
- 4 water pipe
- 5 tiled working surface
- 6 sink
- 7 television monitor, a screen for educational programmes (*Am.* programs)
- 8 overhead projector
- 9 projector top for skins
- 10 projection lens with right-angle mirror
- 11 pupils' (*Am.* students') bench with experimental apparatus
- 12 electrical point (socket)
- 13 projection table
- 14-34 biology preparation room (biology prep room)
- 14 skeleton
- 15 casts of skulls
- 16 calvarium of Pithecanthropus Erectus
- 17 skull of Steinheim man
- 18 calvarium of Peking man (of Sinanthropus)
- 19 skull of Neanderthal man, a skull of primitive man
- 20 Australopithecine skull (skull of Australopithecus)
- 21 skull of present-day man
- 22 dissecting bench
- 23 chemical bottles
- 24 gas tap
- 25 petri dish
- 26 measuring cylinder
- 27 work folder (teaching material)
- 28 textbook
- 29 bacteriological cultures
- 30 incubator
- 31 test tube rack
- 32 washing bottle
- 33 water tank
- 34 sink
- 35 language laboratory
- 36 blackboard

- 37 console
- 38 headphones (headset)
- 39 microphone
- 40 earcups
- 41 padded headband (padded headpiece)
- 42 programme (*Am.* program) recorder, a cassette recorder
- 43 pupil's (*Am.* student's) volume control
- 44 master volume control
- 45 control buttons (operating keys)

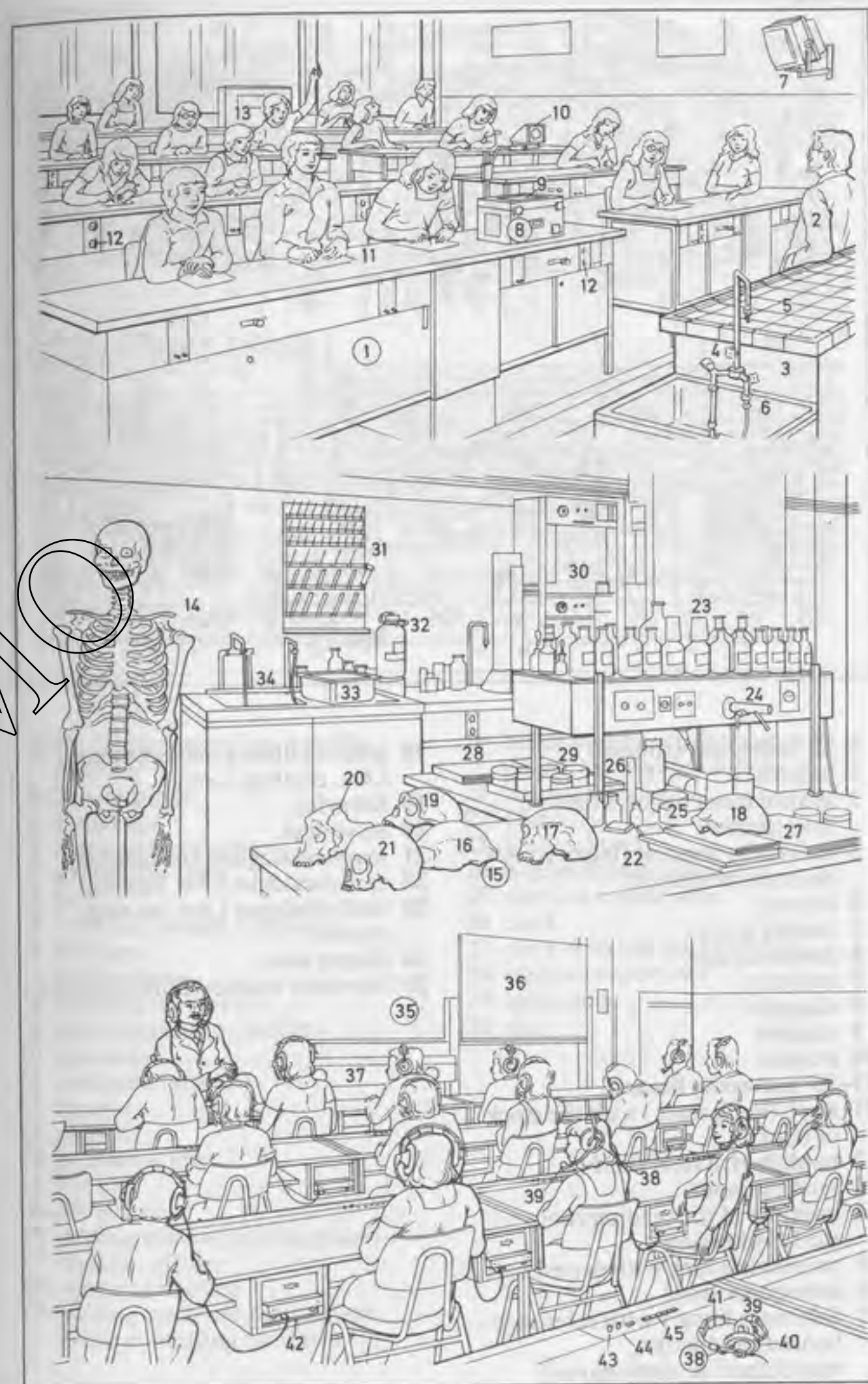

**1-25 university (college)**

- 1 lecture
- 2 lecture room (lecture theatre, *Am.* theater)
- 3 university lecturer (lecturer, *Am.* assistant professor)
- 4 lectern
- 5 lecture notes
- 6 demonstrator
- 7 assistant
- 8 diagram
- 9 student
- 10 student

11-25 university library

- 11 stack (book stack) with the stock of books
- 12 bookshelf, a steel shelf
- 13 reading room
- 14 member of the reading room staff, a librarian
- 15 periodicals rack with periodicals
- 16 newspaper shelf
- 17 reference library with reference books (handbooks, encyclopedias, dictionaries)

18 lending library and catalogue (*Am.* catalog) room

- 19 librarian
- 20 issue desk
- 21 main catalogue (*Am.* catalog)
- 22 card catalogue (*Am.* catalog)
- 23 card catalogue (*Am.* catalog) drawer
- 24 library user
- 25 borrower's ticket (library ticket)

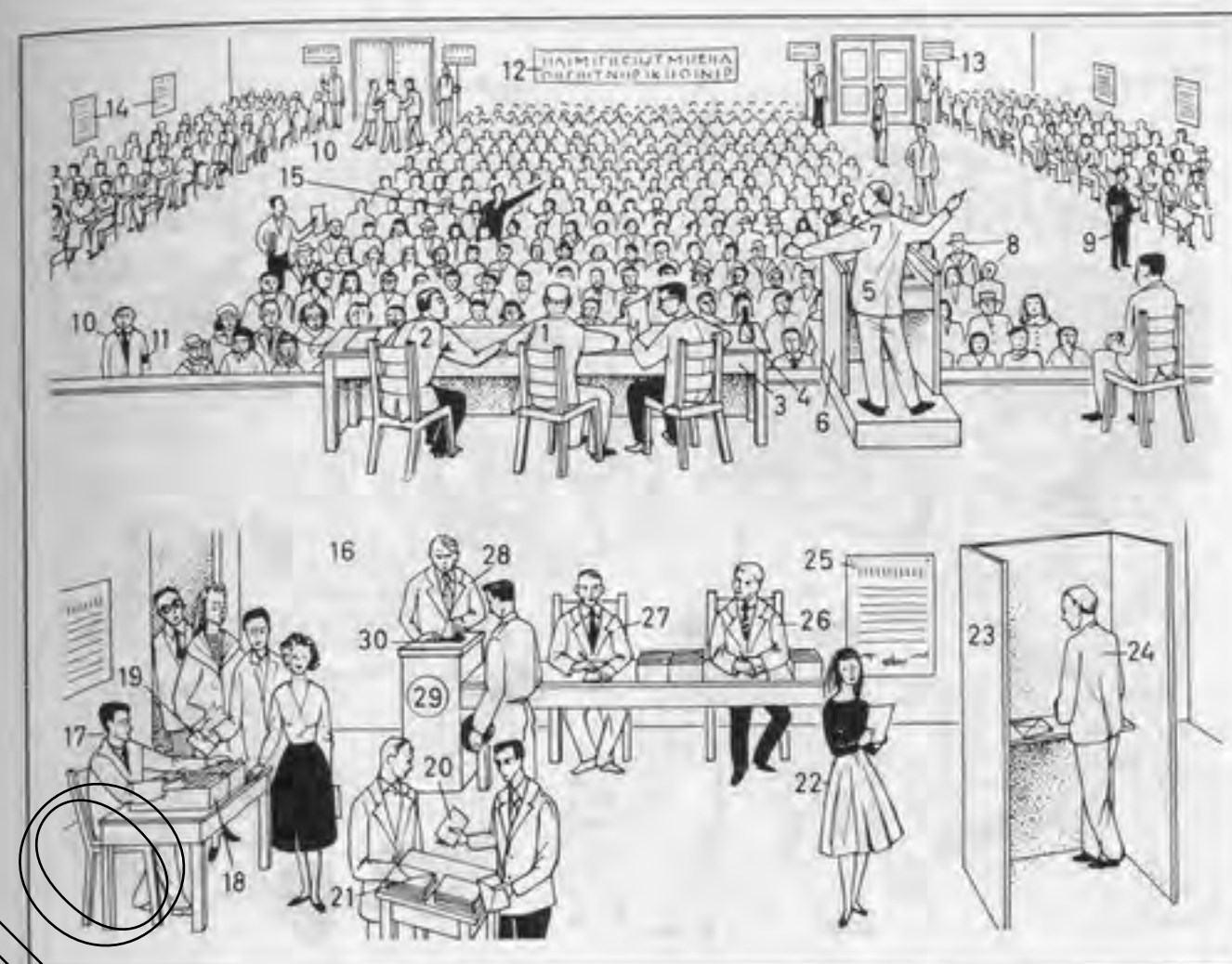
**1-15 election meeting, a public meeting**

- 1-2 committee
- 1 chairman
- 2 committee member
- 3 committee table
- 4 bell
- 5 election speaker (speaker)
- 6 rostrum
- 7 microphone
- 8 meeting (audience)
- 9 man distributing leaflets

10 stewards**11 armband (armlet)****12 banner****13 placard****14 proclamation****15 heckler****16-30 election****16 polling station (polling place)****17 election officer****18 electoral register****19 polling card with registration number (polling number)****20 ballot paper with the names of the parties and candidates****21 ballot envelope****22 voter****23 polling booth****24 elector (qualified voter)****25 election regulations****26 clerk****27 clerk with the duplicate list****28 election supervisor****29 ballot box****30 slot**

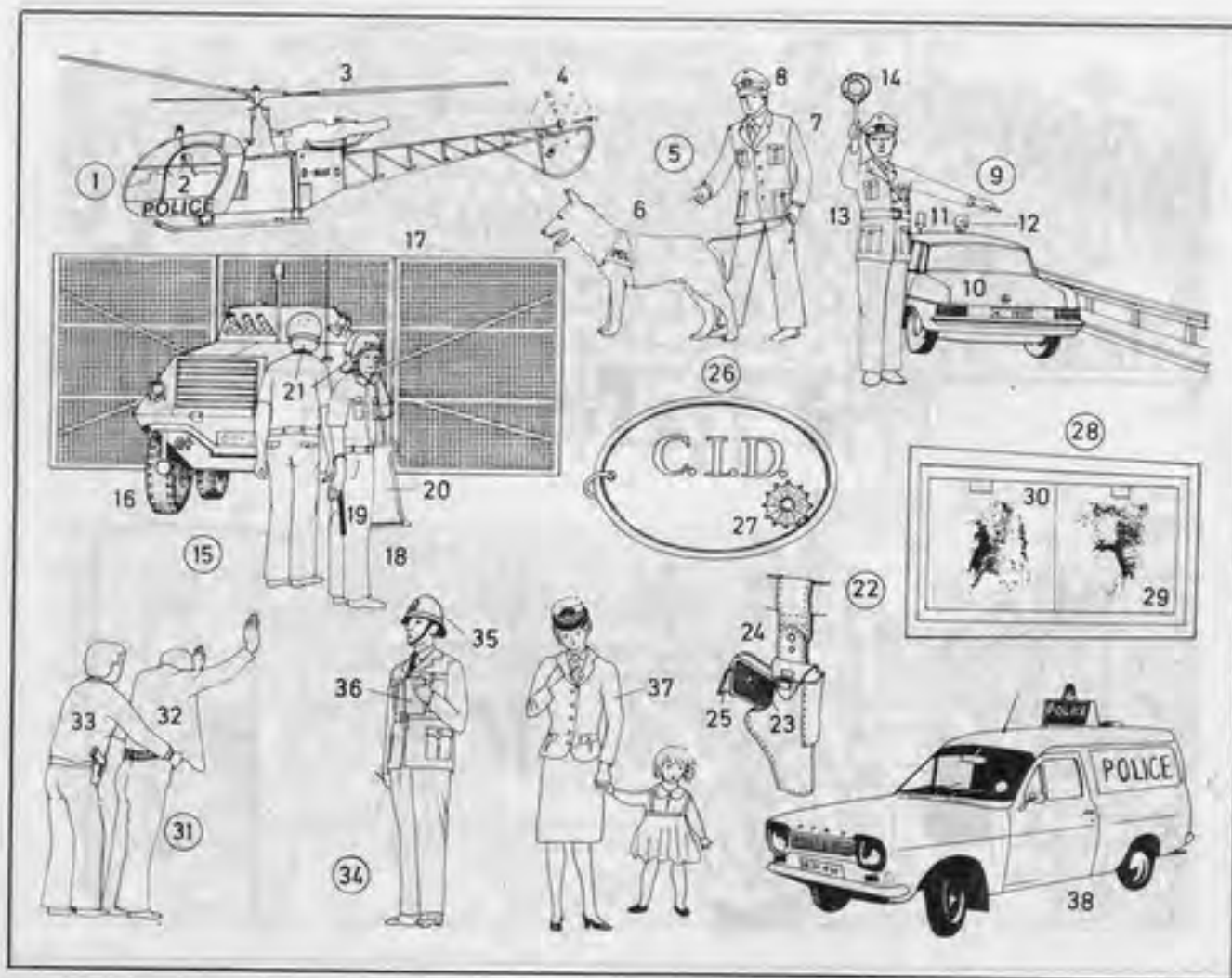

1-33 police duties

- 1 **police helicopter** (traffic helicopter) for controlling (*Am.* controlling) traffic from the air
- 2 cockpit
- 3 rotor (main rotor)
- 4 tail rotor
- 5 **police dog and handler**
- 6 police dog
- 7 uniform
- 8 uniform cap, a peaked cap with cockade
- 9 **traffic control by a mobile traffic patrol**
- 10 patrol car
- 11 blue light
- 12 loud hailer (loudspeaker)
- 13 patrolman (police patrolman)
- 14 police signalling (*Am.* signaling) disc (disk)
- 15 **riot duty**
- 16 special armoured (*Am.* armored) car
- 17 barricade

- 18 policeman (police officer) in riot gear
- 19 truncheon (baton)
- 20 riot shield
- 21 protective helmet (helmet)
- 22 **service pistol**
- 23 pistol grip
- 24 quick-draw holster
- 25 magazine
- 26 **police identification disc (disk)**
- 27 police badge
- 28 **fingerprint identification** (dactyloscopy)
- 29 fingerprint
- 30 illuminated screen
- 31 **search**
- 32 suspect
- 33 detective (plainclothes policeman)
- 34 English policeman
- 35 helmet
- 36 pocket book
- 37 policewoman
- 38 police van

1-26 café, *sim.*: espresso bar, tea room

- 1 counter (cake counter)
- 2 coffee urn
- 3 tray for the money
- 4 gâteau
- 5 meringue with whipped cream
- 6 trainee pastry cook
- 7 counter assistant
- 8 newspaper shelves (newspaper rack)
- 9 wall lamp
- 10 corner seat, an upholstered seat
- 11 café table
- 12 marble top
- 13 waitress
- 14 tray
- 15 bottle of lemonade
- 16 lemonade glass
- 17 chess players playing a game of chess
- 18 coffee set
- 19 cup of coffee
- 20 small sugar bowl
- 21 cream jug (*Am.* creamer)

- 22-24 café customers
- 22 gentleman
- 23 lady
- 24 man reading a newspaper
- 25 newspaper
- 26 newspaper holder

**1-29 restaurant****1-11 bar (counter)**

- 1 beer pump (beerpull)
- 2 drip tray
- 3 beer glass
- 4 froth (head)
- 5 spherical ashtray for cigarette and cigar ash
- 6 beer glass (beer mug)
- 7 beer warmer
- 8 bartender (barman, *Am.* barkeeper, barkeep)
- 9 shelf for glasses
- 10 shelf for bottles
- 11 stack of plates
- 12 coat stand
- 13 hat peg
- 14 coat hook
- 15 wall ventilator
- 16 bottle
- 17 complete meal
- 18 waitress
- 19 tray
- 20 lottery ticket seller
- 21 menu (menu card)

22 cruet stand

- 23 toothpick holder
- 24 matchbox holder
- 25 customer
- 26 beer mat
- 27 meal of the day
- 28 flower seller (flower girl)
- 29 flower basket
- 30-44 wine restaurant (wine bar)**
- 30 wine waiter, a head waiter
- 31 wine list
- 32 wine carafe
- 33 wineglass
- 34 tiled stove
- 35 stove tile
- 36 stove bench
- 37 wooden panelling (*Am.* paneling)
- 38 corner seat
- 39 corner table
- 40 regular customer
- 41 cutlery chest
- 42 wine cooler
- 43 bottle of wine
- 44 ice cubes (ice, lumps of ice)

**45-78 self-service restaurant**

- 45 stack of trays
- 46 drinking straws (straws)
- 47 serviettes (napkins)
- 48 cutlery holders
- 49 cool shelf
- 50 slice of honeydew melon
- 51 plate of salad
- 52 plate of cheeses
- 53 fish dish
- 54 filled roll
- 55 meat dish with trimmings
- 56 half chicken
- 57 basket of fruit
- 58 fruit juice
- 59 drinks shelf
- 60 bottle of milk
- 61 bottle of mineral water
- 62 vegetarian meal (diet meal)
- 63 tray
- 64 tray counter
- 65 food price list
- 66 serving hatch
- 67 hot meal
- 68 beer pump (beerpull)

69 cash desk

- 70 cashier
- 71 proprietor
- 72 rail
- 73 dining area
- 74 table
- 75 open sandwich
- 76 ice-cream sundae
- 77 salt cellar and pepper pot
- 78 table decoration (flower arrangement)

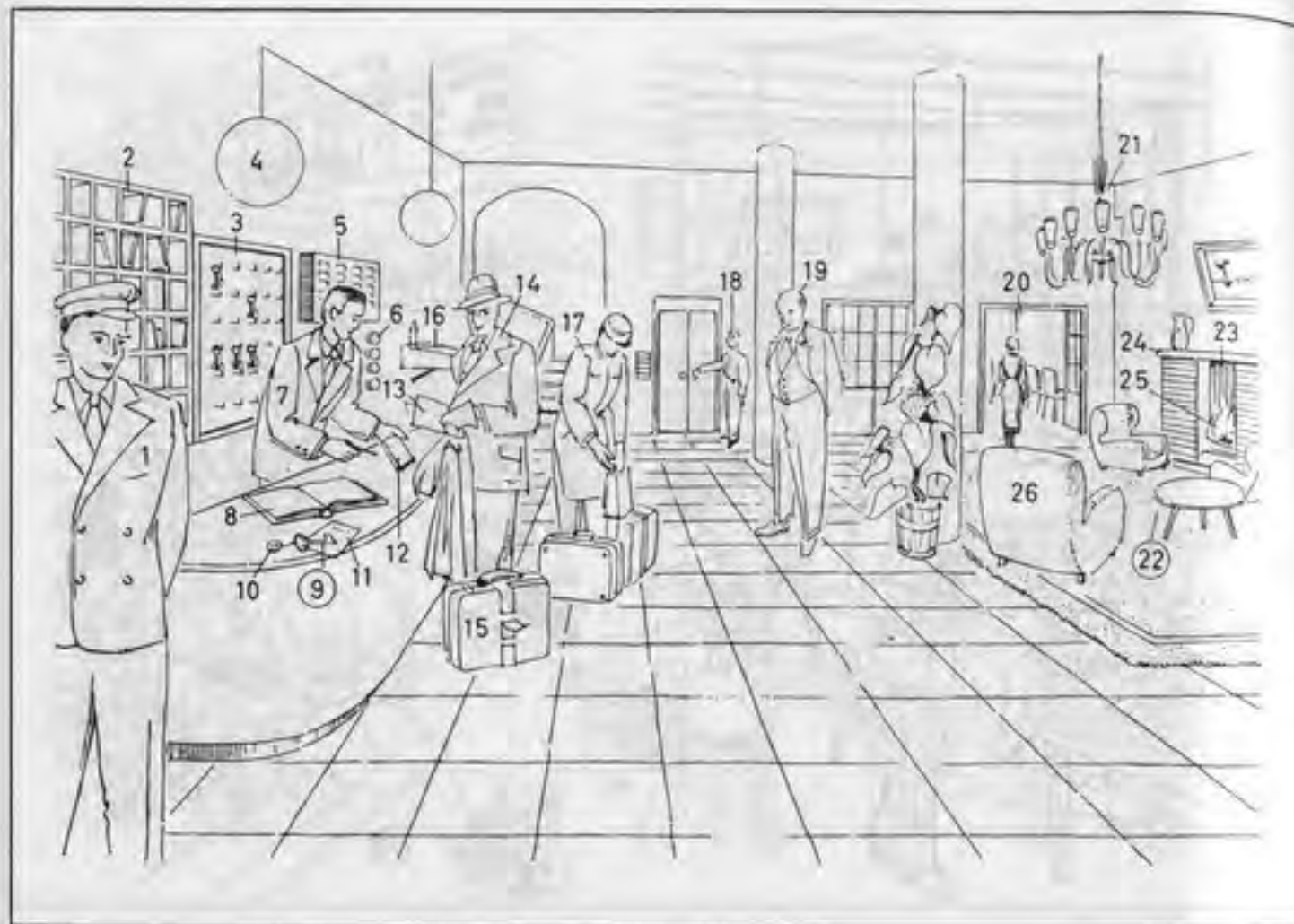

1-26 vestibule (foyer, reception hall)

- 1 doorman (commissionaire)
- 2 letter rack with pigeon holes
- 3 key rack
- 4 globe lamp, a frosted glass globe
- 5 indicator board (drop board)
- 6 indicator light
- 7 chief receptionist
- 8 register (hotel register)
- 9 room key
- 10 number tag (number tab) showing room number
- 11 hotel bill
- 12 block of registration forms
- 13 passport
- 14 hotel guest
- 15 lightweight suitcase, a light suitcase for air travel
- 16 wall desk
- 17 porter (*Am.* baggage man)
- 18-26 lobby (hotel lobby)
- 18 page (pageboy, *Am.* bell boy)
- 19 hotel manager
- 20 dining room (hotel restaurant)

21 chandelier

- 22 fireside
- 23 fireplace
- 24 mantelpiece (mantelshelf)
- 25 fire (open fire)
- 26 armchair
- 27-38 hotel room**, a double room with bath
- 27 double door
- 28 service bell panel
- 29 wardrobe trunk
- 30 clothes compartment
- 31 linen compartment
- 32 double washbasin
- 33 room waiter
- 34 room telephone
- 35 velour (velours) carpet
- 36 flower stand
- 37 flower arrangement
- 38 double bed
- 39 banquet room**
- 40-43 private party**
- 40 speaker proposing a toast
- 41 42's neighbour (*Am.* neighbor)
- 42 43's partner



43 42's partner

- 44-46 **thé dansant** (tea dance) in the foyer
- 44 bar trio
- 45 violinist
- 46 couple dancing (dancing couple)
- 47 waiter
- 48 napkin
- 49 cigar and cigarette boy
- 50 cigarette tray
- 51 hotel bar**
- 52 foot rail
- 53 bar stool
- 54 bar
- 55 bar customer
- 56 cocktail glass (*Am.* highball glass)
- 57 whisky (whiskey) glass
- 58 champagne cork
- 59 champagne bucket (champagne cooler)
- 60 measuring beaker (measure)
- 61 cocktail shaker
- 62 bartender (barman, *Am.* barkeeper, barkeep)

63 barmaid

- 64 shelf for bottles
- 65 shelf for glasses
- 66 mirrored panel
- 67 ice bucket



- | | |
|---|--|
| 1 parking meter | 22 rubbish (litter) |
| 2 map of the town (street map) | 23 tramlines (<i>Am.</i> streetcar tracks) |
| 3 illuminated board | 24 pedestrian crossing (zebra crossing, <i>Am.</i> crosswalk) |
| 4 key | 25 tram stop (<i>Am.</i> streetcar stop, trolley stop) |
| 5 litter bin (<i>Am.</i> litter basket) | 26 tram stop sign (<i>Am.</i> streetcar stop sign, trolley stop sign) |
| 6 street lamp (street light) | 27 tram timetable (<i>Am.</i> streetcar schedule) |
| 7 street sign showing the name of the street | 28 ticket machine |
| 8 drain | 29 'pedestrian crossing' sign |
| 9 clothes shop (fashion house) | 30 traffic policeman on traffic duty (point duty) |
| 10 shop window | 31 traffic control cuff |
| 11 window display (shop window display) | 32 white cap |
| 12 window decoration (shop window decoration) | 33 hand signal |
| 13 entrance | 34 motorcyclist |
| 14 window | 35 motorcycle |
| 15 window box | 36 pillion passenger (pillion rider) |
| 16 neon sign | 37 bookshop |
| 17 tailor's workroom | 38 hat shop (hatter's shop); for ladies' hats: milliner's shop |
| 18 pedestrian | 39 shop sign |
| 19 shopping bag | 40 insurance company office |
| 20 road sweeper (<i>Am.</i> street sweeper) | |
| 21 broom | |



- | | |
|---|---|
| 41 department store | 62 steps to the public lavatories (public conveniences) |
| 42 shop front | 63 taxi rank (taxi stand) |
| 43 advertisement | 64 taxi (taxicab, cab) |
| 44 flags | 65 taxi sign |
| 45 illuminated letters | 66 traffic sign showing 'taxi rank' ('taxi stand') |
| 46 tram (<i>Am.</i> streetcar, trolley) | 67 taxi telephone |
| 47 furniture lorry (<i>Am.</i> furniture truck) | 68 post office |
| 48 flyover | 69 cigarette machine |
| 49 suspended street lamp | 70 advertising pillar |
| 50 stop line | 71 poster (advertisement) |
| 51 pedestrian crossing (<i>Am.</i> crosswalk) | 72 white line |
| 52 traffic lights | 73 lane arrow for turning left |
| 53 traffic light post | 74 lane arrow for going straight ahead |
| 54 set of lights | 75 news vendor (<i>Am.</i> news dealer) |
| 55 pedestrian lights | |
| 56 telephone box (telephone booth, telephone kiosk, call box) | |
| 57 cinema advertisement (film poster) | |
| 58 pedestrian precinct (paved zone) | |
| 59 street café | |
| 60 group seated (sitting) at a table | |
| 61 sunshade | |

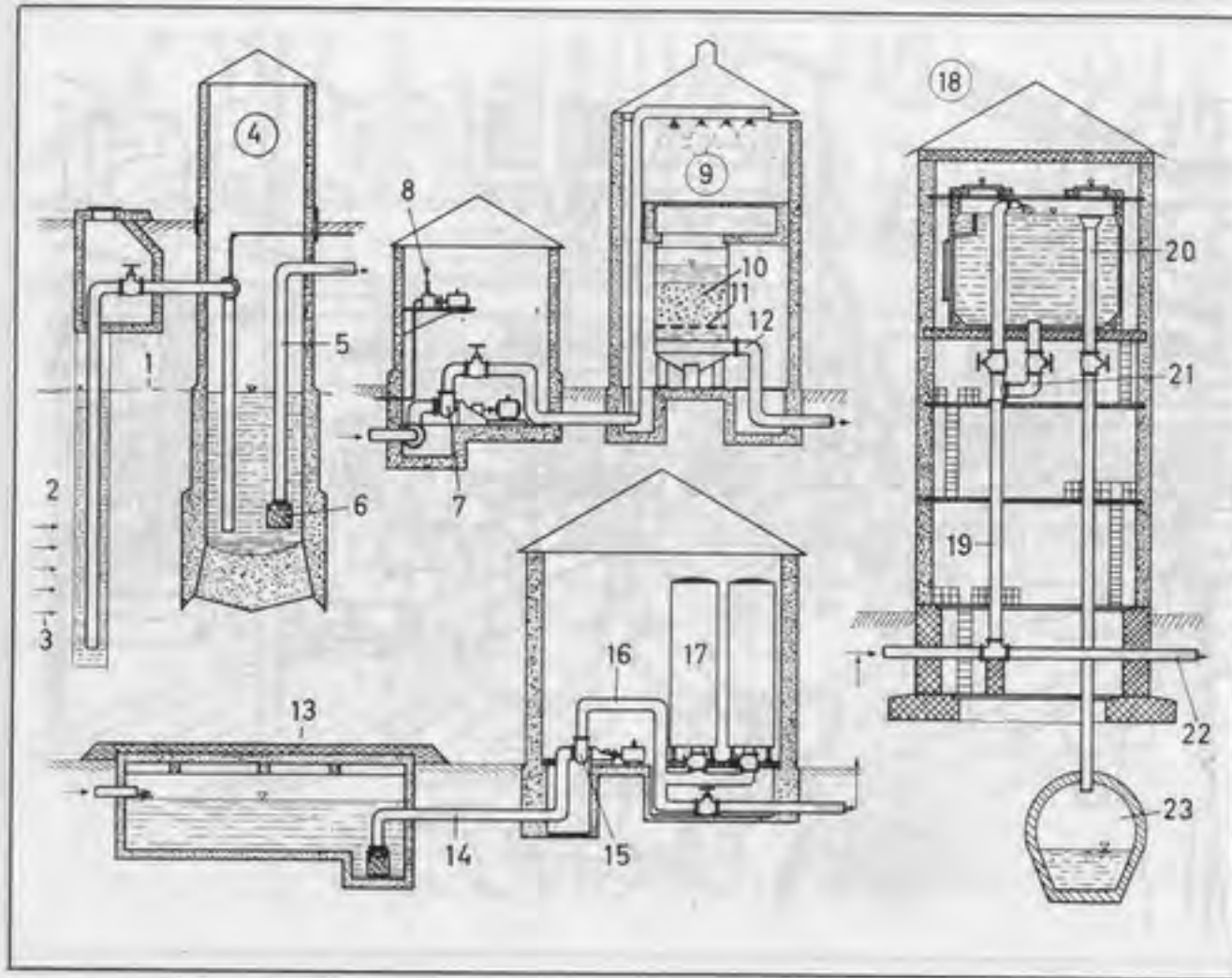

1-66 drinking water supply

- 1 water table (groundwater level)
- 2 water-bearing stratum (aquifer, aquafer)
- 3 groundwater stream (underground stream)
- 4 collector well for raw water
- 5 suction pipe
- 6 pump strainer (with foot valve)
- 7 bucket pump with motor
- 8 vacuum pump with motor
- 9 rapid-filter plant
- 10 filter gravel (filter bed)
- 11 filter bottom, a grid
- 12 filtered water outlet
- 13 purified water tank
- 14 suction pipe with pump strainer and foot valve
- 15 main pump with motor
- 16 delivery pipe
- 17 compressed-air vessel (air vessel, air receiver)
- 18 water tower
- 19 riser pipe (riser)
- 20 overflow pipe
- 21 outlet
- 22 distribution main
- 23 excess water conduit
- 24-39 tapping a spring
- 24 chamber
- 25 chamber wall
- 26 manhole
- 27 ventilator
- 28 step irons
- 29 filling (backing)
- 30 outlet control valve
- 31 outlet valve
- 32 strainer
- 33 overflow pipe (overflow)
- 34 bottom outlet
- 35 earthenware pipes
- 36 impervious stratum (impermeable stratum)
- 37 rough rubble
- 38 water-bearing stratum (aquifer, aquafer)
- 39 loam seal (clay seal)
- 40-52 individual water supply
- 40 well
- 41 suction pipe

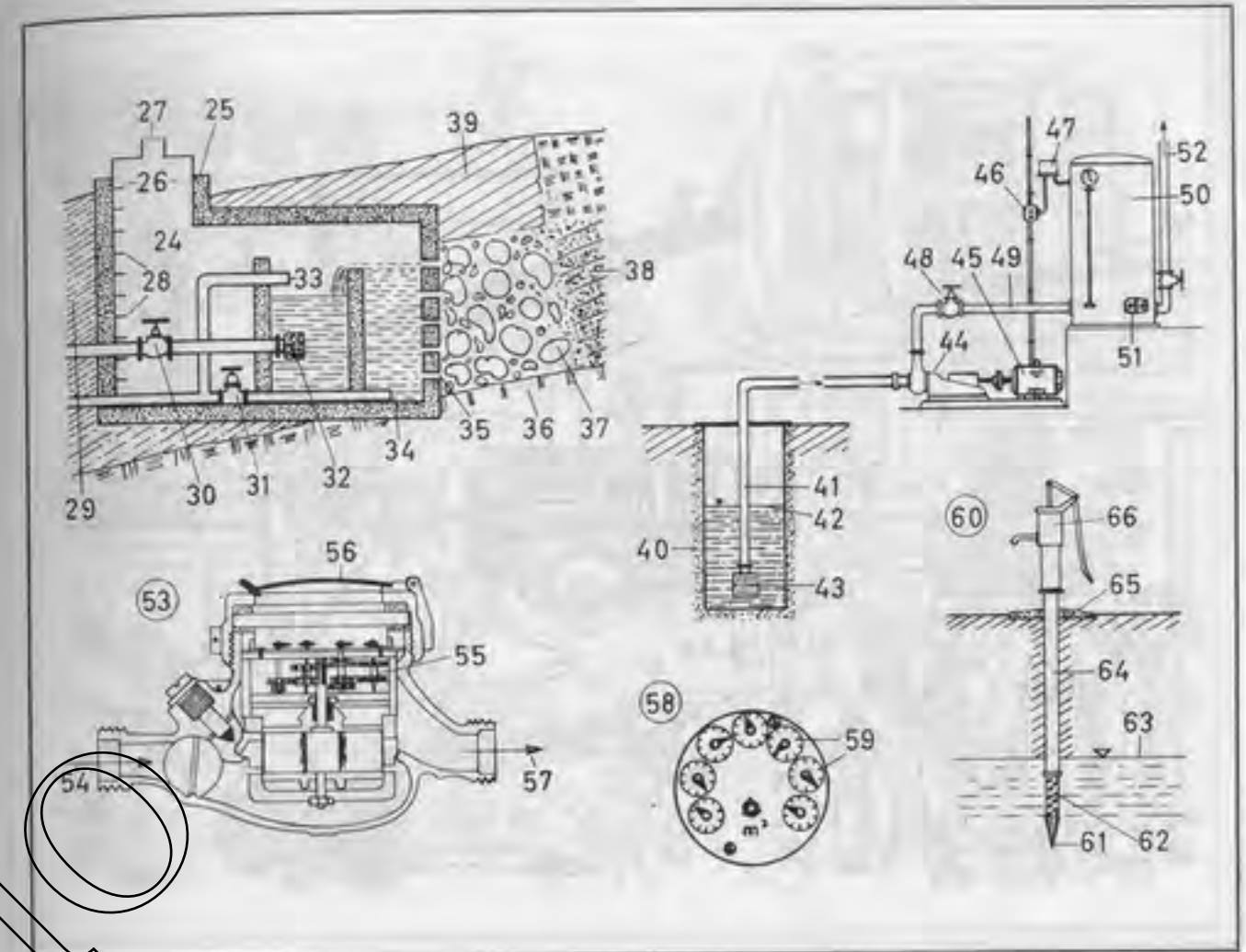

- 42 water table (groundwater level)
- 43 pump strainer with foot valve
- 44 centrifugal pump
- 45 motor
- 46 motor safety switch
- 47 manostat, a switching device
- 48 stopcock
- 49 delivery pipe
- 50 compressed-air vessel (air vessel, air receiver)
- 51 manhole
- 52 delivery pipe
- 53 water meter, a rotary meter
- 54 water inlet
- 55 counter gear assembly
- 56 cover with glass lid
- 57 water outlet
- 58 water-meter dial
- 59 counters
- 60 driven well (tube well, drive well)
- 61 pile shoe
- 62 filter
- 63 water table (groundwater level)
- 64 well casing
- 65 well head
- 66 hand pump

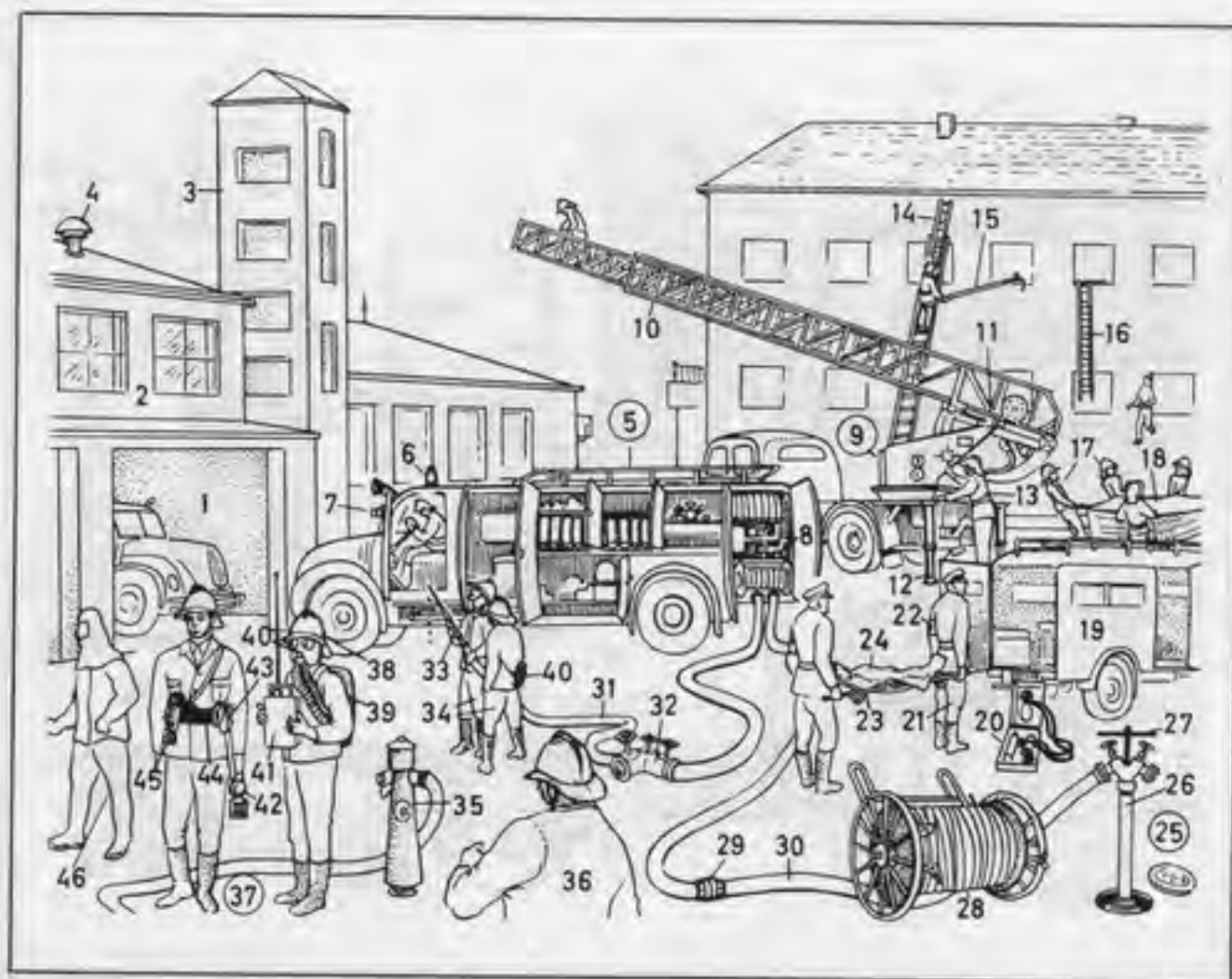
**1-46 fire service drill**

- (extinguishing, climbing, ladder, and rescue work)
- 1-3** fire station
- 1 engine and appliance room
- 2 firemen's quarters
- 3 drill tower
- 4 fire alarm (fire alarm siren, fire siren)
- 5 fire engine
- 6 blue light (warning light), a flashing light (*Am.* flashlight)
- 7 horn (hooter)
- 8 motor pump, a centrifugal pump
- 9 motor turntable ladder (*Am.* aerial ladder)
- 10 ladder, a steel ladder (automatic extending ladder)
- 11 ladder mechanism
- 12 jack
- 13 ladder operator
- 14 extension ladder
- 15 ceiling hook (*Am.* preventer)
- 16 hook ladder (*Am.* pompier ladder)

- 17 holding squad
- 18 jumping sheet (sheet)
- 19 ambulance car (ambulance)
- 20 resuscitator (resuscitation equipment), oxygen apparatus
- 21 ambulance attendant (ambulance man)
- 22 armband (armlet, brassard)
- 23 stretcher
- 24 unconscious man
- 25 pit hydrant
- 26 standpipe (riser, vertical pipe)
- 27 hydrant key
- 28 hose reel (*Am.* hose cart, hose wagon, hose truck, hose carriage)
- 29 hose coupling
- 30 soft suction hose
- 31 delivery hose
- 32 dividing breeching
- 33 branch
- 34 branchmen
- 35 surface hydrant (fire plug)
- 36 officer in charge
- 37 fireman (*Am.* firefighter)

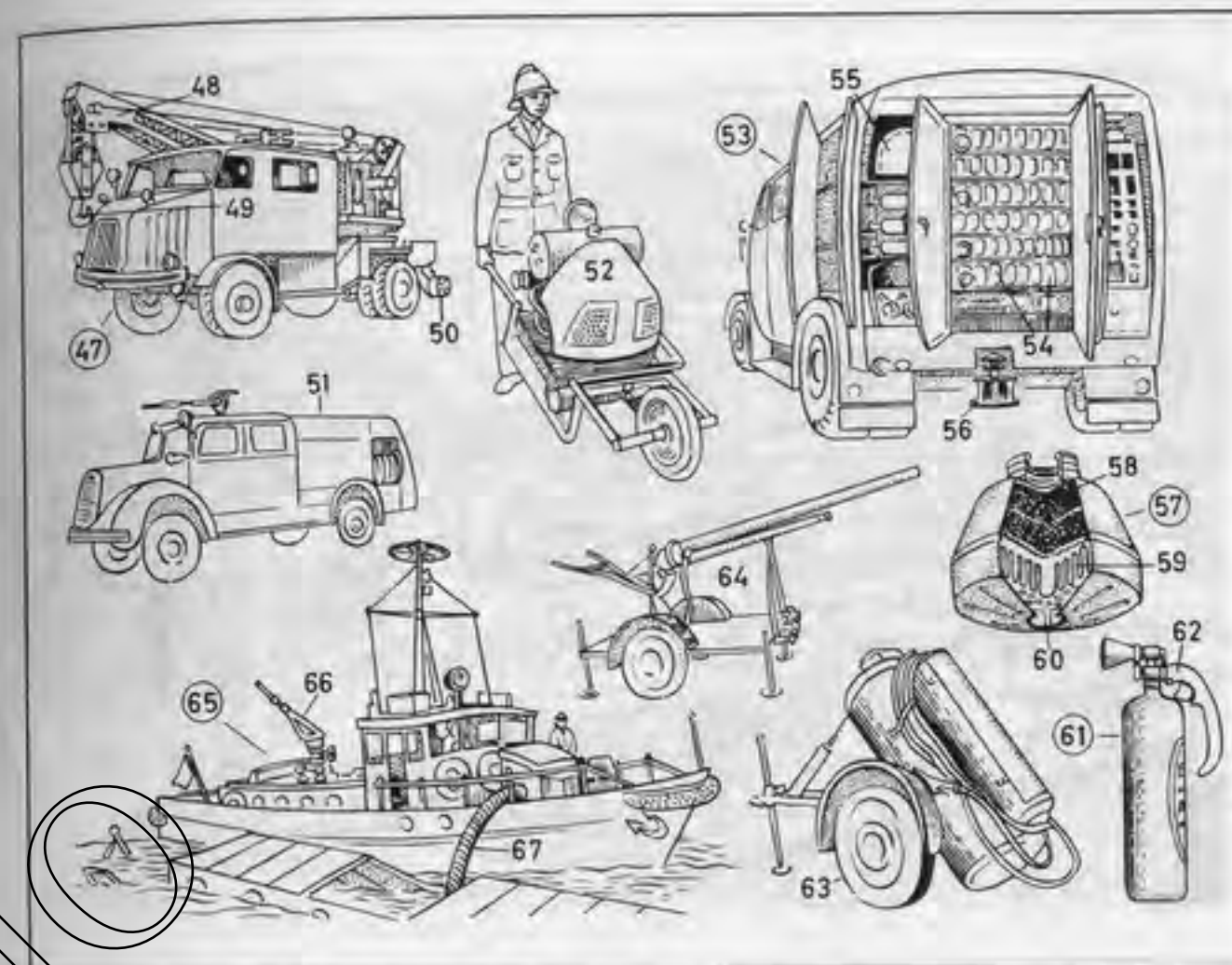

- 38 helmet (fireman's helmet, *Am.* fire hat)
- 39 breathing apparatus
- 40 face mask
- 41 walkie-talkie set
- 42 hand lamp
- 43 small axe (*Am.* ax, pompier hatchet)
- 44 hook belt
- 45 beltline
- 46 protective clothing of asbestos (asbestos suit) or of metallic fabric
- 47 breakdown lorry (*Am.* crane truck, wrecking crane)
- 48 lifting crane
- 49 load hook (draw hook, *Am.* drag hook)
- 50 support roll
- 51 water tender
- 52 portable pump
- 53 hose layer
- 54 flaked lengths of hose
- 55 cable drum

- 56 winch
- 57 face mask filter
- 58 active carbon (activated carbon, activated charcoal)
- 59 dust filter
- 60 air inlet
- 61 portable fire extinguisher
- 62 trigger valve
- 63 large mobile extinguisher (wheeled fire extinguisher)
- 64 foam-making branch (*Am.* foam gun)
- 65 fireboat
- 66 monitor (water cannon)
- 67 suction hose



- 1 cashier
- 2 electric cash register (till)
- 3 number keys
- 4 cancellation button
- 5 cash drawer (till)
- 6 compartments (money compartments) for coins and notes (*Am.* bills)
- 7 receipt (sales check)
- 8 cash total
- 9 adding mechanism
- 10 goods
- 11 glass-roofed well
- 12 men's wear department
- 13 showcase (display case, indoor display window)
- 14 wrapping counter
- 15 tray for purchases
- 16 customer
- 17 hosiery department
- 18 shop assistant (*Am.* salesgirl, saleslady)
- 19 price card
- 20 glove stand

- 21 duffle coat, a three-quarter length coat
- 22 escalator
- 23 fluorescent light (fluorescent lamp)
- 24 office (e.g. customer accounts office, travel agency, manager's office)
- 25 poster (advertisement)
- 26 theatre (*Am.* theater) and concert booking office (advance booking office)
- 27 shelves
- 28 ladies' wear department
- 29 ready-made dress (ready-to-wear dress, *coll.* off-the-peg dress)
- 30 dust cover
- 31 clothes rack
- 32 changing booth (fitting booth)
- 33 shop walker (*Am.* floorwalker, floor manager)
- 34 dummy
- 35 seat (chair)

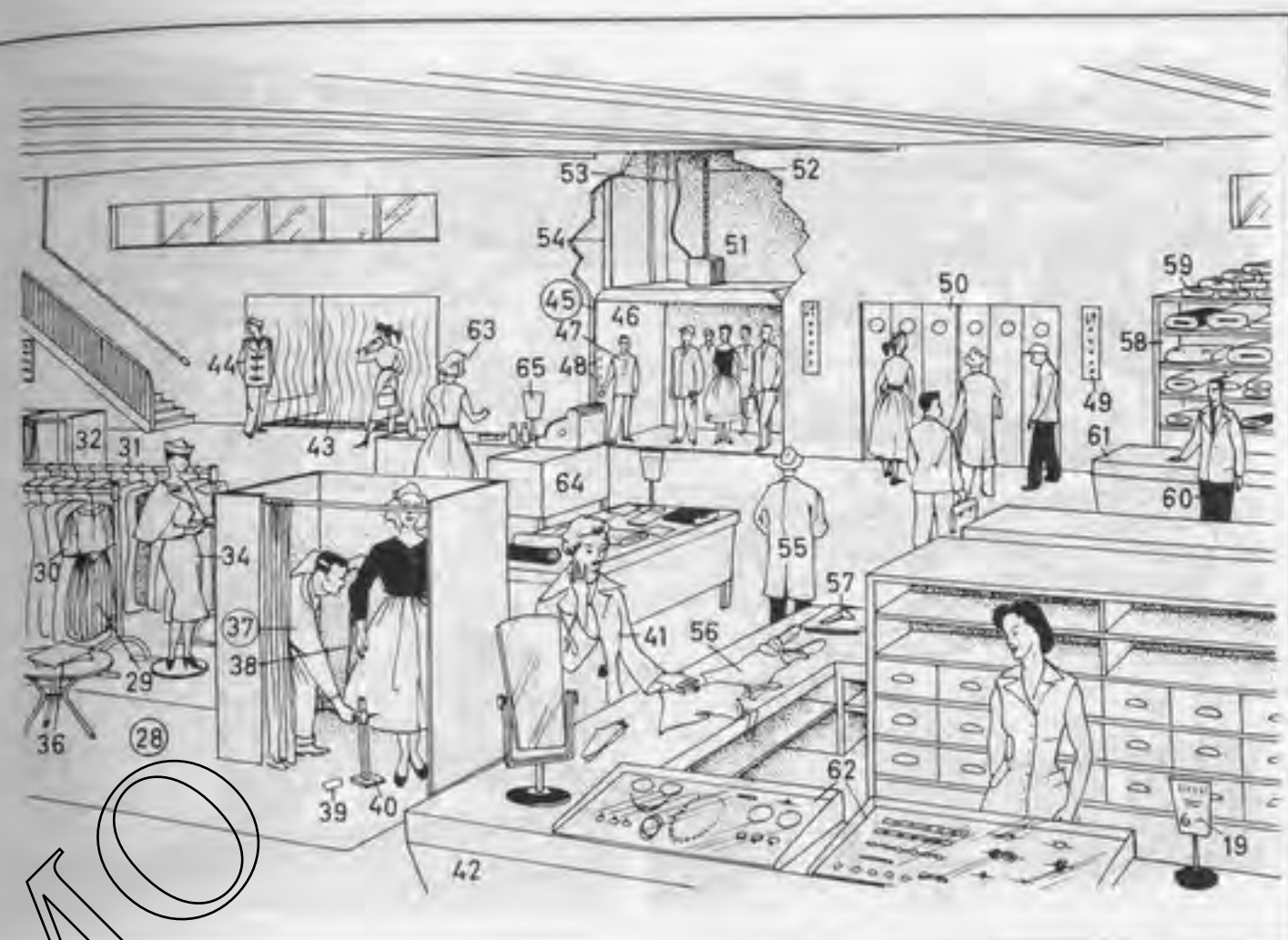

- 36 fashion journal (fashion magazine)
- 37 tailor marking a hemline
- 38 measuring tape (tape measure)
- 39 tailor's chalk (*French* chalk)
- 40 hemline marker
- 41 loose-fitting coat
- 42 sales counter
- 43 warm-air curtain
- 44 doorman (commissionaire)
- 45 lift (*Am.* elevator)
- 46 lift cage (lift car, *Am.* elevator car)
- 47 lift operator (*Am.* elevator operator)
- 48 controls (lift controls, *Am.* elevator controls)
- 49 floor indicator
- 50 sliding door
- 51 lift shaft (*Am.* elevator shaft)
- 52 bearer cable
- 53 control cable
- 54 guide rail
- 55 customer

- 56 hosiery
- 57 linen goods (table linen and bed linen)
- 58 fabric department
- 59 roll of fabric (roll of material, roll of cloth)
- 60 head of department (department manager)
- 61 sales counter
- 62 jewellery (*Am.* jewelry) department
- 63 assistant (*Am.* salesgirl, saleslady), selling new lines (new products)
- 64 special counter (extra counter)
- 65 placard advertising special offers
- 66 curtain department
- 67 display on top of the shelves

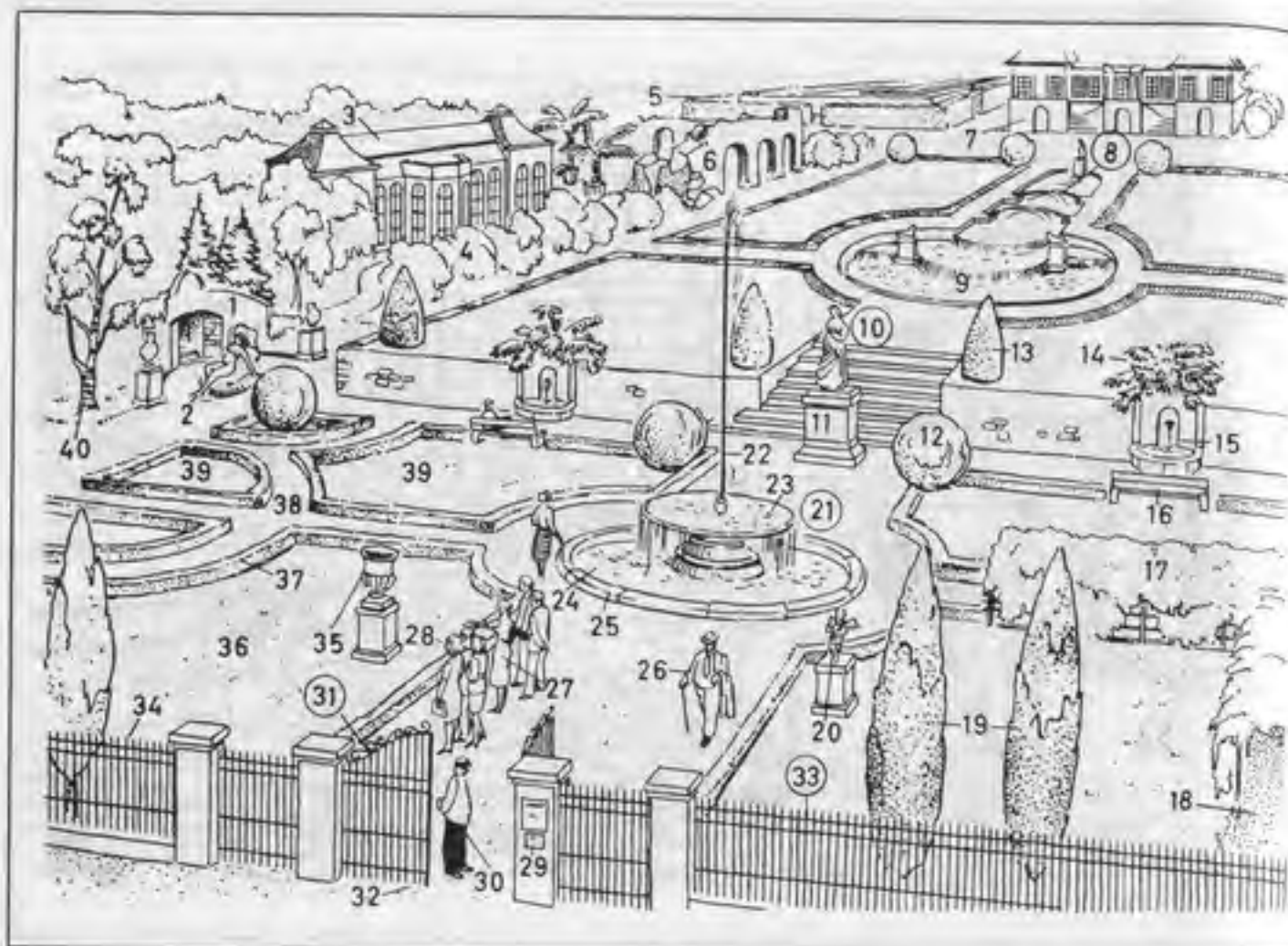

- 1-40 formal garden** (French Baroque garden), palace gardens
- 1 grotto (cavern)
 - 2 stone statue, a river nymph
 - 3 orangery (orangerie)
 - 4 boschage (boskage)
 - 5 maze (labyrinth of paths and hedges)
 - 6 open-air theatre (*Am.* theater)
 - 7 Baroque palace
 - 8 fountains
 - 9 cascade (broken artificial waterfall, artificial falls)
 - 10 statue, a monument
 - 11 pedestal (base of statue)
 - 12 globe-shaped tree
 - 13 conical tree
 - 14 ornamental shrub
 - 15 wall fountain
 - 16 park bench
 - 17 pergola (bower, arbour, *Am.* arbor)
 - 18 gravel path (gravel walk)
 - 19 pyramid tree (pyramidal tree)

- 20 cupid (cherub, amoretto, amorino)
- 21 fountain
- 22 fountain
- 23 overflow basin
- 24 basin
- 25 kerb (curb)
- 26 man out for a walk
- 27 tourist guide
- 28 group of tourists
- 29 park by-laws (*bye-laws*)
- 30 park keeper
- 31 garden gates, wrought iron gates
- 32 park entrance
- 33 park railings
- 34 railing (bar)
- 35 stone vase
- 36 lawn
- 37 border, a trimmed (clipped) hedge
- 38 park path
- 39 parterre
- 40 birch (birch tree)

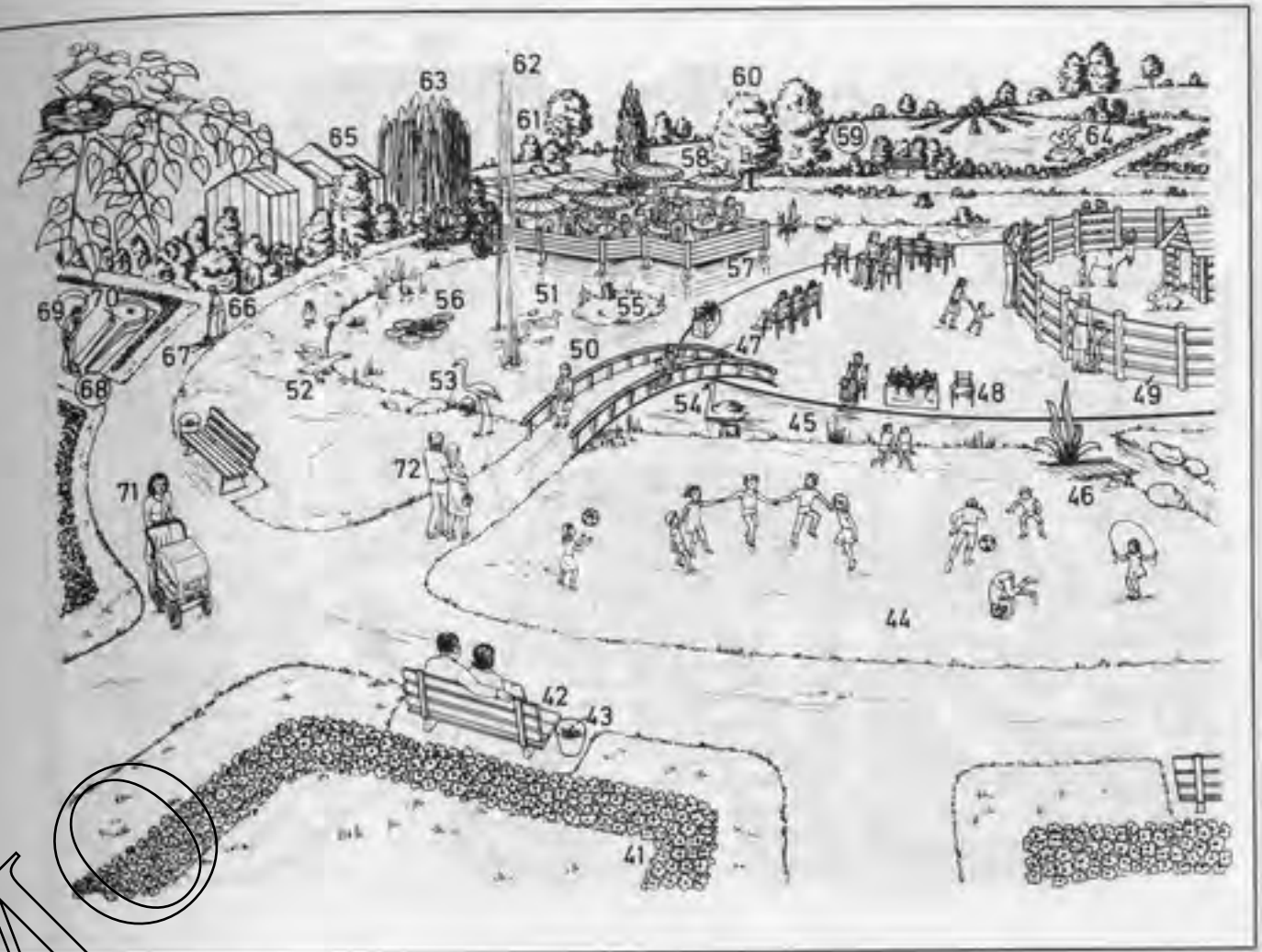

- 41-72 landscaped park** (*jardin anglais*)
- 41 flower bed
 - 42 park bench (garden seat)
 - 43 litter bin (*Am.* litter basket)
 - 44 play area
 - 45 stream
 - 46 jetty
 - 47 bridge
 - 48 park chair
 - 49 animal enclosure
 - 50 pond
 - 51-54 waterfowl
 - 51 wild duck with young
 - 52 goose
 - 53 flamingo
 - 54 swan
 - 55 island
 - 56 water lily
 - 57 open-air café
 - 58 sunshade
 - 59 tree
 - 60 treetop (crown)
 - 61 group of trees

- 62 fountain
- 63 weeping willow
- 64 modern sculpture
- 65 hothouse
- 66 park gardener
- 67 broom
- 68 minigolf course
- 69 minigolf player
- 70 minigolf hole
- 71 mother with pram (baby carriage)
- 72 courting couple (young couple)



- | | |
|---|--|
| 1 table tennis | 23 lookout platform |
| 2 table | 24 slide |
| 3 table tennis net | 25 litter bin (<i>Am.</i> litter basket) |
| 4 table tennis racket (raquet) (table tennis bat) | 26 teddy bear |
| 5 table tennis ball | 27 wooden train set |
| 6 badminton game (shuttlecock game) | 28 paddling pool |
| 7 shuttlecock | 29 sailing boat (yacht, <i>Am.</i> sailboat) |
| 8 maypole swing | 30 toy duck |
| 9 child's bicycle | 31 pram (baby carriage) |
| 10 football (soccer) | 32 high bar (bar) |
| 11 goal (goalposts) | 33 go-cart (soap box) |
| 12 football | 34 starter's flag |
| 13 goal scorer | 35 seesaw |
| 14 goalkeeper | 36 robot |
| 15 skipping (<i>Am.</i> jumping rope) | 37 flying model aeroplanes (<i>Am.</i> airplanes) |
| 16 skipping rope (<i>Am.</i> skip rope, jump rope, jumping rope) | 38 model aeroplane (<i>Am.</i> airplane) |
| 17 climbing tower | 39 double swing |
| 18 rubber tyre (<i>Am.</i> tire) swing | 40 swing seat |
| 19 lorry tyre (<i>Am.</i> truck tire) | 41 flying kites |
| 20 bouncing ball | 42 kite |
| 21 adventure playground | 43 tail of the kite |
| 22 log ladder | 44 kite string |

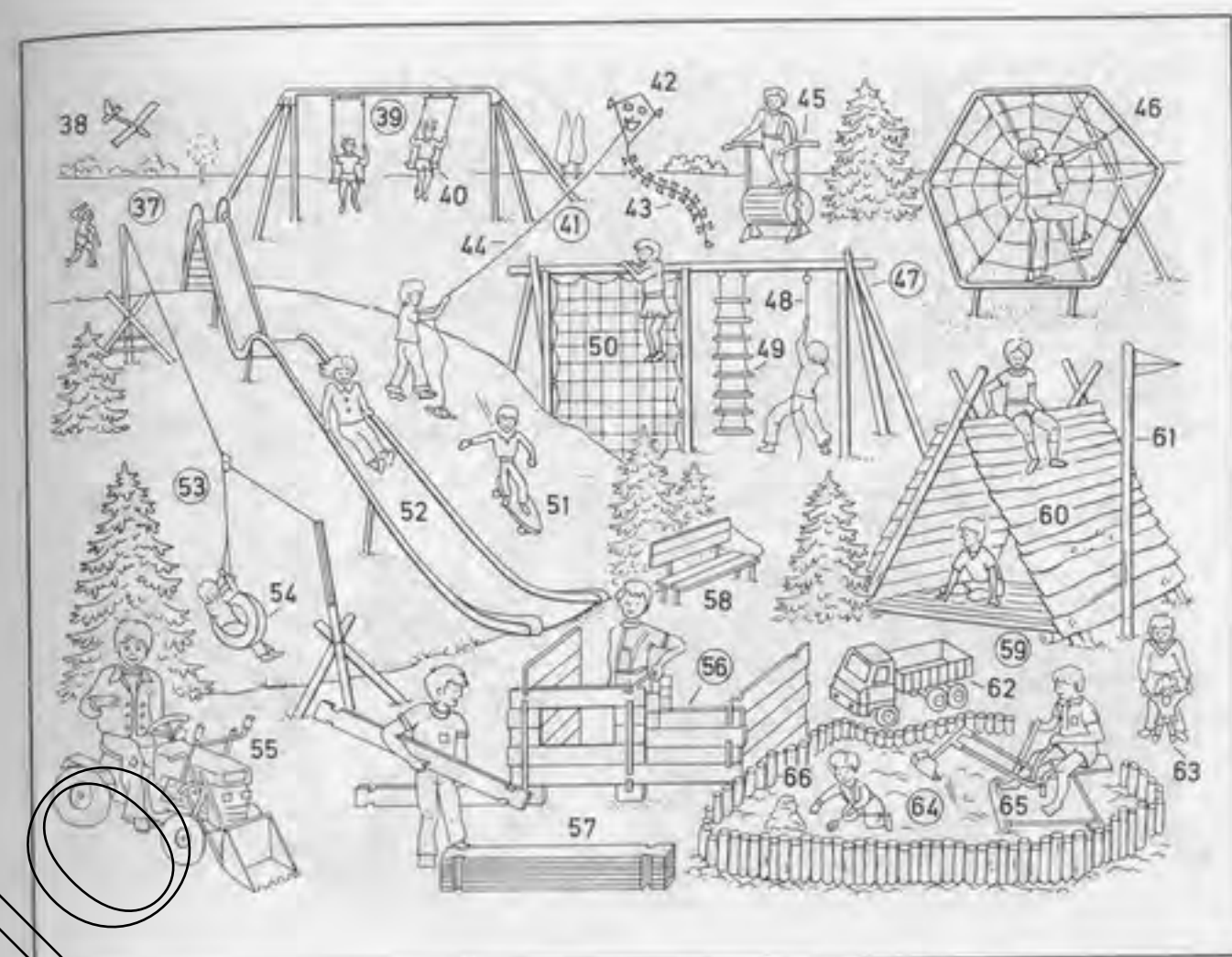

- | |
|---|
| 47 climbing frame |
| 48 climbing rope |
| 49 rope ladder |
| 50 climbing net |
| 51 skateboard |
| 52 up-and-down slide |
| 53 rubber tyre (<i>Am.</i> tire) cable car |
| 54 rubber tyre (<i>Am.</i> tire) |
| 55 tractor, a pedal car |
| 56 den |
| 57 presawn boards |
| 58 seat (bench) |
| 59 Indian hut |
| 60 climbing roof |
| 61 flagpole (flagstaff) |
| 62 toy lorry (<i>Am.</i> toy truck) |
| 63 walking doll |
| 64 sandpit (<i>Am.</i> sandbox) |
| 65 toy excavator (toy digger) |
| 66 sandhill |

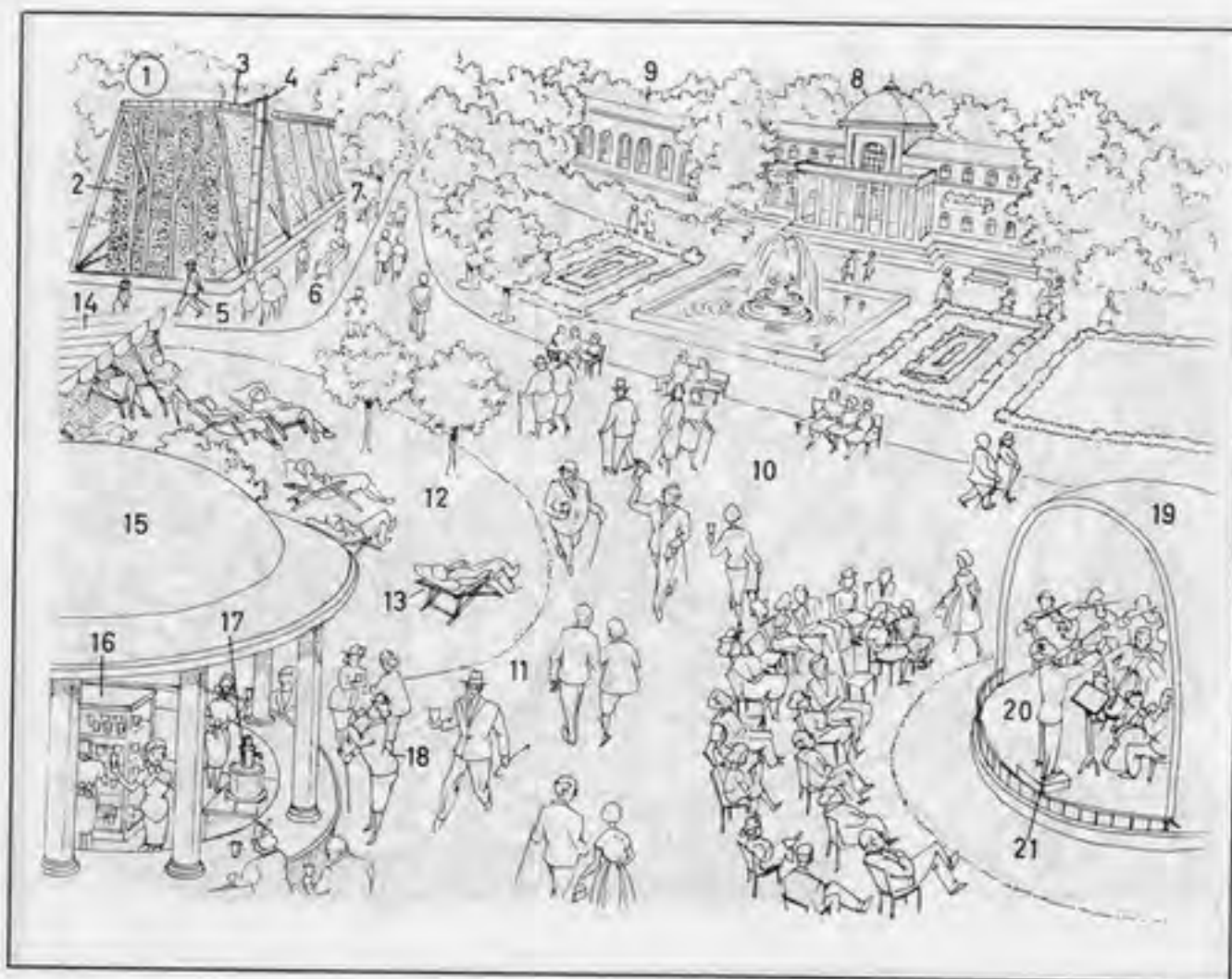

- 1-21 spa gardens
 1-7 salina (salt works)
 1 thorn house (graduation house)
 2 thorns (brushwood)
 3 brine channels
 4 brine pipe from the pumping station
 5 salt works attendant
 6-7 inhalational therapy
 6 open-air inhalatorium (outdoor inhalatorium)
 7 patient inhaling (taking an inhalation)
 8 hydropathic (pump room) with kursaal (casino)
 9 colonnade
 10 spa promenade
 11 avenue leading to the mineral spring
 12-14 rest cure
 12 sunbathing area (lawn)
 13 deck-chair
 14 sun canopy
 15 pump room
 16 rack for glasses
 17 tap
 18 patient taking the waters
 19 bandstand
 20 spa orchestra giving a concert
 21 conductor

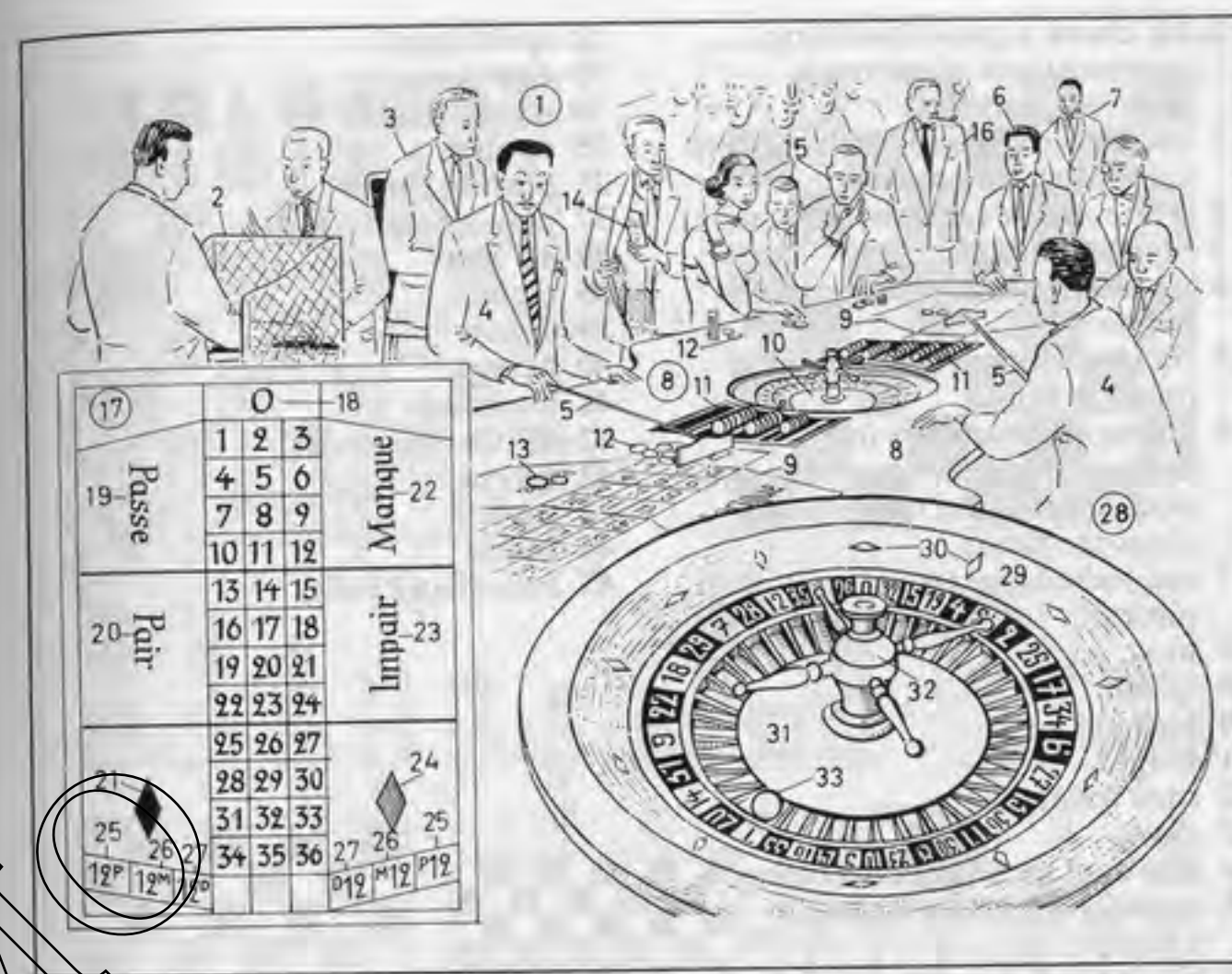

- 1-33 roulette, a game of chance (gambling game)
 1 gaming room in a casino (gambling casino)
 2 cash desk
 3 tourneur (dealer)
 4 croupier
 5 rake
 6 head croupier
 7 hall manager
 8 roulette table (gaming table, gambling table)
 9 roulette layout
 10 roulette wheel
 11 bank
 12 chip (check, plaque)
 13 stake
 14 membership card
 15 roulette player
 16 private detective (house detective)
 17 roulette layout
 18 zero (nought, O)
 19 passe (high) [numbers 19 to 36]
 20 pair (even numbers)
 21 noir (black)
 22 manque (low) [numbers 1 to 18]
 23 impair [odd numbers]
 24 rouge (red)
 25 douze premier (first dozen) [numbers 1 to 12]
 26 douze milieu (second dozen) [numbers 13 to 24]
 27 douze dernier (third dozen) [numbers 25 to 36]
 28 roulette wheel (roulette)
 29 roulette bowl
 30 fret (separator)
 31 revolving disc (disk) showing numbers 0 to 36
 32 spin
 33 roulette ball

- 1-16 chess, a game involving combinations of moves, a positional game
- 1 chessboard (board) with the men (chessmen) in position
- 2 white square (chessboard square)
- 3 black square
- 4 white chessmen (white pieces) [white = W]
- 5 black chessmen (black pieces) [black = B]
- 6 letters and numbers for designating chess squares in the notation of chess moves and chess problems
- 7 individual chessmen (individual pieces)
- 8 king
- 9 queen
- 10 bishop
- 11 knight
- 12 rook (castle)
- 13 pawn
- 14 moves of the individual pieces
- 15 mate (checkmate), a mate by knight
- 16 chess clock, a double clock for chess matches (chess championships)
- 17-19 draughts (*Am.* checkers)
- 17 draughtboard (*Am.* checkerboard)
- 18 white draughtsman (*Am.* checker, checkerman); *also:* piece for backgammon and nine men's morris
- 19 black draughtsman (*Am.* checker, checkerman)
- 20 salta
- 21 salta piece
- 22 backgammon board
- 23-25 nine men's morris
- 23 nine men's morris board
- 24 mill
- 25 double mill
- 26-28 halma
- 26 halma board
- 27 yard (camp, corner)
- 28 halma pieces (halma men) of various colours (*Am.* colors)
- 29 dice (dicing)
- 30 dice cup
- 31 dice

- 32 spots (pips)
- 33 dominoes
- 34 domino (tile)
- 35 double
- 36 playing cards
- 37 playing card (card)
- 38-45 suits
- 38 clubs
- 39 spades
- 40 hearts
- 41 diamonds
- 42-45 German suits
- 42 acorns
- 43 leaves
- 44 hearts
- 45 bells (hawkbells)

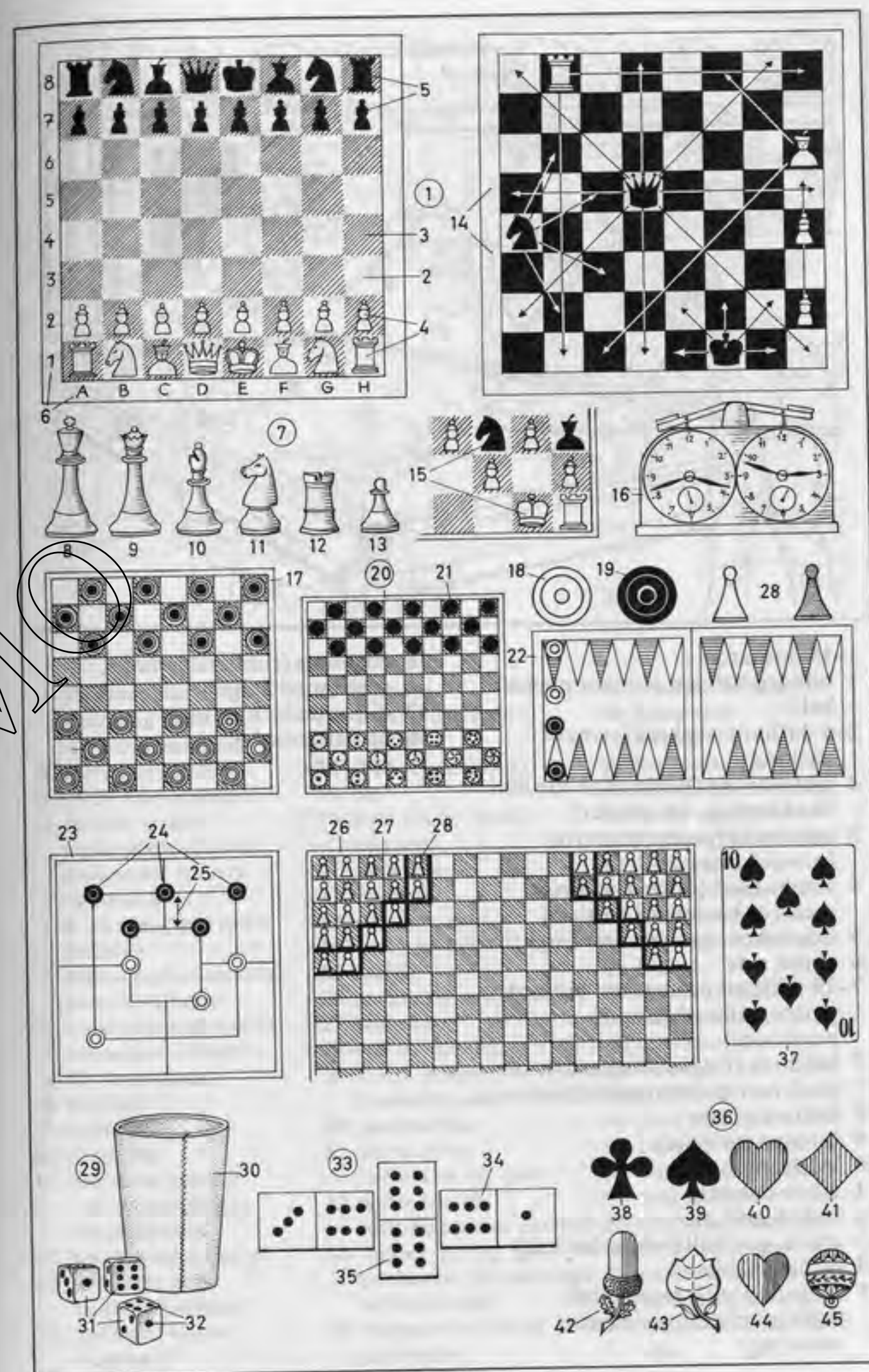

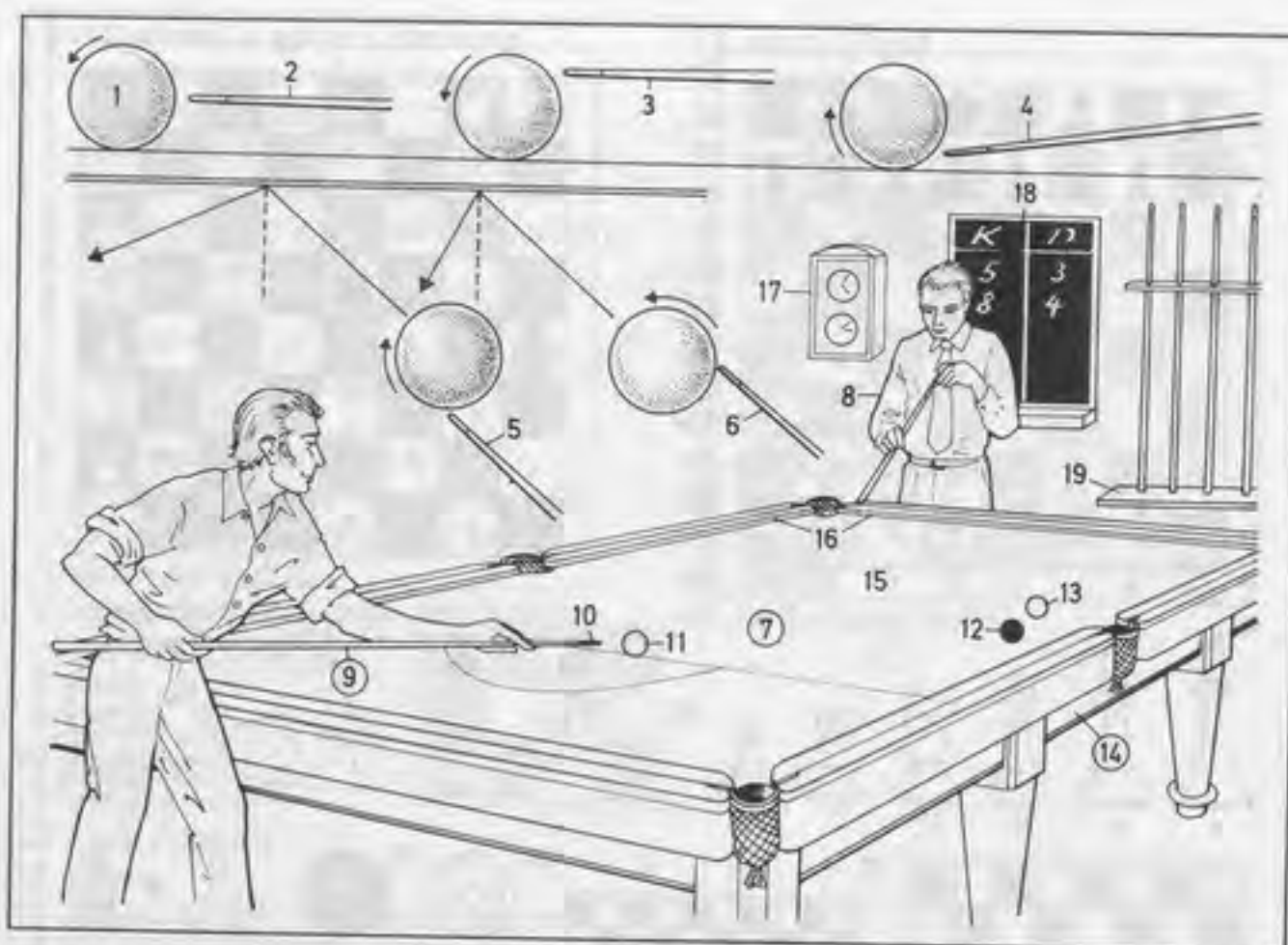

1-19 billiards

- 1 billiard ball, an ivory or plastic ball
- 2-6 billiard strokes (forms of striking)
 - 2 plain stroke (hitting the cue ball dead centre, *Am.* center)
 - 3 top stroke [promotes extra forward rotation]
 - 4 screw-back [imparts a direct recoil or backward motion]
 - 5 side (running side, *Am.* English)
 - 6 check side
- 7-19 billiard room (*Am.* billiard parlor, billiard saloon, poolroom)
- 7 billiards (English billiards); *sim.*: pool, carom (carrom) billiards
- 8 billiard player
- 9 billiard cue (cue)
- 10 leather cue tip
- 11 white cue ball
- 12 red object ball
- 13 white spot ball (white dot ball)
- 14 billiard table
- 15 table bed with green cloth (billiard cloth, green baize covering)

- 16 cushions (rubber cushions, cushioned ledge)
- 17 billiard clock, a timer
- 18 billiard marker
- 19 cue rack

59 camp site
(camping site,
Am. campground)

- 1 reception (office)
- 2 camp site attendant
- 3 folding trailer (collapsible caravan, collapsible trailer)
- 4 hammock
- 5-6 washing and toilet facilities
- 5 toilets and washrooms (*Am.* lavatories)
- 6 washbasins and sinks
- 7 bungalow (chalet)
- 8-11 scout camp
- 8 bell tent
- 9 pennon
- 10 camp fire
- 11 boy scout (scout)
- 12 sailing boat (yacht, *Am.* sailboat)
- 13 landing stage (jetty)
- 14 inflatable boat (inflatable dinghy)
- 15 outboard motor (outboard)
- 16 trimaran
- 17 thwart (oarsman's bench)
- 18 rowlock (oarlock)
- 19 oar
- 20 boat trailer (boat carriage)
- 21 ridge tent
- 22 flysheet
- 23 guy line (guy)
- 24 tent peg (peg)
- 25 mallet
- 26 groundsheet ring
- 27 bell end
- 28 erected awning
- 29 storm lantern, a paraffin lamp
- 30 sleeping bag
- 31 air mattress (inflatable air-bed)
- 32 water carrier (drinking water carrier)
- 33 double-burner gas cooker for propane gas or butane gas
- 34 propane or butane gas bottle
- 35 pressure cooker
- 36 frame tent
- 37 awning
- 38 tent pole
- 39 wheelarch doorway
- 40 mesh ventilator
- 41 transparent window
- 42 pitch number
- 43 folding camp chair
- 44 folding camp table
- 45 camping tableware
- 46 camper
- 47 charcoal grill (barbecue)
- 48 charcoal
- 49 bellows
- 50 roof rack
- 51 roof lashing
- 52 caravan (*Am.* trailer)
- 53 box for gas bottle
- 54 jockey wheel
- 55 drawbar coupling
- 56 roof ventilator
- 57 caravan awning
- 58 inflatable igloo tent
- 59 camp bed (*Am.* camp cot)

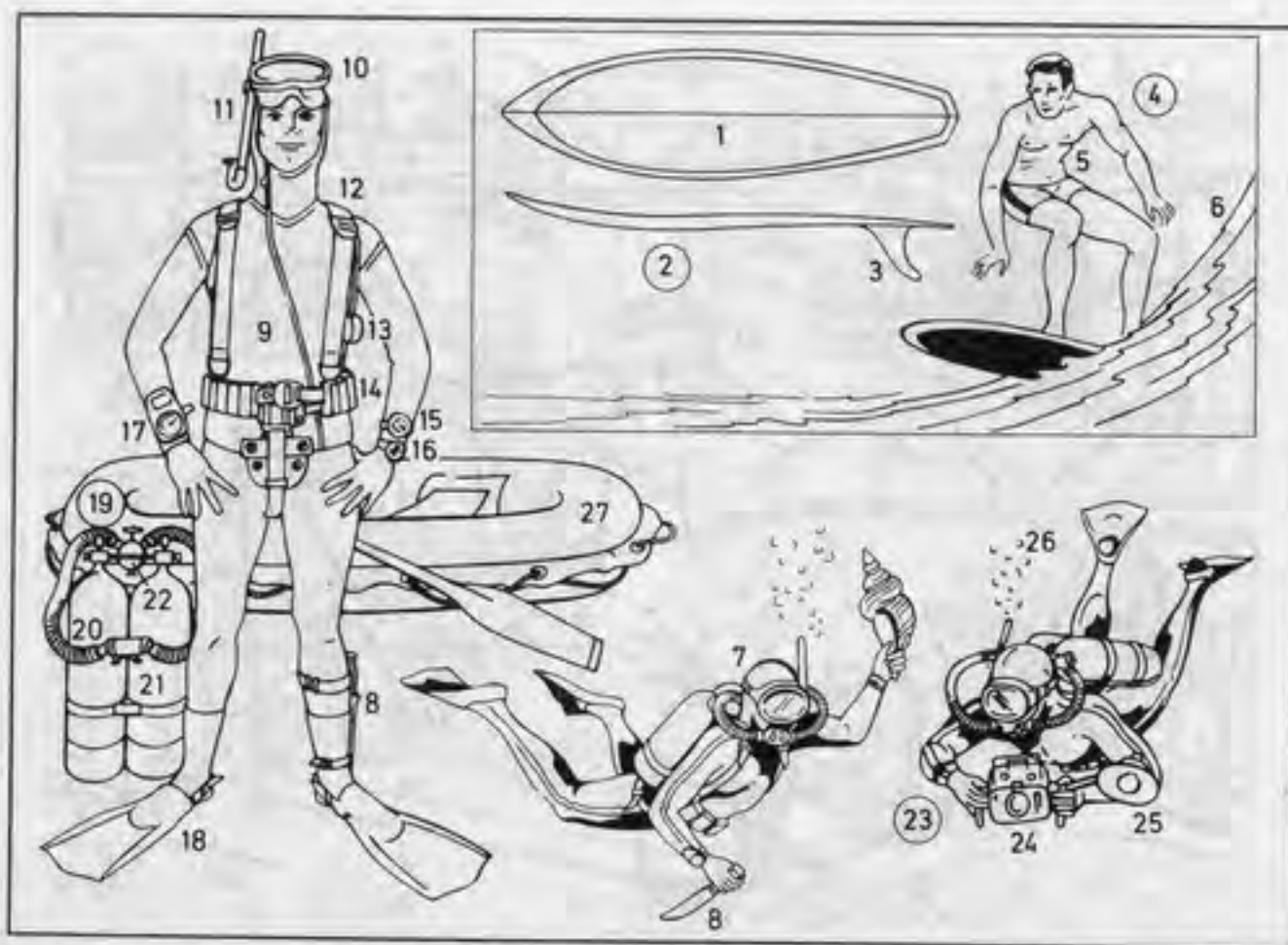

- 1-6 surf riding (surfing)
- 1 plan view of surfboard
- 2 section of surfboard
- 3 skeg (stabilizing fin)
- 4 big wave riding
- 5 surfboarder (surfer)
- 6 breaker
- 7-27 skin diving (underwater swimming)
- 7 skin diver (underwater swimmer)
- 8-22 underwater swimming set
- 8 knife
- 9 neoprene wetsuit
- 10 diving mask (face mask, mask), a pressure-equalizing mask
- 11 snorkel (schnorkel)
- 12 harness of diving apparatus
- 13 compressed-air pressure gauge (Am. gage)
- 14 weight belt
- 15 depth gauge (Am. gage)
- 16 waterproof watch for checking duration of dive
- 17 decometer for measuring stages of ascent
- 18 fin (flipper)

- 19 diving apparatus (also: aqualung, scuba), with two cylinders (bottles)
- 20 two-tube demand regulator
- 21 compressed-air cylinder (compressed-air bottle)
- 22 on/off valve
- 23 underwater photography
- 24 underwater camera
- 25 underwater flashlight
- 26 exhaust bubbles
- 27 inflatable boat (inflatable dinghy)

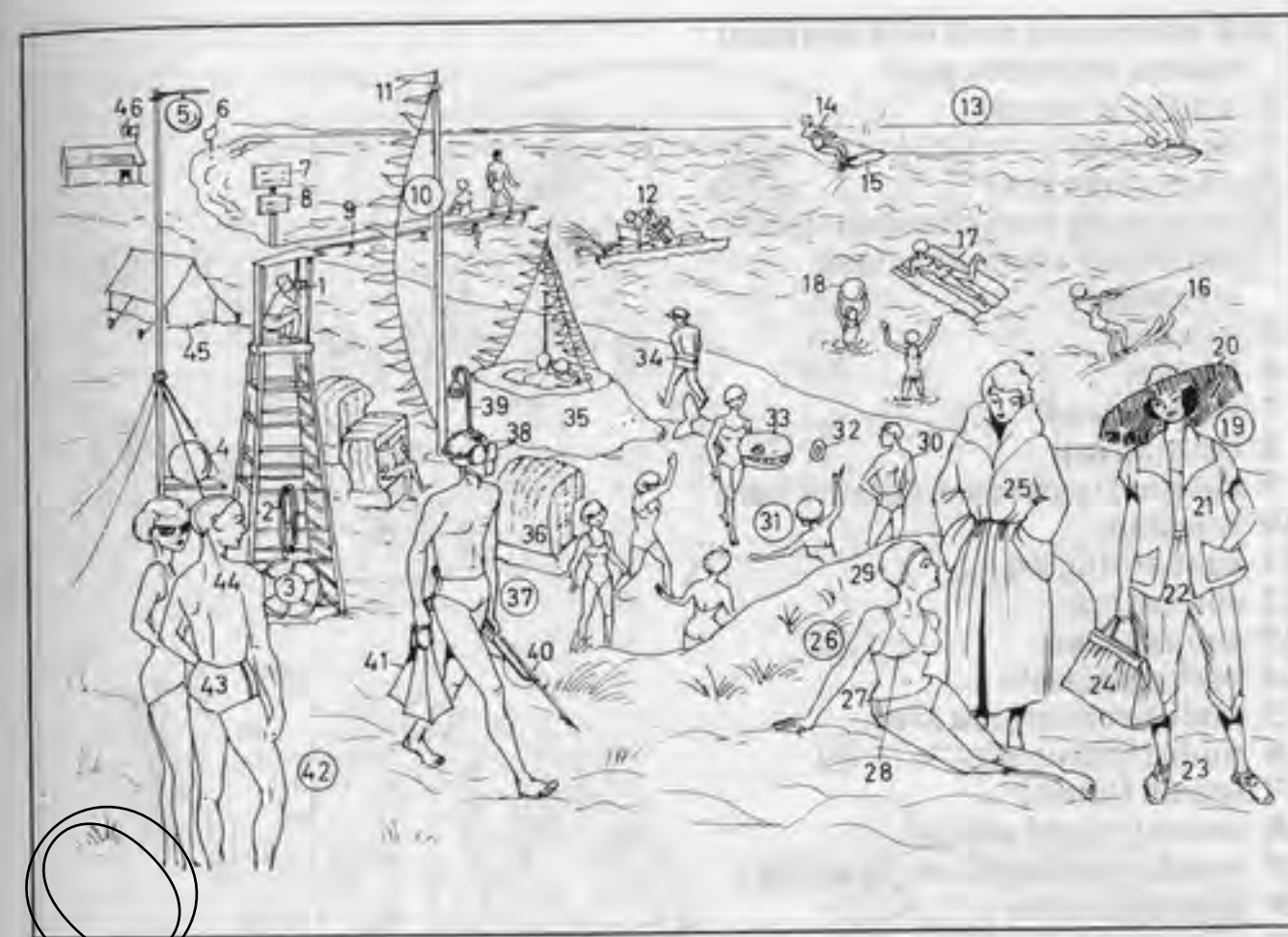

- 1 lifeguard (lifeguard)
- 2 lifeline
- 3 lifebelt (lifebuoy)
- 4 storm signal
- 5 time ball
- 6 warning sign
- 7 tide table, a notice board showing times of low tide and high tide
- 8 board showing water and air temperature
- 9 bathing platform
- 10 pennon staff
- 11 pennon
- 12 paddle boat (peddle boat)
- 13 surf riding (surfing) behind motorboat
- 14 surfboarder (surfer)
- 15 surfboard
- 16 water ski
- 17 inflatable beach mattress
- 18 beach ball
- 19-23 beachwear
- 19 beach suit
- 20 beach hat
- 21 beach jacket
- 22 beach trousers
- 23 beach shoe (bathing shoe)

- 24 beach bag
- 25 bathing gown (bathing wrap)
- 26 bikini (ladies' two-piece bathing suit)
- 27 bikini bottom
- 28 bikini top
- 29 bathing cap (swimming cap)
- 30 bather
- 31 deck tennis (quoits)
- 32 rubber ring (quoit)
- 33 inflatable rubber animal
- 34 beach attendant
- 35 sandcastle
- 36 roofed wicker beach chair
- 37 underwater swimmer
- 38 diving goggles
- 39 snorkel (schnorkel)
- 40 hand harpoon (fish spear, fish lance)
- 41 fin (flipper) for diving (for underwater swimming)
- 42 bathing suit (swimsuit)
- 43 bathing trunks (swimming trunks)
- 44 bathing cap (swimming cap)
- 45 beach tent, a ridge tent
- 46 lifeguard station

- 1-9 swimming pool with artificial waves, an indoor pool
- 1 artificial waves
- 2 beach area
- 3 edge of the pool
- 4 swimming pool attendant (pool attendant, swimming bath attendant)
- 5 sun bed
- 6 lifebelt
- 7 water wings
- 8 bathing cap
- 9 channel to outdoor mineral bath
- 10 solarium
- 11 sunbathing area
- 12 sun bather
- 13 sun ray lamp
- 14 bathing towel
- 15 nudist sunbathing area
- 16 nudist (naturist)
- 17 screen (fence)
- 18 sauna (mixed sauna)
- 19 wood panelling (Am. paneling)
- 20 tiered benches
- 21 sauna stove
- 22 stones
- 23 hygrometer
- 24 thermometer
- 25 towel
- 26 water tub for moistening the stones in the stove
- 27 birch rods (birches) for beating the skin
- 28 cooling room for cooling off (cooling down) after the sauna
- 29 lukewarm shower
- 30 cold bath
- 31 hot whirlpool (underwater massage bath)
- 32 step into the bath
- 33 massage bath
- 34 jet blower
- 35 hot whirlpool [diagram]
- 36 section of the bath
- 37 step
- 38 circular seat
- 39 water extractor
- 40 water jet pipe
- 41 air jet pipe

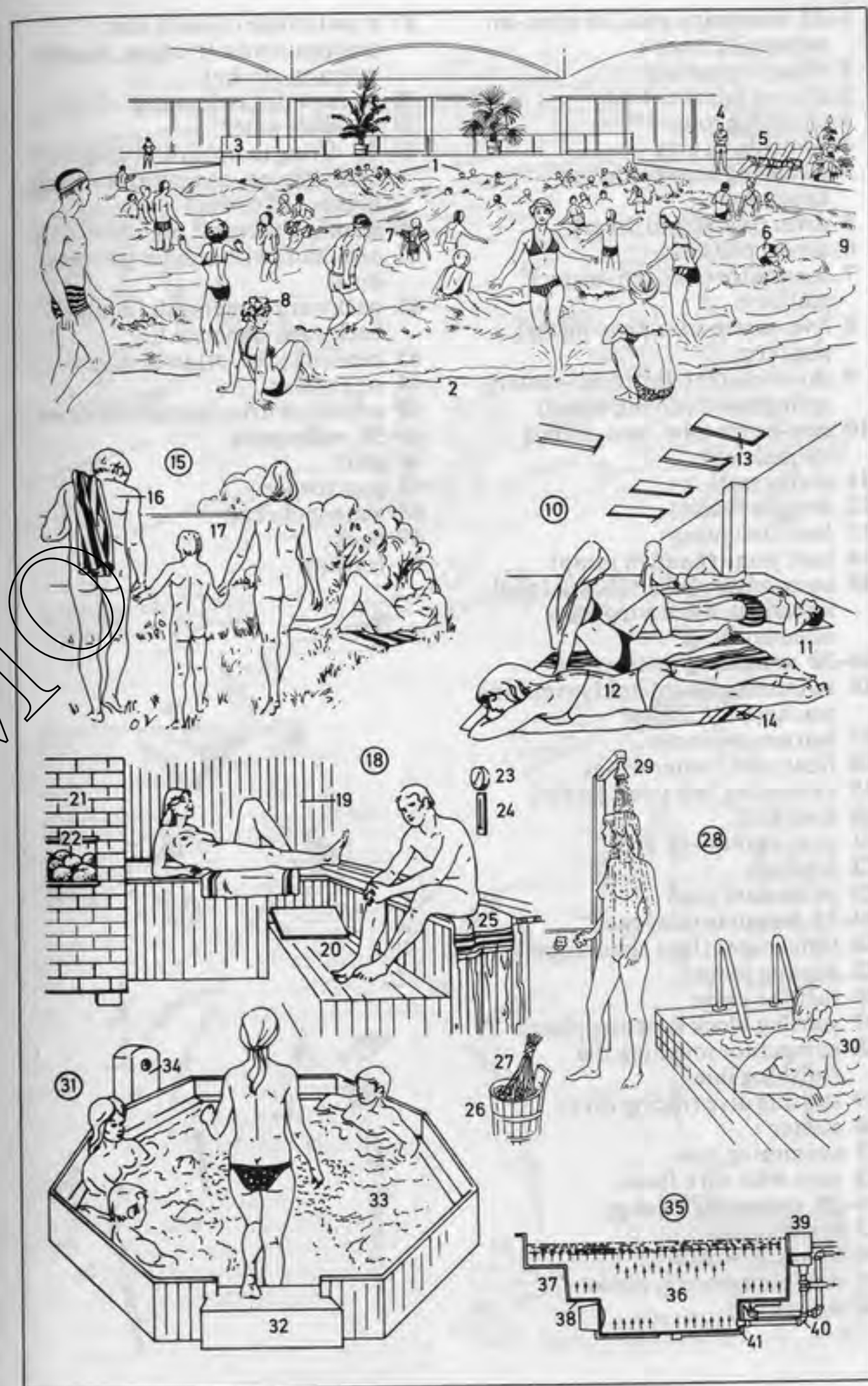

- 1-32 swimming pool, an open-air swimming pool
- 1 changing cubicle
 - 2 shower (shower bath)
 - 3 changing room
 - 4 sunbathing area
 - 5-10 diving boards (diving apparatus)
 - 5 diver (highboard diver)
 - 6 diving platform
 - 7 ten-metre (*Am.* ten-meter) platform
 - 8 five-metre (*Am.* five-meter) platform
 - 9 three-metre (*Am.* three-meter) springboard (diving board)
 - 10 one-metre (*Am.* one-meter) springboard
 - 11 diving pool
 - 12 straight header
 - 13 feet-first jump
 - 14 tuck jump (haunch jump)
 - 15 swimming pool attendant (pool attendant, swimming bath attendant)
 - 16-20 swimming instruction
 - 16 swimming instructor (swimming teacher)
 - 17 learner-swimmer
 - 18 float; *sim.*: water wings
 - 19 swimming belt (cork jacket)
 - 20 land drill
 - 21 non-swimmers' pool
 - 22 footbath
 - 23 swimmers' pool
 - 24-32 freestyle relay race
 - 24 timekeeper (lane timekeeper)
 - 25 placing judge
 - 26 turning judge
 - 27 starting block (starting place)
 - 28 competitor touching the finishing line
 - 29 starting dive (racing dive)
 - 30 starter
 - 31 swimming lane
 - 32 rope with cork floats
 - 33-39 swimming strokes
 - 33 breaststroke
 - 34 butterfly stroke
 - 35 dolphin butterfly stroke
 - 36 side stroke

- 37 crawl stroke (crawl); *sim.*: trudgen stroke (trudgen, double overarm stroke)
- 38 underwater swimming
- 39 treading water
- 40-45 diving (acrobatic diving, fancy diving, competitive diving, highboard diving)
- 40 standing take-off pike dive
- 41 one-half twist isander (reverse dive)
- 42 backward somersault (double backward somersault)
- 43 running take-off twist dive
- 44 screw dive
- 45 armstand dive (handstand dive)
- 46-50 water polo
- 46 goal
- 47 goalkeeper
- 48 water polo ball
- 49 back
- 50 forward

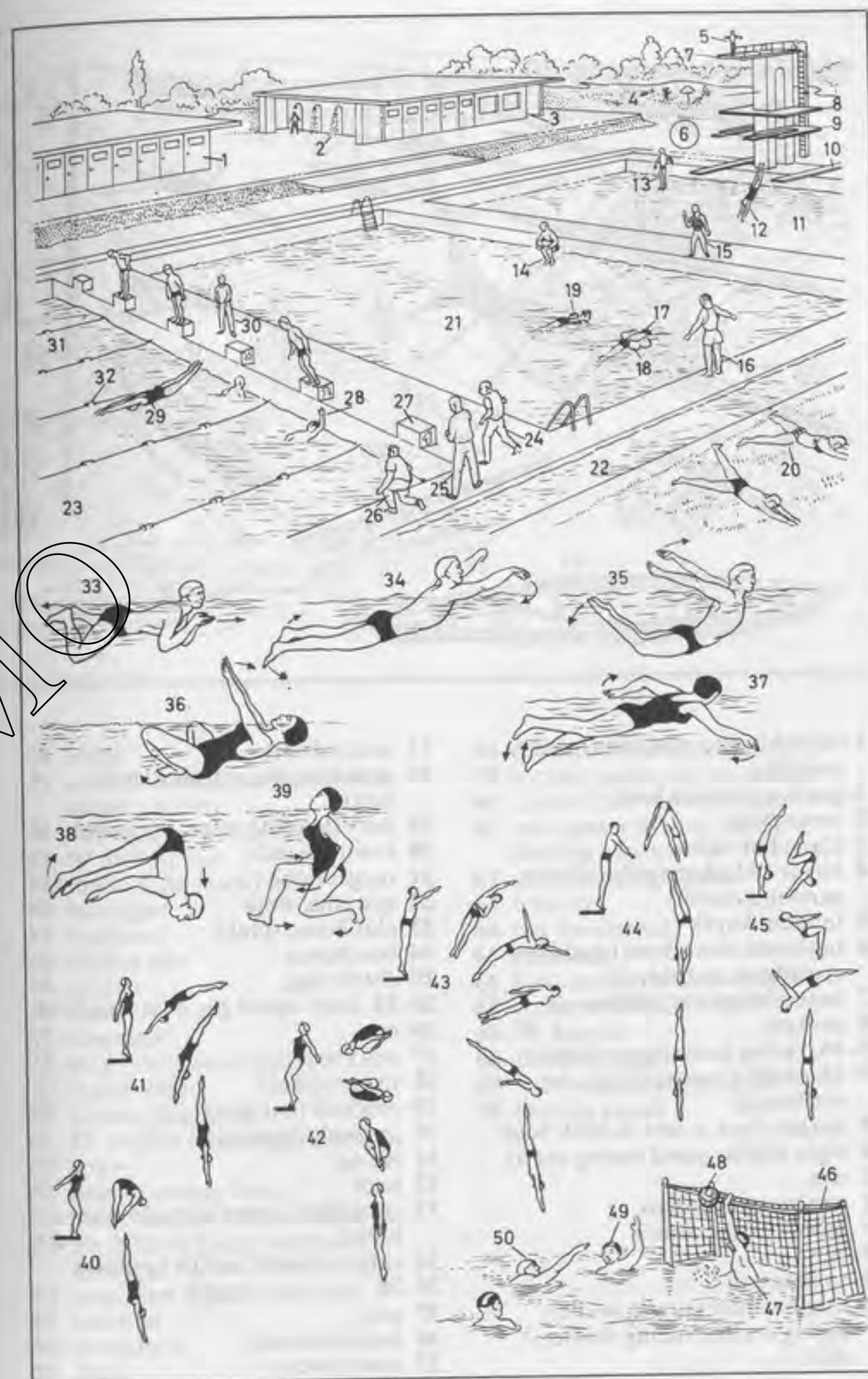

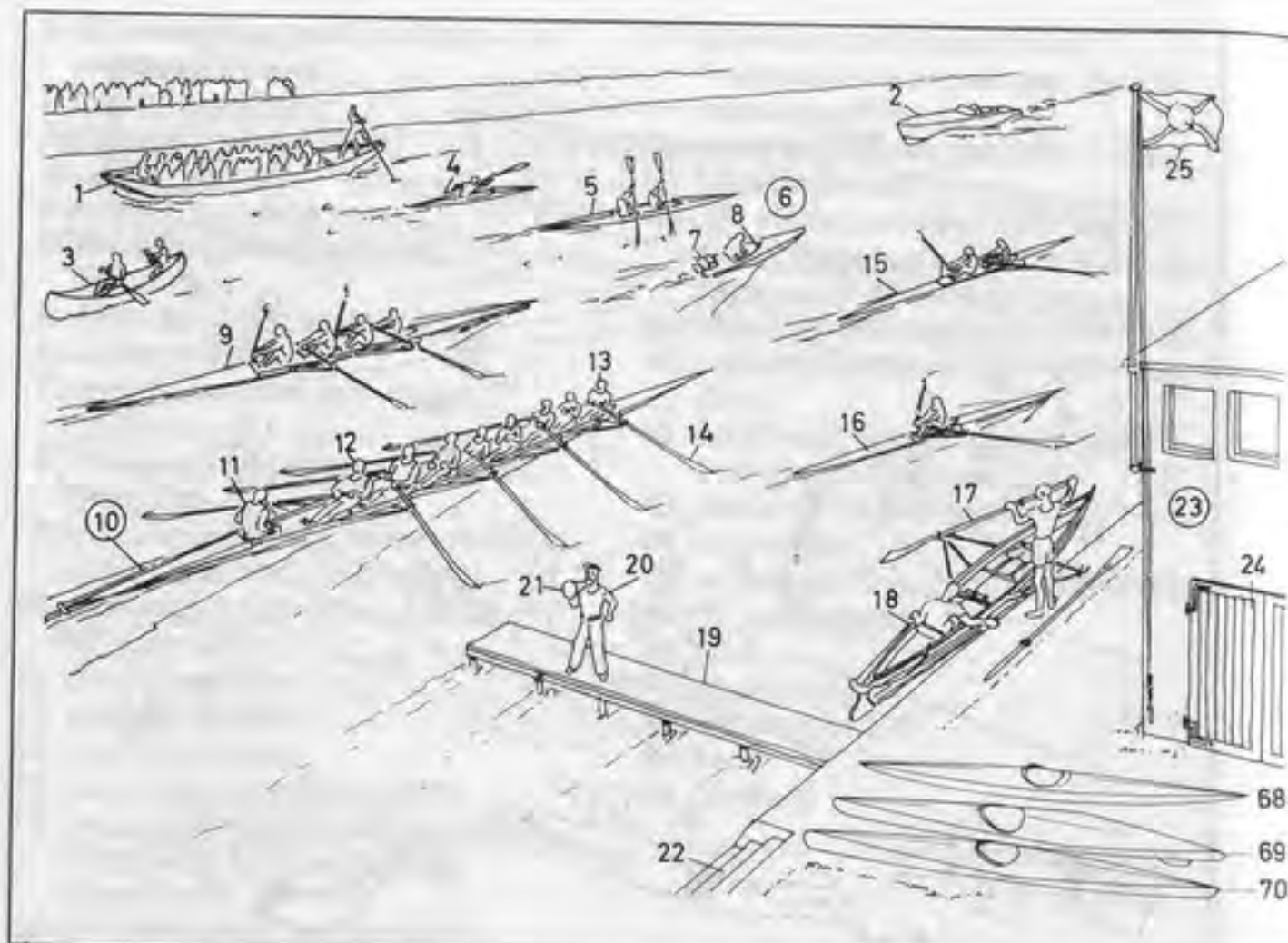

- 1-18 taking up positions for the regatta
 1 punt, a pleasure boat
 2 motorboat
 3 Canadian canoe
 4 kayak (Alaskan canoe, slalom canoe), a canoe
 5 tandem kayak
 6 outboard motorboat (outboard speedboat, outboard)
 7 outboard motor (outboard)
 8 cockpit
 9-16 racing boats (sportsboats)
 9-15 shells (rowing boats, *Am.* rowboats)
 9 coxless four, a carvel-built boat
 10 eight (eight-oared racing shell)
 11 cox
 12 stroke, an oarsman
 13 bow ('number one')
 14 oar
 15 coxless pair
 16 single sculler (single skuller, racing sculler, racing skuller, skiff)

- 17 scull (skull)
 18 coxed single, a clinker-built single
 19 jetty (landing stage, mooring)
 20 rowing coach
 21 megaphone
 22 quayside steps
 23 clubhouse (club)
 24 boathouse
 25 club's flag
 26-33 four-oared gig, a touring boat
 26 oar
 27 cox's seat
 28 thwart (seat)
 29 rowlock (oarlock)
 30 gunwale (gunnel)
 31 rising
 32 keel
 33 skin (shell, outer skin) [clinker-built]
 34 single-bladed paddle (paddle)
 35-38 oar (scull, skull)
 35 grip
 36 leather sheath
 37 shaft (neck)

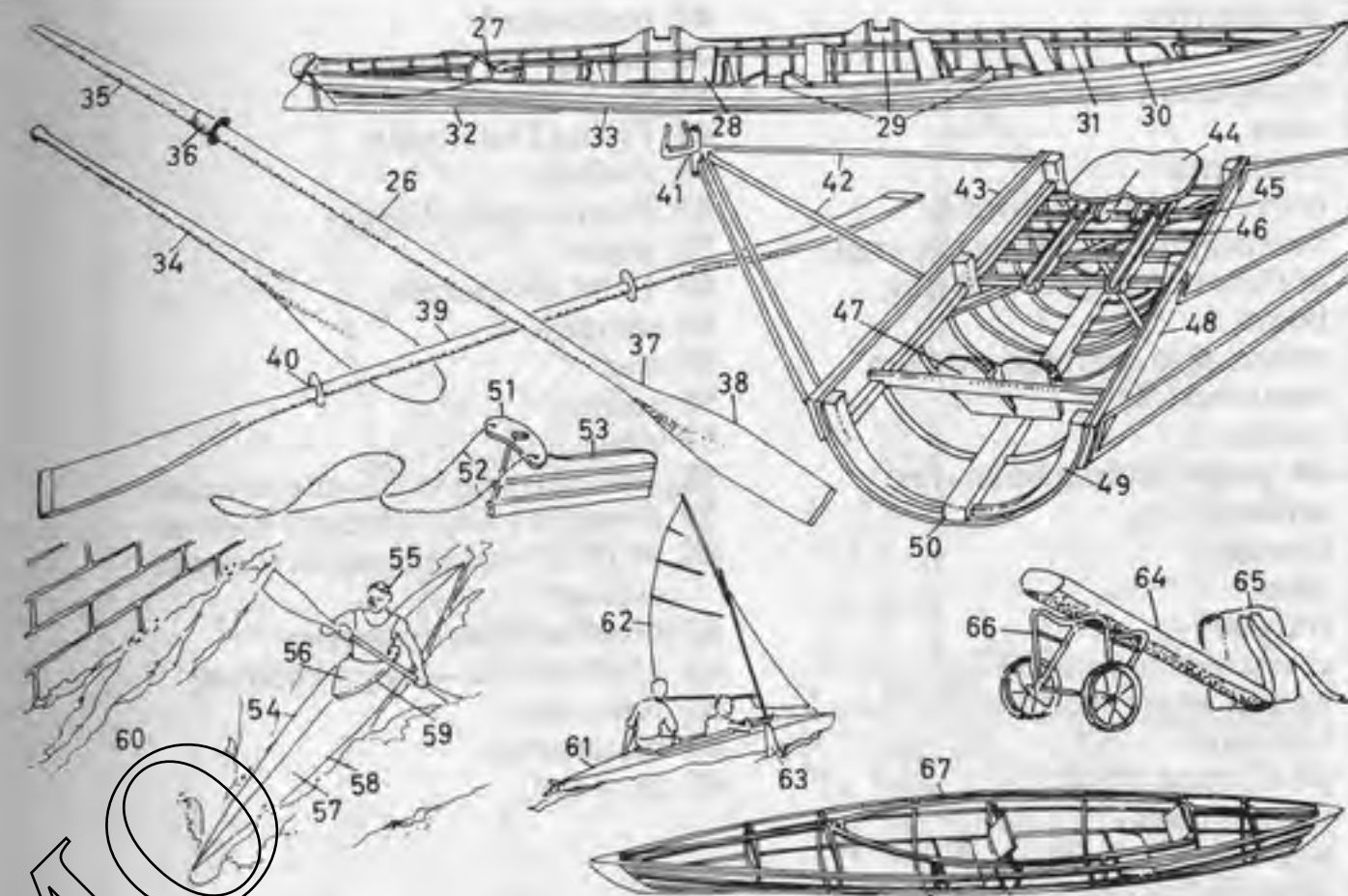

- 38 blade
 39 double-bladed paddle (double-ended paddle)
 40 drip ring
 41-50 sliding seat
 41 rowlock (oarlock)
 42 outrigger
 43 saxboard
 44 sliding seat
 45 runner
 46 strut
 47 stretcher
 48 skin (shell, outer skin)
 49 frame (rib)
 50 kelson (keelson)
 51-53 rudder (steering rudder)
 51 yoke
 52 lines (steering lines)
 53 blade (rudder blade, rudder)
 54-66 folding boats (foldboats, canoes)
 54 one-man kayak
 55 canoeist
 56 spraydeck
 57 deck

- 58 rubber-covered canvas hull
 59 cockpit coaming (coaming)
 60 channel for rafts alongside weir
 61 two-seater folding kayak, a touring kayak
 62 sail of folding kayak
 63 leeboard
 64 bag for the rods
 65 rucksack
 66 boat trailer (boat carriage)
 67 frame of folding kayak
 68-70 kayaks
 68 Eskimo kayak
 69 wild-water racing kayak
 70 touring kayak

- 1-9 windsurfing
- 1 windsurfer
- 2 sail
- 3 transparent window (window)
- 4 mast
- 5 surfboard
- 6 universal joint (movable bearing) for adjusting the angle of the mast and for steering
- 7 boom
- 8 retractable centreboard (*Am.* centerboard)
- 9 rudder
- 10-48 yacht (sailing boat, *Am.* sailboat)
- 10 foredeck
- 11 mast
- 12 trapeze
- 13 crosstrees (spreader)
- 14 hound
- 15 forestay
- 16 jib (Genoa jib)
- 17 jib downhaul
- 18 side stay (shroud)
- 19 lanyard (bottlescrew)
- 20 foot of the mast
- 21 kicking strap (vang)
- 22 jam cleat
- 23 foresheet (jib sheet)
- 24 centreboard (*Am.* centerboard) case
- 25 bitt
- 26 centreboard (*Am.* centerboard)
- 27 traveller (*Am.* traveler)
- 28 mainsheet
- 29 fairlead
- 30 toestraps (hiking straps)
- 31 tiller extension (hiking stick)
- 32 tiller
- 33 rudderhead (rudder stock)
- 34 rudder blade (rudder)
- 35 transom
- 36 drain plug
- 37 gooseneck
- 38 window
- 39 boom
- 40 foot
- 41 clew
- 42 luff (leading edge)
- 43 leech pocket (batten cleat, batten pocket)
- 44 batten
- 45 leech (trailing edge)

- 46 mainsail
- 47 headboard
- 48 racing flag (burgee)
- 49-65 yacht classes
- 49 Flying Dutchman
- 50 O-Joller
- 51 Finn dinghy (Finn)
- 52 pirate
- 53 12.00 m² sharpie
- 54 tempest
- 55 star
- 56 soling
- 57 dragon
- 58 5.5-metre (*Am.* 5.5-meter) class
- 59 6-metre (*Am.* 6-meter) R-class
- 60 30.00 m² cruising yacht (coastal cruiser)
- 61 30.00 m² dinghy cruiser
- 62 25.00 m² one-design keelboat
- 63 KR-class
- 64 catamaran
- 65 twin hull

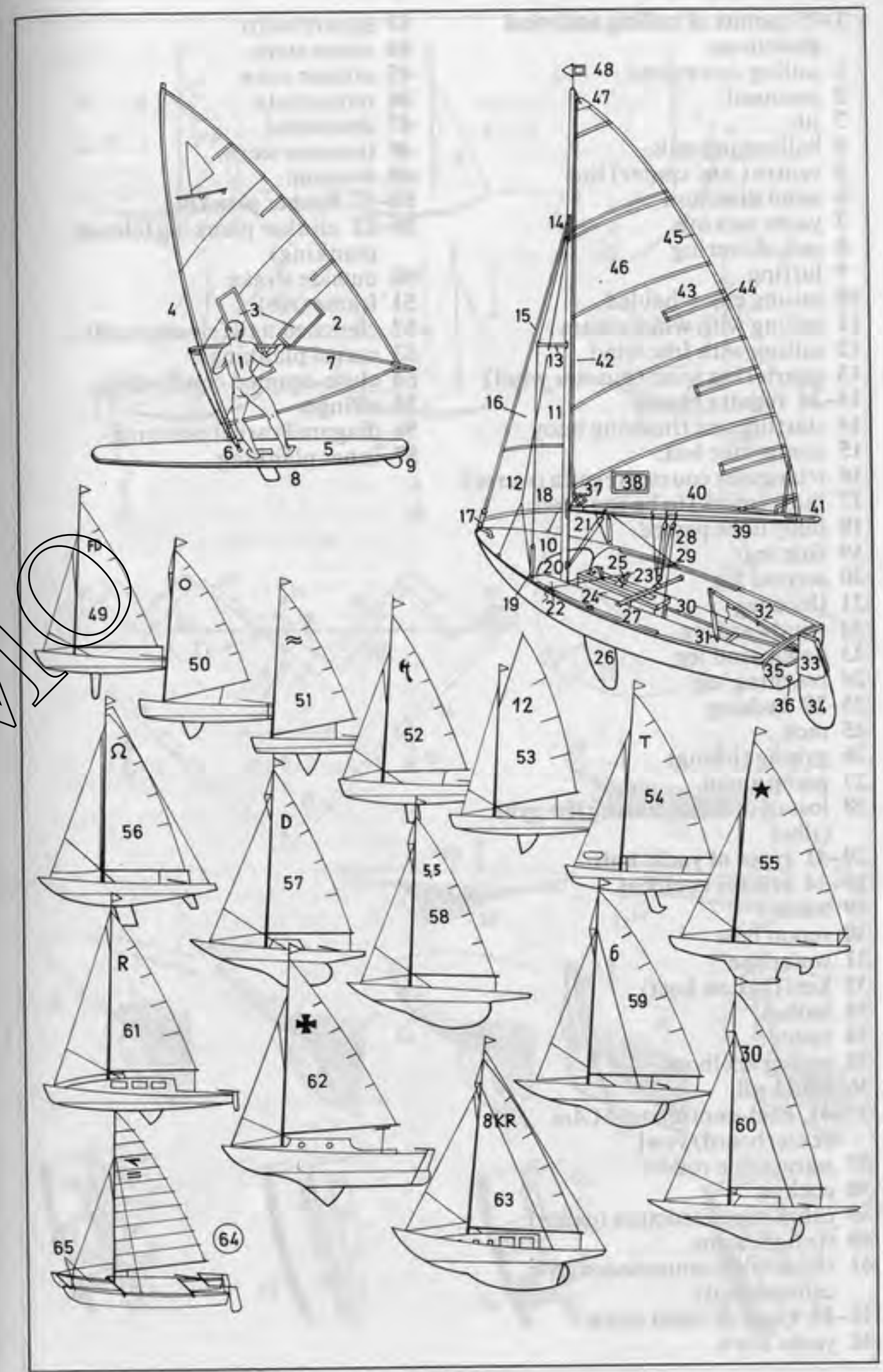

1-13 points of sailing and wind directions

- 1 sailing downwind
- 2 mainsail
- 3 jib
- 4 ballooning sails
- 5 centre (*Am.* center) line
- 6 wind direction
- 7 yacht tacking
- 8 sail, shivering
- 9 luffing
- 10 sailing close-hauled
- 11 sailing with wind abeam
- 12 sailing with free wind
- 13 quartering wind (quarter wind)
- 14-24 regatta course**
- 14 starting and finishing buoy
- 15 committee boat
- 16 triangular course (regatta course)
- 17 buoy (mark) to be rounded
- 18 buoy to be passed
- 19 first leg
- 20 second leg
- 21 third leg
- 22 windward leg
- 23 downwind leg
- 24 reaching leg
- 25-28 tacking**
- 25 tack
- 26 gybing (jibing)
- 27 going about
- 28 loss of distance during the gybe (jibe)

29-41 types of yacht hull

- 29-34 cruiser keelboat**
- 29 stern
- 30 spoon bow
- 31 waterline
- 32 keel (ballast keel)
- 33 ballast
- 34 rudder
- 35 racing keelboat
- 36 lead keel
- 37-41 keel-centreboard (*Am.* centerboard) yawl**
- 37 retractable rudder
- 38 cockpit
- 39 cabin superstructure (cabin)
- 40 straight stem
- 41 retractable centreboard (*Am.* centerboard)

42-49 types of yacht stern

- 42 yacht stern

- 43 square stern
- 44 canoe stern
- 45 cruiser stern
- 46 name plate
- 47 deadwood
- 48 transom stern
- 49 transom
- 50-57 timber planking**
- 50-52 clinker planking (clench planking)**
- 50 outside strake
- 51 frame (rib)
- 52 clenched nail (riveted nail)
- 53 carvel planking
- 54 close-seamed construction
- 55 stringer
- 56 diagonal carvel planking
- 57 inner planking

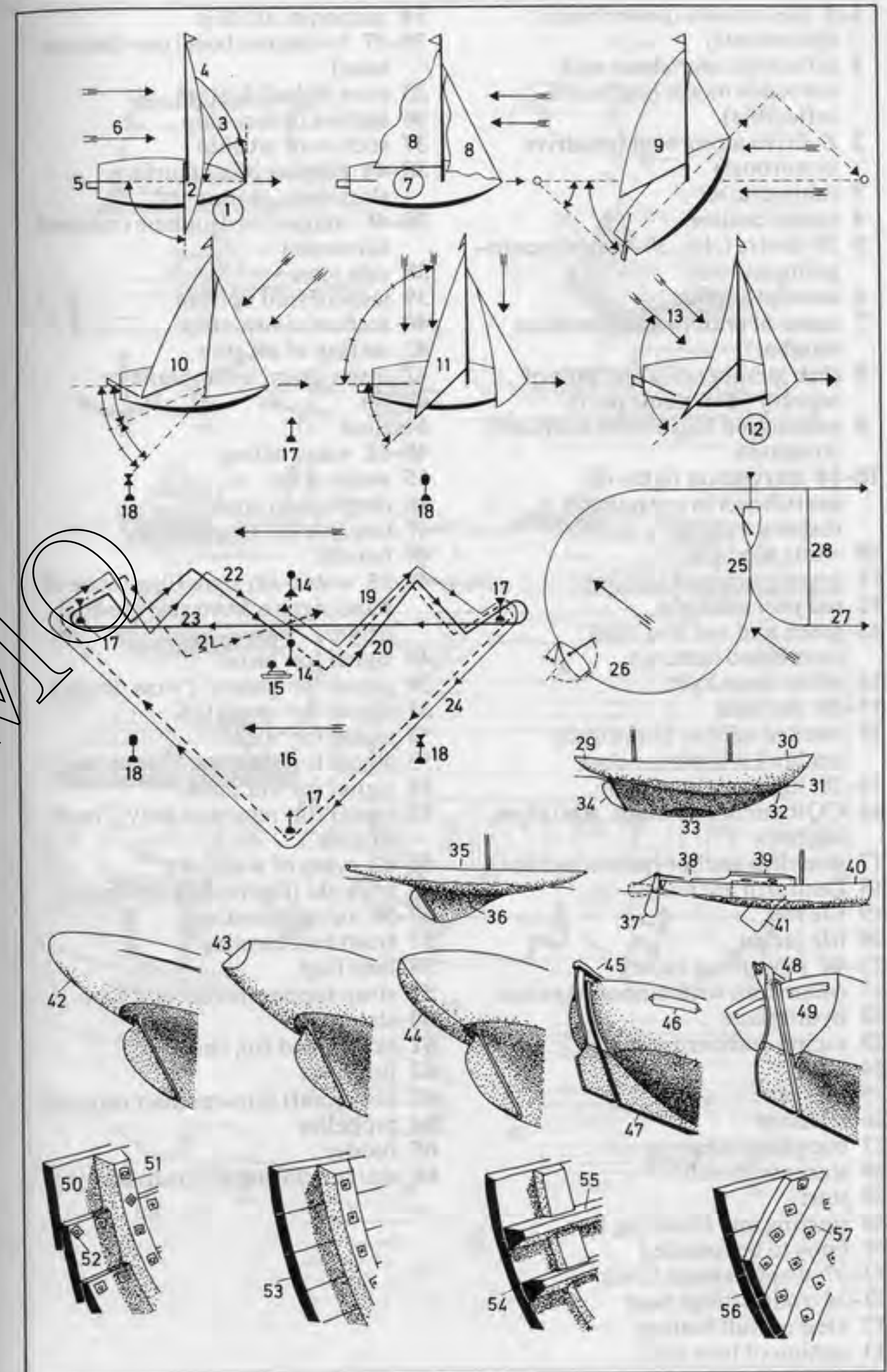

- 1-5 motorboats (powerboats, sportsboats)
 1 inflatable sportsboat with outboard motor (outboard inflatable)
 2 Z-drive motorboat (outdrive motorboat)
 3 cabin cruiser
 4 motor cruiser
 5 30-metre (*Am.* 30-meter) ocean-going cruiser
 6 association flag
 7 name of craft (*or:* registration number)
 8 club membership and port of registry (*Am.* home port)
 9 association flag on the starboard crossrees
 10-14 navigation lights of sportsboats in coastal and inshore waters
 10 white top light
 11 green starboard sidelight
 12 red port sidelight
 13 green and red bow light (combined lantern)
 14 white stern light
 15-18 anchors
 15 stocked anchor (Admiralty anchor), a bower anchor
 16-18 lightweight anchor
 16 CQR anchor (plough, *Am.* plow, anchor)
 17 stockless anchor (patent anchor)
 18 Danforth anchor
 19 life raft
 20 life jacket
 21-44 powerboat racing
 21 catamaran with outboard motor
 22 hydroplane
 23 racing outboard motor
 24 tiller
 25 fuel pipe
 26 transom
 27 buoyancy tube
 28 start and finish
 29 start
 30 starting and finishing line
 31 buoy to be rounded
 32-37 displacement boats
 32-34 round-bilge boat
 32 view of hull bottom
 33 section of fore ship
 34 section of aft ship
 35-37 V-bottom boat (vee-bottom boat)
 35 view of hull bottom
 36 section of fore ship
 37 section of aft ship
 38-44 planing boats (surface skimmers, skimmers)
 38-41 stepped hydroplane (stepped skimmer)
 38 side view
 39 view of hull bottom
 40 section of fore ship
 41 section of aft ship
 42 three-point hydroplane
 43 fin
 44 float
 45-62 water skiing
 45 water skier
 46 deep-water start
 47 tow line (towing line)
 48 handle
 49-55 water-ski signalling (code of hand signals from skier to boat driver)
 49 signal for 'faster'
 50 signal for 'slower' ('slow down')
 51 signal for 'speed OK'
 52 signal for 'turn'
 53 signal for 'stop'
 54 signal for 'cut motor'
 55 signal for 'return to jetty' ('back to dock')
 56-62 types of water ski
 56 trick ski (figure ski), a monoski
 57-58 rubber binding
 57 front foot binding
 58 heel flap
 59 strap support for second foot
 60 slalom ski
 61 skeg (fixed fin, fin)
 62 jump ski
 63 hovercraft (air-cushion vehicle)
 64 propeller
 65 rudder
 66 skirt enclosing air cushion

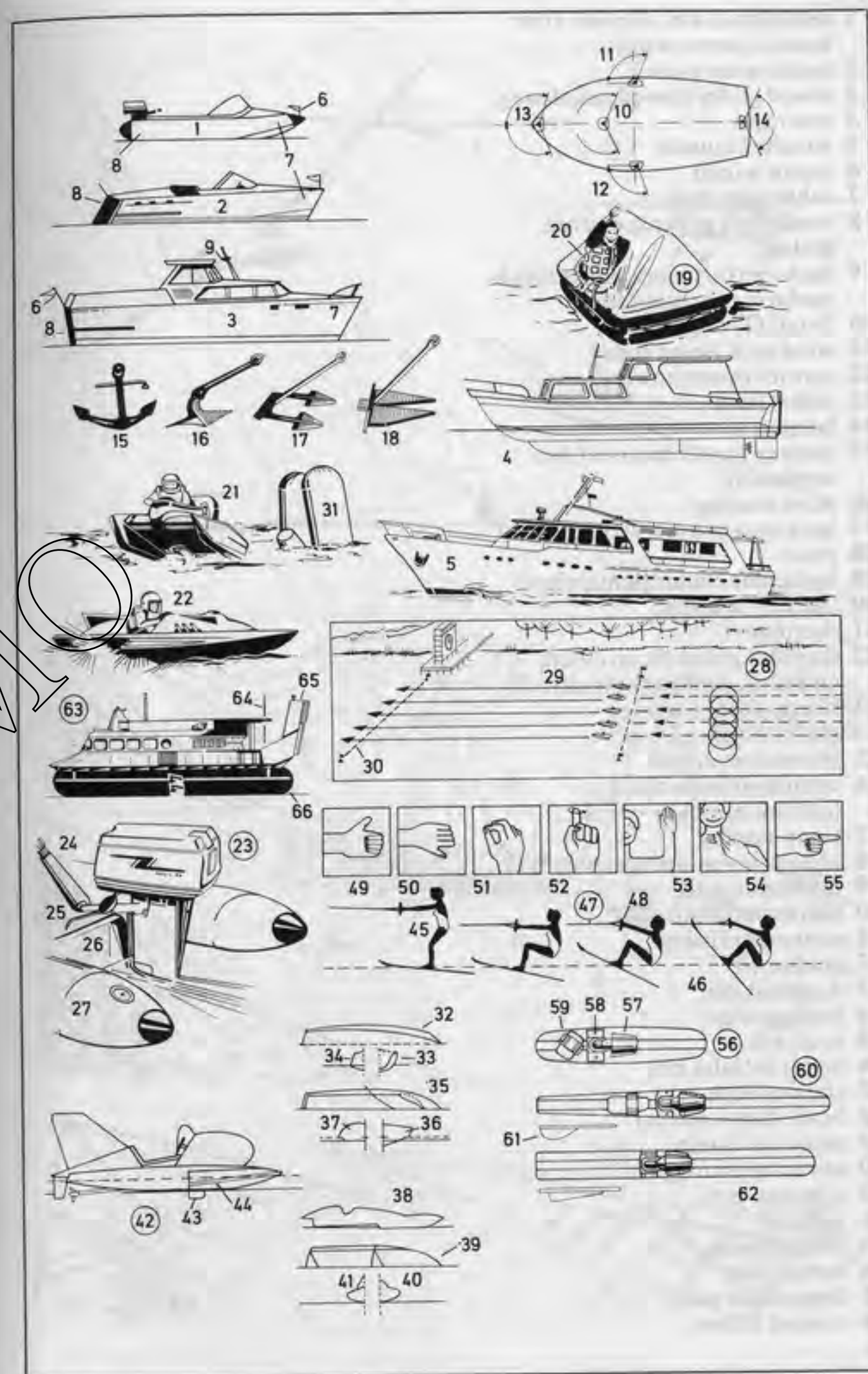

- 1 aeroplane (*Am.* airplane) tow launch (aerotowing)
- 2 tug (towing plane)
- 3 towed glider (towed sailplane)
- 4 tow rope
- 5 winched launch
- 6 motor winch
- 7 cable parachute
- 8 motorized glider (powered glider)
- 9 high-performance glider (high-performance sailplane)
- 10 T-tail (T-tail unit)
- 11 wind sock (wind cone)
- 12 control tower (tower)
- 13 glider field
- 14 hangar
- 15 runway for aeroplanes (*Am.* airplanes)
- 16 wave soaring
- 17 lee waves (waves, wave system)
- 18 rotor
- 19 lenticular clouds (lenticulars)
- 20 thermal soaring
- 21 thermal
- 22 cumulus cloud (heap cloud, cumulus, woolpack cloud)
- 23 storm-front soaring
- 24 storm front
- 25 frontal upcurrent
- 26 cumulonimbus cloud (cumulonimbus)
- 27 slope soaring
- 28 hill upcurrent (orographic lift)
- 29 multispar wing
- 30 main spar, a box spar
- 31 connector fitting
- 32 anchor rib
- 33 diagonal spar
- 34 leading edge
- 35 main rib
- 36 nose rib (false rib)
- 37 trailing edge
- 38 brake flap (spoiler)
- 39 torsional clamp
- 40 covering (skin)
- 41 aileron
- 42 wing tip
- 43 hang gliding
- 44 hang glider
- 45 hang glider pilot
- 46 control frame

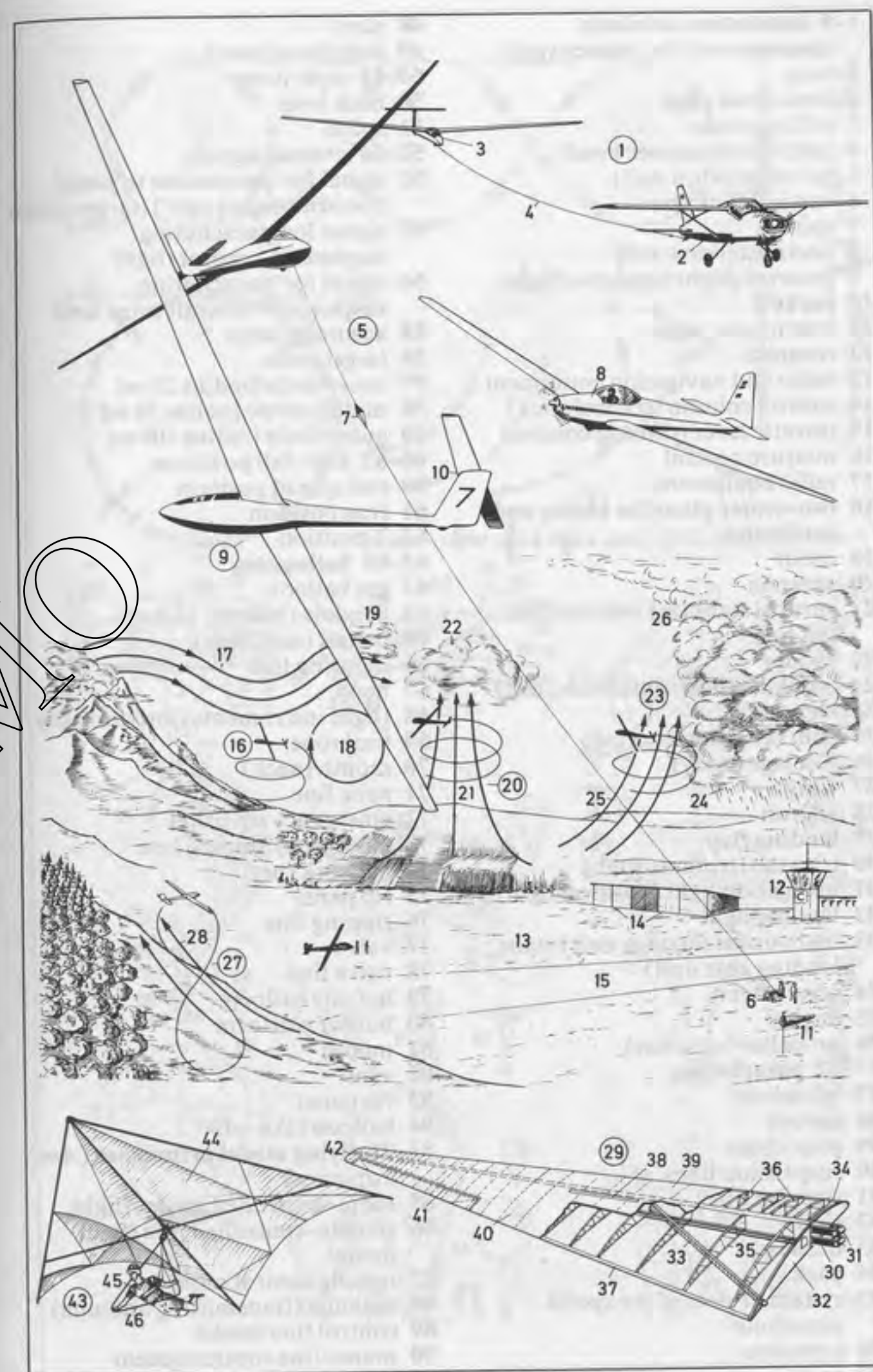

- 1-9 aerobatics, aerobic manoeuvres (*Am.* maneuvers)
- 1 loop
- 2 horizontal eight
- 3 rolling circle
- 4 stall turn (hammer head)
- 5 tail slide (whip stall)
- 6 vertical flick spin
- 7 spin
- 8 horizontal slow roll
- 9 inverted flight (negative flight)
- 10 cockpit
- 11 instrument panel
- 12 compass
- 13 radio and navigation equipment
- 14 control column (control stick)
- 15 throttle lever (throttle control)
- 16 mixture control
- 17 radio equipment
- 18 two-seater plane for racing and aerobatics
- 19 cabin
- 20 antenna
- 21 vertical stabilizer (vertical fin, tail fin)
- 22 rudder
- 23 tailplane (horizontal stabilizer)
- 24 elevator
- 25 trim tab (trimming tab)
- 26 fuselage (body)
- 27 wing
- 28 aileron
- 29 landing flap
- 30 trim tab (trimming tab)
- 31 navigation light (position light) [red]
- 32 landing light
- 33 main undercarriage unit (main landing gear unit)
- 34 nose wheel
- 35 engine
- 36 propeller (airscrew)
- 37-62 parachuting
- 37 parachute
- 38 canopy
- 39 pilot chute
- 40 suspension lines
- 41 steering line
- 42 riser
- 43 harness
- 44 pack
- 45 system of slots of the sports parachute
- 46 turn slots
- 47 apex

- 48 skirt
- 49 stabilizing panel
- 50-51 style jump
- 50 back loop
- 51 spiral
- 52-54 ground signals
- 52 signal for 'permission to jump' ('conditions are safe') (target cross)
- 53 signal for 'parachuting suspended - repeat flight'
- 54 signal for 'parachuting suspended - aircraft must land'
- 55 accuracy jump
- 56 target cross
- 57 inner circle [radius 25 m]
- 58 middle circle [radius 50 m]
- 59 outer circle [radius 100 m]
- 60-62 free-fall positions
- 60 full spread position
- 61 frog position
- 62 T position
- 63-84 ballooning
- 63 gas balloon
- 64 gondola (balloon basket)
- 65 ballast (sandbags)
- 66 mooring line
- 67 hoop
- 68 flight instruments (instruments)
- 69 trail rope
- 70 mouth (neck)
- 71 neck line
- 72 emergency rip panel
- 73 emergency ripping line
- 74 network (net)
- 75 rip panel
- 76 ripping line
- 77 valve
- 78 valve line
- 79 hot-air balloon
- 80 burner platform
- 81 mouth
- 82 vent
- 83 rip panel
- 84 balloon take-off
- 85-91 flying model aeroplanes (*Am.* airplanes)
- 85 radio-controlled model flight
- 86 remote-controlled free flight model
- 87 remote control radio
- 88 antenna (transmitting antenna)
- 89 control line model
- 90 mono-line control system
- 91 flying kennel, a K9-class model

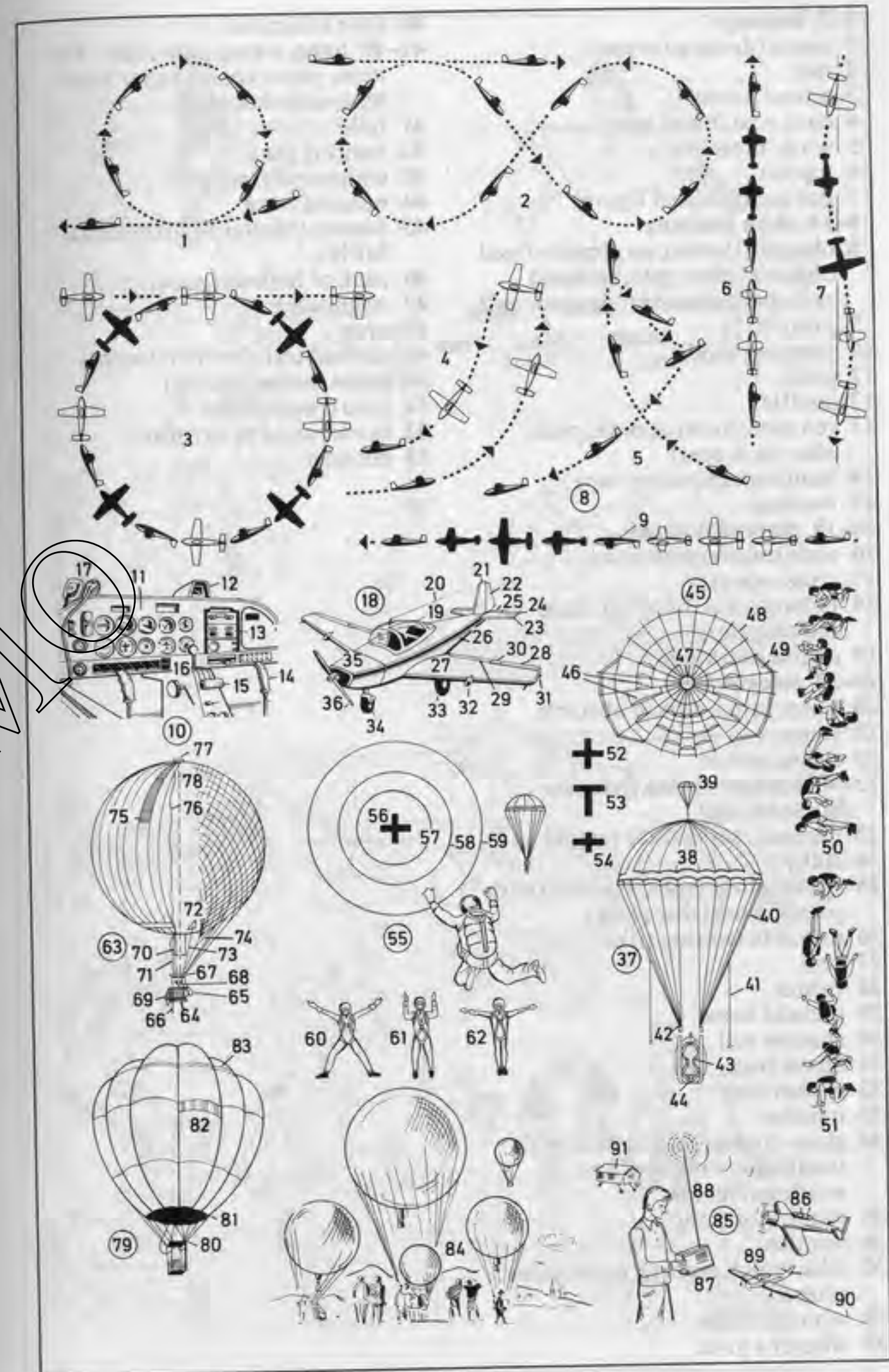

- 1-7 dressage
- 1 arena (dressage arena)
- 2 rail
- 3 school horse
- 4 dark coat (black coat)
- 5 white breeches
- 6 top hat
- 7 gait (also: school figure)
- 8-14 show jumping
- 8 obstacle (fence), an almost-fixed obstacle; *sim.*: gate, gate and rails, palisade, oxer, mound, wall
- 9 jumper
- 10 jumping saddle
- 11 girth
- 12 snaffle
- 13 red coat (hunting pink, pink; also: dark coat)
- 14 hunting cap (riding cap)
- 15 bandage
- 16-19 three-day event
- 16 endurance competition
- 17 cross-country
- 18 helmet (also: hard hat, hard hunting cap)
- 19 course markings
- 20-22 steeplechase
- 20 water jump, a fixed obstacle
- 21 jump
- 22 riding switch
- 23-40 harness racing (harness horse racing)
- 23 harness racing track (track)
- 24 sulky
- 25 spoke wheel (spoked wheel) with plastic wheel disc (disk)
- 26 driver in trotting silks
- 27 rein
- 28 trotter
- 29 piebald horse
- 30 shadow roll
- 31 elbow boot
- 32 rubber boot
- 33 number
- 34 glass-covered grandstand with totalizator windows (tote windows) inside
- 35 totalizator (tote)
- 36 number
- 37 odds (price, starting price, price offered)
- 38 winners' table
- 39 winner's price

- 40 time indicator
- 41-49 hunt, a drag hunt; *sim.*: fox hunt, paper chase (paper hunt, hare-and-hounds)
- 41 field
- 42 hunting pink
- 43 whipper-in (whip)
- 44 hunting horn
- 45 Master (Master of foxhounds, MFH)
- 46 pack of hounds (pack)
- 47 staghound
- 48 drag
- 49 scented trail (artificial scent)
- 50 horse racing (racing)
- 51 field (racehorses)
- 52 favourite (*Am.* favorite)
- 53 outsider

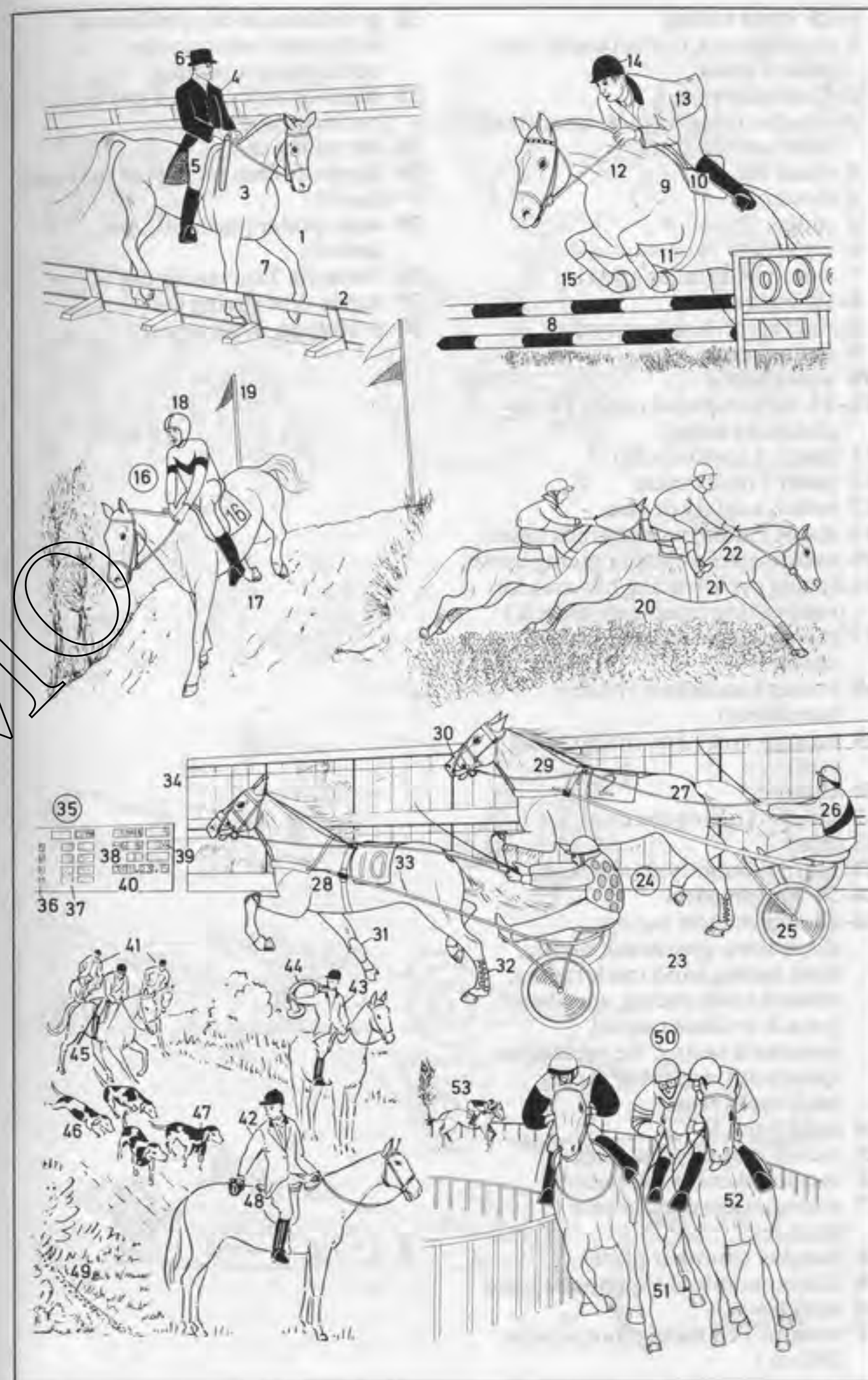

1-23 cycle racing

- 1 cycling track (cycle track); *here*: indoor track
 2-7 six-day race
 2 six-day racer, a track racer (track rider) on the track
 3 crash hat
 4 stewards
 5 judge
 6 lap scorer
 7 rider's box (racer's box)
 8-10 road race
 8 road racer, a racing cyclist
 9 racing jersey
 10 water bottle
 11-15 motor-paced racing (long-distance racing)
 11 pacer, a motorcyclist
 12 pacer's motorcycle
 13 roller, a safety device
 14 stayer (motor-paced track rider)
 15 motor-paced cycle, a racing cycle
 16 racing cycle (racing bicycle) for road racing (road race bicycle)
 17 racing saddle, an unsprung saddle
 18 racing handlebars (racing handlebar)
 19 tubular tyre (*Am.* tyre) (racing tyre)
 20 chain
 21 toe clip (racing toe clip)
 22 strap
 23 spare tubular tyre (*Am.* tyre)

24-38 motorsports

- 24-28 motorcycle racing;
disciplines: grasstrack racing, road racing, sand track racing, cement track racing, speedway [on ash or shale tracks], mountain racing, ice racing (ice speedway), scramble racing, trial, moto cross
 24 sand track
 25 racing motorcyclist (rider)
 26 leather overalls (leathers)
 27 racing motorcycle, a solo machine
 28 number (number plate)
 29 sidecar combination on the bend
 30 sidecar
 31 streamlined racing motorcycle [500 cc.]

- 32 gymkhana, a competition of skill; *here*: motorcyclist performing a jump
 33 cross-country race, a test in performance
 34-38 racing cars
 34 Formula One racing car (a mono posto)
 35 rear spoiler (aerofoil, *Am.* airfoil)
 36 Formula Two racing car
 37 Super-Vee racing car
 38 prototype, a racing car

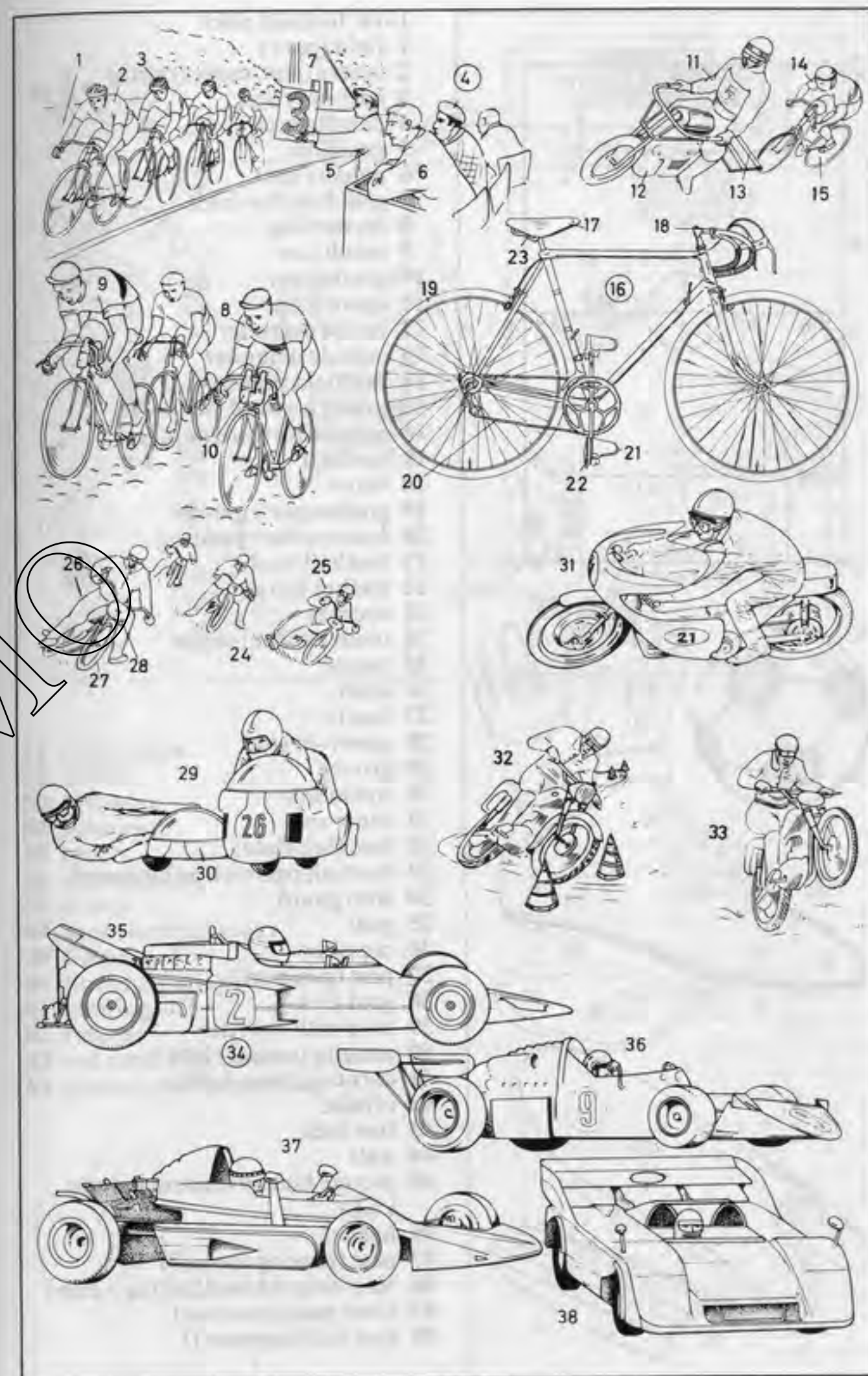



- 1-16 football pitch
- 1 field (park)
- 2 centre (*Am.* center) circle
- 3 half-way line
- 4 penalty area
- 5 goal area
- 6 penalty spot
- 7 goal line (by-line)
- 8 corner flag
- 9 touch line
- 10 goalkeeper
- 11 spare man
- 12 inside defender
- 13 outside defender
- 14 midfield players
- 15 inside forward (striker)
- 16 outside forward (winger)
- 17 football
- 18 valve
- 19 goalkeeper's gloves
- 20 foam rubber padding
- 21 football boot
- 22 leather lining
- 23 counter
- 24 foam rubber tongue
- 25 bands
- 26 shaft
- 27 insole
- 28 screw-in stud
- 29 groove
- 30 nylon sole
- 31 inner sole
- 32 lace (bootlace)
- 33 football pad with ankle guard
- 34 shin guard
- 35 goal
- 36 crossbar
- 37 post (goalpost)
- 38 goal kick
- 39 save with the fists
- 40 penalty (penalty kick)
- 41 corner (corner kick)
- 42 offside
- 43 free kick
- 44 wall
- 45 bicycle kick (overhead bicycle kick)
- 46 header
- 47 pass (passing the ball)
- 48 receiving the ball (taking a pass)
- 49 short pass (one-two)
- 50 foul (infringement)

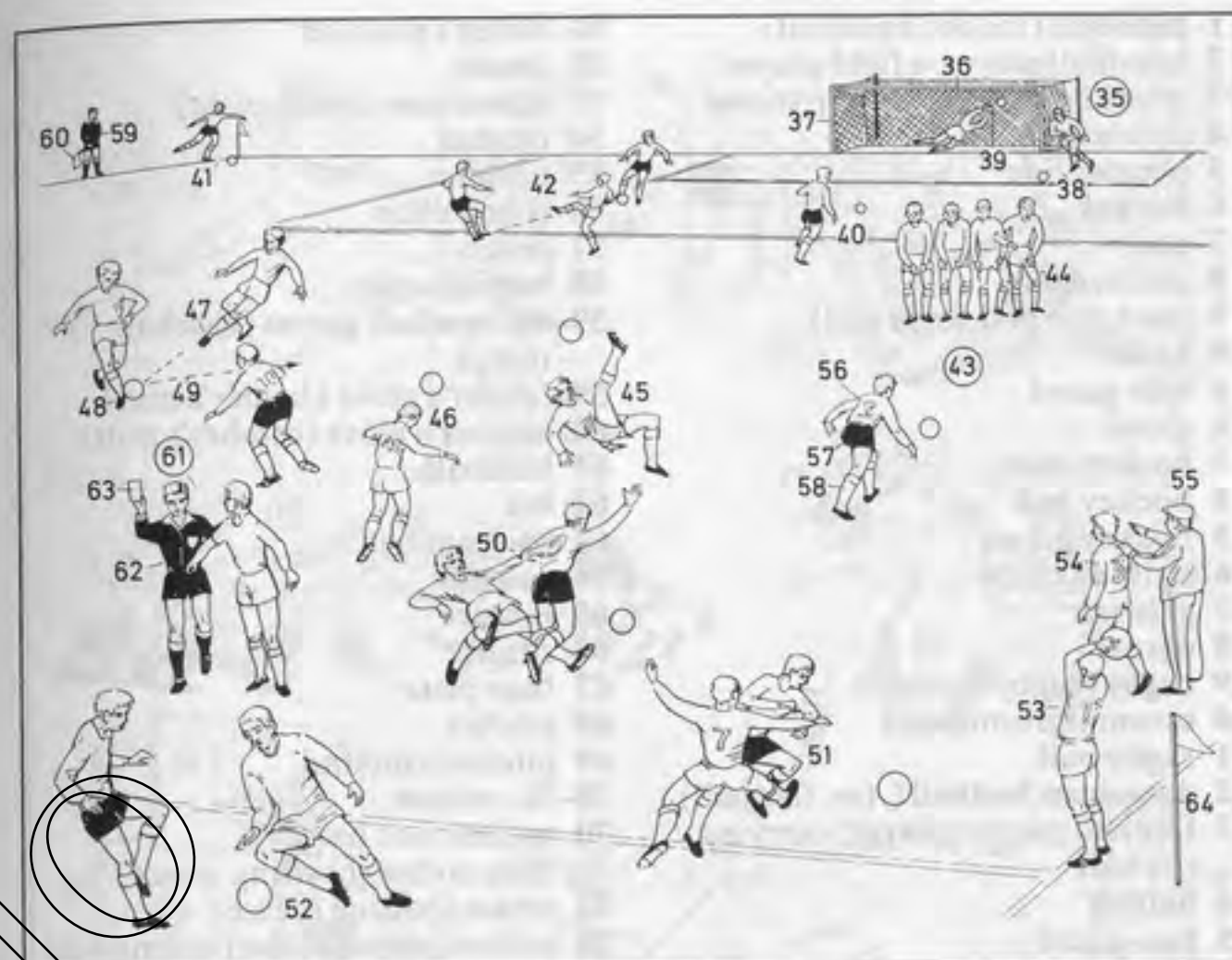

- 51 obstruction
- 52 dribble
- 53 throw-in
- 54 substitute
- 55 coach
- 56 shirt (jersey)
- 57 shorts
- 58 sock (football sock)
- 59 linesman
- 60 linesman's flag
- 61 sending-off
- 62 referee
- 63 red card; also: yellow card
- 64 centre (*Am.* center) flag

- 1 handball (indoor handball)
- 2 handball player, a field player
- 3 attacker, making a jump throw
- 4 defender
- 5 penalty line
- 6 hockey
- 7 goal
- 8 goalkeeper
- 9 pad (shin pad, knee pad)
- 10 kicker
- 11 face guard
- 12 glove
- 13 hockey stick
- 14 hockey ball
- 15 hockey player
- 16 striking circle
- 17 sideline
- 18 corner
- 19 rugby (rugby football)
- 20 scrum (scrummage)
- 21 rugby ball
- 22 American football (Am. football)
- 23 football player (player) carrying the ball
- 24 helmet
- 25 face guard
- 26 padded jersey
- 27 ball (pigskin)
- 28 basketball
- 29 basketball
- 30 backboard
- 31 basket posts
- 32 basket
- 33 basket ring
- 34 target rectangle
- 35 basketball player shooting
- 36 end line
- 37 restricted area
- 38 free-throw line
- 39 substitute
- 40-69 baseball
- 40-58 field (park)
- 40 spectator barrier
- 41 outfielder
- 42 short stop
- 43 second base
- 44 baseman
- 45 runner
- 46 first base
- 47 third base
- 48 foul line (base line)
- 49 pitcher's mound
- 50 pitcher

- 51 batter's position
- 52 batter
- 53 home base (home plate)
- 54 catcher
- 55 umpire
- 56 coach's box
- 57 coach
- 58 batting order
- 59-60 baseball gloves (baseball mitts)
- 59 fielder's glove (fielder's mitt)
- 60 catcher's glove (catcher's mitt)
- 61 baseball
- 62 bat
- 63 batter at bat
- 64 catcher
- 65 umpire
- 66 runner
- 67 base plate
- 68 pitcher
- 69 pitcher's mound
- 70-76 cricket
- 70 wicket with bails
- 71 back crease (bowling crease)
- 72 crease (batting crease)
- 73 wicket keeper of the fielding side
- 74 batsman
- 75 bat (cricket bat)
- 76 fielder (bowler)
- 77-82 croquet
- 77 winning peg
- 78 hoop
- 79 corner peg
- 80 croquet player
- 81 croquet mallet
- 82 croquet ball

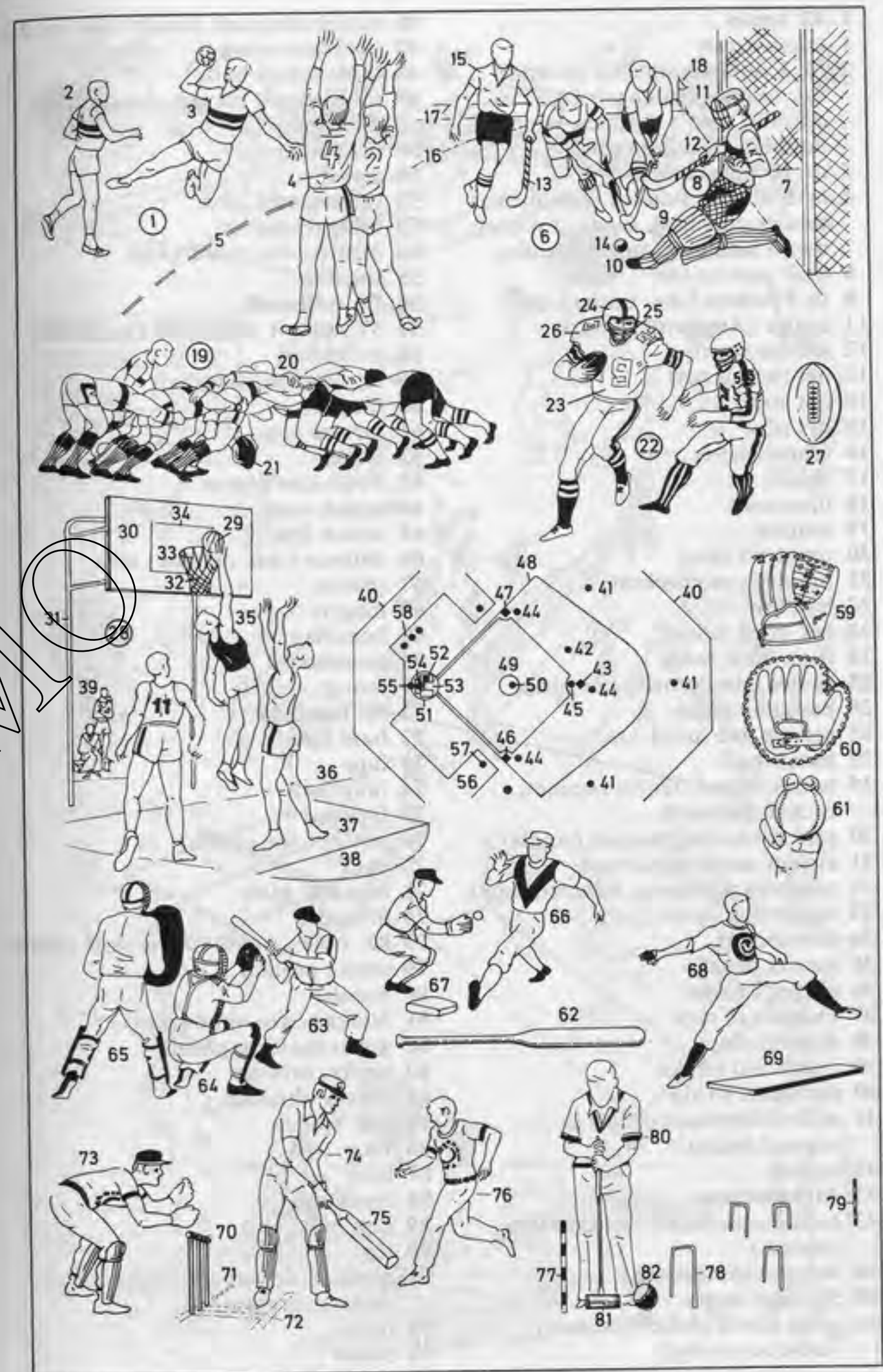

- 1-42 tennis
 1 tennis court
 2 to 3 doubles sideline (sideline for doubles matches); *kinds of doubles*: men's doubles, women's doubles, mixed doubles
 3 to 10 base line
 4 to 5 singles sideline (sideline for singles matches); *kinds of singles*: men's singles, women's singles
 6 to 7 service line
 8 to 9 centre (*Am.* center) line
 11 centre (*Am.* center) mark
 12 service court
 13 net (tennis net)
 14 net strap
 15 net post
 16 tennis player
 17 smash
 18 opponent
 19 umpire
 20 umpire's chair
 21 umpire's microphone
 22 ball boy
 23 net-cord judge
 24 foot-fault judge
 25 centre (*Am.* center) line judge
 26 base line judge
 27 service line judge
 28 tennis ball
 29 tennis racket (tennis racquet, racket, racquet)
 30 racket handle (racquet handle)
 31 strings (striking surface)
 32 press (racket press, racquet press)
 33 tightening screw
 34 scoreboard
 35 results of sets
 36 player's name
 37 number of sets
 38 state of play
 39 backhand stroke
 40 forehand stroke
 41 volley (forehand volley at normal height)
 42 service
- 46 racket (racquet) handle (bat handle)
 47 blade covering
 48 table tennis ball
 49 table tennis players; *here*: mixed doubles
 50 receiver
 51 server
 52 table tennis table
 53 table tennis net
 54 centre (*Am.* center) line
 55 sideline
- 56-71 volleyball
 56-57 correct placing of the hands
 58 volleyball
 59 serving the volleyball
 60 blocker
 61 service area
 62 server
 63 front-line player
 64 attack area
 65 attack line
 66 defence (*Am.* defense) area
 67 referee
 68 umpire
 69 linesman
 70 scoreboard
 71 scorer
- 72-78 faustball
 72 base line
 73 tape
 74 faust ball
 75 forward
 76 centre (*Am.* center)
 77 back
 78 hammer blow
- 79-93 golf
 79-82 hole, a part of the golf course
 79 teeing ground
 80 rough
 81 bunker (*Am.* sand trap)
 82 green (putting green)
 83 golfer, driving
 84 follow-through
 85 golf trolley
 86 flag
 87 hole
 88 flagstick
 89 golf ball
 90 tee
 91 wood, a driver; *sim.*: brassie (brassy, brasse)
 92 iron
 93 putter

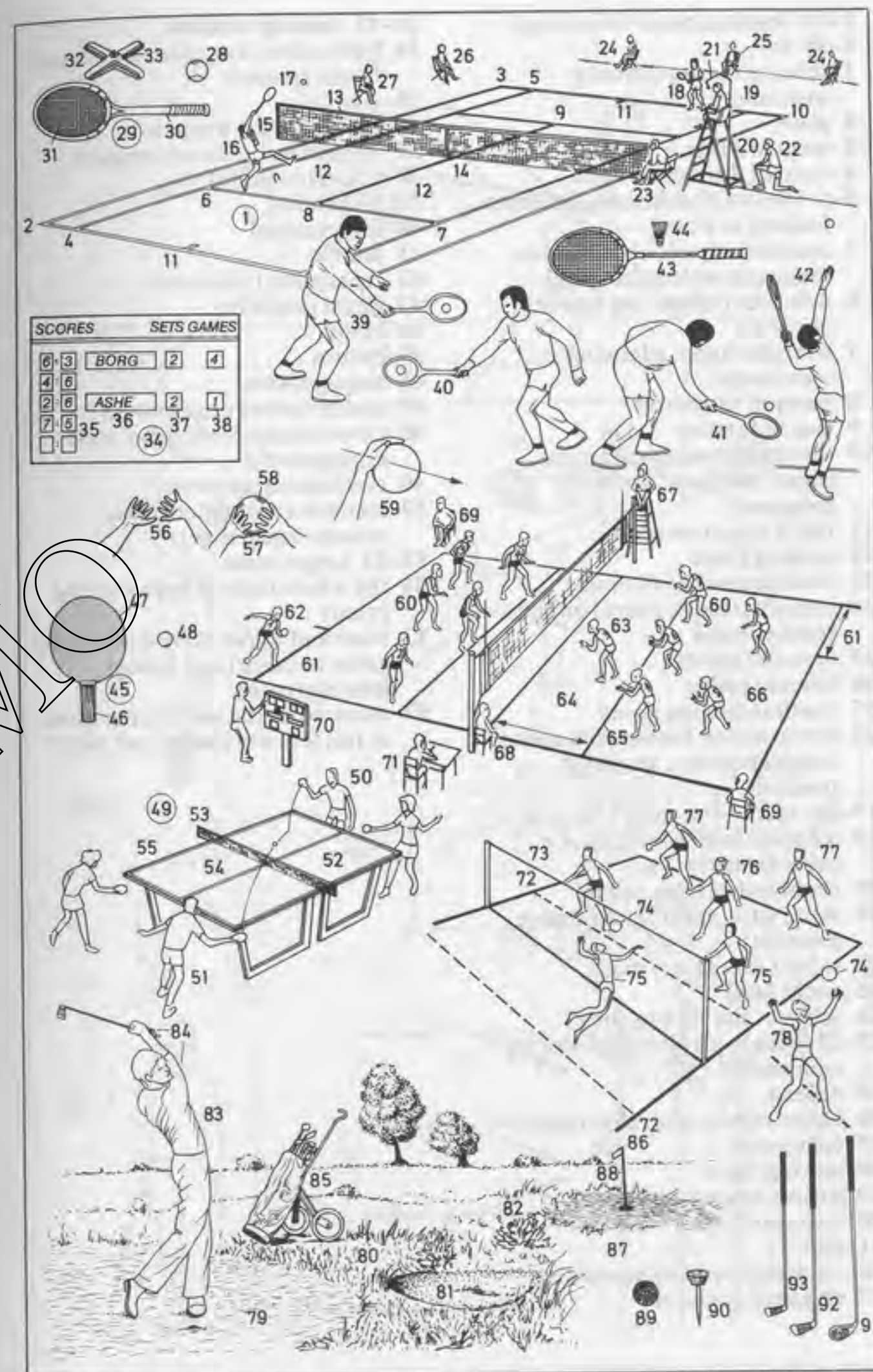

- 1-33 fencing (modern fencing)
 1-18 foil
 1 fencing master (fencing instructor)
 2 piste
 3 on guard line
 4 centre (*Am.* center) line
 5-6 fencers (foil fencers, foilsmen, foilists) in a bout
 5 attacker (attacking fencer) in lunging position (lunging)
 6 defender (defending fencer), parrying
 7 straight thrust, a fencing movement
 8 parry of the tierce
 9 line of fencing
 10 the three fencing measures [short, medium, and long measure]
 11 foil, a thrust weapon
 12 fencing glove
 13 fencing mask (foil mask)
 14 neck flap (neck guard) on the fencing mask
 15 metallic jacket
 16 fencing jacket
 17 heelless fencing shoes
 18 first position for fencer's salute (initial position, on guard position)
 19-24 sabre (*Am.* saber) fencing
 19 sabreurs (sabre fencers, *Am.* saber fencers)
 20 (light) sabre (*Am.* saber)
 21 sabre (*Am.* saber) glove (sabre gauntlet)
 22 sabre (*Am.* saber) mask
 23 cut at head
 24 parry of the fifth (quinte)
 25-33 épée, with electrical scoring equipment
 25 épéist
 26 electric épée; *also*: electric foil
 27 épée point
 28 scoring lights
 29 spring-loaded wire spool
 30 indicator light
 31 wire
 32 electronic scoring equipment
 33 on guard position

- 34-45 fencing weapons
 34 light sabre (*Am.* saber), a cut and thrust weapon
 35 guard
 36 épée, a thrust weapon
 37 French foil, a thrust weapon
 38 guard (coquille)
 39 Italian foil
 40 foil pommel
 41 handle
 42 cross piece (quillons)
 43 guard (coquille)
 44 blade
 45 button
 46 engagements
 47 quarte (carte) engagement
 48 tierce engagement (*also*: sixte engagement)
 49 circling engagement
 50 seconde engagement (*also*: octave engagement)
 51-53 target areas
 51 the whole body in épée fencing (men)
 52 head and upper body down to the groin in sabre (*Am.* saber) fencing (men)
 53 trunk from the neck to the groin in foil fencing (ladies and men)

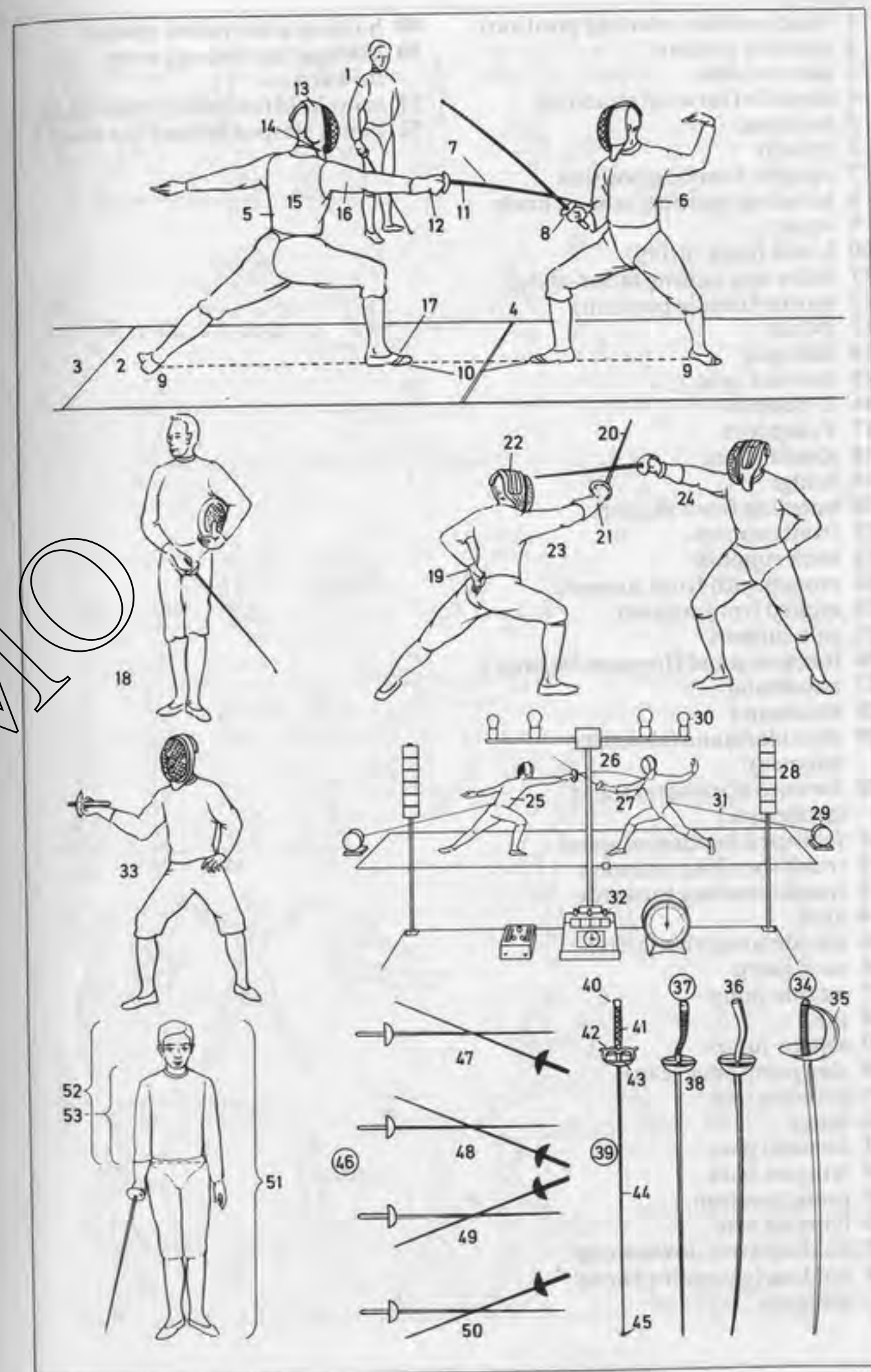

- 1 basic position (starting position)
- 2 running posture
- 3 side straddle
- 4 straddle (forward straddle)
- 5 toe stand
- 6 crouch
- 7 upright kneeling position
- 8 kneeling position, seat on heels
- 9 squat
- 10 L seat (long sitting)
- 11 tailor seat (sitting tailor-style)
- 12 hurdle (hurdle position)
- 13 V-seat
- 14 side split
- 15 forward split
- 16 L-support
- 17 V-support
- 18 straddle seat
- 19 bridge
- 20 kneeling front support
- 21 front support
- 22 back support
- 23 crouch with front support
- 24 arched front support
- 25 side support
- 26 forearm stand (forearm balance)
- 27 handstand
- 28 headstand
- 29 shoulder stand (shoulder balance)
- 30 forward horizontal stand (arabesque)
- 31 rearward horizontal stand
- 32 trunk-bending sideways
- 33 trunk-bending forwards
- 34 arch
- 35 astride jump (butterfly)
- 36 tuck jump
- 37 astride jump
- 38 pike
- 39 scissor jump
- 40 stag jump (stag leap)
- 41 running step
- 42 lunge
- 43 forward pace
- 44 lying on back
- 45 prone position
- 46 lying on side
- 47 holding arms downwards
- 48 holding (extending) arms sideways
- 49 holding arms raised upward
- 50 holding (extending) arms forward
- 51 arms held (extended) backward
- 52 hands clasped behind the head

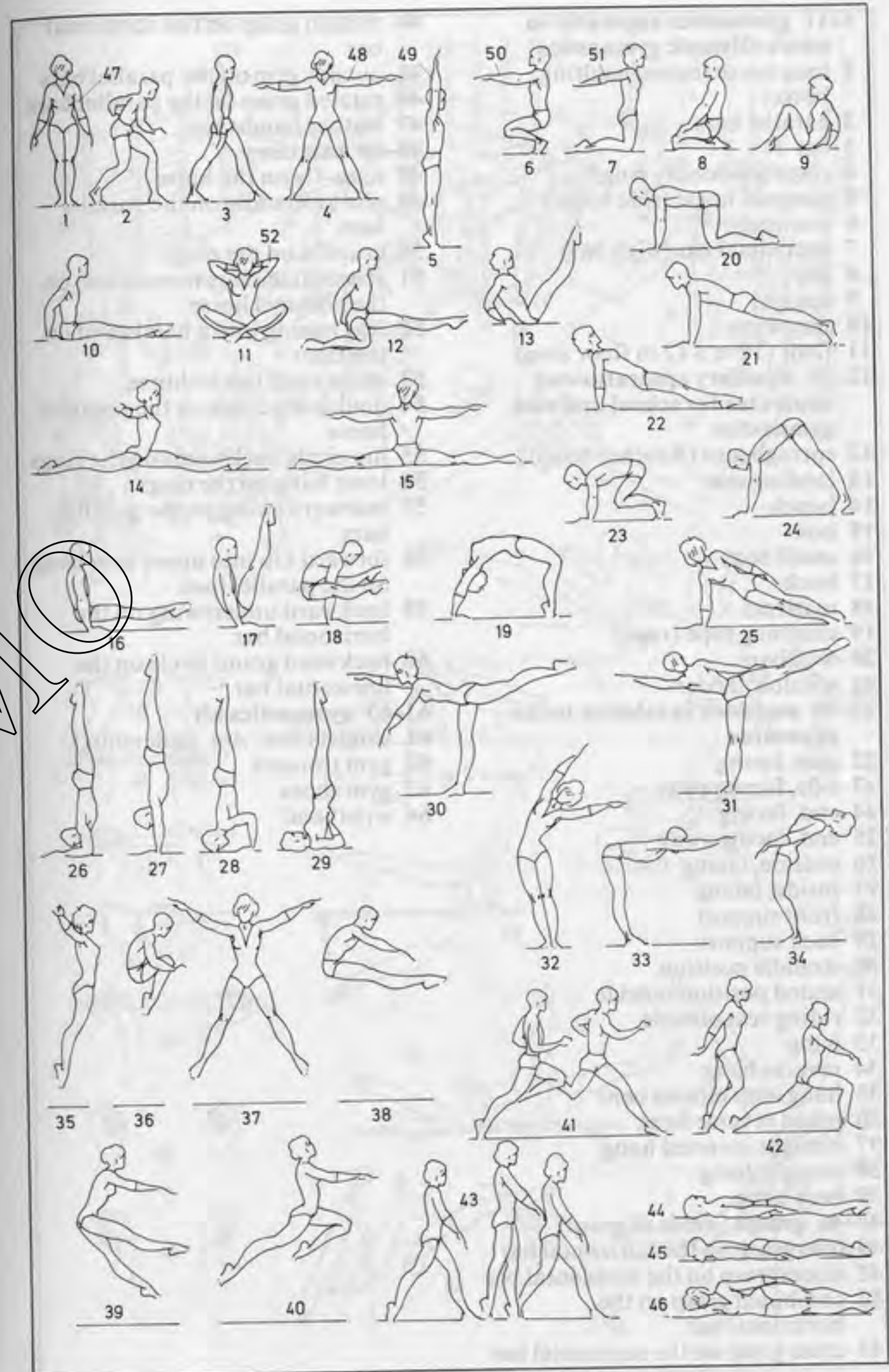

- 1-11 gymnastics apparatus in men's Olympic gymnastics
- 1 long horse (horse, vaulting horse)
- 2 parallel bars
- 3 bar
- 4 rings (stationary rings)
- 5 pommel horse (side horse)
- 6 pommel
- 7 horizontal bar (high bar)
- 8 bar
- 9 upright
- 10 stay wires
- 11 floor (12 m x 12 m floor area)
- 12-21 auxiliary apparatus and apparatus for school and club gymnastics
- 12 springboard (Reuther board)
- 13 landing mat
- 14 bench
- 15 box
- 16 small box
- 17 buck
- 18 mattress
- 19 climbing rope (rope)
- 20 wall bars
- 21 window ladder
- 22-39 positions in relation to the apparatus
- 22 side, facing
- 23 side, facing away
- 24 end, facing
- 25 end, facing away
- 26 outside, facing
- 27 inside, facing
- 28 front support
- 29 back support
- 30 straddle position
- 31 seated position outside
- 32 riding seat outside
- 33 hang
- 34 reverse hang
- 35 hang with elbows bent
- 36 piked reverse hang
- 37 straight inverted hang
- 38 straight hang
- 39 bent hang
- 40-46 grasps (kinds of grasp)
- 40 overgrasp on the horizontal bar
- 41 undergrasp on the horizontal bar
- 42 combined grasp on the horizontal bar
- 43 cross grasp on the horizontal bar

- 44 rotated grasp on the horizontal bar
- 45 outside grip on the parallel bars
- 46 rotated grasp on the parallel bars
- 47 leather handstrap
- 48-60 exercises
- 48 long-fly on the horse
- 49 rise to straddle on the parallel bars
- 50 crucifix on the rings
- 51 scissors (scissors movement) on the pommel horse
- 52 legs raising into a handstand on the floor
- 53 squat vault on the horse
- 54 double leg circle on the pommel horse
- 55 hip circle backwards on the rings
- 56 lever hang on the rings
- 57 rearward swing on the parallel bars
- 58 forward kip into upper arm hang on the parallel bars
- 59 backward underswing on the horizontal bar
- 60 backward grand circle on the horizontal bar
- 61-63 gymnastics kit
- 61 singlet (vest, Am. undershirt)
- 62 gym trousers
- 63 gym shoes
- 64 wristband

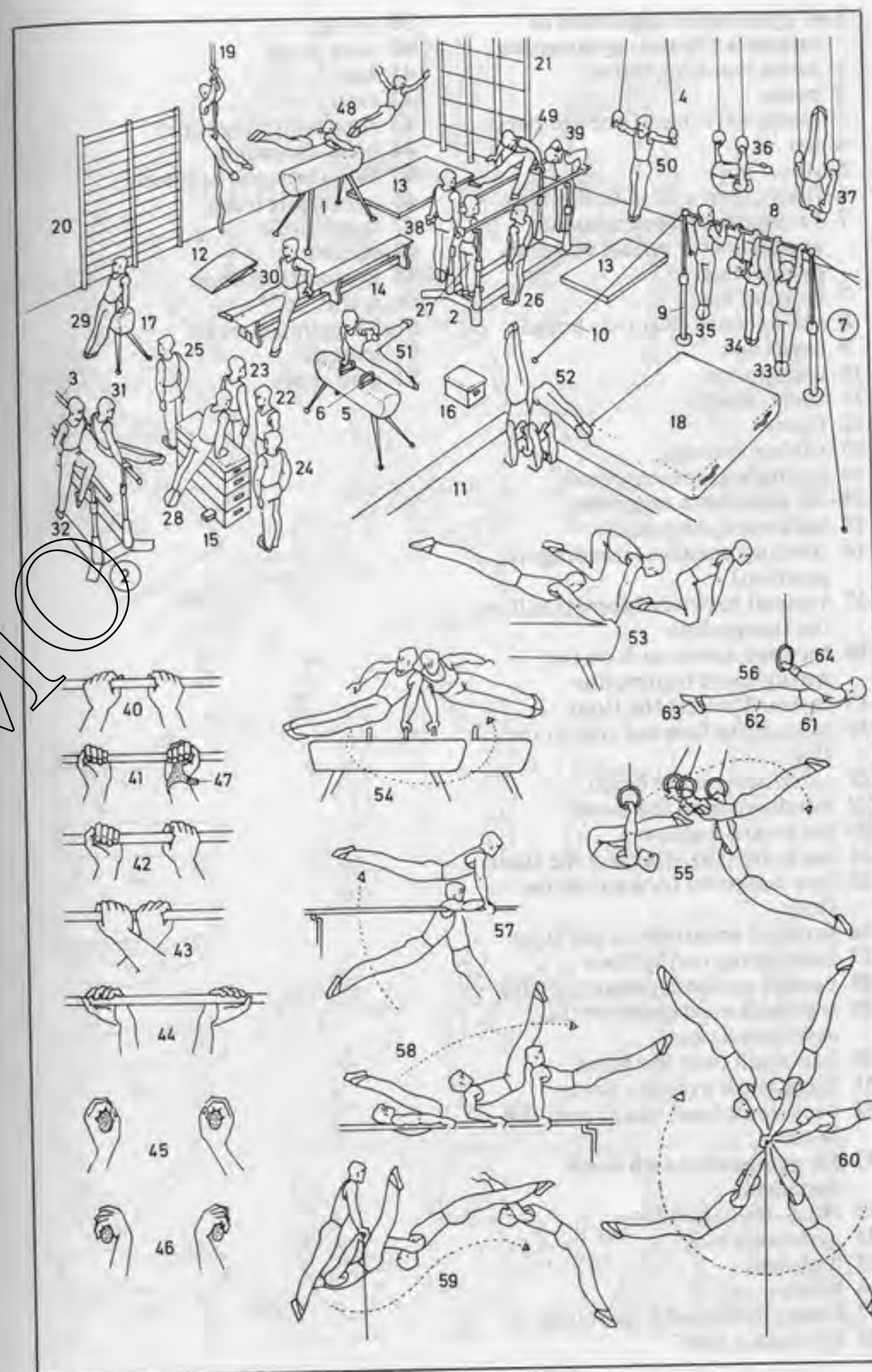

- 1-6 gymnastics apparatus in women's Olympic gymnastics
- 1 horse (vaulting horse)
- 2 beam
- 3 asymmetric bars (uneven bars)
- 4 bar
- 5 stay wires
- 6 floor (12 m x 12 m floor area)
- 7-14 auxiliary apparatus and apparatus for school and club gymnastics
- 7 landing mat
- 8 springboard (Reuther board)
- 9 small box
- 10 trampoline
- 11 sheet (web)
- 12 frame
- 13 rubber springs
- 14 springboard trampoline
- 15-32 apparatus exercises
- 15 backward somersault
- 16 spotting position (standing-in position)
- 17 vertical backward somersault on the trampoline
- 18 forward somersault on the springboard trampoline
- 19 forward roll on the floor
- 20 long-fly to forward roll on the floor
- 21 cartwheel on the beam
- 22 handspring on the horse
- 23 backward walkover
- 24 back flip (flik-flak) on the floor
- 25 free walkover forward on the floor
- 26 forward walkover on the floor
- 27 headspring on the floor
- 28 upstart on the asymmetric bars
- 29 free backward circle on the asymmetric bars
- 30 face vault over the horse
- 31 flank vault over the horse
- 32 back vault (rear vault) over the horse
- 33-50 gymnastics with hand apparatus
- 33 hand-to-hand throw
- 34 gymnastic ball
- 35 high toss
- 36 bounce
- 37 hand circling with two clubs
- 38 gymnastic club

- 39 swing
- 40 tuck jump
- 41 bar
- 42 skip
- 43 rope (skipping rope)
- 44 criss-cross skip
- 45 skip through the hoop
- 46 gymnastic hoop
- 47 hand circle
- 48 serpent
- 49 gymnastic ribbon
- 50 spiral
- 51-52 gymnastics kit
- 51 leotard
- 52 gym shoes

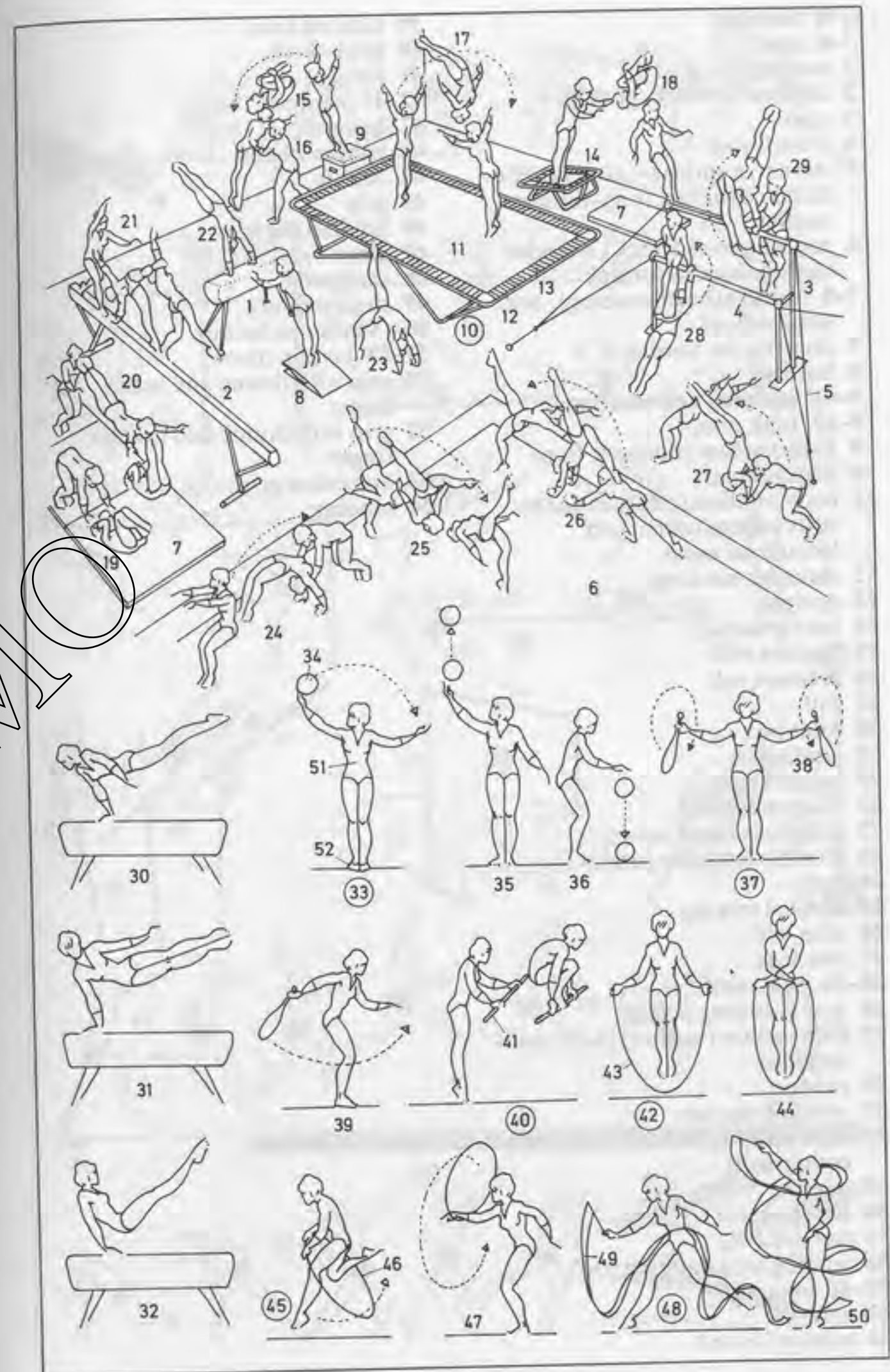

DEMO

- 1-8 running
- 1-6 start
- 1 starting block
- 2 adjustable block (pedal)
- 3 start
- 4 crouch start
- 5 runner, a sprinter; *also*: middle-distance runner, long-distance runner
- 6 running track (track), a cinder track or synthetic track
- 7-8 hurdles (hurdle racing); *sim.*: steeplechase
- 7 clearing the hurdle
- 8 hurdle
- 9-41 jumping and vaulting
- 9-27 high jump
- 9 Fosbury flop (Fosbury, flop)
- 10 high jumper
- 11 body rotation (rotation on the body's longitudinal and latitudinal axes)
- 12 shoulder landing
- 13 upright
- 14 bar (crossbar)
- 15 Eastern roll
- 16 Western roll
- 17 roll
- 18 rotation
- 19 landing
- 20 height scale
- 21 Eastern cut-off
- 22 scissors (scissor jump)
- 23 straddle (straddle jump)
- 24 turn
- 25 vertical free leg
- 26 take-off
- 27 free leg
- 28-36 pole vault
- 28 pole (vaulting pole)
- 29 pole vaulter (vaulter) in the pull-up phase
- 30 swing
- 31 crossing the bar
- 32 high jump apparatus (high jump equipment)
- 33 upright
- 34 bar (crossbar)
- 35 box
- 36 landing area (landing pad)
- 37-41 long jump
- 37 take-off
- 38 take-off board

- 39 landing area
- 40 hitch-kick
- 41 hang
- 42-47 hammer throw
- 42 hammer
- 43 hammer head
- 44 handle
- 45 grip
- 46 holding the grip
- 47 glove
- 48 shot put
- 49 shot (weight)
- 50 O'Brien technique
- 51-53 javelin throw
- 51 grip with thumb and index finger
- 52 grip with thumb and middle finger
- 53 horseshoe grip
- 54 binding

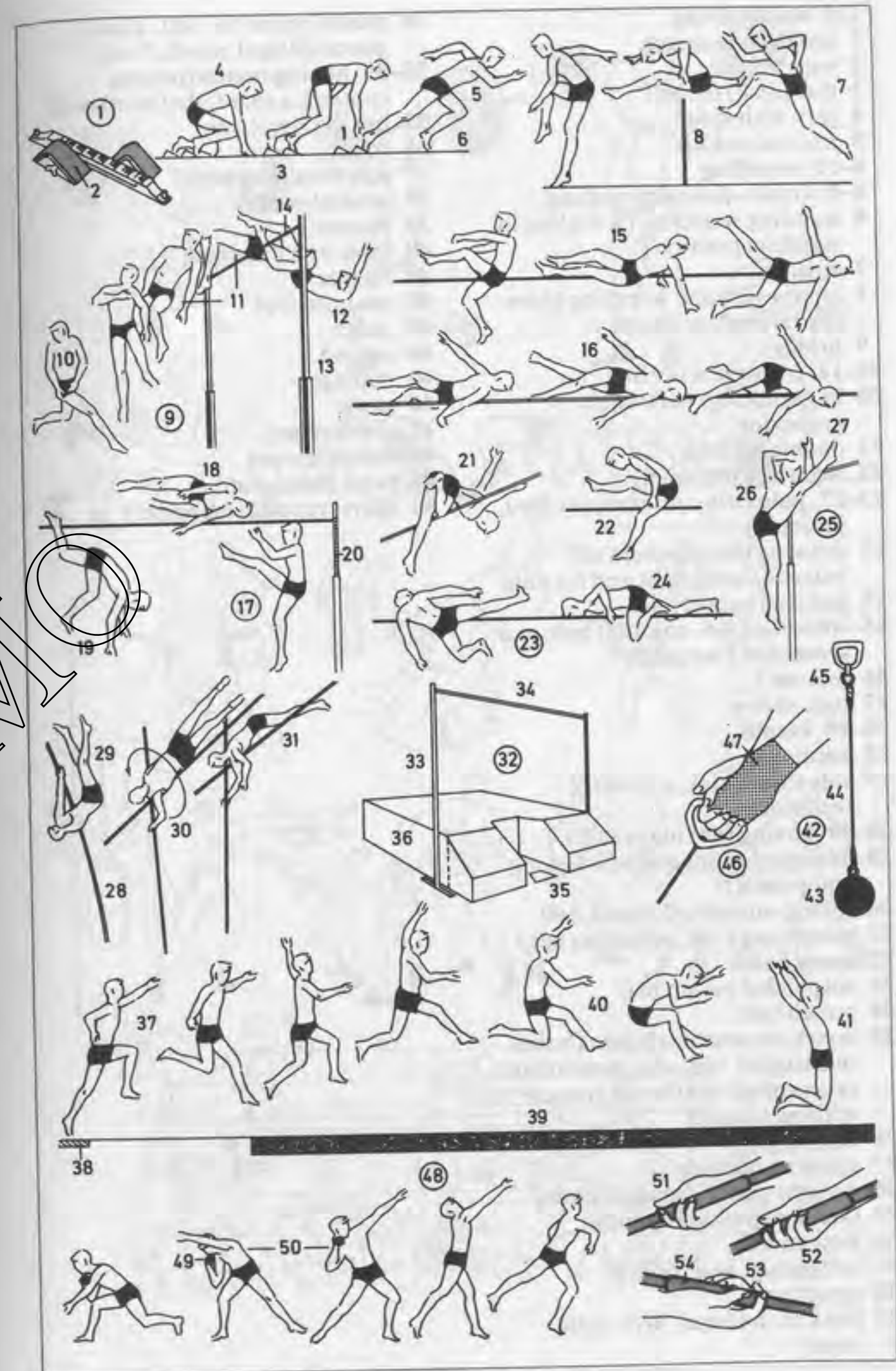

- 1-5 weightlifting
- 1 squat-style snatch
- 2 weightlifter
- 3 disc (disk) barbell
- 4 jerk with split
- 5 maintained lift
- 6-12 wrestling
- 6-9 Greco-Roman wrestling
- 6 standing wrestling (wrestling in standing position)
- 7 wrestler
- 8 on-the-ground wrestling (*here*: the referee's position)
- 9 bridge
- 10-12 freestyle wrestling
- 10 bar arm (arm bar) with grapevine
- 11 double leg lock
- 12 wrestling mat (mat)
- 13-17 judo (*sim.*: ju-jitsu, jiu jitsu, ju-jutsu)
- 13 drawing the opponent off balance to the right and forward
- 14 judoka (judoist)
- 15 coloured (*Am.* colored) belt, as a symbol of Dan grade
- 16 referee
- 17 judo throw
- 18-19 karate
- 18 karateka
- 19 side thrust kick, a kicking technique
- 20-50 boxing (boxing match)
- 20-24 training apparatus (training equipment)
- 20 spring-supported punch ball
- 21 punch bag (*Am.* punching bag)
- 22 speed ball
- 23 suspended punch ball
- 24 punch ball
- 25 boxer, an amateur boxer (boxes in a singlet, vest, *Am.* undershirt) or a professional boxer (boxes without singlet)
- 26 boxing glove
- 27 sparring partner
- 28 straight punch (straight blow)
- 29 ducking and sidestepping
- 30 headguard
- 31 infighting; *here*: clinch
- 32 uppercut
- 33 hook to the head; *here*: right hook

- 34 punch below the belt, a foul punch (illegal punch, foul)
- 35-50 boxing match (boxing contest), a title fight (title bout)
- 35 boxing ring (ring)
- 36 ropes
- 37 stay wire (stay rope)
- 38 neutral corner
- 39 winner
- 40 loser by a knockout
- 41 referee
- 42 counting out
- 43 judge
- 44 second
- 45 manager
- 46 gong
- 47 timekeeper
- 48 record keeper
- 49 press photographer (reporter)
- 50 sports reporter (reporter)

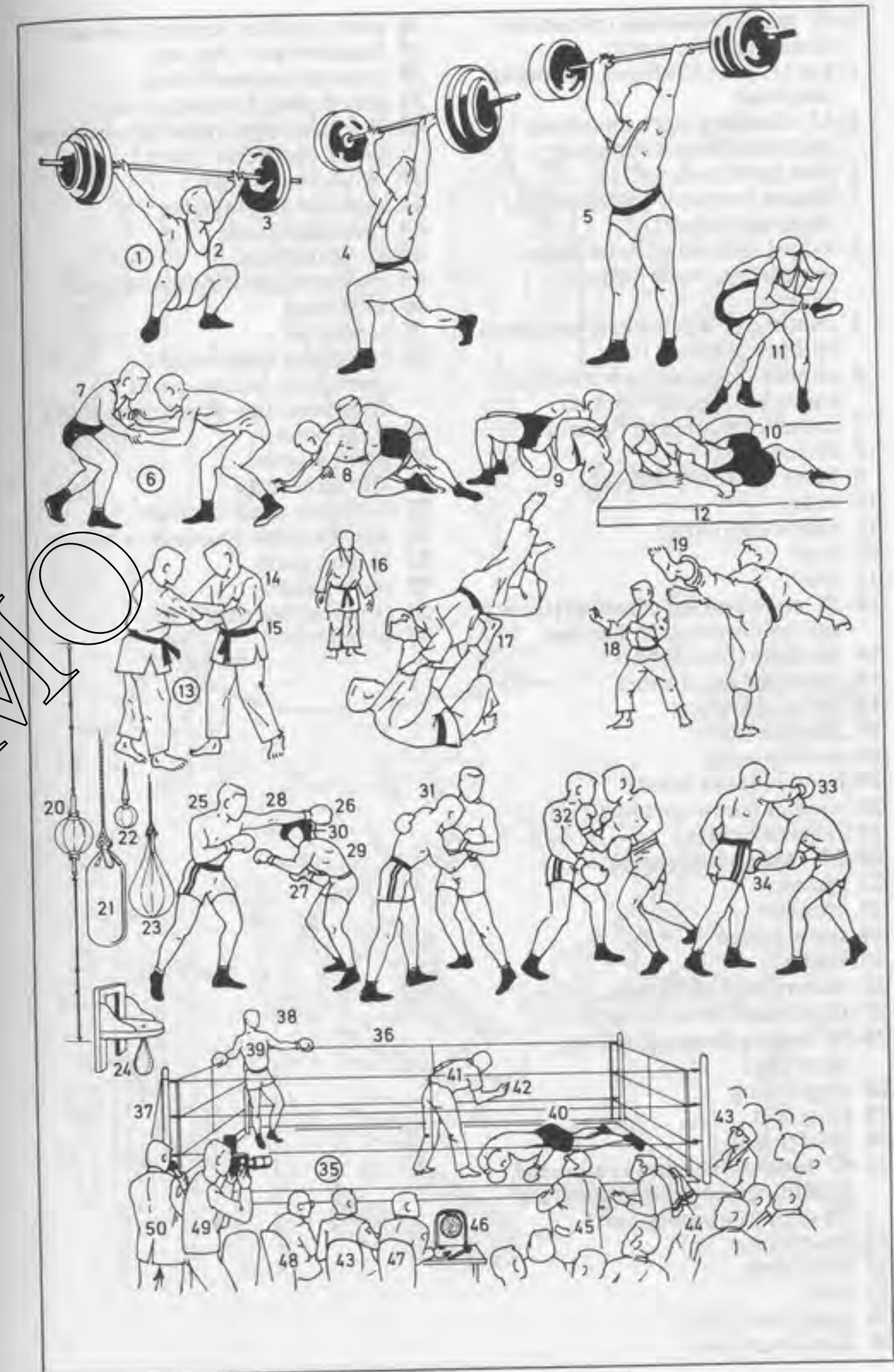

DEMO

- 1-57 **mountaineering** (mountain climbing, Alpinism)
- 1 hut (Alpine Club hut, mountain hut, base)
- 2-13 **climbing** (rock climbing) [rock climbing technique]
- 2 rock face (rock wall)
- 3 fissure (vertical, horizontal, or diagonal fissure)
- 4 ledge (rock ledge, grass ledge, scree ledge, snow ledge, ice ledge)
- 5 mountaineer (climber, mountain climber, Alpinist)
- 6 anorak (high-altitude anorak, snowshirt, padded jacket)
- 7 breeches (climbing breeches)
- 8 chimney
- 9 belay (spike, rock spike)
- 10 belay
- 11 rope sling (sling)
- 12 rope
- 13 spur
- 14-21 **snow and ice climbing** [snow and ice climbing technique]
- 14 ice slope (firn slope)
- 15 snow and ice climber
- 16 ice axe (*Am. ax*)
- 17 step (ice step)
- 18 snow goggles
- 19 hood (anorak hood)
- 20 cornice (snow cornice)
- 21 ridge (ice ridge)
- 22-27 **rope** (roped party)
- 22 glacier
- 23 crevasse
- 24 snow bridge
- 25 leader
- 26 second man (belayer)
- 27 third man (non-belayer)
- 28-30 **roping down** (abseiling, rapelling)
- 28 abseil sling
- 29 sling seat
- 30 Dülfer seat
- 31-57 **mountaineering equipment** (climbing equipment, snow and ice climbing equipment)
- 31 ice axe (*Am. ax*)
- 32 wrist sling
- 33 pick
- 34 adze (*Am. adz*)
- 35 karabiner hole
- 36 short-shafted ice axe (*Am. ax*)
- 37 hammer axe (*Am. ax*)
- 38 general-purpose piton
- 39 abseil piton (ringed piton)
- 40 ice piton (semi-tubular screw ice piton, corkscrew piton)
- 41 drive-in ice piton
- 42 mountaineering boot
- 43 corrugated sole
- 44 climbing boot
- 45 roughened stiff rubber upper
- 46 karabiner
- 47 screwgate
- 48 crampons (lightweight crampons, twelve-point crampons, ten-point crampons)
- 49 front points
- 50 point guards
- 51 crampon strap
- 52 crampon cable fastener
- 53 safety helmet (protective helmet)
- 54 helmet lamp
- 55 snow gaiters
- 56 climbing harness
- 57 sit harness

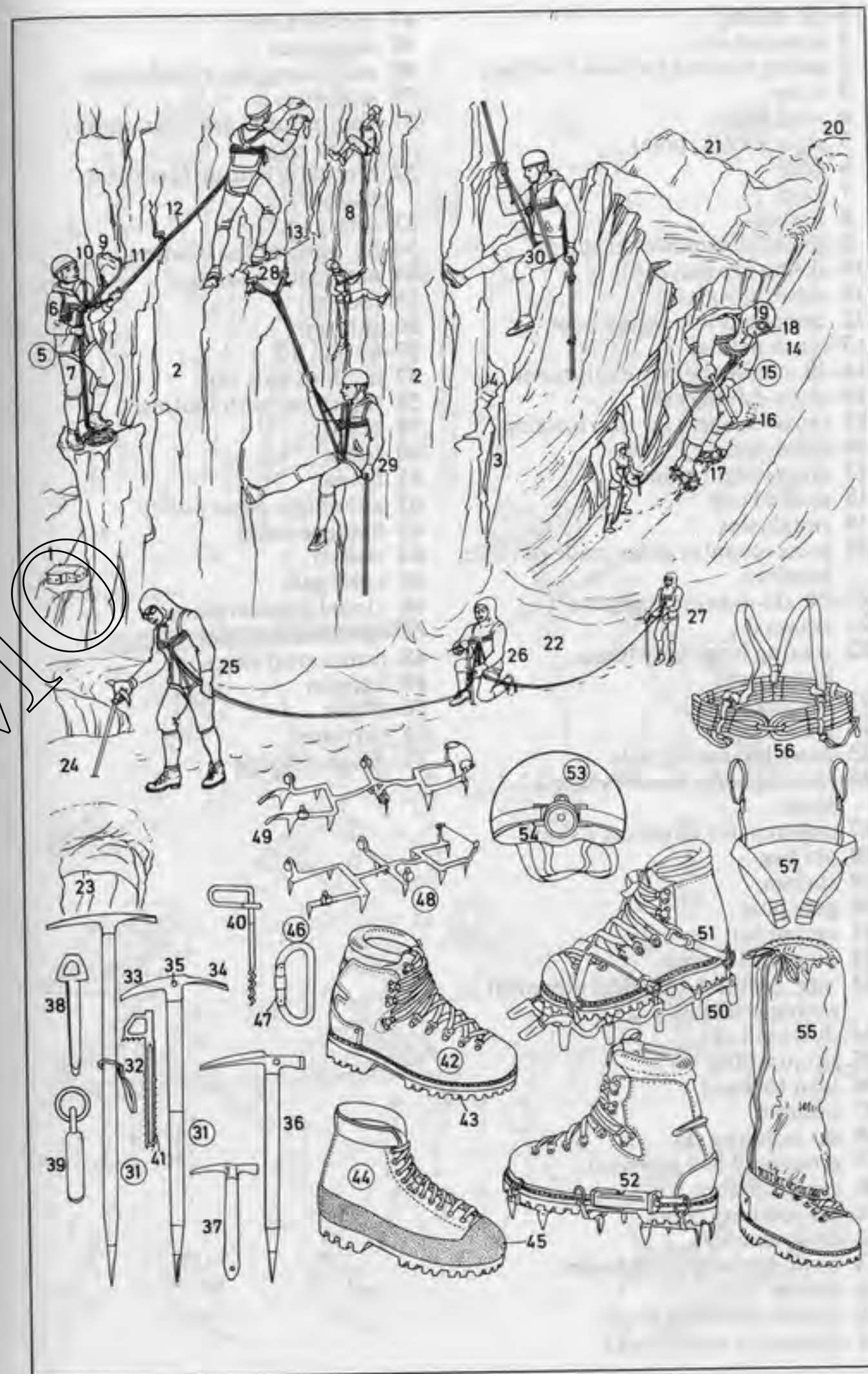

- 1-72 skiing
- 1 compact ski
- 2 safety binding (release binding)
- 3 strap
- 4 steel edge
- 5 ski stick (ski pole)
- 6 grip
- 7 loop
- 8 basket
- 9 ladies' one-piece ski suit
- 10 skiing cap (ski cap)
- 11 skiing goggles
- 12 cemented sole skiing boot
- 13 crash helmet
- 14-20 cross-country equipment
- 14 cross-country ski
- 15 cross-country rat trap binding
- 16 cross-country boot
- 17 cross-country gear
- 18 peaked cap
- 19 sunglasses
- 20 cross-country poles made of bamboo
- 21-24 ski-waxing equipment
- 21 ski wax
- 22 waxing iron (blowlamp, blowtorch)
- 23 waxing cork
- 24 wax scraper
- 25 downhill racing pole
- 26 herringbone, for climbing a slope
- 27 sidestep, for climbing a slope
- 28 ski bag
- 29 slalom
- 30 gate pole
- 31 racing suit
- 32 downhill racing
- 33 'egg' position, the ideal downhill racing position
- 34 downhill ski
- 35 ski jumping
- 36 lean forward
- 37 number
- 38 ski jumping ski
- 39 grooves (3 to 5 grooves)
- 40 cable binding
- 41 ski jumping boots
- 42 cross-country
- 43 cross-country stretch-suit
- 44 course
- 45 course-marking flag
- 46 layers of a modern ski

- 47 special core
- 48 laminates
- 49 stabilizing layer (stabilizer)
- 50 steel edge
- 51 aluminium (*Am.* aluminum) upper edge
- 52 synthetic bottom (artificial bottom)
- 53 safety jet
- 54-56 parts of the binding
- 54 automatic heel unit
- 55 toe unit
- 56 ski stop
- 57-63 ski lift
- 57 double chair lift
- 58 safety bar with footrest
- 59 ski lift
- 60 track
- 61 hook
- 62 automatic cable pulley
- 63 haulage cable
- 64 slalom
- 65 open gate
- 66 closed vertical gate
- 67 open vertical gate
- 68 transversal chicane
- 69 hairpin
- 70 elbow
- 71 corridor
- 72 Allais chicane



DEMO

- 1-26 ice skating
- 1 ice skater, a solo skater
- 2 tracing leg
- 3 free leg
- 4 pair skaters
- 5 death spiral
- 6 pivot
- 7 stag jump (stag leap)
- 8 jump-sit-spin
- 9 upright spin
- 10 holding the foot
- 11-19 compulsory figures
- 11 curve eight
- 12 change
- 13 three
- 14 double-three
- 15 loop
- 16 change-loop
- 17 bracket
- 18 counter
- 19 rocker
- 20-25 ice skates
- 20 speed skating set (speed skate)
- 21 edge
- 22 hollow grinding (hollow ridge, concave ridge)
- 23 ice hockey set (ice hockey skate)
- 24 ice skating boot
- 25 skate guard
- 26 speed skater
- 27-28 skate sailing
- 27 skate sailor
- 28 hand sail
- 29-37 ice hockey
- 29 ice hockey player
- 30 ice hockey stick
- 31 stick handle
- 32 stick blade
- 33 shin pad
- 34 headgear (protective helmet)
- 35 puck, a vulcanized rubber disc (disk)
- 36 goalkeeper
- 37 goal
- 38-40 ice-stick shooting (Bavarian curling)
- 38 ice-stick shooter (Bavarian curler)
- 39 ice stick
- 40 block
- 41-43 curling
- 41 curler
- 42 curling stone (granite)

- 43 curling brush (curling broom, besom)
- 44-46 ice yachting (iceboating, ice sailing)
- 44 ice yacht (iceboat)
- 45 steering runner
- 46 outrigger runner

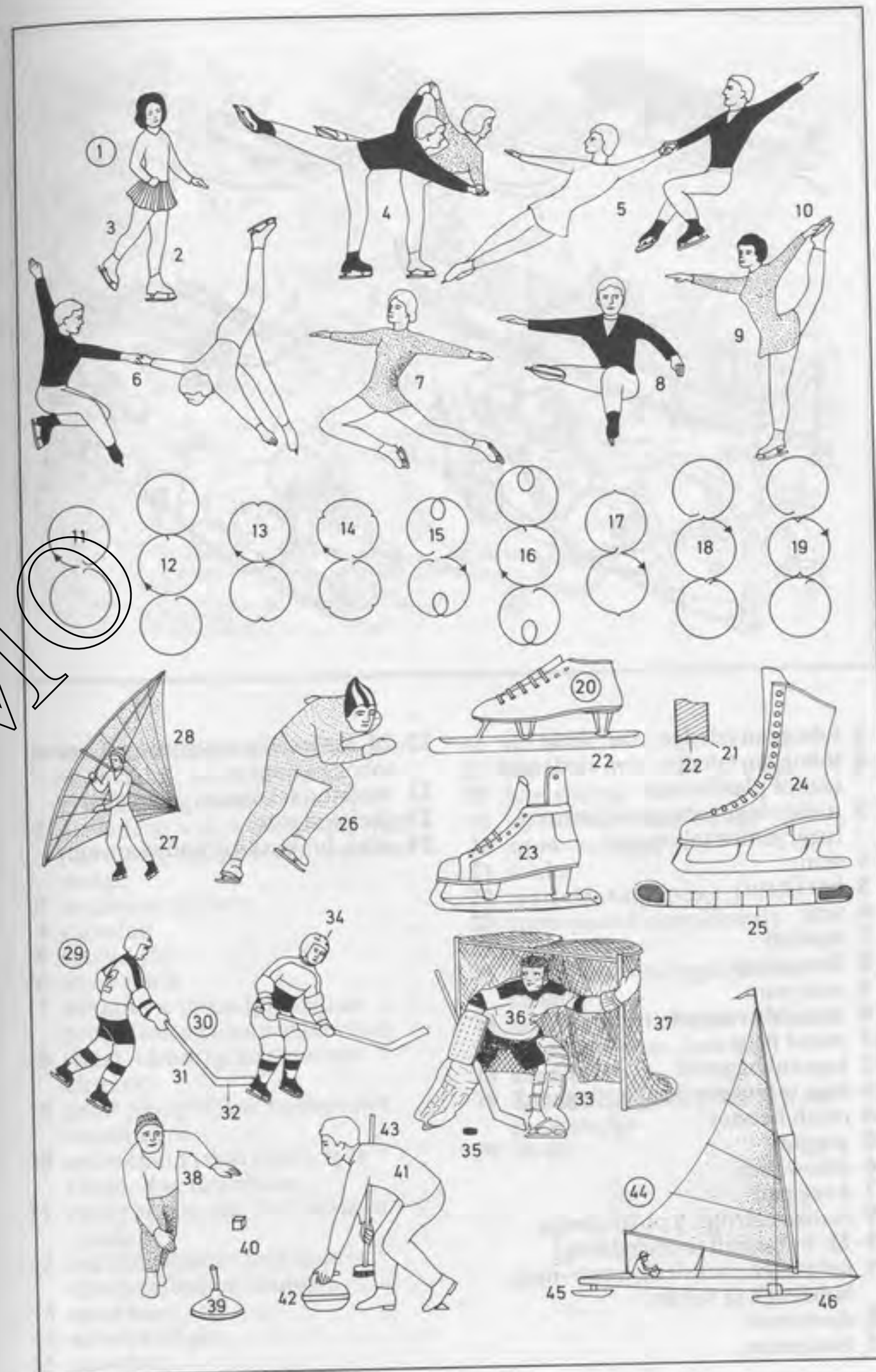

DEMO

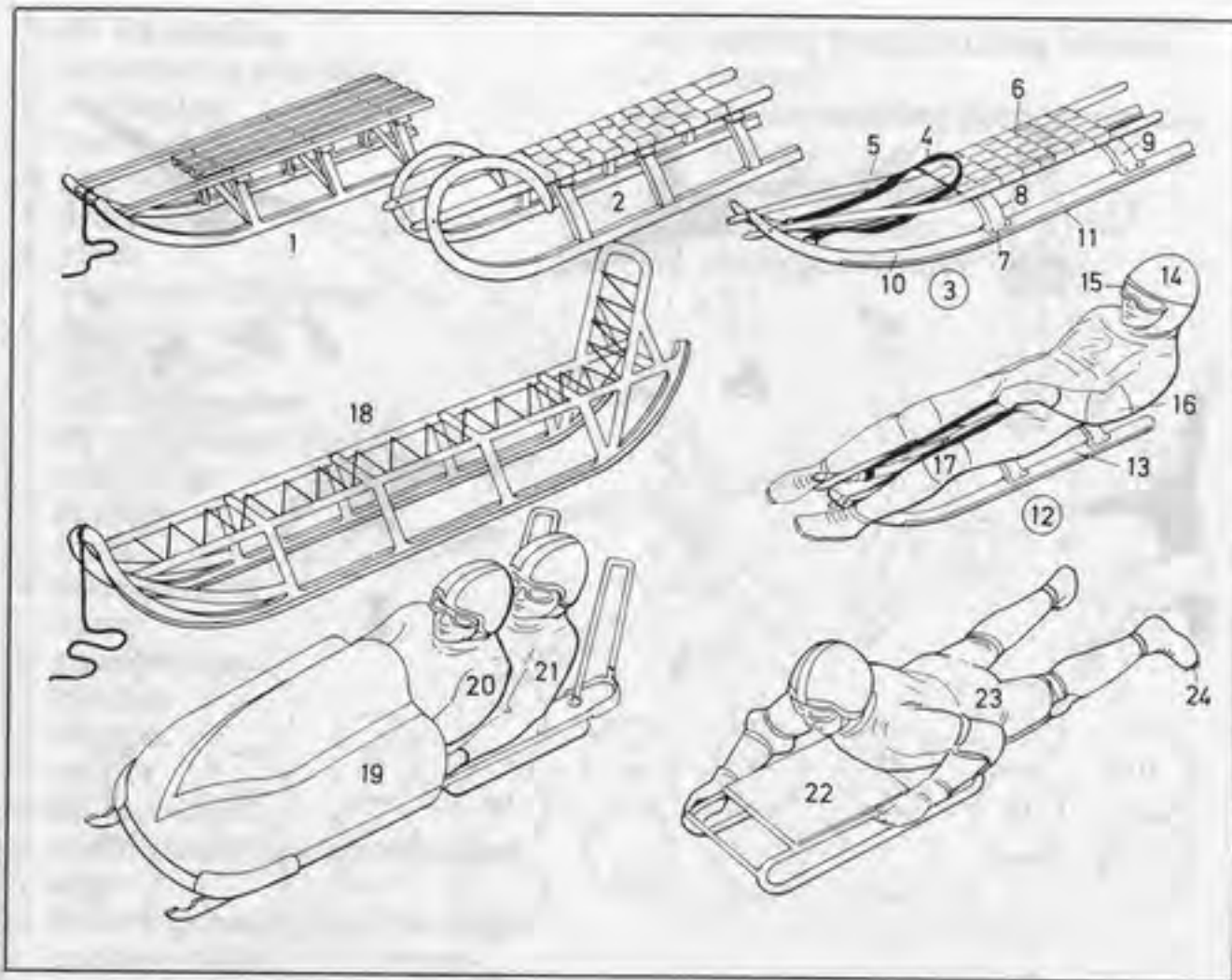

- 1 toboggan (sledge, *Am.* sled)
- 2 toboggan (sledge, *Am.* sled) with seat of plaid straps
- 3 junior luge toboggan (junior luge, junior toboggan)
- 4 rein
- 5 bar (strut)
- 6 seat
- 7 bracket
- 8 front prop
- 9 rear prop
- 10 movable runner
- 11 metal face
- 12 luge tobogganer
- 13 luge toboggan (luge, toboggan)
- 14 crash helmet
- 15 goggles
- 16 elbow pad
- 17 knee pad
- 18 Nansen sledge, a polar sledge
- 19-21 bobsleigh (bobsledding)
- 19 bobsleigh (bobsled), a two-man bobsleigh (a boblet)
- 20 steersman
- 21 brakeman

- 22-24 skeleton tobogganing (Cresta tobogganing)
- 22 skeleton (skeleton toboggan)
- 23 skeleton rider
- 24 rake, for braking and steering

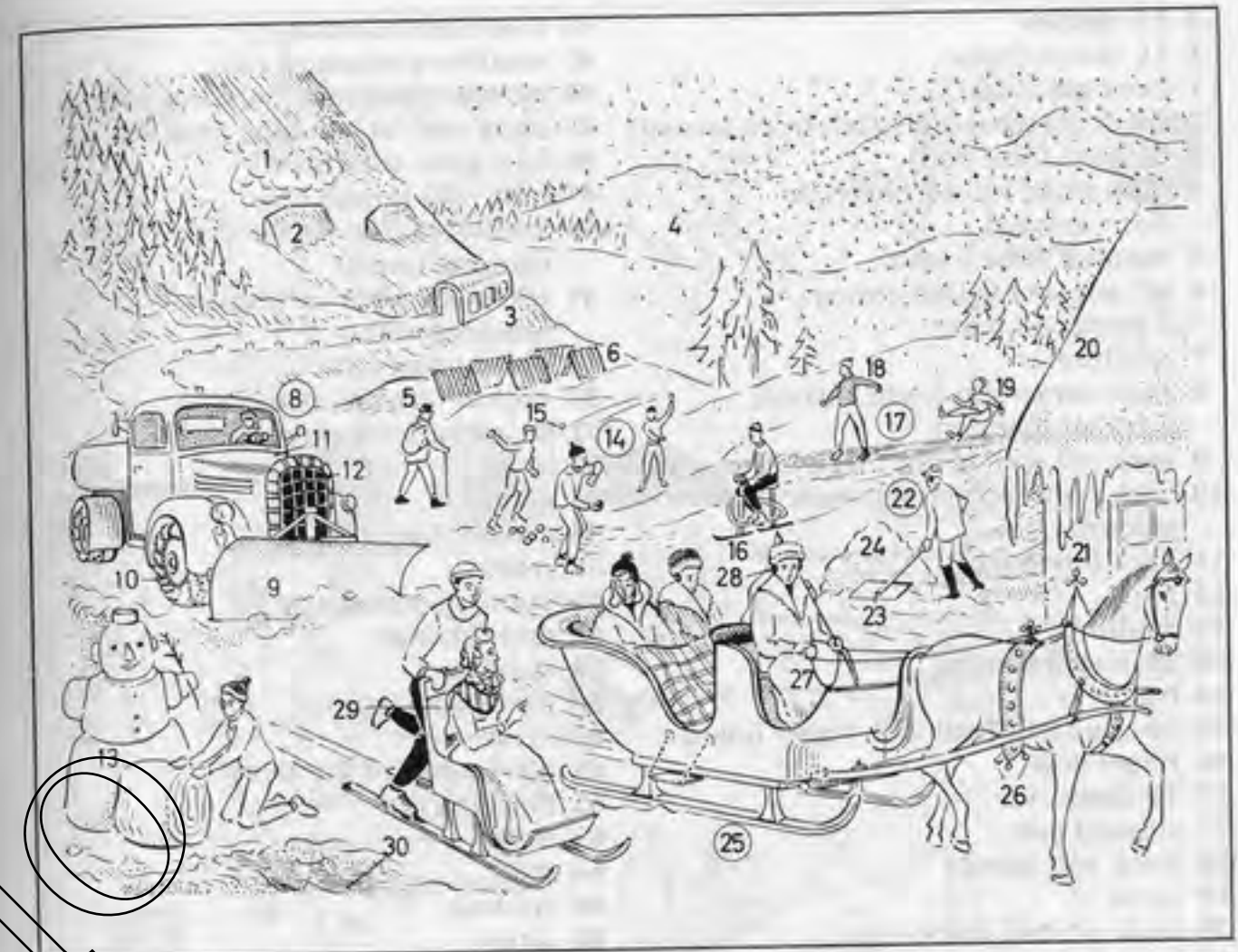

- 1 avalanche (snow avalanche, *Am.* snowslide); *kinds:* wind avalanche, ground avalanche
- 2 avalanche wall, a deflecting wall (diverting wall); *sim.:* avalanche wedge
- 3 avalanche gallery
- 4 snowfall
- 5 snowdrift
- 6 snow fence
- 7 avalanche forest [planted as protection against avalanches]
- 8 street-cleaning lorry (street cleaner)
- 9 snow plough (*Am.* snowplow) attachment
- 10 snow chain (skid chain, tyre chain, *Am.* tire chain)
- 11 radiator bonnet (*Am.* radiator hood)
- 12 radiator shutter and shutter opening (louvre shutter)
- 13 snowman
- 14 snowball fight
- 15 snowball

- 16 ski bob
- 17 slide
- 18 boy, sliding
- 19 icy surface (icy ground)
- 20 snow-covered roof
- 21 icicle
- 22 man clearing snow
- 23 snow push (snow shovel)
- 24 heap of snow
- 25 horse-drawn sleigh (horse sleigh)
- 26 sleigh bells (bells, set of bells)
- 27 foot muff (*Am.* foot bag)
- 28 earmuff
- 29 handsledge (tread sledge); *sim.:* push sledge
- 30 slush

- 1-13 skittles
- 1-11 skittle frame
- 1 front pin (front)
- 2 left front second pin (left front second)
- 3 running three [left]
- 4 right front second pin (right front second)
- 5 running three [right]
- 6 left corner pin (left corner), a corner (copper)
- 7 landlord
- 8 right corner pin (right corner), a corner (copper)
- 9 back left second pin (back left second)
- 10 back right second pin (back right second)
- 11 back pin (back)
- 12 pin
- 13 landlord
- 14-20 tenpin bowling
- 14 frame
- 15 bowling ball (ball with finger holes)
- 16 finger hole
- 17-20 deliveries
- 17 straight ball
- 18 hook ball (hook)
- 19 curve
- 20 back-up ball (back-up)
- 21 boules; *sim.*: Italian game of bocce, green bowls (bowls)
- 22 boules player
- 23 jack (target jack)
- 24 grooved boule
- 25 group of players
- 26 rifle shooting
- 27-29 shooting positions
- 27 standing position
- 28 kneeling position
- 29 prone position
- 30-33 targets
- 30 target for 50 m events (50 m target)
- 31 circle
- 32 target for 100 m events (100 m target)
- 33 bobbing target (turning target, running-boar target)
- 34-39 ammunition
- 34 air rifle cartridge
- 35 rimfire cartridge for zimmerstutzen (indoor target rifle), a smallbore German single-shot rifle
- 36 case head
- 37 caseless round
- 38 .22 long rifle cartridge
- 39 .222 Remington cartridge
- 40-49 sporting rifles
- 40 air rifle
- 41 optical sight
- 42 front sight (foresight)
- 43 smallbore standard rifle
- 44 international smallbore free rifle
- 45 palm rest for standing position
- 46 butt plate with hook
- 47 butt with thumb hole
- 48 smallbore rifle for bobbing target (turning target)
- 49 telescopic sight (riflescope, telescope sight)
- 50 optical ring sight
- 51 optical ring and bead sight
- 52-66 archery (target archery)
- 52 shot
- 53 archer
- 54 competition bow
- 55 riser
- 56 point-of-aim mark
- 57 grip (handle)
- 58 stabilizer
- 59 bow string (string)
- 60 arrow
- 61 pile (point) of the arrow
- 62 fletching
- 63 nock
- 64 shaft
- 65 cresting
- 66 target
- 67 Basque game of pelota (jai alai)
- 68 pelota player
- 69 wicker basket (cesta)
- 70-78 skeet (skeet shooting), a kind of clay pigeon shooting
- 70 skeet over-and-under shotgun
- 71 muzzle with skeet choke
- 72 ready position on call
- 73 firing position
- 74 shooting range
- 75 high house
- 76 low house
- 77 target's path
- 78 shooting station (shooting box)
- 79 aero wheel
- 80 handle
- 81 footrest
- 82 go-karting (karting)
- 83 go-kart (kart)
- 84 number plate (number)
- 85 pedals
- 86 pneumatic tyre (*Am.* tire)
- 87 petrol tank (*Am.* gasoline tank)
- 88 frame
- 89 steering wheel
- 90 bucket seat
- 91 protective bulkhead
- 92 two-stroke engine
- 93 silencer (*Am.* muffler)

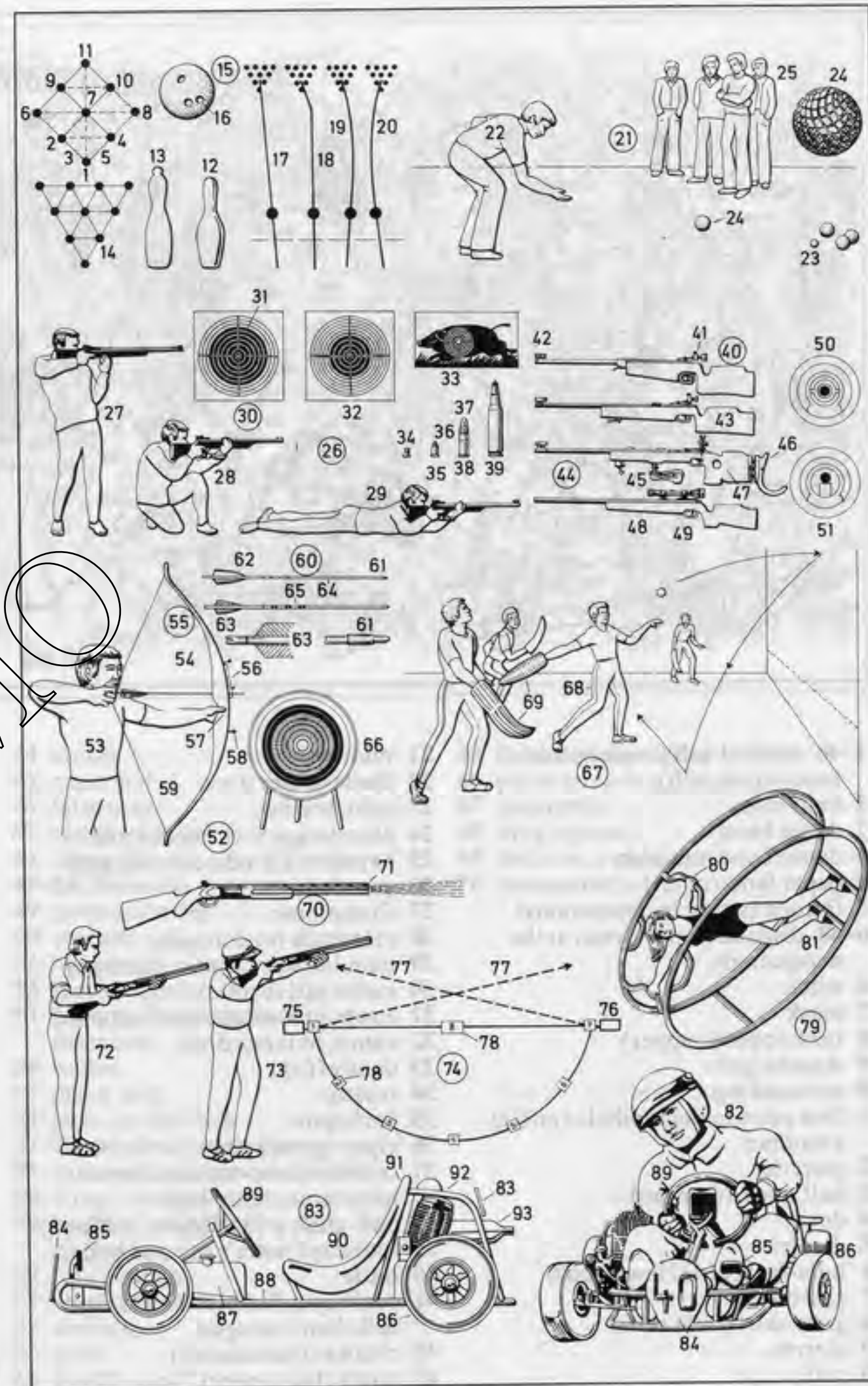



- 1-48 masked ball (masquerade, fancy-dress ball)
 1 ballroom
 2 dance band
 3 dance band musician
 4 paper lantern
 5 festoon (string of decorations)
 6-48 disguise (fancy dress) at the masquerade
 6 witch
 7 mask
 8 fur trapper (trapper)
 9 Apache girl
 10 net stocking
 11 first prize in the tombola (raffle), a hamper
 12 pierette
 13 half mask (domino)
 14 devil
 15 domino
 16 hula-hula girl (Hawaii girl)
 17 garland
 18 grass skirt (hula skirt)
 19 pierrot
 20 ruff

- 21 midinette
 22 Biedermeier dress
 23 poke bonnet
 24 décolletage with beauty spot
 25 bayadère (Hindu dancing girl)
 26 grandee
 27 Columbine
 28 maharaja (maharajah)
 29 mandarin, a Chinese dignitary
 30 exotic girl (exotic)
 31 cowboy; *sim.*: gaucho (vaquero)
 32 vamp, in fancy dress
 33 dandy (fop)
 34 rosette
 35 harlequin
 36 gipsy (gypsy) girl
 37 cocotte (demi-monde, demi-mondaine, demi-rep)
 38 owl-glass, a fool (jester, buffoon)
 39 foolscap (jester's cap and bells)
 40 rattle
 41 odalisque, Eastern female slave in Sultan's seraglio
 42 chalwar (pantaloon)
 43 pirate (buccaneer)



- 44 tattoo
 45 paper hat
 46 false nose
 47 clapper (rattle)
 48 slapstick
 49-54 fireworks
 49 percussion cap
 50 cracker
 51 banger
 52 jumping jack
 53 cannon cracker (maroon, marroon)
 54 rocket
 55 paper ball
 56 jack-in-the-box
 57-70 carnival procession
 57 carnival float (carnival truck)
 58 King Carnival
 59 bauble (fool's sceptre, *Am.* scepter)
 60 fool's badge
 61 Queen Carnival
 62 confetti
 63 giant
 64 beauty queen

- 65 fairy-tale figure
 66 paper streamer
 67 majorette
 68 king's guard
 69 buffoon, a clown
 70 lansquenet's drum

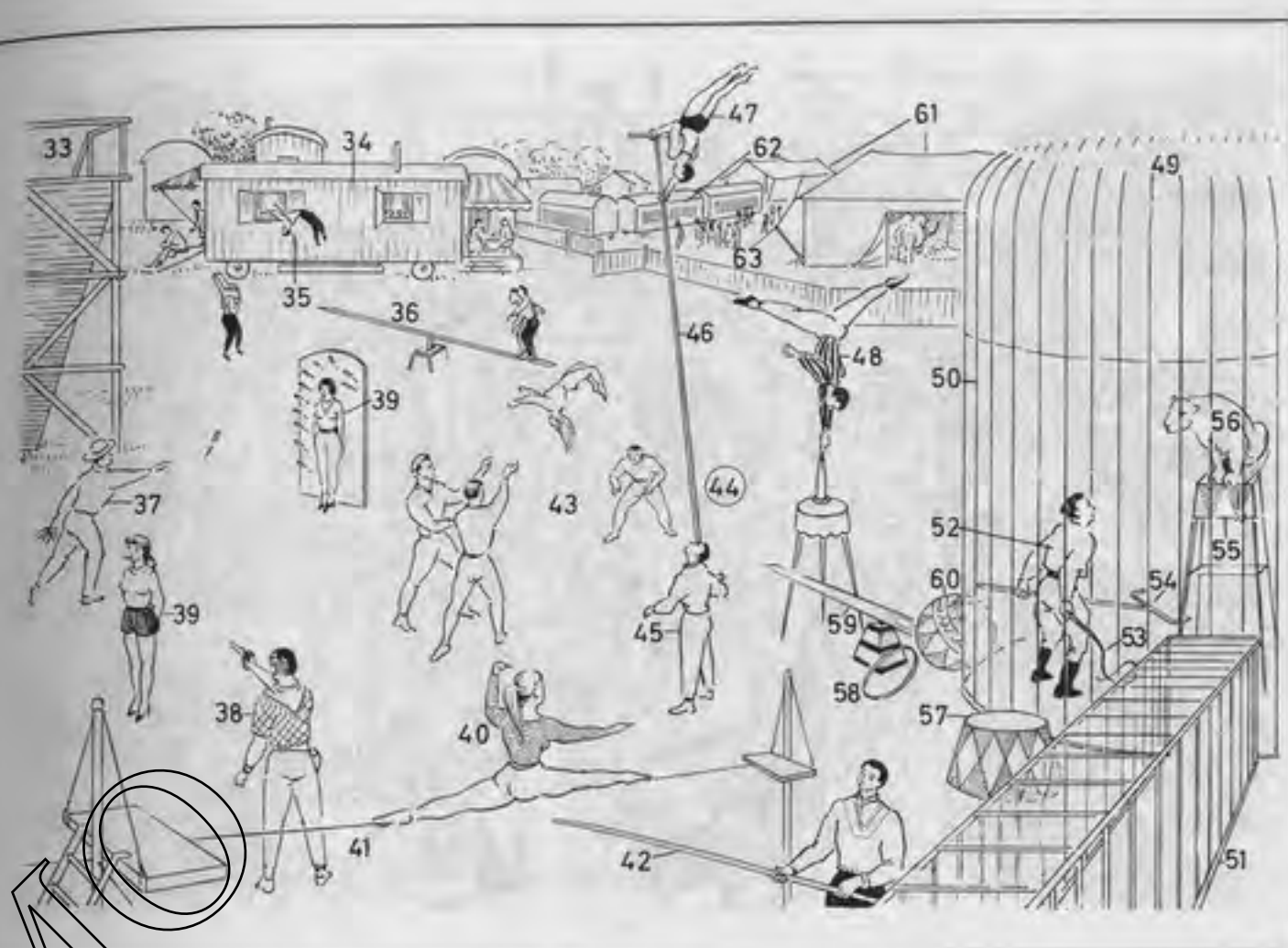
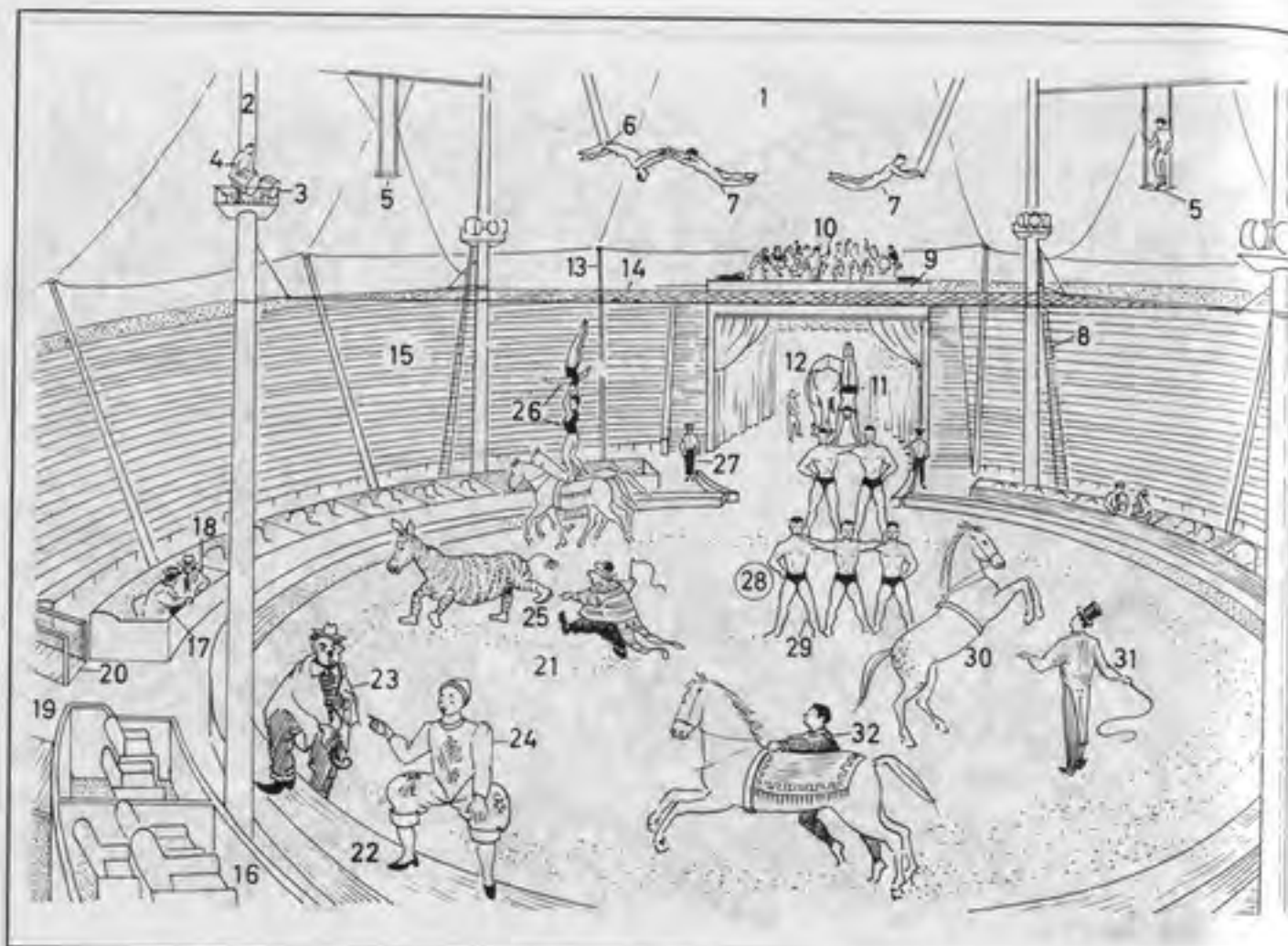

- 1-63 travelling (*Am.* traveling) circus
- 1 circus tent (big top), a four-pole tent
 - 2 tent pole
 - 3 spotlight
 - 4 lighting technician
 - 5 trapeze platform
 - 6 trapeze
 - 7 trapeze artist
 - 8 rope ladder
 - 9 bandstand
 - 10 circus band
 - 11 ring entrance (arena entrance)
 - 12 wings
 - 13 tent prop (prop)
 - 14 safety net
 - 15 seats for the spectators
 - 16 circus box
 - 17 circus manager
 - 18 agent
 - 19 entrance and exit
 - 20 steps
 - 21 ring (arena)
 - 22 ring fence

- 23 musical clown (clown)
- 24 clown
- 25 comic turn (clown act), a circus act
- 26 circus riders (bareback riders)
- 27 ring attendant, a circus attendant
- 28 pyramid
- 29 support
- 30-31 performance by liberty horses
- 30 circus horse, performing the levade (*pesade*)
- 31 ringmaster
- 32 vaulter
- 33 emergency exit
- 34 caravan (circus caravan, *Am.* trailer)
- 35 springboard acrobat (springboard artist)
- 36 springboard
- 37 knife thrower
- 38 circus marksman
- 39 assistant
- 40 tightrope dancer
- 41 tightrope

- 42 balancing pole
- 43 throwing act
- 44 balancing act
- 45 support
- 46 pole (bamboo pole)
- 47 acrobat
- 48 equilibrist (balancer)
- 49 wild animal cage, a round cage
- 50 bars of the cage
- 51 passage (barred passage, passage for the wild animals)
- 52 tamer (wild animal tamer)
- 53 whip
- 54 fork
- 55 pedestal
- 56 wild animal (tiger, lion)
- 57 stand
- 58 hoop (jumping hoop)
- 59 seesaw
- 60 ball
- 61 camp
- 62 cage caravan
- 63 menagerie



1-69 fair (annual fair)

- 1 fairground
- 2 children's merry-go-round, (whirligig), a roundabout (*Am.* carousel)
- 3 refreshment stall (drinks stall)
- 4 chairoplane
- 5 up-and-down roundabout
- 6 show booth (booth)
- 7 box (box office)
- 8 barker
- 9 medium
- 10 showman
- 11 try-your-strength machine
- 12 hawk
- 13 hot dog stand
- 14 paper serpent
- 15 pickpocket (thief)
- 16 vendor
- 17 Turkish delight
- 18 freak show
- 19 giant
- 20 fat lady
- 21 dwarfs (midgets)
- 22 beer marquee
- 23 sideshow
- 24 travelling (*Am.* traveling) artistes (travelling show people)
- 25 fire eater
- 26 sword swallower
- 27 strong man
- 28 escapologist
- 29 spectators
- 30 ice-cream vendor (ice-cream man)
- 31 ice-cream cornet
- 32 hot-dog stand
- 33 grill (*Am.* broiler)
- 34 hot dog
- 35 sausage tongs
- 36 fortune teller
- 37 big wheel (Ferris wheel)
- 38 orchestrion (automatic organ)



- 45 wheel of fortune
- 46 devil's wheel (typhoon wheel)
- 47 throwing ring (quoit)
- 48 prizes
- 49 sandwich man on stilts
- 50 sandwich board (placard)
- 51 cigarette seller, an itinerant trader (a hawker)
- 52 tray
- 53 fruit stall
- 54 wall-of-death rider
- 55 hall of mirrors
- 56 concave mirror
- 57 convex mirror
- 58 shooting gallery
- 59 hippodrome
- 60 junk stalls (second-hand stalls)
- 61 first aid tent (first aid post)
- 62 dodgems (bumper cars)
- 63 dodgem car (bumper car)

- 64-66 pottery stand
- 64 barker
- 65 market woman
- 66 pottery
- 67 visitors to the fair
- 68 waxworks
- 69 wax figure

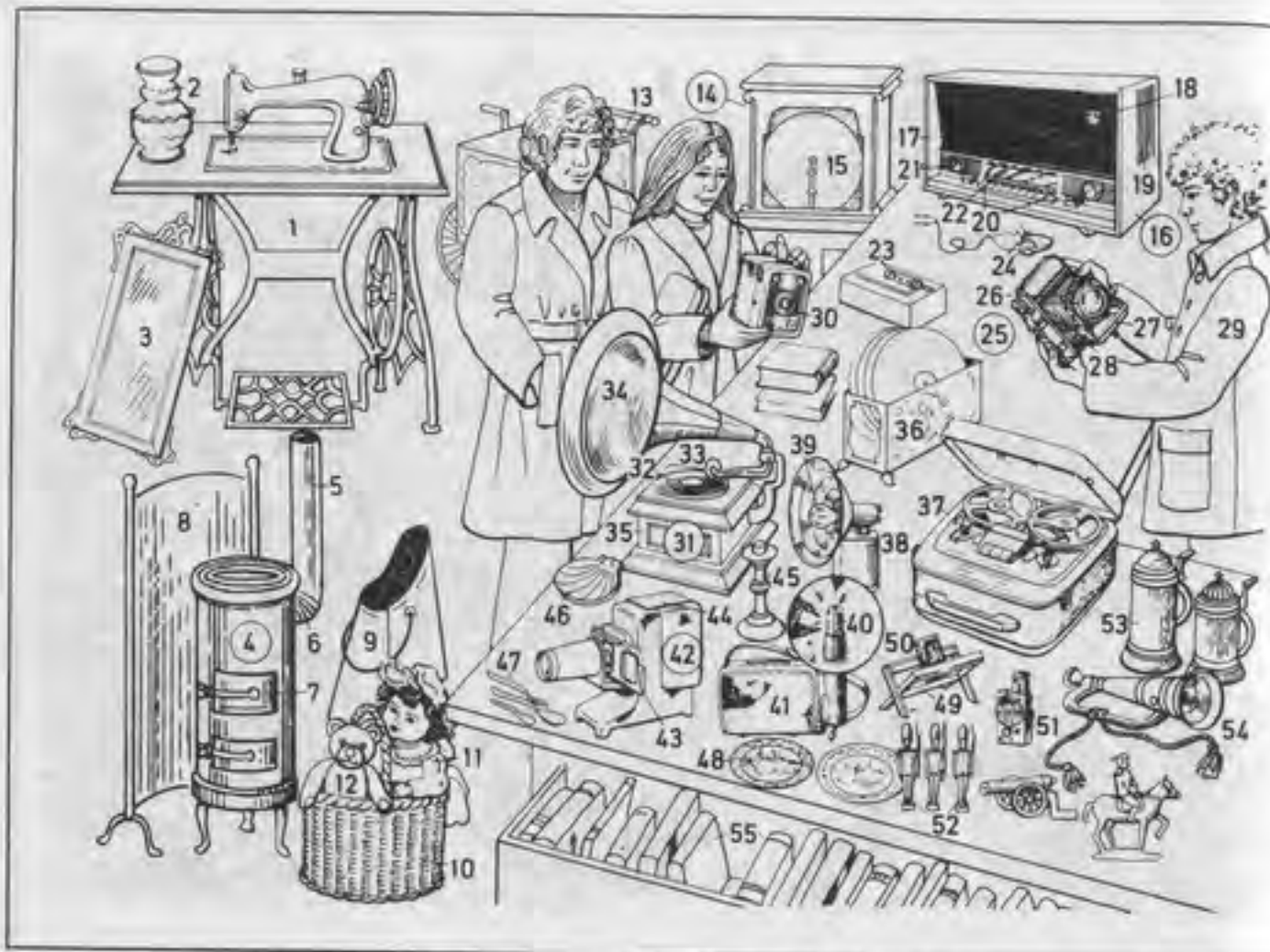

- 1 treadle sewing machine
- 2 flower vase
- 3 wall mirror
- 4 cylindrical stove
- 5 stovepipe
- 6 stovepipe elbow
- 7 stove door
- 8 stove screen
- 9 coal scuttle
- 10 firewood basket
- 11 doll
- 12 teddy bear
- 13 barrel organ
- 14 orchestrion
- 15 metal disc (disk)
- 16 radio (radio set, *loc.*: 'steam radio'), a superheterodyne (superhet)
- 17 baffle board
- 18 'magic eye', a tuning indicator valve
- 19 loudspeaker aperture
- 20 station selector buttons (station preset buttons)
- 21 tuning knob

- 22 frequency bands
- 23 crystal detector (crystal set)
- 24 headphones (headset)
- 25 folding camera
- 26 bellows
- 27 hinged cover
- 28 spring extension
- 29 salesman
- 30 box camera
- 31 gramophone
- 32 record (gramophone record)
- 33 needle head with gramophone needle
- 34 horn
- 35 gramophone box
- 36 record rack
- 37 portable tape recorder
- 38 flashgun
- 39 flash bulb
- 40-41 electronic flash (electronic flashgun)
- 40 flash head
- 41 accumulator
- 42 slide projector
- 43 slide holder



- 44 lamphouse
- 45 candlestick
- 46 scallop shell
- 47 cutlery
- 48 souvenir plate
- 49 drying rack for photographic plates
- 50 photographic plate
- 51 delayed-action release
- 52 tin soldiers (*sim.*: lead soldiers)
- 53 beer mug (stein)
- 54 bugle
- 55 second-hand books
- 56 grandfather clock
- 57 clock case
- 58 pendulum
- 59 time weight
- 60 striking weight
- 61 rocking chair
- 62 sailor suit
- 63 sailor's hat
- 64 washing set
- 65 washing basin
- 66 water jug
- 67 washstand

- 68 dolly
- 69 washtub
- 70 washboard
- 71 humming top
- 72 slate
- 73 pencil box
- 74 adding machine
- 75 paper roll
- 76 number keys
- 77 abacus
- 78 inkwell, with lid
- 79 typewriter
- 80 [hand-operated] calculating machine (calculator)
- 81 operating handle
- 82 result register (product register)
- 83 rotary counting mechanism (rotary counter)
- 84 kitchen scales
- 85 waist slip (underskirt)
- 86 wooden handcart
- 87 wall clock
- 88 bed warmer
- 89 milk churn

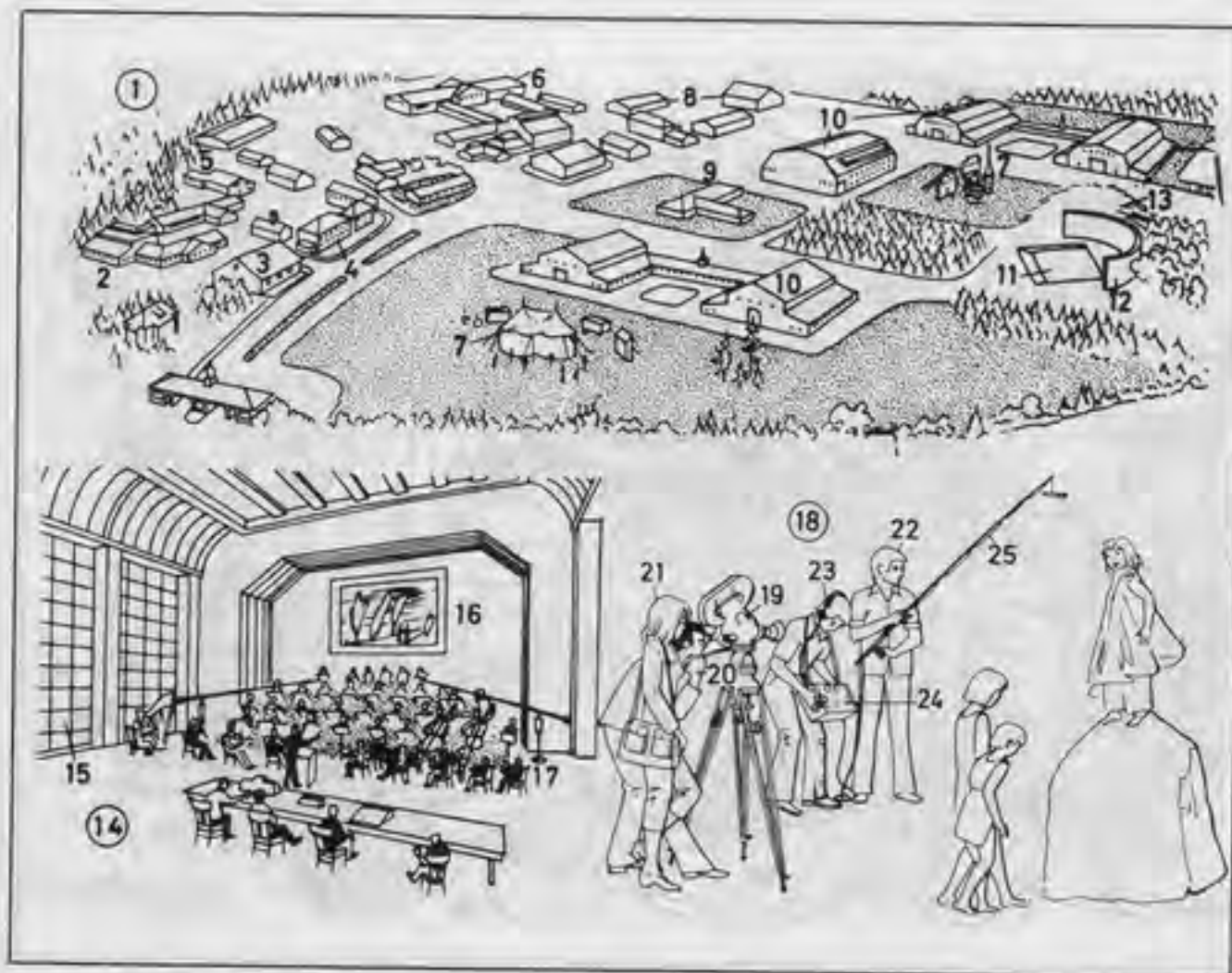

- 1-13 film studios** (studio complex, *Am.* movie studios)
- 1 lot (studio lot)
 - 2 processing laboratories (film laboratories, motion picture laboratories)
 - 3 cutting rooms
 - 4 administration building (office building, offices)
 - 5 film (motion picture) storage vault (film library, motion picture library)
 - 6 workshop
 - 7 film set (*Am.* movie set)
 - 8 power house
 - 9 technical and research laboratories
 - 10 groups of stages
 - 11 concrete tank for marine sequences
 - 12 cyclorama
 - 13 hill
 - 14-60 shooting** (filming)
 - 14 music recording studio (music recording theatre, *Am.* theater)
 - 15 'acoustic' wall lining

- 16 screen (projection screen)
- 17 film orchestra
- 18 exterior shooting (outdoor shooting, exterior filming, outdoor filming)
- 19 camera with crystal-controlled drive
- 20 cameraman
- 21 assistant director
- 22 boom operator (boom swinger)
- 23 recording engineer (sound recordist)
- 24 portable sound recorder with crystal-controlled drive
- 25 microphone boom
- 26-60 shooting** (filming) in the studio (on the sound stage, on the stage, in the filming hall)
- 26 production manager
- 27 leading lady (film actress, film star, star)
- 28 leading man (film actor, film star, star)
- 29 film extra (extra)
- 30 arrangement of microphones for stereo and sound effects

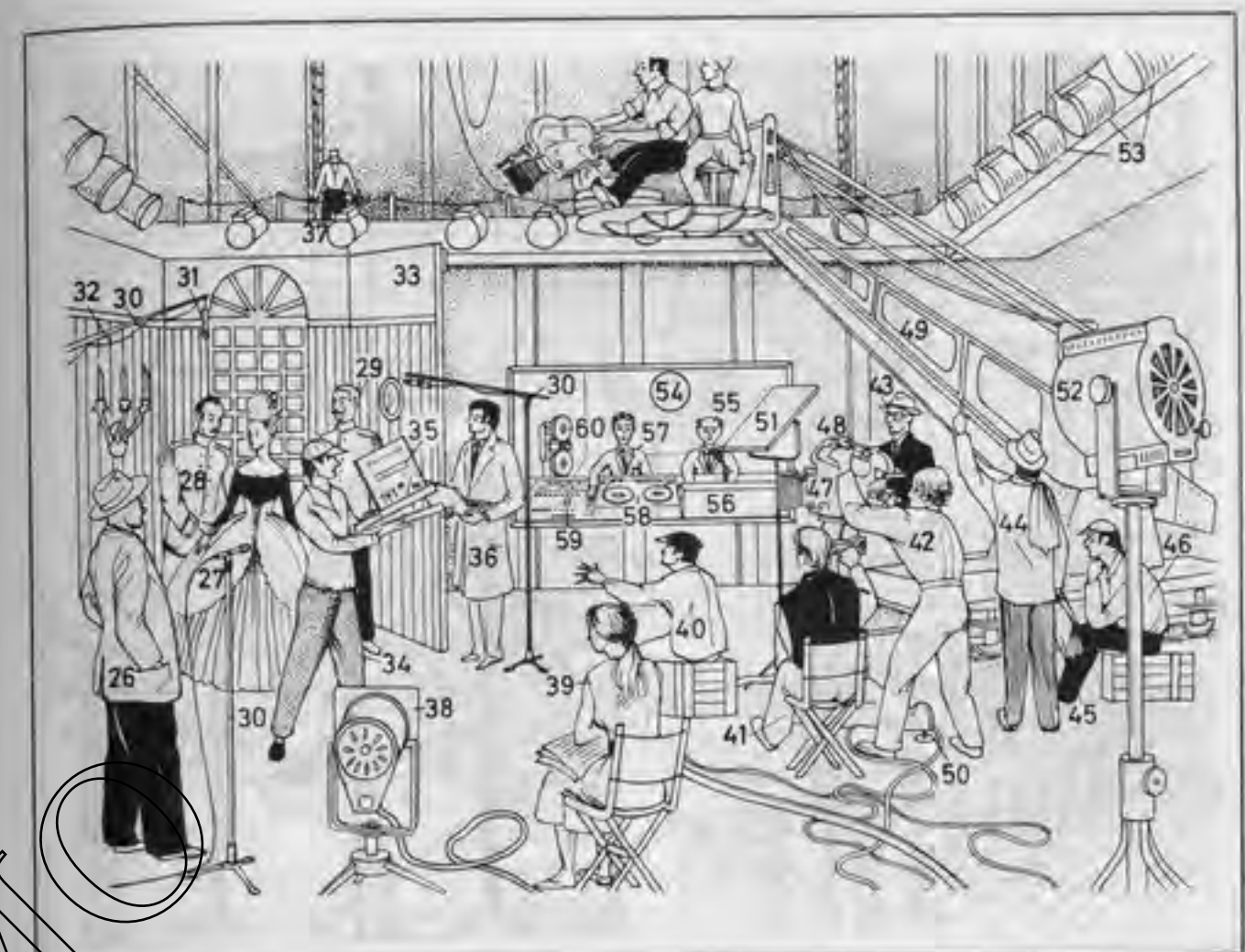

- 31 studio microphone
- 32 microphone cable
- 33 side flats and background
- 34 clapper boy
- 35 clapper board (clapper) with slates (boards) for the film title, shot number (scene number), and take number
- 36 make-up artist (hairstylist)
- 37 lighting electrician (studio electrician, lighting man, *Am.* gaffer)
- 38 diffusing screen
- 39 continuity girl (script girl)
- 40 film director (director)
- 41 cameraman (first cameraman)
- 42 camera operator, an assistant cameraman (camera assistant)
- 43 set designer (art director)
- 44 director of photography
- 45 filmscript (script, shooting script, *Am.* movie script)
- 46 assistant director
- 47 soundproof film camera (soundproof motion picture camera), a wide screen camera (cinemascope camera)

- 48 soundproof housing (soundproof cover, blimp)
- 49 camera crane (dolly)
- 50 hydraulic stand
- 51 mask (screen) for protection from spill light (gobo, nigger)
- 52 tripod spotlight (fill-in light, filler light, fill light, filler)
- 53 spotlight catwalk
- 54 recording room
- 55 recording engineer (sound recordist)
- 56 mixing console (mixing desk)
- 57 sound assistant (assistant sound engineer)
- 58 magnetic sound recording equipment (magnetic sound recorder)
- 59 amplifier and special effects equipment, e.g. for echo and sound effects
- 60 sound recording camera (optical sound recorder)

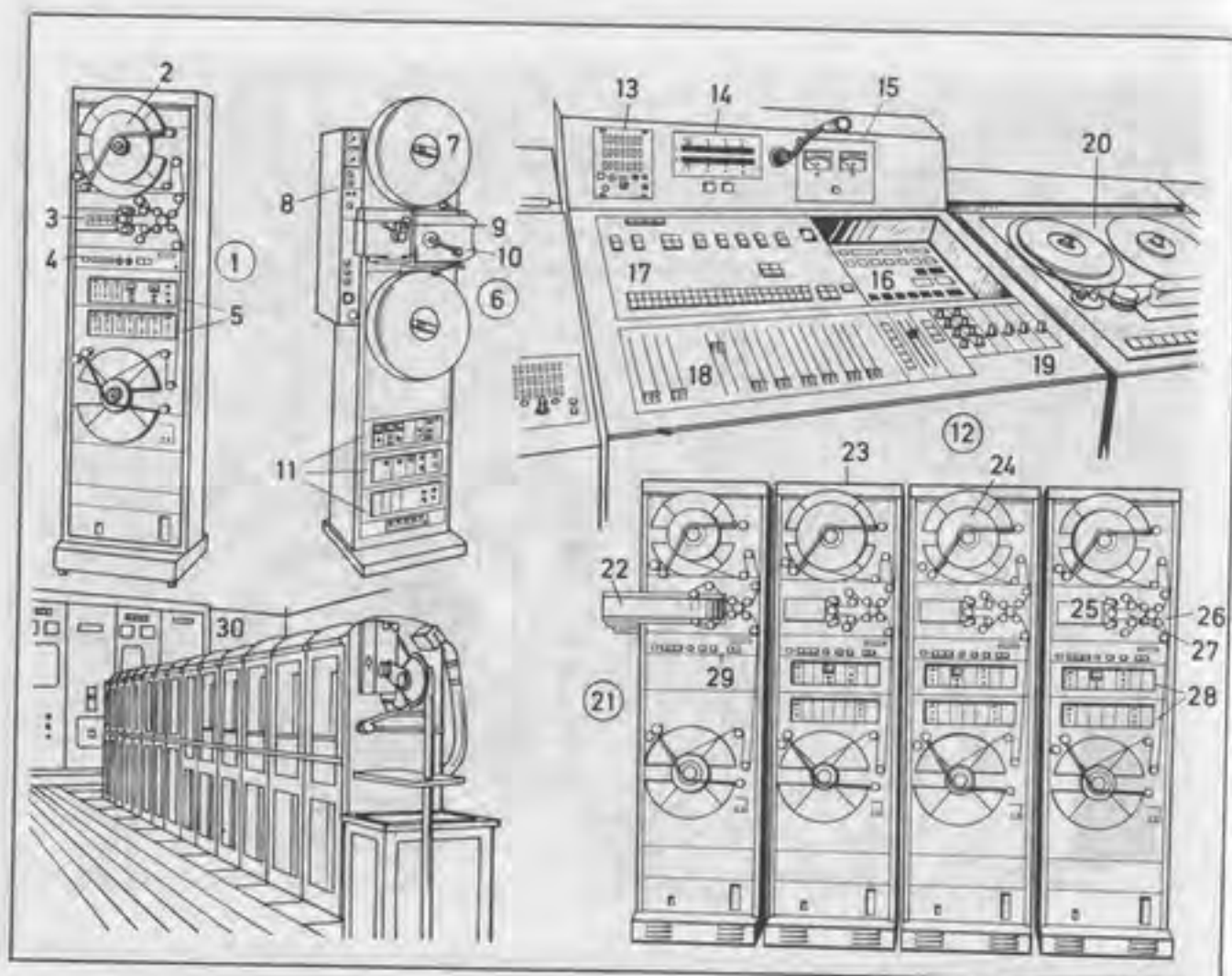

- 1-46 sound recording and re-recording (dubbing)**
- 1 magnetic sound recording equipment (magnetic sound recorder)
 - 2 magnetic film spool
 - 3 magnetic head support assembly
 - 4 control panel
 - 5 magnetic sound recording and playback amplifier
 - 6 optical sound recorder (sound recording camera, optical sound recording equipment)
 - 7 daylight film magazine
 - 8 control and monitoring panel
 - 9 eyepiece for visual control of optical sound recording
 - 10 deck
 - 11 recording amplifier and mains power unit
 - 12 control desk (control console)
 - 13 monitoring loudspeaker (control loudspeaker)
 - 14 recording level indicators
 - 15 monitoring instruments

- 16 jack panel
- 17 control panel
- 18 sliding control
- 19 equalizer
- 20 magnetic sound deck
- 21 mixer for magnetic film
- 22 film projector
- 23 recording and playback equipment
- 24 film reel (film spool)
- 25 head support assembly for the recording head, playback head, and erasing head (erase head)
- 26 film transport mechanism
- 27 synchronizing filter
- 28 magnetic sound amplifier
- 29 control panel
- 30 film-processing machines (film-developing machines) in the processing laboratory (film laboratory, motion picture laboratory)
- 31 echo chamber
- 32 echo chamber loudspeaker
- 33 echo chamber microphone

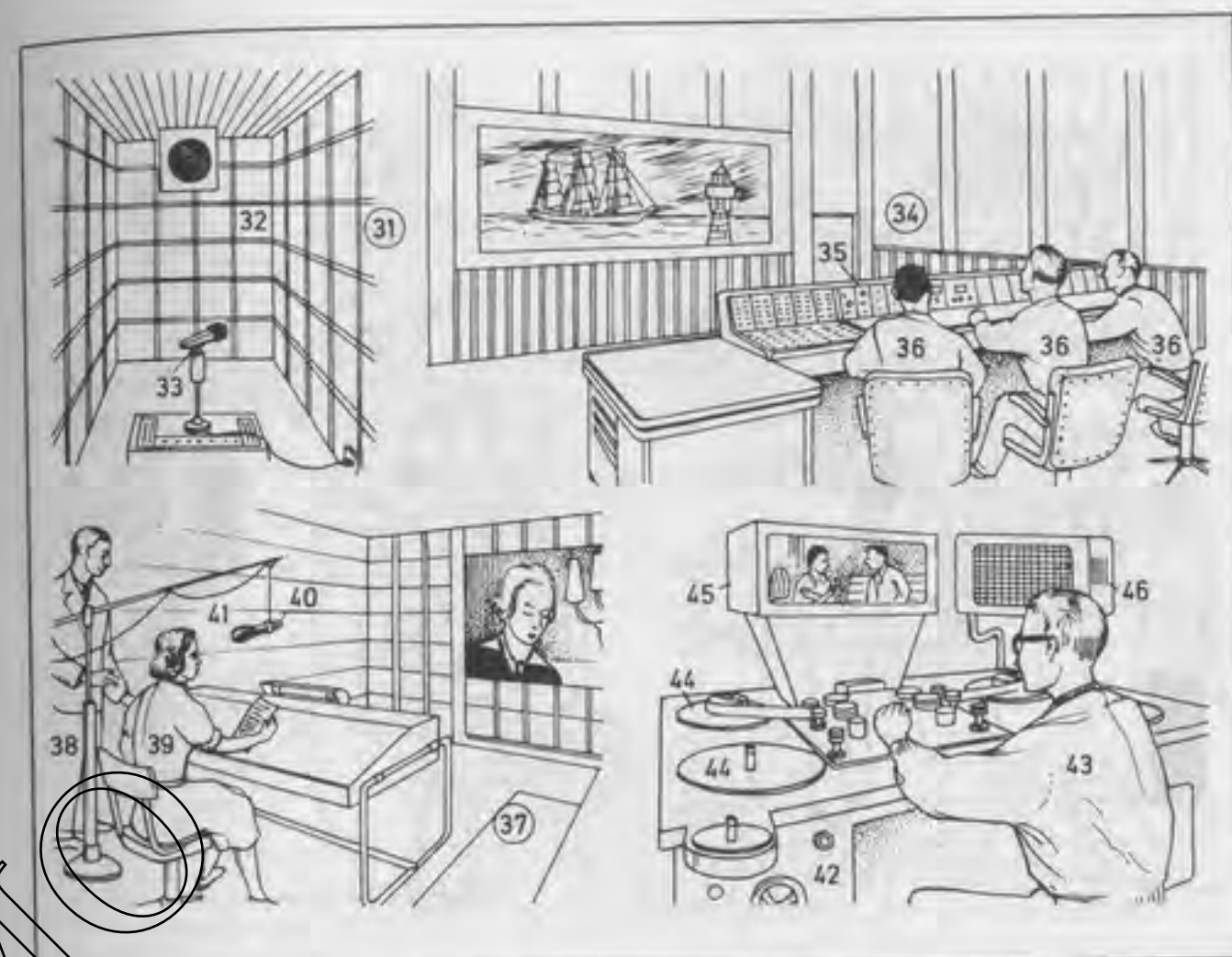

- 34-36 sound mixing (sound dubbing, mixing of several sound tracks)
- 34 mixing room (dubbing room)
- 35 mixing console (mixing desk) for mono or stereo sound
- 36 dubbing mixers (recording engineers, sound recordists) dubbing (mixing)
- 37-41 synchronization (syncing, dubbing, post-synchronization, post-syncing)
- 37 dubbing studio (dubbing theatre, Am. theater)
- 38 dubbing director
- 39 dubbing speaker (dubbing actress)
- 40 boom microphone
- 41 microphone cable

- 42-46 cutting (editing)
- 42 cutting table (editing table, cutting bench)
- 43 film editor (cutter)
- 44 film turntable, for picture and sound tracks
- 45 projection of the picture
- 46 loudspeaker

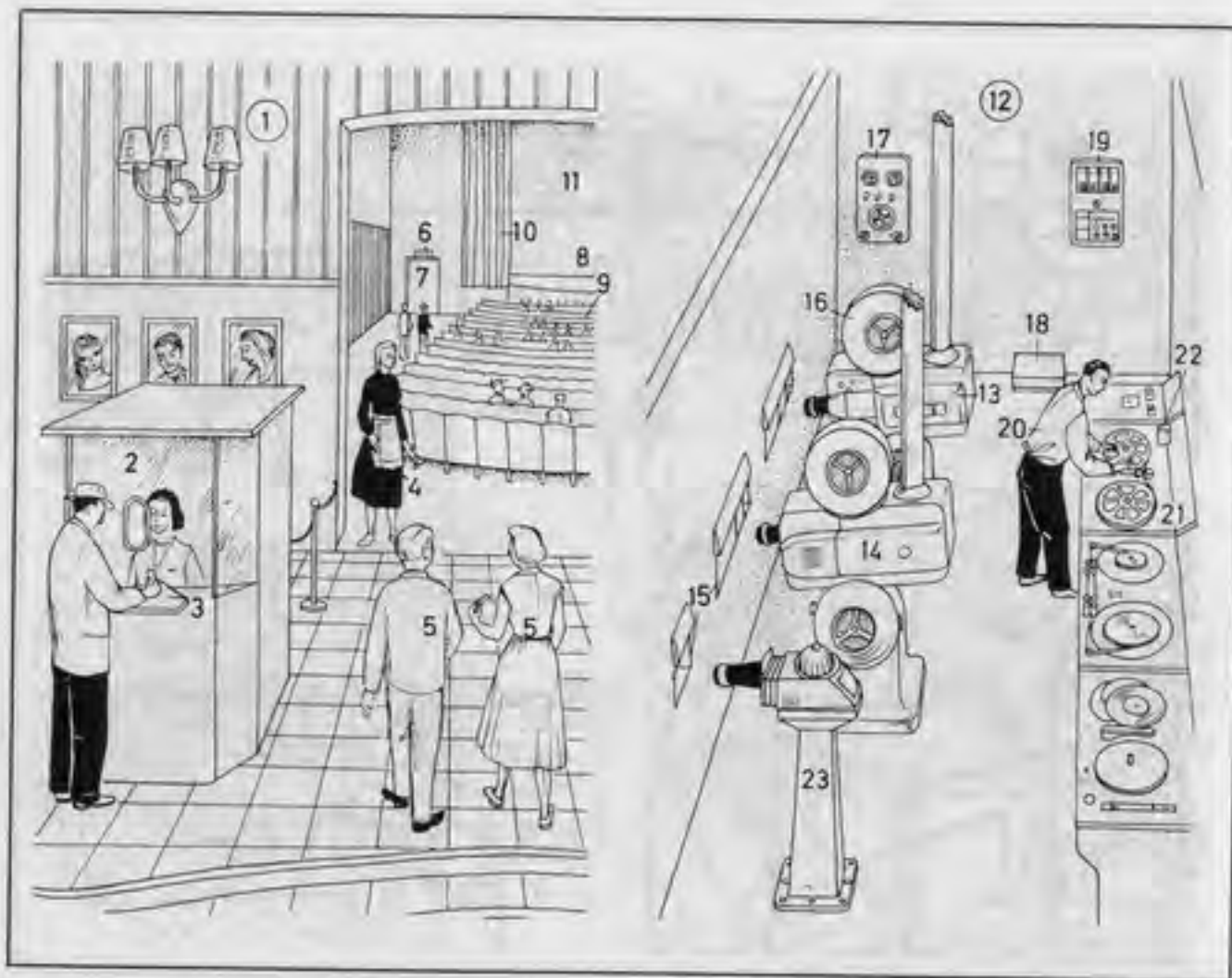

- 1-23 film projection (motion picture projection)**
- 1 cinema (picture house, *Am.* movie theater, movie house)
 - 2 cinema box office (*Am.* movie theater box office)
 - 3 cinema ticket (*Am.* movie theater ticket)
 - 4 usherette
 - 5 cinemagoers (filmgoers, cinema audience, *Am.* moviegoers, movie audience)
 - 6 safety lighting (emergency lighting)
 - 7 emergency exit
 - 8 stage
 - 9 rows of seats (rows)
 - 10 stage curtain (screen curtain)
 - 11 screen (projection screen)
 - 12 projection room (projection booth)
 - 13 lefthand projector
 - 14 righthand projector
 - 15 projection room window with projection window and observation port

- 16 reel drum (spool box)
- 17 house light dimmers (auditorium lighting control)
- 18 rectifier, a selenium or mercury vapour rectifier for the projection lamps
- 19 amplifier
- 20 projectionist
- 21 rewind bench for rewinding the film
- 22 film cement (splicing cement)
- 23 slide projector for advertisements
- 24-52 film projectors**
- 24 sound projector (film projector, cinema projector, theatre projector, *Am.* movie projector)
- 25-38 projector mechanism**
- 25 fireproof reel drums (spool boxes) with circulating oil cooling system
- 26 feed sprocket (supply sprocket)
- 27 take-up sprocket
- 28 magnetic head cluster
- 29 guide roller (guiding roller) with framing control

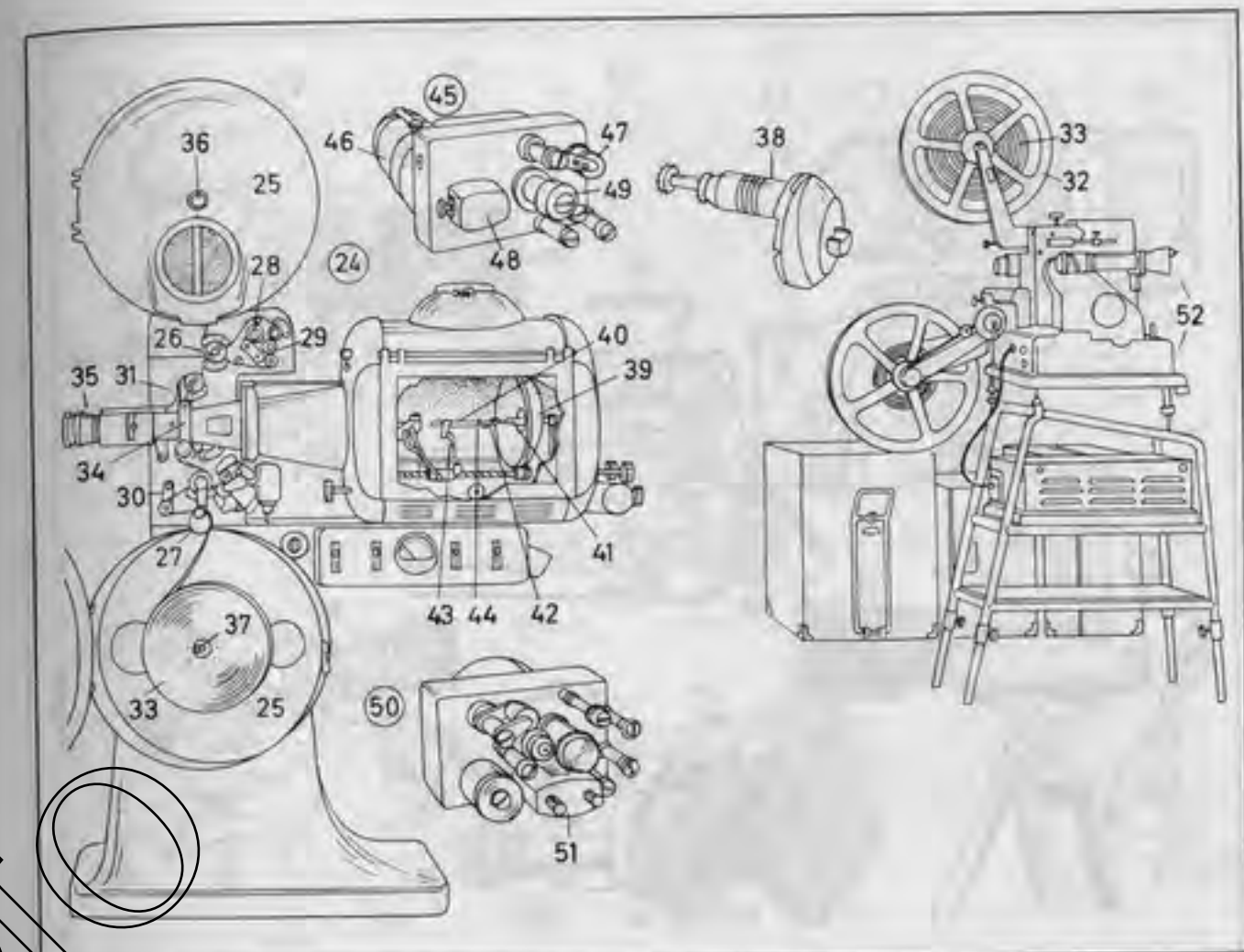

- 30 loop former for smoothing out the intermittent movement; *also*: film break detector
- 31 film path
- 32 film reel (film spool)
- 33 reel of film
- 34 film gate (picture gate, projector gate) with cooling fan
- 35 projection lens (projector lens)
- 36 feed spindle
- 37 take-up spindle with friction drive
- 38 maltese cross mechanism (maltese cross movement, Geneva movement)
- 39-44 lamphouse
- 39 mirror arc lamp, with aspherical (non-spherical) concave mirror and blowout magnet for stabilizing the arc (*also*: high-pressure xenon arc lamp)
- 40 positive carbon (positive carbon rod)
- 41 negative carbon (negative carbon rod)
- 42 arc
- 43 carbon rod holder
- 44 crater (carbon crater)
- 45 optical sound unit [also designed for multi-channel optical stereophonic sound and for push-pull sound tracks]
- 46 sound optics
- 47 sound head
- 48 exciter lamp in housing
- 49 photocell in hollow drum
- 50 attachable four-track magnetic sound unit (penthouse head, magnetic sound head)
- 51 four-track magnetic head
- 52 narrow-gauge (*Am.* narrow-gauge) cinema projector for mobile cinema

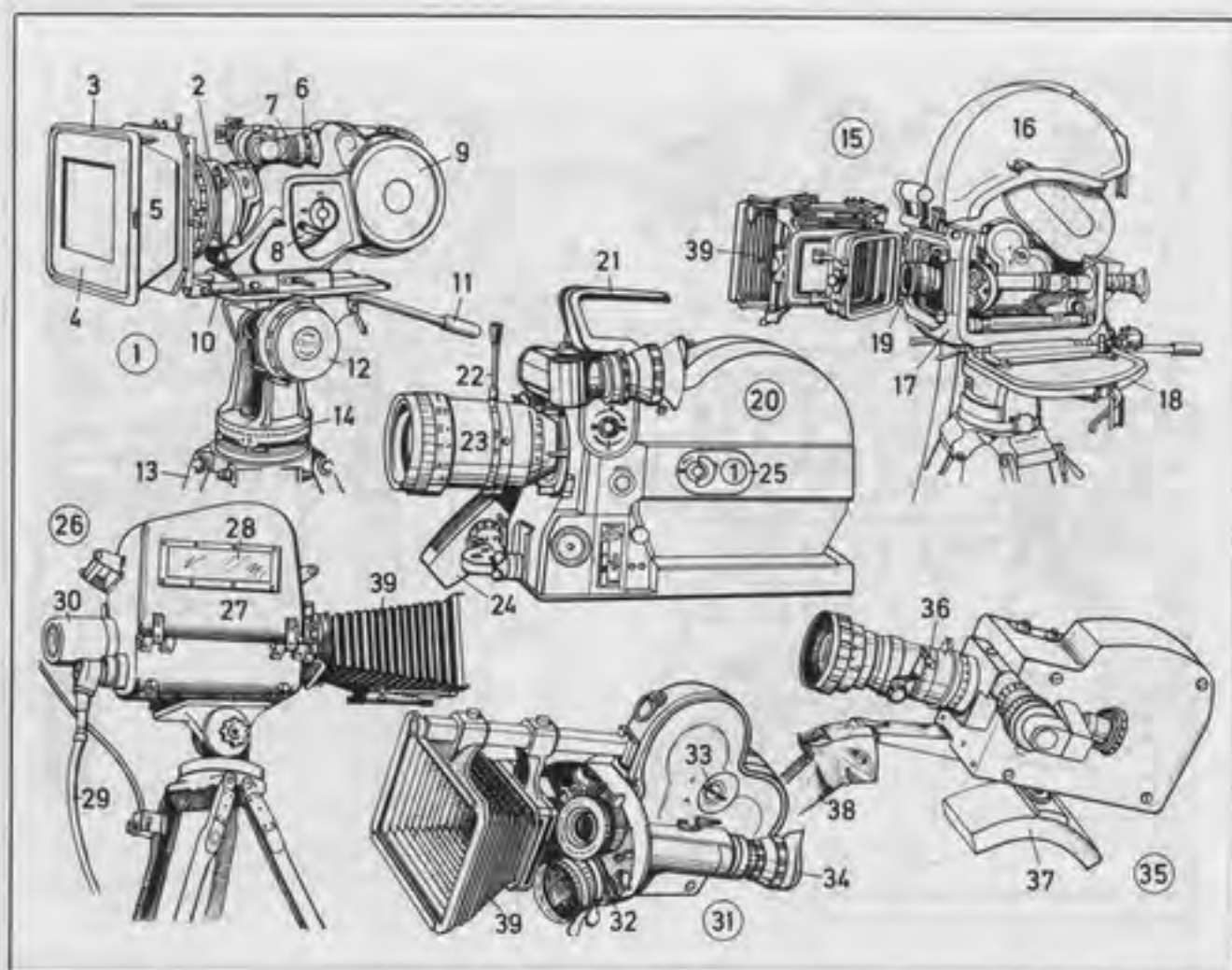

1-39 motion picture cameras (film cameras)

- 1 standard-gauge (*Am.* standard-gauge) motion picture camera (standard-gauge, *Am.* standard-gauge, 35 mm camera)
- 2 lens (object lens, taking lens)
- 3 lens hood (sunshade) with matte box
- 4 matte (mask)
- 5 lens hood barrel
- 6 viewfinder eyepiece
- 7 eyepiece control ring
- 8 opening control for the segment disc (disk) shutter
- 9 magazine housing
- 10 slide bar for the lens hood
- 11 control arm (control lever)
- 12 pan and tilt head
- 13 wooden tripod
- 14 degree scale
- 15 soundproof (blimped) motion picture camera (film camera)
- 16-18 soundproof housing (blimp)
- 16 upper section of the soundproof housing
- 17 lower section of the soundproof housing
- 18 open sidewall of the soundproof housing
- 19 camera lens
- 20 lightweight professional motion picture camera
- 21 grip (handgrip)
- 22 zooming lever
- 23 zoom lens (variable focus lens, varifocal lens) with infinitely variable focus
- 24 handgrip with shutter release
- 25 camera door
- 26 sound camera (newsreel camera) for recording sound and picture
- 27 soundproof housing (blimp)
- 28 window for the frame counters and indicator scales
- 29 pilot tone cable (sync pulse cable)
- 30 pilot tone generator (signal generator, pulse generator)
- 31 professional narrow-gauge (*Am.* narrow-gauge) motion picture camera, a 16 mm camera
- 32 lens turret (turret head)
- 33 housing lock
- 34 eyecup
- 35 high-speed camera, a special narrow-gauge (*Am.* narrow-gauge) camera
- 36 zooming lever
- 37 rifle grip
- 38 handgrip with shutter release
- 39 lens hood bellows

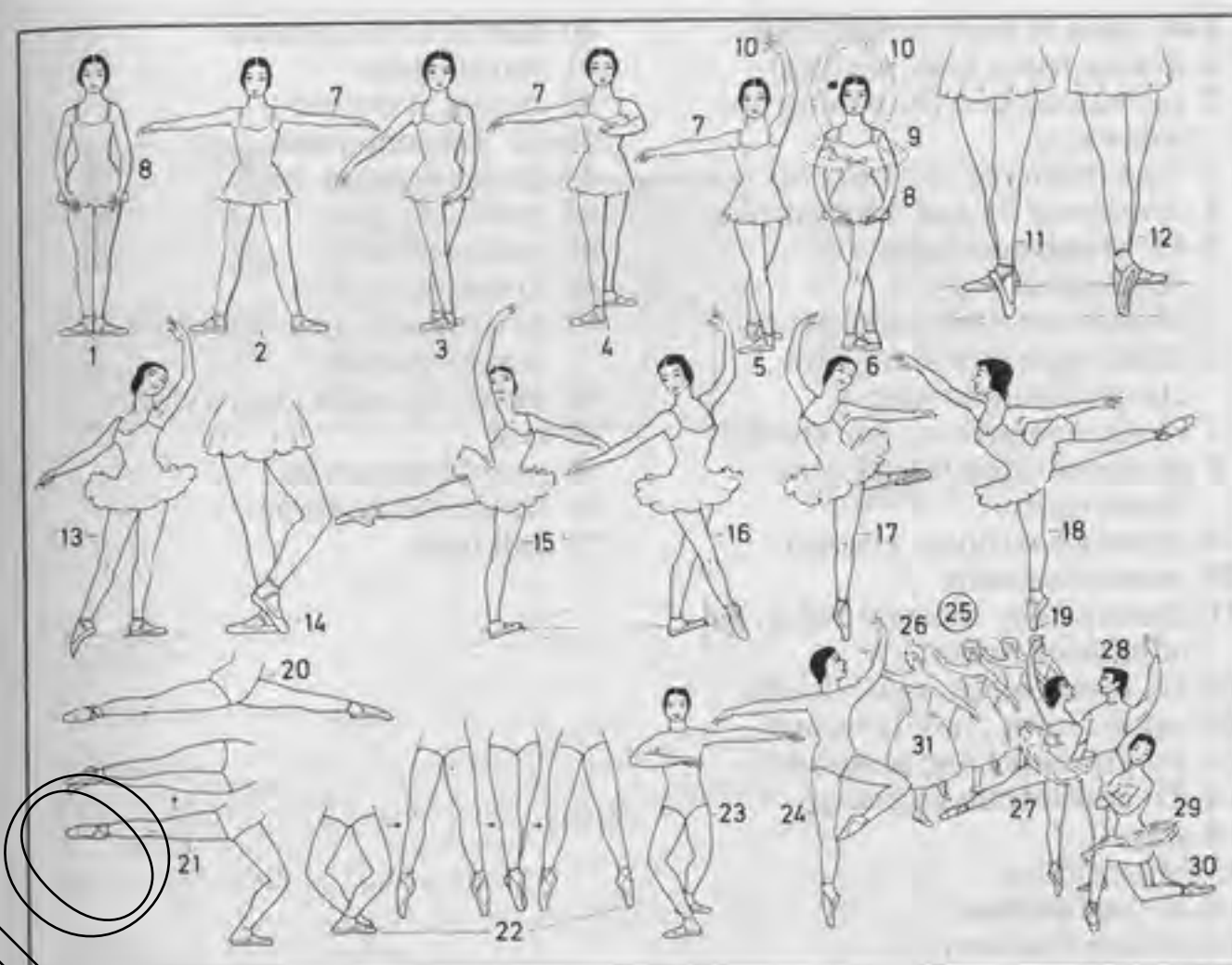

1-6 the five positions (ballet positions)

- 1 first position
- 2 second position
- 3 third position
- 4 fourth position [open]
- 5 fourth position [crossed; extended fifth position]
- 6 fifth position
- 7-10 ports de bras (arm positions)
- 7 port de bras à coté
- 8 port de bras en bas
- 9 port de bras en avant
- 10 port de bras en haut
- 11 dégagé à la quatrième devant
- 12 dégagé à la quatrième derrière
- 13 effacé
- 14 sur le cou-de-pied
- 15 écarté
- 16 croisé
- 17 attitude
- 18 arabesque
- 19 à pointe (on full point)
- 20 splits
- 21 cabriole (capriole)
- 22 entrechat (entrechat quatre)
- 23 préparation [e.g. for a pirouette]
- 24 pirouette
- 25 corps de ballet
- 26 ballet dancer (ballerina)
- 27-28 pas de trois
- 27 prima ballerina
- 28 principal male dancer (leading soloist)
- 29 tutu
- 30 point shoe, a ballet shoe (ballet slipper)
- 31 ballet skirt

- 1-4 types of curtain operation
 1 draw curtain (side parting)
 2 tableau curtain (bunching up sideways)
 3 fly curtain (vertical ascent)
 4 combined fly and draw curtain
 5-11 cloakroom hall (Am. checkroom hall)
 5 cloakroom (Am. checkroom)
 6 cloakroom attendant (Am. checkroom attendant)
 7 cloakroom ticket (Am. check)
 8 playgoer (theatregoer, Am. theatergoer)
 9 opera glass (opera glasses)
 10 commissionaire
 11 theatre (Am. theater) ticket, an admission ticket
 12-13 foyer (lobby, crush room)
 12 usher; *form.*: box attendant
 13 programme (Am. program)
 14-27 auditorium and stage
 14 stage
 15 proscenium
 16-20 auditorium
 16 gallery (balcony)
 17 upper circle
 18 dress circle (Am. balcony, mezzanine)
 19 front stalls
 20 seat (theatre seat, Am. theater seat)
 21-27 rehearsal (stage rehearsal)
 21 chorus
 22 singer
 23 singer
 24 orchestra pit
 25 orchestra
 26 conductor
 27 baton (conductor's baton)
 28-42 paint room, a workshop
 28 stagehand (scene shifter)
 29 catwalk (bridge)
 30 set piece
 31 reinforcing struts
 32 built piece (built unit)
 33 backcloth (backdrop)
 34 portable box for paint containers
 35 scene painter
 36 paint trolley
 37 stage designer (set designer)
 38 costume designer
 39 design for a costume

- 40 sketch for a costume
 41 model stage
 42 model of the set
 43-52 dressing room
 43 dressing room mirror
 44 make-up gown
 45 make-up table
 46 greasepaint stick
 47 chief make-up artist (chief make-up man)
 48 make-up artist (hairstylist)
 49 wig
 50 props (properties)
 51 theatrical costume
 52 call light

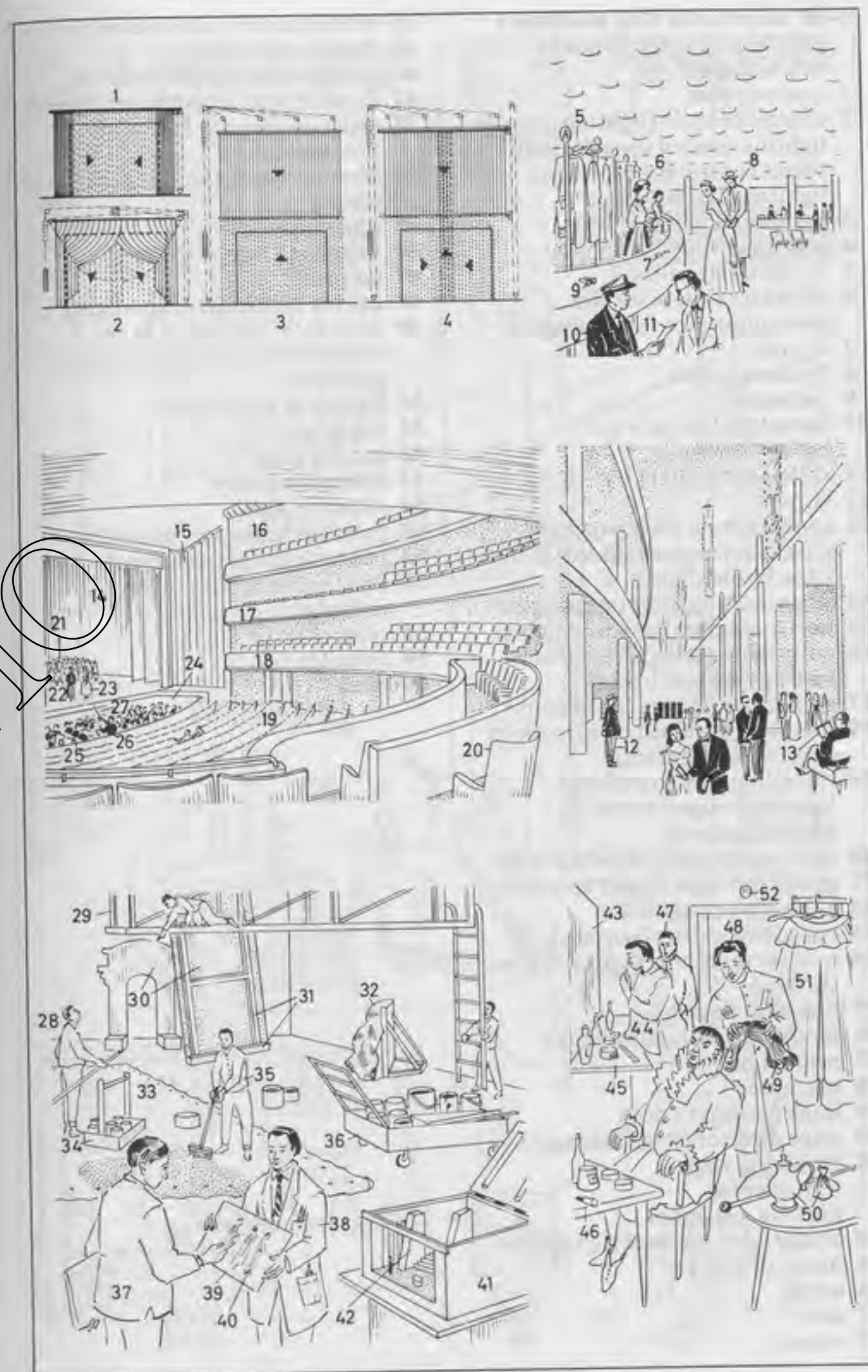

- 1-60 stagehouse with machinery
(machinery in the flies and below stage)
- 1 control room
 - 2 control console (lighting console, lighting control console) with preset control for presetting lighting effects
 - 3 lighting plot (light plot)
 - 4 grid (gridiron)
 - 5 fly floor (fly gallery)
 - 6 sprinkler system for fire prevention (for fire protection)
 - 7 fly man
 - 8 fly lines (lines)
 - 9 cyclorama
 - 10 backcloth (backdrop, background)
 - 11 arch, a drop cloth
 - 12 border
 - 13 compartment (compartment-type, compartmentalized) batten (Am. border light)
 - 14 stage lighting units (stage lights)
 - 15 horizon lights (backdrop lights)
 - 16 adjustable acting area lights (acting area spotlights)
 - 17 scenery projectors (projectors)
 - 18 monitor (water cannon) (a piece of safety equipment)
 - 19 travelling (Am. traveling) lighting bridge (travelling lighting gallery)
 - 20 lighting operator (lighting man)
 - 21 portal spotlight (tower spotlight)
 - 22 adjustable proscenium
 - 23 curtain (theatrical curtain)
 - 24 iron curtain (safety curtain, fire curtain)
 - 25 forestage (apron)
 - 26 footlight (footlights, floats)
 - 27 prompt box
 - 28 prompter
 - 29 stage manager's desk
 - 30 stage director (stage manager)
 - 31 revolving stage
 - 32 trap opening
 - 33 lift (Am. elevator)
 - 34 bridge (Am. elevator), a rostrum
 - 35 pieces of scenery
 - 36 scene
 - 37 actor
 - 38 actress

- 39 extras (supers, supernumeraries)
- 40 director (producer)
- 41 prompt book (prompt script)
- 42 director's table (producer's table)
- 43 assistant director (assistant producer)
- 44 director's script (producer's script)
- 45 stage carpenter
- 46 stagehand (scene shifter)
- 47 set piece
- 48 mirror spot (mirror spotlight)
- 49 automatic filter change (with colour filters, colour mediums, gelatines)
- 50 hydraulic plant room
- 51 water tank
- 52 suction pipe
- 53 hydraulic pump
- 54 pressure pipe
- 55 pressure tank (accumulator)
- 56 pressure gauge (Am. gage)
- 57 level indicator (liquid level indicator)
- 58 control lever
- 59 operator
- 60 rams

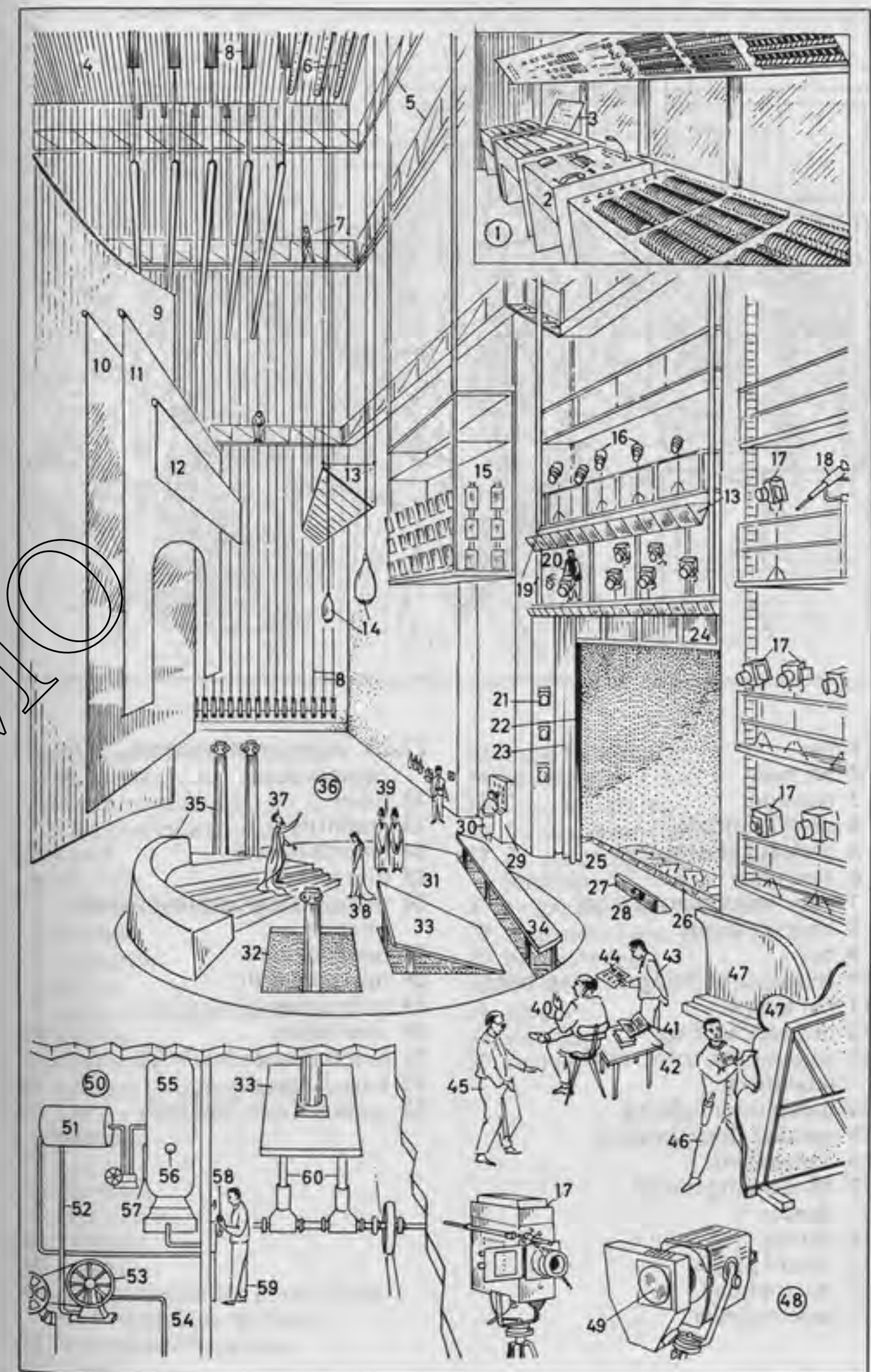

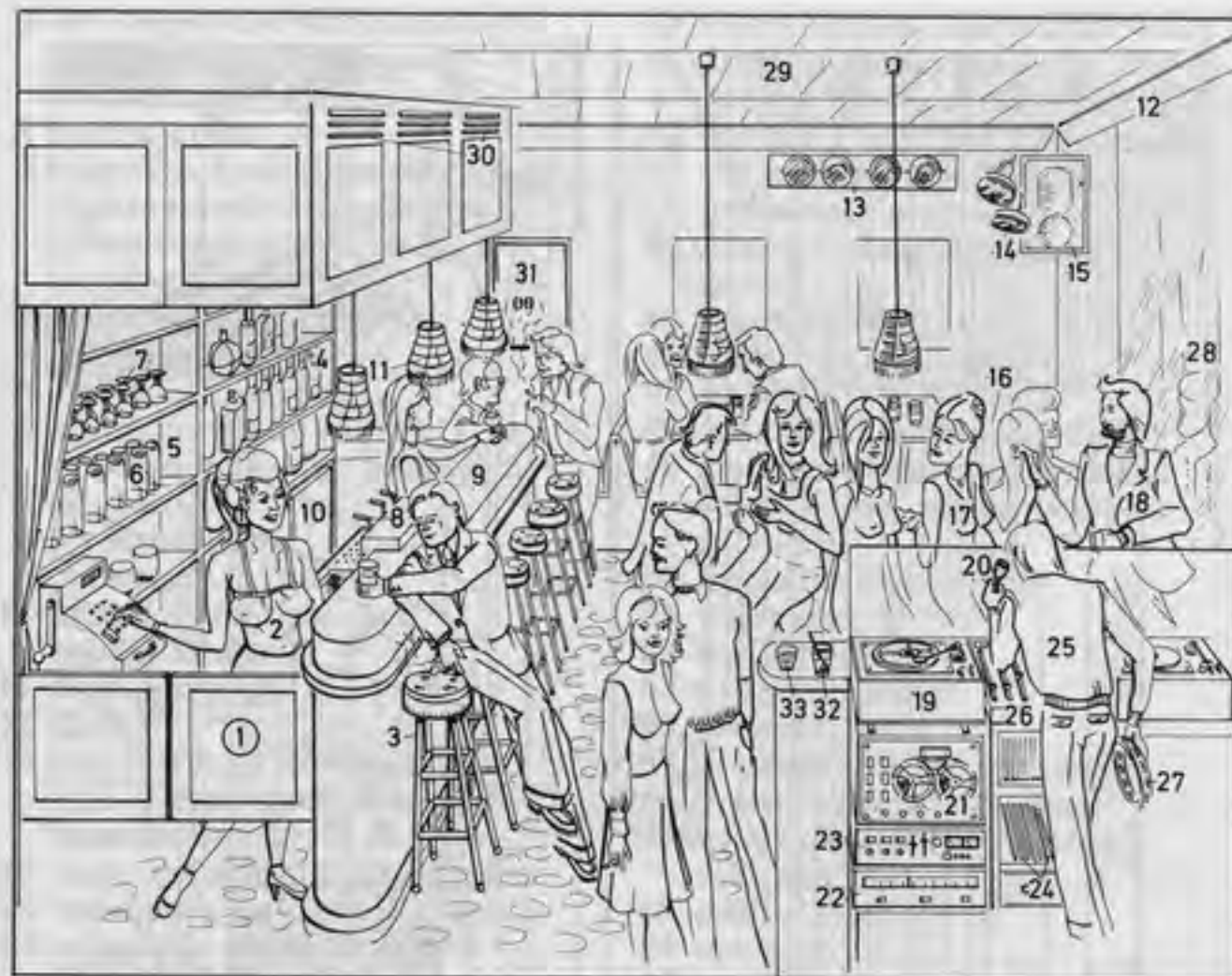

- | | |
|--|--|
| 1 bar | 22-23 stereo system (stereo equipment) |
| 2 barmaid | 22 tuner |
| 3 bar stool | 23 amplifier |
| 4 shelf for bottles | 24 records (discs) |
| 5 shelf for glasses | 25 disc jockey |
| 6 beer glass | 26 mixing console (mixing desk, mixer) |
| 7 wine and liqueur glasses | 27 tambourine |
| 8 beer tap (tap) | 28 mirrored wall |
| 9 bar | 29 ceiling tiles |
| 10 refrigerator (fridge, <i>Am.</i> icebox) | 30 ventilators |
| 11 bar lamps | 31 toilets (lavatories, WC) |
| 12 indirect lighting | 32 long drink |
| 13 colour (<i>Am.</i> color) organ (clavilux) | 33 cocktail (<i>Am.</i> highball) |
| 14 dance floor lighting | |
| 15 speaker (loudspeaker) | |
| 16 dance floor | |
| 17-18 dancing couple | |
| 17 dancer | |
| 18 dancer | |
| 19 record player | |
| 20 microphone | |
| 21 tape recorder | |



- | | |
|--|--|
| 1-33 nightclub (night spot) | 23 stage lighting |
| 1 cloakroom (<i>Am.</i> checkroom) | 24 spotlight |
| 2 cloakroom attendant (<i>Am.</i> checkroom attendant) | 25 festoon lighting |
| 3 band | 26 festoon lamp (lamp, light bulb) |
| 4 clarinet | 27-32 striptease act (striptease number) |
| 5 clarinetist (<i>Am.</i> clarinetist) | 27 striptease artist (stripper) |
| 6 trumpet | 28 suspender (<i>Am.</i> garter) |
| 7 trumpeter | 29 brassière (bra) |
| 8 guitar | 30 fur stole |
| 9 guitarist (guitar player) | 31 gloves |
| 10 drums | 32 stocking |
| 11 drummer | 33 hostess |
| 12 speaker (loudspeaker) | |
| 13 bar | |
| 14 barmaid | |
| 15 bar | |
| 16 bar stool | |
| 17 tape recorder | |
| 18 receiver | |
| 19 spirits | |
| 20 cine projector for porno films (sex films, blue movies) | |
| 21 box containing screen | |
| 22 stage | |

- 1-33 bullfight (corrida, corrida de toros)
- 1 mock bullfight
 - 2 novillero
 - 3 mock bull (dummy bull)
 - 4 novice banderillero (apprentice banderillero)
 - 5 bullring (plaza de toros) [diagram]
 - 6 main entrance
 - 7 boxes
 - 8 stands
 - 9 arena (ring)
 - 10 bullfighters' entrance
 - 11 torril door
 - 12 exit gate for killed bulls
 - 13 slaughterhouse
 - 14 bull pens (corrals)
 - 15 paddock
 - 16 lancer on horseback (picador)
 - 17 lance (pike pole, javelin)
 - 18 armoured (*Am.* armored) horse
 - 19 leg armour (*Am.* armor)
 - 20 picador's round hat
 - 21 banderillero, a torero
 - 22 banderillas (barbed darts)
 - 23 shirtwaist
 - 24 bullfight
 - 25 matador (swordsman), a torero
 - 26 queue, a distinguishing mark of the matador
 - 27 red cloak (capa)
 - 28 fighting bull
 - 29 montera [hat made of tiny black silk chenille balls]
 - 30 killing the bull (kill)
 - 31 matador in charity performances [without professional uniform]
 - 32 estoque (sword)
 - 33 muleta
 - 34 rodeo
 - 35 young bull
 - 36 cowboy
 - 37 stetson (stetson hat)
 - 38 scarf (necktie)
 - 39 rodeo rider
 - 40 lasso



- 1-2 medieval (mediaeval) notes
- 1 plainsong notation (neumes, neums, pneumes, square notation)
- 2 mensural notation
- 3-7 musical note (note)
- 3 note head
- 4 note stem (note tail)
- 5 hook
- 6 stroke
- 7 dot indicating augmentation of note's value
- 8-11 clefs
- 8 treble clef (G-clef, violin clef)
- 9 bass clef (F-clef)
- 10 alto clef (C-clef)
- 11 tenor clef
- 12-19 note values
- 12 breve (brevis, *Am.* double-whole note)
- 13 semibreve (*Am.* whole note)
- 14 minim (*Am.* half note)
- 15 crotchet (*Am.* quarter note)
- 16 quaver (*Am.* eighth note)
- 17 semiquaver (*Am.* sixteenth note)
- 18 demisemiquaver (*Am.* thirty-second note)
- 19 hemidemisemiquaver (*Am.* sixty-fourth note)
- 20-27 rests
- 20 breve rest
- 21 semibreve rest (*Am.* whole rest)
- 22 minim rest (*Am.* half rest)
- 23 crotchet rest (*Am.* quarter rest)
- 24 quaver rest (*Am.* eighth rest)
- 25 semiquaver rest (*Am.* sixteenth rest)
- 26 demisemiquaver rest (*Am.* thirty-second rest)
- 27 hemidemisemiquaver rest (*Am.* sixty-fourth rest)
- 28-42 time (time signatures, measure, *Am.* meter)
- 28 two-eight time
- 29 two-four time
- 30 two-two time
- 31 four-eight time
- 32 four-four time (common time)
- 33 four-two time
- 34 six-eight time
- 35 six-four time
- 36 three-eight time
- 37 three-four time

- 38 three-two time
- 39 nine-eight time
- 40 nine-four time
- 41 five-four time
- 42 bar (bar line, measure line)
- 43-44 staff (stave)
- 43 line of the staff
- 44 space
- 45-49 scales
- 45 C major scale naturals: c, d, e, f, g, a, b, c
- 46 A minor scale [natural] naturals: a, b, c, d, e, f, g, a
- 47 A minor scale [harmonic]
- 48 A minor scale [melodic]
- 49 chromatic scale
- 50-54 accidentals (inflections, key signatures)
- 50-51 signs indicating the raising of a note
- 50 sharp (raising the note a semitone or half-step)
- 51 double sharp (raising the note a tone or full-step)
- 52-53 signs indicating the lowering of a note
- 52 flat (lowering the note a semitone or half-step)
- 53 double flat (lowering the note a tone or full-step)
- 54 natural
- 55-68 keys (major keys and the related minor keys having the same signature)
- 55 C major (A minor)
- 56 G major (E minor)
- 57 D major (B minor)
- 58 A major (F sharp minor)
- 59 E major (C sharp minor)
- 60 B major (G sharp minor)
- 61 F sharp major (D sharp minor)
- 62 C major (A minor)
- 63 F major (D minor)
- 64 B flat major (G minor)
- 65 E flat major (C minor)
- 66 A flat major (F minor)
- 67 D flat major (B flat minor)
- 68 G flat major (E flat minor)

The right page of the book contains musical notation examples. At the top, there are three staves of plainsong notation (neumes) on a four-line staff. The first staff is labeled '1' and 'Magni - fi - cat'. The second staff is labeled '2' and 'Nu kom der heidē Heiland,'. The third staff is labeled '3' and '5 6 7'. Below these are several staves of modern musical notation. The first staff is a bass clef staff with a 3/8 time signature, labeled with measure numbers 8 through 27. The second staff is a treble clef staff with a 2/4 time signature, labeled with measure numbers 28 through 41. The third staff is a treble clef staff with a 2/4 time signature, labeled with measure numbers 42 through 44. The fourth staff is a treble clef staff with a 2/4 time signature, labeled with measure numbers 45 through 47. The fifth staff is a treble clef staff with a 2/4 time signature, labeled with measure numbers 48 through 49. The sixth staff shows five key signatures: 50 (one sharp), 51 (one natural), 52 (one flat), 53 (two flats), and 54 (one sharp). The seventh staff shows six key signatures: 55 (two sharps), 56 (two sharps), 57 (two sharps), 58 (two sharps), 59 (two sharps), and 60 (two sharps). The eighth staff shows six key signatures: 61 (two sharps), 62 (two sharps), 63 (two sharps), 64 (two sharps), 65 (two sharps), and 66 (two sharps). The ninth staff shows six key signatures: 67 (two sharps), 68 (two sharps), 69 (two sharps), 70 (two sharps), 71 (two sharps), and 72 (two sharps).

- 1-5 chord
- 1-4 triad
- 1 major triad
- 2 minor triad
- 3 diminished triad
- 4 augmented triad
- 5 chord of four notes, a chord of the seventh (seventh chord, dominant seventh chord)
- 6-13 intervals
- 6 unison (unison interval)
- 7 major second
- 8 major third
- 9 perfect fourth
- 10 perfect fifth
- 11 major sixth
- 12 major seventh
- 13 perfect octave
- 14-22 ornaments (graces, grace notes)
- 14 long appoggiatura
- 15 acciaccatura (short appoggiatura)
- 16 slide
- 17 trill (shake) without turn
- 18 trill (shake) with turn
- 19 upper mordent (inverted mordent, pralltriller)
- 20 lower mordent (mordent)
- 21 turn
- 22 arpeggio
- 23-26 other signs in musical notation
- 23 triplet; corresponding groupings: duplet (couplet), quadruplet, quintuplet, sextolet (sextuplet), septolet (septuplet, septimole)
- 24 tie (bind)
- 25 pause (pause sign)
- 26 repeat mark
- 27-41 expression marks (signs of relative intensity)
- 27 marcato (marcando, markiert, attack, strong accent)
- 28 presto (quick, fast)
- 29 portato (lourer, mezzo staccato, carried)
- 30 tenuto (held)
- 31 crescendo (increasing gradually in power)
- 32 decrescendo (diminuendo, decreasing or diminishing gradually in power)

- 33 legato (bound)
- 34 staccato (detached)
- 35 piano (soft)
- 36 pianissimo (very soft)
- 37 pianissimo piano (as soft as possible)
- 38 forte (loud)
- 39 fortissimo (very loud)
- 40 forte fortissimo (double fortissimo, as loud as possible)
- 41 forte piano (loud and immediately soft again)
- 42-50 divisions of the compass
- 42 subcontra octave (double contra octave)
- 43 contra octave
- 44 great octave
- 45 small octave
- 46 one-line octave
- 47 two-line octave
- 48 three-line octave
- 49 four-line octave
- 50 five-line octave

1 2 3 4 5 6 7 8 9 10 11 12 13

14 15 16 17 18 19 20 21

22 23 24 25 26

28 Presto

29 30 31 32 33 34

p *pp* *ppp* *f* *ff* *fff* *fp*

35 36 37 38 39 40 41

42 43 44 45 46 47 48 49 50

8va sopra

8va bassa

${}^2A_2 B_2 H_1 C$ usw
in Britain:
 $A_2 B_{\flat 2} B_2 C_1$ etc.

${}^1H C H c h c^1 h^1 c^2 h^2 c^3 h^3 c^4 h^4 c^5$

$B_1 C B c b c' b' c'' b' c'' b' c'' b' c''$

- 1 lur, a bronze trumpet
- 2 panpipes (Pandean pipes, syrinx)
- 3 aulos, a double shawm
- 4 aulos pipe
- 5 phorbeia (peristomion, capistrum, mouth band)
- 6 crumhorn (crumhorn, cromorne, krumhorn, krummhorn)
- 7 recorder (fipple flute)
- 8 bagpipe; *sim.*: musette
- 9 bag
- 10 chanter (melody pipe)
- 11 drone (drone pipe)
- 12 curved cornett (zink)
- 13 serpent
- 14 shawm (schalmeyes); *larger*: bombard (bombarde, pommer)
- 15 cythara (cithara); *sim. and smaller*: lyre
- 16 arm
- 17 bridge
- 18 sound box (resonating chamber, resonator)
- 19 plectrum, a plucking device
- 20 kit (pochette), a miniature violin
- 21 cittern (cithern, cither, cister, citole), a plucked instrument; *sim.*: pandora (bandora, bandore)
- 22 sound hole
- 23 viol (descant viol, treble viol), a viola da gamba; *larger*: tenor viol, bass viol (viola da gamba, gamba), violone (double bass viol)
- 24 viol bow
- 25 hurdy-gurdy (vielle à roue, symphonia, armonie, organistrum)
- 26 friction wheel
- 27 wheel cover (wheel guard)
- 28 keyboard (keys)
- 29 resonating body (resonator, sound box)
- 30 melody strings
- 31 drone strings (drones, bourdons)
- 32 dulcimer
- 33 rib (resonator wall)
- 34 beater for the Valasian dulcimer
- 35 hammer (stick) for the Appenzell dulcimer

- 36 clavichord; *kinds*: fretted or unfretted clavichord
- 37 clavichord mechanism
- 38 key (key lever)
- 39 balance rail
- 40 guiding blade
- 41 guiding slot
- 42 resting rail
- 43 tangent
- 44 string
- 45 harpsichord (clavicembalo, cembalo), a wing-shaped stringed keyboard instrument; *sim.*: spinet (virginal)
- 46 upper keyboard (upper manual)
- 47 lower keyboard (lower manual)
- 48 harpsichord mechanism
- 49 key (key lever)
- 50 jack
- 51 slide (register)
- 52 tongue
- 53 quill plectrum
- 54 damper
- 55 string
- 56 portative organ, a portable organ; *larger*: positive organ (positive)
- 57 pipe (flue pipe)
- 58 bellows

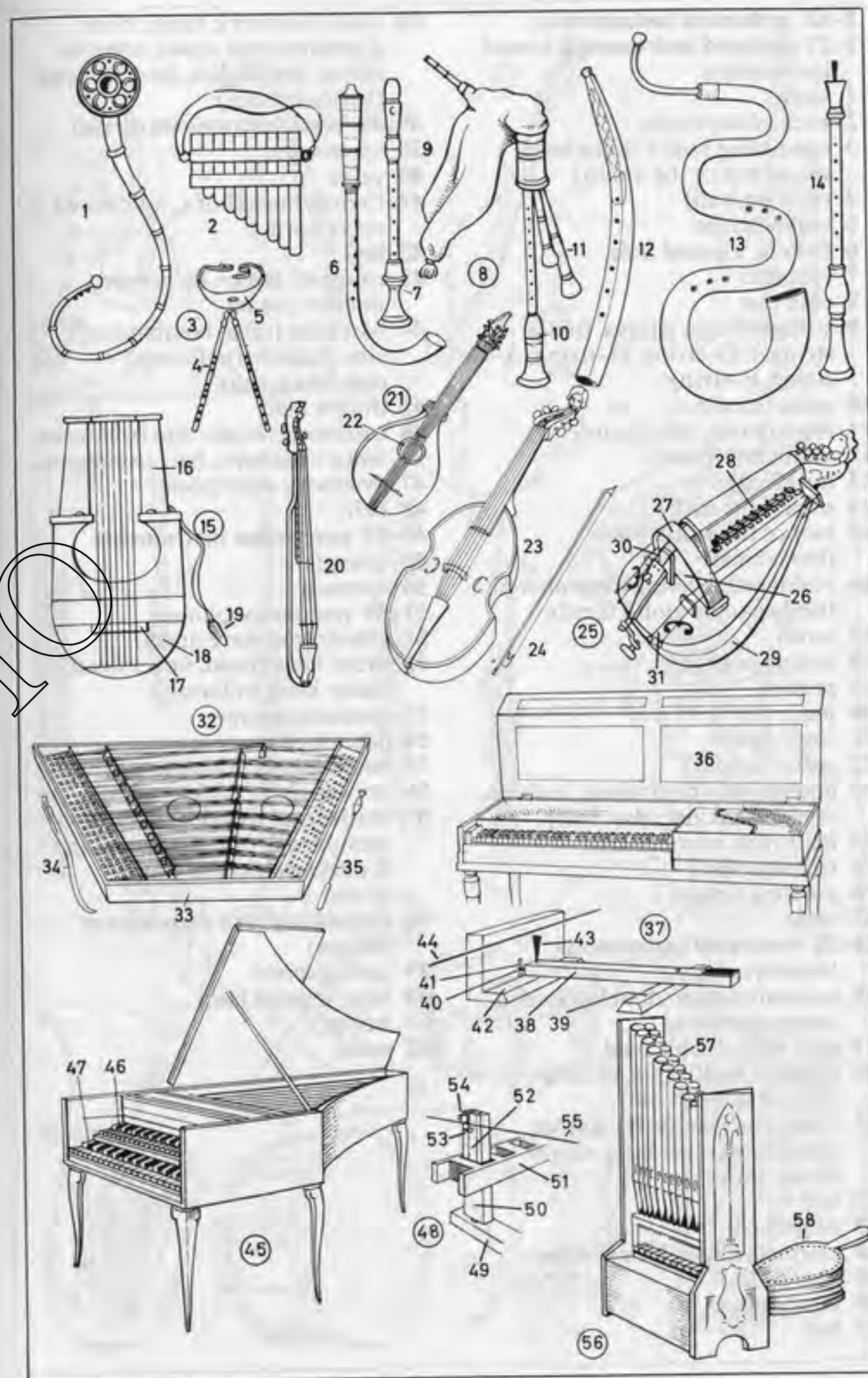

- 1-62 orchestral instruments**
1-27 stringed instruments, bowed instruments
 1 violin
 2 neck of the violin
 3 resonating body (violin body, sound box of the violin)
 4 rib (side wall)
 5 violin bridge
 6 F-hole, a sound hole
 7 tailpiece
 8 chin rest
 9 strings (violin strings, fiddle strings): G-string, D-string, A-string, E-string
 10 mute (sordino)
 11 resin (rosin, colophony)
 12 violin bow (bow)
 13 nut (frog)
 14 stick (bow stick)
 15 hair of the violin bow (horsehair)
 16 violoncello (cello), a member of the da gamba violin family
 17 scroll
 18 tuning peg (peg)
 19 pegbox
 20 nut
 21 fingerboard
 22 spike (tailpin)
 23 double bass (contrabass, violone, double bass viol, *Am.* bass)
 24 belly (top, soundboard)
 25 rib (side wall)
 26 purfling (inlay)
 27 viola
28-38 woodwind instruments (woodwinds)
 28 bassoon; *larger*: double bassoon (contrabassoon)
 29 tube with double reed
 30 piccolo (small flute, piccolo flute, flauto piccolo)
 31 flute (German flute), a cross flute (transverse flute, side-blown flute)
 32 key
 33 fingerhole
 34 clarinet; *larger*: bass clarinet
 35 key (brille)
 36 mouthpiece
 37 bell
 38 oboe (hautboy); *kinds*: oboe d'amore; tenor oboes: oboe da caccia, cor anglais; heckelphone (baritone oboe)
39-48 brass instruments (brass)
 39 tenor horn
 40 valve
 41 French horn (horn, waldhorn), a valve horn
 42 bell
 43 trumpet; *larger*: B \flat cornet; *smaller*: cornet
 44 bass tuba (tuba, bombardon); *sim.*: helicon (pellitone), contrabass tuba
 45 thumb hold
 46 trombone; *kinds*: alto trombone, tenor trombone, bass trombone
 47 trombone slide (slide)
 48 bell
49-59 percussion instruments
 49 triangle
 50 cymbals
51-59 membranophones
 51 side drum (snare drum)
 52 drum head (head, upper head, batter head, vellum)
 53 tensioning screw
 54 drumstick
 55 bass drum (Turkish drum)
 56 stick (padded stick)
 57 kettledrum (timpano), a screw-tensioned drum; *sim.*: machine drum (mechanically tuned drum)
 58 kettledrum skin (kettledrum vellum)
 59 tuning screw
 60 harp, a pedal harp
 61 strings
 62 pedal

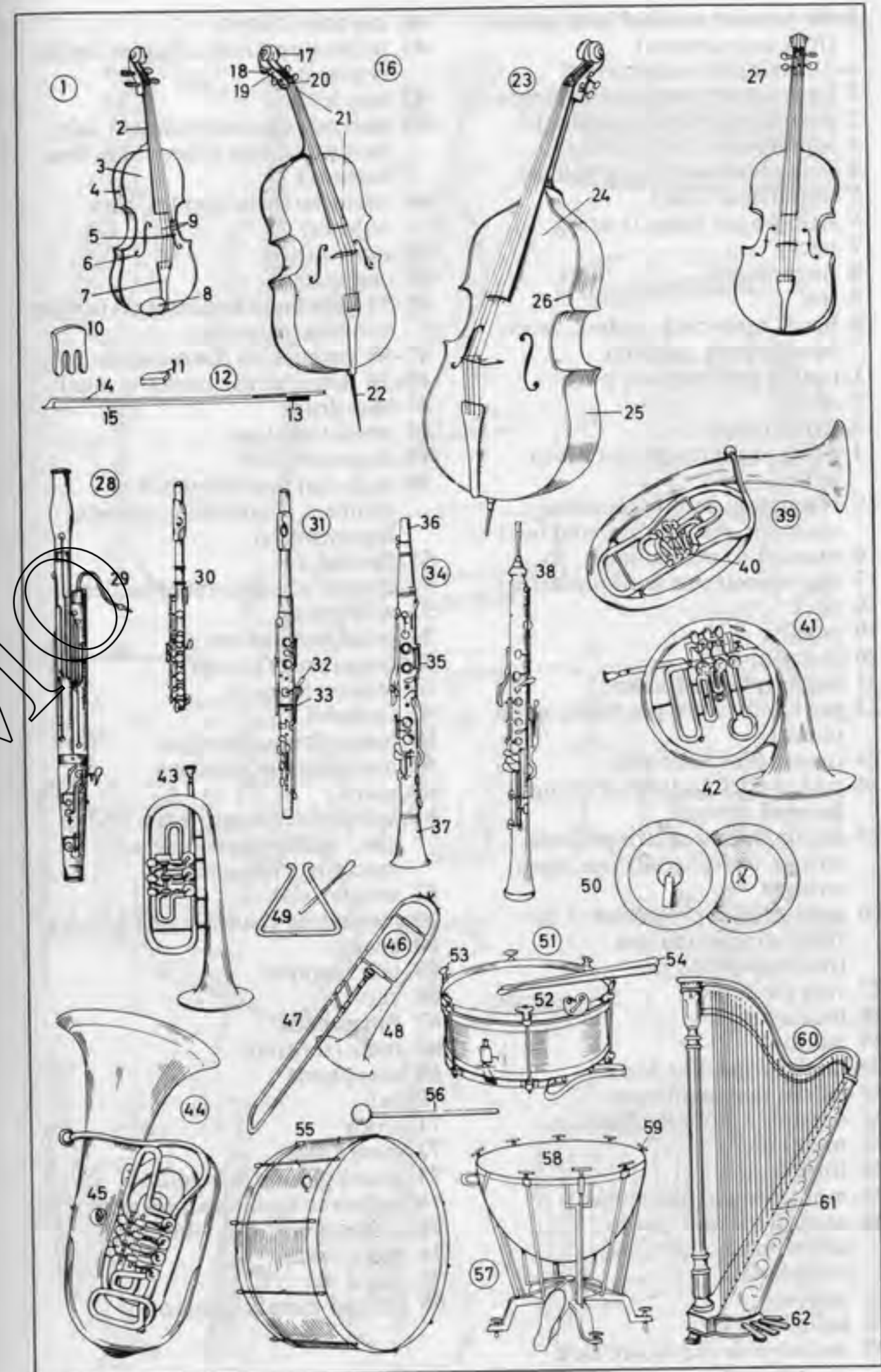

- 1-46 popular musical instruments (folk instruments)
 1-31 stringed instruments
 1 lute; *larger*: theorbo, chitarraone
 2 resonating body (resonator)
 3 soundboard (belly, table)
 4 string fastener (string holder)
 5 sound hole (rose)
 6 string, a gut (catgut) string
 7 neck
 8 fingerboard
 9 fret
 10 head (bent-back pegbox, swan-head pegbox, pegbox)
 11 tuning peg (peg, lute pin)
 12 guitar
 13 string holder
 14 string, a gut (catgut) or nylon string
 15 resonating body (resonating chamber, resonator, sound box)
 16 mandolin (mandoline)
 17 sleeve protector (cuff protector)
 18 neck
 19 pegdisc
 20 plectrum
 21 zither (plucked zither)
 22 pin block (wrest pin block, wrest plank)
 23 tuning pin (wrest pin)
 24 melody strings (fretted strings, stopped strings)
 25 accompaniment strings (bass strings, unfretted strings, open strings)
 26 semicircular projection of the resonating sound box (resonating body)
 27 ring plectrum
 28 balalaika
 29 banjo
 30 tambourine-like body
 31 parchment membrane
 32 ocarina, a globular flute
 33 mouthpiece
 34 fingerhole
 35 mouth organ (harmonica)
 36 accordion; *sim.*: piano accordion, concertina, bandoneon
 37 bellows
 38 bellows strap
 39 melody side (keyboard side, melody keys)

- 40 keyboard (keys)
 41 treble stop (treble coupler, treble register)
 42 stop lever
 43 bass side (accompaniment side, bass studs, bass press-studs, bass buttons)
 44 bass stop (bass coupler, bass register)
 45 tambourine
 46 castanets
 47-78 jazz band instruments (dance band instruments)
 47-58 percussion instruments
 47-54 drum kit (drum set, drums)
 47 bass drum
 48 small tom-tom
 49 large tom-tom
 50 high-hat cymbals (choke cymbals, Charleston cymbals, cup cymbals)
 51 cymbal
 52 cymbal stand (cymbal holder)
 53 wire brush
 54 pedal mechanism
 55 conga drum (conga)
 56 tension hoop
 57 timbales
 58 bongo drums (bongos)
 59 maracas; *sim.*: shakers
 60 guiro
 61 xylophone; *form.*: straw fiddle; *sim.*: marimbaphone (steel marimba), tubaphone
 62 wooden slab
 63 resonating chamber (sound box)
 64 beater
 65 jazz trumpet
 66 valve
 67 finger hook
 68 mute (sordino)
 69 saxophone
 70 bell
 71 crook
 72 mouthpiece
 73 struck guitar (jazz guitar)
 74 hollow to facilitate fingering
 75 vibraphone (*Am.* vibraharp)
 76 metal frame
 77 metal bar
 78 tubular metal resonator



- 1 piano (pianoforte, upright piano, upright, vertical piano, spinet piano, console piano), a keyboard instrument (keyed instrument); *smaller form*: cottage piano (pianino); *earlier forms*: pantaleon, celesta, with steel bars instead of strings
- 2-18 piano action (piano mechanism)
- 2 iron frame
- 3 hammer; *collectively*: striking mechanism
- 4-5 keyboard (piano keys)
- 4 white key (ivory key)
- 5 black key (ebony key)
- 6 piano case
- 7 strings (piano strings)
- 8-9 piano pedals
- 8 right pedal (sustaining pedal, damper pedal; *loosely*: forte pedal, loud pedal) for raising the dampers
- 9 left pedal (soft pedal; *loosely*: piano pedal) for reducing the striking distance of the hammers on the strings
- 10 treble strings
- 11 treble bridge (treble belly bridge)
- 12 bass strings
- 13 bass bridge (bass belly bridge)
- 14 hitch pin
- 15 hammer rail
- 16 brace
- 17 tuning pin (wrest pin, tuning peg)
- 18 pin block (wrest pin block, wrest plank)
- 19 metronome
- 20 tuning hammer (tuning key, wrest)
- 21 tuning wedge
- 22-39 key action (key mechanism)
- 22 beam
- 23 damper-lifting lever
- 24 felt-covered hammer head
- 25 hammer shank
- 26 hammer rail
- 27 check (back check)
- 28 check felt (back check felt)
- 29 wire stem of the check (wire stem of the back check)
- 30 sticker (hopper, hammer jack, hammer lever)
- 31 button
- 32 action lever
- 33 pilot
- 34 pilot wire
- 35 tape wire
- 36 tape
- 37 damper (damper block)
- 38 damper lifter
- 39 damper rest rail
- 40 grand piano (horizontal piano, grand, concert grand); *smaller*: baby grand piano, boudoir piano; *sim.*: square piano, table piano
- 41 grand piano pedals; right pedal for raising the dampers; left pedal for softening the tone (shifting the keyboard so that only one string is struck 'una corda')
- 42 pedal bracket
- 43 harmonium (reed organ, melodium)
- 44 draw stop (stop, stop knob)
- 45 knee lever (knee swell, swell)
- 46 pedal (bellows pedal)
- 47 harmonium case
- 48 harmonium keyboard (manual)

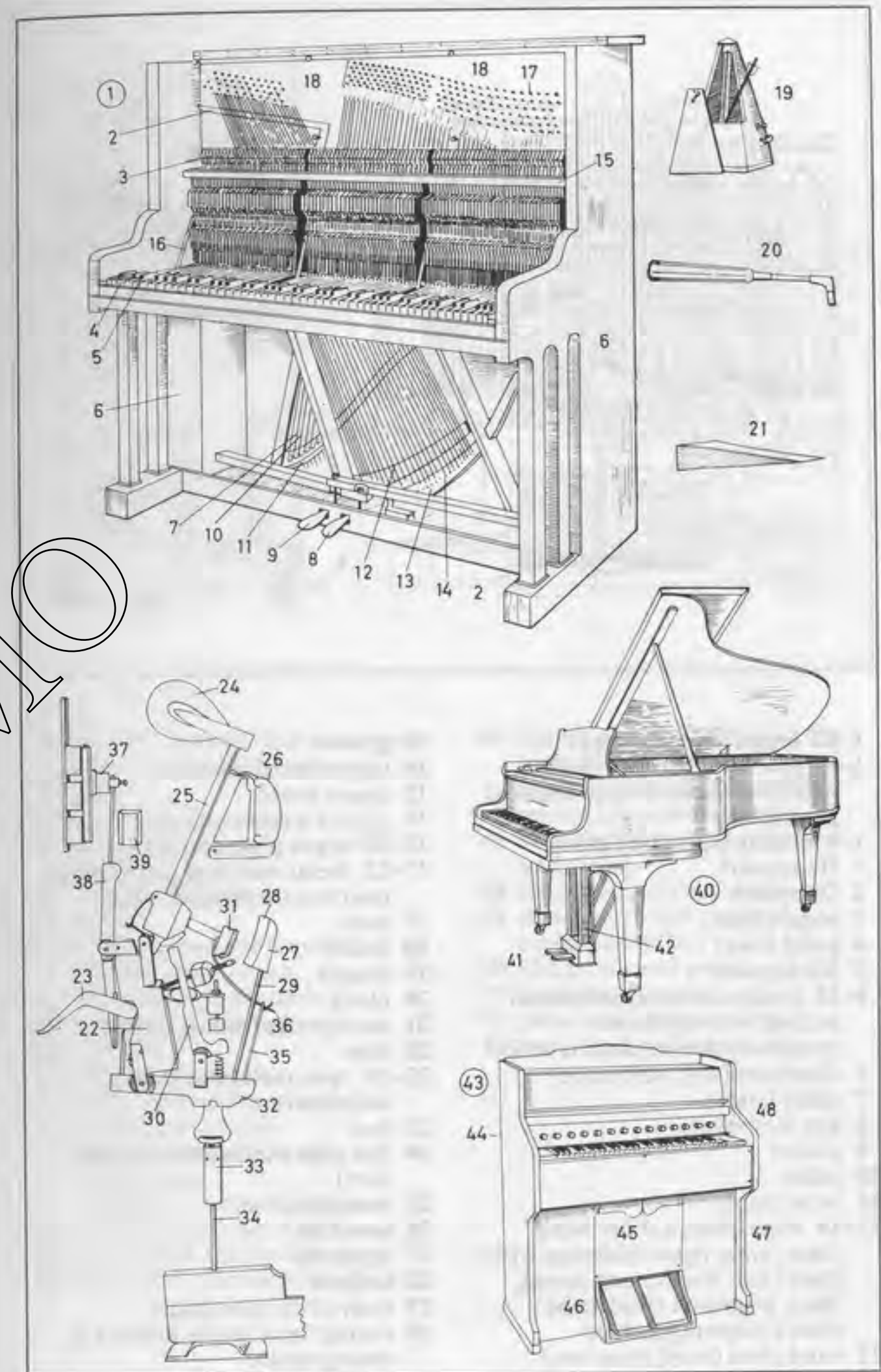

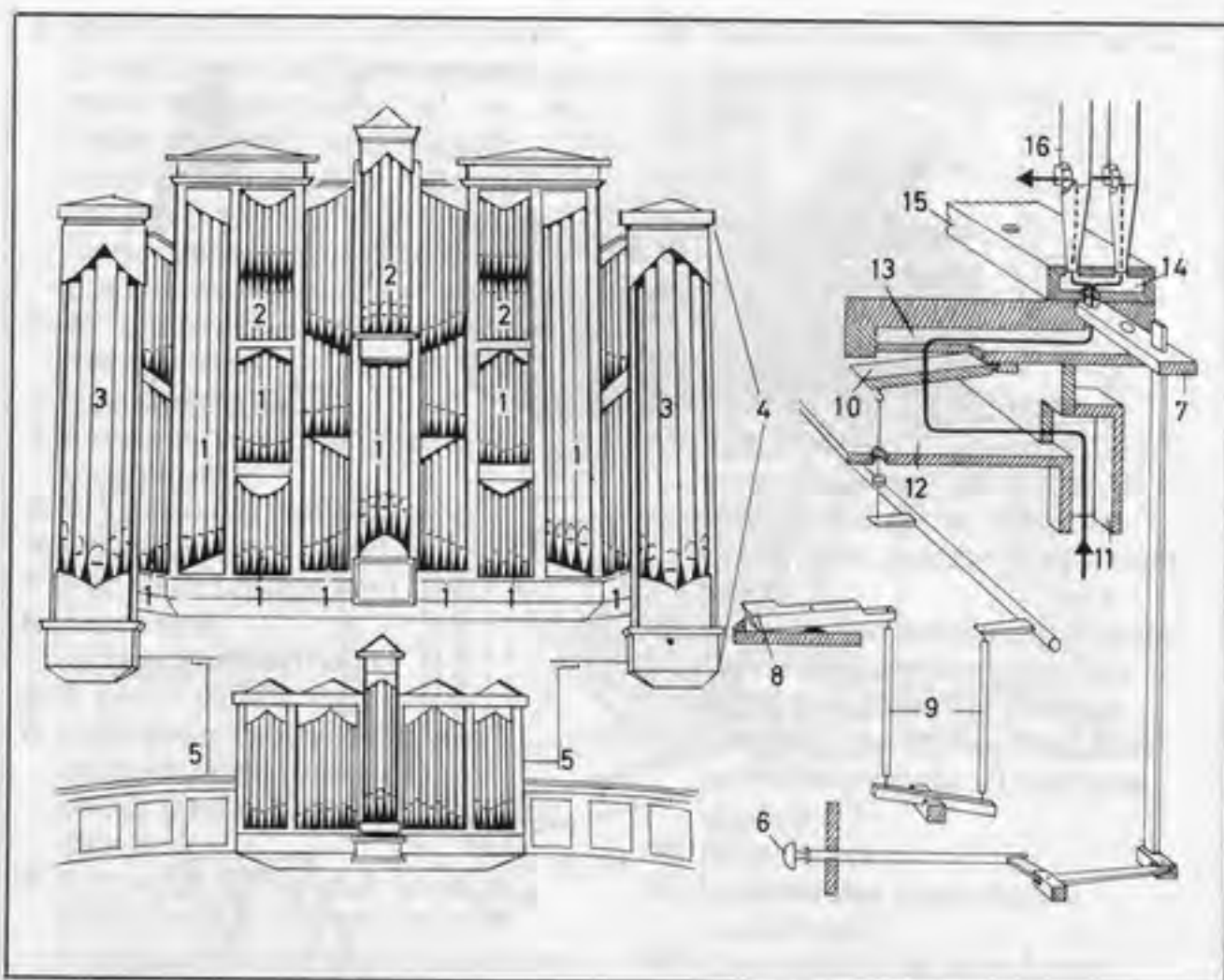

- 1-52 organ (church organ)**
1-5 front view of organ (organ case) [built according to classical principles]
1-3 display pipes (face pipes)
1 Hauptwerk
2 Oberwerk
3 pedal pipes
4 pedal tower
5 Rückpositiv
6-16 tracker action (mechanical action); *other systems:* pneumatic action, electric action
6 draw stop (stop, stop knob)
7 slider (slide)
8 key (key lever)
9 sticker
10 pallet
11 wind trunk
12-14 wind chest, a slider wind chest; *other types:* sliderless wind chest (unit wind chest), spring chest, kegellade chest (cone chest), diaphragm chest
12 wind chest (wind chest box)
13 groove
14 upper board groove
15 upper board
16 pipe of a particular stop
17-35 organ pipes (pipes)
17-22 metal reed pipe (*set of pipes:* reed stop), a posaune stop
17 boot
18 shallot
19 tongue
20 block
21 tuning wire (tuning crook)
22 tube
23-30 open metal flue pipe, a salicional
23 foot
24 flue pipe windway (flue pipe duct)
25 mouth (cutup)
26 lower lip
27 upper lip
28 languid
29 body of the pipe (pipe)
30 tuning flap (tuning tongue), a tuning device

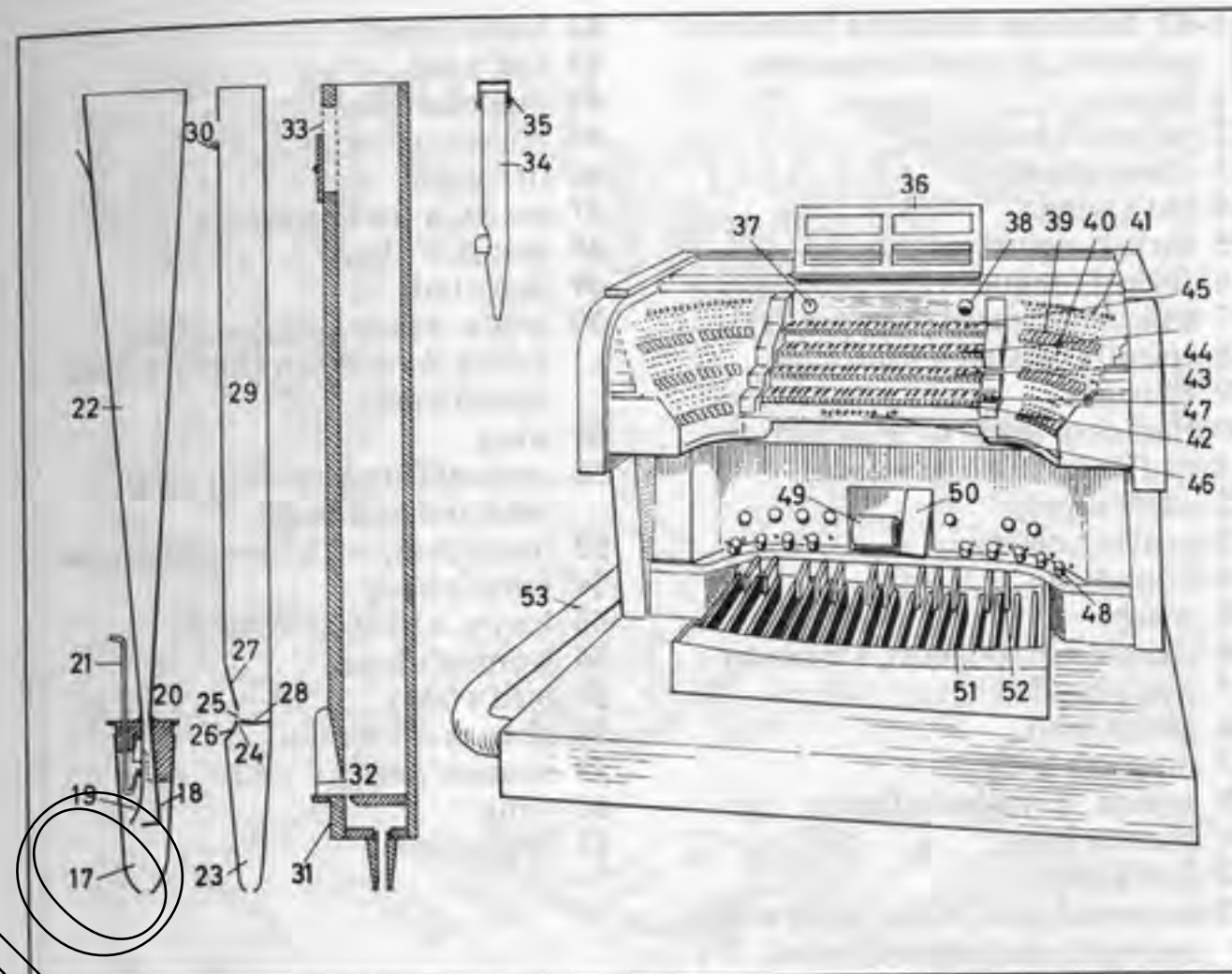

- 31-33** open wooden flue pipe (open wood), principal (diapason)
31 cap
32 ear
33 tuning hole (tuning slot), with slide
34 stopped flue pipe
35 stopper
36-52 organ console (console) of an electric action organ
36 music rest (music stand)
37 crescendo roller indicator
38 voltmeter
39 stop tab (rocker)
40 free combination stud (free combination knob)
41 cancel buttons for reeds, couplers etc.
42 manual I, for the Rückpositiv
43 manual II, for the Hauptwerk
44 manual III, for the Oberwerk
45 manual IV, for the Schwellwerk
46 thumb pistons controlling the manual stops (free or fixed combinations) and buttons for setting the combinations
47 switches for current to blower and action
48 toe piston, for the coupler
49 crescendo roller (general crescendo roller)
50 balanced swell pedal
51 pedal key [natural]
52 pedal key [sharp or flat]
53 cable (transmission cable)

- 1-61 fabulous creatures (fabulous animals), mythical creatures
- 1 dragon
 - 2 serpent's body
 - 3 claws (claw)
 - 4 bat's wing
 - 5 fork-tongued mouth
 - 6 forked tongue
 - 7 unicorn [symbol of virginity]
 - 8 spirally twisted horn
 - 9 Phoenix
 - 10 flames or ashes of resurrection
 - 11 griffin (griffon, gryphon)
 - 12 eagle's head
 - 13 griffin's claws
 - 14 lion's body
 - 15 wing
 - 16 chimera (chimaera), a monster
 - 17 lion's head
 - 18 goat's head
 - 19 dragon's body
 - 20 sphinx, a symbolic figure
 - 21 human head
 - 22 lion's body
 - 23 mermaid (nix, nixie, water nixie, sea maid, sea maiden, naiad, water nymph, water elf, ocean nymph, sea nymph, river nymph); *sim.*: Nereids, Oceanids (sea divinities, sea deities, sea goddesses); *male*: nix (merman, seaman)
 - 24 woman's trunk
 - 25 fish's tail (dolphin's tail)
 - 26 Pegasus (favourite, *Am.* favorite, steed of the Muses, winged horse); *sim.*: hippogryph
 - 27 horse's body
 - 28 wings
 - 29 Cerberus (hellhound)
 - 30 three-headed dog's body
 - 31 serpent's tail
 - 32 Lernaean (Lernean) Hydra
 - 33 nine-headed serpent's body
 - 34 basilisk (cockatrice)
 - 35 cock's head
 - 36 dragon's body
 - 37 giant (titan)
 - 38 rock
 - 39 serpent's foot
 - 40 triton, a merman (demigod of the sea)
 - 41 conch shell trumpet

- 42 horse's hoof
- 43 fish's tail
- 44 hippocampus
- 45 horse's trunk
- 46 fish's tail
- 47 sea ox, a sea monster
- 48 monster's body
- 49 fish's tail
- 50 seven-headed dragon of St. John's Revelation (Revelations, Apocalypse)
- 51 wing
- 52 centaur (hippocentaur), half man and half beast
- 53 man's body with bow and arrow
- 54 horse's body
- 55 harpy, a winged monster
- 56 woman's head
- 57 bird's body
- 58 siren, a daemon
- 59 woman's body
- 60 wing
- 61 bird's claw

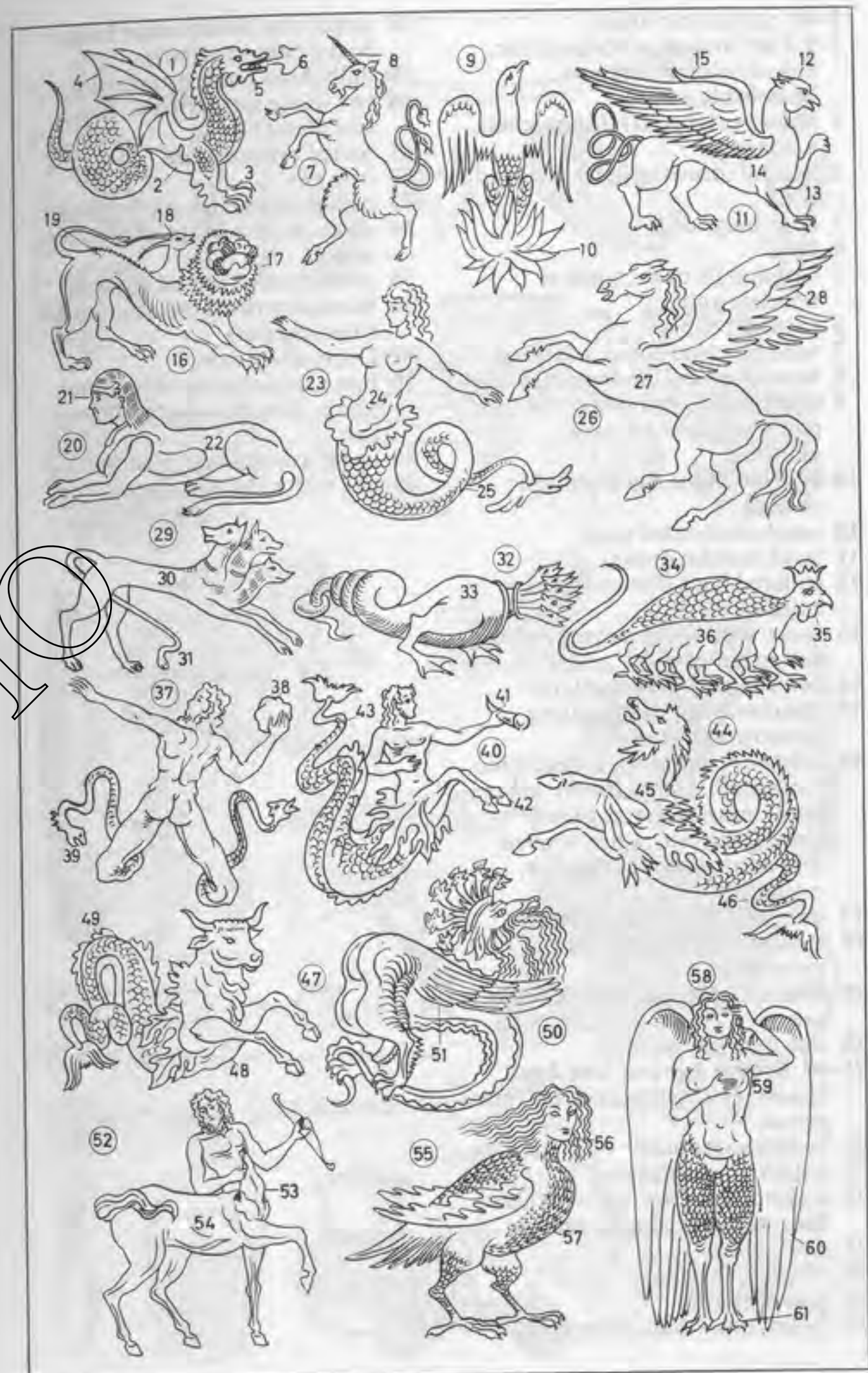

- 1-40 prehistoric finds
1-9 Old Stone Age (Palaeolithic, Paleolithic, period) and Mesolithic period
 1 hand axe (*Am. ax*) (fist hatchet), a stone tool
 2 head of throwing spear, made of bone
 3 bone harpoon
 4 head
 5 harpoon thrower, made of reindeer antler
 6 painted pebble
 7 head of a wild horse, a carving
 8 Stone Age idol, an ivory statuette
 9 bison, a cave painting (rock painting) [cave art, cave painting]
10-20 New Stone Age (Neolithic period)
 10 amphora [corded ware]
 11 bowl [menhir group]
 12 collared flask [Funnel-Beaker culture]
 13 vessel with spiral pattern [spiral design pottery]
 14 bell beaker [beaker pottery]
 15 pile dwelling (lake dwelling, lacustrine dwelling)
 16 dolmen (cromlech), a megalithic tomb (*coll.*: giant's tomb); *other kinds*: passage grave, gallery grave (long cist); *when covered with earth*: tumulus (barrow, mound)
 17 stone cist, a contracted burial
 18 menhir (standing stone), a monolith
 19 boat axe (*Am. ax*), a stone battle axe
 20 clay figurine (an idol)
21-40 Bronze Age and Iron Age;
epochs: Hallstatt period, La Tène period
 21 bronze spear head
 22 hafted bronze dagger
 23 socketed axe (*Am. ax*) with haft fastened to rings, a bronze axe
 24 girdle clasp
 25 necklace (lunula)
 26 gold neck ring
 27 violin-bow fibula (safety pin)

- 28 serpentine fibula; *other kinds*: boat fibula, arc fibula
 29 bulb-head pin, a bronze pin
 30 two-piece spiral fibula; *sim.*: disc (disk) fibula
 31 hafted bronze knife
 32 iron key
 33 ploughshare (*Am. plowshare*)
 34 sheet-bronze situla, a funerary vessel
 35 pitcher [chip-carved pottery]
 36 miniature ritual cart (miniature ritual chariot)
 37 Celtic silver coin
 38 face urn, a cinerary urn; *other kinds*: domestic urn, embossed urn
 39 urn grave in stone chamber
 40 urn with cylindrical neck



- 1 knight's castle (castle)
 2 inner ward (inner bailey)
 3 draw well
 4 keep (donjon)
 5 dungeon
 6 battlements (crenellation)
 7 merlon
 8 tower platform
 9 watchman
 10 ladies' apartments (bowers)
 11 dormer window (dormer)
 12 balcony
 13 storehouse (magazine)
 14 angle tower
 15 curtain wall (curtains, enclosure wall)
 16 bastion
 17 angle tower
 18 crenel (embrasure)
 19 inner wall
 20 battlemented parapet
 21 parapet (breastwork)
 22 gatehouse
 23 machicolation (machicoulis)
 24 portcullis
 25 drawbridge
 26 buttress
 27 offices and service rooms
 28 turret
 29 chapel
 30 great hall
 31 outer ward (outer bailey)
 32 castle gate
 33 moat (ditch)
 34 approach
 35 watchtower (turret)
 36 palisade (pallisade, palisading)
 37 moat (ditch, fosse)
 38-65 knight's armour (*Am. armor*)
 38 suit of armour (*Am. armor*)
 39 skull
 40 visor (vizor)
 41 beaver
 42 throat piece
 43 gorget
 44 epaulière
 45 palette (pauldron, besageur)
 46 breastplate (cuirass)
 47 brassard (rear brace and vambrace)
 48 cubitière (coudière, couter)
 49 tasse (tasset)
 50 gauntlet
 51 habergeon (haubergeon)
 52 cuisse (cuish, cuissard, cuissart)
 53 knee cap (knee piece, genouillère, poleyn)
 54 jambeau (greave)
 55 solleret (sabaton, sabbaton)
 56 pavis (pavise, pavais)
 57 buckler (round shield)
 58 boss (umbo)
 59 iron hat
 60 morion
 61 light casque
 62 types of mail and armour (*Am. armor*)
 63 mail (chain mail, chain armour, *Am. armor*)
 64 scale armour (*Am. armor*)
 65 plate armour (*Am. armor*)
 66 accolade (dubbing, knighting)
 67 liege lord, a knight
 68 esquire
 69 cup bearer
 70 minstrel (minnesinger, troubadour)
 71 tournament (tourney, joust, just, tilt)
 72 crusader
 73 Knight Templar
 74 caparison (trappings)
 75 herald (marshal at tournament)
 76 tilting armour (*Am. armor*)
 77 tilting helmet (jousting helmet)
 78 panache (plume of feathers)
 79 tilting target (tilting shield)
 80 lance rest
 81 tilting lance (lance)
 82 vamplate
 83-88 horse armour (*Am. armor*)
 83 neck guard (neck piece)
 84 chamfron (chaffron, chafron, chamfrain, chanfron)
 85 poitrel
 86 flanchard (flancard)
 87 tournament saddle
 88 rump piece (quarter piece)

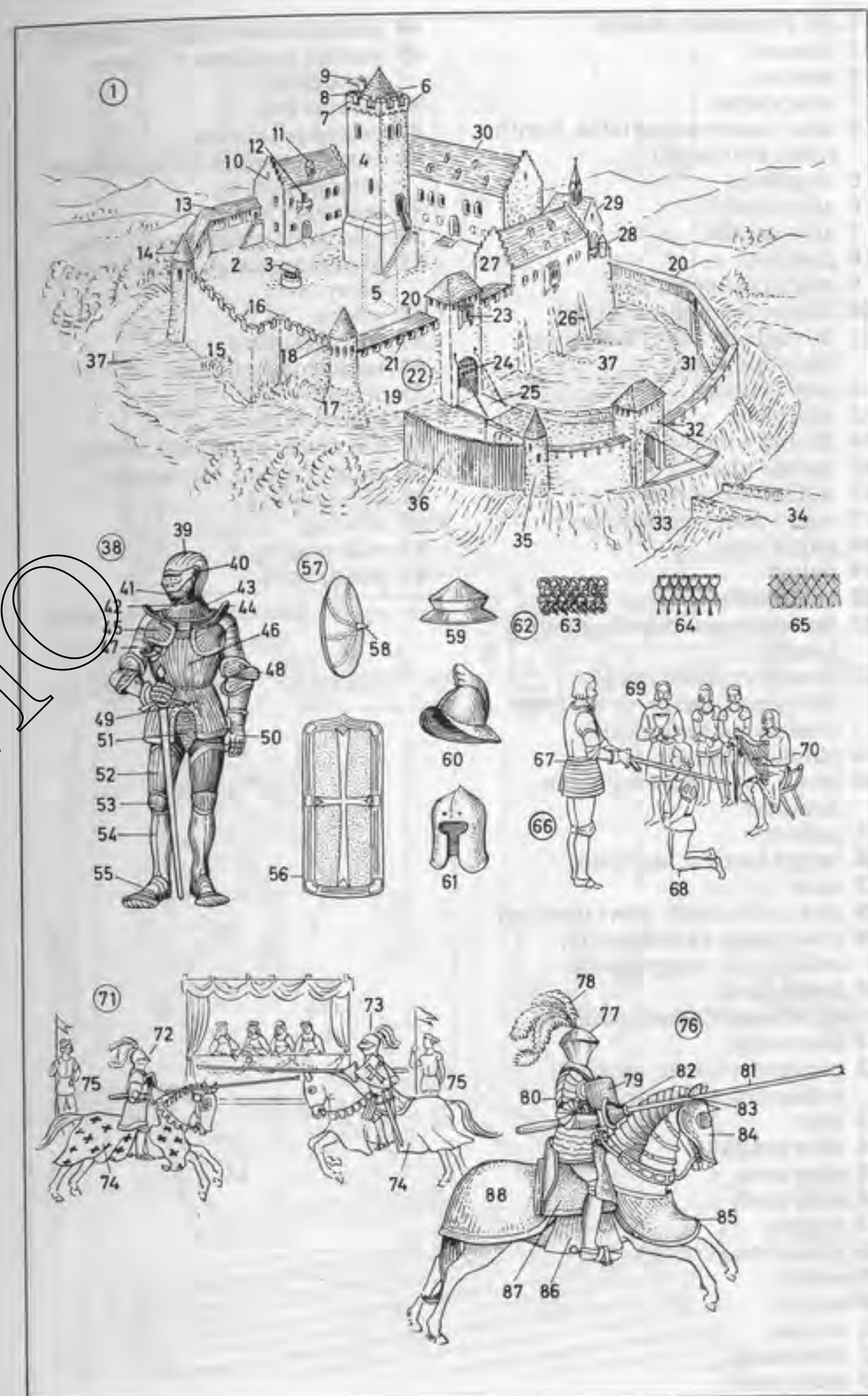

1-30 Protestant church

- 1 chancel
- 2 lectern
- 3 altar carpet
- 4 altar (communion table, Lord's table, holy table)
- 5 altar steps
- 6 altar cloth
- 7 altar candle
- 8 pyx (pix)
- 9 paten (patin, patine)
- 10 chalice (communion cup)
- 11 Bible (Holy Bible, Scriptures, Holy Scripture)
- 12 altar crucifix
- 13 altarpiece
- 14 church window
- 15 stained glass
- 16 wall candelabrum
- 17 vestry door (sacristy door)
- 18 pulpit steps
- 19 pulpit
- 20 antependium
- 21 canopy (soundboard, sounding board)
- 22 preacher (pastor, vicar, clergyman, rector) in his robes (vestments, canonicals)
- 23 pulpit balustrade
- 24 hymn board showing hymn numbers
- 25 gallery
- 26 vergers (sexton, sacristan)
- 27 aisle
- 28 pew; collectively: pews (seating)
- 29 churchgoer (worshipper); collectively: congregation
- 30 hymn book

- 44 paschal candle (Easter candle)
- 45 paschal candlestick (Easter candlestick)
- 46 sanctus bell
- 47 processional cross
- 48 altar decoration (foliage, flower arrangement)
- 49 sanctuary lamp
- 50 altarpiece, a picture of Christ
- 51 Madonna, statue of the Virgin Mary
- 52 pricket
- 53 votive candles
- 54 station of the Cross
- 55 offertory box
- 56 literature stand
- 57 literature (pamphlets, tracts)
- 58 vergers (sexton, sacristan)
- 59 offertory bag
- 60 offering
- 61 man praying
- 62 prayer book

31-62 Roman Catholic church

- 31 altar steps
- 32 presbytery (choir, chancel, sacrarium, sanctuary)
- 33 altar
- 34 altar candles
- 35 altar cross
- 36 altar cloth
- 37 lectern
- 38 missal (mass book)
- 39 priest
- 40 server
- 41 sedilia
- 42 tabernacle
- 43 stela (stela)

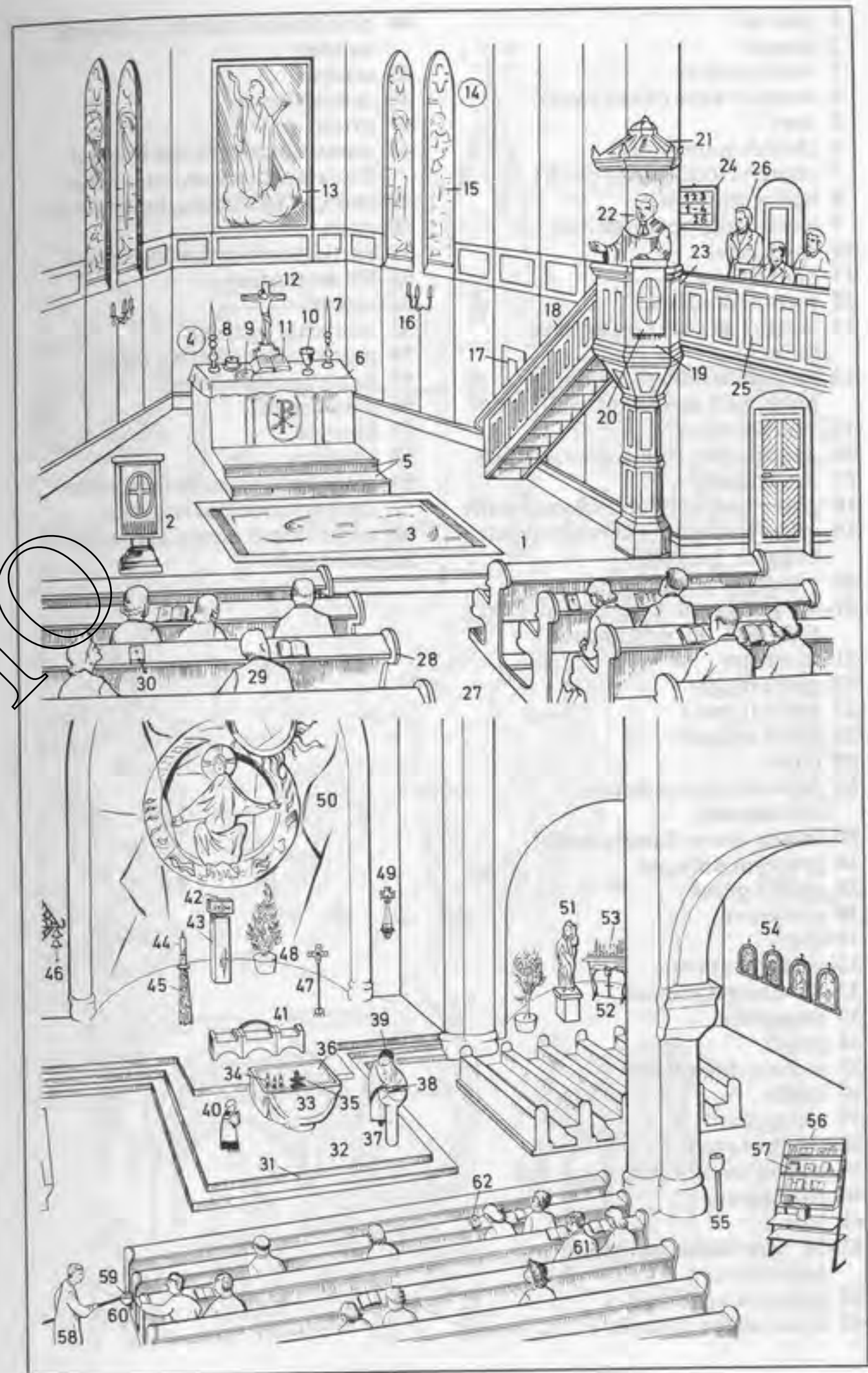

- 1 church
- 2 steeple
- 3 weathercock
- 4 weather vane (wind vane)
- 5 apex
- 6 church spire (spire)
- 7 church clock (tower clock)
- 8 belfry window
- 9 electrically operated bell
- 10 ridge cross
- 11 church roof
- 12 memorial chapel
- 13 vestry (sacristy), an annexe (annex)
- 14 memorial tablet (memorial plate, wall memorial, wall stone)
- 15 side entrance
- 16 church door (main door, portal)
- 17 churchgoer
- 18 graveyard wall (churchyard wall)
- 19 graveyard gate (churchyard gate, lichgate, lychgate)
- 20 vicarage (parsonage, rectory)
- 21-41 graveyard (churchyard, God's acre, *Am.* burying ground)
- 21 mortuary
- 22 grave digger
- 23 grave (tomb)
- 24 grave mound
- 25 cross
- 26 gravestone (headstone, tombstone)
- 27 family grave (family tomb)
- 28 graveyard chapel
- 29 child's grave
- 30 urn grave
- 31 urn
- 32 soldier's grave
- 33-41 funeral (burial)
- 33 mourners
- 34 grave
- 35 coffin (*Am.* casket)
- 36 spade
- 37 clergyman
- 38 the bereaved
- 39 widow's veil, a mourning veil
- 40 pallbearers
- 41 bier
- 42-50 procession (religious procession)
- 42 processional crucifix
- 43 cross bearer (crucifer)
- 44 processional banner, a church banner
- 45 acolyte
- 46 canopy bearer
- 47 priest
- 48 monstrance with the Blessed Sacrament (consecrated Host)
- 49 canopy (baldachin, baldaquin)
- 50 nuns
- 51 participants in the procession
- 52-58 monastery
- 52 cloister
- 53 monastery garden
- 54 monk, a Benedictine monk
- 55 habit (monk's habit)
- 56 cowl (hood)
- 57 tonsure
- 58 breviary
- 59 catacomb, an early Christian underground burial place
- 60 niche (tomb recess, arcosolium)
- 61 stone slab

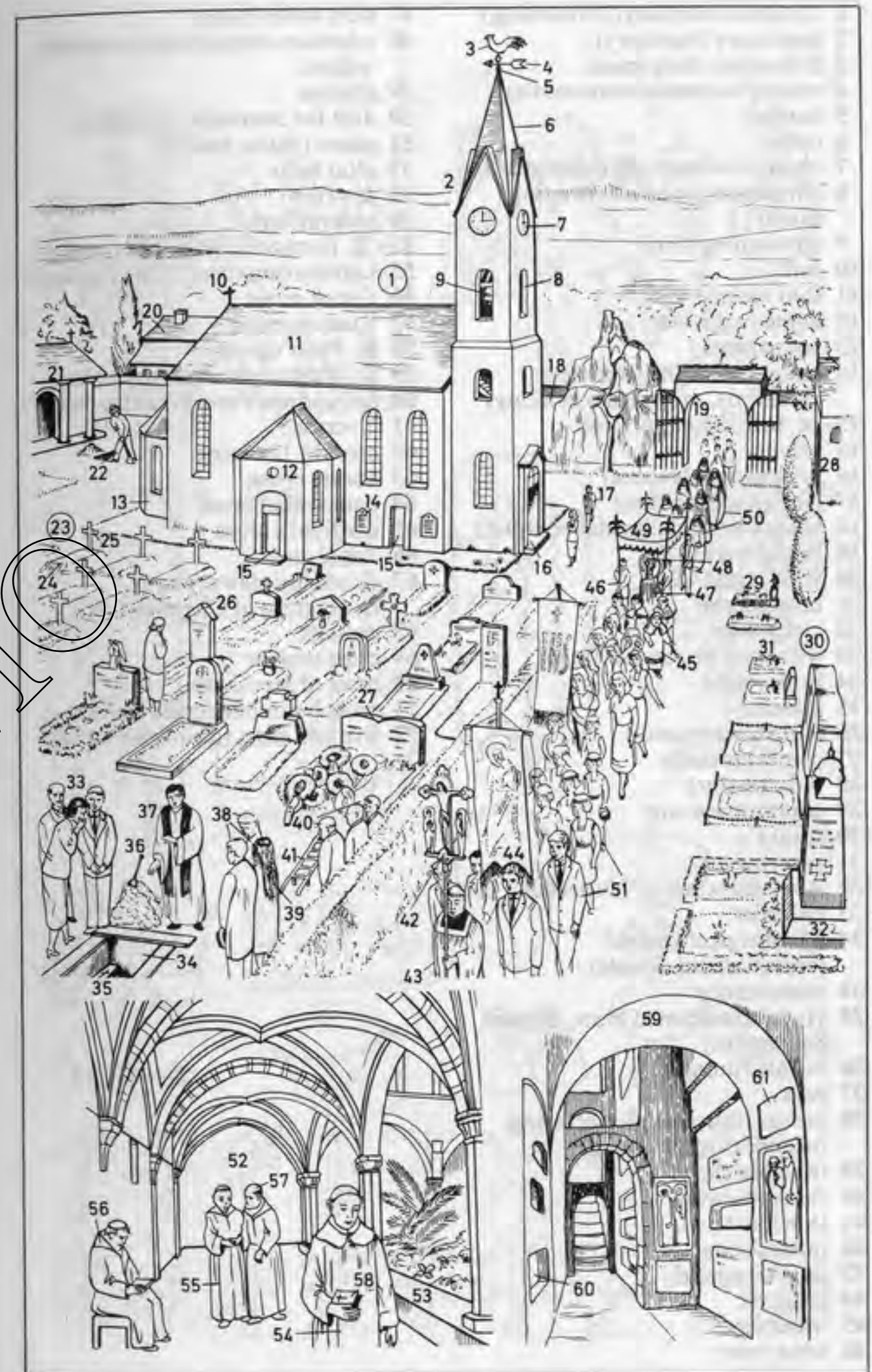

- 1 Christian baptism (christening)
- 2 baptistery (baptistry)
- 3 Protestant clergyman
- 4 robes (vestments, canonicals)
- 5 bands
- 6 collar
- 7 child to be baptized (christened)
- 8 christening robe (christening dress)
- 9 christening shawl
- 10 font
- 11 font basin
- 12 baptismal water
- 13 godparents
- 14 church wedding (wedding ceremony, marriage ceremony)
- 15-16 bridal couple
- 15 bride
- 16 bridegroom (groom)
- 17 ring (wedding ring)
- 18 bride's bouquet (bridal bouquet)
- 19 bridal wreath
- 20 veil (bridal veil)
- 21 buttonhole
- 22 clergyman
- 23 witnesses [to the marriage]
- 24 bridesmaid
- 25 kneeler
- 26 Holy Communion
- 27 communicants
- 28 Host (wafer)
- 29 communion cup
- 30 rosary
- 31 paternoster
- 32 Ave Maria; set of 10: decade
- 33 crucifix
- 34-54 liturgical vessels (ecclesiastical vessels)
- 34 monstrance
- 35 Host (consecrated Host, Blessed Sacrament)
- 36 lunula (lunule)
- 37 rays
- 38 censer (thurible), for offering incense (for incensing)
- 39 thurible chain
- 40 thurible cover
- 41 thurible bowl
- 42 incense boat
- 43 incense spoon
- 44 cruet set
- 45 water cruet
- 46 wine cruet

- 47 holy water basin
- 48 ciborium containing the sacred wafers
- 49 chalice
- 50 dish for communion wafers
- 51 paten (patin, patine)
- 52 altar bells
- 53 pyx (pix)
- 54 aspergillum
- 55-72 forms of Christian crosses
- 55 Latin cross (cross of the Passion)
- 56 Greek cross
- 57 Russian cross
- 58 St. Peter's cross
- 59 St. Anthony's cross (tau cross)
- 60 St. Andrew's cross (saltire cross)
- 61 Y-cross
- 62 cross of Lorraine
- 63 ansate cross
- 64 patriarchal cross
- 65 cardinal's cross
- 66 Papal cross
- 67 Constantinian cross, a monogram of Christ (CHR)
- 68 crosslet
- 69 cross moline
- 70 cross of Jerusalem
- 71 cross botonnée (cross treflée)
- 72 fivefold cross (quintuple cross)

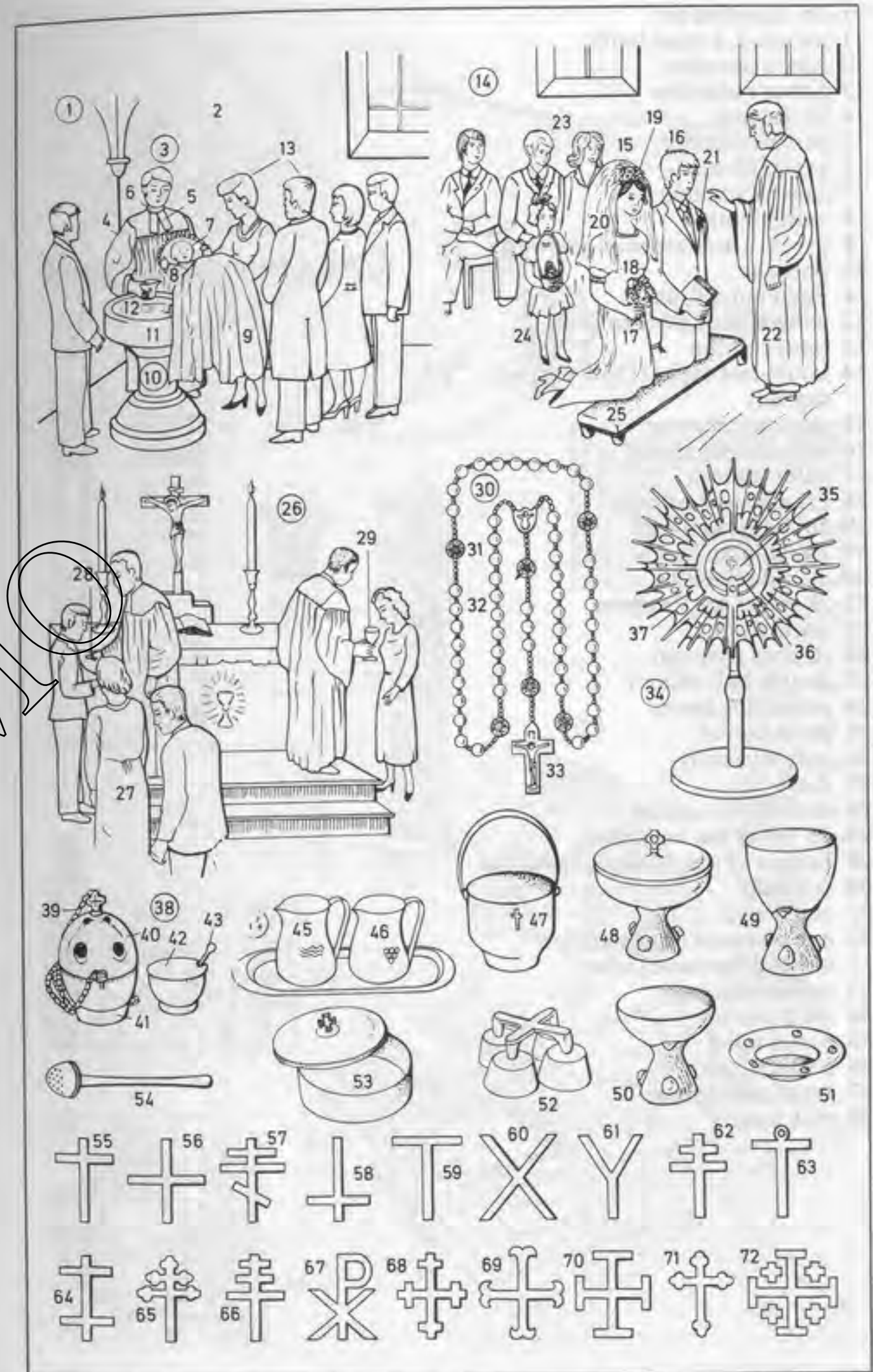

- 1-18 Egyptian art**
 1 pyramid, a royal tomb
 2 king's chamber
 3 queen's chamber
 4 air passage
 5 coffin chamber
 6 pyramid site
 7 funerary temple
 8 valley temple
 9 pylon, a monumental gateway
 10 obelisks
 11 Egyptian sphinx
 12 winged sun disc (sun disk)
 13 lotus column
 14 knob-leaf capital (bud-shaped capital)
 15 papyrus column
 16 bell-shaped capital
 17 palm column
 18 ornamented column
19-20 Babylonian art
 19 Babylonian frieze
 20 glazed relief tile
21-28 art of the Persians
 21 tower tomb
 22 stepped pyramid
 23 double bull column
 24 projecting leaves
 25 palm capital
 26 volute (scroll)
 27 shaft
 28 double bull capital
29-36 art of the Assyrians
 29 Sargon's Palace, palace buildings
 30 city wall
 31 castle wall
 32 temple tower (ziggurat), a stepped (terraced) tower
 33 outside staircase
 34 main portal
 35 portal relief
 36 portal figure
37 art of Asia Minor
 38 rock tomb

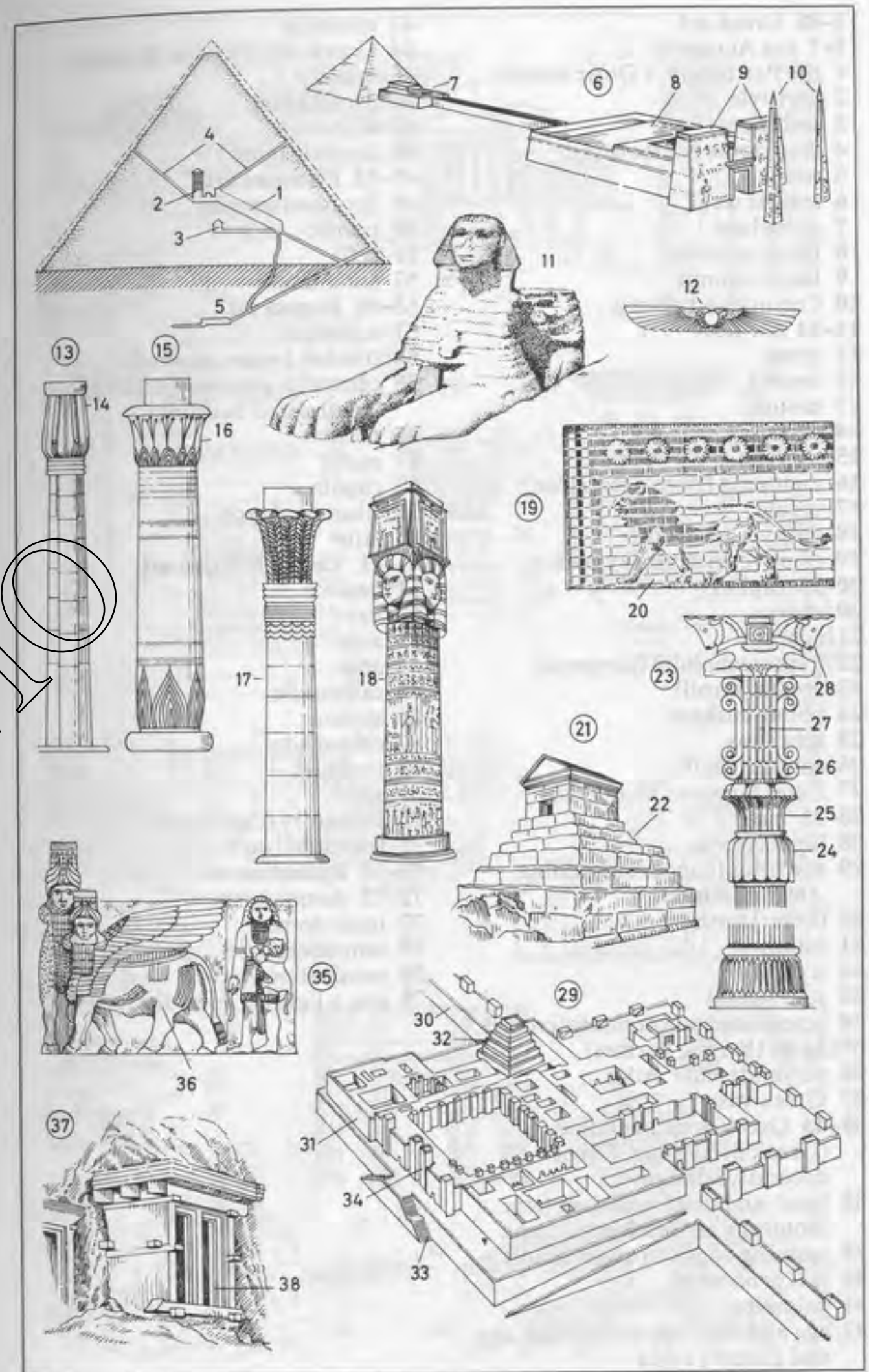

- 1-48 Greek art
 1-7 the Acropolis
 1 the Parthenon, a Doric temple
 2 peristyle
 3 pediment
 4 crepidoma (stereobate)
 5 statue
 6 temple wall
 7 propylaea
 8 Doric column
 9 Ionic column
 10 Corinthian column
 11-14 cornice
 11 cyma
 12 corona
 13 mutule
 14 dentils
 15 triglyph
 16 metope, a frieze decoration
 17 regula
 18 epistyle (architrave)
 19 cyma (cymatium, kymation)
 20-25 capital
 20 abacus
 21 echinus
 22 hypotrachelium (gorgerin)
 23 volute (scroll)
 24 volute cushion
 25 acanthus
 26 column shaft
 27 flutes (grooves, channels)
 28-31 base
 28 [upper] torus
 29 trochilus (concave moulding, *Am.* molding)
 30 [lower] torus
 31 plinth
 32 stylobate
 33 stele (stela)
 34 acroterion (acroterium, acroter)
 35 herm (herma, hermes)
 36 caryatid; *male*: Atlas
 37 Greek vase
 38-43 Greek ornamentation
 (Greek decoration, Greek decorative designs)
 38 bead-and-dart moulding (*Am.* moulding), an ornamental band
 39 running dog (Vitruvian scroll)
 40 leaf ornament
 41 palmette
 42 egg and dart (egg and tongue, egg and anchor) cyma

- 43 meander
 44 Greek theatre (*Am.* theater)
 45 scene
 46 proscenium
 47 orchestra
 48 thymele (altar)
 49-52 Etruscan art
 49 Etruscan temple
 50 portico
 51 cella
 52 entablature
 53-60 Roman art
 53 aqueduct
 54 conduit (water channel)
 55 centrally-planned building (centralized building)
 56 portico
 57 reglet
 58 cupola
 59 triumphal arch
 60 attic
 61-71 Early Christian art
 61 basilica
 62 nave
 63 aisle
 64 apse
 65 campanile
 66 atrium
 67 colonnade
 68 fountain
 69 altar
 70 clerestory (clearstory)
 71 triumphal arch
 72-75 Byzantine art
 72-73 dome system
 72 main dome
 73 semidome
 74 pendentive
 75 eye, a lighting aperture

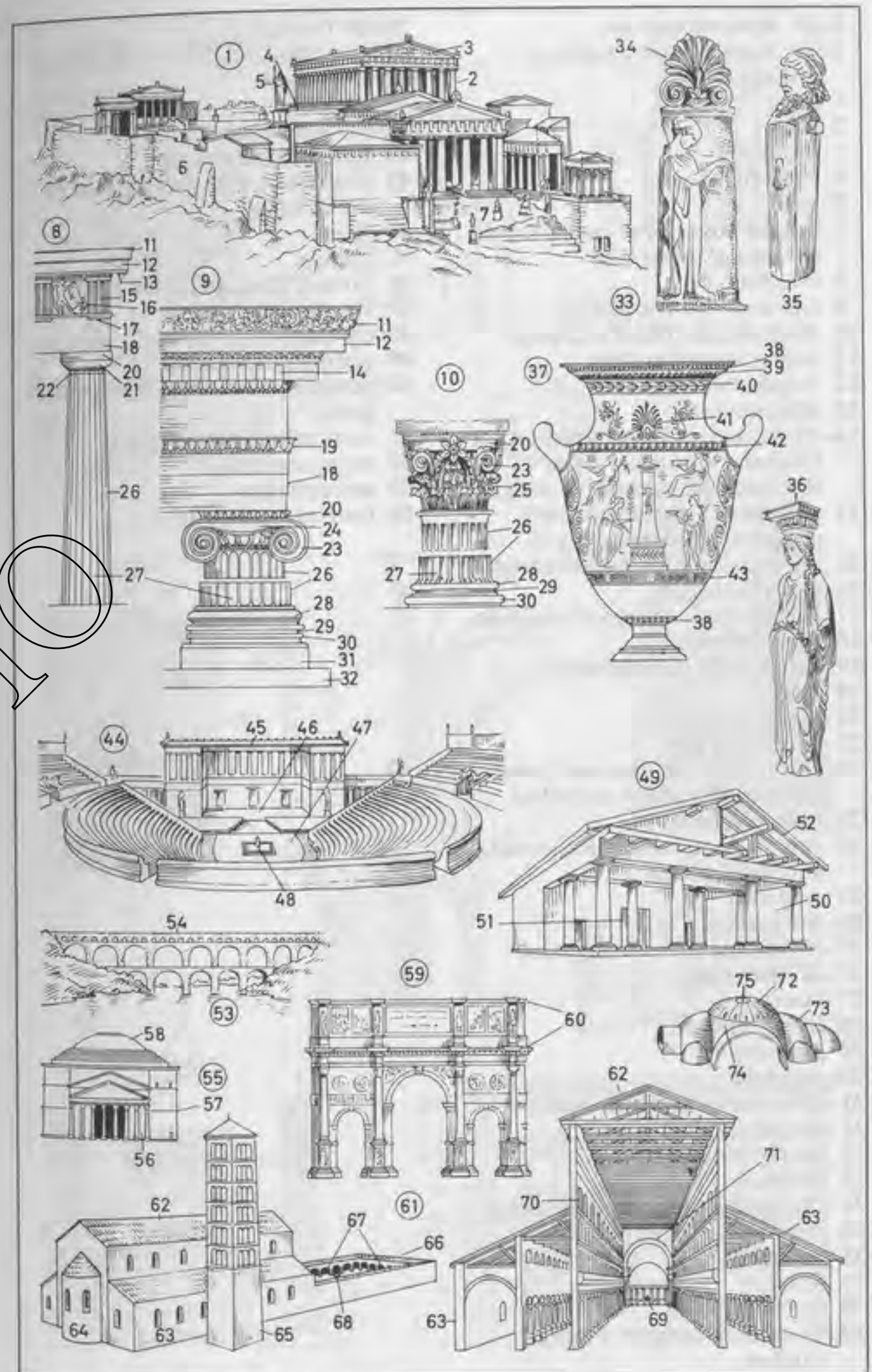

1-21 Romanesque art

1-13 Romanesque church, a cathedral

1 nave

2 aisle

3 transept

4 choir (chancel)

5 apse

6 central tower (*Am.* center tower)

7 pyramidal tower roof

8 arcading

9 frieze of round arcading

10 blind arcade (blind arcading)

11 lesene, a pilaster strip

12 circular window

13 side entrance

14-16 Romanesque ornamentation (Romanesque decoration, Romanesque decorative designs)

14 chequered (*Am.* checkered) pattern (chequered design)

15 imbrication (imbricated design)

16 chevron design

17 Romanesque system of vaulting

18 transverse arch

19 barrel vault (tunnel vault)

20 pillar

21 cushion capital

22-41 Gothic art

22 Gothic church [westwork, west end, west façade], a cathedral

23 rose window

24 church door (main door, portal), a recessed portal

25 archivolt

26 tympanum

27-35 Gothic structural system

27-28 buttresses

27 buttress

28 flying buttress

29 pinnacle

30 gargoyle

31-32 cross vault (groin vault)

31 ribs (cross ribs)

32 boss (pendant)

33 triforium

34 clustered pier (compound pier)

35 respond (engaged pillar)

36 pediment

37 finial

38 crocket

39-41 tracery window, a lancet window

39-40 tracery

39 quatrefoil

40 cinquefoil

41 mullions

42-54 Renaissance art

42 Renaissance church

43 projection, a projecting part of the building

44 drum

45 lantern

46 pilaster (engaged pillar)

47 Renaissance palace

48 cornice

49 pedimental window

50 pedimental window with round gable

51 rustication (rustic work)

52 string course

53 sarcophagus

54 festoon (garland)

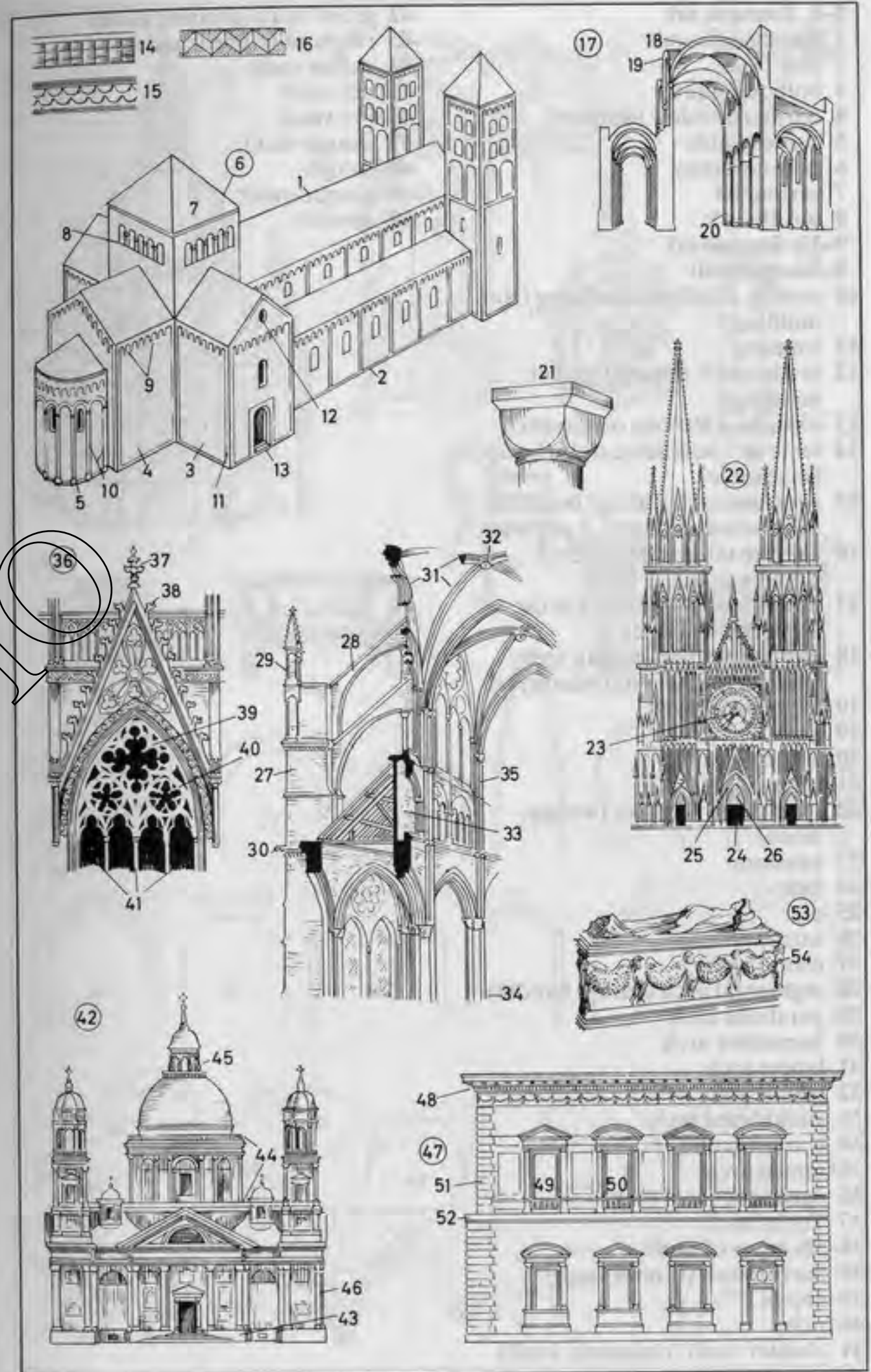

- 1-8 Baroque art
- 1 Baroque church
- 2 bull's eye
- 3 bulbous cupola
- 4 dormer window (dormer)
- 5 curved gable
- 6 twin columns
- 7 cartouche
- 8 scrollwork
- 9-13 Rococo art
- 9 Rococo wall
- 10 coving, a hollow moulding (*Am.* moulding)
- 11 framing
- 12 ornamental moulding (*Am.* moulding)
- 13 rocaille, a Rococo ornament
- 14 table in Louis Seize style (Louis Seize table)
- 15 neoclassical building (building in neoclassical style), a gateway
- 16 Empire table (table in the Empire style)
- 17 Biedermeier sofa (sofa in the Biedermeier style)
- 18 Art Nouveau easy chair (easy chair in the Art Nouveau style)
- 19-37 types of arch
- 19 arch
- 20 abutment
- 21 impost
- 22 springer, a voussoir (wedge stone)
- 23 keystone
- 24 face
- 25 pier
- 26 extrados
- 27 round arch
- 28 segmental arch (basket handle)
- 29 parabolic arch
- 30 horseshoe arch
- 31 lancet arch
- 32 trefoil arch
- 33 shouldered arch
- 34 convex arch
- 35 tented arch
- 36 ogee arch (keel arch)
- 37 Tudor arch
- 38-50 types of vault
- 38 barrel vault (tunnel vault)
- 39 crown
- 40 side
- 41 cloister vault (cloistered vault)
- 42 groin vault (groined vault)
- 43 rib vault (ribbed vault)
- 44 stellar vault
- 45 net vault
- 46 fan vault
- 47 trough vault
- 48 trough
- 49 cavetto vault
- 50 cavetto

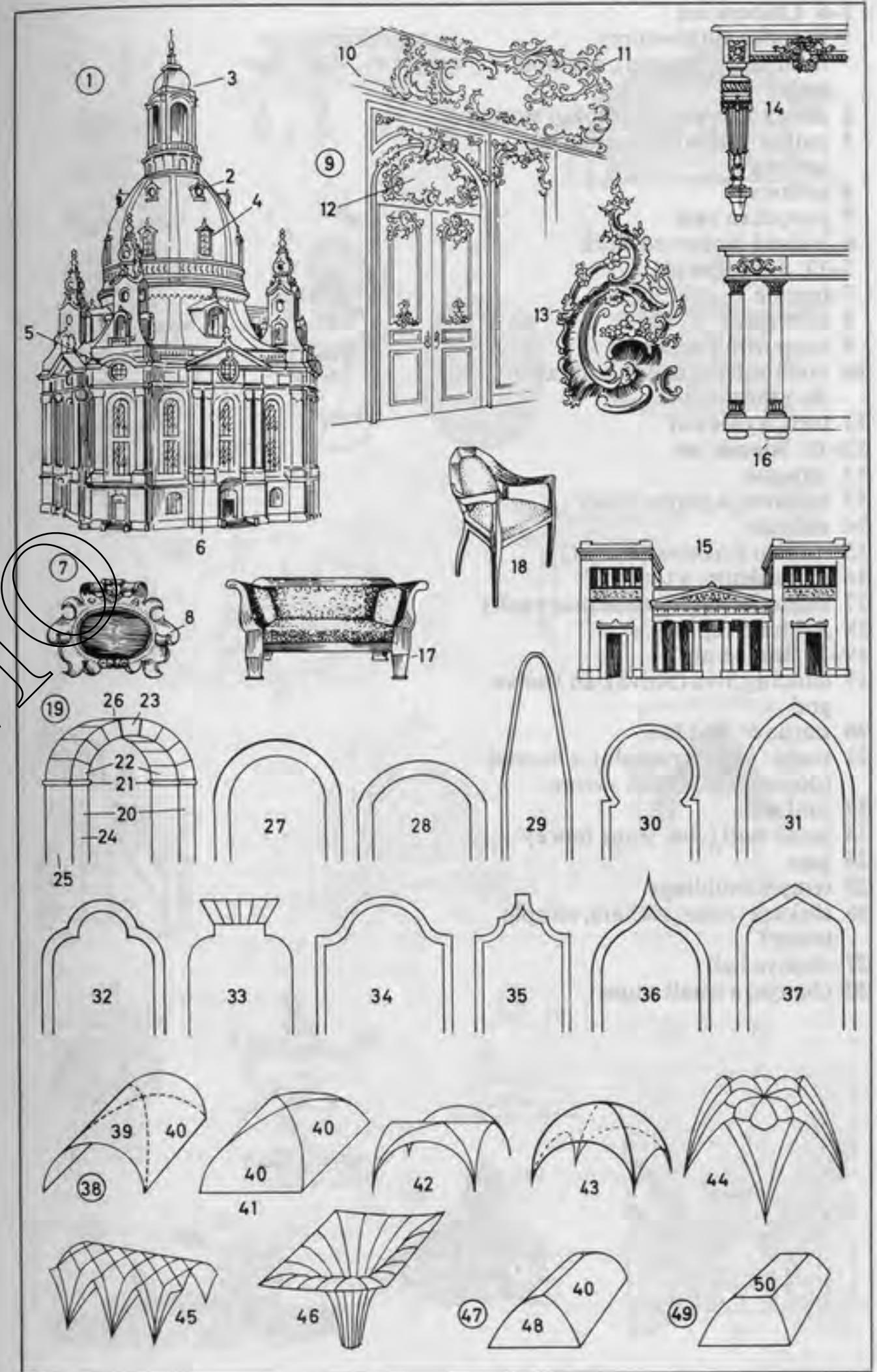

1-6 Chinese art

- 1 pagoda (multi-storey, multistory, pagoda), a temple tower
- 2 storey (story) roof (roof of storey)
- 3 pailou (pailoo), a memorial archway
- 4 archway
- 5 porcelain vase
- 6 incised lacquered work

7-11 Japanese art

- 7 temple
- 8 bell tower
- 9 supporting structure
- 10 bodhisattva (boddhisattva), a Buddhist saint
- 11 torii, a gateway

12-18 Islamic art

- 12 mosque
- 13 minaret, a prayer tower
- 14 mihrab
- 15 minbar (mimbar, pulpit)
- 16 mausoleum, a tomb
- 17 stalactite vault (stalactitic vault)
- 18 Arabian capital

19-28 Indian art

- 19 dancing Siva (Shiva), an Indian god
- 20 statue of Buddha
- 21 stupa (Indian pagoda), a mound (dome), a Buddhist shrine
- 22 umbrella
- 23 stone wall (*Am.* stone fence)
- 24 gate
- 25 temple buildings
- 26 shikara (sikar, sikhara, temple tower)
- 27 chaitya hall
- 28 chaitya, a small stupa



**1-43 studio**

- 1 studio skylight
- 2 painter, an artist
- 3 studio easel
- 4 chalk sketch, a rough draft
- 5 crayon (piece of chalk)
- 6-19 painting materials
- 6 flat brush
- 7 camel hair brush
- 8 round brush
- 9 priming brush
- 10 box of paints (paintbox)
- 11 tube of oil paint
- 12 varnish
- 13 thinner
- 14 palette knife
- 15 spatula
- 16 charcoal pencil (charcoal, piece of charcoal)
- 17 tempera (gouache)
- 18 watercolour (*Am.* watercolor)
- 19 pastel crayon
- 20 wedged stretcher (canvas stretcher)
- 21 canvas
- 22 piece of hardboard, with painting surface
- 23 wooden board
- 24 fibreboard (*Am.* fiberboard)
- 25 painting table
- 26 folding easel
- 27 still life group, a motif
- 28 palette
- 29 palette dipper
- 30 platform
- 31 lay figure (mannequin, manikin)
- 32 nude model (model, nude)
- 33 drapery
- 34 drawing easel
- 35 sketch pad
- 36 study in oils
- 37 mosaic (tessellation)
- 38 mosaic figure
- 39 tesserae
- 40 fresco (mural)
- 41 sgraffito
- 42 plaster
- 43 cartoon



- 1 sculptor
- 2 proportional dividers
- 3 calliper (caliper)
- 4 plaster model, a plaster cast
- 5 block of stone (stone block)
- 6 modeller (*Am.* modeler)
- 7 clay figure, a torso
- 8 roll of clay, a modelling (*Am.* modeling) substance
- 9 modelling (*Am.* modeling) stand
- 10 wooden modelling (*Am.* modeling) tool
- 11 wire modelling (*Am.* modeling) tool
- 12 beating wood
- 13 claw chisel (toothed chisel, tooth chisel)
- 14 flat chisel
- 15 point (punch)
- 16 iron-headed hammer
- 17 gouge (hollow chisel)
- 18 spoon chisel
- 19 wood chisel, a bevelled-edge chisel
- 20 V-shaped gouge
- 21 mallet
- 22 framework
- 23 baseboard
- 24 armature support (metal rod)
- 25 armature
- 26 wax model
- 27 block of wood
- 28 wood carver (wood sculptor)
- 29 sack of gypsum powder (gypsum)
- 30 clay box
- 31 modelling (*Am.* modeling) clay (clay)
- 32 statue, a sculpture
- 33 low relief (bas-relief)
- 34 modelling (*Am.* modeling) board
- 35 wire frame, wire netting
- 36 circular medallion (tondo)
- 37 mask
- 38 plaque





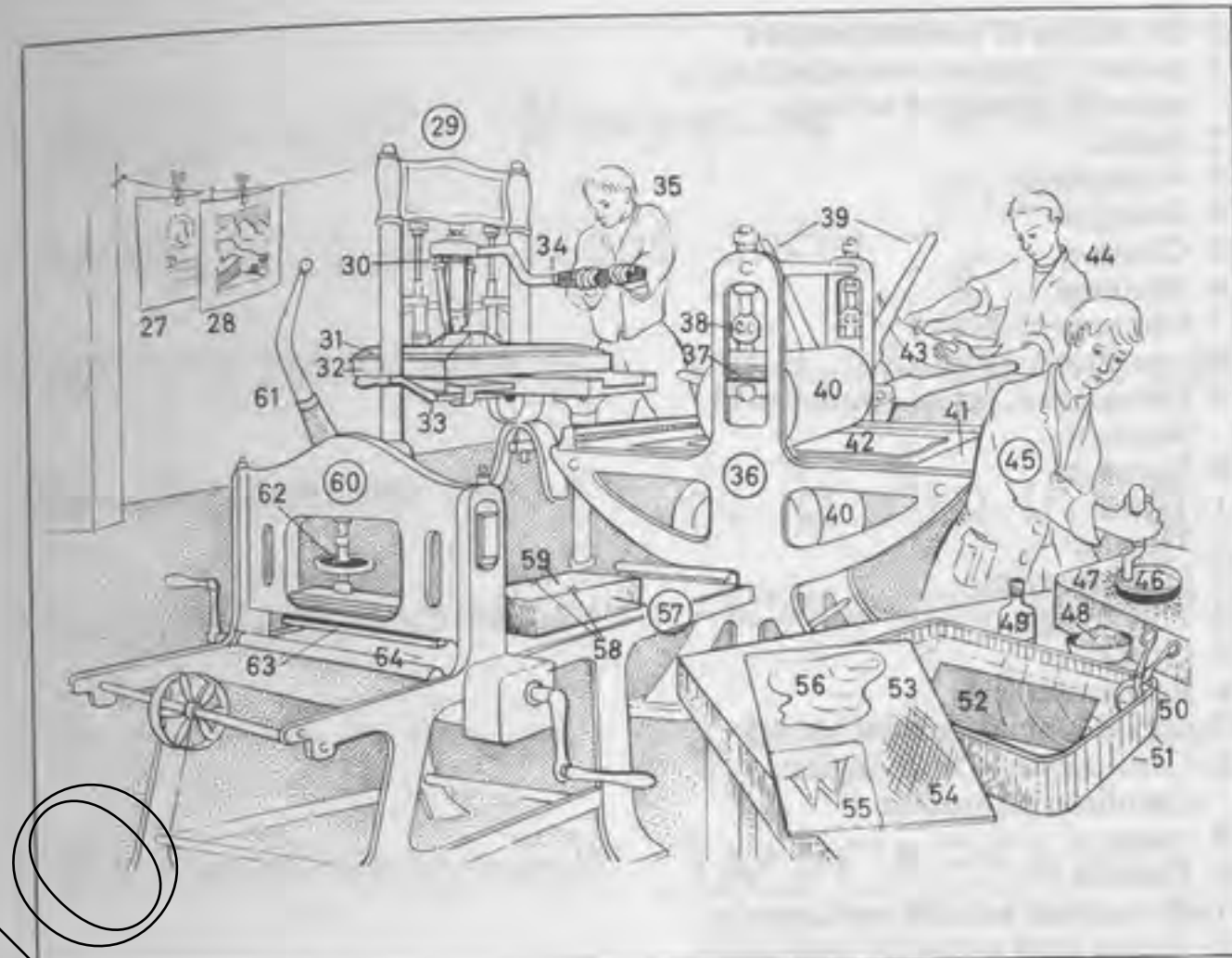

- 1-13 wood engraving (xylography), a relief printing method (a letterpress printing method)**
- 1 end-grain block for wood engravings, a wooden block
 - 2 wooden plank for woodcutting, a relief image carrier
 - 3 positive cut
 - 4 plank cut
 - 5 burin (graver)
 - 6 U-shaped gouge
 - 7 scorper (scauper, scalper)
 - 8 scoop
 - 9 V-shaped gouge
 - 10 contour knife
 - 11 brush
 - 12 roller (brayer)
 - 13 pad (wiper)
- 14-24 copperplate engraving (chalcography), an intaglio process; kinds: etching, mezzotint, aquatint, crayon engraving**
- 14 hammer
 - 15 burin
 - 16 etching needle (engraver)
 - 17 scraper and burnisher
 - 18 roulette
 - 19 rocking tool (rocker)
 - 20 round-headed graver, a graver (burin)
 - 21 oilstone
 - 22 dabber (inking ball, ink ball)
 - 23 leather roller
 - 24 sieve
- 25-26 lithography (stone lithography), a planographic printing method**
- 25 sponge for moistening the lithographic stone
 - 26 lithographic crayons (greasy chalk)
- 27-64 graphic art studio, a printing office (Am. printery)**
- 27 broadside (broadsheet, single sheet)
 - 28 full-colour (Am. full-color) print (colour print, chromolithograph)
 - 29 platen press, a hand press
 - 30 toggle
 - 31 platen
 - 32 type forme (Am. form)

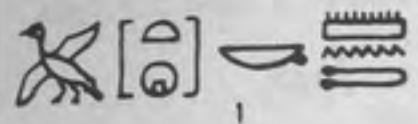
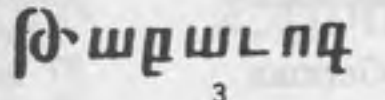

- 33 feed mechanism
- 34 bar (devil's tail)
- 35 pressman
- 36 copperplate press
- 37 tympan
- 38 pressure regulator
- 39 star wheel
- 40 cylinder
- 41 bed
- 42 felt cloth
- 43 proof (pull)
- 44 copperplate engraver
- 45 lithographer (litho artist), grinding the stone
- 46 grinding disc (disk)
- 47 grain (granular texture)
- 48 pulverized glass
- 49 rubber solution
- 50 tongs
- 51 etching bath for etching
- 52 zinc plate
- 53 polished copperplate
- 54 cross hatch
- 55 etching ground
- 56 non-printing area
- 57 lithographic stone
- 58 register marks
- 59 printing surface (printing image carrier)
- 60 lithographic press
- 61 lever
- 62 scraper adjustment
- 63 scraper
- 64 bed

1-20 scripts of various peoples

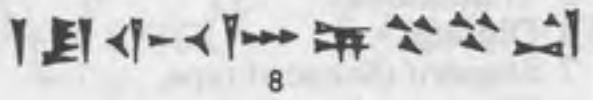
- 1 ancient Egyptian hieroglyphics, a pictorial system of writing
- 2 Arabic
- 3 Armenian
- 4 Georgian
- 5 Chinese
- 6 Japanese
- 7 Hebrew (Hebraic)
- 8 cuneiform script
- 9 Devanagari, script employed in Sanskrit
- 10 Siamese
- 11 Tamil
- 12 Tibetan
- 13 Sinitic script
- 14 Phoenician
- 15 Greek
- 16 Roman capitals
- 17 uncial (uncials, uncial script)
- 18 Carolingian (Carlovingian, Caroline) minuscule
- 19 runes
- 20 Russian
- 21-26 ancient writing implements
- 21 Indian steel stylus for writing on palm leaves
- 22 ancient Egyptian reed pen
- 23 writing cane
- 24 brush
- 25 Roman metal pen (stylus)
- 26 quill (quill pen)
- 27 Korean

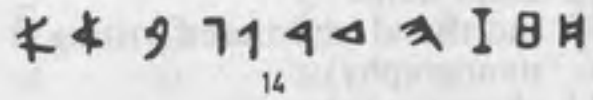
 <p>1</p>	 <p>3</p>	<p>圖書館 } 图书馆 } 新しい 6</p>
<p>انصف بالشجاعة اما</p> <p>2</p>	<p>ბაბიბ 306</p> <p>4</p>	<p>5</p>
 <p>7</p>	 <p>8</p>	<p>6</p>
<p>वेत्त चित्तमन्तरकाया अरिग-</p> <p>9</p>	<p>ຍੰ ໄ ເກືອນ ເກົາ ລຸບ</p> <p>10</p>	<p>7</p>
<p>உறிரண்ணியவாமின்</p> <p>11</p>	<p>རས་མ་ཉམས་བ་སྐྱ་མེད་པ་</p> <p>12</p>	<p>8</p>
 <p>13</p>	 <p>14</p>	<p>9</p>
<p>Τῆς παρελθούσης νυκτὸ</p> <p>15</p>	<p>IMPCAESARI·</p> <p>16</p>	<p>10</p>
<p>ΜΙΝΗΣΥΕΝΙΕ</p> <p>17</p>	<p>addiem festum</p> <p>18</p>	<p>11</p>
<p>КНРПН: РНПРПРПРПРПРП</p> <p>19</p>	<p>Кожух генератора и</p> <p>20</p>	<p>12</p>
<p>책입니다 27</p>		<p>13</p>

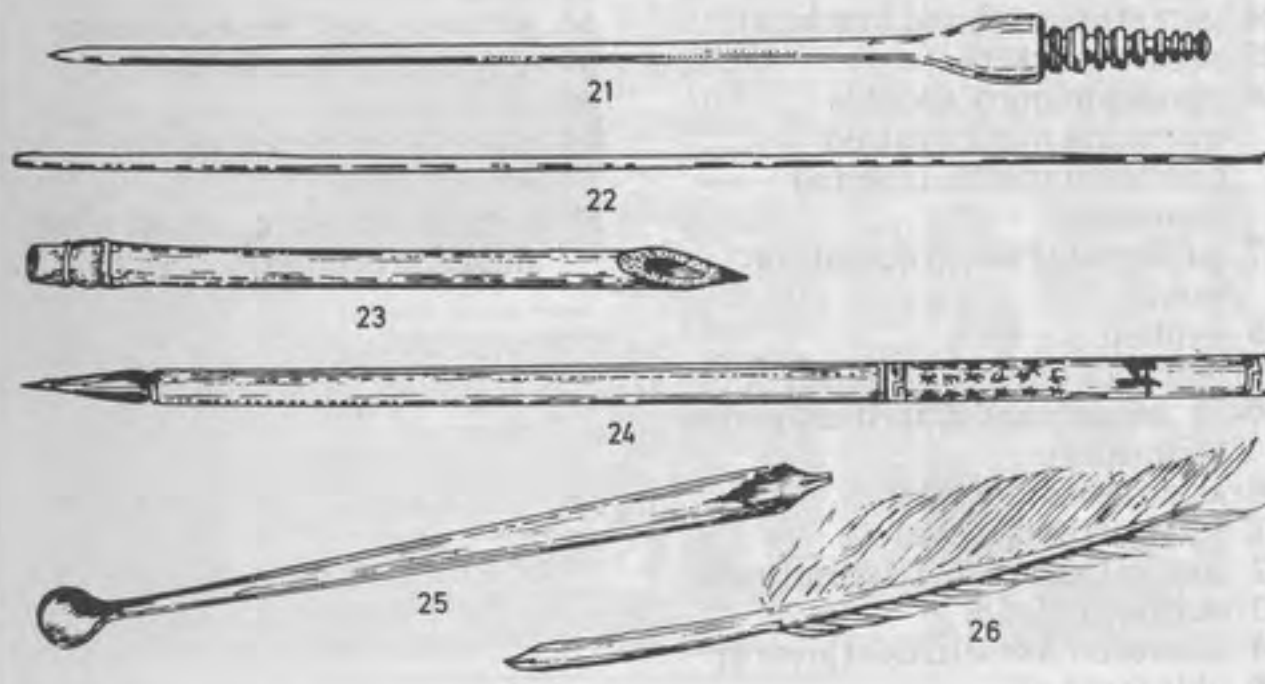

- 1-15 types (type faces)
- 1 Gothic type (German black-letter type)
 - 2 Schwabacher type (German black-letter type)
 - 3 Fraktur (German black-letter type)
 - 4 Humanist (Mediaeval)
 - 5 Transitional
 - 6 Didone
 - 7 Sanserif (Sanserif type, Grotesque)
 - 8 Egyptian
 - 9 typescript (typewriting)
 - 10 English hand (English handwriting, English writing)
 - 11 German hand (German handwriting, German writing)
 - 12 Latin script
 - 13 shorthand (shorthand writing, stenography)
 - 14 phonetics (phonetic transcription)
 - 15 Braille
- 16-29 punctuation marks (stops)
- 16 full stop (period, full point)
 - 17 colon
 - 18 comma
 - 19 semicolon
 - 20 question mark (interrogation point, interrogation mark)
 - 21 exclamation mark (*Am.* exclamation point)
 - 22 apostrophe
 - 23 dash (em rule)
 - 24 parentheses (round brackets)
 - 25 square brackets
 - 26 quotation mark (double quotation marks, paired quotation marks, inverted commas)
 - 27 guillemet (French quotation mark)
 - 28 hyphen
 - 29 marks of omission (ellipsis)
- 30-35 accents and diacritical marks (diacritics)
- 30 acute accent (acute)
 - 31 grave accent (grave)
 - 32 circumflex accent (circumflex)
 - 33 cedilla [under c]
 - 34 diaeresis (*Am.* dieresis) [over e]
 - 35 tilde [over n]
- 36 section mark
 - 37-70 newspaper, a national daily newspaper
 - 37 newspaper page
 - 38 front page
 - 39 newspaper heading
 - 40 contents
 - 41 price
 - 42 date of publication
 - 43 place of publication
 - 44 headline
 - 45 column
 - 46 column heading
 - 47 column rule
 - 48 leading article (leader, editorial)
 - 49 reference to related article
 - 50 brief news item
 - 51 political section
 - 52 page heading
 - 53 cartoon
 - 54 report by newspaper's own correspondent
 - 55 news agency's sign
 - 56 advertisement (*coll. ad*)
 - 57 sports section
 - 58 press photo
 - 59 caption
 - 60 sports report
 - 61 sports news item
 - 62 home and overseas news section
 - 63 news in brief (miscellaneous news)
 - 64 television programmes (*Am.* programs)
 - 65 weather report
 - 66 weather chart (weather map)
 - 67 arts section (feuilleton)
 - 68 death notice
 - 69 advertisements (classified advertising)
 - 70 job advertisement, a vacancy (a situation offered)



- 1 red
- 2 yellow
- 3 blue
- 4 pink
- 5 brown
- 6 azure (sky blue)
- 7 orange
- 8 green
- 9 violet
- 10 additive mixture of colours (*Am. colors*)
- 11 white
- 12 subtractive mixture of colours (*Am. colors*)
- 13 black
- 14 solar spectrum (colours, *Am. colors*, of the rainbow)
- 15 grey (*Am. gray*) scale
- 16 heat colours (*Am. colors*)

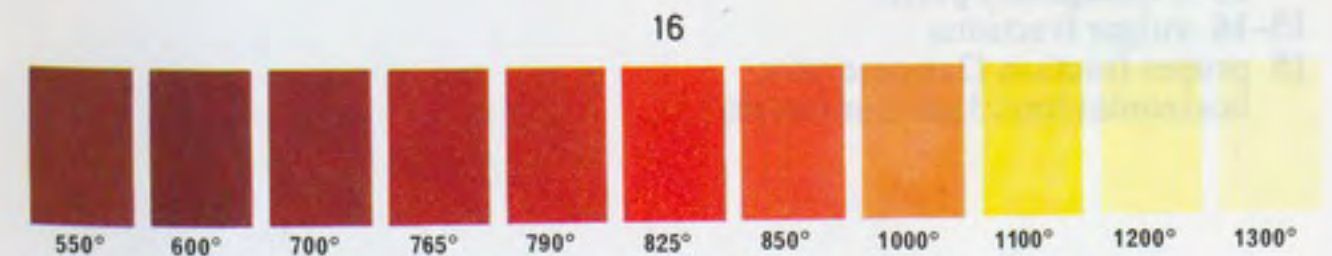
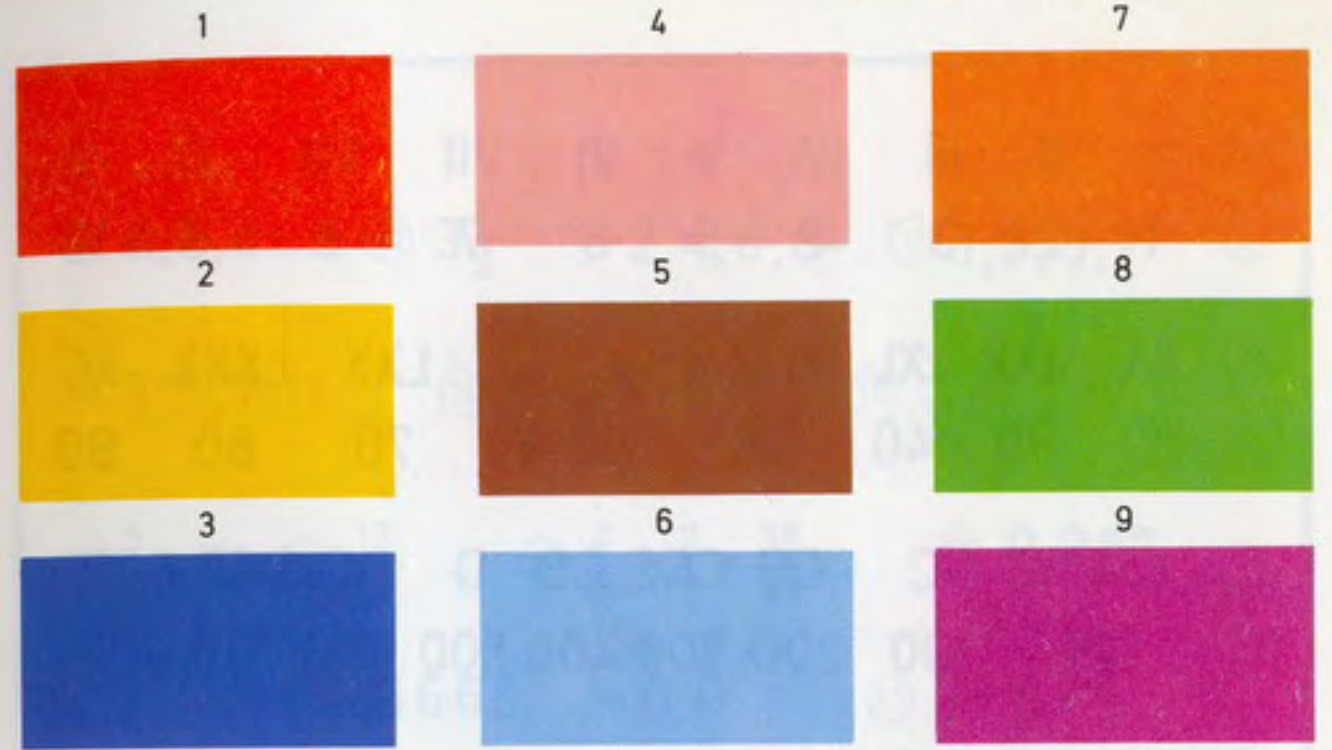

550° 600° 700° 765° 790° 825° 850° 1000° 1100° 1200° 1300°

① I II III IV V VI VII VIII IX X
 ② 1 2 3 4 5 6 7 8 9 10

① XX XXX XL XLIX IL L LX LXX LXXX XC
 ② 20 30 40 49 50 60 70 80 90

① XCIX IC C CC CCC CD D DC DCC DCCC
 ② 99 100 200 300 400 500 600 700 800

① CM CMXC M
 ② 900 990 1000

③ 9658 ④ 5 kg. ⑤ 2 ⑥ 2nd ⑦ +5 ⑧ -5

⑨ a, b, c ... ⑩ $3\frac{1}{3}$ ⑪ 2, 4, 6, 8 ⑫ 1, 3, 5, 7

⑬ 3, 5, 7, 11 ⑭ $3+2\sqrt{-1}$ ⑮ $\frac{2}{3}$ ⑯ $\frac{3}{2}$

⑰ $\frac{5}{6}$ ⑱ $\frac{12}{4}$ ⑲ $\frac{4}{5} + \frac{2}{7} = \frac{38}{35}$ ⑳ 0.357

⑳ 0.357 ㉑ $0.6666\dots = 0.\bar{6}$ ㉒ $3+2=5$

㉓ $3-2=1$ ㉔ $3 \cdot 2 = 6$ ㉕ $6 \div 2 = 3$
 $3 \times 2 = 6$

1-26 arithmetic**1-22 numbers**

- 1 Roman numerals
 2 Arabic numerals
 3 abstract number, a four-figure number [8: units; 5: tens; 6: hundreds; 9: thousands]
 4 concrete number
 5 cardinal number (cardinal)
 6 ordinal number (ordinal)
 7 positive number [with plus sign]
 8 negative number [with minus sign]
 9 algebraic symbols
 10 mixed number [3: whole number (integer); $\frac{1}{3}$: fraction]
 11 even numbers
 12 odd numbers
 13 prime numbers
 14 complex number [3: real part; $2\sqrt{-1}$: imaginary part]
 15-16 vulgar fractions
 15 proper fraction [2: numerator, horizontal line; 3: denominator]

- 16 improper fraction, also the reciprocal of item 15
 17 compound fraction (complex fraction)
 18 improper fraction [when cancelled down produces a whole number]
 19 fractions of different denominations [35: common denominator]
 20 proper decimal fraction with decimal point and decimal places [3: tenths; 5: hundredths; 7: thousandths]
 21 recurring decimal
 22 recurring decimal

23-26 fundamental arithmetical operations

- 23 addition (adding) [3 and 2: the terms of the sum; +: plus sign; =: equals sign; 5: the sum]
 24 subtraction (subtracting); [3: the minuend; -: minus sign; 2: the subtrahend; 1: the remainder (difference)]
 25 multiplication (multiplying); [3: the multiplicand; \times : multiplication sign; 2: the multiplier; 2 and 3: factors; 6: the product]
 26 division (dividing); [6: the dividend; \div : division sign; 2: the divisor; 3: the quotient]

$$\begin{array}{lll} \textcircled{1} 3^2 = 9 & \textcircled{2} \sqrt[3]{8} = 2 & \textcircled{3} \sqrt{4} = 2 \\ & \textcircled{4} 3x + 2 = 12 & \\ & & \textcircled{6} \\ \textcircled{5} 4a + 6ab - 2ac = 2a(2 + 3b - c) & \log_{10} 3 = 0.4771 & \\ & & \\ \textcircled{7} \frac{P[\pounds 1000] \times R[5\%] \times T[2 \text{ years}]}{100} = I[\pounds 100] & & \end{array}$$

$$\begin{array}{ll} 2 \text{ years @ } \pounds 50 & \textcircled{11} 2 + 4 + 6 + 8 \dots \\ \textcircled{8} \frac{4 \text{ years @ } \pounds x}{2 : 50 = 4 : x} & \textcircled{12} 2 + 4 + 8 + 16 + 32 \dots \quad \textcircled{13} \frac{dy}{dx} \\ \textcircled{9} & \textcircled{10} x = \pounds 100 \quad \int ax dx = a \int x dx = \frac{ax^2}{2} + C \\ \textcircled{15} \infty & \textcircled{16} \equiv & \textcircled{17} \approx & \textcircled{18} \neq & \textcircled{19} > \\ \textcircled{20} < & \textcircled{21} \parallel & \textcircled{22} \sim & \textcircled{23} \sphericalangle & \textcircled{24} \triangle \end{array}$$

1-24 arithmetic**1-10 advanced arithmetical operations**

- 1 raising to a power [three squared (3^2): the power; 3: the base; 2: the exponent (index); 9: value of the power]
 2 evolution (extracting a root); [cube-root of 8: cube root; 8: the radical; 3: the index (degree) of the root; $\sqrt{\quad}$: radical sign; 2: value of the root]
 3 square root
 4-5 algebra
 4 simple equation [3, 2: the coefficients; x: the unknown quantity]
 5 identical equation; [a, b, c: algebraic symbols]
 6 logarithmic calculation (taking the logarithm, log); [log: logarithm sign; 3: number whose logarithm is required; 10: the base; 0: the characteristic; 4771: the mantissa; 0.4771: the logarithm]

- 7 simple interest formula; [P: the principal; R: rate of interest; T: time; I: interest (profit); %: percentage sign]
 8-10 rule of three (rule-of-three sum, simple proportion)
 8 statement with the unknown quantity x
 9 equation (conditional equation)
 10 solution
11-14 higher mathematics
 11 arithmetical series with the elements 2, 4, 6, 8
 12 geometrical series
13-14 infinitesimal calculus
 13 derivative [dx, dy: the differentials; d: differential sign]
 14 integral (integration); [x: the variable; C: constant of integration; S: the integral sign; dx: the differential]

15-24 mathematical symbols

- 15 infinity
 16 identically equal to (the sign of identity)
 17 approximately equal to
 18 unequal to
 19 greater than
 20 less than
21-24 geometrical symbols
 21 parallel (sign of parallelism)
 22 similar to (sign of similarity)
 23 angle symbol
 24 triangle symbol

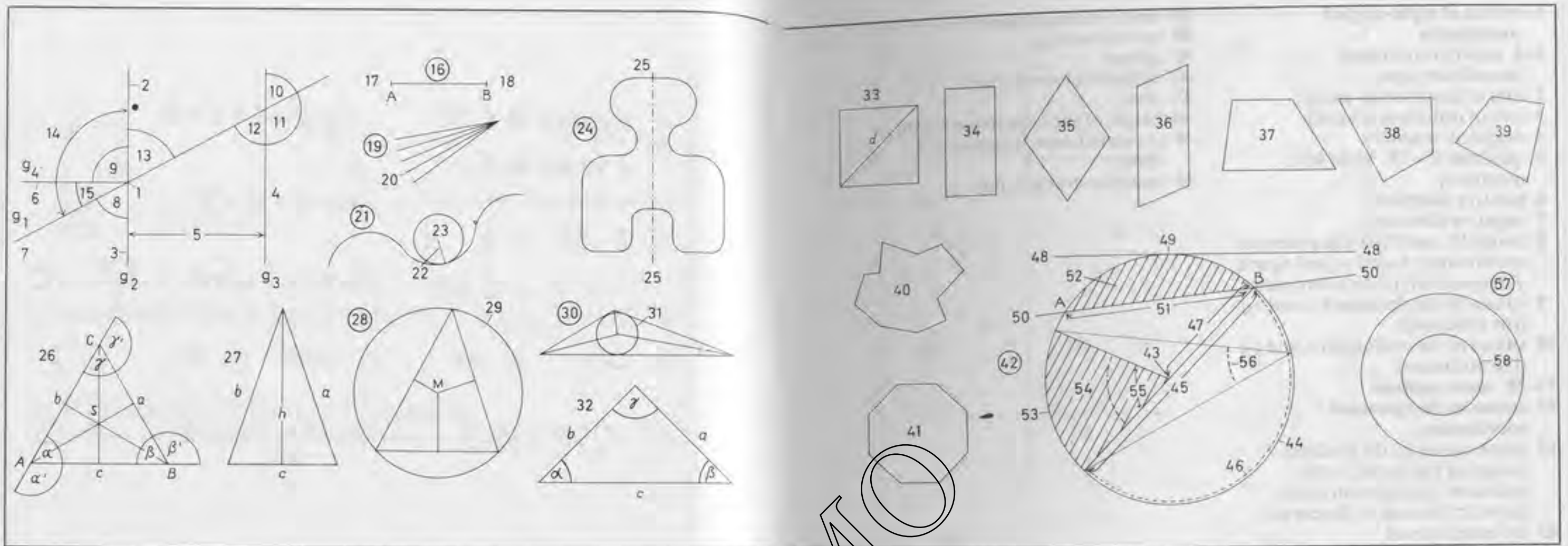

1-58 plane geometry (elementary geometry, Euclidian geometry)

1-23 point, line, angle

- 1 point [point of intersection of g_1 and g_2], the angular point of 8
- 2, 3 straight line g_2
- 4 the parallel to g_2
- 5 distance between the straight lines g_2 and g_3
- 6 perpendicular (g_4) on g_2
- 7, 3 the arms of 8
- 8, 13 vertically opposite angles
- 8 angle
- 9 right angle [90°]
- 10, 11, 12 reflex angle
- 10 acute angle, also the alternate angle to 8
- 11 obtuse angle
- 12 corresponding angle to 8
- 13, 9, 15 straight angle [180°]
- 14 adjacent angle; *here*: supplementary angle to 13
- 15 complementary angle to 8
- 16 straight line AB
- 17 end A

- 18 end B
- 19 pencil of rays
- 20 ray
- 21 curved line
- 22 radius of curvature
- 23 centre (*Am. center*) of curvature

24-58 plane surfaces

- 24 symmetrical figure
- 25 axis of symmetry
- 26-32 plane triangles**
- 26 equilateral triangle; [A, B, C: the vertices; a, b, c: the sides; α (alpha), β (beta), γ (gamma): the interior angles; α' , β' , γ' : the exterior angles; S: the centre (*Am. center*)]
- 27 isocles triangle [a, b: the sides (legs); c: the base; h: the perpendicular, an altitude]
- 28 acute-angled triangle with perpendicular bisectors of the sides
- 29 circumcircle (circumscribed circle)

- 30 obtuse-angled triangle with bisectors of the angles
- 31 inscribed circle
- 32 right-angled triangle and the trigonometrical functions of angles; [a, b: the catheti; c: the hypotenuse; γ : the right angle; $\frac{a}{c} = \sin \alpha$ (sine); $\frac{b}{c} = \cos \alpha$ (cosine); $\frac{a}{b} = \tan \alpha$ (tangent); $\frac{b}{a} = \cot \alpha$ (cotangent)]

33-39 quadrilaterals

- 33-36 parallelograms
- 33 square [d: a diagonal]
- 34 rectangle
- 35 rhombus (rhomb, lozenge)
- 36 rhomboid
- 37 trapezium
- 38 deltoid (kite)
- 39 irregular quadrilateral
- 40 polygon
- 41 regular polygon
- 42 circle
- 43 centre (*Am. center*)
- 44 circumference (periphery)
- 45 diameter

- 46 semicircle
- 47 radius (r)
- 48 tangent
- 49 point of contact (P)
- 50 secant
- 51 the chord AB
- 52 segment
- 53 arc
- 54 sector
- 55 angle subtended by the arc at the centre (*Am. center*) (centre, *Am. center*, angle)
- 56 circumferential angle
- 57 ring (annulus)
- 58 concentric circles

- 1 system of right-angled coordinates
- 2-3 axes of coordinates (coordinate axes)
- 2 axis of abscissae (x-axis)
- 3 axis of ordinates (y-axis)
- 4 origin of ordinates
- 5 quadrant [I - IV: 1st to 4th quadrant]
- 6 positive direction
- 7 negative direction
- 8 points $[P_1$ and $P_2]$ in the system of coordinates; x_1 and y_1 [and x_2 and y_2 respectively] their coordinates
- 9 values of the abscissae [x_1 and x_2] (the abscissae)
- 10 values of the ordinates [y_1 and y_2] (the ordinates)
- 11-29 conic sections
- 11 curves in the system of coordinates
- 12 plane curves [a: the gradient (slope) of the curve; b: the ordinates' intersection of the curve; c: the root of the curve]
- 13 inflected curves
- 14 parabola, a curve of the second degree
- 15 branches of the parabola
- 16 vertex of the parabola
- 17 axis of the parabola
- 18 a curve of the third degree
- 19 maximum of the curve
- 20 minimum of the curve
- 21 point of inflexion (of inflection)
- 22 ellipse
- 23 transverse axis (major axis)
- 24 conjugate axis (minor axis)
- 25 foci of the ellipse [F_1 and F_2]
- 26 hyperbola
- 27 foci [F_1 and F_2]
- 28 vertices [S_1 and S_2]
- 29 asymptotes [a and b]
- 30-46 solids
- 30 cube
- 31 square, a plane (plane surface)
- 32 edge
- 33 corner
- 34 quadratic prism
- 35 base
- 36 parallelepiped
- 37 triangular prism
- 38 cylinder, a right cylinder
- 39 base, a circular plane
- 40 curved surface
- 41 sphere
- 42 ellipsoid of revolution
- 43 cone
- 44 height of the cone (cone height)
- 45 truncated cone (frustum of a cone)
- 46 quadrilateral pyramid

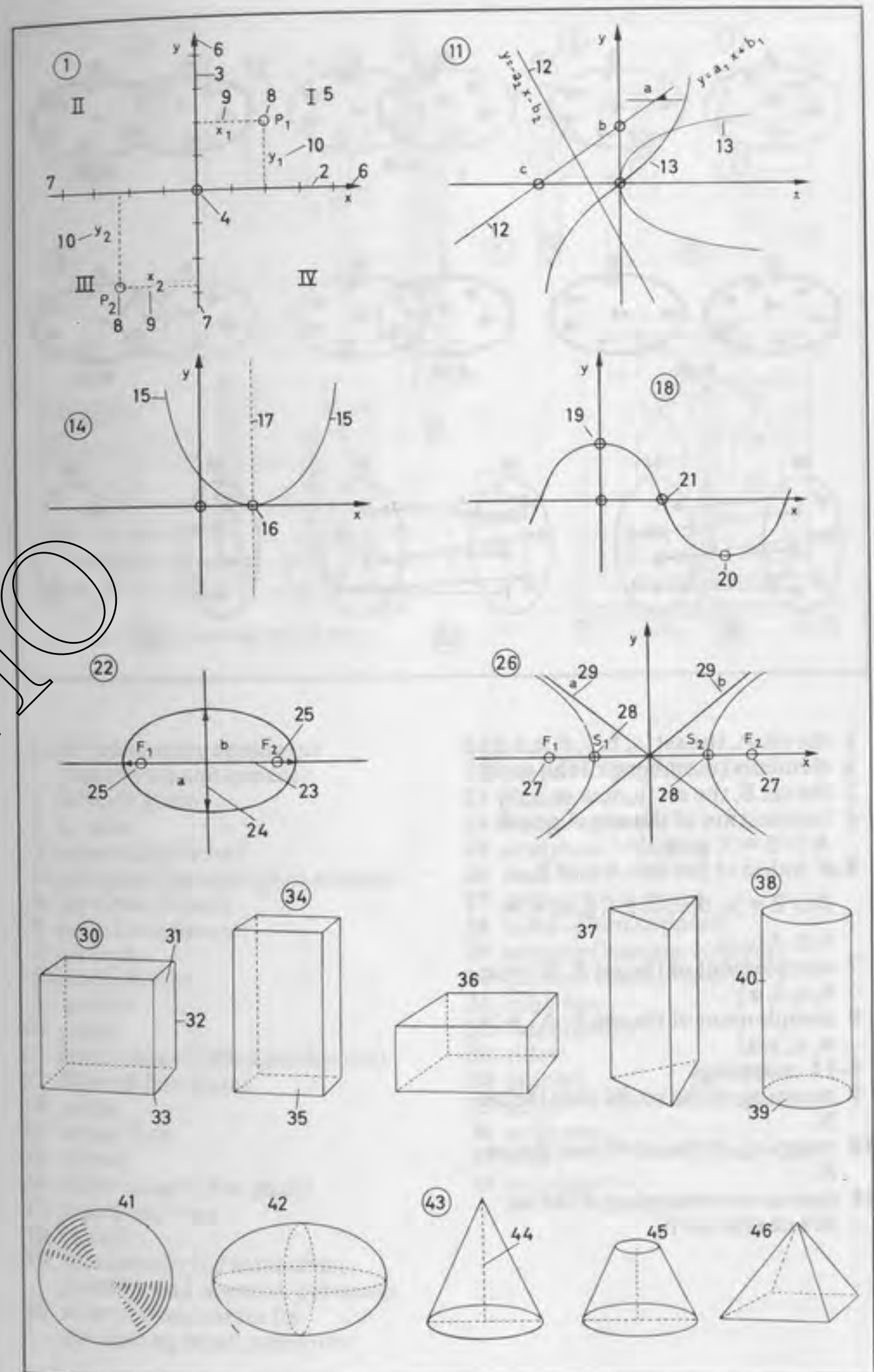

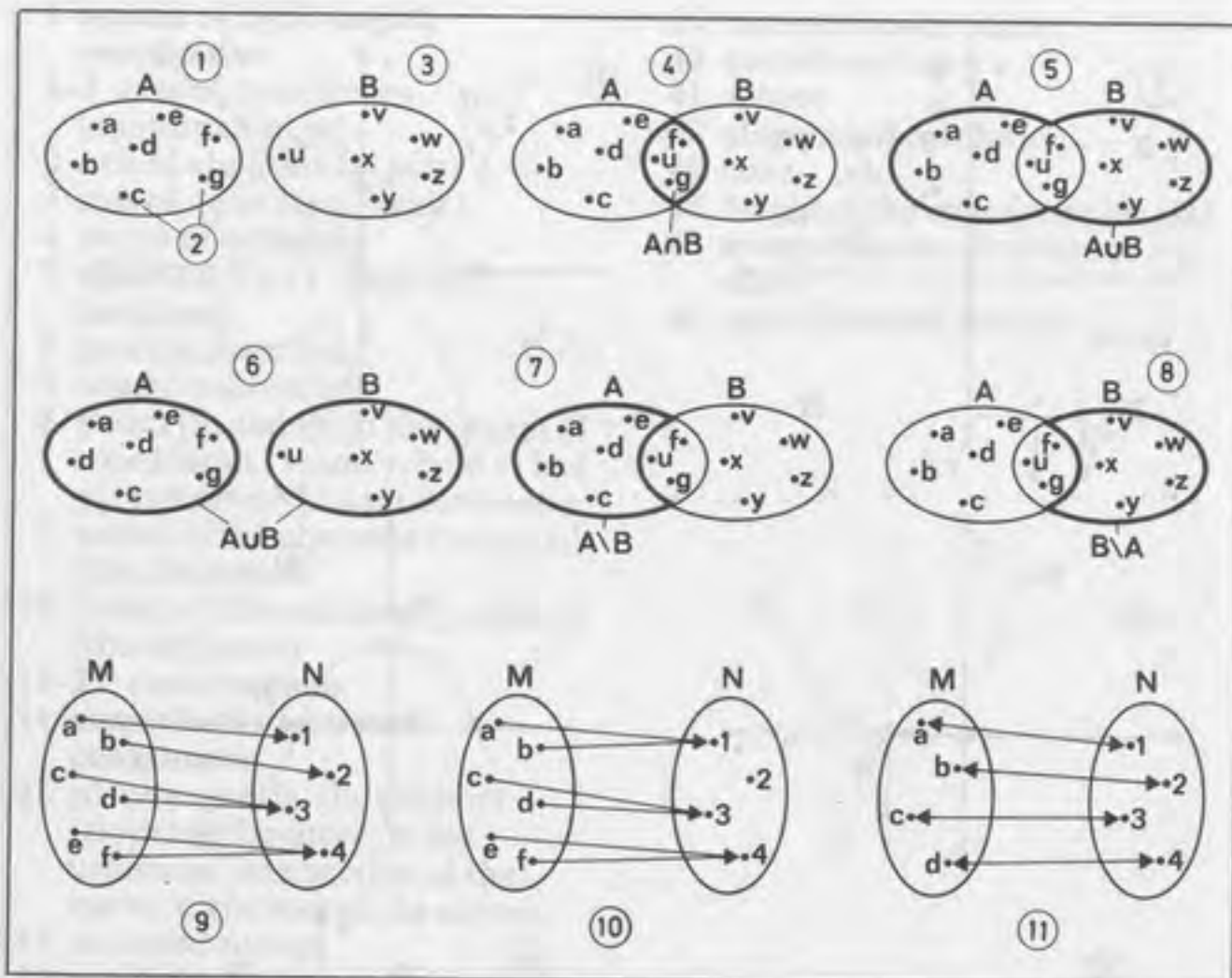

- 1 the set A, the set $\{a, b, c, d, e, f, g\}$
- 2 elements (members) of the set A
- 3 the set B, the set $\{u, v, w, x, y, z\}$
- 4 intersection of the sets A and B,
 $A \cap B = \{f, g, u\}$
- 5-6 union of the sets A and B,
 $A \cup B = \{a, b, c, d, e, f, g, u, v, w, x, y, z\}$
- 7 complement of the set B, $B^c = \{a, b, c, d, e\}$
- 8 complement of the set A, $A^c = \{v, w, x, y, z\}$
- 9-11 mappings
- 9 mapping of the set M onto the set N
- 10 mapping of the set M into the set N
- 11 one-to-one mapping of the set M onto the set N

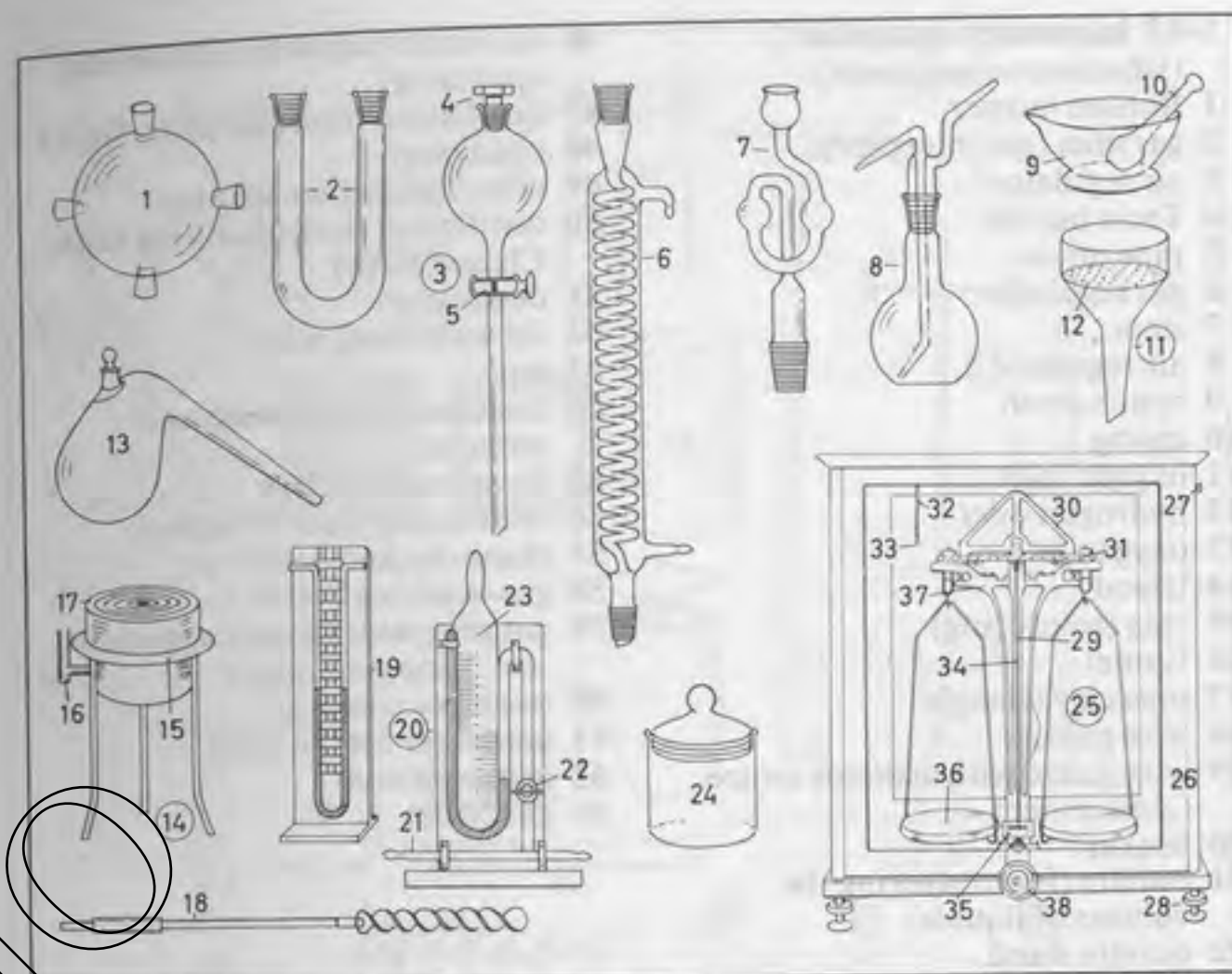

1-38 laboratory apparatus (laboratory equipment)

- 1 Scheidt globe
- 2 U-tube
- 3 separating funnel
- 4 octagonal ground-glass stopper
- 5 tap (Am. faucet)
- 6 coiled condenser
- 7 air lock
- 8 wash-bottle
- 9 mortar
- 10 pestle
- 11 filter funnel (Büchner funnel)
- 12 filter (filter plate)
- 13 retort
- 14 water bath
- 15 tripod
- 16 water gauge (Am. gage)
- 17 insertion rings
- 18 stirrer
- 19 manometer for measuring positive and negative pressures
- 20 mirror manometer for measuring small pressures
- 21 inlet
- 22 tap (Am. faucet)
- 23 sliding scale
- 24 weighing bottle
- 25 analytical balance
- 26 case
- 27 sliding front panel
- 28 three-point support
- 29 column (balance column)
- 30 balance beam (beam)
- 31 rider bar
- 32 rider holder
- 33 rider
- 34 pointer
- 35 scale
- 36 scale pan
- 37 stop
- 38 stop knob

1-63 laboratory apparatus
(laboratory equipment)

- 1 Bunsen burner
- 2 gas inlet (gas inlet pipe)
- 3 air regulator
- 4 Teclu burner
- 5 pipe union
- 6 gas regulator
- 7 stem
- 8 air regulator
- 9 bench torch
- 10 casing
- 11 oxygen inlet
- 12 hydrogen inlet
- 13 oxygen jet
- 14 tripod
- 15 ring (retort ring)
- 16 funnel
- 17 pipe clay triangle
- 18 wire gauze
- 19 wire gauze with asbestos centre
(Am. center)
- 20 beaker
- 21 burette (for measuring the
volume of liquids)
- 22 burette stand
- 23 burette clamp
- 24 graduated pipette
- 25 pipette
- 26 measuring cylinder (measuring
glass)
- 27 measuring flask
- 28 volumetric flask
- 29 evaporating dish (evaporating
basin), made of porcelain
- 30 tube clamp (tube clip,
pinchcock)
- 31 clay crucible with lid
- 32 crucible tongs
- 33 clamp
- 34 test tube
- 35 test tube rack
- 36 flat-bottomed flask
- 37 ground glass neck
- 38 long-necked round-bottomed
flask
- 39 Erlenmeyer flask (conical flask)
- 40 filter flask
- 41 fluted filter
- 42 one-way tap
- 43 calcium chloride tube
- 44 stopper with tap
- 45 cylinder

- 46 distillation apparatus (distilling
apparatus)
- 47 distillation flask (distilling flask)
- 48 condenser
- 49 return tap, a two-way tap
- 50 distillation flask (distilling flask,
Claisen flask)
- 51 desiccator
- 52 lid with fitted tube
- 53 tap
- 54 desiccator insert made of
porcelain
- 55 three-necked flask
- 56 connecting piece (Y-tube)
- 57 three-necked bottle
- 58 gas-washing bottle
- 59 gas generator (Kipp's apparatus,
Am. Kipp generator)
- 60 overflow container
- 61 container for the solid
- 62 acid container
- 63 gas outlet

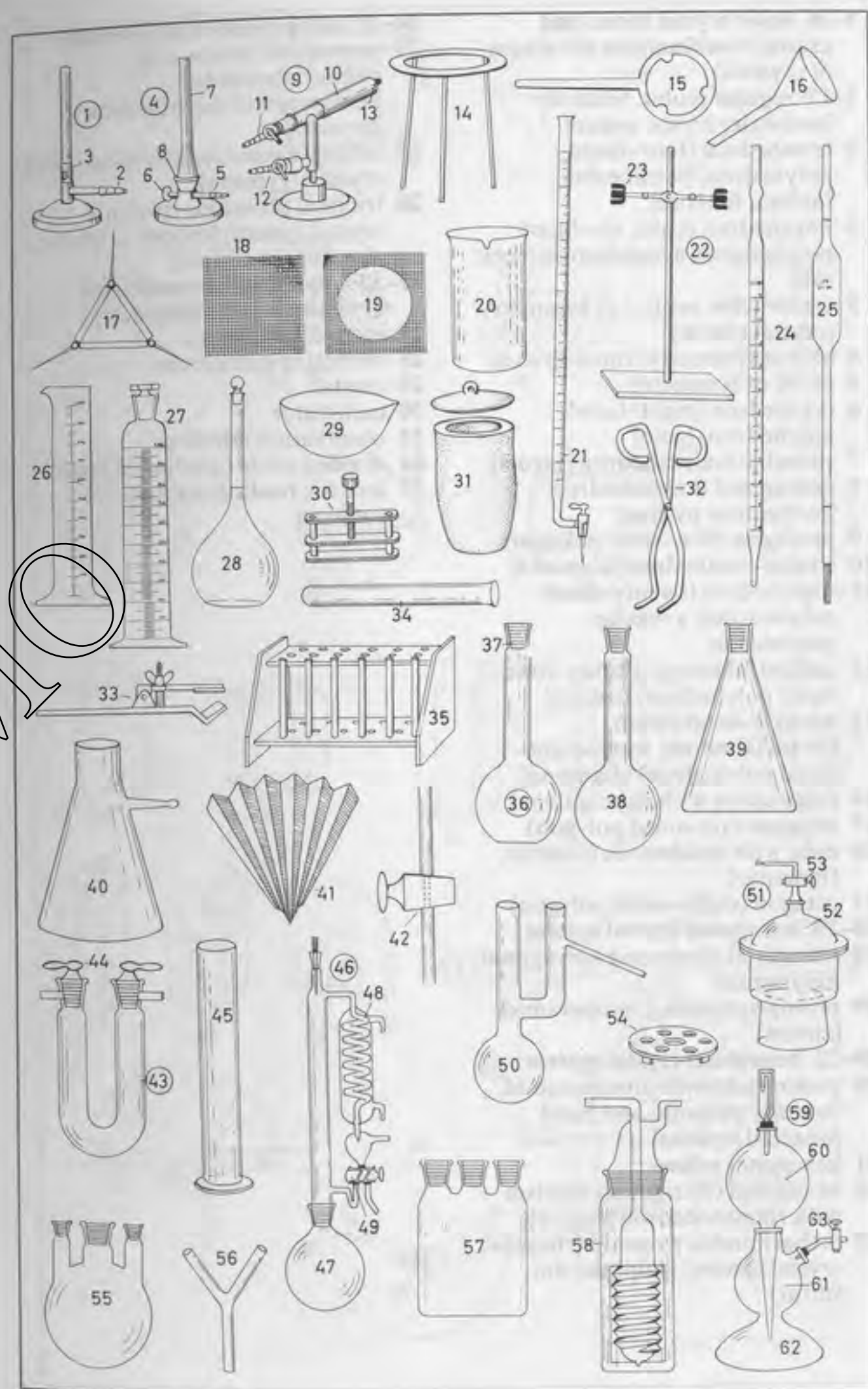

- 1-26 basic crystal forms and crystal combinations** (structure of crystals)
- 1-17 regular** (cubic, tesseral, isometric) crystal system
- 1 tetrahedron (four-faced polyhedron) [tetrahedrite, fahlerz, fahl ore]
 - 2 hexahedron (cube, six-faced polyhedron), a holohedron [rock salt]
 - 3 centre (*Am.* center) of symmetry (crystal centre)
 - 4 axis of symmetry (rotation axis)
 - 5 plane of symmetry
 - 6 octahedron (eight-faced polyhedron) [gold]
 - 7 rhombic dodecahedron [garnet]
 - 8 pentagonal dodecahedron [pyrite, iron pyrites]
 - 9 pentagon (five-sided polygon)
 - 10 triakis-octahedron [diamond]
 - 11 icosahedron (twenty-faced polyhedron), a regular polyhedron
 - 12 icositetrahedron (twenty-four-faced polyhedron) [leucite]
 - 13 hexakis-octahedron (hexoctahedron, forty-eight-faced polyhedron) [diamond]
 - 14 octahedron with cube [galena]
 - 15 hexagon (six-sided polygon)
 - 16 cube with octahedron [fluorite, fluorspar]
 - 17 octagon (eight-sided polygon)
- 18-19 tetragonal crystal system**
- 18 tetragonal dipyramid (tetragonal bipyramid)
 - 19 protoprism with protopyramid [zircon]
- 20-22 hexagonal crystal system**
- 20 protoprism with protopyramid, deutero-pyramid and basal pinacoid [apatite]
 - 21 hexagonal prism
 - 22 hexagonal (ditrigonal) biprism with rhombohedron [calcite]
 - 23 orthorhombic pyramid (rhombic crystal system) [sulphur, *Am.* sulfur]

- 24-25 monoclinic crystal system**
- 24 monoclinic prism with clinopinacoid and hemipyramid (hemihedron) [gypsum]
 - 25 orthopinacoid (swallow-tail twin crystal) [gypsum]
- 26 triclinic pinacoids** (triclinic crystal system) [copper sulphate, *Am.* copper sulfate]
- 27-33 apparatus for measuring crystals** (for crystallography)
- 27 contact goniometer
 - 28 reflecting goniometer
 - 29 crystal
 - 30 collimator
 - 31 observation telescope
 - 32 divided circle (graduated circle)
 - 33 lens for reading the angle of rotation

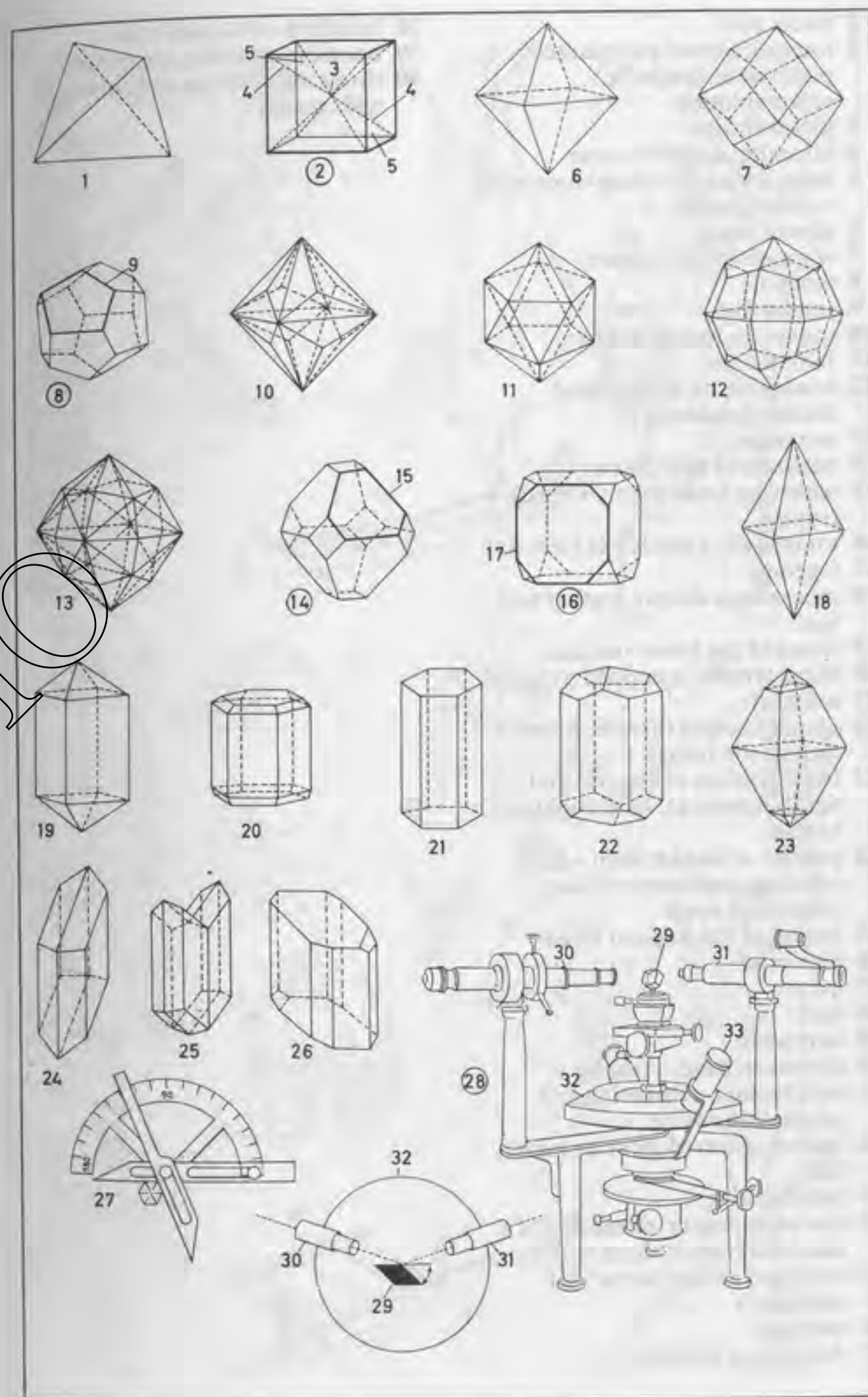

- 1 totem pole
- 2 totem, a carved and painted pictorial or symbolic representation
- 3 plains Indian
- 4 mustang, a prairie horse
- 5 lasso, a long throwing-rope with running noose
- 6 pipe of peace
- 7 wigwam (tepee, teepee)
- 8 tent pole
- 9 smoke flap
- 10 squaw, an Indian woman
- 11 Indian chief
- 12 headdress, an ornamental feather headdress
- 13 war paint
- 14 necklace of bear claws
- 15 scalp (cut from enemy's head), a trophy
- 16 tomahawk, a battle axe (*Am. ax*)
- 17 leggings
- 18 moccasin, a shoe of leather and bast
- 19 canoe of the forest Indians
- 20 Maya temple, a stepped pyramid
- 21 mummy
- 22 quipa (knotted threads, knotted code of the Incas)
- 23 Indio (Indian of Central and South America); *here*: highland Indian
- 24 poncho, a blanket with a head opening used as an armless cloak-like wrap
- 25 Indian of the tropical forest
- 26 blowpipe
- 27 quiver
- 28 dart
- 29 dart point
- 30 shrunken head, a trophy
- 31 bola (bolas), a throwing and entangling device
- 32 leather-covered stone or metal ball
- 33 pile dwelling
- 34 duk-duk dancer, a member of a duk-duk (men's secret society)
- 35 outrigger canoe (canoe with outrigger)
- 36 outrigger
- 37 Australian aborigine

- 38 loincloth of human hair
- 39 boomerang, a wooden missile
- 40 throwing stick (spear thrower) with spears

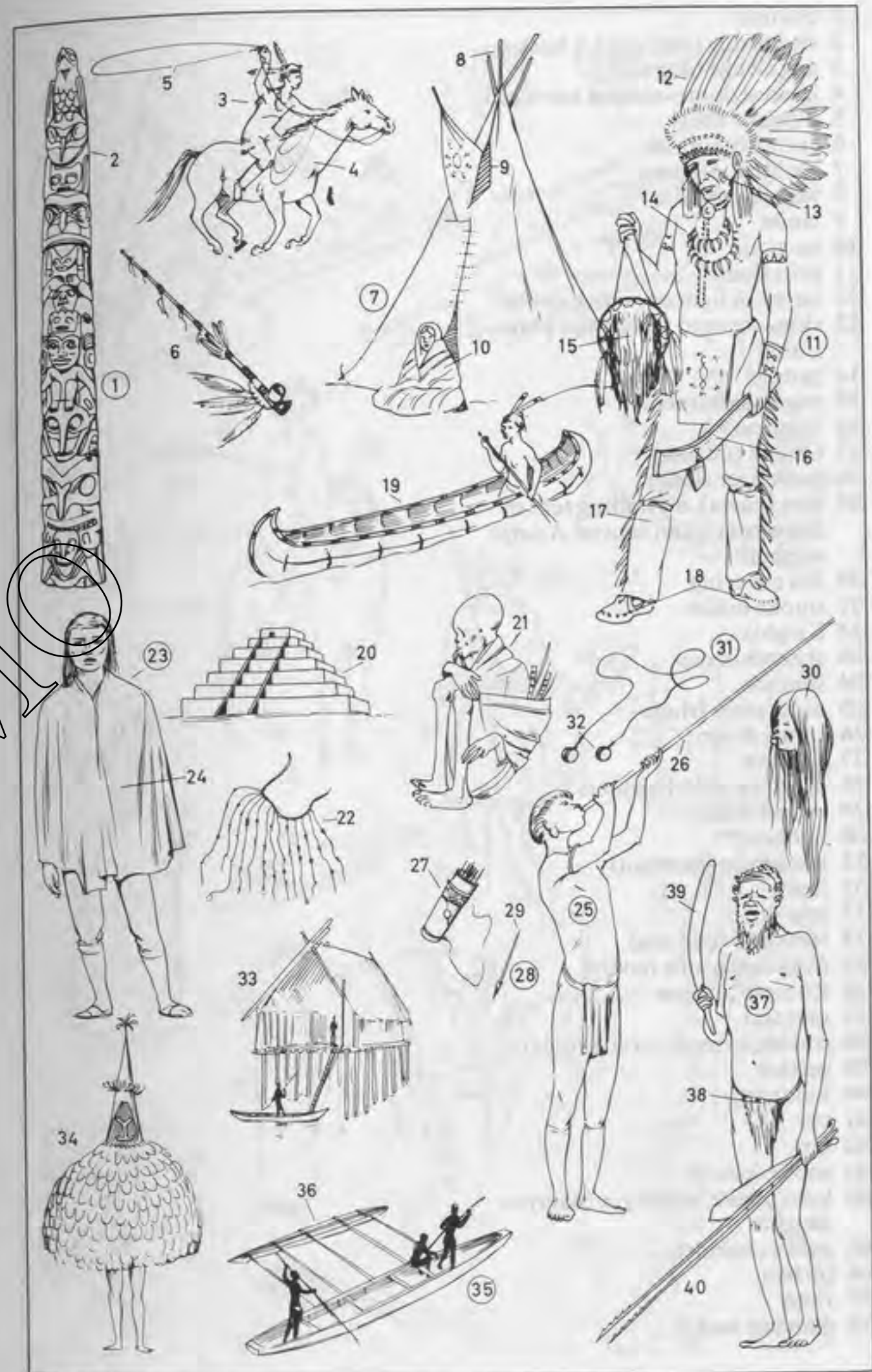

- 1 Eskimo
- 2 sledge dog (sled dog), a husky
- 3 dog sledge (dog sled)
- 4 igloo, a dome-shaped snow hut
- 5 block of snow
- 6 entrance tunnel
- 7 blubber-oil lamp
- 8 wooden missile
- 9 lance
- 10 harpoon
- 11 skin float
- 12 kayak, a light one-man canoe
- 13 skin-covered wooden or bone frame
- 14 paddle
- 15 reindeer harness
- 16 reindeer
- 17 Ostyak (Ostiak)
- 18 passenger sledge
- 19 yurt (yurta), a dwelling tent of the western and central Asiatic nomads
- 20 felt covering
- 21 smoke outlet
- 22 Kirghiz
- 23 sheepskin cap
- 24 shaman
- 25 decorative fringe
- 26 frame drum
- 27 Tibetan
- 28 flintlock with bayonets
- 29 prayer wheel
- 30 felt boot
- 31 houseboat (sampan)
- 32 junk
- 33 mat sail
- 34 rickshaw (ricksha)
- 35 rickshaw coolie (cooly)
- 36 Chinese lantern
- 37 samurai
- 38 padded armour (*Am. armor*)
- 39 geisha
- 40 kimono
- 41 obi
- 42 fan
- 43 coolie (cooly)
- 44 kris (creese, crease), a Malayan dagger
- 45 snake charmer
- 46 turban
- 47 flute
- 48 dancing snake



- 1 camel caravan
- 2 riding animal
- 3 pack animal
- 4 oasis
- 5 grove of palm trees
- 6 bedouin (beduin)
- 7 burnous
- 8 Masai warrior
- 9 headdress (hairdress)
- 10 shield
- 11 painted ox hide
- 12 long-bladed spear
- 13 negro
- 14 dance drum
- 15 throwing knife
- 16 wooden mask
- 17 figure of an ancestor
- 18 slit gong
- 19 drumstick
- 20 dugout, a boat hollowed out of a tree trunk
- 21 negro hut
- 22 negress
- 23 lip plug (labret)
- 24 grinding stone
- 25 Herero woman
- 26 leather cap
- 27 calabash (gourd)
- 28 beehive-shaped hut
- 29 bushman
- 30 earplug
- 31 loincloth
- 32 bow
- 33 knobkerry (knobkerrie), a club with round, knobbed end
- 34 bushman woman making a fire by twirling a stick
- 35 windbreak
- 36 Zulu in dance costume
- 37 dancing stick
- 38 bangle
- 39 ivory war horn
- 40 string of amulets and bones
- 41 pigmy
- 42 magic pipe for exorcising evil spirits
- 43 fetish





- 1 Greek woman
2 peplos
3 Greek
4 petasus (Thessalonian hat)
5 chiton, a linen gown worn as a basic garment
6 himation, woollen (*Am.* woolen) cloak
7 Roman woman
8 toupee wig (partial wig)
9 stola
10 palla, a coloured (*Am.* colored) wrap
11 Roman
12 tunica (tunic)
13 toga
14 purple border (purple band)
15 Byzantine empress
16 pearl diadem
17 jewels
18 purple cloak
19 long tunic
20 German princess [13th cent.]
21 crown (diadem)
22 chinband
23 tassel
24 cloak cord
25 girt-up gown (girt-up surcoat, girt-up tunic)
26 cloak
27 German dressed in the Spanish style [ca. 1575]
28 wide-brimmed cap
29 short cloak (Spanish cloak, short cape)
30 padded doublet (stuffed doublet, peasecod)
31 stuffed trunk-hose
32 lansquenet (German mercenary soldier) [ca. 1530]
33 slashed doublet (paned doublet)
34 Pluderhose (loose breeches, paned trunk-hose, slops)
35 woman of Basle [ca. 1525]
36 overgown (gown)
37 undergown (petticoat)
38 woman of Nuremberg [ca. 1500]
39 shoulder cape
40 Burgundian [15th cent.]
41 short doublet
42 piked shoes (peaked shoes, copped shoes, crackowes, poulaines)
43 pattens (clogs)



- 44 young nobleman [ca. 1400]
45 short, padded doublet (short, quilted doublet, jerkin)
46 dagged sleeves (petal-scalloped sleeves)
47 hose
48 Augsburg patrician lady [ca. 1575]
49 puffed sleeve
50 overgown (gown, open gown, sleeveless gown)
51 French lady [ca. 1600]
52 millstone ruff (cartwheel ruff, ruff)
53 corseted waist (wasp waist)
54 gentleman [ca. 1650]
55 wide-brimmed felt hat (cavalier hat)
56 falling collar (wide-falling collar) of linen
57 white lining
58 jack boots (bucket-top boots)
59 lady [ca. 1650]
60 full puffed sleeves (puffed sleeves)
61 gentleman [ca. 1700]
62 three-cornered hat
63 dress sword
64 lady [ca. 1700]
65 lace fontange (high headdress of lace)
66 lace-trimmed loose-hanging gown (loose-fitting housecoat, robe de chambre, negligée, contouche)
67 band of embroidery
68 lady [ca. 1880]
69 bustle
70 lady [ca. 1858]
71 poke bonnet
72 crinoline
73 gentleman of the Biedermeier period
74 high collar (choker collar)
75 embroidered waistcoat (vest)
76 frock coat
77 pigtail wig
78 ribbon (bow)
79 ladies in court dress [ca. 1780]
80 train
81 upswept Rococo coiffure
82 hair decoration
83 panniered overskirt

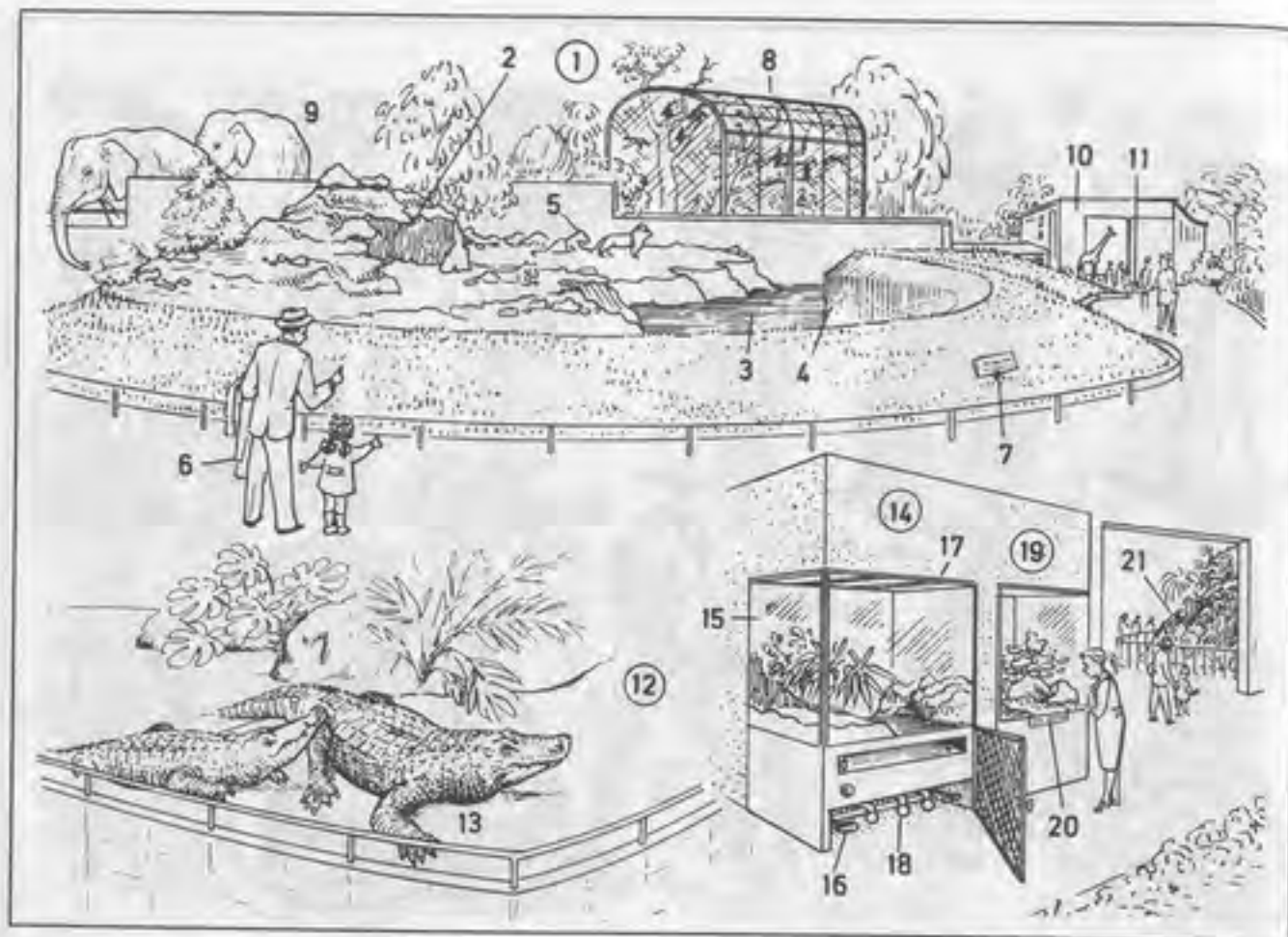

- 1 outdoor enclosure (enclosure)
- 2 rocks
- 3 moat
- 4 enclosing wall
- 5 animals on show; here: a pride of lions
- 6 visitor to the zoo
- 7 notice
- 8 aviary
- 9 elephant enclosure
- 10 animal house (e.g. carnivore house, giraffe house, elephant house, monkey house)
- 11 outside cage, animals' summer quarters
- 12 reptile enclosure
- 13 Nile crocodile
- 14 terrarium and aquarium
- 15 glass case
- 16 fresh-air inlet
- 17 ventilator
- 18 underfloor heating
- 19 aquarium
- 20 information plate
- 21 flora in artificially maintained climate

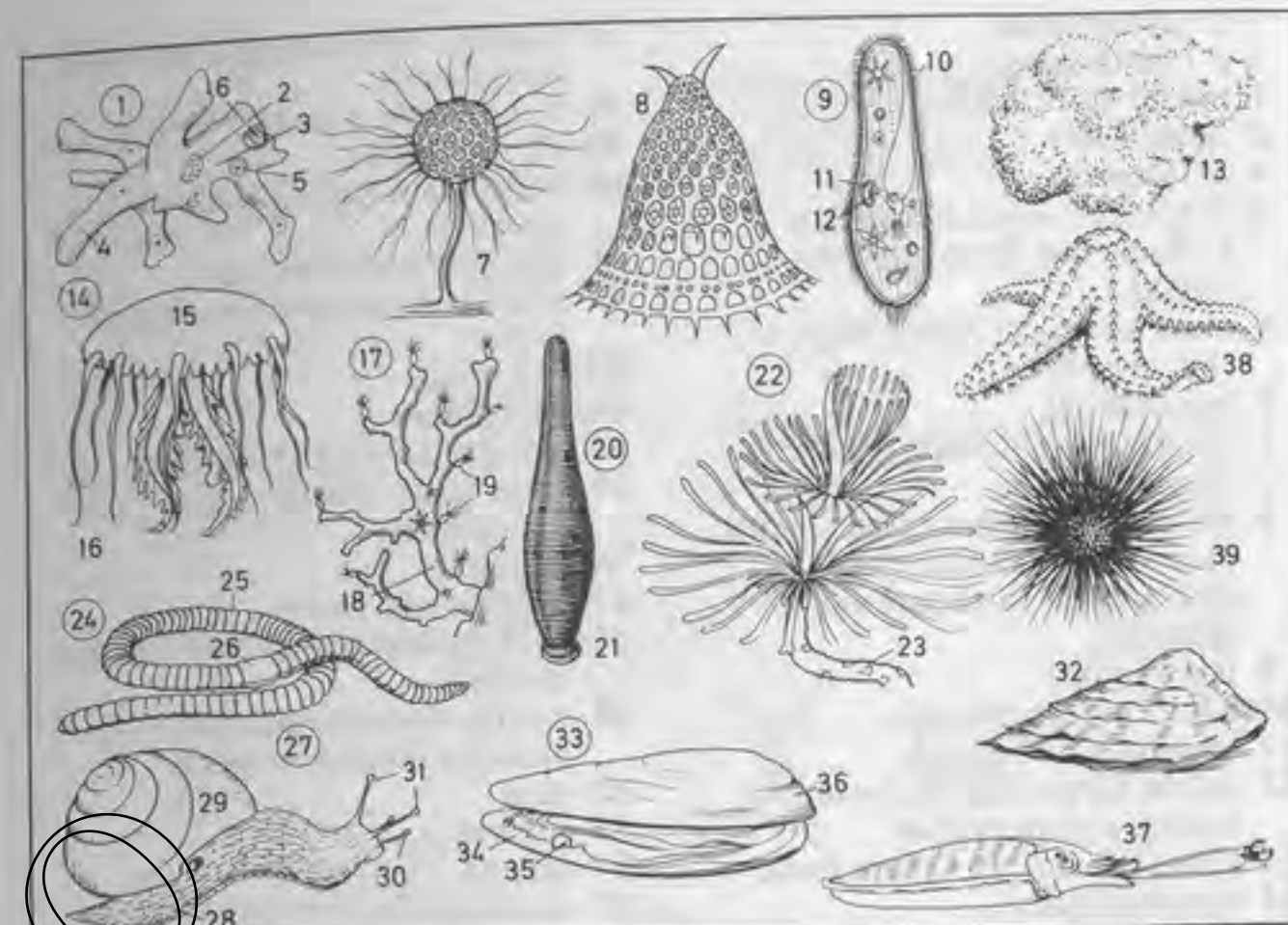

1-12 unicellular (one-celled, single-celled) animals (protozoans)

- 1 amoeba, a rhizopod
 - 2 cell nucleus
 - 3 protoplasm
 - 4 pseudopod
 - 5 excretory vacuole (contractile vacuole, an organelle)
 - 6 food vacuole
 - 7 Actinophrys, a heliozoan
 - 8 radiolarian; here: siliceous skeleton
 - 9 slipper animalcule, a Paramecium
 - 10 cilium
 - 11 macronucleus (meganucleus)
 - 12 micronucleus
- 13-39 multicellular animals (metazoans)**
- 13 bath sponge, a porifer (sponge)
 - 14 medusa, a discomedusa (jellyfish), a coelenterate
 - 15 umbrella
 - 16 tentacle
 - 17 red coral (precious coral), a coral animal (anthozoan, reef-building animal)

- 18 coral colony
- 19 coral polyp
- 20-26 worms (Vermes)
- 20 leech, an annelid
- 21 sucker
- 22 Spirographis, a bristle worm
- 23 tube
- 24 earthworm
- 25 segment
- 26 clitellum [accessory reproductive organ]
- 27-36 molluscs (*Am. mollusks*)
- 27 edible snail, a snail
- 28 creeping foot
- 29 shell (snail shell)
- 30 stalked eye
- 31 tentacle (horn, feeler)
- 32 oyster
- 33 freshwater pearl mussel
- 34 mother-of-pearl (nacre)
- 35 pearl
- 36 mussel shell
- 37 cuttlefish, a cephalopod
- 38-39 echinoderms
- 38 starfish (sea star)
- 39 sea urchin (sea hedgehog)

- 1-23 arthropods
 1-2 crustaceans
 1 mitten crab, a crab
 2 water slater
 3-23 insects
 3 dragonfly (water nymph), a homopteran (homopterous insect)
 4 water scorpion (water bug), a rhynchophore
 5 raptorial leg
 6 mayfly (dayfly, ephemerid)
 7 compound eye
 8 green grasshopper (green locust, meadow grasshopper), an orthopteron (orthopterous insect)
 9 larva (grub)
 10 adult insect, an imago
 11 leaping hind leg
 12 caddis fly (spring fly, water moth), a neuropteran
 13 aphid (greenfly), a plant louse
 14 wingless aphid
 15 winged aphid
 16-20 dipterous insects (dipterans)
 16 gnat (mosquito, midge), a culicid
 17 proboscis (sucking organ)
 18 bluebottle (blowfly), a fly
 19 maggot (larva)
 20 chrysalis (pupa)
 21-23 Hymenoptera
 21-22 ant
 21 winged female
 22 worker
 23 bumblebee (humblebee)
 24-39 beetles (Coleoptera)
 24 stag beetle, a lamellicorn beetle
 25 mandibles
 26 trophi
 27 antenna (feeler)
 28 head
 29-30 thorax
 29 thoracic shield (prothorax)
 30 scutellum
 31 tergites
 32 stigma
 33 wing (hind wing)
 34 nervure
 35 point at which the wing folds
 36 elytron (forewing)
 37 ladybird (ladybug), a coccinellid

- 38 Ergates faber, a longicorn beetle (longicorn)
 39 dung beetle, a lamellicorn beetle
 40-47 arachnids
 40 Euscorpius flavicandus, a scorpion
 41 cheliped with chelicer
 42 maxillary antenna (maxillary feeler)
 43 tail sting
 44-46 spiders
 44 wood tick (dog tick), a tick
 45 cross spider (garden spider), an orb spinner
 46 spinneret
 47 spider's web (web)
 48-56 Lepidoptera (butterflies and moths)
 48 mulberry-feeding moth (silk moth), a bombycid moth
 49 eggs
 50 silkworm
 51 cocoon
 52 swallowtail, a butterfly
 53 antenna (feeler)
 54 eyespot
 55 privet hawkmoth, a hawkmoth (sphinx)
 56 proboscis

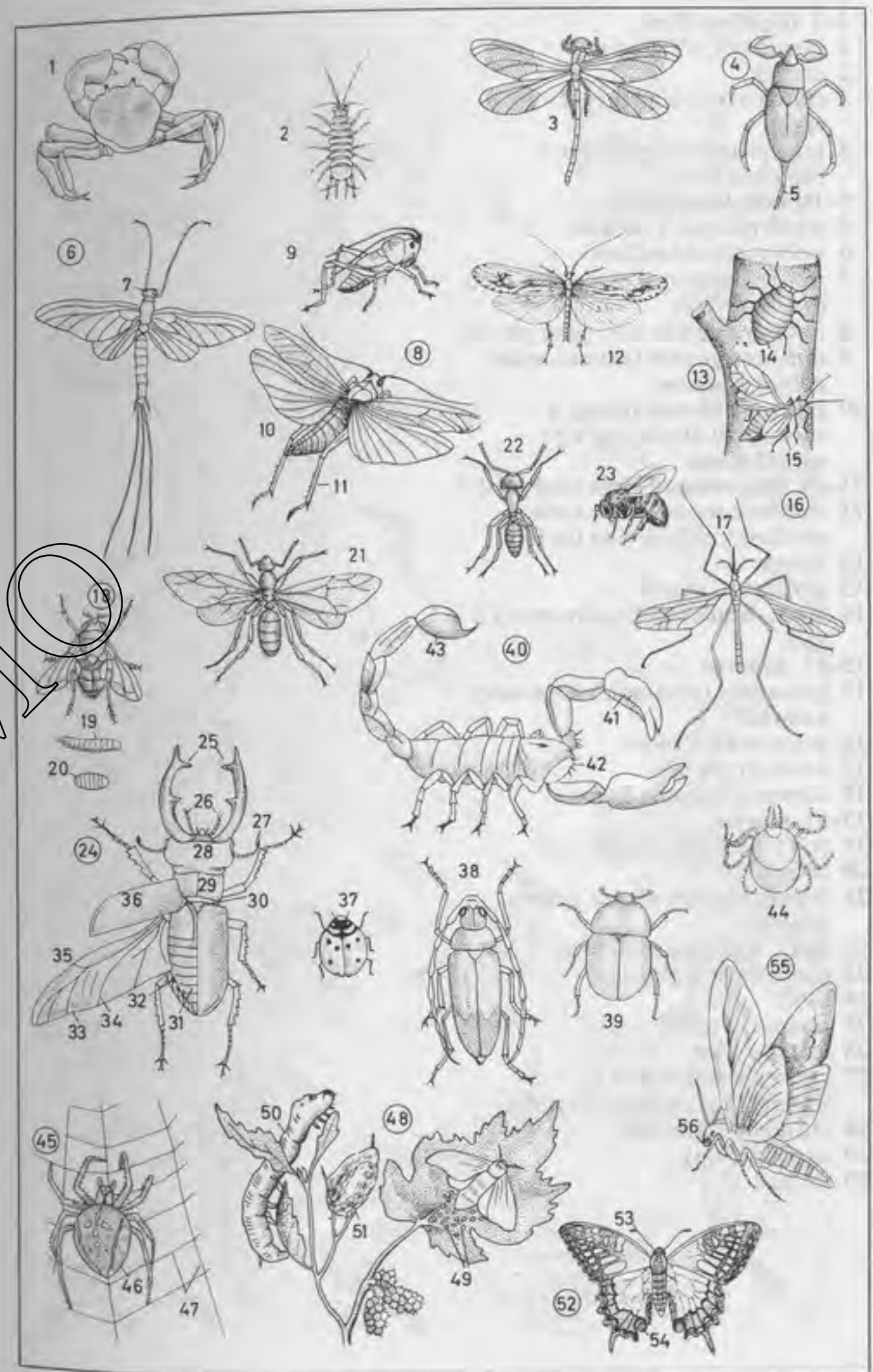

- 1-3 **flightless birds**
 1 cassowary; *sim.*: emu
 2 ostrich
 3 clutch of ostrich eggs [12 - 14 eggs]
 4 king penguin, a penguin, a flightless bird
 5-10 **web-footed birds**
 5 white pelican, a pelican
 6 webfoot (webbed foot)
 7 web (palmations) of webbed foot (palmate foot)
 8 lower mandible with gular pouch
 9 northern gannet (gannet, solan goose), a gannet
 10 green cormorant (shag), a cormorant displaying with spread wings
 11-14 **long-winged birds** (seabirds)
 11 common sea swallow, a sea swallow (tern); diving for food
 12 fulmar
 13 guillemot, an auk
 14 black-headed gull (mire crow), a gull
 15-17 **Anseres**
 15 goosander (common merganser), a sawbill
 16 mute swan, a swan
 17 knob on the bill
 18 common heron, a heron
 19-21 **plovers**
 19 stilt (stilt bird, stilt plover)
 20 coot, a rail
 21 lapwing (green plover, peewit, pewit)
 22 quail, a gallinaceous bird
 23 turtle dove, a pigeon
 24 swift
 25 hoopoe, a roller
 26 erectile crest
 27 spotted woodpecker, a woodpecker; *related*: wryneck
 28 entrance to the nest
 29 nesting cavity
 30 cuckoo

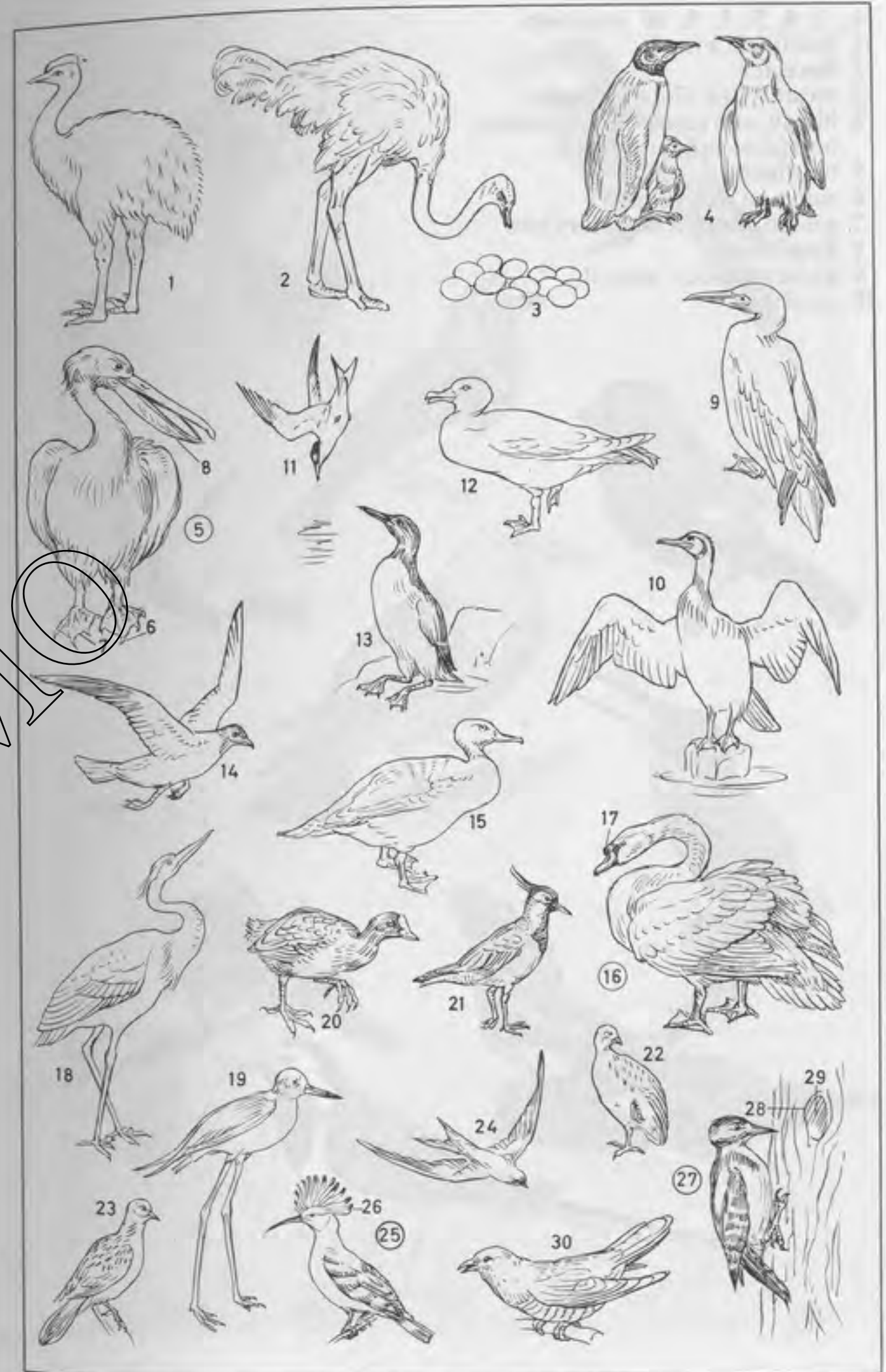

- 1, 3, 4, 5, 7, 9, 10 songbirds
 1 goldfinch, a finch
 2 bee eater
 3 redstart (star finch), a thrush
 4 bluetit, a tit (titmouse), a resident bird (non-migratory bird)
 5 bullfinch
 6 common roller (roller)
 7 golden oriole, a migratory bird
 8 kingfisher
 9 white wagtail, a wagtail
 10 chaffinch

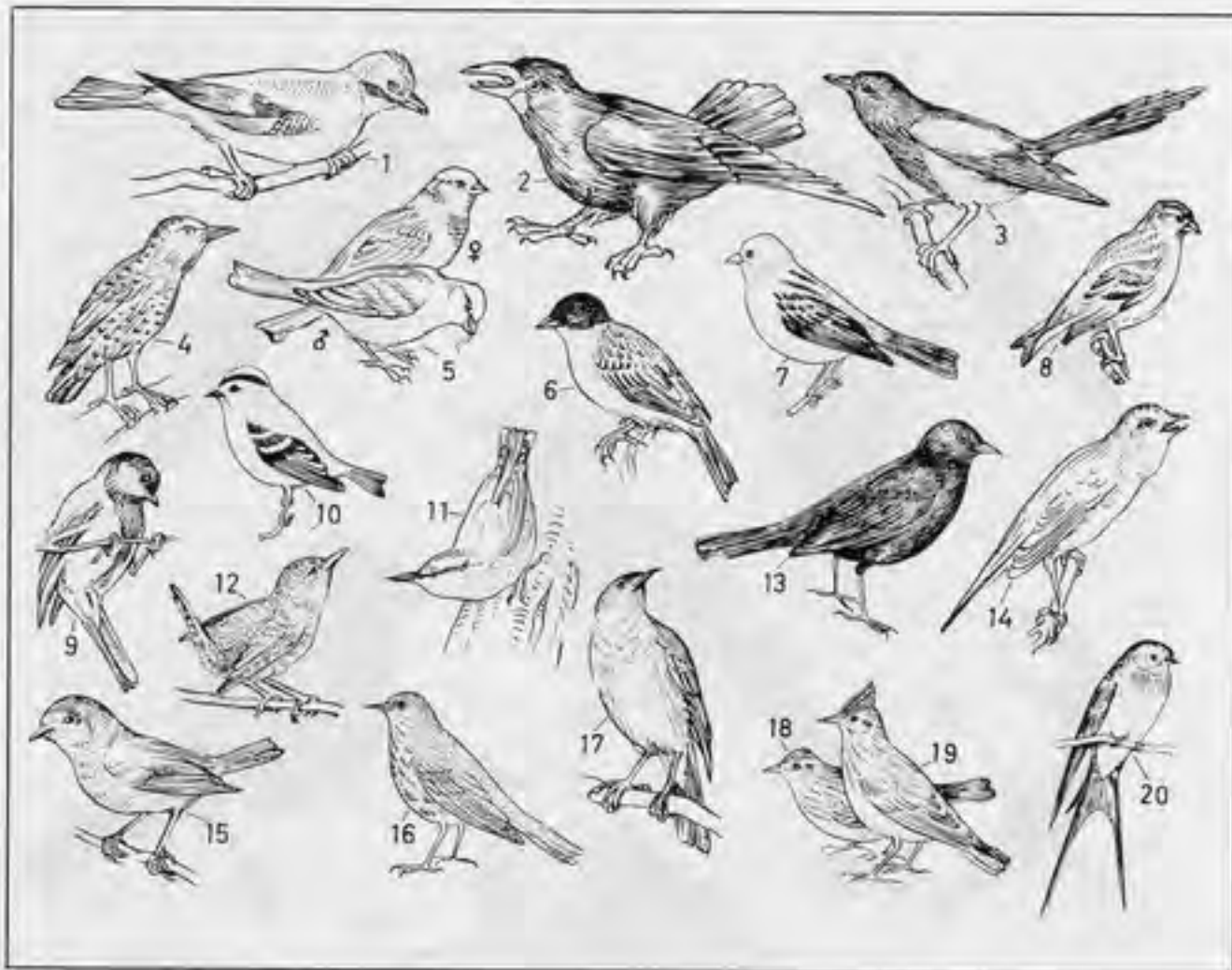

DEMO

**1-20 songbirds****1-3 Corvidae** (corvine birds, crows)

- 1 jay (nutcracker)
- 2 rook, a crow
- 3 magpie
- 4 starling (pastor, shepherd bird)
- 5 house sparrow
- 6-8 finches**
- 6-7 buntings
- 6 yellowhammer (yellow bunting)
- 7 ortolan (ortolan bunting)
- 8 siskin (aberdevine)
- 9 great titmouse (great tit, ox eye), a titmouse (tit)
- 10 golden-crested wren (goldcrest); *sim.*: firecrest, one of the Regulidae
- 11 nuthatch
- 12 wren
- 13-17 thrushes**
- 13 blackbird
- 14 nightingale (*poet.*: philomel, philomela)

- 15 robin (redbreast, robin redbreast)
- 16 song thrush (throstle, mavis)
- 17 thrush nightingale
- 18-19 larks**
- 18 woodlark
- 19 crested lark (tufted lark)
- 20 common swallow (barn swallow, chimney swallow), a swallow

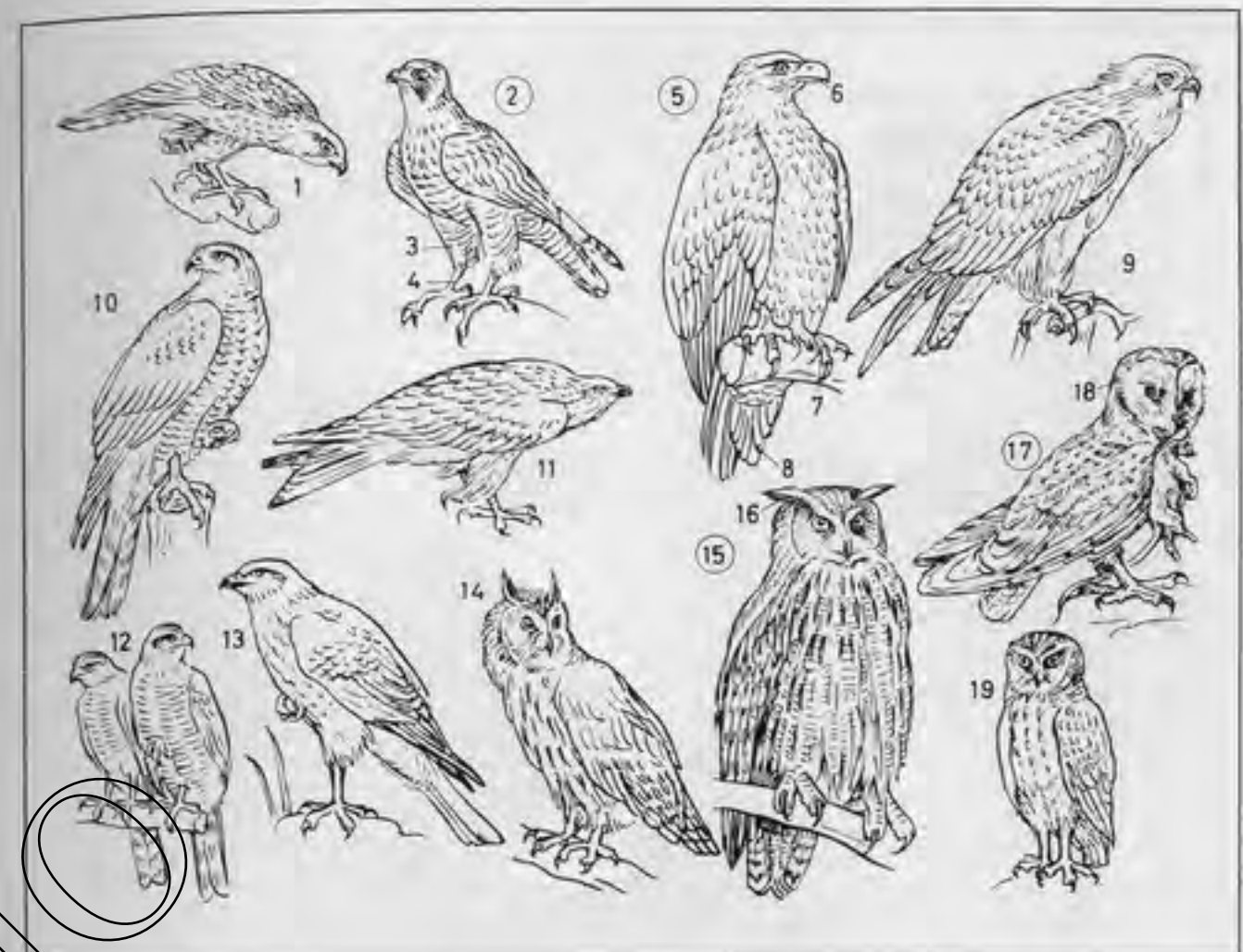
**1-13 diurnal birds of prey**

- 1-4 falcons**
- 1 merlin
- 2 peregrine falcon
- 3 leg feathers
- 4 tarsus
- 5-9 eagles**
- 5 white-tailed sea eagle (white-tailed eagle, grey sea eagle, erne)
- 6 hooked beak
- 7 claw (talon)
- 8 tail
- 9 common buzzard
- 10-13 accipiters**
- 10 goshawk
- 11 common European kite (glede, kite)
- 12 sparrow hawk (spar-hawk)
- 13 marsh harrier (moor buzzard, moor harrier, moor hawk)
- 14-19 owls** (nocturnal birds of prey)
- 14 long-eared owl (horned owl)
- 15 eagle-owl (great horned owl)
- 16 plumicorn (feathered ear, ear tuft, ear, horn)

- 17 barn owl (white owl, silver owl, yellow owl, church owl, screech owl)
- 18 facial disc (disk)
- 19 little owl (sparrow owl)

- 1 sulphur-crested cockatoo, a parrot
- 2 blue-and-yellow macaw
- 3 blue bird of paradise
- 4 sappho
- 5 cardinal (cardinal bird)
- 6 toucan (red-billed toucan), one of the Piciformes



DEMO

- 1-18 fishes**
 1 man-eater (blue shark, requin), a shark
 2 nose (snout)
 3 gill slit (gill cleft)
 4 mirror carp, a carp
 5 gill cover (operculum)
 6 dorsal fin
 7 pectoral fin
 8 pelvic fin (abdominal fin, ventral fin)
 9 anal fin
 10 caudal fin (tail fin)
 11 scale
 12 catfish (sheatfish, sheathfish, wels)
 13 barbel
 14 herring
 15 brown trout, a trout
 16 pike (northern pike)
 17 freshwater eel (eel)
 18 sea horse (Hippocampus, horsefish)
 19 tufted gills
20-26 Amphibia (amphibians)
 20-22 salamanders
 20 greater water newt (crested newt), a water newt
 21 dorsal crest
 22 fire salamander, a salamander
 23-26 salientians (anurans, batrachians)
 23 European toad, a toad
 24 tree frog (tree toad)
 25 vocal sac (vocal pouch, croaking sac)
 26 adhesive disc (disk)
27-41 reptiles
27, 30-37 lizards
 27 sand lizard
 28 hawksbill turtle (hawksbill)
 29 carapace (shell)
 30 basilisk
 31 desert monitor, a monitor lizard (monitor)
 32 common iguana, an iguana
 33 chameleon, one of the Chamaeleontidae (Rhiptoglossa)
 34 prehensile foot
 35 prehensile tail
 36 wall gecko, a gecko
 37 slowworm (blindworm), one of the Anguidae

- 38-41 snakes**
 38 ringed snake (ring snake, water snake, grass snake), a colubrid
 39 collar
40-41 vipers (adders)
 40 common viper, a poisonous (venomous) snake
 41 asp (asp viper)

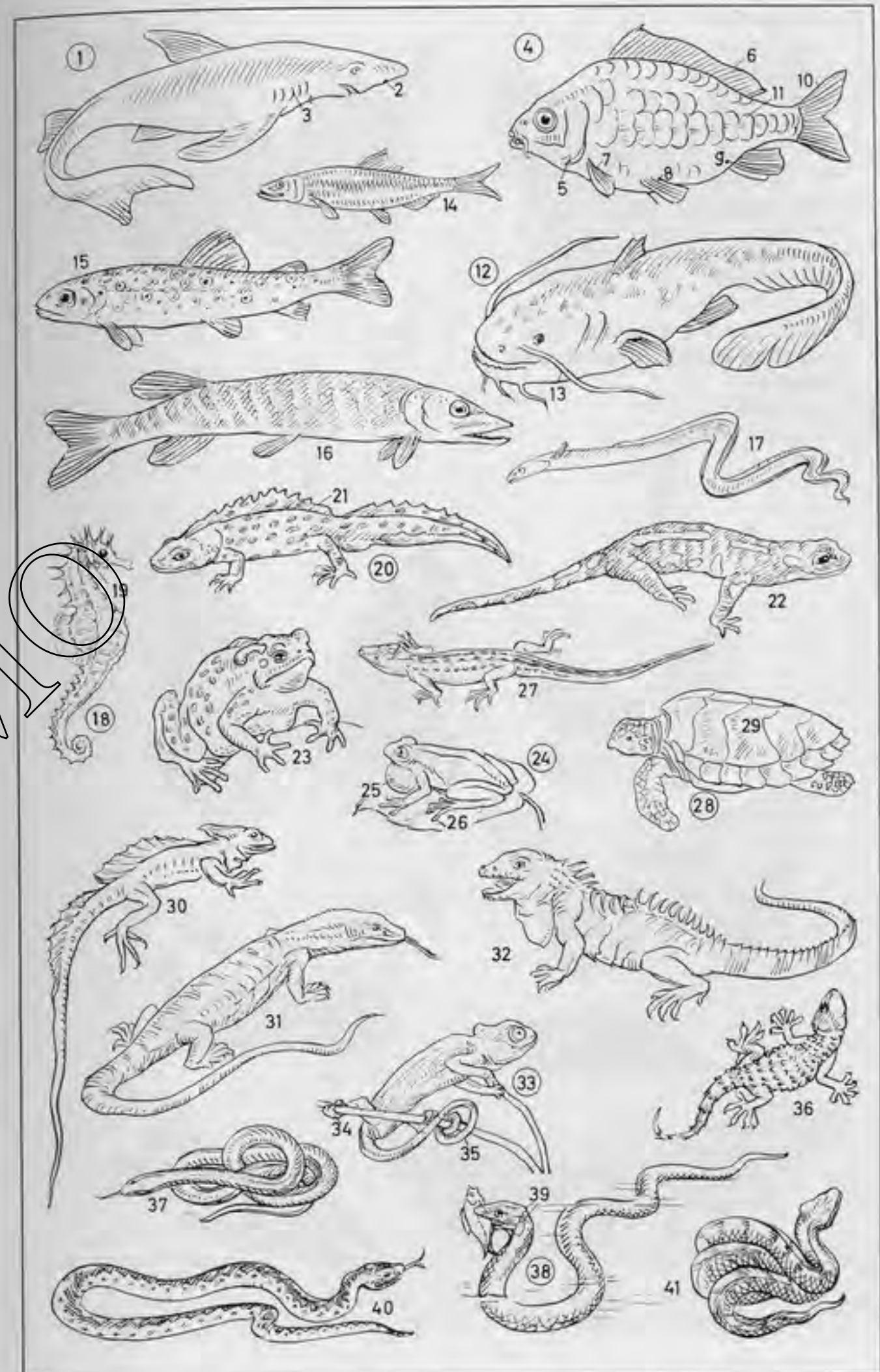

1-6 butterflies

- 1 red admiral
 - 2 peacock butterfly
 - 3 orange tip (orange tip butterfly)
 - 4 brimstone (brimstone butterfly)
 - 5 Camberwell beauty (mourning cloak, mourning cloak butterfly)
 - 6 blue (lycaenid butterfly, lycaenid)
- 7-11 moths (Heterocera)
- 7 garden tiger
 - 8 red underwing
 - 9 death's-head moth (death's-head hawkmoth), a hawkmoth (sphinx)
 - 10 caterpillar
 - 11 chrysalis (pupa)



DEMO

- 1 platypus (duck-bill, duck-mole), a monotreme (oviparous mammal)
- 2-3 marsupial mammals (marsupials)
- 2 New World opossum, a didelphid
- 3 red kangaroo (red flyer), a kangaroo
- 4-7 insectivores (insect-eating mammals)
- 4 mole
- 5 hedgehog
- 6 spine
- 7 shrew (shrew mouse), one of the Soricidae
- 8 nine-banded armadillo (peba)
- 9 long-eared bat (flutter-mouse), a flying mammal (chiropter, chiropteran)
- 10 pangolin (scaly ant-eater), a scaly mammal
- 11 two-toed sloth (unau)
- 12-19 rodents
- 12 guinea pig (cavy)
- 13 porcupine
- 14 beaver
- 15 jerboa
- 16 hamster
- 17 water vole
- 18 marmot
- 19 squirrel
- 20 African elephant, a proboscidean (proboscidian)
- 21 trunk (proboscis)
- 22 tusk
- 23 manatee (manati, lamantin), a sirenian
- 24 South African dassie (das, coney, hyrax), a procaviid
- 25-31 ungulates
- 25-27 odd-toed ungulates
- 25 African black rhino, a rhinoceros (nasicorn)
- 26 Brazilian tapir, a tapir
- 27 zebra
- 28-31 even-toed ungulates
- 28-30 ruminants
- 28 llama
- 29 Bactrian camel (two-humped camel)
- 30 guanaco
- 31 hippopotamus

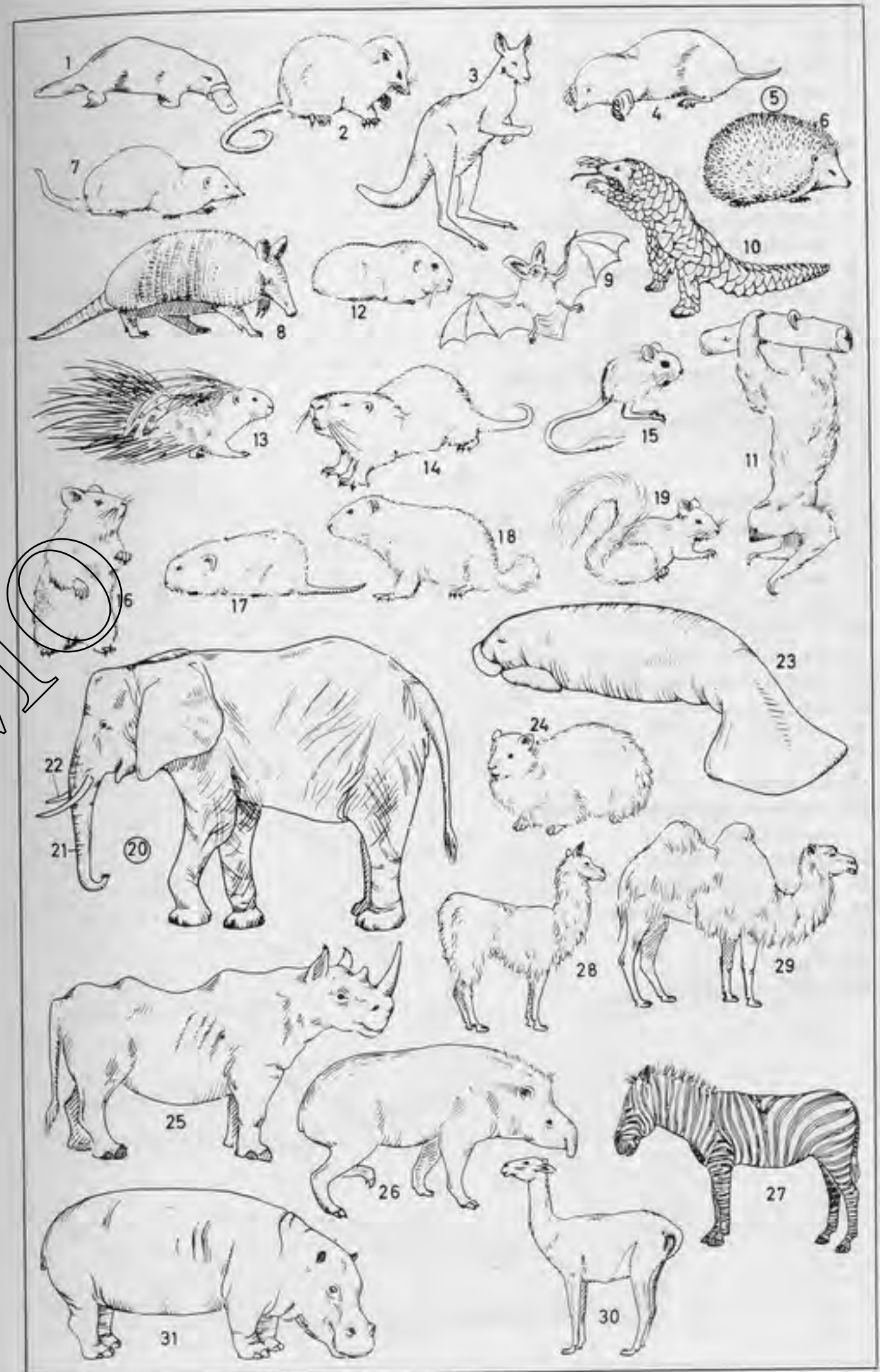

- 1-10 ungulates, ruminants**
1-10
 1 elk (moose)
 2 wapiti (*Am. elk*)
 3 chamois
 4 giraffe
 5 black buck, an antelope
 6 mouflon (mouflon)
 7 ibex (rock goat, bouquetin, steinbock)
 8 water buffalo (Indian buffalo, water ox)
 9 bison
 10 musk ox
11-22 carnivores (beasts of prey)
11-13 Canidae
 11 black-backed jackal (jackal)
 12 red fox
 13 wolf
14-17 martens
 14 stone marten (beach marten)
 15 sable
 16 weasel
 17 sea otter, an otter
18-22 seals (pinnipeds)
 18 fur seal (sea bear, ursine seal)
 19 common seal (sea calf, sea dog)
 20 walrus (morse)
 21 whiskers
 22 tusk
23-29 whales
 23 bottle-nosed dolphin (bottle-nose dolphin)
 24 common dolphin
 25 sperm whale (cachalot)
 26 blowhole (spout hole)
 27 dorsal fin
 28 flipper
 29 tail flukes (tail)

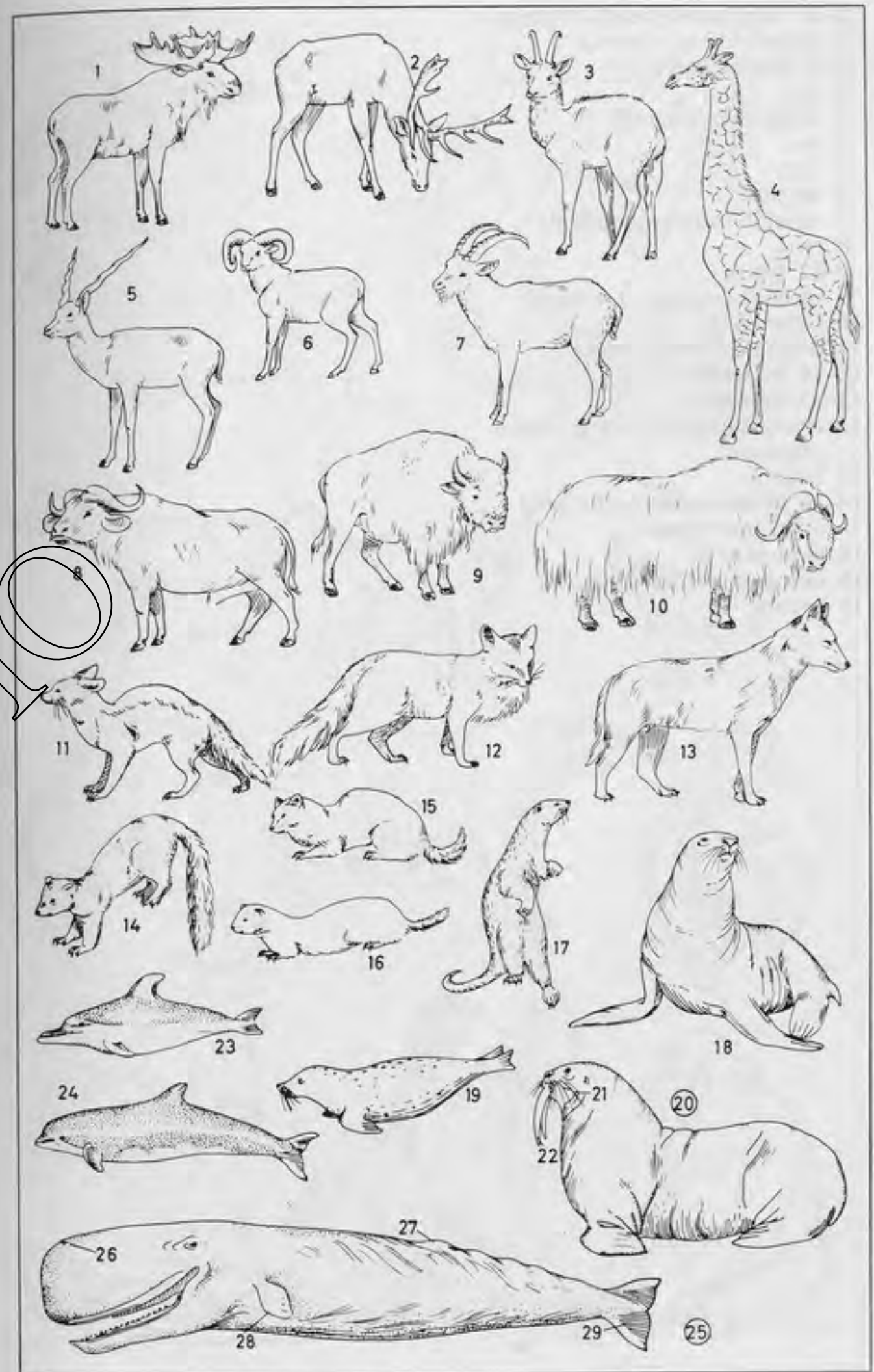

- 1-11 carnivores (beasts of prey)
 1 striped hyena, a hyena
 2-8 felines (cats)
 2 lion
 3 mane (lion's mane)
 4 paw
 5 tiger
 6 leopard
 7 cheetah (hunting leopard)
 8 lynx
 9-11 bears
 9 raccoon (racoon, *Am. coon*)
 10 brown bear
 11 polar bear (white bear)
 12-16 primates
 12-13 monkeys
 12 rhesus monkey (rhesus, rhesus macaque)
 13 baboon
 14-16 anthropoids (anthropoid apes, great apes)
 14 chimpanzee
 15 orang-utan (orang-outan)
 16 gorilla

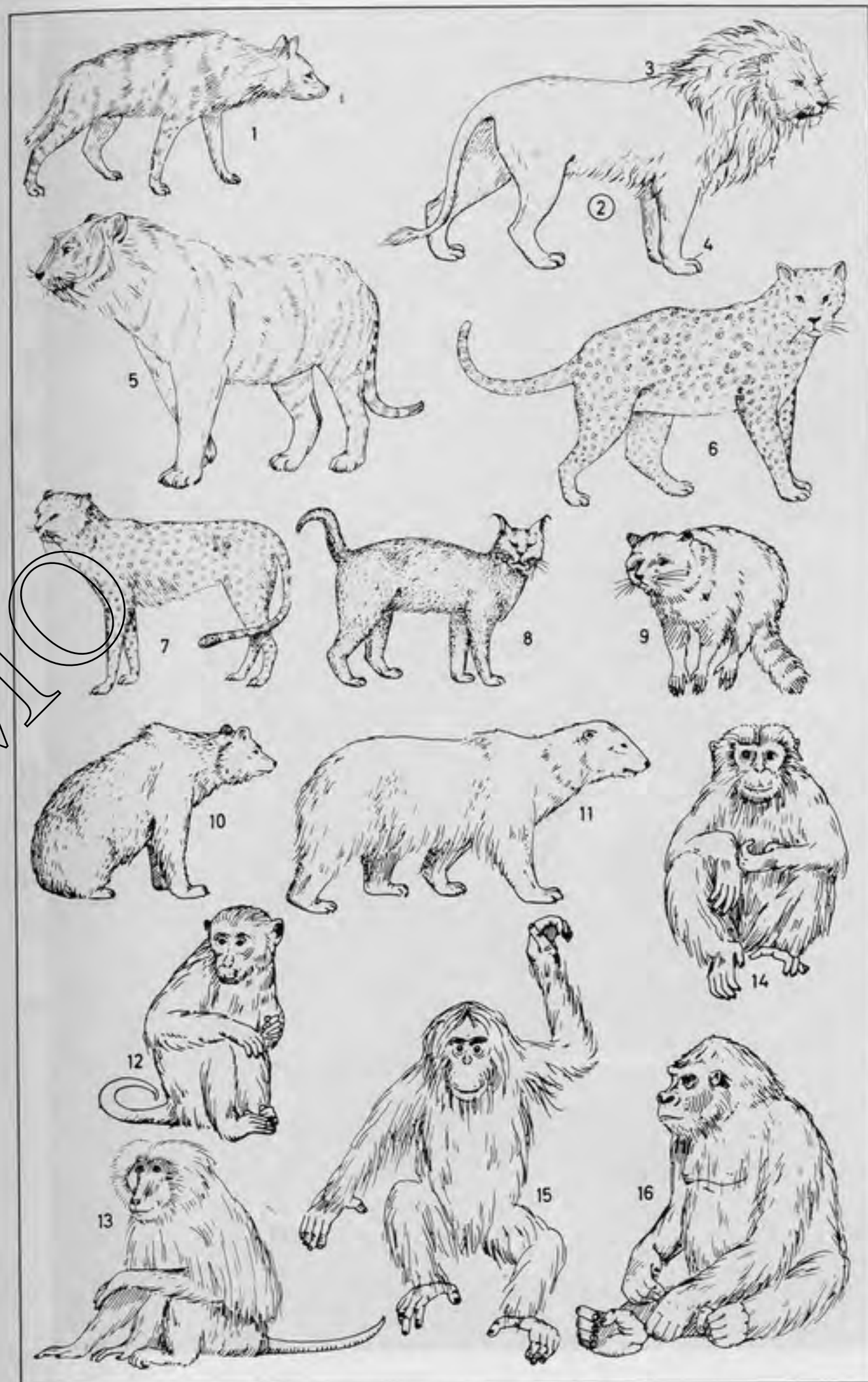

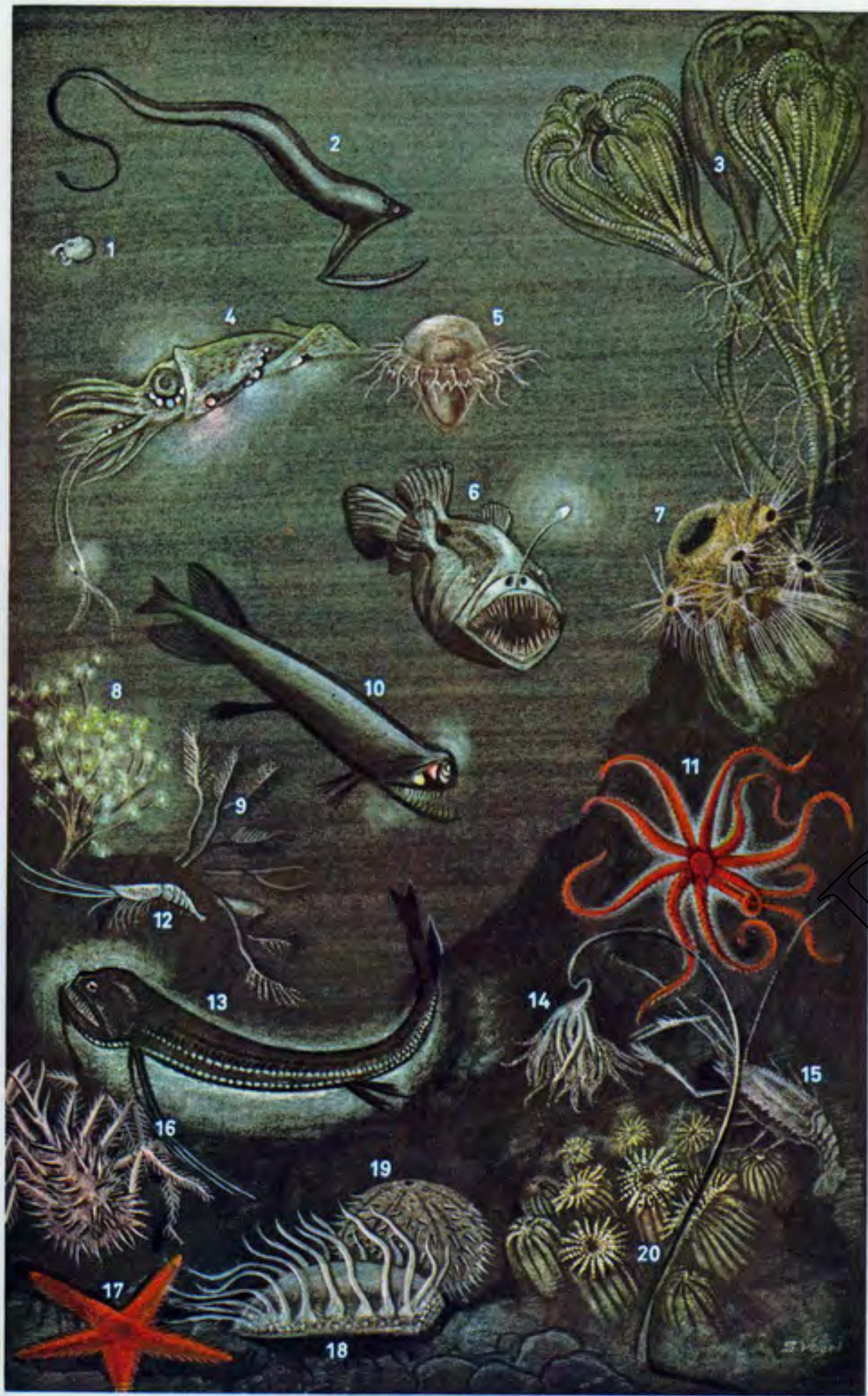

- 1 Gigantocypris agassizi
- 2 Macropharynx longicaudatus (pelican eel)
- 3 Pentacrinus (feather star), a sea lily, an echinoderm
- 4 Thaumatolampas diadema, a cuttlefish [luminescent]
- 5 Atolla, a deep-sea medusa, a coelenterate
- 6 Melanocetes, a pediculate [luminescent]
- 7 Lophocalyx philippensis, a glass sponge
- 8 Mopsea, a sea fan [colony]
- 9 Hydrallmania, a hydroid polyp, a coelenterate [colony]
- 10 Malacosteus indicus, a stomiatid [luminescent]
- 11 Brisinga endecacnemos, a sand star (brittle star), an echinoderm [luminescent only when stimulated]
- 12 Pasiphaea, a shrimp, a crustacean
- 13 Echiostoma, a stomiatid, a fish [luminescent]
- 14 Umbellula encrinus, a sea pen (sea feather), a coelenterate [colony, luminescent]
- 15 Polycheles, a crustacean
- 16 Lithodes, a crustacean, a crab
- 17 Archaster, a starfish (sea star), an echinoderm
- 18 Oneirophanta, a sea cucumber, an echinoderm
- 19 Palaeopneustes niasicus, a sea urchin (sea hedgehog), an echinoderm
- 20 Chitonactis, a sea anemone (actinia), a coelenterate

- 1 tree
- 2 bole (tree trunk, trunk, stem)
- 3 crown of tree (crown)
- 4 top of tree (treetop)
- 5 bough (limb, branch)
- 6 twig (branch)
- 7 bole (tree trunk) [cross section]
- 8 bark (rind)
- 9 phloem (bast sieve tissue, inner fibrous bark)
- 10 cambium (cambium ring)
- 11 medullary rays (vascular rays, pith rays)
- 12 sapwood (sap, alburnum)
- 13 heartwood (duramen)
- 14 pith
- 15 plant
- 16-18 root
- 16 primary root
- 17 secondary root
- 18 root hair
- 19-25 shoot (sprout)
- 19 leaf
- 20 stalk
- 21 side shoot (offshoot)
- 22 terminal bud
- 23 flower
- 24 flower bud
- 25 leaf axil with axillary bud
- 26 leaf
- 27 leaf stalk (petiole)
- 28 leaf blade (blade, lamina)
- 29 venation (veins, nervures, ribs)
- 30 midrib (nerve)
- 31-38 leaf shapes
- 31 linear
- 32 lanceolate
- 33 orbicular (orbiculate)
- 34 acerose (acerous, acerate, acicular, needle-shaped)
- 35 cordate
- 36 ovate
- 37 sagittate
- 38 reniform
- 39-42 compound leaves
- 39 digitate (digitated, palmate, quinquefoliate)
- 40 pinnatifid
- 41 abruptly pinnate
- 42 odd-pinnate
- 43-50 leaf margin shapes
- 43 entire
- 44 serrate (serrulate, saw-toothed)
- 45 doubly toothed
- 46 crenate
- 47 dentate
- 48 sinuate
- 49 ciliate (ciliated)
- 50 cilium
- 51 flower
- 52 flower stalk (flower stem, scape)

- 53 receptacle (floral axis, thalamus, torus)
- 54 ovary
- 55 style
- 56 stigma
- 57 stamen
- 58 sepal
- 59 petal
- 60 ovary and stamen [section]
- 61 ovary wall
- 62 ovary cavity
- 63 ovule
- 64 embryo sac
- 65 pollen
- 66 pollen tube
- 67-77 inflorescences
- 67 spike (racemose spike)
- 68 raceme (simple raceme)
- 69 panicle
- 70 cyme
- 71 spadix (fleshy spike)
- 72 umbel (simple umbel)
- 73 capitulum
- 74 composite head (discoid flower head)
- 75 hollow flower head
- 76 bostryx (helicoid cyme)
- 77 cincinnus (scorpioid cyme, curled cyme)
- 78-82 roots
- 78 adventitious roots
- 79 tuber (tuberous root, swollen taproot)
- 80 adventitious roots (aerial roots)
- 81 root thorns
- 82 pneumatophores
- 83-85 blade of grass
- 83 leaf sheath
- 84 ligule (ligula)
- 85 leaf blade (lamina)
- 86 embryo (seed, germ)
- 87 cotyledon (seed leaf, seed lobe)
- 88 radicle
- 89 hypocotyl
- 90 plumule (leaf bud)
- 91-102 fruits
- 91-96 dehiscent fruits
- 91 follicle
- 92 legume (pod)
- 93 siliqua (pod)
- 94 schizocarp
- 95 pyxidium (circumscissile seed vessel)
- 96 poricidal capsule (porose capsule)
- 97-102 indehiscent fruits
- 97 berry
- 98 nut
- 99 drupe (stone fruit) (cherry)
- 100 aggregate fruit (compound fruit) (rose hip)
- 101 aggregate fruit (compound fruit) (raspberry)
- 102 pome (apple)

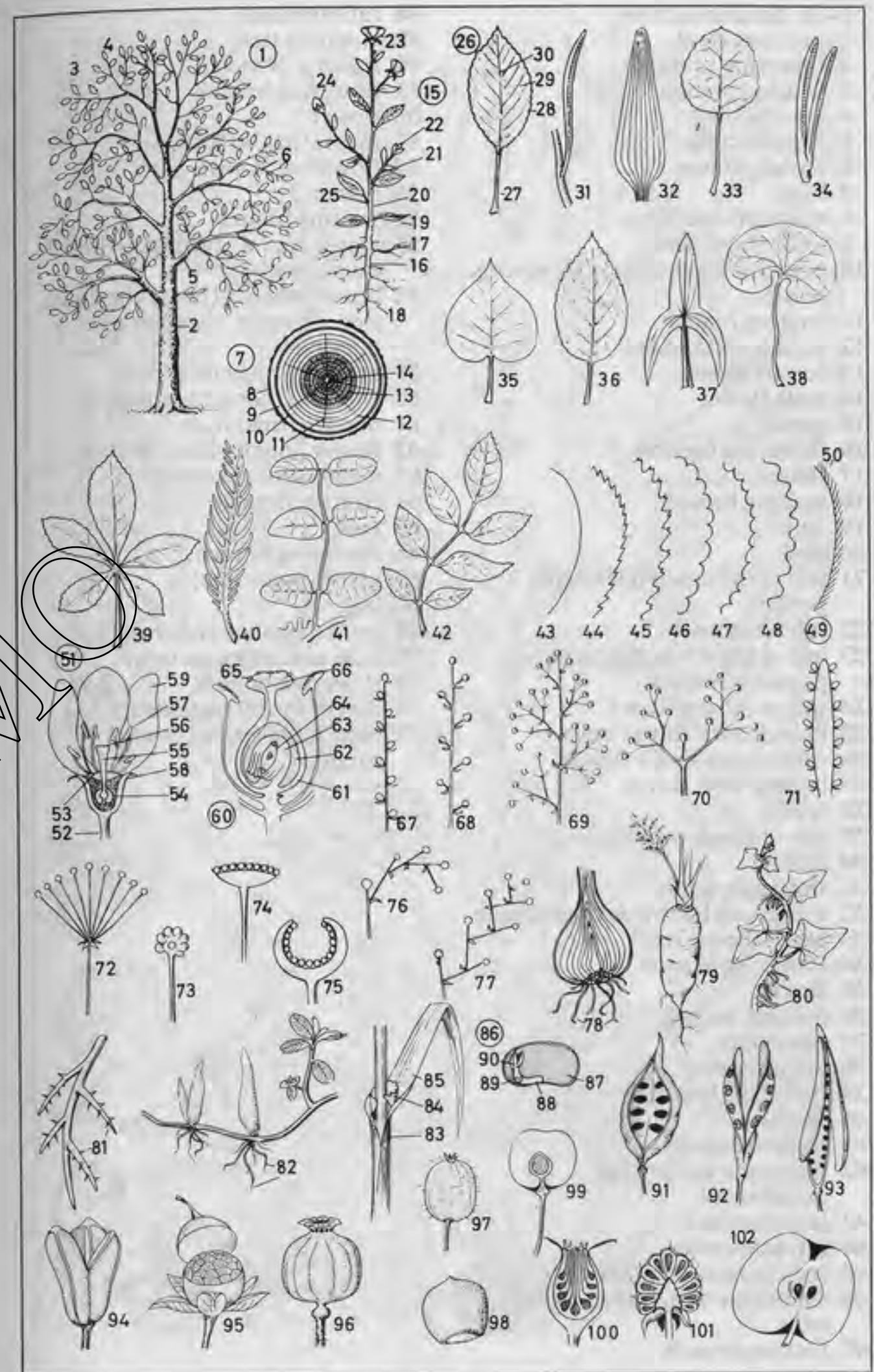

- 1-73 deciduous trees
 1 oak (oak tree)
 2 flowering branch
 3 fruiting branch
 4 fruit (acorn)
 5 cupule (cup)
 6 female flower
 7 bract
 8 male inflorescence
 9 birch (birch tree)
 10 branch with catkins, a flowering branch
 11 fruiting branch
 12 scale (catkin scale)
 13 female flower
 14 male flower
 15 poplar
 16 flowering branch
 17 flower
 18 fruiting branch
 19 fruit
 20 seed
 21 leaf of the aspen (trembling poplar)
 22 infructescence
 23 leaf of the white poplar (silver poplar, silverleaf)
 24 willow (goat willow)
 25 branch with flower buds
 26 catkin with single flower
 27 branch with leaves
 28 fruit
 29 osier branch with leaves
 30 alder
 31 fruiting branch
 32 branch with previous year's cone
 33 beech (beech tree)
 34 flowering branch
 35 flower
 36 fruiting branch
 37 beech nut
 38 ash (ash tree)
 39 flowering branch
 40 flower
 41 fruiting branch
 42 mountain ash (rowan, quickbeam)
 43 inflorescence
 44 infructescence
 45 fruit [longitudinal section]
 46 lime (lime tree, linden, linden tree)
 47 fruiting branch
 48 inflorescence
 49 elm (elm tree)
 50 fruiting branch
 51 flowering branch
 52 flower
 53 maple (maple tree)
 54 flowering branch
 55 flower
 56 fruiting branch
 57 maple seed with wings (winged maple seed)
 58 horse chestnut (horse chestnut tree, chestnut, chestnut tree, buckeye)
 59 branch with young fruits
 60 chestnut (horse chestnut)
 61 mature (ripe) fruit
 62 flower [longitudinal section]
 63 hornbeam (yoke elm)
 64 fruiting branch
 65 seed
 66 flowering branch
 67 plane (plane tree)
 68 leaf
 69 infructescence and fruit
 70 false acacia (locust tree)
 71 flowering branch
 72 part of the infructescence
 73 base of the leaf stalk with stipules



- 1-71 coniferous trees (conifers)
- 1 silver fir (European silver fir, common silver fir)
- 2 fir cone, a fruit cone
- 3 cone axis
- 4 female flower cone
- 5 bract scale (bract)
- 6 male flower shoot
- 7 stamen
- 8 cone scale
- 9 seed with wing (winged seed)
- 10 seed [longitudinal section]
- 11 fir needle (needle)
- 12 spruce (spruce fir)
- 13 spruce cone
- 14 cone scale
- 15 seed
- 16 female flower cone
- 17 male inflorescence
- 18 stamen
- 19 spruce needle
- 20 pine (Scots pine)
- 21 dwarf pine
- 22 female flower cone
- 23 short shoot with bundle of two leaves
- 24 male inflorescences
- 25 annual growth
- 26 pine cone
- 27 cone scale
- 28 seed
- 29 fruit cone of the arolla pine (Swiss stone pine)
- 30 fruit cone of the Weymouth pine (white pine)
- 31 short shoot [cross section]
- 32 larch
- 33 flowering branch
- 34 scale of the female flower cone
- 35 anther
- 36 branch with larch cones (fruit cones)
- 37 seed
- 38 cone scale
- 39 arbor vitae (tree of life, thuja)
- 40 fruiting branch
- 41 fruit cone
- 42 scale
- 43 branch with male and female flowers
- 44 male shoot
- 45 scale with pollen sacs
- 46 female shoot
- 47 juniper (juniper tree)
- 48 female shoot [longitudinal section]
- 49 male shoot
- 50 scale with pollen sacs
- 51 fruiting branch
- 52 juniper berry
- 53 fruit [cross section]
- 54 seed
- 55 stone pine
- 56 male shoot
- 57 fruit cone with seeds [longitudinal section]
- 58 cypress
- 59 fruiting branch
- 60 seed
- 61 yew (yew tree)
- 62 male flower shoot and female flower cone
- 63 fruiting branch
- 64 fruit
- 65 cedar (cedar tree)
- 66 fruiting branch
- 67 fruit scale
- 68 male flower shoot and female flower cone
- 69 mammoth tree (Wellingtonia, sequoia)
- 70 fruiting branch.
- 71 seed



- 1 forsythia
- 2 ovary and stamen
- 3 leaf
- 4 yellow-flowered jasmine
(jasmin, jessamine)
- 5 flower [longitudinal section] with
styles, ovaries and stamens
- 6 privet (common privet)
- 7 flower
- 8 infructescence
- 9 mock orange (sweet syringa)
- 10 snowball (snowball bush,
guelder rose)
- 11 flower
- 12 fruits
- 13 oleander (rosebay, rose laurel)
- 14 flower [longitudinal section]
- 15 red magnolia
- 16 leaf
- 17 japonica (japanese quince)
- 18 fruit
- 19 common box (box, box tree)
- 20 female flower
- 21 male flower
- 22 fruit [longitudinal section]
- 23 weigela (weigelia)
- 24 yucca [part of the inflorescence]
- 25 leaf
- 26 dog rose (briar rose, wild briar)
- 27 fruit
- 28 kerria
- 29 fruit
- 30 cornelian cherry
- 31 flower
- 32 fruit (cornelian cherry)
- 33 sweet gale (gale)

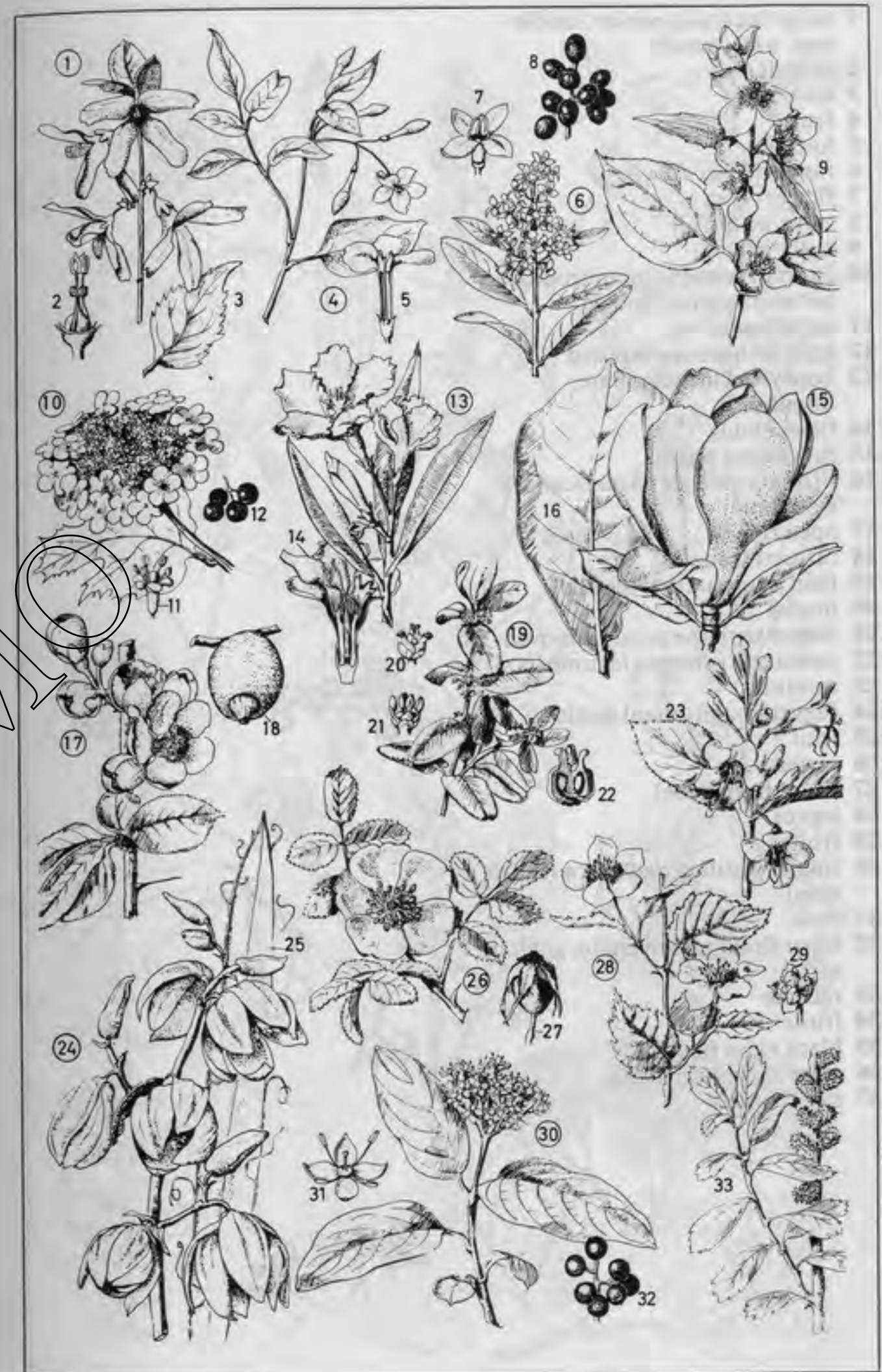

- 1 tulip tree (tulip poplar, saddle tree, whitewood)
- 2 carpels
- 3 stamen
- 4 fruit
- 5 hyssop
- 6 flower [front view]
- 7 flower
- 8 calyx with fruit
- 9 holly
- 10 androgynous (hermaphroditic, hermaphrodite) flower
- 11 male flower
- 12 fruit with stones exposed
- 13 honeysuckle (woodbine, woodbind)
- 14 flower buds
- 15 flower [cut open]
- 16 Virginia creeper (American ivy, woodbine)
- 17 open flower
- 18 infructescence
- 19 fruit [longitudinal section]
- 20 broom
- 21 flower with the petals removed
- 22 immature (unripe) legume (pod)
- 23 spiraea
- 24 flower [longitudinal section]
- 25 fruit
- 26 carpel
- 27 blackthorn (sloe)
- 28 leaves
- 29 fruits
- 30 single-pistilled hawthorn (thorn, may)
- 31 fruit
- 32 laburnum (golden chain, golden rain)
- 33 raceme
- 34 fruits
- 35 black elder (elder)
- 36 elder flowers (cymes)
- 37 elderberries

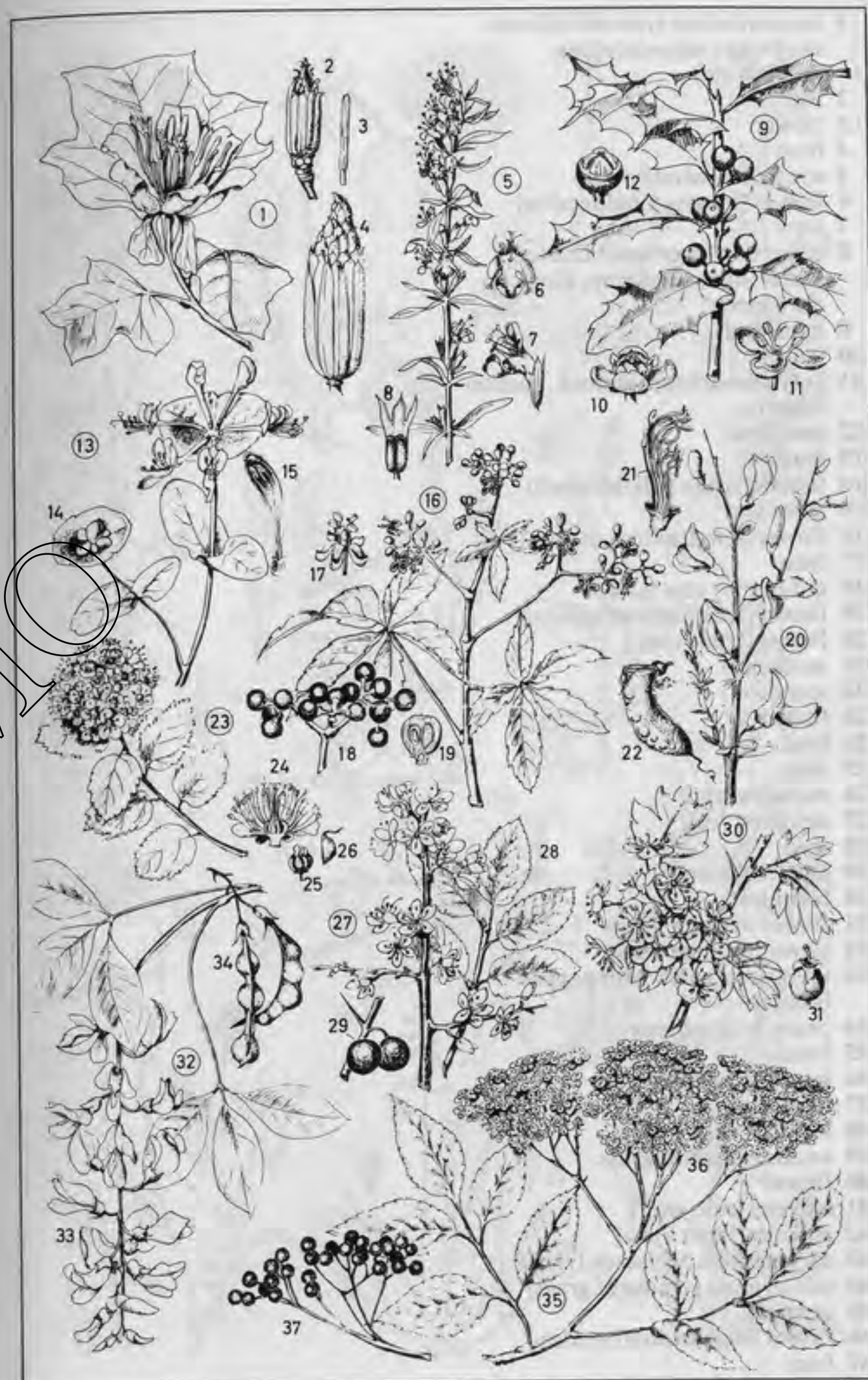

- 1 rotundifoliate (rotundifolious)
saxifrage (rotundifoliate
breakstone)
- 2 leaf
- 3 flower
- 4 fruit
- 5 anemone (windflower)
- 6 flower [longitudinal section]
- 7 fruit
- 8 buttercup (meadow buttercup,
butterflower, goldcup, king cup,
crowfoot)
- 9 basal leaf
- 10 fruit
- 11 lady's smock (ladysmock, cuckoo
flower)
- 12 basal leaf
- 13 fruit
- 14 harebell (hairbell, bluebell)
- 15 basal leaf
- 16 flower [longitudinal section]
- 17 fruit
- 18 ground ivy (ale hoof)
- 19 flower [longitudinal section]
- 20 flower [front view]
- 21 stonecrop
- 22 speedwell
- 23 flower
- 24 fruit
- 25 seed
- 26 moneywort
- 27 dehisced fruit
- 28 seed
- 29 small scabious
- 30 basal leaf
- 31 flower of outer series
- 32 flower of inner series
- 33 involucre calyx with pappus
bristles
- 34 ovary with pappus
- 35 fruit
- 36 lesser celandine
- 37 fruit
- 38 leaf axil with bulbil
- 39 annual meadow grass
- 40 flower
- 41 spikelet [side view]
- 42 spikelet [front view]
- 43 caryopsis (indehiscent fruit)
- 44 tuft of grass (clump of grass)
- 45 comfrey
- 46 flower [longitudinal section]
- 47 fruit

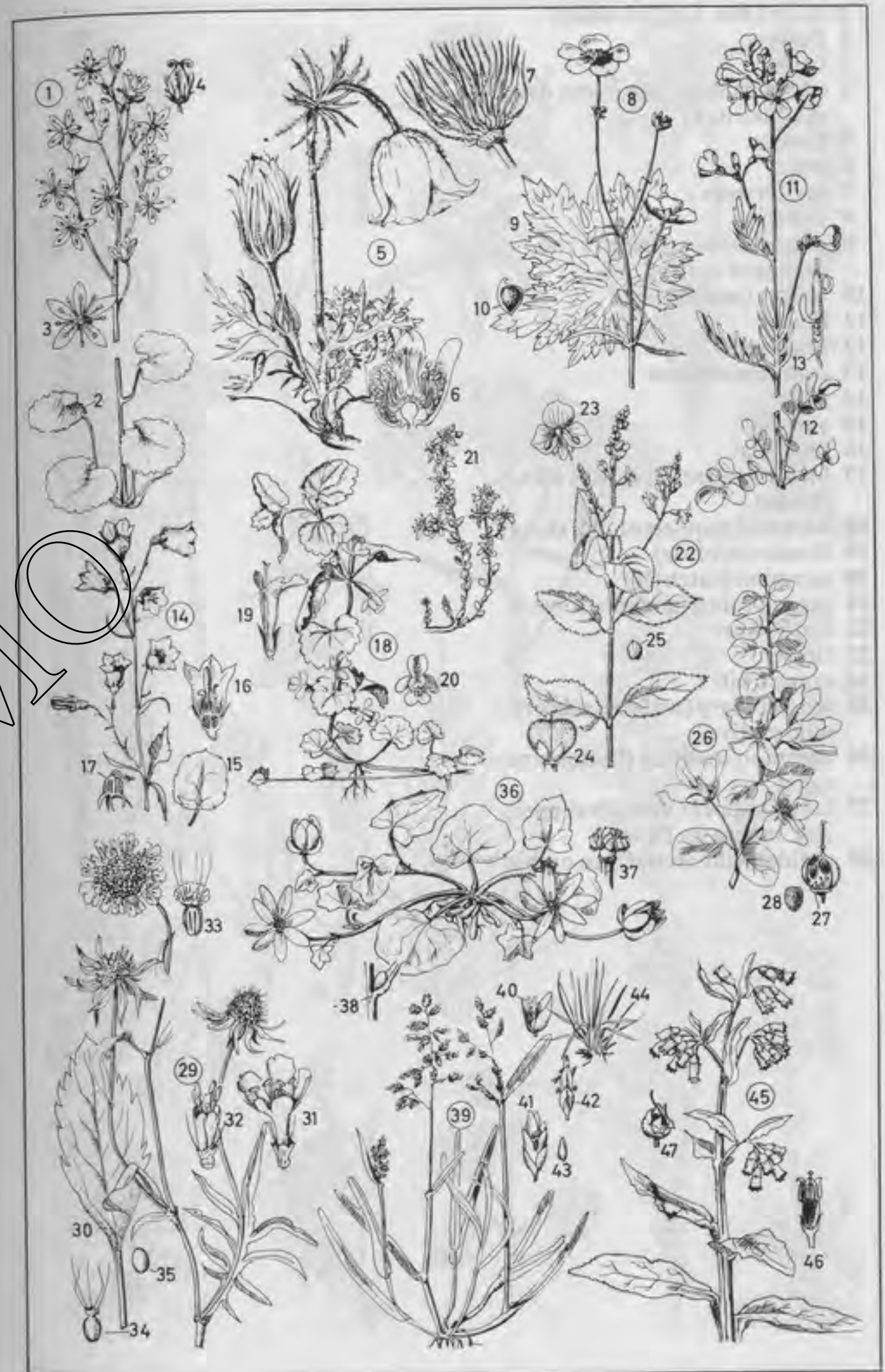

- 1 daisy (*Am.* English daisy)
- 2 flower
- 3 fruit
- 4 oxeye daisy (white oxeye daisy, marguerite)
- 5 flower
- 6 fruit
- 7 masterwort
- 8 cowslip
- 9 great mullein (*Aaron's rod*, shepherd's club)
- 10 bistort (*snakeweed*)
- 11 flower
- 12 knapweed
- 13 common mallow
- 14 fruit
- 15 yarrow
- 16 self-heal
- 17 bird's foot trefoil (*bird's foot clover*)
- 18 horsetail (*equisetum*) [a shoot]
- 19 flower (strobile)
- 20 campion (catchfly)
- 21 ragged robin (*cuckoo flower*)
- 22 birth-wort
- 23 flower
- 24 crane's bill
- 25 wild chicory (*witloof*, succory, wild endive)
- 26 common toadflax (*butter-and-eggs*)
- 27 lady's slipper (*Venus's slipper*, *Am.* moccasin flower)
- 28 orchis (*wild orchid*), an orchid

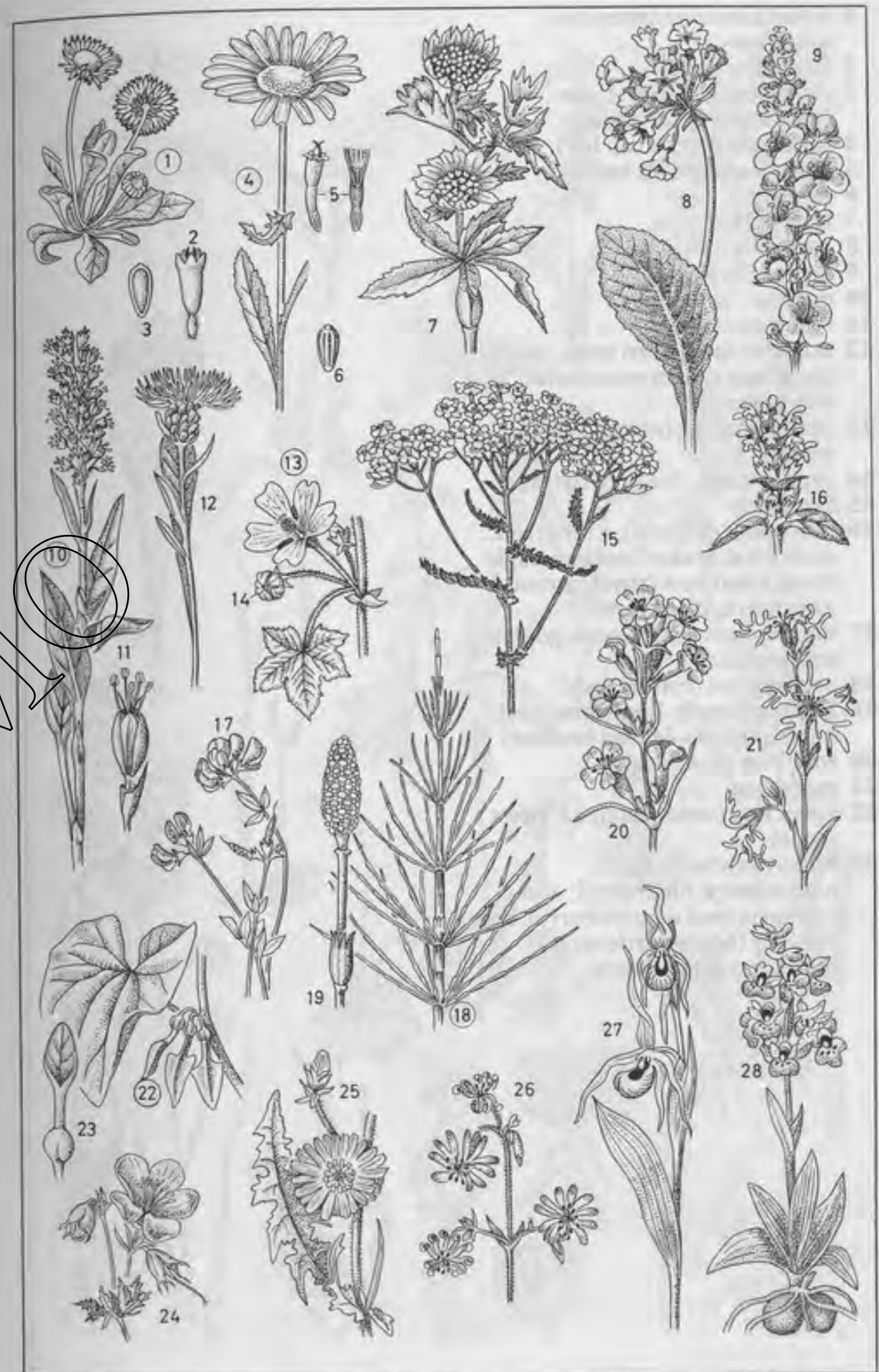

- 1 wood anemone (anemone, windflower)
- 2 lily of the valley
- 3 cat's foot (milkwort); *sim.*: sandflower (everlasting)
- 4 turk's cap (turk's cap lily)
- 5 goatsbeard (goat's beard)
- 6 ramson
- 7 lungwort
- 8 corydalis
- 9 orpine (livelong)
- 10 daphne
- 11 touch-me-not
- 12 staghorn (stag horn moss, stag's horn, stag's horn moss, coral evergreen)
- 13 butterwort, an insectivorous plant
- 14 sundew; *sim.*: Venus's flytrap
- 15 bearberry
- 16 polypody (polypod), a fern; *sim.*: male fern, brake (bracken, eagle fern), royal fern (royal osmund, king's fern, ditch fern)
- 17 haircap moss (hair moss, golden maidenhair), a moss
- 18 cotton grass (cotton rush)
- 19 heather (heath, ling); *sim.*: bell heather (cross-leaved heather)
- 20 rock rose (sun rose)
- 21 marsh tea
- 22 sweet flag (sweet calamus, sweet sedge)
- 23 bilberry (whortleberry, huckleberry, blueberry); *sim.*: cowberry (red whortleberry), bog bilberry (bog whortleberry), crowberry (crakeberry)



**378 Alpine Plants, Aquatic Plants (Water Plants),
and Marsh Plants**

- 1-13 alpine plants
- 1 alpine rose (alpine rhododendron)
- 2 flowering shoot
- 3 alpine soldanella (soldanella)
- 4 corolla opened out
- 5 seed vessel with the style
- 6 alpine wormwood
- 7 inflorescence
- 8 auricula
- 9 edelweiss
- 10 flower shapes
- 11 fruit with pappus tuft
- 12 part of flower head (of capitulum)
- 13 stemless alpine gentian
- 14-57 aquatic plants (water plants) and marsh plants
- 14 white water lily
- 15 leaf
- 16 flower
- 17 Queen Victoria water lily (Victoria regia water lily, royal water lily, Amazon water lily)
- 18 leaf
- 19 underside of the leaf
- 20 flower
- 21 reed mace bulrush (cattail, cat's tail, cattail flag, club rush)
- 22 male part of the spadix
- 23 male flower
- 24 female part
- 25 female flower
- 26 forget-me-not
- 27 flowering shoot
- 28 flower [section]
- 29 frog's bit
- 30 watercress
- 31 stalk with flowers and immature (unripe) fruits
- 32 flower
- 33 siliqua (pod) with seeds
- 34 two seeds
- 35 duckweed (duck's meat)
- 36 plant in flower
- 37 flower
- 38 fruit
- 39 flowering rush
- 40 flower umbel
- 41 leaves
- 42 fruit
- 43 green alga
- 44 water plantain

- 45 leaf
- 46 panicle
- 47 flower
- 48 honey wrack, a brown alga
- 49 thallus (plant body, frond)
- 50 holdfast
- 51 arrow head
- 52 leaf shapes
- 53 inflorescence with male flowers [above] and female flowers [below]
- 54 sea grass
- 55 inflorescence
- 56 Canadian waterweed (Canadian pondweed)
- 57 flower

**Alpine Plants, Aquatic Plants (Water Plants), 378
and Marsh Plants**



- 1 aconite (monkshood, wolfsbane, helmet flower)
- 2 foxglove (*Digitalis*)
- 3 meadow saffron (naked lady, naked boys)
- 4 hemlock (*Conium*)
- 5 black nightshade (common nightshade, petty morel)
- 6 henbane
- 7 deadly nightshade (belladonna, banewort, dwale), a solanaceous herb
- 8 thorn apple (stramonium, stramony, *Am.* jimson weed, jimpson weed, Jamestown weed, stinkweed)
- 9 cuckoo pint (lords-and-ladies, wild arum, wake-robin)
- 10-13 poisonous fungi (poisonous mushrooms, toadstools)
- 10 fly agaric (fly amanita, fly fungus), an agaric
- 11 amanita
- 12 Satan's mushroom
- 13 woolly milk cap

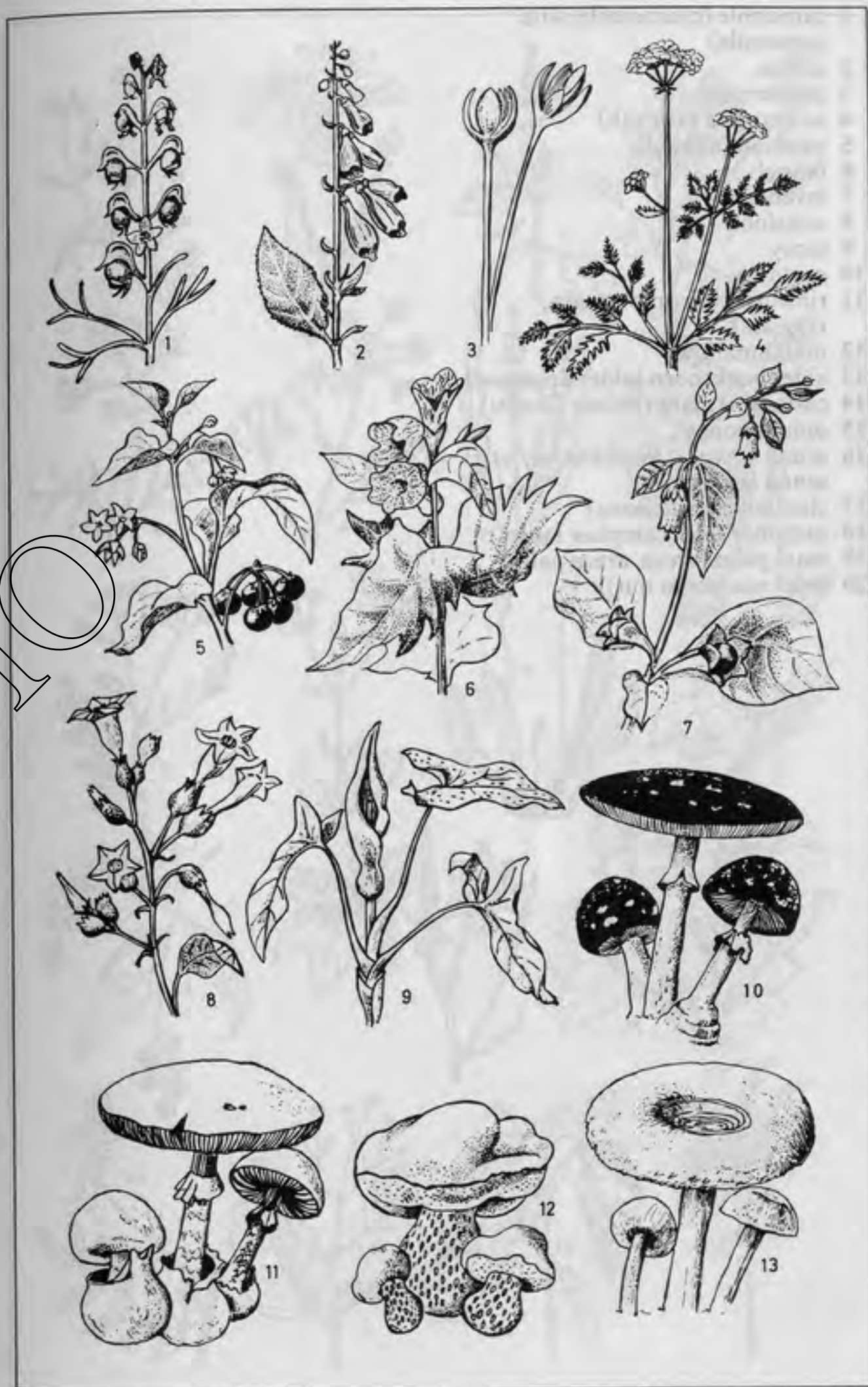

- 1 camomile (chamomile, wild camomile)
- 2 arnica
- 3 peppermint
- 4 wormwood (absinth)
- 5 valerian (allheal)
- 6 fennel
- 7 lavender
- 8 coltsfoot
- 9 tansy
- 10 centaury
- 11 ribwort (ribwort plantain, ribgrass)
- 12 marshmallow
- 13 alder buckthorn (alder dogwood)
- 14 castor-oil plant (Palma Christi)
- 15 opium poppy
- 16 senna (cassia); *the dried leaflets:*
senna leaves
- 17 cinchona (chinchona)
- 18 camphor tree (camphor laurel)
- 19 betel palm (areca, areca palm)
- 20 betel nut (areca nut)

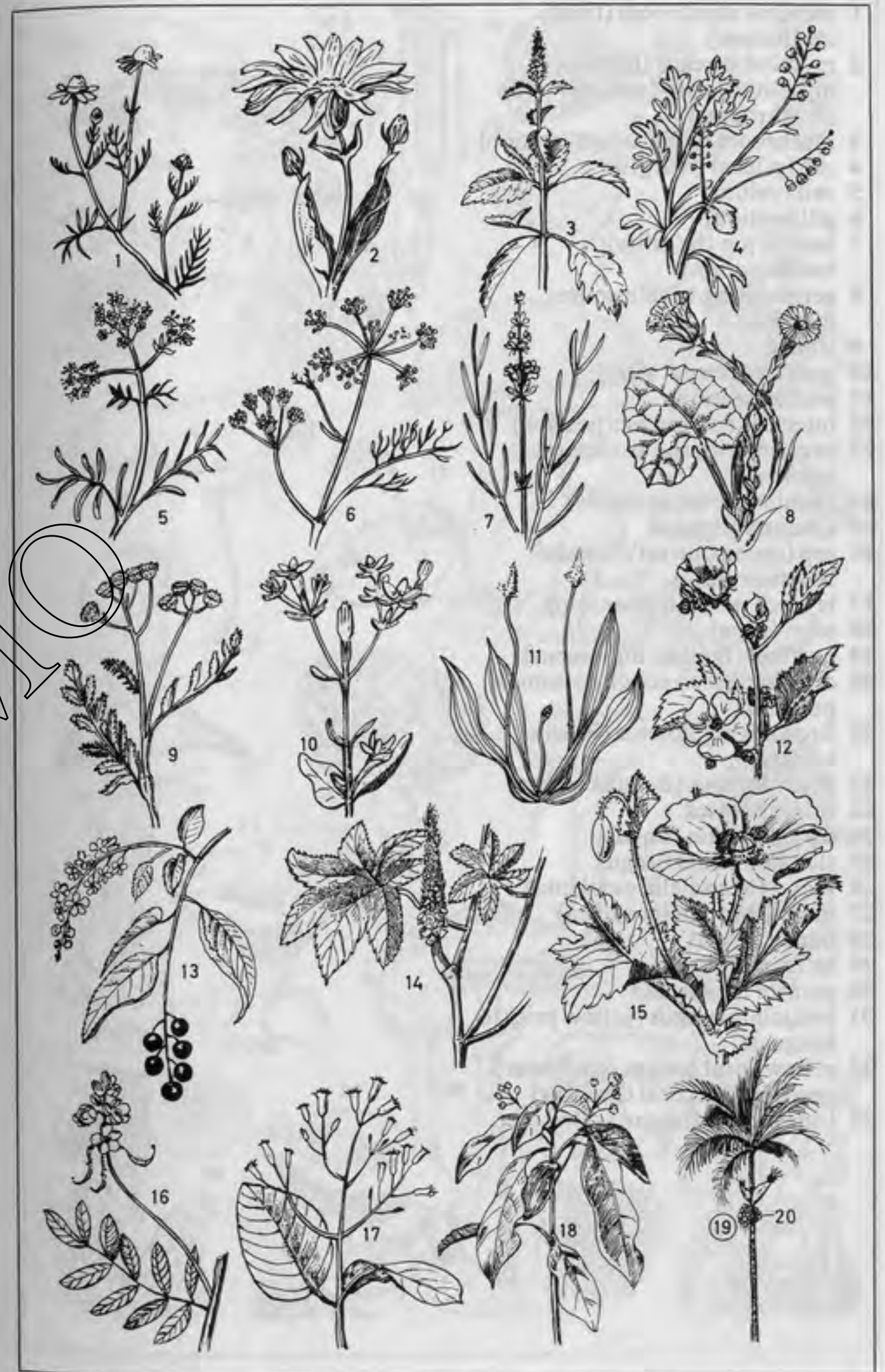

- 1 meadow mushroom (field mushroom)
- 2 mycelial threads (hyphae, mycelium) with fruiting bodies (mushrooms)
- 3 mushroom [longitudinal section]
- 4 cap (pileus) with gills
- 5 veil (velum)
- 6 gill [section]
- 7 basidia [on the gill with basidiospores]
- 8 germinating basidiospores (spores)
- 9 truffle
- 10 truffle [external view]
- 11 truffle [section]
- 12 interior showing asci [section]
- 13 two asci with the ascospores (spores)
- 14 chanterelle (chantarelle)
- 15 Chestnut Boletus
- 16 cep (cepe, squirrel's bread, *Boletus edulis*)
- 17 layer of tubes (hymenium)
- 18 stem (stipe)
- 19 puffball (*Bovista nigrescens*)
- 20 devil's tobacco pouch (common puffball)
- 21 Brown Ring Boletus (*Boletus luteus*)
- 22 Birch Boletus (*Boletus scaber*)
- 23 *Russula vesca*
- 24 scaled prickle fungus
- 25 slender funnel fungus
- 26 morel (*Morchella esculenta*)
- 27 morel (*Morchella conica*)
- 28 honey fungus
- 29 saffron milk cap
- 30 parasol mushroom
- 31 hedgehog fungus (yellow prickle fungus)
- 32 yellow coral fungus (goatsbeard, goat's beard, coral *Clavaria*)
- 33 little cluster fungus

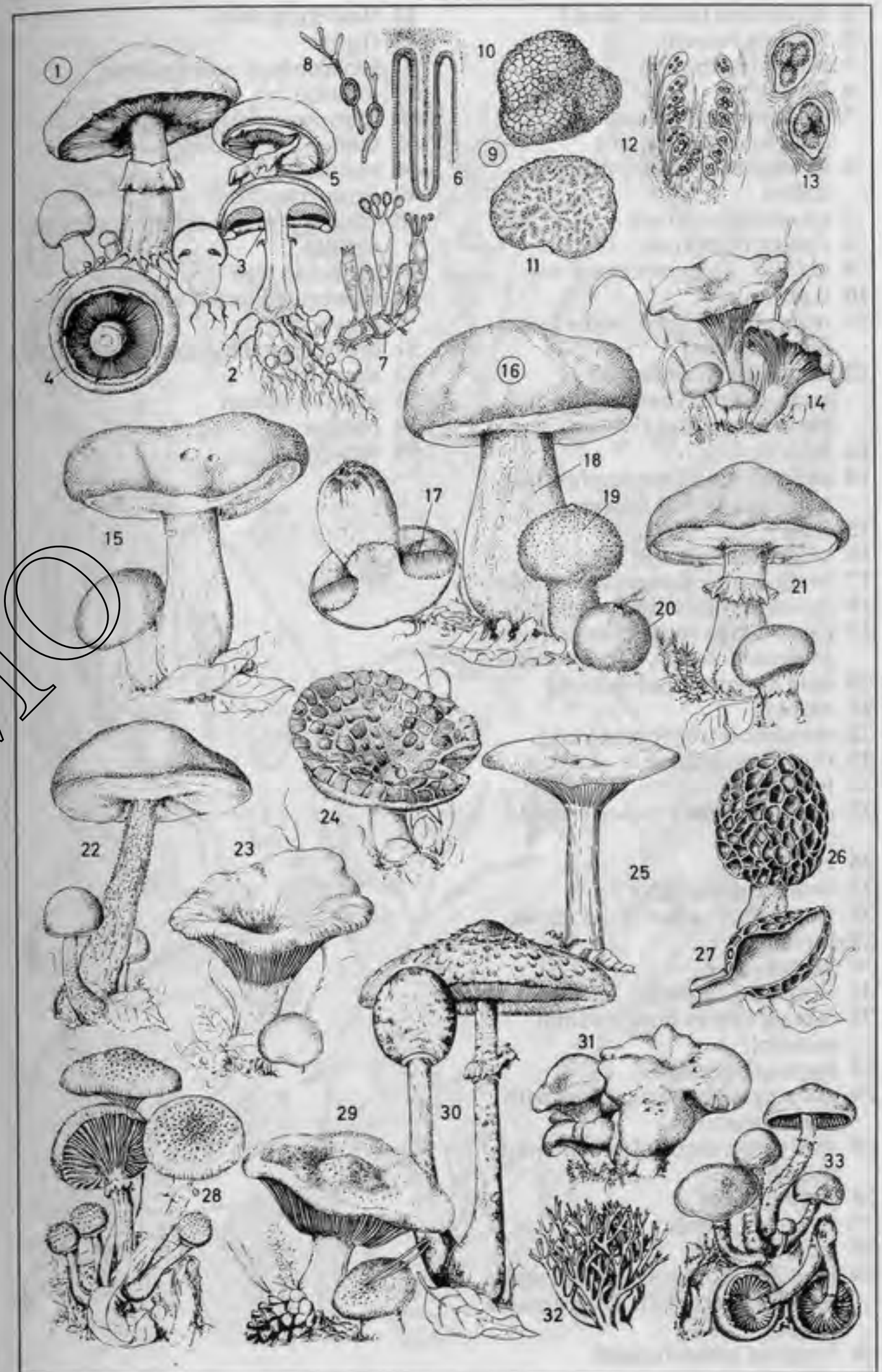

**382 Tropical Plants used as Stimulants, Spices,
and Flavourings (Am. Flavorings)**

- 1 coffee tree (coffee plant)
- 2 fruiting branch
- 3 flowering branch
- 4 flower
- 5 fruit with two beans
[longitudinal section]
- 6 coffee bean; *when processed:*
coffee
- 7 tea plant (tea tree)
- 8 flowering branch
- 9 tea leaf; *when processed:* tea
- 10 fruit
- 11 maté shrub (maté, yerba maté,
Paraguay tea)
- 12 flowering branch with
androgynous (hermaphroditic,
hermaphrodite) flowers
- 13 male flower
- 14 androgynous (hermaphroditic,
hermaphrodite) flower
- 15 fruit
- 16 cacao tree (cacao)
- 17 branch with flowers and fruits
- 18 flower [longitudinal section]
- 19 cacao beans (cocoa beans); *when
processed:* cocoa, cocoa powder
- 20 seed [longitudinal section]
- 21 embryo
- 22 cinnamon tree (cinnamon)
- 23 flowering branch
- 24 fruit
- 25 cinnamon bark; *when crushed:*
cinnamon
- 26 clove tree
- 27 flowering branch
- 28 flower bud; *when dried:* clove
- 29 flower
- 30 nutmeg tree
- 31 flowering branch
- 32 female flower [longitudinal
section]
- 33 mature (ripe) fruit
- 34 nutmeg with mace, a seed with
lacinate aril
- 35 seed [cross section]; *when dried:*
nutmeg
- 36 pepper plant
- 37 fruiting branch
- 38 inflorescence
- 39 fruit [longitudinal section] with
seed (peppercorn); *when ground:*
pepper
- 40 Virginia tobacco plant

- 41 flowering shoot
- 42 flower
- 43 tobacco leaf; *when cured:*
tobacco
- 44 mature (ripe) fruit capsule
- 45 seed
- 46 vanilla plant
- 47 flowering shoot
- 48 vanilla pod; *when cured:* stick of
vanilla
- 49 pistachio tree
- 50 flowering branch with female
flowers
- 51 drupe (pistachio, pistachio nut)
- 52 sugar cane
- 53 plant in bloom
- 54 panicle
- 55 flower

**Tropical Plants used as Stimulants, Spices, 382
and Flavourings (Am. Flavorings)**

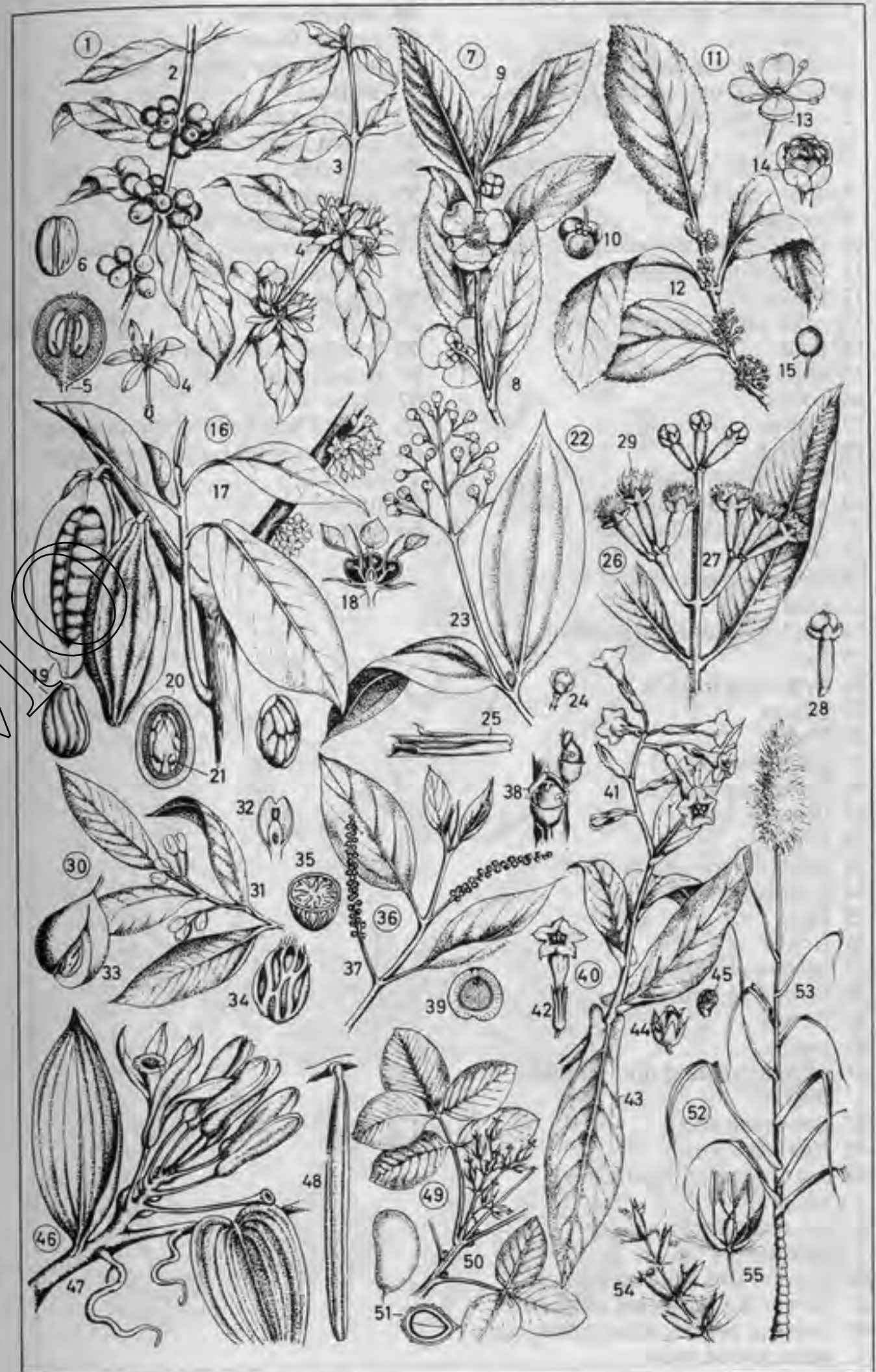

- 1 rape (cole, coleseed)
- 2 basal leaf
- 3 flower [longitudinal section]
- 4 mature (ripe) siliqua (pod)
- 5 oleiferous seed
- 6 flax
- 7 peduncle (pedicel, flower stalk)
- 8 seed vessel (boll)
- 9 hemp
- 10 fruiting female (pistillate) plant
- 11 female inflorescence
- 12 flower
- 13 male inflorescence
- 14 fruit
- 15 seed
- 16 cotton
- 17 flower
- 18 fruit
- 19 lint [cotton wool]
- 20 silk-cotton tree (kapok tree, capoc tree, ceiba tree)
- 21 fruit
- 22 flowering branch
- 23 seed
- 24 seed [longitudinal section]
- 25 jute
- 26 flowering branch
- 27 flower
- 28 fruit
- 29 olive tree (olive)
- 30 flowering branch
- 31 flower
- 32 fruit
- 33 rubber tree (rubber plant)
- 34 fruiting branch
- 35 fig
- 36 flower
- 37 gutta-percha tree
- 38 flowering branch
- 39 flower
- 40 fruit
- 41 peanut (ground nut, monkey nut)
- 42 flowering shoot
- 43 root with fruits
- 44 nut (kernel) [longitudinal section]
- 45 sesame plant (simsim, benniseed)
- 46 flowers and fruiting branch
- 47 flower [longitudinal section]
- 48 coconut palm (coconut tree, coco palm, cocoa palm)

- 49 inflorescence
- 50 female flower
- 51 male flower [longitudinal section]
- 52 fruit [longitudinal section]
- 53 coconut (cokernut)
- 54 oil palm
- 55 male spadix
- 56 infructescence with fruit
- 57 seed with micropyles (foramina) (foraminate seed)
- 58 sago palm
- 59 fruit
- 60 bamboo stem (bamboo culm)
- 61 branch with leaves
- 62 spike
- 63 part of bamboo stem with joints
- 64 papyrus plant (paper reed, paper rush)
- 65 umbel
- 66 spike

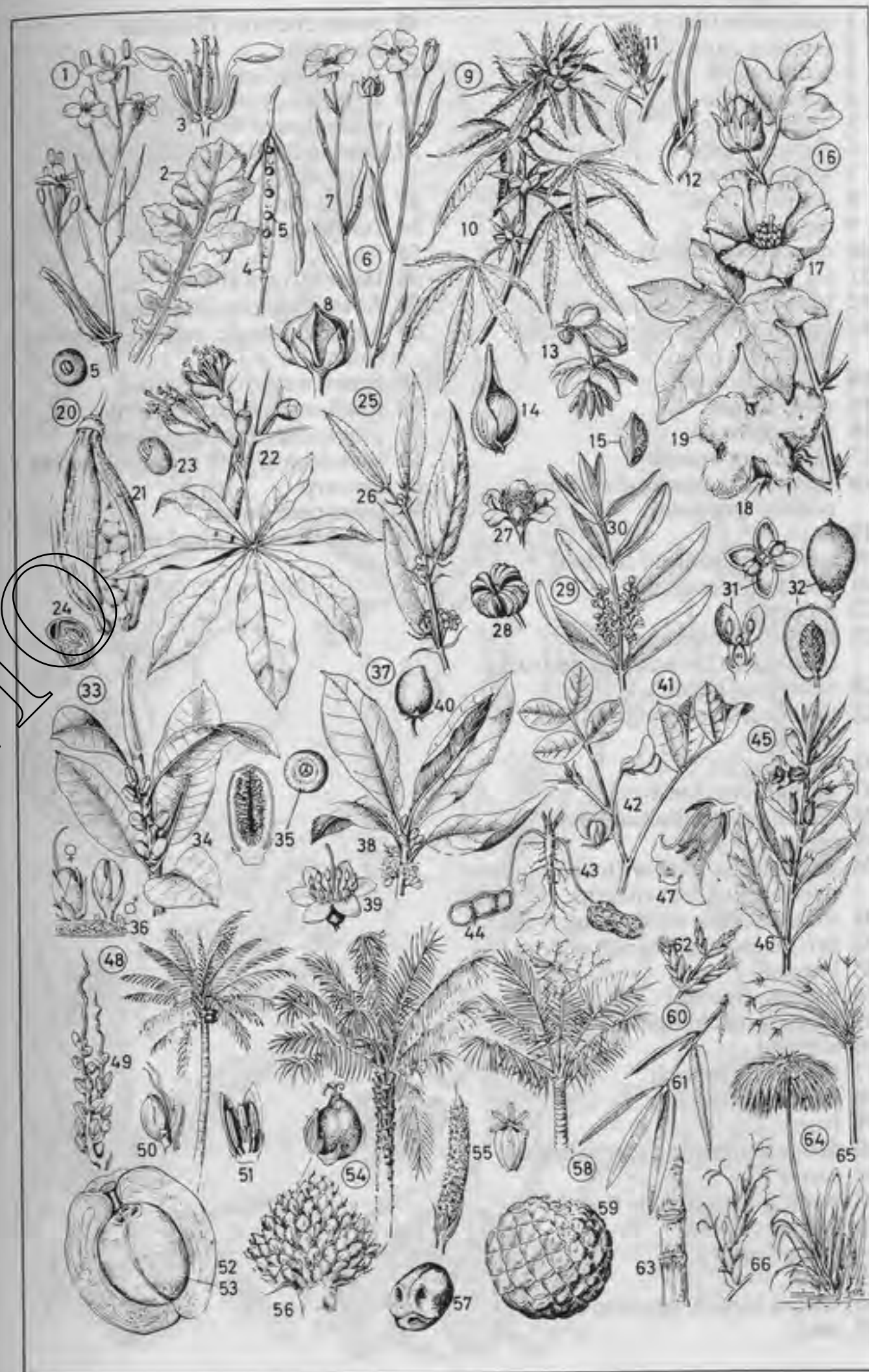

- 1 date palm (date)
- 2 fruiting palm
- 3 palm frond
- 4 male spadix
- 5 male flower
- 6 female spadix
- 7 female flower
- 8 stand of fruit
- 9 date
- 10 date kernel (seed)
- 11 fig
- 12 branch with pseudocarps
- 13 fig with flowers [longitudinal section]
- 14 female flower
- 15 male flower
- 16 pomegranate
- 17 flowering branch
- 18 flower [longitudinal section, corolla removed]
- 19 fruit
- 20 seed [longitudinal section]
- 21 seed [cross section]
- 22 embryo
- 23 lemon; *sim.*: tangerine (mandarin), orange, grapefruit
- 24 flowering branch
- 25 orange flower [longitudinal section]
- 26 fruit
- 27 orange [cross section]
- 28 banana plant (banana tree)
- 29 crown
- 30 herbaceous stalk with overlapping leaf sheaths
- 31 inflorescence with young fruits
- 32 infructescence (bunch of fruit)
- 33 banana
- 34 banana flower
- 35 banana leaf [diagram]
- 36 almond
- 37 flowering branch
- 38 fruiting branch
- 39 fruit
- 40 drupe containing seed [almond]
- 41 carob
- 42 branch with female flowers
- 43 female flower
- 44 male flower
- 45 fruit
- 46 siliqua (pod) [cross section]
- 47 seed

- 48 sweet chestnut (Spanish chestnut)
- 49 flowering branch
- 50 female inflorescence
- 51 male flower
- 52 cupule containing seeds (nuts, chestnuts)
- 53 Brazil nut
- 54 flowering branch
- 55 leaf
- 56 flower [from above]
- 57 flower [longitudinal section]
- 58 opened capsule, containing seeds (nuts)
- 59 Brazil nut [cross section]
- 60 nut [longitudinal section]
- 61 pineapple plant (pineapple)
- 62 pseudocarp with crown of leaves
- 63 syncarp
- 64 pineapple flower
- 65 flower [longitudinal section]



In the index the entries are ordered as follows:

1. Entries consisting of single words, e.g.: 'hair'.
2. Entries consisting of noun + adjective. Within this category the adjectives are entered alphabetically, e.g. 'hair, bobbed' is followed by 'hair, closely-cropped'.

Where adjective and noun are regarded as elements of a single lexical item, they are not inverted, e.g.: 'blue spruce', not 'spruce, blue'.

3. Entries consisting of other phrases, e.g. 'hair curler', 'ham on the bone', are alphabetized as headwords.

Where a whole phrase makes the meaning or use of a headword highly specific, the whole phrase is entered alphabetically. For example 'ham on the bone' follows 'hammock'.

References

The numbers in bold type refer to the sections in which the word may be found, and those in normal type refer to the items named in the pictures. Homonyms, and in some cases uses of the same word in different fields, are distinguished by section headings (in italics), some of which are abbreviated, to help to identify at a glance the field required. In most cases the full form referred to by the abbreviations will be obvious. Those which are not are explained in the following list:

<i>Agr.</i>	Agriculture/Agricultural	<i>Hydr. Eng.</i>	Hydraulic Engineering
<i>Alp. Plants</i>	Alpine Plants	<i>Impl.</i>	Implements
<i>Art. Studio</i>	Artist's Studio	<i>Inf. Tech.</i>	Information Technology
<i>Bldg.</i>	Building	<i>Intern. Combust. Eng.</i>	Internal Combustion Engine
<i>Carp.</i>	Carpenter	<i>Moon L.</i>	Moon Landing
<i>Cement Wks.</i>	Cement Works	<i>Music Not.</i>	Musical Notation
<i>Cost.</i>	Costumes	<i>Overh. Irrign.</i>	Overhead Irrigation
<i>Cyc.</i>	Cycle	<i>Platem.</i>	Platemaking
<i>Decid.</i>	Deciduous	<i>Plant. Propagn.</i>	Propagation of Plants
<i>D.I.Y.</i>	Do-it-yourself	<i>Rm.</i>	Room
<i>Dom. Anim.</i>	Domestic Animals	<i>Sp.</i>	Sports
<i>Equest.</i>	Equestrian Sport	<i>Text.</i>	Textile[s]
<i>Gdn.</i>	Garden	<i>Veg.</i>	Vegetable[s]

A

- Aaron's rod **376 9**
 abacus **309 77**
 abacus *Art* **334 20**
 abator **94**
 abdomen *Man* **16 35-37, 36**
 abdomen *Bee* **77 10-19**
 abdomen *Fores. Pests* **82 9**
 abdomen, lower ~ **16 37**
 abdomen, upper ~ **16 35**
 abductor hallucis **18 49**
 abductor of the hallux **18 49**
 abelvine **361 8**
 aborigine, Australian ~ **352 37**
 abrasion platform **13 31**
 abrasive wheel combination **111 28, 35**
 abscissa **347 9**
 abseiling **300 28-30**
 abseil piton **300 39**
 abseil sling **300 28**
 absinth **380 4**
 absorber attachment **27 44**
 absorption dynamometer **143 97-107**
 absorption muffler **190 16**
 absorption silencer **190 16**
 abutment *Bridges* **215 27, 29, 45**
 abutment *Art* **336 20**
 abutment pier **215 29**
 acanthus **334 25**
 acceleration rocket **234 22, 48**
 accelerator **191 46**
 accelerator lock **85 17**
 accelerator pedal **191 46, 94**
 accelerometer **230 10**
 accent, acute ~ **342 30**
 accent, circumflex ~ **342 32**
 accent, grave ~ **342 31**
 accent, strong ~ **321 27**
 accents **342 30-35**
 acceptance **250 12, 23**
 access balcony **37 72-76**
 access flap **6 21, 25**
 accessories **115 43-105**
 accessory shoe **114 4; 115 20**
 accessory shop **196 24**
 access ramp **199 15**
 acciaccatura **321 15**
 accipiters **362 10-13**
 accolade **329 66**
 accommodation **146 33**
 accommodation bureau **204 28**
 accommodation ladder **221 98**
 accommodation module **146 33**
 accompaniment side **324 43**
 accompaniment string **324 25**
 accordion **324 36**
 account, private ~ **250 4**
 accounting machine **236 26**
 accumulator **309 41**
 accumulator *Theatre* **316 55**
 accumulator railcar **211 55**
 accuracy jump **288 55**
 acerate **370 34**
 acerose **370 34**
 acerous **370 34**
 acetylene connection **141 31**
 acetylene control **141 32**
 acetylene cylinder **141 2, 22**
 achene **58 23**
 achievement **254 1-6**
 achievement, marital ~ **254 10-13**
 achievement of arms **254 1-6**
 Achilles' tendon **18 48**
 acicular **370 34**
 acid container **350 62**
 Ackermann steering system **85 31, 37**
 acolyte **331 45**
 aconite **379 1**
 acorn **371 4**
 acorns **276 42**
 acrobat **307 47**
 Acropolis **334 1-7**
 acroter **334 34**
 acroterion **334 34**
 acroterium **334 34**
 acting area light **316 16**
 acting area spotlight **316 16**
 actinia **369 20**
 Actinophrys **357 7**
 action **326 6-16**
 action lever **325 32**
 activated blade attachment **84 33**
 actor **316 37**
 actress **316 38**
 actuating transistor **195 19**
 acuity projector **111 47**
 acute **342 30**
 ad **342 56**
 Adam's apple **19 13**
 adapter **112 55**
 adapter, four-socket ~ **127 8**
 adapter, four-way ~ **127 8**
 adapter ring **115 82**
 adapter unit **242 34**
 adders **364 40-41**
 adding **344 23**
 adding machine **309 74**
 adding mechanism **271 9**
 addition **344 23**
 address **236 42**
 address display **236 41**
 addressing machine, transfer-type ~ **245 7**
 address label **236 4**
 address system, ship's ~ **224 30**
 A-deck **223 28-30**
 adhesion railcar **214 1**
 adhesive, hot ~ **249 61**
 adhesive binder *Bookbind.* **184 1**
 adhesive binder *Office* **249 61**
 adhesive tape dispenser **247 27**
 adhesive tape dispenser, roller-type ~ **247 28**
 adhesive tape holder **247 28**
 adjusting cone **187 58**
 adjusting equipment **148 61-65**
 adjusting knob **116 54**
 adjusting nut **143 35**
 adjusting screw *Bldg. Site* **119 79**

adjusting screw

adjusting screw *Mach. Parts etc.* 143 107
 adjusting screw *Inf. Tech.* 242 78
 adjusting spindle 226 51
 adjusting washer 187 55
 adjustment, circular ~ 14 62
 adjustment, coarse ~ 112 4
 adjustment, fine ~ *Optic. Instr.* 112 5
 adjustment, fine ~ *Photog.* 116 33
 adjustment, fine ~ *Joiner* 133 36
 adjustment, fine ~ *Drawing Off.* 151 66
 adjustment knob 11 41
 administration area 5 17
 administration building *Coal* 144 18
 administration building *Airport* 233 16
 administration building *Films* 310 4
 Admiralty anchor 286 15
 admission ticket 315 11
 adult insect 358 10
 advance booking office 271 26
 adventure playground 273 21
 advertisement 98 2; 204 10; 268 43, 71; 271 25; 312 23; 342 56, 69
 advertising, classified ~ 342 69
 advertising calendar 22 10
 advertising pillar 268 70
 adze 300 34
 aerator 56 15
 aerial 213 4
 aerial ladder 270 9
 aerial sports 288
 aerobatic manoeuvres 288 1-9
 aerobatics 288 1-9
 aero engines 232 33-60
 aerofoil, rear ~ 290 35
 aerogenerator 55 34; 155 42
 aeroplane 230 67-72
 aeroplane, propeller-driven ~ 231 1-6
 aeroplane, types of ~ 231 1-33
 aeroplane tow launch 287 1
 aerotowing 287 1
 aero wheel 305 79
 Afghan 70 23
 Afghan hound 70 23
 A flat major 320 66
 Africa 14 14
 African hemp 53 9
 African marigold 60 20
 Afro look 34 26
 afterburner exhaust nozzle 256 13
 aftercastle 218 23
 after deck 223 32
 afterpeak 227 28
 aftershave lotion 49 38
 aft fan-jet 232 42
 aft ship 286 34, 37, 41
 agaric 379 10

agate 175 22
 agent 307 18
 aggregate scraper 200 13
 agitator *Agr. Mach.* 64 70
 agitator *Paperm.* 172 47
 agricultural implements 66
 agricultural machinery 64; 65
 agricultural worker 63 5
 agriculture 63
 Agulhas Current 14 37
 aileron 230 52; 287 41; 288 28
 aileron, inner ~ 229 43
 aileron, outer ~ 229 41
 aileron actuator 257 39
 aiming position 86 34
 air-bed, inflatable ~ 278 31
 air blast 139 56
 air-blast circuit breaker 152 34; 153 51-62
 air-bleed duct *Roof & Boilerr.* 38 51
 air-bleed duct *Intern. Combust. Eng.* 190 12
 air blower, primary ~ 160 11
 air brake 229 44; 256 12
 airbus 231 17
 air cleaner 191 55
 air compressor *Painter* 129 33
 air compressor *Offshore Drill.* 146 23
 air compressor *Railw.* 211 14, 44; 212 34, 58, 72
 air compressor, diesel-powered ~ 200 39
 air compressor, mobile ~ 200 39
 air-conditioning 26 20
 air-conditioning equipment 239 15
 air correction jet 192 3
 aircraft 229; 230; 231; 232
 aircraft, propeller-driven ~ 231 1-6
 aircraft, single-engine ~ 230 1-31, 32-66; 231 1, 2
 aircraft, tilt-wing ~ 232 26
 aircraft, twin-boom ~ 229 34
 aircraft, twin-engine ~ 231 3
 aircraft, twin-jet ~ 231 7
 aircraft, types of ~ 231 1-33
 aircraft cannon 256 3
 aircraft carrier, nuclear-powered ~ 259 1
 aircraft elevator 259 4, 13
 aircraft engines 232 33-60
 aircraft lift 259 4, 13
 aircraft tractor 233 23
 aircraft tug 233 23
 air currents 9 25-29
 air cushion 286 66
 air-cushion vehicle 286 63
 air duct 155 35
 ailer 50 32
 ailer, extending ~ 50 34
 air extraction vent 154 21
 air extractor duct 258 57
 air extractor pipe 133 40
 air feed pipe 147 29
 air filler neck 196 21
 air filter 191 55
 air flow 199 45

air flow, secondary ~ 232 50
 air force 256; 257
 air hose *Garage* 195 54
 air hose *Serv. Stat.* 196 18
 air inlet *Lorries etc.* 194 16
 air inlet *Warships* 259 73
 air inlet *Fire Brig.* 270 60
 air inlet and outlet 92 14
 air intake *Car* 192 60
 air intake *Railw.* 209 11
 air intake *Air Force* 256 5; 257 12
 air intake, annular ~ 232 52
 air intake duct 257 14
 air jet pipe 281 41
 air line 75 28
 airliner, four-jet ~ 231 13
 airliner, supersonic ~ 231 15
 airliner, tri-jet ~ 231 12
 airliner, twin-jet ~ 231 11, 17
 airliner, wide-body ~ 231 14, 17
 air lock *Coal* 144 38
 air lock *Offshore Drill.* 146 24
 air lock *Space* 235 27
 air lock *Chem.* 349 7
 air masses, homogeneous ~ 8 1-4
 air mattress 278 31
 air outlet 168 29
 air oxidation passage 165 48
 air passage 333 4
 airplane see aeroplane
 airport 233
 'airport' 233 24
 airport fire service 233 7
 airport information symbols 233 24-53
 airport restaurant 233 19
 air preheater *Forging* 139 53
 air preheater *Power Plant* 152 11
 air pump *Paperm.* 172 40
 air pump *Letterpress* 181 4, 35
 air receiver 269 17, 50
 air refuelling probe 256 7
 air regenerator chamber 147 30
 air regulator *Offset Print.* 180 74
 air regulator *Chem.* 350 3, 8
 air reservoir, auxiliary ~ 212 61
 air reservoir, main ~ 211 8; 212 57, 71
 air rifle 305 40
 air rifle cartridge 305 34
 airscrew 230 32; 288 36
 air space 74 61
 air-speed indicator 230 2
 airsports 288
 airstream, cold ~ 9 29
 airstream, main ~ 192 5
 airstream, warm ~ 9 28
 air supply 155 24
 air survey camera 14 63
 air temperature 280 8
 air vent cap 38 52
 air vessel 269 17, 50
 aisle *Map* 15 112
 aisle *Forestry* 84 1

aisle *Church* 330 27
 aisle *Art* 334 63, 335 2
 alarm clock 110 19
 alarm clock, electric ~ 43 16
 albumen 74 62
 albuminum *Corp.* 120 85
 albuminum *Bot.* 370 12
 Alcor 3 29
 Aldebaran 3 25
 alder 371 30
 alder buckthorn 380 13
 alder dogwood 380 13
 alder-swamp peat 13 18
 ale 93 26
 ale hoof 375 18
 Alençon lace 102 30
 alfalfa grass 136 26
 alga, brown ~ 378 48
 alga, green ~ 378 43
 algebra 345 4-5
 alighting board 77 49
 alkali-cellulose 169 9
 alkali-cellulose crumbs 169 7
 Allais chicane 301 72
 all-container ship 221 21; 226 5
 Aller rock salt 154 63
 allheal 380 5
 allonge newwig 34 2
 allotment 52 32
 allotment holder 52 24
 all-purpose gun 258 70
 all-purpose gun, radar-controlled ~ 258 47, 48
 all-purpose trailer 62 40
 all-purpose vehicle 255 96
 all-weather aileron 229 43
 alluvial deposit 216 52
 all-weather roof 200 38
 all-wheel drive 194 1
 almond *Tablew. etc.* 45 41
 almond *South, Fruits* 384 36
 aloe 53 13
 alphanumeric disc store 176 33
 alpha particle 1-31; 227
 alpha radiation 1 30-31
 Alpine Club hut 300 1
 alpine rhododendron 378 1
 alpine rose 378 1
 alpine soldanella 378 3
 alpine strawberry 58 16
 alpine wormwood 378 6
 Alpinism 300 1-57
 Alpinist 300 5
 Alsatian 70 25
 alsike 69 3
 alsike clover 69 3
 Altair 3 9
 altar 330 4, 33; 334 48, 69
 altar bell 332 52
 altar candle 330 7, 34
 altar carpet 330 3
 altar cloth 330 6, 36
 altar cross 330 35
 altar crucifix 330 12
 altar decoration 330 48
 altarpiece 330 13, 50
 altar steps 330 5, 31
 alternative school 261 1-45
 alternator 152 23; 153 1

altimeter 230 4
 altitude 346 27
 altitude scale 7 35
 alto clef 320 10
 altocumulus 8 15
 altocumulus castellanus 8 16
 altocumulus floccus 8 16
 altostratus 8 8
 altostratus praecipitans 8 9
 alto trombone 323 46
 aluminium foil, asphalted ~ 155 29
 aluminium see aluminium
 A major 320 58
 amanita 379 11
 amaryllis 53 8
 Amazon water lily 378 17
 ambulance 270 19
 ambulance, armoured ~ 255 79
 ambulance attendant 270 21
 ambulance car 270 19
 ambulance man 270 21
 America 14 12-13
 American blight 80 32
 American football 292 22
 American ivy 51 5; 374 16
 A minor 320 55, 62
 A minor scale 320 46, 47, 48
 ammeter *Car* 191 78
 ammeter *Aircraft* 230 18
 ammonia 170 24
 ammonia scrubber 156 23
 ammonia wet collector 156 23
 ammonium sulphate 156 36
 ammonium sulphate, production of ~ 156 35
 ammonium sulphate solution 170 26
 ammunition 87 19; 305 34-49
 amoeba 357 1
 amoretto 272 20
 amorino 272 20
 Amphibia 364; 364 20-26
 amphibian 232 8
 amphibians 364 20-26
 amplifier 241 40; 312 19; 317 23
 amplifier, underwater ~ 237 57
 amplifier and mains power unit 238 3
 amplifier equipment 310 59
 amplitude adjustment 10 11
 amulet 354 40
 anaesthesia and breathing apparatus 26 1
 anaesthesia and respiratory apparatus 26 24
 anaesthetic, local ~ 24 53
 analog see analogue
 analogue control 242 38
 analogue output 112 45
 analyser 23 53
 analysis, automatic ~ 25 48
 analytical balance 349 25
 anchor 223 52; 259 81
 anchor, lightweight ~ 286 16-18
 anchor, stocked ~ 222 79; 286 15

animals, one-celled

anchor, stockless ~ 222 78; 258 5; 286 17
 anchorage 216 13
 anchor cable 218 18; 222 77; 223 50; 227 12
 anchor capstan 258 6
 anchor hawser 218 18
 anchor rib 287 32
 anchor rope 218 18
 anchors 286 15-18
 anchor winch 259 82
 ancillary brake valve 211 23
 Andromeda 3 24
 anemometer 10 28
 anemone 375 5; 377 1
 aneroid barometer 10 4
 aneroid box 10 6
 aneroid capsule 10 6
 angiographic examination table 27 26
 angiography room 27 12
 angle *Mach. Parts etc.* 143 1
 angle *Maths.* 346 1-23; 346 8-13, 8, 55
 angle, acute ~ 346 10
 angle, adjacent ~ 346 14
 angle, alternate ~ 346 10
 angle, circumferential ~ 346 56
 angle, exterior ~ 346 26
 angle, interior ~ 346 26
 angle, obtuse ~ 346 11
 angle, straight ~ 346 13, 9-15
 angle brace 118 25; 119 63; 121 57
 angle deck 259 12
 angle iron 143 1
 angle of departure 87 75
 angle of descent 87 78
 angle of dip 12 3
 angle of elevation 87 76
 angle of rotation 351 33
 angle of the mouth 16 14; 19 19
 angle shears 125 2
 angle symbol 345 23
 angle tie 118 25; 121 57
 angle tongs 137 37
 angle tower 329 14, 17
 angling 89 20-94
 angling fence 133 19
 Angora cat 73 17
 Angoumois grain moth 81 29
 Angoumois grain moth caterpillar 81 30
 Angoumois moth 81 29
 Anguidae 364 37
 animal, cloven-hoofed ~ 73 9
 animal, inflatable ~ 280 33
 animal, rubber ~ 280 33
 animal, toy ~ 46 13; 47 6
 animal, wild ~ 307 56
 animal enclosure 272 49
 animal house 356 10
 animals, domestic ~ 73 18-36
 animals, fabulous ~ 327 1-61
 animals, multicellular ~ 357 13-39
 animals, one-celled ~ 357 1-12

animals, single-celled ~ 357
1-12
animals, unicellular ~ 357
1-12
ankle guard 291 33
ankle sock, children's ~ 29 30
annealing lehr 162 18
annelid 357 20
annexe 331 13
annuity 251 11-19
annulus 346 57
Annunciation lily 60 12
anode, copper ~ 178 5
anode rod 178 5
anorak *Child. Clothes* 29 62
anorak *Mountain* 300 6
anorak hood 300 19
Anseres 359 15-17
ant 358 21-22
Antarctica 14 18
Antarctic Circumpolar Drift
14 44
Antarctic Continent 14 18
Antarctic Ocean 14 22
antelope 367 5
antenna *Meteorol. Instr.* 10
59, 68
antenna *Forest Pests* 82 3
antenna *Air Force* 256 17
antenna *Warships* 258 16, 46;
259 7, 47, 89
antenna *Airsports* 288 20, 88
antenna *Articulates* 358 27, 53
antenna, maxillary ~ 358 42
antenna, trichotomous ~ 81 5
antenna down-lead 223 4
antenna lead-in 223 4
antenna mast 259 6
antepodium 330 20
anther *Soft Fruit* 58 45
anther *Drupes & Nuts* 59 10
anther *Conifers* 372 35
anthozoan 357 17
anthropoid apes 368 14-16
anthropoids 368 14-16
anti-aircraft gun 258 73
anti-aircraft gun, automatic
~ 259 34
anti-aircraft machine gun
255 63
anti-aircraft missile launcher
258 32; 259 5, 20
anti-aircraft rocket launcher
258 32; 259 5, 20
anticline 12 16, 27
anticlinorium 12 20
anticollision light 230 64
anticyclone 9 6
antifriction bearing 143 69
anti-frost layer 198 1; 200 60
antimacassar 207 48
anti-mist windscreen 189 46
anti-mist windshield 189 46
anti-radiation screen 154 74
anti-rolling system 224 26
antirrhinum 51 32
anti set-off apparatus 181 10
anti set-off spray 181 10
anti-skate control 241 25
anti-skid brake switch 211 33
anti-slosh baffle 234 13

anti-submarine missile
launcher 258 30, 50
anti-submarine rocket
launcher 258 30, 50
anti-submarine torpedo tube
258 33
anti-syphon trap *Bathrm. etc.*
49 27
anti-syphon trap *Plumb. etc.*
126 26
anti-tank rocket launcher
255 25
anti-tank tank 255 88
anti-torque rotor 232 14
anti-vortex system 234 11
antler, palmate ~ 88 40
antler, royal ~ 88 8
antler, surroyal ~ 88 9
antlers 88 5-11; 29-31
anurans 364 23-26
anus 20 62
anvil *Plumb.* 125 22
anvil *Blacksm.* 137 11; 11-16;
138 33
anvil *Forging* 139 17, 31, 40
anvil *Office* 247 5
anvil, clockmaker's ~ 109 7
aorta 18 10; 20 54
aorta, abdominal ~ 18 16
Apache girl 306 9
apartment 37 64-68, 69-71;
46
apartment, ladies' ~ 329 10
apartment building 37 72-76
apartment building, high-rise
~ 37 82
apartment building,
multistory ~ 37 77-81
apartment house 37 72-76
apartment house, high-rise ~
37 82
apartment house, multistory
~ 37 77-81
apatite 351 20
aperture 115 62, 63
aperture control, automatic ~
117 20
aperture control ring 115 5;
117 4
aperture ring 115 5; 117 4
aperture scale 115 56
aperture setting 117 4
aperture-setting control 114
34
aperture-setting ring 115 5;
117 4
aperture-stop slide 112 16
apex *Hunt.* 87 77
apex *Airsports* 288 47
apex *Church* 331 5
aphid 80 32; 358 13
aphid, winged ~ 82 39; 358 15
aphid, wingless ~ 358 14
apiarist 77 57
apiary 77 56
apiculture 77
à pointe 314 19
Apollo booster 234 1, 2
Apollo service module 234 56
Apollo space capsule 6 9
Apollo spacecraft 6 1

apostrophe 342 22
apparatus, auxiliary ~ 296
12-21; 297 7-14
apparatus exercises 297 15-32
apparatus gymnastics 296;
297
appendix 20 18
appendix, vermiform ~ 20 18
Appenzell dulcimer 322 35
apple 58 56; 99 86; 370 102
apple blossom 58 54
appleblossom weevil 80 10
apple core 58 59
apple pip 58 60
apple skin 58 57
apple stalk 58 61
apple tree 58 51, 52
appliance room 270 1
appliqué 29 20
appoggiatura 321 14, 15
appointments book 22 11
appointments diary 246 8
approach 329 34
approach sign 203 26, 27, 28,
29
approach signs 203 26-29
apricot 59 35
apricot blossom 59 34
apricot branch, flowering ~
59 33
apricot flower 59 34
apricot leaf 59 36
apricot tree 59 33-36
apron *Mach. Tools* 149 16
apron *Electrotyp. etc.* 178 9
apron *Airport* 233 3
apron *Theatre* 316 25
apron, butcher's ~ 96 39
apron, composition ~ 164 16
apron, frilled ~ 31 33
apron, leather ~ *Arc Weld.*
142 11
apron, leather ~ *Cotton Spinn.*
164 16
apron taxiway 233 4
apse 334 64; 335 5
aquafer 12 22; 269 2, 38
aqualung 279 19
aquarium 356 14, 19
Aquarius 4 63
aquatint 340 14-24
aqueduct 334 53
aquifer 12 22; 269 2, 38
Aquila 3 9
aquilegia 60 10
arabesque *Free Exerc.* 295 30
arabesque *Ballet* 314 18
arachnids 358 40-47
araucaria 53 16
arbor 272 17
arbor vitae 372 39
arbour 272 17
arc *Films* 312 42
arc *Maths.* 346 53, 55
arc, graduated ~ 224 2
arcade, blind ~ 335 10
arcading 335 8
arcading, blind ~ 335 10
arcading, round ~ 335 9
arc fibula 328 28
arch *Bldg. Site* 119 6

arch *Bridges* 215 20
arch *Free Exerc.* 295 34
arch *Theatre* 316 11
arch *Ari* 336 19
arch, convex ~ 336 34
arch, longitudinal ~ 19 61
arch, parabolic ~ 336 29
arch, reinforced concrete ~
215 50
arch, round ~ 336 27
arch, segmental ~ 336 28
arch, shouldered ~ 336 33
arch, supercilial ~ 16 5
arch, tented ~ 336 35
arch, transverse ~ 335 18
arch, trellis ~ 52 12
arch, triumphal ~ 334 59, 71
arch, trussed ~ 215 25
arch, Tudor ~ 336 37
arch, types of ~ 336 19-37
Archaster 369 17
arch board file 247 40
arch bridge, spandrel-braced
~ 215 28
arch bridge, stone ~ 215 19
arched front support 295 24
Archer *Astron.* 3 37; 4 61
archer *Sports* 305 53
archery 305 52-66
archimedes drill 108 4
architrave 334 18
archivolt 335 25
arch span 273 26
arch unit 247 41
archway 337 4
archway, memorial ~ 337 3
arching horn 152 47; 153 61
arcosolium 331 60
Arctic Ocean 14 21
arc welder 142 2
arc welding, gas-shielded ~
142 33
arc welding helmet 142 3, 39
area, epicentral ~ 11 38
area spraying 83 1
area 380 19
area nut 380 20
area palm 380 19
arena *Equest.* 289 1
arena *Circus* 307 21
arena *Bullfight. etc.* 319 9
arena entrance 307 11
areola 16 29
argent 254 25
Argo 3 45
Aries 4 53
aril, lacinate ~ 382 34
arista 68 12
arithmetic 344 1-26; 345 1-24
arithmetic unit 244 6
arm *Man* 16 43-48; 17 12-14
arm *Living Rm.* 42 22
arm *Flat* 46 28
arm *Shoem.* 100 25
arm *Photog.* 115 93
arm *Joiner* 132 63
arm *Mach. Parts etc.* 143 88
arm *Mach. Tools* 150 24
arm *Music. Instr.* 322 16
arm *Maths.* 346 7-3
arm, adjustable ~ 195 26

arm, hydraulic ~ 85 21
arm, supplementary ~ 203 22,
23
arm, upper ~ 16 43
armadillo 366 8
armament 258 29-37
armature 339 25
armature support 339 24
armband 263 11; 270 22
armband, fluorescent ~ 199 7
arm bandage 21 1
arm bar 299 10
armchair 42 21; 267 26
armed forces 255; 256; 257
armlet 263 11; 270 22
armonie 322 25
armor *see* armour
armour 329 38, 62
armour, knight's ~ 329 38-65
armour, padded ~ 353 38
armour, steel tape ~ 153 50
armour, steel wire ~ 153 50
armoured car 264 16
armoured vehicles 255 79-95
armour plating 246 24
armpit 16 26
armpit hair 16 27
arm positions 314 7-10
armrest 106 18; 109 3; 207 45,
69; 208 26
arm sling 21 2
arms of the baron 254 10
arms of the family of the
femme 254 11-13
arms of the family of the wife
254 11-13
arms of the husband 254 10
armstand dive 282 45
army 255
army weaponry 255 1-98
arnica 380 2
A road 15 83
arolla pine 372 29
arpeggio 321 22
arrangement of desks 260 1
arrester 152 35
arrester wire 259 16
arris 121 12
arris fillet 121 31
'arrivals' 233 26
arrivals and departures board
204 18
arrival schedule 204 19
arrival timetable 204 19
arrow 305 60
arrow head *Drawing Off.* 151
26
arrow head *Alp. Plants etc.*
378 51
art 333; 334; 335; 336; 337
art, Babylonian ~ 333 19-20
art, Baroque ~ 336 1-8
art, Byzantine ~ 334 72-75
art, Chinese ~ 337 1-6
art, computer-generated ~
248 19
art, Early Christian ~ 334
61-71
art, Egyptian ~ 333 1-18
art, Etruscan ~ 334 49-52
art, Gothic ~ 335 22-41

art, Greek ~ 334 1-48
art, Indian ~ 337 19-28
art, Islamic ~ 337 12-18
art, Japanese ~ 337 7-11
art, Renaissance ~ 335 42-54
art, Rococo ~ 336 9-13
art, Roman ~ 334 53-60
art, Romanesque ~ 335 1-21
art director 310 43
artery, carotid ~ 18 1
artery, femoral ~ 18 19
artery, frontal ~ 18 5
artery, iliac ~ 18 17
artery, pulmonary ~ 18 11; 20
55
artery, radial ~ 18 21
artery, subclavian ~ 18 7
artery, temporal ~ 18 3
artery, tibial ~ 18 20
artery forceps 26 49
arthropods 358 1-23
articulates 358
artillery weapons 255 49-74
artist 338 2
artistes, travelling ~ 308
25-28
Art Nouveau easy chair 336 18
art of Asia Minor 333 37
art of the Assyrians 333 29-36
art of the Persians 333 21-28
arts section 342 67
ascent, vertical ~ 315 3
ascent stage 6 37-47
ascospore 381 13
ascus 381 12, 13
ash box door 38 39
ashpan 210 6, 7
ash pit 152 8
ashtray 42 29; 104 5; 207 46,
69; 208 29; 246 33
ashtray, spherical ~ 266 5
ash tree 371 38
Asia 14 16
asp 364 41
asparagus 57 14
asparagus bed 52 25
asparagus cutter 56 10
asparagus knife 56 10
asparagus patch 52 25
asparagus server 45 77
asparagus slice 45 77
aspen 371 21
aspergillum 332 54
asphalt drying and mixing
plant 200 48
asphalt mixer drum 200 50
asphalt-mixing drum 200 50
aspiration psychrometer 10 33
asp viper 364 41
assay balance 108 35
assembler 174 23
assembling machine 249 59
assembling station 249 60
assembly of a circuit 242 72
assembly point *Airport*
233 11
'assembly point' *Airport*
233 29
assistant *Univ.* 262 7
assistant *Store* 271 63
assistant *Circus* 307 39

assistant, cellarer's ~ 79 12
 assistant, dentist's ~ 24 18
 assistant, doctor's ~ 22 19
 assistant cameraman **310** 42
 assistant director *Films* **310**
 21, 46
 assistant director *Theatre* **316**
 43
 assistant producer **316** 43
 assistant professor **262** 3
 assistant sound engineer **310**
 57
 association flag **286** 6, 9
 association football **291**
 asterisk **185** 61
 asteroids **4** 47
 astride jump **295** 35, 37
 astronaut **6** 11; **235** 67
 astronomy **3**; **4**; **5**
 asymmetric bars **297** 3
 asymptote **347** 29
 athletics **298**
 Atlantic Ocean **14** 20
 Atlas **334** 36
 atmosphere **7**
 atoll **13** 32
 Atolla **369** 5
 atom **1**; **2**
 atomic pile casing **259** 67
 atomic power plant **154** 19
 atom layer **7** 32
 atom models **1** 1-8
 atrium *Man* **20** 45
 atrium *Art* **334** 66
 attachment to Orbiter **235** 49
 attack **321** 27
 attack area **293** 64
 attacker *Ball Games* **292** 3
 attacker *Fencing* **294** 5
 attacking fencer **294** 5
 attack line **293** 65
 attack periscope **259** 88
 attic **38** 1-29, 18; **334** 60
 attitude **314** 17
 attitude control rocket **234** 38
 aubretia **51** 7
 auction room **225** 58
 audience **263** 8
 audio cassette **242** 17
 audio coding equipment **242**
 11-14
 audio head **243** 35
 audio level control **117** 16
 audio recording level control
243 11
 audio sync head **243** 24
 audio systems **241**
 audio track **243** 32
 audio typist **248** 33
 audiovision **243**
 audio-visual camera **243** 1-4
 audio-visual projector **242** 16
 auditorium **315** 14-27, 16-20
 auditorium lighting control
312 17
 auger *Agr. Mach.* **64** 6, 25
 auger *Carp.* **120** 65
 augmented triad **321** 4
 auk **359** 13
 aulos **322** 3
 aulos pipe **322** 4

aural syringe **22** 74
 aureus **252** 3
 auricle **17** 56; **20** 24
 auricula **378** 8
 Auriga **3** 27
 auriscope **22** 74
 aurora **7** 30
 Australia **14** 17
 Australopithecus **261** 20
 auto **191** 1-56; **195** 34
 autoclave **170** 12, 33
 autofocus override switch **117**
 11
 automatic flight control panel
235 23
 automatic-threading button
117 83
 automobile **191** 1-56; **192**;
193; **195** 34
 automobile models **193** 1-36
 automobile tire **191** 15; **196**
 27
 automotive mechanic **195** 53
 autopilot **224** 18
 auto-soling machine **100** 2
 auxiliaries **258** 92-97
 auxiliary brake valve **211** 23
 auxiliary-cable tensioning
 mechanism **214** 48
 auxiliary engine room **223**
 70; **259** 56
 auxiliary parachute bay **235**
 59
 AV **243**
 avalanche **304** 1
 avalanche forest **304** 7
 avalanche gallery **304** 3
 avalanche wall **304** 2
 avalanche wedge **304** 2
 Ave Maria **332** 32
 avenue **274** 11
 aviary **356** 8
 aviation fuel **145** 57
 avionics bay, front ~ **257** 11
 avionics bay, rear ~ **257** 18
 avionics console **235** 22
 awn **68** 12
 awner **64** 10
 awning *Dwellings* **37** 71
 awning *Ship* **218** 15; **221** 116
 awning *Camping* **278** 28, 37
 awning crutch **218** 14
 ax *see* axe
 axe **85** 1; **120** 73; **270** 43
 axe, bronze ~ **328** 23
 axe, socketed ~ **328** 23
 axial-flow pump **217** 47-52
 axis *Astron.* **4** 22
 axis *Maths.* **347** 17
 axis, anticlinal ~ **12** 17
 axis, celestial ~ **4** 10
 axis, conjugate ~ **347** 24
 axis, coordinate ~ **347** 2-3
 axis, earth's ~ **4** 22-28
 axis, floral ~ **370** 53
 axis, lateral ~ **230** 68
 axis, longitudinal ~ **230** 72
 axis, major ~ **347** 23
 axis, minor ~ **347** 24
 axis, normal ~ **230** 70
 axis, polar ~ **113** 15, 18

axis, synclinal ~ **12** 19
 axis, transverse ~ **347** 23
 axis, vertical ~ **230** 70
 axis mount, English-type ~
113 22
 axis mounting, English-type
 ~ **113** 22
 axis of abscissae **347** 2
 axis of ordinates **347** 3
 axis of rotation,
 instantaneous ~ **4** 25
 axis of rotation, mean ~ **4** 27
 axis of symmetry *Maths.* **346**
 25
 axis of symmetry *Crystals* **351**
 4
 axle **187** 61, 76, 81
 axle, coupled ~ **210** 36
 axle, floating ~ *Agr. Mach.* **65**
 33
 axle, floating ~ *Motorcycle*
189 34
 axle, live ~ **192** 65-71
 axle, rigid ~ **192** 65-71
 axle bearing **210** 10
 axle drive shaft **201** 13
 azalea **53** 12
 azimuth **87** 74
 azure *Heraldry* **254** 28
 azure *Colour* **343** 6

B

baboon **368** 13
 baby **28** 5
 baby bath **28** 3
 baby carriage **28** 34; **272** 71;
273 31
 baby clothes **29** 1-12
 baby doll **48** 25
 baby grand piano **325** 40
 baby pants **28** 22
 baby pants, rubber ~ **29** 10
 baby powder **28** 14
 baby scales **22** 42
 back *Man* **16** 22-25
 back *Tablew. etc.* **45** 56
 back *Horse* **72** 29
 back *Mills* **91** 2
 back *Roof* **122** 86
 back *Bookbind.* **185** 41
 back *Car* **193** 35
 back *Swim.* **282** 49
 back *Ball Games* **293** 77
 back *Sports* **305** 11
 backband **71** 19
 backboard **292** 30
 backbone *Man* **17** 2-5
 backbone *Bookbind.* **185** 41
 back check **325** 27
 back check felt **325** 28
 backcloth **315** 33; **316** 10
 back comb **105** 6
 back crease **292** 71
 back cushion **42** 25
 back cut **84** 29
 backdrop **315** 33; **316** 10
 backdrop light **316** 15
 back fat **95** 40
 backfilling **217** 7

back flip **297** 24
 backgammon **276** 18
 backgammon board **276** 22
 back gauge **183** 17; **185** 4, 7
 background *Films* **310** 33
 background *Theatre* **316** 10
 backhand stroke **293** 39
 backing **269** 29
 backing disc, rubber ~ **134** 22
 backing paper *Photog.* **114** 21
 backing paper *Paperhanger*
128 5
 back left second pin **305** 9
 back loop **288** 50
 back of the hand **19** 83
 backpack unit **6** 20
 back-pedal brake **187** 63
 back pin **305** 11
 back plate **140** 36
 back-pressure valve,
 hydraulic ~ **141** 8
 backrest *Weaving* **166** 37
 backrest *Railw.* **207** 66
 backrest, reclining ~ **191** 35
 back right second pin **305** 10
 back scouring valve **216** 61
 backside **16** 40
 back-sight leaf **87** 67
 back-sight slide **87** 69
 back-stand adjustment
114 55
 backstay **219** 19
 backstitch seam **102** 1
 back support **295** 22; **296** 29
 back-up ball **305** 20
 back vault **297** 32
 backward grand circle **296** 60
 backward somersault *Swim.*
282 42
 backward somersault *Gymn.*
297 15
 backward underswing **296** 59
 backward walkover **297** 23
 backwater **172** 26
 bacon **96** 2
 Bactrian camel **366** 29
 badge, fool's ~ **306** 60
 badger **88** 48
 badging **191** 12
 badminton **293** 43-44
 badminton game **273** 6
 badminton racket **293** 43
 badminton racquet **293** 43
 baffle board *Warships* **259** 27
 baffle board **309** 17
 baffle board, hinged ~ **259** 15
 baffle board, movable ~ **259**
 15
 bag *Doc.* **22** 33
 bag *Hunt.* **86** 38
 bag *Music. Instr.* **322** 9
 bag, girl's ~ **29** 56
 bag, heat-sealed ~ **76** 29
 bag, paper ~ **98** 48
 bag, postman's ~ **236** 54
 bag filter **83** 54
 bag-full indicator **50** 61, 73
 baggage compartment **257** 19
 baggage loader **233** 22
 baggage man **267** 17
 'baggage retrieval' **233** 38

baggage terminal **233** 5, 16
 bagging nozzle **83** 55
 bag net **77** 54
 bagpipe **322** 8
 bag sealer **40** 47
 baguette **97** 12
 bag wig **34** 4
 bail **292** 70
 bailey, inner ~ **329** 2
 bailey, outer ~ **329** 31
 bait **86** 21
 bait, poisoned ~ **83** 31
 bait, weighted ~ **89** 36
 bait needle **89** 41
 baits **89** 65-76
 bait tin **89** 24
 bakehouse **97** 55-74
 baker's shop **97** 1-54
 bakery **97** 55-74
 baking ingredient **99** 62
 baking ingredients **98** 8-11
 balalaika **324** 28
 Balance *Astron.* **3** 19; **4** 59
 balance *Paperm.* **173** 9
 balance beam **349** 30
 balance cable **214** 46
 balance cable sleeve **214** 74
 balance column **349** 29
 balancer **307** 48
 balance rail **322** 39
 balance weight **242** 50
 balance wheel **110** 39
 balancing act **307** 44
 balancing cabins **214** 25
 balancing knob **116** 39
 balancing pole **307** 42
 balcony *Dwellings* **37** 18, 69,
 73
 balcony *Theatre* **315** 16; **315**
 18
 balcony *Chivalry* **329** 12
 balcony, projecting ~ **218** 57
 baldachin **331** 49
 baldachin **331** 49
 bald patch **34** 21
 bale **55** 31; **63** 34; **75** 7; **83** 13;
169 34; **170** 62; **206** 10, 11,
 23
 bale arm **89** 62
 bale breaker **163** 7
 bale loader, hydraulic ~ **63** 37
 bale opener **163** 7
 baler, high-pressure ~ **63** 35
 baling press **169** 33
 balk **63** 3
 ball *Infant Care etc.* **28** 16
 ball *Bicycle* **187** 31
 ball *Aircraft* **230** 12
 ball *Ball Games* **292** 27
 ball *Circus* **307** 60
 ball, ivory ~ **277** 1
 ball, metal ~ **352** 32
 ball, paper ~ **306** 55
 ball, plastic ~ **277** 1
 ball, steel ~ **143** 70
 ball, stone ~ **352** 32
 ball and socket head **114** 47
 ballast *Station* **205** 61
 ballast *Railw.* **212** 66
 ballast *Sailing* **285** 33
 ballast *Airsports* **288** 65

ballast keel **285** 32
 ballast tank **223** 78
 ball bearing **143** 69; **187** 56,
 68
 ball boy **293** 22
 ballerina **314** 26
 ballet **314**
 ballet dancer **314** 26
 ballet positions **314** 1-6
 ballet shoe **314** 30
 ballet skirt **314** 31
 ballet slipper **314** 30
 ball games **291**; **292**; **293**
 ballistics **87** 73
 ball mill **161** 1
 ball of clay **161** 9
 ball of the foot **19** 58
 ball of the thumb **19** 75
 balloon **308** 13
 balloon, gas ~ **288** 63
 balloon, hot-air ~ **288** 79
 balloon, manned ~ **7** 16
 balloon basket **288** 64
 ballooning **288** 63-84
 ballot box **263** 29
 ballot envelope **263** 21
 ballot paper **263** 20
 ball race **187** 68
 ballroom **306** 1
 Balmer series **1** 21
 baluster **38** 29; **123** 51
 balustrade **38** 25; **123** 22, 50
 bamboo cane **136** 31
 bamboo culm **383** 60
 bamboo stem **383** 60, 63
 banana **99** 90; **384** 33
 banana flower **384** 34
 banana-handling terminal
226 22
 banana leaf **384** 35
 banana plant **384** 28
 banana saddle **188** 59
 banana tree **384** 28
 band *Ball Games* **291** 25
 band *Nightclub* **318** 3
 band *Church* **332** 5
 band, fluorescent ~ **199** 8
 band, iron ~ **130** 16
 band, ornamental ~ **334** 38
 band, steel ~ **163** 5
 bandage *First Aid* **21** 9
 bandage *Equest.* **289** 15
 bandages, emergency ~ **21**
 1-13
 band brake **143** 104
 banderilla **319** 22
 banderillero **319** 4, 21
 band of barrel **130** 8
 bandoneon **324** 36
 bandora **322** 21
 bandsaw **134** 50; **157** 48
 bandsaw, horizontal ~ **157** 48
 bandsaw blade **157** 53
 bandstand **274** 19; **307** 9
 band wheel **104** 15
 bandwheel cover **133** 32
 banewort **379** 7
 banger **306** 51
 bangle *Jewell.* **36** 17
 bangle *Ethnal.* **354** 38
 bangle, asymmetrical ~ **36** 26

bangs 34 36
banjo 324 29
bank *Phys. Geog.* 13 4
bank *Post* 237 43
bank *Bank* 250
bank *Roulette* 275 11
bank acceptance 250 12
bank branch 204 31
bank clerk 250 5
bank employee 251 7
banknotes 252 29-39
bank of circulation 252 30
bank of issue 252 30
bank of oars 218 12
bank protection 216 51-55
bank slope 217 28
bank stabilization 216 51-55
bank statement 247 44
banner *Flags* 253 12
banner *Election* 263 12
banner, processional ~ 331 44
banquet room 267 39
bantam 74 56
baptism, Christian ~ 332 1
baptistry 332 2
bar *Horse* 71 41
bar *Office* 246 29
bar *Restaurant* 266 1-11
bar *Hotel* 267 54
bar *Park* 272 34
bar *Playground* 273 32
bar *Gymn.* 296 3, 8; 297 4, 41
bar *Athletics* 298 14, 34
bar *Winter Sp.* 303 5
bar *Circus* 307 50
bar *Disco* 317 1, 9
bar *Nightclub* 318 13, 15
bar *Music. Not.* 320 42
bar *Graphic Art* 340 34
bar, flat ~ 143 10
bar, metal ~ 324 77
bar, round ~ 143 8
bar, sliding ~ 75 21
bar arm 299 10
barb *Bees* 77 10
barb *Fish Farm.* 89 80
barb *Mach. Parts etc.* 143 44
barbecue 278 47
barbel 364 13
bar bender 119 21
barber 106 1
barber's shop 106 1-42
barchan 13 40
barchane 13 40
bar customer 267 55
bareback rider 307 26
barge 216 22, 25; 225 8
barge and push tug assembly 221 92
bargeboard 37 8
bargee 216 26
bargeman 216 26
barge sucker 216 59
bark *Carp.* 120 86
bark *Ship* 219 1-72; 220 21-23
bark *Bot.* 370 8
bark, five-masted ~ 220 32-34
bark, four-masted ~ 220 29
bark beetle 82 22
bark brush 56 23
barkeep 266 8; 267 62
barkeeper 266 8; 267 62
barker 308 8, 64
barkhan 13 40
barking 85 23
barking iron 85 8
bark schooner 220 20
bark scraper 56 14
bark spud 85 8
bark stripping 85 23
bar lamp 317 11
barley 68 1, 26
barley, germinated ~ 92 23
barley elevator 92 33
barley hopper 92 2
barley reception 92 41
barley silo 92 31
bar line 320 42
barmaid 267 63; 317 2; 318 14
barman 266 8; 267 62
barn owl 362 17
barn swallow 361 20
barograph 10 4
barouche 186 35
barque 219 1-72; 220 21-23
barque, five-masted ~ 220 32-34
barque, four-masted ~ 220 29
barque schooner 220 20
barrage 217 57-64, 65-72
barrel *Cooper* 130 5
barrel *Mach. Tools* 149 27
barrel *Army* 255 2, 17, 41
barrel, aluminium ~ 93 17
barrel, rifled ~ 87 26
barrel, semi-oval ~ 89 3
barrel, smooth-bore ~ 87 27
barrel casing 87 35; 255 33
barrel clamp 255 11, 62
barrel-clamping nut 255 11
barrel cradle 255 60
barrelhead 130 10
barrel organ 309 13
barrel recuperator 255 61
barrel-shape 36 75
barrel-shape, standard ~ 36 56
barrel stave 130 9
barrel store 93 16
barrel vault 335 19; 336 38
barricade 264 17
barrier *Supermkt.* 99 5
barrier *Railw.* 202 40
barrier *Hydr. Eng.* 217 65
barrow *Station* 205 32
barrow *Prehist.* 328 16
barrow, road sweeper's ~ 199 9
barrow, street sweeper's ~ 199 9
bars 75 5
bar set 246 30
bar stool 267 53; 317 3; 318 16
bartender 266 8; 267 62
bar trio 267 44
barysphere 11 5
basal pinacoid 351 20
base *Dining Rm.* 44 23
base *Mills* 91 33

base *Optic. Instr.* 112 3; 113 2
base *Floor etc. Constr.* 123 21, 63
base *Bookbind.* 183 25
base *Road Constr.* 200 59
base *Heraldry* 254 22-23
base *Mountain.* 300 1
base *Art* 334 28-31
base *Maths.* 345 1, 6; 346 27; 347 35, 39
base, horizontal ~ 112 72
base, round ~ *Hairdresser* 105 27
base, round ~ *Basketm.* 136 19
base, round ~ *Electrotyp. etc.* 178 10
base, woven ~ 136 20
baseball 292 40-69, 61
baseball glove 292 59-60
baseball mitt 292 59-60
baseboard *Photog.* 116 27
baseboard *Sculpt. Studio* 339 23
base course *Dwellings* 37 17
base course *Carp.* 120 28
base course *Street Sect.* 198 3
base course *Road Constr.* 200 59
base course, concrete ~ 118 2
base course, natural stone ~ 37 85
base frame 177 40
base line 292 48; 293 3-10, 72
base line judge 293 26
base man 292 44
basement 37 1; 118 1
basement stairs 123 16
basement wall 123 1
basement window 37 27; 118 3
base of goblet 162 42
base of machine 168 54
base of statue 272 11
base of support 214 81
base plate *Optic. Instr.* 112 27
base plate *Iron Foundry etc.* 148 56
base plate *Mach. Tools* 150 19
base plate *Knitting* 167 34
base plate *Railw.* 202 5
base plate *Army* 255 46
base plate *Ball Games* 292 67
base unit 39 9
basic knits 171 30-48
basic position 295 1
basidia 381 7
basidiospore 381 8
basilica 334 61
basilisk *Fabul. Creat.* 327 34
basilisk *Fish etc.* 364 30
basin *Doc.* 23 25
basin *Dent.* 24 12
basin *Park* 272 24
basis weight 173 9
basket *Kitch. Utensils* 40 42
basket *Butch.* 96 18
basket *Supermkt.* 99 8
basket *Basketm.* 136 16
basket *Station* 204 3

basket *Ball Games* 292 32
basket *Winter Sp.* 301 8
basket, rotating ~ 168 17
basket, wicker ~ 305 69
basket, wire ~ 55 50; 66 25; 188 23
basketball 292 28, 29
basketball player 292 35
basket handle 336 28
basket maker 136 33
basket making 136 1-40
basket post 292 31
basket ring 292 33
basketry 136 1-40
basket weave 171 11
basketwork 136 1-40, 16
bas-relief 339 33
bass 323 23
bass belly bridge 325 13
bass bridge 325 13
bass button 324 43
bass clarinet 323 34
bass clef 320 9
bass coupler 324 44
bass drum 323 55; 324 47
bassinet 28 30
bassinet covers 28 31
bassoon 323 28
bass press-stud 324 43
bass register 324 44
bass side 324 43
bass stop 324 44
bass string 324 25; 325 12
bass stud 324 43
bass trombone 323 46
bass tuba 323 44
bass tuning 241 43
bass viol 322 23
bast 136 29
bastard title 185 44
bastion 329 16
bat 292 62, 75
batch 162 2
batch feeder 162 13
batch funnel 162 13
batching and mixing plant, automatic ~ 201 19
batch of eggs 80 2, 30
bath *Bathrm. etc.* 49 1
bath *Hotel* 267 27-38
bath *Swim.* 281 36
bath, cold ~ 281 30
bat handle 293 46
bather 280 30
bathing beach 280
bathing cap 280 29, 44; 281 8
bathing gown 280 25
bathing platform 280 9
bathing shoe 280 23
bathing suit 280 42
bathing suit, two-piece ~ 280 26
bathing towel 281 14
bathing trunks 280 43
bathing wrap 280 25
bath mat 49 48
batholite 11 29
bath robe 29 24
bathroom 49
bathroom cabinet, mirrored ~ 49 31

bathroom mule 49 46
bathroom scales 49 47
bathroom tissue 49 11
bathroom tissue holder 49 10
bath salts 49 5; 99 34
bath sponge *Bathrm. etc.* 49 6
bath sponge *Invertebr.* 357 13
bat of clay 161 9
baton 264 19
baton, conductor's ~ 315 27
batrachians 364 23-26
batsman 292 74
batten *Roof* 122 17
batten *Sailing* 284 44
batten, compartmentalized ~ 316 13
batten, compartment-type ~ 316 13
batten cleat 284 43
batten door 37 34
batten gauge 122 18
batten pocket 284 43
batter 292 52, 63
batterboard 118 69
batter's position 292 51
battery *Agr. Mach.* 65 53
battery *Poultry Farm* 74 19
battery *Photog.* 114 66
battery *Car* 191 50
battery *Warships* 259 83
battery, rotary ~ 166 5
battery box 207 5, 25; 211 56
battery cage 74 20
battery cell 110 7
battery chamber *Photog.* 115 10
battery chamber *Cine Film* 117 5
battery compartment 188 22
battery container 207 5, 25; 211 56
battery feeding 74 23
battery holder 115 76
battery housing 257 17
battery railcar 211 55
battery switch 115 13
battery system 74 18
battery tester 25 52
battery unit 115 75
batting crease 292 72
batting order 292 58
battle axe 352 16
battle axe, stone ~ 328 19
battlement 329 6
battleships, light ~ 258 1-63
bauble 306 59
bault *Agr.* 63 3
bault *Carp.* 120 87
baumkuchen 97 46
Bavarian curler 302 38
Bavarian curling 302 38-40
bay *Phys. Geog.* 13 7
bay *Game* 88 7
bay *Carp.* 120 59
bayadère 306 25
bay antler 88 7
bayonet 353 28
bayonet fitting 127 65, 69
B-deck 223 32-42
beach 13 35-44
beach, raised ~ 11 54

beach area 281 2
beach attendant 280 34
beach bag 280 24
beach ball 280 18
beach chair, roofed ~ 280 36
beach chair, wicker ~ 280 36
beach grass 15 7
beach hat 280 20
beach jacket 280 21
beach marten 367 14
beach mattress, inflatable ~ 280 17
beach shoe 280 23
beach suit 33 24; 280 19
beach tent 280 45
beach trousers 280 22
beachwear 280 19-23.
beacon 15 10, 49
bead 87 72
bead-and-dart moulding 334 38
beading 123 64
beading hammer 125 15
beading iron 125 8
beading pin 128 30
beading swage 125 15
beak 88 84
beak, flat ~ 137 12
beak, hooked ~ 362 6
beak, round ~ 137 13
beaker 350 20
beaker pottery 328 14
beam *Agr. Mach.* 65 9, 71
beam *Game* 88 11, 30
beam *Carp.* 120 19, 24
beam *Gymn.* 297 2
beam *Music. Instr.* 325 22
beam *Chem.* 349 30
beam, central ~ 273
beam, dipped ~ 191 20
beam, high ~ 191 20
beam, low ~ 191 20
beam, main ~ *Carp.* 120 38
beam, main ~ *Roof* 121 66
beam, main ~ *Car* 191 20
beam, tied ~ 215 44
beam bridge 215 7
beam compass 125 11
beam compass, glazier's ~ 124 22
beam entry point 1 64
beam flange 165 30; 166 49; 167 26
beam head 121 33
beaming machine 165 55
beam motion control 166 60
beam of light 224 83
beam setter 195 24
beam splitter 240 35
beam-splitting prism *Optic. Instr.* 112 13
beam-splitting prism *Broadcast.* 240 35
beam trammel 125 11
bean 57 8, 11
bean, bush ~ 57 8
bean, climbing ~ 57 8
bean flower 57 9
bean plant 52 28; 57 8
bean pole 52 28
beanstalk 57 10

bearberry 377 15
 beard *Arable Crops* 68 12
 beard *Dom. Anim.* 73 15
 beard *Game* 88 73
 beard, circular ~ 34 15
 beard, full ~ 34 15
 beard, round ~ 34 15
 bearded couch grass 61 30
 beards 34 1-25
 bearer cable 119 37; 271 52
 bearer share 251 11
 bearing, axial-radial ~ 113 3
 bearing, centre ~ 177 65
 bearing, fixed ~ 215 11
 bearing, hydrostatic ~ 5 10
 bearing, jewelled ~ 110 33
 bearing, lower ~ 192 83
 bearing, main ~ 192 23
 bearing, movable ~ *Bridges* 215 12
 bearing, movable ~ *Sailing* 284 6
 bearing, upper ~ 192 73
 bearing block 177 61
 bearing cup 187 68
 bears 368 9-11
 beasts of prey 367 11-22; 368 1-11
 beater *Hunt.* 86 37
 beater *Bakery* 97 70
 beater *Music. Instr.* 322 34; 324 64
 beater, revolving ~ 64 13
 beater, three-blade ~ 163 25
 beater drive motor 163 23
 beater driving shaft 163 24
 beating 86 34-39
 beating machine 131 4
 beating wood 339 12
 beauty parlor 105 1-39
 beauty queen 306 64
 beauty salon 105 1-39
 beauty shop 105 1-39
 beauty spot 306 24
 beaver *Chivalry* 329 41
 beaver *Mammals* 366 14
 beck, flat ~ 137 12
 beck, round ~ 137 13
 bed *Phys. Geog.* 13 49
 bed *Hosp.* 25 10
 bed *Joiner* 133 50
 bed *Mach. Tools* 150 19, 29
 bed *Offset Print.* 180 78
 bed *Letterpress* 181 17
 bed *Bookbind.* 183 25
 bed *Station* 205 61
 bed *Graphic Art* 340 41, 64
 bed, children's ~ 47 1
 bed, double ~ 43 4-13; 267 38
 bed, rear ~ 85 49
 bed bug 81 39
 bedder 91 23
 bed frame 43 5
 bed linen 271 57
 Bedlington terrier 70 18
 bed monitor 25 19
 bedouin 354 6
 bedrock 13 70
 bedroom 43
 bedroom, twin-berth 207 38
 bedroom, two-berth ~ 207 38

bedroom, two-seat ~ 207 38
 bedroom lamp 43 19
 bedside cabinet 43 17
 bedside rug 43 22
 bed slide 149 24
 bedspread 43 7
 bedstead 43 4-6
 bed stone 91 23
 beduin 354 6
 bed unit 46 16
 bed unit drawer 46 18
 bed unit shelf 46 19
 bed warmer 309 88
 bee 77 1-25
 bee, male ~ 77 5
 beech cellulose 169 1
 beech gall 82 37
 beech nut 371 37
 beech tree 371 33
 bee eater 360 2
 beef 95 14-37
 beehive 77 45-50
 beehive kiln 161 3
 bee house 77 56
 beekeeper 77 57
 beekeeping 77
 beeman 77 57
 beer 99 72
 beer, bottled ~ 93 26
 beer, canned ~ 99 73
 beer barrel 93 17
 beer bottle 93 26; 205 50
 beer can 93 25
 beer crate 93 24
 beer filter 93 15
 beer glass 45 91; 93 30; 266 3, 6; 317 6
 beer marquee 308 23
 beer mat 266 26
 beer mug 266 6; 309 53
 beerpull 266 1, 68
 beer pump 266 1, 68
 beer tap 317 8
 beer warmer 266 7
 bees 77
 bee shed 77 51
 bee smoker 77 59
 bee sting ointment 77 68
 beeswax 77 67
 beet 68 44, 45
 beet carrion beetle 80 45
 beet cleaner 64 89
 beet elevator 64 94
 beet elevator belt 64 95
 beet harvester 64 85-96
 beet hopper 64 96
 beetle 82 26, 42
 beet leaf 68 47
 beetles 358 24-39
 beet top 68 46
 bee veil 77 58
 begonia 53 10
 begonia, tuberos ~ 51 19
 belay 300 9, 10
 belayer 300 26
 bellfry window 331 8
 bell *Plumb. etc.* 126 16
 bell *Iron & Steel* 147 6
 bell *Railw.* 212 49
 bell *Navig.* 224 75
 bell *Election* 263 4

bell *Winter Countr.* 304 26
 bell *Music. Instr.* 323 37, 42, 48; 324 70
 bell, electric ~ 127 15
 bell, electrically operated ~ 331 9
 belladonna 379 7
 Bellatrix 3 13
 bell beaker 328 14
 bell boy 267 18
 bell end 278 27
 bellows *Photog.* 114 53; 116 31
 bellows *Photomech. Reprod.* 177 10, 26
 bellows *Camping* 278 49
 bellows *Flea Market* 309 26
 bellows *Music. Instr.* 322 58; 324 37
 bellows pedal 325 46
 bellows strap 324 38
 bellows unit 115 85
 bell push 127 2
 bells 276 45
 bell sleeve, pleated ~ 30 54
 bell tent 278 8
 bell tower 337 8
 belly *Sea Fish.* 90 20
 belly *Meat* 95 39, 41
 belly *Music. Instr.* 323 24; 324 3
 belly-band 71 36
 belt 30 11; 31 10; 32 39
 belt, coloured ~ 299 15
 belt, flat ~ 163 49
 belt, stretch ~ 31 63
 belt buckle 31 12
 belt-changing flap 255 35
 belt conveying 144 40
 belt conveyor 156 2
 belt delivery 185 13
 belt drive 165 33
 belt guard 133 31
 beltline 270 45
 belt roller 133 18
 belt-tensioning lever 133 16
 bench *Goldsm. etc.* 108 20
 bench *Plumb.* 125 10
 bench *Blacksm.* 137 21
 bench *Metalwkr.* 140 7
 bench *Playground* 273 58
 bench *Gymn.* 296 14
 bench, collapsible ~ 134 41
 bench, oarsman's ~ 278 17
 bench, paperhanger's ~ 128 31
 bench, pupil's ~ 261 11
 bench, student's ~ 261 11
 bench, teacher's ~ 261 3
 bench, tiered ~ 281 20
 bench, woodworker's ~ 132 29-37
 bench apron 108 21
 bench brush 108 33
 bench covering 141 16
 bench holdfast 132 36
 bench stop 132 36
 bench top 132 34
 bench torch 350 9
 bend 126 46
 bending iron *Bldg. Site* 119 77

bending iron *Blacksm.* 137 39
 bending machine 125 28, 30
 bending table 119 20
 bending tool 136 34
 bend of hook 89 81
 bend sinister wavy 254 6
 Benguela Current 14 43
 benniseed 383 45
 bent hang 296 39
 benzene chlorination 170 8
 benzene extraction 170 6
 benzene ring 242 66
 benzene scrubber 156 24
 benzol scrubber 156 24
 beret 35 27
 berlin 186 1
 berm 216 38
 Bermuda shorts 31 44
 berry 58 9, 11; 370 97
 berry bush 52 19
 berry bushes 58 1-30
 berry tree, standard ~ 52 11
 besageur 329 45
 besom *Roof & Boilerr.* 38 36
 besom *Winter Sp.* 302 43
 Bessemer converter 147 55-69
 best end of loin 95 7
 beta particle 1 32
 beta radiation 1 32
 Betelgeuse 3 13
 betel nut 380 20
 betel palm 380 19
 bevel *Carp.* 120 81
 bevel *Mach. Parts etc.* 143 62
 bevel edge 178 44
 bevel gear 91 25
 bevel gearing 91 25
 bevel gear wheel 143 91
 bevel wheel 143 91
 bez antler 88 7
 bez tine 88 7
 B flat major 320 64
 B flat minor 320 67
 bib *Infant Care etc.* 28 43
 bib *Ladies' Wear* 30 24
 bib and brace *Child. Clothes* 29 40
 bib and brace *Ladies' Wear* 30 21
 bib and brace overalls 33 44
 Bible 330 11
 bib skirt 29 41
 biceps brachii 18 37
 biceps femoris 18 61
 bick, flat ~ 137 12
 bick, round ~ 137 13
 bicycle 187
 bicycle, child's ~ 273 9
 bicycle, folding ~ 188 1
 bicycle, gent's ~ 187 1
 bicycle, motor-assisted ~ 188 6
 bicycle bell 187 4
 bicycle drive 187 35-42
 bicycle frame 187 14-20
 bicycle kick 291 45
 bicycle lamp 187 7
 bicycle lock 187 49
 bicycle pedal 187 78
 bicycle pump 187 48

bicycles 188
 bicycle saddle 187 22
 bicycle speedometer 187 33
 bidet 49 7
 Biedermeier dress 306 22
 Biedermeier sofa 336 17
 bier 331 41
 bifurcation 224 89
 Big Dipper 3 29
 big top 307 1
 big wave riding 279 4
 big wheel 308 37
 bike 187 1
 bikini 280 26
 bikini bottom 280 27
 bikini briefs 32 15
 bikini top 280 28
 bilberry 377 23
 bile duct, common ~ 20 37-38
 bilge block 222 40
 bilge keel 222 47
 bilge shore 222 40
 bilge strake 222 46
 bill *Game* 88 84
 bill *Bank* 250 12
 bill *Birds* 359 17
 billboard 118 45
 bill clause 250 17
 billhook 56 9; 85 11
 billiard ball 277 1
 billiard clock 277 17
 billiard cloth 277 15
 billiard cue 277 9
 billiard marker 277 18
 billiard parlor 277 7-19
 billiard player 277 8
 billiard room 277 7-19
 billiards 277 1-19
 billiards, English ~ 277 7
 billiards, French ~ 277 7
 billiards, German ~ 277 7
 billiard saloon 277 7-19
 billiard strokes 277 2-6
 billiard table 277 14
 bill of exchange 250 12
 bills 252 29-39
 bin 200 45
 bind 321 24
 binder 107 6
 binder course 198 4
 binder injector 200 53
 binding *Bookbind.* 185 40-42
 binding *Athletics* 298 54
 binding, parts of ~ 301 54-56
 binding, rubber ~ 286 57-58
 bindweed 61 26
 binoculars 86 6; 111 17; 221 128
 biology preparation room 261 14-34
 biopsy forceps 23 17
 biplane 229 10
 bipod 255 42
 bipod mast 221 24
 biprism, ditrigonal ~ 351 22
 biprism, hexagonal ~ 351 22
 bipyramid, tetragonal ~ 351 18
 birch 51 13; 272 40; 281 27
 Birch Boletus 381 22
 birch rod 281 27

birch tree 51 13; 272 40; 371 9
 bird 86 50
 bird, flightless ~ 359 4
 bird, gallinaceous ~ 359 22
 bird, migratory ~ 360 7
 bird, non-migratory ~ 360 4
 bird, resident ~ 360 4
 bird cherry 59 5
 bird-foot 69 11
 birds 359; 360; 361; 362; 363
 birds, corvine ~ 361 1-3
 birds, European ~ 360
 birds, exotic ~ 363
 birds, flightless ~ 359 1-3
 birds, long-winged ~ 359 11-14
 birds, web-footed ~ 359 5-10
 bird's foot 69 11
 bird's foot clover 376 17
 bird's foot trefoil 69 11; 376 17
 birdsmouth 84 28
 birds of prey 362
 birds of prey, diurnal ~ 362 1-13
 birds of prey, nocturnal ~ 362 14-19
 birth-wort 376 22
 biscuit tin, decorative ~ 46 12
 bisector 346 28, 30
 bishop 276 10
 bismarck 97 29
 bison 328 9; 367 9
 bistort 376 10
 bit 140 35
 bitch 73 16
 biting housefly 81 4
 bitt 284 25
 bitter 93 26
 bitumen 145 64
 bituminous distributor 200 46
 black 343 13
 black arches moth 82 17
 black-backed jackal 367 11
 black beetle 81 17
 blackberry 58 29
 blackbird 361 13
 blackboard 47 13; 48 16; 261 36
 blackboard, three-part ~ 260 29
 blackboard chalk 48 15
 blackboard compass 260 40
 blackboard drawing 260 33
 blackboard sponge 260 42
 black buck 367 5
 blackcock 86 11; 88 66
 black elder 374 35
 Black Forest clock 109 31
 Black Forest gateau 97 24
 black-headed gull 359 14
 black liquor filter 172 28
 black liquor storage tank 172 29
 black nightshade 379 5
 black rhino 366 25
 black salsify 57 35
 blacksmith 137; 138
 blacksmith's tools 137 22-39
 blackthorn 374 27
 bladder 20 33, 78

blade *Kitch. Utensils* 40 40
 blade *Tablew. etc.* 45 54
 blade *Gdn. Tools* 56 36
 blade *Arable Crops* 68 20
 blade *Paperm.* 172 74
 blade *Bookbind.* 185 29
 blade *Rowing* 283 38, 53
 blade *Fencing* 294 44
 blade *Bot.* 370 28
 blade, flexible ~ 85 20
 blade, front ~ 85 35
 blade, lower ~ 23 14
 blade, rear ~ 85 40
 blade, rotating ~ 39 24
 blade bit 145 21
 bladebone 95 22, 30, 32, 42
 blade coater 173 29-35
 blade coating machine 173 29-35
 blade covering 293 47
 bladed cone, rotating ~ 172 75
 bladed plug, rotating ~ 172 75
 bladed shell, stationary ~ 172 76
 blade of grass 370 83-85
 blade-slewing gear 200 22
 blancmange powder 98 50
 blank 252 43
 blanket 71 44; 168 56
 blanket, rubber ~ 180 54, 79
 blanket cylinder 180 24, 37, 54, 63
 blast burner 108 16
 blast furnace 147 1
 blast furnace plant 147 1-20
 blast furnace shaft 147 7
 blasting cartridge 158 27
 blasting fuse 158 28
 blast inlet 148 2
 blast lamp 108 16
 blast main 147 17, 68; 148 2
 blastodisc 74 65
 blast pipe *Blacksm.* 137 6
 blast pipe *Iron Foundry etc.* 148 2
 blast pipe *Railw.* 210 25
 blazer 33 54
 blazing star 51 31
 blazon 254 17-23
 blazonry 254 1-36
 bleach 105 1
 bleach-hardener 116 10
 bleaching 169 21
 bleach tube 105 3
 bleed 192 27
 bleeder 38 65
 bleeding heart 60 5
 blender 40 46
 blending pump 196 1
 Blessed Sacrament 331 48; 332 35
 blimp 310 48; 313 16-18, 27
 blind *Hosp.* 25 9
 blind *Hunt.* 86 9
 blinder 71 26
 blind spot 19 50
 blindworm 364 37
 blinker 71 26
 blob marker 83 9
 blob marking 83 6
 block *Headgear* 35 3
 block *Plumb.* 125 21
 block *Mach. Tools* 150 20
 block *Ship* 221 28, 105
 block *Winter Sp.* 302 40
 block *Music. Instr.* 326 20
 block, adjustable ~ 298 2
 block, charcoal ~ 108 37
 block, clay ~ 159 22, 23
 block, halftone ~ 178 38
 block, hollow ~ 119 24, 159 21-22, 22, 23
 block, pumice concrete ~ 119 24
 block, rubber ~ 187 85
 block, tongued and grooved ~ 123 74
 block, travelling ~ 145 8
 block, wooden ~ 340 1
 block and tackle 137 20
 block board 132 73
 block brake 143 97
 blocker 293 60
 blocking saw 157 54
 block instruments 203 59
 block making 178
 block mount 178 41
 block mountain 12 4-11
 block mounting 178 41
 block of flats 37 72-76
 block of flats, high-rise ~ 37 82
 block of flats, multi-storey ~ 37 77-81
 block section panel 203 60
 block step 123 17
 blood, arterial ~ 18 12
 blood, venous ~ 18 11
 blood circulation 18 1-21
 blood pressure 23 32; 25 1
 blood sausage 99 56
 blood sedimentation 23 42
 blood smear 23 50
 bloodstone 108 48
 blood vessel 19 33
 bloomer 97 8
 blooming train 148 50, 70
 bloom shears 148 52
 blossom 59 9; 69 14; 80 11
 blotter 46 23; 246 6; 260 25
 blouse 30 9
 blouse, girl's ~ 29 58
 blow, straight ~ 299 28
 blow-and-blow process 162 22
 blower *Furrier* 131 10
 blower *Paperm.* 172 4
 blower *Railw.* 211 11
 blower, travelling ~ 165 2, 3
 blower aperture 165 5
 blower fan 191 48; 192 62
 blower oil pump 211 45
 blower rail 165 6
 blowfly 358 18
 blowhole 367 26
 blowing 162 28, 36
 blowing, first ~ 162 24
 blowing assembly 165 4
 blowing iron 162 39
 blowing processes 162 22-37
 blowlamp 126 74; 301 22
 blow mould 162 26, 34

blowout magnet 312 39
 blowpipe *Gas Weld.* 141 11, 19; 141 28
 blowpipe *Ethnol.* 352 26
 blowpipe lighter 141 27
 blow pit 172 13
 blow position 147 57
 blow tank 172 11
 blowtorch 126 74; 301 22
 blow valve 172 12
 blubber-oil lamp 353 7
 blue *Colour* 343 3
 blue *Lepidopt.* 365 6
 blue-and-yellow macaw 363 2
 bluebell 375 14
 blueberry 377 23
 blue bird of paradise 363 3
 bluebottle 61 1; 358 18
 blue light 264 11; 270 6
 Blue Peter 253 26
 blue shark 364 1
 blue spruce 51 10
 bluetit 360 4
 blurb 185 39
 B minor 320 57, 60
 boar *Dom. Anim.* 73 9
 boar *Game* 88 51
 boar, young ~ 88 51
 board *Bldg. Site* 118 22, 87; 119 16
 board *Carp.* 120 1, 91
 board *Sawmill* 157 35
 board *Games* 276 1
 board, illuminated ~ 268 3
 board, presawn ~ 273 57
 board, squared ~ 120 95
 board, unsquared ~ 120 94
 board, wooden ~ 338 23
 board cutter 183 16
 board cutter, rotary ~ 184 20
 board-cutting machine, rotary ~ 184 20
 board feed hopper 184 7
 board games 276
 boarding 121 75
 boarding, horizontal ~ 37 84
 boarding platform 194 39
 boardman 251 7
 board platform 118 28
 board-sawing machine 132 68
 board support 132 70
 boarhound 86 33
 boar hunt 86 31
 boaster 158 37
 boat, carvel-built ~ 283 9
 boat, inflatable ~ 228 18; 258 82; 278 14; 279 27
 boat, ship's ~ 221 107; 258 12, 45; 259 35
 boat, V-bottom ~ 286 35-37
 boat, vee-bottom ~ 286 35-37
 boat axe 328 19
 boat carriage 278 20; 283 66
 boat deck 223 19-21
 boat elevator 217 29-38
 boater 35 35
 boat fibula 328 28
 boathouse 283 24
 boat-launching crane 258 13
 boat lift 217 29-38
 boat neck 30 34
 boats, folding ~ 283 54-66
 boatswain 221 114
 boat tank 217 33
 boat trailer 278 20; 283 66
 bobbin *Shoem.* 100 29
 bobbin *Dressm.* 103 12
 bobbin *Cotton Spin.* 164 52, 56, 60
 bobbin creel 164 28
 bobbin lace 102 18
 bobbin thread 104 16
 bobble 29 4
 bobblet 303 19
 bobsled 303 19
 bobsledding 303 19-21
 bobsleigh 303 19-21
 bobsleigh, two-man ~ 303 19
 bobstay 219 15
 bob wig 34 2
 boocie 305 21
 bock beer 93 26
 bodhisattva 337 10
 bodice 31 30
 bodkin *Basketm.* 136 35
 bodkin *Composing Rm.* 174 17
 bodkin beard 34 13
 body *Flat* 46 3
 body *Joiner* 132 24
 body *Lorries etc.* 194 3, 23
 body *Artery* 230 54
 body *Airports* 288 26
 body, bird's ~ 327 57
 body, dog's ~ 327 30
 body, dragon's ~ 327 19, 36
 body, fibre glass ~ 193 14
 body, horse's ~ 327 27, 54
 body, human ~ 16 1-54
 body, interchangeable ~ 213 40
 body, lion's ~ 327 14, 22
 body, man's ~ 327 53
 body, monocoque ~ 191 1
 body, monster's ~ 327 48
 body, pituitary ~ 174 3
 body, serpent's ~ 327 2, 33
 body, tambourine-like ~ 324 30
 body, unitary ~ 191 1
 body, woman's ~ 327 59
 body brush 71 55
 body-fixing plate 192 72
 body hammer 195 46
 bodyline 175 43
 body louse 81 41
 body of barrel 130 6
 body of wall 217 2
 body paper 173 29
 body plan 259 2-11
 body rotation 298 11
 body size 175 46
 body temperature 23 3
 body tube 113 8, 31-39
 bog 13 14-24
 bog bilberry 377 23
 bogie *Bldg. Site* 119 32
 bogie *Power Plant* 152 41
 bogie *Tram* 197 9

bogie *Railw.* 207 4; 208 4; 212 2; 213 11, 13
 bogie open freight car 213 24
 bogie open wagon 213 24
 bogie wagon 213 26
 bog pool 13 23
 bog whortleberry 377 23
 Bohr-Sommerfeld model 1 26
 boiler *Roof & Boilerr.* 38 24, 68
 boiler *Bakery* 97 69
 boiler *Energy Sources* 155 13
 boiler *Railw.* 210 16
 boiler, radiant-type ~ 152 5
 boiler, vertical ~ 210 62
 boiler barrel 210 16
 boiler feed pump 152 18
 boiler house *Market Gdn.* 55 7
 boiler house *Power Plant* 152 1-21
 boiler pressure 210 3
 boiler pressure gauge 210 47
 boiler room *Roof & Boilerr.* 38 38-43
 boiler room *Market Gdn.* 55 7
 boiler shop 222 9
 boiler suit 30 21
 boiling fowl 99 60
 boiling water system 154 49
 bola 352 31
 bolas 352 31
 bold 175 2
 bold condensed 175 10
 boldface 175 2
 bole 84 19, 22; 85 23, 41; 370 2, 7
 Boletus edulis 381 16
 Boletus luteus 381 21
 Boletus scaber 381 22
 boll 383 8
 bollard 217 12
 bollard, cross-shaped ~ 217 13, 14; 227 10
 bollard, double ~ 217 11, 14
 bollard, recessed ~ 217 10
 bolster *Bedrm.* 43 11
 bolster *Tablew. etc.* 45 55
 bolster plate 85 48
 bolt *Slaughterho.* 94 4
 bolt *Roof* 121 98
 bolt *Metalwkr.* 140 39
 bolt *Mach. Parts etc.* 143 31
 bolt *Office* 246 23
 bolt, collar-head ~ 143 32
 bolt, countersunk-head ~ 143 28
 bolt, hexagonal-head ~ 143 13
 bolt, square-head ~ 143 39
 bolt, T-head ~ 143 41
 bolter 91 26
 bolt guide pin 140 41
 bolt handle 87 22
 bolt lever 87 22
 bolts 143 13-50
 bombard 322 14
 bombardon 323 44
 bomber jacket 31 42
 bombycid moth 358 48
 bond *Bldg. Site* 118 30
 bond *Stock Exch.* 251 1-10, 11-19
 bond, convertible ~ 251 11-19
 bond, English ~ 118 62
 bond, industrial ~ 251 11-19
 bond, municipal ~ 251 11-19
 bonding, rubber ~ 192 82
 bone 70 33; 354 40
 bone, ethmoid ~ 17 39
 bone, frontal ~ 17 30
 bone, hyoid ~ 20 2
 bone, jugal ~ 16 8
 bone, lacrimal ~ 17 40
 bone, malar ~ 16 8
 bone, metacarpal ~ 17 16
 bone, nasal ~ 17 41
 bone, occipital ~ 17 32
 bone, parietal ~ 17 31
 bone, sphenoid ~ 17 38
 bone, tarsal ~ 17 26
 bone, temporal ~ 17 33
 bone, zygomatic ~ 16 8; 17 37
 bone chisel 24 49
 bone-cutting forceps 26 51
 bone lace 102 18
 bone nippers 26 51
 bones 17 1-29
 bone saw *Slaughterho.* 94 19
 bone saw *Buich.* 96 56
 bongo drum 324 58
 boning knife 96 36
 bonnet *Car* 191 8
 bonnet *Garage* 195 36
 bonnet *Ship* 218 34
 bonnet support 195 37
 book 42 4; 46 8; 185 36, 52
 book, children's ~ 47 17; 48 23
 book, second-hand ~ 309 55
 book, sewn ~ 185 22
 book, unbound ~ 183 32
 bookbinder 183 2
 bookbinding 183; 184; 185
 bookbinding machines 184 1-23; 185 1-35
 bookcase unit 46 7
 book cover 185 40
 book delivery 184 5
 bookjacket 185 37
 bookmark, attached ~ 185 70
 bookmark, loose ~ 185 71
 bookmarker, attached ~ 185 70
 bookmarker, loose ~ 185 71
 bookplate 185 51
 book-sewing machine 185 16
 bookshelf 42 3; 43 14; 262 12
 bookshelf unit 46 7
 bookshop 268 37
 book stack 262 11
 boom *Bldg. Site* 119 36
 boom *Docks* 226 49
 boom *Sailing* 284 7, 39
 boom, double ~ 229 35
 boomerang 352 39
 boom foresail 220 12
 boom microphone 311 40
 boom operator 310 22
 boom swinger 310 22
 booster rocket 234 1, 2

boost gauge 230 7
 boot *Shoem.* 100 57
 boot *Car* 191 24; 193 23
 boot *Music. Instr.* 326 17
 boot, baby's ~ 101 56
 boot, felt ~ 353 30
 boot, ladies' ~ 101 12
 boot, men's ~ 101 5
 boot, pony-skin ~ 101 10
 boot, rubber ~ 289 32
 boot, Western ~ 101 9
 bootee 28 45; 29 5
 Boötes 3 30
 booth 308 6
 bootlace 100 64; 291 32
 boot lid 191 7
 bootmaker 100
 boot space 193 17
 borage family 69 13
 Boraginaceae 69 13
 border *Fruit & Veg. Gdn.* 52
 18, 22
 border *Basketm.* 136 17
 border *Park* 272 37
 border *Theatre* 316 12
 border light 316 13
 bore 143 86
 bore axis 87 38
 bore diameter 87 40
 borehole 158 12
 borer 80 18
 boring machine 175 49
 boring mill 138 22
 boring mill column 150 31
 boring motor 133 7
 boring tool 149 51
 borrower's ticket 262 25
 bosage 272 4
 bosh 137 8
 bo's'n 221 114
 bosom 16 30
 boss *Chivalry* 329 58
 boss *Art* 335 32
 bostryx 370 76
 bo'sun 221 114
 botany 370
 bottle *Brew.* 93 21
 bottle *Restaurant* 266 16
 bottle *Swim.* 279 19
 bottle, collapsible ~ 116 9
 bottle, non-returnable ~ 93
 29
 bottle, three-necked ~ 350 57
 bottle, wicker ~ 206 13
 bottle, wickered ~ 206 13
 bottle basket 79 13
 bottle bobbin 167 4
 bottle-capping machine 76 46
 bottle kiln 161 3
 bottle-making machine 162
 21
 bottle-nosed dolphin 367 23
 bottle-opener 45 47
 bottle rack *Kitch.* 39 6
 bottle rack *Wine Cell.* 79 11
 bottlescrew 284 19
 bottle warmer 28 21
 bottle washer 93 19
 bottle-washing machine 93
 19
 bottle-washing plant 93 18

bottling 93 22
 bottling machine, circular ~
 79 9
 bottling machine, semi-
 automatic ~ 79 9
 bottom 16 40
 bottom, artificial ~ 301 52
 bottom, cellular ~ 222 60
 bottom, cut-in ~ 119 56
 bottom, double ~ 222 60
 bottom, synthetic ~ 301 52
 bottom bracket bearing 187
 42
 bottom outlet 269 34
 bottom plating 222 48
 bottom plating, inner ~ 222
 54
 bott stick 148 10
 boudoir piano 325 40
 bough 370 5
 bouillon cube 98 27
 boule, grooved ~ 305 24
 boules 305 21
 boules player 305 22
 bounce 297 36
 bouncing ball 273 20
 boundary layer control flap
 256 6; 257 13
 boundary ridge 63 3
 boundary stone 63 2
 bouquet, bridal ~ 332 18
 bouquetin 367 7
 bourgeois 175 26
 bout 294 5-6
 Bovista nigrescens 381 19
 bow *Ladies' Wear* 30 46
 bow *Hairst. etc.* 34 7
 bow *Metalwkr.* 140 34
 bow *Shipbuild.* 222 74-79
 bow *Warships* 258 3
 bow *Rowing* 283 13
 bow *Music. Instr.* 323 12
 bow *Ethnol.* 354 32
 bow *Hist. Cost.* 355 78
 bow, bulbous ~ 221 45; 222
 74
 bow, fully enclosed ~ 259 9
 bow, sliding ~ 205 36
 bow and arrow 327 53
 bow bilge 259 80
 Bowden cable 188 37;
 189 12
 bow door 221 30
 bowed instruments 323 1-27
 bowels 20 14-22
 bower 272 17
 bower, ladies' ~ 329 10
 bower anchor 258 39; 286 15
 bow fender 227 17
 bow gin 87 48
 bowl 40 6; 45 63; 105 1; 107
 36
 bowler 292 76
 bowler hat 35 28
 bow light, green and red ~ 286
 13
 bowline 218 35
 bowling ball 305 15
 bowling crease 292 71
 bowl lid 107 37
 bowls 305 21

bow-manoeuving propeller
 224 23
 bow propeller 228 33
 bow ramp 258 90
 bowsprit 218 20; 219 1
 bow stick 323 14
 bow string 305 59
 bow thruster 224 23
 bow-tie 32 47; 33 11, 16
 bow trap 87 48
 bow wave 223 81
 box *Livestock* 75 2
 box *Carriages* 186 8
 box *Gymn.* 296 15
 box *Athletics* 298 35
 box *Fair* 308 7
 box *Bullfight. etc.* 319 7
 box, centrifugal ~ 169 17
 box, coach's ~ 292 56
 box, crossing keeper's ~ 202
 43
 box, gateman's ~ 202 43
 box, racer's ~ 290 7
 box, rider's ~ 290 7
 box, small ~ 296 16; 297 9
 box attendant 315 12
 box camera 309 30
 boxcar 213 14, 22
 boxer *Dog* 70 10
 boxer *Sports* 299 25
 box feeder 159 7
 box gutter 122 83
 boxing 299 20-50
 boxing contest 299 35-50
 boxing glove 299 26
 boxing match 299 20-50,
 35-50
 boxing ring 299 35
 box office 308 7
 box pile 217 6
 boxroom door 38 20
 box spar 287 30
 box spur 71 50
 box trap 86 20
 box tree 373 19
 boy scout 278 11
 bra 32 1; 318 29
 bra, longline ~ 32 4
 brace *Bldg. Site* 119 63
 brace *Carp.* 120 27, 54
 brace *Roof* 121 41, 58, 69, 82
 brace *Ship* 219 67
 brace *Music. Instr.* 325 16
 brace, diagonal ~ *Bldg. Site*
 118 88; 119 51
 brace, diagonal ~ *Bridges* 215
 4
 bracelet 36 3
 bracelet, cultured pearl ~ 36 9
 bracelet, gemstone ~ 36 25
 bracelet watch 36 33
 braces 29 26, 34; 32 30
 braces, adjustable ~ 33 45
 braces clip 32 31
 brachioradialis 18 39
 bracing 215 3
 bracing, diagonal ~ 119 14
 bracken 15 5; 377 16
 bracket *Doc.* 23 10
 bracket *Plumb. etc.* 126 6
 bracket *Bicycle* 187 77

bracket *School* 260 30
 bracket *Winter Sp.* 302 17;
 303 7
 bracket, chrome ~ 188 60
 bracket, round ~ 342 24
 bracket, square ~ 342 25
 Brackett series 1 23
 bract 371 7; 372 5
 bracteate 252 4
 bract scale 372 5
 braid, floral ~ 30 28
 braid embroidery 102 31
 braid work 102 31
 Braille 342 15
 brain-stem 17 47; 18 24
 brake *Mills* 91 8
 brake *Carriages* 186 2, 16
 brake *Car* 191 45
 brake *Air Force* 257 10
 brake *Forest Plants etc.* 377 16
 brake, automatic ~ 181 47
 brake, auxiliary ~ 212 10
 brake, covered ~ 186 33
 brake, front ~ 187 5
 brake, hydraulic ~ 212 44
 brake arm 187 66
 brake arm cone 187 67
 brake axle 143 99
 brake band 143 105
 brake block *Mach. Parts etc.*
 143 100
 brake block *Carriages* 186 16
 brake cable 188 37; 189 12
 brake casing 187 70
 brake chute housing 257 24
 brake cone 187 71
 brake cylinder pressure gauge
 212 7
 brake disc 191 17; 192 48
 brake drum 138 11, 20
 brake flap *Aircraft* 229 44
 brake flap *Air Force* 256 12
 brake flap *Gliding* 287 38
 brake fluid reservoir 191 49
 brake line *Motorcycle* 189 12
 brake line *Car* 192 53
 brake lining *Blacksm.* 138 13
 brake lining *Mach. Parts etc.*
 143 106
 brake lining *Car* 192 52
 brake lock 56 38
 brake magnet 143 102
 brakeman 303 21
 brake pedal *Gdn. Tools* 56 40
 brake pedal *Offset Platem.*
 179 12, 30
 brake pedal *Car* 191 45, 95
 brake pressure gauge 210 50
 brake pulley 143 98
 brake shaft 143 99
 brake shoe *Blacksm.* 138 12
 brake shoe *Mach. Parts etc.*
 143 100
 brake shoe *Car* 192 51
 brake system, dual-circuit ~
 191 72
 brake-testing equipment 138
 16
 brake weight 143 103
 brake wheel 91 7
 braking disc 191 17; 192 48

braking distance 203 29
 braking roller 138 18
 branch *Railw.* 203 48
 branch *Fire Brig.* 270 33
 branch *Maths.* 347 15
 branch *Bot.* 370 5, 6
 branch *Decid. Trees* 371 10,
 25, 27, 32, 59
 branch *Conifers* 372 36, 43
 branch *Trop. Plants* 382 17
 branch *Industr. Plants* 383 61
 branch *South. Fruits* 384 12,
 42
 branch, flowering ~ 58 32,
 52; 59 1, 26, 37
 branch, fruit-bearing ~ 59 19,
 48
 branch, fruiting ~ 59 30
 branch, left ~ 203 47
 branch, right ~ 203 46
 branch line 15 23
 branchman 270 34
 brandy 98 59
 brandy glass 45 88
 brushing 84 12
 brass 323 39-48
 brassard *Fire Brig.* 270 22
 brassard *Chivalry* 329 47
 brassica 57 32
 brassicas 57 28-34
 brassie 293 91
 brassière 32 1; 318 29
 brassière, longline ~ 32 4
 brass instruments 323 39-48
 brayer 340 12
 Brazil Current 14 35
 Brazil nut 384 53, 59
 breach 13 34
 bread 45 22; 97 2
 bread, kinds of ~ 97 6-12; 99
 11
 bread, wrapped ~ 97 48-50
 bread basket 45 20
 bread-corn 68 1-37
 bread counter 99 9
 bread crust 97 4
 breadth scale 157 58
 bread unit 97 56-57
 break *Brew.* 93 2
 break *Composing Rm.* 175 15
 break *Carriages* 186 2
 break, covered ~ 186 33
 break-bulk cargo, unitized ~
 226 11
 break-bulk cargo elevator,
 floating ~ 226 31
 break-bulk cargo transit shed
 225 9
 break-bulk carrier 225 14;
 226 13
 breakdown lorry 270 47
 breaker *Overh. Irrign.* 67 34
 breaker *Swim.* 279 6
 breaker spring 67 35
 break removal 93 1-5
 breakstone, rotundifoliate ~
 375 1
 breakwater *Hydr. Eng.* 217 16
 breakwater *Docks* 225 65
 breakwater *Warships* 258 7,
 76

breast *Man* 16 28-29
 breast *Horse* 72 19
 breast beam 166 46
 breast beam board 166 16
 breastbone *Man* 17 8
 breastbone *Meat* 95 27
 breastbox 173 11
 breast collar 71 28
 breast collar ring 71 27
 breast drill 140 58
 breast harness 71 26-36
 breast of veal 95 4
 breastplate 329 46
 breast pocket 33 9
 breasts 16 28-29
 breaststroke 282 33
 breastwork 329 21
 breather 153 10
 breathing apparatus 26 1; 270
 39
 breathing tube 27 37
 breccia 11 27
 breeches 300 7
 breeches, loose ~ 355 34
 breeches, white ~ 289 5
 breeches buoy 228 13
 breech ring 255 54
 breeding comb 77 46
 breeds of dog 70
 breeze 120 44
 breve 320 12
 breve rest 320 20
 breviary 331 58
 brevier 175 25
 brevis 320 12
 brewer 92 49
 brewery 93 1-31
 brewhouse 93 1-31
 brewing 92; 93
 briar grain 107 41
 briar rose 373 26
 brick 118 40
 brick, cellular ~ 159 28
 brick, green ~ 159 16
 brick, perforated ~ 159 21-22,
 21
 brick, radial ~ 159 25
 brick, radiating ~ 159 25
 brick, solid ~ 159 20
 brick, standard ~ 118 58
 brick, unfired ~ 159 16
 brick cutter 159 15
 brickfield 159
 brick hammer 118 53
 brick kiln 159 19
 bricklayer 118 18
 bricklayer's tools 118 50-57
 brickmason 118 18
 brickmason's tools 118 50-57
 brick-pressing machine 159
 11
 brickwork, frost-resistant ~
 122 39
 brickwork base 123 15
 brickworks *Map* 15 89
 brickworks 159
 brickyard 159
 bride 332 15
 bridegroom 332 16
 bridesmaid 332 24
 bridge *Map* 15 44

bridge *Optics* 111 11
 bridge *Station* 205 3
 bridge *Ship* 221 6, 12; 223 12-18
 bridge *Shipbuild.* 222 26
 bridge *Warships* 258 14; 259 3, 28
 bridge *Park* 272 47
 bridge *Free Exerc.* 295 19
 bridge *Sports* 299 9
 bridge *Theatre* 315 29; 316 34
 bridge *Music. Instr.* 322 17
 bridge, cable-stayed ~ 215 46
 bridge, covered ~ 215 32
 bridge, cross-section of ~ 215 1
 bridge, dental ~ 24 26
 bridge, flat ~ 215 52
 bridge, iron ~ 15 56
 bridge, reinforced concrete ~ 215 49
 bridge, rope ~ 215 15
 bridge, solid ~ 215 19
 bridge, stone ~ 15 50
 bridge bearing 215 55
 bridge deck 223 12-18
 bridge over railway 15 40
 bridge ring 89 58
 bridges 215
 bridge strut 215 30
 bridge superstructure 258 14
 bridge support 222 12
 bridge under railway 15 42
 bridle 71 7-13
 bridle path 12 46
 briefcase 41 17
 briefs 32 26
 brig 220 17
 brigantine 220 14
 brightness control 240 33
 brille 323 35
 brilliant 175 21
 brilliant cut 36 44
 brimstone butterfly 365 4
 brine channel 274 3
 brine pipe 274 4
 briolette, faceted ~ 36 86
 Brisinga endecacnemus 369 11
 brisket, hind ~ 95 25
 brisket, middle ~ 95 26
 brisket of beef 95 23
 bristle 88 52
 bristles *Hairst. etc.* 34 23
 bristles *Household* 50 47
 bristletail 81 14
 bristle worm 357 22
 broach 109 8
 broaching tap 93 14
 broach roof, conical ~ 121 24
 B road 15 36
 broad axe 120 70
 broad bean *Veg.* 57 8
 broad bean *Fodder Plants* 69 15
 broadcasting 238; 239; 240
 broadcasting centre 238 16-26
 broadcasting station 15 33
 broadsheet 340 27

broadside 340 27
 broadside fire 218 59
 broadtail *Ladies' Wear* 30 60
 broadtail *Furrier* 131 21
 brochure 250 7
 broderie anglaise 102 11
 broiler 98 6; 308 33
 broiler chicken 74 12
 broiler rearing 74 11-17
 broken thread detector roller 164 4
 broken thread stop motion 165 19
 broker, commercial ~ 251 5
 broker, inside ~ 251 4
 broker, outside ~ 251 5
 bronchus 20 5
 Bronze Age 328 21-40
 brooch, ivory ~ 36 30
 brooch, modern-style ~ 36 19
 brooch, pearl ~ 36 7
 brood bud bulblet 54 27, 29
 brood cell 77 31
 brood chamber 77 46
 brooder 74 3
 brook 13 8; 15 80
 broom 38 36; 50 46; 62 5; 199 6; 268 21; 272 67
 broom *Shrubs etc.* 374 20
 broom, circular ~ 199 40
 broom, cylinder ~ 199 42
 broom, inverted ~ 224 99
 broom, upward-pointing ~ 224 100
 broom handle 38 37; 50 49
 broom head 50 48
 broomstick 38 37; 50 49
 brougham 186 3
 brow antler 88 6
 browband 71 9
 brown 343 5
 brown ale 93 26
 brown bear 368 10
 brown leaf-eating weevil 80 49
 Brown Ring Boletus 381 21
 brown-tail moth 80 28
 brown trout 364 15
 brow point 88 6
 brow snag 88 6
 brow tine 88 6
 brush *Roof & Boilerm.* 38 32
 brush *Household* 50 42, 53
 brush *Bees* 77 7
 brush *Forestry* 84 5
 brush *Game* 88 47
 brush *School* 260 59
 brush *Graphic Art* 340 11
 brush *Script* 341 24
 brush, camel hair ~ 338 7
 brush, dry ~ 128 49
 brush, flat ~ *Painter* 129 17
 brush, flat ~ *Art. Studio* 338 6
 brush, rotating ~ 168 46
 brush, round ~ 338 8
 brush, stiff-bristle ~ 105 16
 brush, wire ~ *Gas Weld.* 141 26
 brush, wire ~ *Arc Weld.* 142 18

brush, wire ~ *Music. Instr.* 324 53
 brush head 50 79
 brush head, detachable ~ 49 30
 brushwood *Map* 15 15
 brushwood *Forestry* 84 5
 brushwood *Spa* 274 2
 Brussels lace 102 18
 Brussels sprout 57 30
 bubble bath 49 3
 bubble chamber 1 58
 bubble float, oval ~ 89 47
 buccaneer 306 43
 Büchner funnel 349 11
 buck *Dom. Anim.* 73 18
 buck *Game* 88 28, 40, 59
 buck *Gymn.* 296 17
 buck, young ~ 88 39
 bucket *Household* 50 54
 bucket *Mills* 91 36
 bucket *Bldg. Site* 118 82
 bucket *Road Constr.* 200 5
 bucket chain 226 42
 bucket dredger 226 41
 bucket elevator 200 49; 201 21
 bucket elevator chain 216 57
 bucket ladder 226 43
 bucket pump 269 7
 bucket seat *Car* 193 11
 bucket seat *Sports* 305 90
 bucket teeth 200 6
 bucket-top boot 355 58
 buckeye 371 58
 buckle 101 52
 buckle and knife folder 185 8
 buckle and knife folding machine 185 8
 buckle fold 185 11
 buckler 329 57
 bucksaw 120 61
 bud 54 23, 26; 58 27; 59 22; 60 16; 61 3
 bud, axillary ~ 370 25
 bud, terminal ~ 370 22
 bud cutting 54 22
 Buddha 337 20
 budding 54 30
 budding knife 54 31
 buffalo 367 8
 buffalo horn 254 34
 buffer *Station* 206 51
 buffer *Railw.* 213 7
 buffer *Army* 255 27, 44, 52
 buffer recuperator 255 52
 buffer ring 255 44
 buffer storage 242 33
 buffet 207 78-79
 buffet car, quick-service ~ 207 73
 buffet compartment 207 78-79
 buffing machine 108 46
 buffing wheel 100 10
 buffoon 306 38, 69
 bug 81 39
 buggy 193 12
 buggy, American ~ 186 49
 buggy, English ~ 186 48
 bugle 309 54
 building, centralized ~ 334 55

building, centrally-planned ~ 334 55
 building, model ~ 48 28
 building, neoclassical ~ 336 15
 building, public ~ 15 54
 building berth 222 11-18
 building berths 222 11-26
 building block 28 41; 48 27
 building board, lightweight ~ 123 58
 building brick *Infant Care etc.* 28 41
 building brick *Kindergart.* 48 27
 building brick *Brickwks.* 159 20
 building glazier 124 8
 building site 118; 119
 building slips 222 11-26
 building timber 120 10, 83-96
 built piece 315 32
 built unit 315 32
 bulb, glass ~ 127 57
 bulb, old ~ 54 28
 bulb-head pin 328 29
 bulbil 54 27, 29; 375 38
 bulk cargo 221 11
 bulk cargo handling 226 29
 bulk carrier *Ship* 221 9
 bulk carrier *Docks* 225 67; 226 30
 bulk goods 221 11
 bulkhead, protective ~ 305 91
 bulk material 200 12
 bulk transporter barge 226 35
 Bull *Astron.* 3 25; 4 54
 bull *Dom. Anim.* 73 1
 bull *Heraldry* 254 15
 bull, mock ~ 319 3
 bull, young ~ 319 35
 bulldog 70 1
 bulldozer 199 16; 200 28
 bulldozer blade 200 29
 bulldozer for dumping and compacting 199 18
 bullfight 319 1-33, 24
 bullfight, mock ~ 319 1
 bullfighting 319
 bullfinch 360 5
 bull pen 319 14
 bullring 319 5
 bull's eye 336 2
 bull's-eye glass 124 6
 bull terrier 70 16
 bulrush 136 27
 bulwark 221 120; 222 67
 bumblebee 358 23
 bumper *Tram* 197 12
 bumper *Station* 206 51
 bumper, front ~ 191 13
 bumper, integral ~ 193 33
 bumper car 308 62, 63
 bumper steel 166 44
 bumper steel stop rod 166 45
 bump rubber 192 82
 bun 34 29
 bun, iced ~ 97 39
 bun, plaited ~ 97 41
 bunches 34 30
 bunch of fruit 384 32

bunch of grapes 78 5; 99 89
 bunch pink 60 6
 bungalow 278 7
 bunghole 130 7
 bunk, folding ~ 259 84
 bunk, rear ~ 85 49
 bunk-bed 47 1
 bunker 293 81
 bunkering boat 225 13
 Bunsen burner 173 5; 350 1
 Bunter downthrow 154 61
 bunting 253 3, 11
 buntings 361 6-7
 bunt line 218 36; 219 71
 buoy 90 2; 216 12; 224 71; 285 17, 18; 286 31
 buoy, conical ~ 224 76
 buoy, green ~ 224 84
 buoy, port hand ~ 224 95
 buoy, starboard hand ~ 224 96
 buoyancy tube 286 27
 buoy rope 90 3
 bur 24 37
 burden chain 139 44
 burette 350 21
 burette clamp 350 23
 burette stand 350 22
 burgee 253 22; 284 48
 Burgundian 355 40
 burial 331 33-41
 burial place, underground ~ 331 59
 burin 175 33; 340 5, 15, 20
 burner *Power Plant* 152 6
 burner *Glass Prod.* 162 6
 burner, gas ~ 139 3, 48
 burner platform 288 80
 burner ventilator 92 17
 burning-in oven 179 32
 burnisher *Goldsm. etc.* 108 51
 burnisher *Watchm.* 109 17
 burnishing 109 17
 burnous 354 7
 burr 88 5, 29
 burrow *Soft Fruit* 58 63
 burrow *Hunt.* 86 26
 burying ground 331 21-41
 bus 194 17
 bus, double-deck ~ 194 36
 bus, double-decker ~ 194 36
 bus, electrical system ~ 235 55
 busbar 152 29
 buses *Lorries etc.* 194
 'buses' *Airport* 233 35
 bush, rubber ~ 192 67
 bushing 162 50
 bushing chain, double ~ 190 49
 bushing tip 162 51
 bushman 354 29
 bushman woman 354 34
 business and passenger aircraft 231 3, 7
 business letter 245 33; 246 7; 248 30
 business trip 209 29
 bust 42 17
 bustle 355 69
 bustle pipe 147 53
 butane gas 278 33
 butane gas bottle 278 34

butcher 96 38, 58
 butcher knife 94 15; 96 37
 butcher's shop 96 1-30
 butt *Hunt.* 86 47-52, 51; 87 3, 7
 butt *Meat* 95 50
 butt *Army* 255 9, 24, 31, 39
 butt *Sports* 305 47
 butt, bound ~ 89 55
 butt, cork ~ 89 50
 butt end 85 41
 butter 98 22; 99 47
 butter, branded ~ 76 37
 butter-and-eggs 376 26
 butter churn 76 33
 butter-cream cake 97 24
 buttercup 375 8
 butter dish 45 36
 butterflies 358 48-56; 365 1-6
 butterflower 375 8
 butterfly *Free Exerc.* 295 35
 butterfly *Articulates* 358 52
 butterfly nut 143 42; 187 39
 butterfly stroke 282 34
 butterfly tail 229 31
 butterfly valve 192 9
 butter knife 45 73
 butter-making, continuous ~ 76 33
 buttermilk tank 76 18
 butter shaping and packing machine 76 32
 butter supply pipe 76 34
 butterwort 377 13
 button *Tram* 197 32
 button *Fencing* 294 45
 button *Music. Instr.* 325 31
 button, staghorn ~ 29 33
 button box 103 15
 buttonhole 332 21
 buttonhole stitch 102 6
 button stitch 102 6
 butt plate *Hunt.* 87 14
 butt plate *Sports* 305 46
 buttress *Chivalry* 329 26
 buttress *Art* 335 27
 buttresses 335 27-28
 butt ring 89 58
 buzzer, electric ~ 127 15
 buzz saw 119 19; 125 24; 134 50
 buzz saw blade 132 59
 by-line 291 7
 bypass air flow 232 50
 bypass duct 232 41, 44
 bypass engine 232 46
 bypass switch 211 25

C

cab *Carriages* 186 26, 28
 cab *Lorries etc.* 194 2
 cab *Town* 268 64
 cab, driver's ~ 64 36; 194 2, 15; 200 11; 208 14; 209 6; 210 39-63, 49; 211 19, 57; 212 5; 213 2
 cab, engineer's ~ 208 14; 209 6; 210 39-63, 49; 211 19, 57; 212 5; 213 2

cabbage, green ~ 57 32
cabbage, red ~ 57 32
cabbage, round ~ 57 32
cabbage lettuce 57 36
cabbage white butterfly 80 47, 48
cab frame 65 21
cab heating switch 211 39
cab horse 186 28
cabin *Railw.* 214 20, 28
cabin *Ship* 218 45
cabin *Sailing* 285 39
cabin *Airsports* 288 19
cabin, admiral's ~ 218 27
cabin, captain's ~ 223 13
cabin, commanding officer's ~ 259 85
cabin, coxswain's ~ 228 31
cabin, crane driver's ~ 119 35; 222 16; 226 52
cabin, de luxe ~ 223 30
cabin, double-berth ~ 223 29
cabin, large-capacity ~ 214 52
cabin, officer's ~ 223 21
cabin, single-berth ~ 223 46; 228 32
cabin cruiser 286 3
cabinet 22 40; 246 20
cabinet maker 132 38
cabin pulley cradle 214 66
cabin superstructure 285 39
cable *Sea Fish.* 90 26
cable *Power Plant* 153 41
cable *Music. Instr.* 326 53
cable, auxiliary ~ 214 47
cable, electric ~ 56 32
cable, endless ~ 214 21
cable, high-voltage ~ 153 42
cable, lower ~ 214 46
cable, moisture-proof ~ 127 42
cable, submarine ~ 237 56
cable, thermoplastic ~ 127 42
cable, three-core ~ 127 44
cable binding 301 40
cable boom 195 15
cable box 153 33
cable clip 127 40
cable connection 6 26
cable connection panel 239 3
cable crane berth 222 11-18
cable drum 85 39; 270 55
cable duct 234 29, 47; 235 61
cable ferry 216 1
cable guide 201 7
cable guide rail 214 33
cable manhole 198 17
cable parachute 287 7
cable pattern 30 39
cable pulley, automatic ~ 301 62
cable railway 214 12
cable release 23 9; 114 38; 115 101
cable release, double ~ 115 102
cable release socket 117 6
cable support 214 76
cable suspension lines 214 15-38
cable tunnel 152 20

cable vault 152 21
cableway 214 30
cableway, endless ~ 214 19
cableway gondola 214 52
cableways 214 15-38
cable winch 85 38, 46; 255 69; 258 85
cabochon, high ~ 36 79
cabochon, octagonal ~ 36 81
cabochon, oval ~ 36 80
cabochon, round ~ 36 78
cabochon, simple ~ 36 78
cabochons 36 78-81
caboose 223 42
cabriole 314 21
cabriole 186 29
cacao bean 382 19
cacao tree 382 16
cachalot 367 25
caddis fly 358 12
caecum 20 17
café 265 1-26
café, open-air ~ 272 57
café customers 265 22-24
café table 265 11
cage *Fish Farm.* 89 1
cage *Coal* 144 23
cage *Circus* 307 50
cage, crane driver's ~ 119 35; 222 16; 226 52
cage, outside ~ 356 11
cage, rotating ~ 168 17
cage, round ~ 307 49
cage, stepped ~ 74 20
cage, tiered ~ 74 20
cage caravan 307 62
cage system 74 18
cage-winding system 144 23
caisson 217 33; 222 32; 259 19
cake 169 19-27, 22
cake counter 99 9; 265 1
cake plate 97 25
cakes 97 17-47
cake tin 40 28, 29
calabash 354 27
calcaneum 17 27
calcite 351 22
calcium chloride tube 350 43
calculating machine 309 80
calculation, logarithmic ~ 345 6
calculator 309 80
calculator, electronic ~ 246 12
calculator dial *Photog.* 114 57
calculator dial *Photograv.* 182 19
calculus, infinitesimal ~ 345 13-14
calendar 22 10
calendar clock 110 19
calendar sheet 247 33
calender 173 36
calendering machine 168 38
calender roll 173 26, 38
calender roller 163 20, 37, 59
calf *Man* 16 53
calf *Farm Bldgs.* 62 33
calf *Dom. Anim.* 73 1
calf *Game* 88 1
calf *Meat* 95 1-13
caliber 87 40

calibre 87 40
California Current 14 39
caliper *see* calliper
call, local ~ 237 3
call, long-distance ~ 237 3
call box 204 46; 236 8; 237 1; 251 10; 268 56
call button 25 6; 127 3; 246 15
calliper *Car* 191 18
calliper *Sculpt. Studio* 339 3
calliper, fixed ~ 192 49
calliper, inside ~ 135 23
calliper, outside ~ 135 18
calliper gauge 149 59
calliper square 85 10
call light 315 52
callosity 72 27
calls for luring game 87 43-47
calm 9 11
calm belts 9 46-47
calms, equatorial ~ 9 46
calvarium 261 16, 18
calyx 58 8; 374 8
calyx, involucre ~ 375 33
calyx, renal ~ 20 30
cam 190 60
Camberwell beauty 365 5
cambium ring 370 10
came 124 13
camel 366 29
camel caravan 354 1
camera *Atom* 1 60
camera *Optic. Instr.* 112 14, 20
camera *Cine Film* 117 28
camera *Audiovis.* 243 1
camera *Films* 310 19
camera, cartridge-loading ~ 114 11
camera, compact ~ *Cine Film* 117 51
camera, compact ~ *Photomech. Reprod.* 177 32
camera, folding ~ 114 49; 300 25
camera, high-speed ~ 313 35
camera, large-format ~ *Optic. Instr.* 112 25, 36
camera, large-format ~ *Photog.* 114 49, 61
camera, miniature ~ *Doc.* 23 7
camera, miniature ~ *Optic. Instr.* 112 26
camera, miniature ~ *Photog.* 114 1; 115 1
camera, 35 mm ~ *Photog.* 114 1
camera, 16 mm ~ *Cine Film* 117 43
camera, 35 mm ~ *Films* 313 1
camera, 16 mm ~ *Films* 313 31
camera, narrow-gauge ~ 313 35
camera, photogrammetric ~ 112 68
camera, professional press-type ~ 117 66
camera, rapid-sequence ~ 115 77

camera, single-lens reflex ~ 115 1
camera, spectrographic ~ 5 6
camera, stereometric ~ 112 71
camera, subminiature ~ 114 16
camera, Super-8 ~ 117 51
camera, underwater ~ 279 24
camera assistant 117 68; 310 42
camera back 114 54; 115 23
camera body *Photog.* 115 2
camera body *Photomech. Reprod.* 177 25, 33
camera cable 239 2
camera case 115 103
camera control 242 36
camera crane 310 49
camera door 313 25
camera head 240 27
camera lens 313 19
cameraman 117 67; 310 20
cameraman, first ~ 310 41
camera monitor 238 65; 239 12; 240 28
camera operator 310 42
camera tube switch 242 23
cam housing 167 13
camomile *Weeds* 61 8
camomile *Med. Plants* 380 1
camp *Games* 276 27
camp *Circus* 307 61
campanil 334 65
camp bed 278 59
camp chair, folding ~ 278 vp
camp cot 278 59
camper 278 46
camp fire 278 10
campground 278 1-59
camphor laurel 380 18
camphor tree 380 18
camping 278
camping site 278 1-59
camping tableware 278 45
campion 376 20
camp site 278 1-59
camp site attendant 278 2
camp table, folding ~ 278 44
camshaft 166 56; 190 11, 14
camshaft bearing 192 24
camshaft lubrication 190 13
camshaft wheel 166 55
can *Butch.* 96 26
can *Supermkt.* 99 91
can *Painter* 129 7
can *Weaving* 166 21
Canadian pondweed 378 56
Canadian waterweed 378 56
canal *Map* 15 57
canal *Hydr. Eng.* 217 15-28
canal, auditory ~ 17 34, 58
canal, stomachic-intestinal ~ 77 15-19
canal administration 217 24
canal bed 217 30
canal entrance 217 15-16
Canary Current 14 41
can buoy 224 77, 94
cancel button 326 41
cancellation button 271 4
Cancer 4 56

candelabra 45 16
candidate 263 20
candies *Grocer* 98 75-86
candle, cast ~ 260 76
candle, paschal ~ 330 44
candle, wax ~ 77 66; 260 76
candlestick 309 45
candlestick, paschal ~ 330 45
candlewick yarn 35 9
candy 98 75
cane, flowering ~ 58 14
can holder 163 36
Canidae 367 11-13
canine 19 17
Canis Major 3 14
Canis Minor 3 15
canister 84 35; 129 16
canned vegetables 98 17
cannon *Horse* 72 23
cannon *Army* 255 49, 92
cannon cracker 306 53
canoe 352 19
canoe, Alaskan ~ 283 4
canoe, Canadian ~ 283 3
canoeing 283
canoeist 283 55
canoes 283 54-66
canoe stern 285 44
canoe with outrigger 352 35
cañon 13 45
canonicals *Church* 330 22; 332 4
canopy *Infant Care etc.* 28 32
canopy *Dwellings* 37 67
canopy *Child. Rm.* 47 12
canopy *Kindergart.* 48 26
canopy *Supermkt.* 99 24
canopy *Aircraft* 230 39
canopy *Airsports* 288 38
canopy *Church* 330 21; 331 49
canopy bearer 331 46
canopy jack 257 5
cant chisel 132 11
canteen 119 45
canter 72 42
cant hook 85 7
canting table 133 17
cattle 71 39, 46
canvas 338 21
canvas hull, rubber-covered ~ 283 58
canvas stretcher 338 20
canyon 13 45
canyon river 13 51
cap *Bees* 77 39
cap *Drawing Off.* 151 40
cap *Refuse Coll.* 199 8
cap *Music. Instr.* 326 31
cap *Edib. Fungi* 381 4
cap, astrakhan ~ 35 34
cap, corduroy ~ 35 25
cap, fox ~ 35 31
cap, leather ~ 35 32; 354 26
cap, linen ~ 35 8
cap, mink ~ 35 17, 20
cap, musquash ~ 35 33
cap, peaked ~ 35 17, 29; 264 8; 301 18
cap, sheepskin ~ 353 23
cap, white ~ 268 32

cap, wide-brimmed ~ 355 28
cap, workman's ~ 35 40
caps 319 27
capacitor 211 17
cap and bells 306 39
caparison 329 74
cape 30 65; 105 34; 106 4
cape, short ~ 355 29
cape chisel 140 25
capeline 21 3
Capella 3 27
caper 98 42
capercaillie 88 72
capillary tube stand 23 42
capistrum 322 5
capital *Composing Rm.* 175 11
capital *Art* 334 20-25
capital, Arabian ~ 337 18
capital, bell-shaped ~ 333 16
capital, bud-shaped ~ 333 14
capital, Roman ~ 341 16
capital, small ~ 175 14
capitulum 61 14; 370 73; 378 12
capoc tree 383 20
cap of typing element 249 30
capon 73 21
capper 76 46
capping *Bees* 77 39
capping *Coal* 144 48
Capricorn 3 36; 4 62
capriole 71 5
caprolactam 170 28
caprolactam oil 170 25
caps, ladies' ~ 35 1-21
caps, men's ~ 35 22-40
capstan *Cine Film* 117 34
capstan *Hydr. Eng.* 217 22
capstan *Audiovis.* 243 23
capstan *Warships* 258 23
capstan idler 117 35
capsule 384 58
capsule, poricidal ~ 370 96
capsule, porose ~ 370 96
captain 224 38
caption 185 67; 342 59
car *Car* 191 1-56
car *Garage* 195 34
car *Railw.* 213 18
car, four-axled ~ 208 3
car, large-capacity ~ 213 28
car, open ~ 207 59
car accessory 196 28
carapace 364 29
caravan 278 52; 307 34
caravan, collapsible ~ 278 3
caravan, showman's ~ 206 20
caravan awning 278 57
caravanning 278
caravel 218 27-43; 220 37
caraway roll 97 31
caraway stick 97 31
carbide, cemented ~ 149 46
carbide 86 30
carbolic acid 170 14
carbon, active ~ 270 58
carbon, negative ~ 312 41
carbon, positive ~ 312 40
carbon atom 242 63
carbon crater 312 44

carbon disulfide 169 8
 carbon disulphide 169 8
 carbon disulphide injector 83 33
 carbon rod, negative ~ 312 41
 carbon rod, positive ~ 312 40
 carbon rod holder 312 43
 carbon tissue 182 1, 10
 carbon tissue, printed ~ 182 8
 carbon tissue transfer machine 182 6
 carburetor *see* carburettor
 carburettor 189 4; 192 1-15
 carburettor, cross-draught ~ 190 79
 car carrier, double-deck ~ 213 35
 car carrier, two-tier ~ 213 35
 carcase 118 1-49
 carcass 118 1-49
 carcassing 118 1-49
 car coat 33 63
 card *Cotton Spin.* 163 34, 51
 card *Games* 276 37
 card, patient's ~ 25 5
 card, used ~ 195 14
 cardan coupling 67 6
 cardan joint 67 6, 28
 cardan mount 6 36
 cardan shaft 64 40, 48; 67 16; 211 51; 212 29, 83
 cardan shaft connection 64 63
 cardan transmission 189 47
 cardboard 260 50-52
 card can 163 35
 card catalogue 262 22
 card catalogue drawer 262 23
 car deck 221 79
 cardiac rhythm 25 1
 cardiac sulcus, longitudinal ~ 20 25
 cardigan 31 50; 33 30
 cardinal *Maths.* 344 5
 cardinal *Birds* 363 5
 cardinal bird 363 5
 card index 245 23
 card index box 46 10; 248 27
 carding can 163 35
 carding engine 163 34, 51
 carding machine 163 34
 car door 191 4
 card sliver 163 38
 card stacker 244 13
 car ferry 216 10
 cargo 223 77
 cargo and passenger liner 221 96
 cargo and passenger ship 223 1-71
 cargo barge 216 25
 cargo boom 221 26, 59; 223 36
 cargo gear 221 24-29, 59
 cargo handling, horizontal ~ 226 7
 cargo-handling berth 226 1
 cargo-handling gear 221 24-29, 59
 cargo hatchway 221 11, 63; 226 14
 cargo hold 231 21
 cargo ship 221 23

cargo warehouse 233 10
 'car hire' 233 33
 Carina 3 46
 carload 206 52
 car location number 195 48
 car models 193 1-36
 carnation 60 6
 carnival 306
 carnival float 306 57
 carnival procession 306 57-70
 carnival truck 306 57
 carnivore house 356 10
 carnivores 367 11-22; 368 1-11
 carob 384 41
 carom billiards 277 7
 carousel 308 2
 carp 89 26; 364 4
 carpel 58 36, 59; 59 13; 374 2, 26
 carpenter 120 12
 carpenter's tools 120 60-82
 carpenter's yard 120 1-59
 carpet 44 16
 carpet, fitted ~ 41 18; 43 23
 carpet, oriental ~ 46 36
 carpet, velour ~ 267 35
 carpet beater head 50 79
 carpet beater nozzle 50 71
 carpet brush 50 45
 carpet cleaning 50 53-86
 carpeting 191 43
 carpet sweeper 50 57
 carpet sweeper and shampooer, combined ~ 50 76
 carp hook 89 86
 carp pond 89 6
 carpus *Man* 17 15; 19 76
 carpus *Horse* 72 22
 car radio 191 90
 carriage *Hosp.* 26 36
 carriage *Sawmill* 157 12, 52
 carriage *Knitting* 167 39
 carriage *Tram* 197 5, 6, 7
 carriage, auxiliary ~ 157 11
 carriage, one-horse ~ 186 18, 29
 carriage, open ~ 207 61; 208 9
 carriage, three-horse ~ 186 45
 carriage, two-horse ~ 186 36
 carriage apron 149 16
 carriage handle 167 41
 carriage heating pressure gauge 210 44
 carriage horse 186 28
 carriage motor 157 15
 carriage rail 167 45
 carriages 186 1-54, 1-3, 26-39, 45, 51-54
 carriages, horse-drawn ~ 186
 carriage sprayer 83 38
 carriage step 186 13
 carrier *Bicycle* 187 44
 carrier *Docks* 226 4
 carrier return lever 249 21
 carrion flower 53 15
 carrot 57 17
 carrot, stump-rooted ~ 57 18
 carrycot 28 48
 carry-home pack 93 28

carrying axle 210 35
 carrying bar 148 16
 carrying bogie 197 10
 carrying cart 56 26
 carrying grip 21 22
 carrying handle 241 2
 carrying rope 215 16
 carrying saddle 73 4
 carrying strap 115 9
 carrying wheel 214 7
 cart 86 39
 cart, electric ~ 206 34
 carte engagement 294 47
 cartilage, costal ~ 17 11
 cartilage, thyroid ~ 20 3
 cartoon *Art. Studio* 338 43
 cartoon *Script* 342 53
 cartouche 336 7
 cartridge *Hunt.* 87 19, 54
 cartridge *Cine Film* 117 30
 cartridge *Slaughterho.* 94 5
 cartridge, full-jacketed ~ 87 55
 cartridge, instamatic ~ 114 15
 cartridge, magnetic ~ 241 26
 cartridge, subminiature ~ 114 17
 cartridge chamber 87 15
 cartwheel 297 21
 cartwheel ruff 355 52
 car tyre 191 15; 196 27
 carvel 218 27-43; 220 37
 carvel planking 285 53
 carvel planking, diagonal ~ 285 56
 carver 96 35
 carving knife 45 69; 96 35
 carving set 45 69-70
 car-wash hose 196 23
 car wheel 191 14
 car window, crank-operated ~ 191 22
 caryatid 334 36
 caryopsis 375 43
 cascade 272 9
 case *Meteorol. Instr.* 10 18
 case *Doc.* 22 33
 case *Composing Rm.* 174 3, 8
 case *Bookbind.* 185 40
 case *Lorries etc.* 194 19
 case *Station* 204 6; 205 7
 case *Chem.* 349 26
 case, cardboard ~ 87 50
 case cabinet 174 4
 case head 305 36
 case maker 184 6
 case-making machine 184 6
 case rack 174 4
 case room 174; 175; 176
 cash desk 196 29; 266 69; 275 2
 cash drawer 271 5
 cashier 99 94; 250 2; 266 70; 271 1
 cash readout 196 4
 cash register 47 34; 99 93; 207 86
 cash register, electric ~ 271 2
 cash total 271 8
 casing *Mach. Parts etc.* 143 79
 casing *Oil, Petr.* 145 18

casing *Power Plant* 153 37
 casing *Text. Finish.* 168 16
 casing *Army* 255 10
 casing *Chem.* 350 10
 casing, outer ~ 168 17
 casing, protective ~ *Meteorol. Instr.* 10 39
 casing, protective ~ *Railw.* 202 35
 casing cover 143 80
 casing-in machine 185 27
 casino 274 8; 275 1
 cask 130 5
 casket 331 35
 casque, light ~ 329 61
 Cassegrain cage 5 4
 casserole dish 40 14
 cassette, compact ~ 241 10
 cassette, daylight ~ 177 50
 cassette, 35 mm ~ 114 7
 cassette, single-8 ~ 117 39
 cassette box 241 11, 47
 cassette cabinet 241 11, 47
 cassette compartment 241 6, 34; 243 8; 249 72
 cassette deck 241 52
 cassette exit slot 114 10
 cassette holder 241 11, 47
 cassette recorder 117 73; 261 42
 cassette recorder unit 241 3
 cassette slit 114 10
 cassette tape 241 12
 cassia 380 16
 Cassiopeia 3 33
 cassowary 359 1
 cast 89 64, 78
 cast, long ~ 89 58
 castanets 324 46
 caster 148 8
 castes of bees 77 1, 4, 5
 cast glass 124 6
 casting 148 42
 casting, continuous ~ 148 24-29
 casting mechanism 174 25
 casting net 89 31
 casting off 167 66
 casting team 148 13
 castle *Games* 276 12
 castle, knight's ~ 329 1
 castle gate 329 32
 castle nut 143 77
 castle wall 333 31
 cast line 174 27
 cast of skull 261 15
 castor *Household* 50 81
 castor *Horse* 72 27
 castor *Pest Contr.* 83 61
 Castor and Pollux 3 28
 castor-oil plant 380 14
 casual 101 34
 casualty 21 20
 cat 62 3; 73 17
 catacomb 331 59
 catalogue, main ~ 262 21
 catalogue room 262 18
 catalytic cracking plant 145 70
 catamaran 284 64; 286 21
 cataract 11 45

catch *Mach. Parts etc.* 143 29
 catch *Railw.* 203 57
 catcher 292 54, 64
 catchfly 376 20
 catchment area 12 24
 catchup 45 43
 cat cracker 145 48
 caterpillar 58 64; 82 16, 20, 31, 44, 47; 365 10; 80 3, 8, 14, 17, 29, 44, 48
 caterpillar hauling scraper 200 16
 caterpillar mounting 200 3
 caterpillar tractor 200 3
 catfish 364 12
 cathedral 335 1-13, 22
 catheter 26 31
 catheter, cardiac ~ 25 53
 catheter gauge unit 27 30
 catheter holder 26 30
 catheterization 27 30
 cathetus 346 32
 cathode 178 6
 cathode ray tube 242 40
 catkin 59 39; 371 10, 26
 catkin scale 371 12
 cat ladder 38 4; 122 63
 cat litter 99 38
 cats 368 2-8
 cat's foot 377 3
 cat's tail 378 21
 catsuit 29 19
 catsup 45 43
 cattail 378 21
 cattail flag 378 21
 cattle 62 45; 73 1-2
 cattleship 221 68
 cattle vessel 221 68
 catwalk *Iron & Steel* 147 38
 catwalk *Ship* 221 3
 catwalk *Theatre* 315 29
 cauliflower 57 31; 99 84
 causticizing agitator 172 49
 causticizing stirrer 172 49
 caustic soda 169 3, 4, 5, 10; 170 11
 caustic soda solution 170 10
 cautery 24 43
 cavalier hat 355 55
 cavalry saddle 71 45-49
 cavalry standard 253 13
 cave *Phys. Geog.* 13 76
 cave *Map* 15 85
 cave, dripstone ~ 13 79
 cave, limestone ~ 13 79
 cave art 328 9
 cave formations 13 80-81
 cave painting 328 9
 cavern *Phys. Geog.* 13 76
 cavern *Park* 272 1
 cavetto 336 50
 cavetto vault 336 49
 caviare knife 45 81
 cavity 91 36
 cavity, nasal ~ 17 53
 cavity, tympanic ~ 17 60
 cavity of the uterus 20 80
 cavy 366 12
 C-clef 320 10
 cecum 20 17

cedar tree 372 65
 cedilla 342 33
 ceiba tree 383 20
 ceiling 222 63
 ceiling, concrete ~ 123 28
 ceiling, false ~ 123 61, 68-69
 ceiling beam 120 38
 ceiling construction 123
 ceiling hook 270 15
 ceiling joint 126 48
 ceiling joist 119 5; 120 38; 121 54
 ceiling light 24 20; 75 8
 ceiling paper 128 53
 ceiling paperhanger 128 50
 ceiling plaster 123 59, 72
 ceiling tile 317 29
 celeriac 57 27
 celesta 325 1
 Celestial River 3 12
 Celestial Ship 3 45
 cell 77 26-30, 27
 cell, sealed ~ 77 32, 33
 cella 334 51
 cellarman 79 18
 cellar steps, outside ~ 118 4
 cellar window 37 27; 118 3
 cell nucleus 357 2
 cello 323 16
 cellulose, refined ~ 172 78
 cellulose, unrefined ~ 172 77
 cellulose sheet 169 2, 4, 6
 cellulose xanthate 169 9
 cembalo 322 45
 cement *Man* 19 29
 cement *Bldg. Site* 118 43
 cement factory 160
 cement-grinding mill 160 12
 cementing pump, high-pressure ~ 146 34
 cement-packing plant 160 16
 cement screed 123 14
 cement silo 119 30; 160 15
 cement storage tank 146 15
 cement store 201 22
 cement track racing 290 24-28
 cementum, dental ~ 19 29
 cement works 160
 cemetery 15 106
 censer 332 38
 cent 252 19, 33
 Centaur *Astron.* 3 39
 Centaur *Fabul. Creat.* 327 52
 Centaurus 3 39
 centaur 61 1; 380 10
 centavo 252 23
 center *see* centre
 centerboard *see* centreboard
 centering *see* centring
 centime 252 15, 16
 centimeter *see* centimetre
 centimetre graduation 247 36
 centimo 252 22
 central heating, full ~ 38 38-81
 central heating furnace 38 57
 central heating system, coke-fired ~ 38 38
 central heating system, oil-fired ~ 38 44-60

centre *Turner* 135 8
 centre *Ball Games* 293 76
 centre *Maths* 346 26, 43, 55
 centre, asbestos ~ 350 19
 centre, live ~ 135 11
 centre angle 346 55
 centreboard 284 26
 centreboard, retractable ~ 284 8; 285 41
 centreboard case 284 24
 centre circle 291 2
 centre console 191 38
 centre flag 291 64
 centre girder 222 53
 centre lathe 149 1
 centre line *Drawing Off* 151 30
 centre line *Sailing* 285 5
 centre line *Ball Games* 293 8-9, 54
 centre line *Fencing* 294 4
 centre line judge 293 25
 centre mark 293 11
 centre of curvature 346 23
 centre of symmetry 351 3
 centre plate girder 222 53
 centre punch 134 31; 140 64
 centre-section fuel tank 257 30
 centre strake 222 55
 centrifuge 23 59
 centrifuge, pendulum-type ~ 168 14
 centrifuge lid 168 18
 centring apparatus, universal ~ 111 21
 centring control 243 10
 centring ring 240 23
 centring suction holder 111 22
 centrosphere 11 5
 cep 381 16
 cepe 381 16
 cephalopod 357 37
 Cerberus 327 29
 cereal 68 1
 cereal product 99 62
 cereal products 98 35-39
 cereals 68 1-37
 cerebellum 17 45; 18 23
 cerebrum 17 42; 18 22
 cesta 305 69
 Cetus 3 11
 chaffinch 360 10
 chaffron 329 84
 chafron 329 84
 chain 74 14; 75 15; 99 95; 118 30
 chain *Bicycle* 187 36
 chain *Cyc. Racing* 290 20
 chain armour 329 63
 chain cable 222 77; 223 50; 227 12
 chain compressor 223 51
 chain curtain 139 50
 chain cutter 120 17
 chain delivery 180 43
 chain drive 187 35-42
 chain feeder 74 25
 chain ferry 216 1

chain grinder, continuous ~ 172 53, 66
 chain gripper 180 56
 chain guard 187 37; 188 46
 chain guide 120 15
 chain mail 329 63
 chain mortiser 132 49
 chain mortising machine 132 49
 chain reaction 1 41, 48
 chain saw 120 14
 chain sling *Forging* 139 44
 chain sling *Docks* 226 26
 chain stay 187 20
 chain stitch 102 2
 chain-tensioning device 157 41
 chain transmission 187 35-39
 chain wheel 187 35
 chair 42 34; 271 35
 chair, adjustable ~ 105 17; 106 16
 chair, barber's ~ 106 16
 chair, cane ~ 43 3
 chair, dentist's ~ 24 3
 chair, double ~ 214 18
 chair, folding ~ 28 33
 chair, gaffer's ~ 162 45
 chair, glassmaker's ~ 162 45
 chair, hairdresser's ~ 105 17; 106 16
 chair, single ~ 214 16
 chair, steel ~ 67 2
 chair, tubular steel ~ 41 21
 chair, two-seater ~ 214 17, 18
 chair, umpire's ~ 293 20
 chair, visitor's ~ 246 21
 chair grip 21 21
 chair lift 214 16-18
 chair lift, double ~ 301 57
 chairman 263 1
 chairman of board of directors 251 16
 chairman of board of governors 251 15
 chairoplane 308 4
 chaise 186 34
 chaise, closed ~ 186 54
 chaise, covered ~ 186 54
 chaise, one-horse ~ 186 29
 chaitya 337 28
 chaitya hall 337 27
 chalaza 74 63
 chalcography 340 14-24
 chalet 278 7
 chalice 330 10; 332 49
 chalk 48 15; 260 32; 338 5
 chalk, French ~ 104 24
 chalk, tailor's ~ 104 24
 chalk ledge 260 31
 chalk sketch 338 4
 chalwar 306 42
 Chamaeleontidae 364 33
 chamber *Atom* 1 66
 chamber *Forest Pests* 82 36
 chamber *Hunt* 87 20
 chamber *Water* 269 24
 chamber, king's ~ 333 2
 chamber, photographic ~ 113 40
 chamber, queen's ~ 333 3

chamber, stone ~ 328 39
 chamber wall 269 25
 chameleon 364 33
 chamfer 143 62
 chamfering hammer 125 14
 chamfrain 329 84
 chamfron 329 84
 chamois 367 3
 chamomile 61 8; 380 1
 chamotte slab 141 16
 champagne 99 78
 champagne bucket 267 59
 champagne cooler 267 59
 champagne cork 267 58
 champagne glass 45 86
 champagne glasses 45 85-86
 chancel 330 1, 32; 335 4
 chandelier 267 21
 chanfron 329 84
 'change' *Airport* 233 51
 change *Winter Sp.* 302 12
 change-gear box 149 7
 change-gear handle 132 56
 change gears 10 14
 change-loop 302 16
 change machine 197 33; 204 22; 236 28
 changemaker 236 28
 changeover switch 50 59; 243 15
 change points, electric ~ 197 37
 change rack 236 23
 change-speed gear 163 29; 211 50
 change wheel 164 40
 changing booth 271 32
 changing cubicle 282 1
 changing room 282 3
 changing top 28 4
 changing unit 28 11
 channel *Overh. Irrign.* 67 13
 channel *Railw.* 202 32
 channel *Swim.* 281 9
 channel *Rowing* 283 60
 channel *Art* 334 27
 channel, distributary ~ 13 2
 channel, navigable ~ 224 92, 93
 channel iron 143 7
 channel markings 224 84-102
 channel marks 224 68-83
 chantarelle 381 14
 chanter 322 10
 chanterelle 381 14
 chapel *Map* 15 61, 107
 'chapel' *Airport* 233 49
 chapel *Chivalry* 329 29
 chaplet 34 32
 chaplet hairstyle 34 31
 chaps 70 26
 chapter heading 185 60
 char-a-banc, covered ~ 186 33
 character 174 7, 44; 175 38
 characteristic 345 6
 characteristic light 221 48; 224 105
 character storage 242 37
 charcoal 278 48
 charcoal, activated ~ 270 58

charcoal grill 278 47
 charcoal pencil 338 16
 chard 57 28
 charge postmark 236 58
 charger 25 51
 charging car 144 8; 156 6
 charging chamber 154 79
 charging conveyor 144 42
 charging door 38 61; 139 4
 charging machine 147 25
 charging opening 139 49
 charging platform 147 4
 charging position 147 55, 56
 Charioteer 3 27
 charity performance 319 31
 Charles's Wain 3 29
 Charleston cymbals 324 50
 charcoal 61 18
 charm 36 35
 chart 22 32; 76 8; 260 30
 chart, illustrated ~ 22 16
 chase 181 38
 chasing 87 28
 chasing hammer 108 41
 chassis *Overh. Irrign.* 67 14
 chassis *Blacksm.* 138 28
 chassis *Car* 191 2
 check *Roulette* 275 12
 check *Theatre* 315 7
 check *Music. Instr.* 325 27
 check brake 143 97
 checker 276 18, 19
 checkerboard 276 17
 checkerboard 276 18, 19
 checkers 276 17-19
 check felt 325 28
 check light 195 21, 22
 checkmate 276 15
 checkout 99 92
 check rail 202 23
 checkroom 315 5; 318 1
 checkroom attendant 315 6; 318 2
 checkroom hall 315 5-11
 check side 277 6
 cheek *Man* 16 9
 cheek *Hunt* 87 4
 cheekbone 16 8; 17 37
 cheek piece 71 8
 cheek rest 255 30
 cheek strap 71 8
 cheese 98 5; 99 49; 266 52
 cheese, cross-wound ~ 164 58
 cheese, round ~ 99 42
 cheese, whole ~ 99 40
 cheeseboard 45 35
 cheesecake 97 23
 cheese counter 99 39
 cheese dish 40 7
 cheese fly 81 15
 cheese knife 45 72
 cheese machine 76 47
 cheetah 368 7
 chef 207 34
 chelicer 358 41
 cheliped 358 41
 chemical bottle 116 10; 261 23
 'chemist' 233 45
 chemistry 261 1-13
 chemistry laboratory 261 1; 349; 350

chemistry teacher 261 2
 chequer-board cut 36 66
 cheroot 107 4
 cherry *Drupes & Nuts* 59 5, 6-8
 cherry *Goldsm. etc.* 108 7
 cherry *Bot.* 370 99
 cherry blossom 59 3
 cherry flan 97 22
 cherry flower 59 3
 cherry fruit 59 6-8
 cherry fruit fly 80 18
 cherry leaf 59 2
 cherry stone 59 7
 cherry tree 59 1, 11-18
 cherub 272 20
 chess 265 17; 276 1-16
 chessboard 47 20; 276 1
 chessboard square 276 2
 chess championship 276 16
 chess clock 276 16
 chessman 276 1, 4, 5, 7
 chess match 276 16
 chess move 276 6
 chess player 265 17
 chess problem 276 6
 chess square 276 6
 chest *Man* 16 28-30; 17 8-11
 chest *Paperm.* 172 25
 chest grip 21 37
 chestnut *Horse* 72 27
 chestnut *Decid. Trees* 371 60
 chestnut *South. Fruits* 384 52
 Chestnut Boletus 381 15
 chestnut tree 371 58
 chest of drawers 41 8
 chevron design 335 16
 chew 107 19
 chewing tobacco 107 19
 Chianti 98 61; 99 77
 chibonk 107 32
 chibonque 107 32
 chick 74 2
 chicken 62 36; 73 19-26; 96 24
 chicken run 74 11
 chick-pea 69 19
 chick unit 74 1
 chicory 57 40
 chief 254 18-19
 chignon 34 29
 child 260 3
 child, small ~ 28 42
 child carrier seat 187 21
 children's room 47
 chilling roll 180 28
 chill roller 180 28
 chimera 327 16
 chimney *Map* 15 38
 chimney *Dwellings* 37 10
 chimney *Roof & Boilerr.* 38 5
 chimney *Bldg. Site* 118 21
 chimney *Carp.* 120 47
 chimney *Roof* 122 13
 chimney *Blacksm.* 137 7
 chimney *Power Plant* 152 15
 chimney *Energy Sources* 155 12
 chimney *Railw.* 210 22
 chimney *Mountain.* 300 8
 chimney bond 118 66

chimney brick 159 28
 chimney flashing 122 14
 chimney swallow 361 20
 chimney sweep 38 31
 chimney sweeper 38 31
 chimpanzee 368 14
 chin 16 15
 china, broken ~ 260 61
 china cabinet 44 26
 china manufacture 161
 china painter 161 17
 China rose 60 15
 chinband 355 22
 chinch 81 39
 chinchona 380 17
 Chinese lantern 52 15
 chine strake 258 8
 chin rest 323 8
 chintuft 34 10
 chip *Basketm.* 136 12
 chip *Roulette* 275 12
 chip basket 136 11
 chip container 170 40
 chip crusher 172 5
 chip distributor 172 3
 chip extractor 157 51
 chip-extractor opening 132 48
 chip packer 172 3
 chip pan 40 41
 chipper 172 1
 chipping hammer *Blacksm.* 137 38
 chipping hammer *Gas Weld.* 141 25
 chipping hammer *Arc Weld.* 142 17
 chip remover 157 50
 chiropter 366 9
 chiropteran 366 9
 chisel 120 71
 chisel, bevelled-edge ~ 132 7; 339 19
 chisel, blacksmith's ~ 137 38
 chisel, broad ~ 158 37
 chisel, flat ~ 140 26; 339 14
 chisel, hollow ~ 339 17
 chisel, pneumatic ~ 148 45
 chisel, toothed ~ 339 13
 chisels 132 7-11
 chitarrone 324 1
 chiton 355 5
 Chitonactis 369 20
 chivalry 329
 hive 57 22
 chlorine 170 7
 chlorine ion 1 10
 chlorobenzene 170 9, 11
 chock *Bldg. Site* 119 40
 chock *Iron Foundry etc.* 148 61
 chocolate 98 80
 chocolate, bar of ~ 98 78
 chocolate box 98 79
 chocolate liqueur 98 83
 choir 330 32; 335 4
 choke cymbals 324 50
 choke flap 192 6
 choker 36 16
 choker collar 355 74
 cholecystography 27 4

Chopper 188 56

chopper drum 64 34
chopping board 96 57
chord *Aircraft* 230 56
chord *Music. Not.* 321 1-5, 5
chord *Maths.* 346 51
chord, lower ~ 121 73, 79
chord, upper ~ 121 74, 80
chorus 315 21
chow 70 21
christening 332 1
christening dress 332 8
christening robe 332 8
christening shawl 332 9
chromatic scale 320 49
chromolithograph 340 28
chronometer 230 11
chrysalis 77 30, 32; 80 4, 25,
43; 81 3, 21, 24; 82 13, 21,
32; 358 20; 365 11
chrysanthemum 51 29; 61 7
chuck *Meat* 95 19
chuck *D.I.Y.* 134 48
chuck *Turner* 135 6
chuck, four-jaw ~ 149 35
chuck, independent ~ 149 35
chuck, quick-action ~ 132 54
chuck, self-centring ~ 149 37
chuck, three-jaw ~ 149 37
chuck, two-jaw ~ 135 10
church 15 53, 61, 107; 330;
331 1; 332
church, Baroque ~ 336 1
church, Gothic ~ 335 22
church, Protestant ~ 330 1-30
church, Renaissance ~ 335 42
church, Roman Catholic ~
330 31-62
church, Romanesque ~ 335
1-13
church banner 331 44
church clock 331 7
church door *Church* 331 16
church door *Art* 335 24
churchgoer 330 29; 331 17
church landmark 15 64
church organ 326 1-52
church owl 362 17
church roof 331 11
church spire 331 6
church wedding 332 14
church window 330 14
churtyard 331 21-41
churtyard gate 331 19
churtyard wall 331 18
chute *Docks* 226 45
chute *Fair* 308 40
chute, spiral ~ 144 28
chute, three-way ~ 92 34
ciborium 332 48
cigar, Brazilian ~ 107 2
cigar and cigarette boy 267 49
cigar box 107 1
cigar case 107 8
cigar cutter 107 9
cigarette, filter-tipped ~ 107
12
cigarette, Russian ~ 107 14
cigarette beetle 81 25
cigarette case 107 10
cigarette holder 107 16

cigarette lighter 107 27, 30
cigarette machine 268 69
cigarette packet 107 11
cigarette paper 107 17
cigarette roller 107 15
cigarettes and tobacco kiosk
204 47
cigarette seller 308 51
cigarette tip 107 13
cigarette tray 267 50
cigarillo 107 3
cigar lighter 191 88
ciliate 370 49
cilium *Man* 19 41
cilium *Invertebr.* 357 10
cilium *Bot.* 370 50
cinchona 380 17
cincinnus 77 30, 32; 80 4, 25,
43; 81 3, 21, 24; 82 13, 21,
32; 358 20; 365 11
chrysanthemum 51 29; 61 7
chuck *Meat* 95 19
chuck *D.I.Y.* 134 48
chuck *Turner* 135 6
chuck, four-jaw ~ 149 35
chuck, independent ~ 149 35
chuck, quick-action ~ 132 54
chuck, self-centring ~ 149 37
chuck, three-jaw ~ 149 37
chuck, two-jaw ~ 135 10
church 15 53, 61, 107; 330;
331 1; 332
church, Baroque ~ 336 1
church, Gothic ~ 335 22
church, Protestant ~ 330 1-30
church, Renaissance ~ 335 42
church, Roman Catholic ~
330 31-62
church, Romanesque ~ 335
1-13
church banner 331 44
church clock 331 7
church door *Church* 331 16
church door *Art* 335 24
churchgoer 330 29; 331 17
church landmark 15 64
church organ 326 1-52
church owl 362 17
church roof 331 11
church spire 331 6
church wedding 332 14
church window 330 14
churtyard 331 21-41
churtyard gate 331 19
churtyard wall 331 18
chute *Docks* 226 45
chute *Fair* 308 40
chute, spiral ~ 144 28
chute, three-way ~ 92 34
ciborium 332 48
cigar, Brazilian ~ 107 2
cigar and cigarette boy 267 49
cigar box 107 1
cigar case 107 8
cigar cutter 107 9
cigarette, filter-tipped ~ 107
12
cigarette, Russian ~ 107 14
cigarette beetle 81 25
cigarette case 107 10
cigarette holder 107 16

circular saw blade 132 59
circulation, atmospheric ~ 9
46-52
circulation pump 154 43, 54
circulatory system 18 1-21
circumcircle 346 29
circumference *Cooper* 130 23
circumference *Maths.* 346 44
circumference, staved ~ 130 2
circumflex 342 32
circus 307
circus, travelling ~ 307 1-63
circus act 307 25
circus attendant 307 27
circus band 307 10
circus box 307 16
circus caravan 206 20; 307 34
circus horse 307 30
circus manager 307 17
circus marksman 307 38
circus rider 307 26
circus tent 307 1
circus trailer 307 34
cirrocumulus 8 14
cirrostratus 8 7
cirrus 8 6
cist, long ~ 328 16
cist, stone ~ 328 17
cistern 49 16
cithara 322 15
cittern 322 21
city 15 51
city banner 218 22
city wall 333 30
Claisen flask 350 50
clamp *Atom* 2 43
clamp *Overh. Irrign.* 67 30
clamp *Goldsm. etc.* 108 34
clamp *Joiner* 132 51; 133 9
clamp *Bookbind.* 183 18; 185
3
clamp *Chem.* 350 33
clamp, horizontal ~ 14 57
clamp, vertical ~ 14 55
clamp handle 133 8
clamping device *Atom* 2 43
clamping device *Mach. Tools*
150 15
clamping plate, hinged ~ 117
90
clamping screw 133 23
clamping shoe 133 10
clamp lever 132 67
clamp tip 149 46
clamp tip tool 149 45
clapper *Carnival* 306 47
clapper *Films* 310 35
clapper board 310 35
clapper boy 310 34
clappers 162 42
clarinet 318 4; 323 34
clarinetist 318 5
clasp, white gold ~ 36 10
clasp nut 149 19
classes, social ~ of bees 77
1, 4, 5
classification siding 206 47
classification track 206 47
classification yard 206 42
classification yard switch
tower 206 44

classifier 172 50
classroom 260 1-45
classroom cupboard 260 43
clavicembalo 322 45
clavichord 322 36
clavichord mechanism 322 37
clavicle 17 6
clavilux 317 13
claw 327 3; 362 7
claw, bird's ~ 327 61
claw, double ~ 77 8
claw chisel 339 13
claw head 120 75
claws, griffin's ~ 327 13
clay 160 1; 260 79; 339 8, 31
clay, impure ~ 159 2
clay, raw ~ 159 2
clay box 339 30
clay column *Brickwks.* 159 14
clay column *Porcelain.*
Manuf. 161 8
clay pigeon shooting 305
70-78
clay pit *Map* 15 88
clay pit *Brickwks.* 159 1
cleaner, centrifugal ~ 173 11
cleaner, ultrasonic ~ 109 23
cleaning brush *Hunt.* 87 62
cleaning brush *Office* 247 10
cleaning fluid 111 32
cleaning machine *Brew.* 92 36
cleaning machine *Watchm.*
109 30
cleaning plant 144 20
cleaning rag 50 55
cleaning rod 87 61
cleaning shop 148 38-45
cleaning tank 178 1
cleaning tow 87 63
cleanout door 38 39
cleansing pond 89 6
clear-felling system 84 4-14
clearing *Map* 15 2
clearing *Forestry* 84 13
clearstory 334 70
clear *Carp.* 120 45
cleat *Floor etc. Constr.* 123 67
cleaver, butcher's ~ 94 18
cleaving hammer 85 5
clefs 320 8-11
cleft, anal ~ 16 41
clench planking 285 50-52
clerestory 334 70
clergyman 330 22; 331 37;
332 22
clergyman, Protestant ~ 332 3
clerk 263 26, 27
clew 284 41
click 110 34
click beetle 80 37, 38
click wheel 110 35
cliff 13 28
cliff face 13 28
cliffline 13 25-31
cliffs 13 25-31
climate, artificially
maintained ~ 356 21
climate, boreal ~ 9 56
climate, equatorial ~ 9 53
climates 9 53-58

climates, polar ~ 9 57-58
climatic map 9 40-58
climatology 9
climber *Flower Gdn.* 51 5
climber *Fruit & Veg. Gdn.* 52
5
climber *Indoor Plants* 53 2
climber *Veg.* 57 8
climber *Mountain.* 300 5
climbing 300 2-13
climbing boot 300 44
climbing breeches 300 7
climbing equipment 300
31-57
climbing frame 273 47
climbing harness 300 56
climbing net 273 50
climbing plant 53 2
climbing roof 273 60
climbing rope 273 48; 296 19
climbing tower 273 17
clinch 299 31
clinker cooler 160 9
clinker pit 152 8
clinker planking 285 50-52
clinker store 160 10
clinopinacoid 351 24
clip *Atom* 2 18
clip *Bicycle* 187 62
clip *Railw.* 202 9
clipper display 238 44
clippers, electric ~ 105 21; 106
32
clipper ship, English ~ 220 36
clitellum 357 26
clitoris 20 88
Clivia minata 53 8
cloak 355 18, 26
cloak, red ~ 319 27
cloak, short ~ 355 29
cloak, Spanish ~ 355 29
cloak, woollen ~ 355 6
cloak cord 355 24
cloakroom 48 34; 207 70; 315
5; 318 1
cloakroom attendant 315 6;
318 2
cloakroom hall 315 5-11
cloakroom ticket 315 7
cloche 35 12
clock 191 38; 211 37; 212 16
clock, double ~ 276 16
clock, electric ~ 191 79
clock, main ~ 245 18
clock case 110 26; 309 57
clockmaker 109 1
clocks 110
clockwork 110 36
clockwork drive 10 14
clockwork mechanism 110 36
clod 63 7
clog 101 44; 355 43
cloister 331 52
cloister vault 336 41
closed vertical gate 301 66
close-up bellows attachment
115 85
close-up equipment 115
81-98
close-up lens 117 55
closing gear 90 27

closing head 143 59
closure rail 202 26
cloth 166 12; 271 59
cloth, damask ~ 45 2
cloth, felt ~ 340 42
cloth, flannel ~ 128 48
cloth, linen ~ 206 11
cloth, sterile ~ 26 38
cloth, unraised ~ 168 33
clothes, children's ~ 29
clothes, teenagers' ~ 29 48-68
clothes brush 50 44; 104 31
clothes closet 43 1
clothes closet door 46 2
clothes compartment 212 63;
267 30
clothes line 38 23; 50 33
clothes louse 81 41
clothes moth 81 13
clothes rack 271 31
clothes rack, movable ~ 103
17
clothes shop 268 9
clothing, protective ~ 84 26;
270 46
cloth roller 166 20
cloth-shearing machine,
rotary ~ 168 42
cloth take-up motion 166 19
cloth take-up roller 166 47
cloth temple 166 13
cloud, lenticular ~ 287 19
cloud chamber photograph 2
26
cloud chamber track 2 27
cloud cover 9 20-24
clouds 8 1-19, 1-4, 5-12,
13-17
clouds, luminous ~ 7 22
clouds, noctilucent ~ 7 22
clout 121 94
clout nail 121 94; 122 96
clove 382 28
clove carnation 60 7
clove pink 60 7
clover, four-leaf ~ 69 5
clover broadcaster 66 26
clove tree 382 26
clown 306 69; 307 24
clown, musical ~ 307 23
clown act 307 25
club 283 23
club hammer 126 77
clubhouse 283 23
club membership 286 8
club rush 378 21
clubs 276 38
clump of grass 375 44
cluster of eggs 80 2, 30
cluster of grapes 78 5
cluster of stars 3 26
clutch 191 44
clutch, dry ~ 190 78
clutch, fluid ~ 65 37
clutch, main ~ 65 39
clutch, multi-plate ~ 190 78
clutch, single-plate ~ 190 71
clutch coupling 227 23
clutch flange 177 55
clutch lever 188 32
clutch pedal 191 44, 96; 192 28

C major 320 55, 62
 C major scale 320 45
 C minor 320 59, 65
 coach *Lorries etc.* 194 17
 coach *Ball Games* 291 55; 292 57
 coach, four-axled ~ 208 3
 coach, second ~ 209 7
 coach body 186 5; 207 2; 208 6
 coach bolt 202 7
 coach box 186 8
 coach door 186 11
 coaches 186
 1-3, 26-39, 45, 51-54
 coach horse 186 28
 coachman 186 32
 coach screw 202 7
 coach step 186 13
 coach wagons 186
 1-3, 26-39, 45, 51-54
 coagulating bath 169 15
 coal 170 1
 coal bunker 152 2; 225 19
 coal conveyor 152 1
 coal distillation, dry ~ 170 2
 coal feed conveyor 199 37
 coal mill 152 4
 coal mine 144 1-51
 coal scuttle 309 9
 coal seam 144 50
 coal shovel 38 43
 coal tar 170 3
 coal tar extraction 156 18
 coal tower 156 5
 coal tower conveyor 156 4
 coal wharf 225 18
 coaming 283 59
 coarse dirt hose 50 84
 coarse fishing 89 20-31
 coastal cruiser 284 60
 coastal lake 13 44
 coaster 221 99
 coaster brake 187 63
 coasting vessel 221 99
 coat 29 54; 30 60
 coat, black ~ 289 4
 coat, braided ~ 186 23
 coat, cloth ~ 30 61; 33 66
 coat, dark ~ 289 4, 13
 coat, fur ~ 30 60
 coat, gallooned ~ 186 23
 coat, loden ~ 29 31; 30 64
 coat, loose-fitting ~ 271 41
 coat, mink ~ 131 24
 coat, ocelot ~ 131 25
 coat, oilskin ~ 228 7
 coat, poncho-style ~ 30 68
 coat, poplin ~ 33 60
 coat, red ~ 289 13
 coat, three-quarter length ~ 271 21
 coat belt 33 59
 coat button 33 64
 coat collar 33 58
 coater 173 31, 34
 coat hanger 41 3
 coat hook 41 2; 207 50; 266 14
 coating, bituminous ~ 200 58

coating of fluorescent material 240 19
 coat-of-arms 254 1-6
 coat-of-arms, marshalled ~ 254 10-13
 coat-of-arms, provincial ~ 252 12, 14
 coat pocket 33 61
 coat rack 41 1
 coat stand 266 12
 coat-tail 33 14
 cob 59 49
 cobalt bomb 2 28
 cobnut 59 49
 coccinellid 358 37
 coccyx 17 5; 20 60
 cochlea 17 63
 cock *Farm Bldgs.* 62 37
 cock *Dom. Anim.* 73 21
 cockade 264 8
 cockatrice 327 34
 cockchafer 82 1
 cockchafer grub 82 12
 cocker spaniel 70 38
 cocking handle 255 12
 cocking lever 255 12
 cocking piece 121 30
 cock pheasant 88 77
 cock pigeon 73 33
 cockpit *Aircraft* 230 1-31, 35; 231 19
 cockpit *Police* 264 2
 cockpit *Rowing* 283 8
 cockpit *Sailing* 285 38
 cockpit *Airsports* 288 10
 cockpit canopy 230 39; 257 4
 cockpit coaming 283 59
 cockpit hood 230 39; 257 4
 cockroach 81 17
 cocksecomb 73 22
 cock's foot 69 25
 cock's head 69 10
 cock's tread 74 65
 cocktail 317 33
 cocktail fork 45 76
 cocktail glass 267 56
 cocktail shaker 267 61
 cocoa *Grocer* 98 66
 cocoa *Trop. Plants* 382 19
 cocoa bean 382 19
 cocoa palm 383 48
 cocoa powder 382 19
 coconut 383 53
 coconut oil 98 23
 coconut palm 383 48
 coconut tree 383 48
 cocoon *Forest Pests* 82 21
 cocoon *Articulates* 358 51
 coco palm 383 48
 cocotte 306 37
 cod 90 22
 code flag halyard 223 10
 code flag signal 223 9
 cod end 90 22
 code pendant 253 29
 code pennant 253 29
 coding keyboard 242 11
 coding station 236 35
 cod line 90 23
 codling moth 58 62
 codlin moth 58 62

coefficient 345 4
 coelenterate 357 14; 369 5, 9, 14, 20
 coffee 98 65-68, 67; 99 68-70, 68; 265 19
 coffee *Trop. Plants* 382 6
 coffee, instant ~ 99 70
 coffee, pure ~ 98 65
 coffee bean 382 6
 coffee cup 44 29
 coffee grinder, electric ~ 39 24; 98 69
 coffee maker 39 38
 coffee plant 382 1
 coffee pot 44 28
 coffee roaster 98 70
 coffee service 44 27
 coffee set 44 27; 265 18
 coffee table 42 28
 coffee tree 382 1
 coffee urn 265 2
 cofferdam 259 19
 coffin 331 35
 coffin chamber 333 5
 cog *Mach. Parts etc.* 143 83
 cog *Ship* 218 18-26
 cog, wooden ~ 91 9
 cognac 98 59
 cog railroad 214 4-5
 cog railway 214 4-5
 cog wheels 143 82-96
 coiffure, upswept ~ 355 81
 coiffures 34 27-38
 coil 89 21
 coiled-coil filament 127 58
 coiler 148 72
 coiler top 163 62
 coil spring 191 28; 192 68
 coin 252 1-28
 coin, Celtic ~ 328 37
 coin, gold ~ 36 37
 coin, silver ~ 328 37
 coinage 252 1-28, 40-44
 coin-box telephone 236 9; 237 3
 coin bracelet 36 36
 coin disc 252 43
 coining dies 252 40-41
 coining press 252 44
 coins 252 1-28
 coins, aluminium ~ 252 1-28
 coins, copper ~ 252 1-28
 coins, gold ~ 252 1-28
 coins, nickel ~ 252 1-28
 coins, silver ~ 252 1-28
 coin setting 36 38
 coke 147 2
 coke guide 156 9
 coke loading 156 15
 coke loading bay 156 12
 coke oven 144 7; 156 8, 16
 coke-oven gas processing 156 16-45
 coke-quenching car 144 11
 coke-quenching tower 144 10
 cokernut 383 53
 coke side bench 156 13
 coke wharf 156 12
 coking coal 156 1
 coking coal tower 144 9
 coking plant *Coal* 144 7-11

coking plant *Coking* 156 1-15
 coking plant *Synth. Fibres* 170 2
 col 12 47
 cold-drawing 170 46
 cold house 55 33
 cold light source 23 8
 cold room 94 21-24
 cold shelf 96 12; 98 3
 cold storage room 223 56
 cold store 94 21-24; 225 50
 cold tap 126 29
 cold water tank 92 9
 cole 383 1
 Coleoptera 358 24-39
 coleseed 383 1
 collar *Jewell.* 36 16
 collar *Dog* 70 13
 collar *Game* 88 27
 collar *Roof* 121 35, 70
 collar *Money* 252 42
 collar *Church* 332 6
 collar *Fish etc.* 364 39
 collar, braided ~ 186 22
 collar, cowl ~ 30 3
 collar, Dutch ~ 71 28
 collar, fur ~ 30 63
 collar, fur-trimmed ~ 30 63
 collar, gallooned ~ 186 22
 collar, ground glass ~ 115 53, 64
 collar, high ~ 355 74
 collar, integral ~ 143 33
 collar, knived ~ 33 31
 collar, matt ~ 115 53, 64
 collar, padded ~ 101 20
 collar, pointed ~ 71 15
 collar, stand-up ~ 30 43
 collar, turndown ~ 30 5; 31 69
 collar, wide-falling ~ 355 56
 collar beam 121 35, 38, 70
 collar beam roof 121 34
 collar beam roof structure 121 37
 collar bearing 148 73
 collarbone 17 6
 collating machine 249 59
 collating station 249 60
 collecting bin 201 20
 collecting hopper 92 20
 collecting tank 172 26
 collecting vessel 10 40, 45
 collection 74 36
 collection bag 236 51
 collector 155 19
 collector bow 205 36
 collector well 269 4
 college 262 1-25
 colliery 144 1-51
 collimator 111 46; 351 30
 colon 342 17
 colon, ascending ~ 20 19
 colon, descending ~ 20 21
 colon, transverse ~ 20 20
 colonnade 274 9; 334 67
 colophony 323 11
 color see colour
 Colorado beetle 80 52
 colour 343
 colour analyser 116 36
 colour analyser lamp 116 37

colour chemicals 116 52
 colour computer 177 51
 colour conversion filter step 117 38
 colour correction, selective ~ 177 51
 colour correction unit 177 39
 colour decoder module 240 5
 colour developer 116 10
 colour enlarger 116 40
 colour filter 316 49
 colour indicator 127 37
 colour light distant signal 203 9, 14
 colour light signal 203 3
 colour medium 316 49
 colour-mixing knob 116 43-45
 colour organ 317 13
 colour output stage module 240 13
 colour pickup tube 240 36
 colour picture tube 240 15
 colour print 340 28
 colour printing paper 116 51
 colour processing chemicals 116 52
 colours of the rainbow 343 14
 colour television receiver 240 1
 colour television set 240 1
 colposcope 23 5
 coltsfoot 380 8
 colubrid 364 38
 Columbian 175 30
 columbine *Gdn. Flowers* 60 10
 Columbine *Carnival* 306 27
 column *Photog.* 116 42
 column *Forging* 139 10
 column *Mach. Tools* 150 10
 column *Bookbind.* 185 65
 column *Script* 342 45
 column *Chem.* 349 29
 column, angled ~ 116 28
 column, bent ~ 113 21
 column, central ~ 114 46
 column, Corinthian ~ 334 10
 column, Doric ~ 334 8
 column, Ionic ~ 334 9
 column, ornamented ~ 333 18
 column, spinal ~ 17 2-5
 column, vertebral ~ 17 2-5
 column box 119 11, 73
 column heading 342 46
 column rule 342 47
 column shaft 334 26
 coma position 21 24
 comb *Infant Care etc.* 28 8
 comb *Dom. Anim.* 73 22
 comb *Hairdresser* 105 6
 comb, adjustable ~ 165 26
 comb, top ~ 163 67
 combat sports 299
 comber 163 56, 63
 comber draw box 163 60
 comb foundation 77 43
 combination, two-piece ~ 30 45
 combination cutting pliers 126 60; 127 53

combination lever 210 30
 combination rib weave 171 25
 combination toolholder 149 41
 combine 64 1-33
 combined grasp 296 42
 combine harvester 63 31; 64 1-33
 combing cylinder 163 68
 combing machine 163 56
 comb setting 165 36
 combustion chamber 232 37
 combustion chamber, external ~ 147 16
 comfrey 375 45
 comic turn 307 25
 comma 342 18
 command key 247 21
 command module 6 9
 command section 234 65
 commencement of speed restriction 203 39, 42
 commissionaire 267 1; 271 44; 315 10
 commissure, labial ~ 16 14; 19 19
 committee 263 1-2
 committee boat 285 15
 committee member 263 2
 committee table 263 3
 common box 373 19
 common buzzard 362 9
 common comfrey 69 13
 common denominator 344 19
 common dolphin 367 24
 common European kite 362 11
 common flea 81 42
 common groundsel 61 12
 common heron 359 18
 common housefly 81 2
 common iguana 364 32
 common mallow 376 13
 common merganser 359 15
 common myrtle 53 11
 common nightshade 379 5
 common orache 61 24
 common pheasant 88 77
 common privet 373 6
 common puffball 381 20
 common roller 360 6
 common salt 170 13
 common seal 367 19
 common sea-swallow 359 11
 common silver fir 372 1
 common swallow 361 20
 common time 320 32
 common toadflax 376 26
 common vetch 69 18
 common viper 364 40
 communicant 332 27
 communication line 127 23
 communication link 237 50
 communications satellite 237 52
 communion cup 330 10; 332 29
 communion table 330 4
 communion wafer 332 50
 commutator cover 211 18
 companion hatch 258 24

companion ladder 221 123;
223 24; 258 24
companionway 221 123; 222
23; 223 24; 258 24
company account 250 4
company messenger 236 17
compartment *Forestry* 84 2
compartment *Railw.* 207 13;
208 24
compartment *Store* 271 6
compartment, secretarial ~
205 37; 209 25
compartment, special ~ 205
26
compartment, twin-berth ~
207 38
compartment, two-berth ~
207 38
compartment, two-seat ~ 207
38
compartment batten 316 13
compartment door 207 14
compartment window 207 52;
208 8
compass *Drawing Off.* 151 52
compass *Airsports* 288 12
compass, divisions of ~ 321
42-50
compass, fluid ~ 224 46
compass, gyroscopic ~ 224 31,
51-53
compass, liquid ~ 224 46
compass, magnetic ~ 223 6;
224 46; 230 6
compass, mariner's ~ 223 6
compass, ratchet-type ~ 151
64
compass, spirit ~ 224 46
compass, wet ~ 224 46
compass bowl 224 49
compass brick 159 25
compass bridge 223 4-11; 227
24
compass card 224 47
compasses 224 46-53
compass flat 223 4-11; 227 24
compass head 151 53
compass plane 132 28
compass platform 223 4-11;
227 24
compass repeater 224 31, 52,
53
compass saw 120 63; 126 70;
132 3
compendium of games 47 18
compensating airstream 192 4
compensating roller 181 45
compensation pendulum 109
33
compensator 181 45
compensator level 112 69
competition bow 305 54
competitor 282 28
complementary angle 346 15
complement of set 348 7, 8
composing frame 174 2
composing room 174; 175;
176
composing rule 174 14
composing stick 174 13
composition 175 1-17

composition, computer-
controlled ~ 176 14
compositor 174 5
compost heap 52 6
comprehensive school 261
1-45
compress 27 4
compressed-air bottle 279 21
compressed-air braking
system 208 21
compressed-air cylinder 279
21
compressed-air hose 174 38
compressed-air inlet 153 53
compressed-air line *Joiner*
133 45
compressed-air line *Blacksm.*
138 5
compressed-air pipe *Forging*
139 22
compressed-air pipe
Metalwkr. 140 17
compressed-air pressure
gauge 279 13
compressed-air reservoir
Agr. Mach. 64 92
compressed-air reservoir
Offshore Drill. 146 21
compressed-air supply 213 20
compressed-air system 138 1
compressed-air tank
Blacksm. 138 4
compressed-air tank *Power*
Plant 153 51
compressed-air vessel 269 17,
50
compressed-gas container
234 32
compressed-helium bottle
234 14
compressed-helium tank 234
43, 50
compression bandage 21 17
compression plate 2 25
compressor *Painter* 129 33
compressor *Blacksm.* 138 3
compressor *Oil, Petr.* 145 45
compressor *Energy Sources*
155 4
compressor *Ship* 223 51
compressor *Office* 247 43
compressor, high-pressure ~
232 36
compressor, low-pressure ~
232 35
computer 23 53; 177 70; 195 1
computer cable 195 3, 38
computer centre 244
computer data 238 13
computer harness 195 3, 38
computer plug, main ~ 195 2
computer socket, main ~ 195
39
computer test, automatic ~
195 33
computing scale 98 12
concave 64 11
concave ridge 302 22
concentrator 172 24, 42, 44,
48, 62
concert grand 325 40

concertina 324 36
conch shell trumpet 327 41
concrete, heavy ~ 119 72
concrete, rammed ~ 118 1
concrete, tamped ~ 118 1
concrete aggregate 118 36;
119 26
concrete bucket 119 38
concrete mixer 47 40; 118 33;
119 29; 201 23
concrete-mixing plant 201 19
concrete pump hopper 201 24
concrete reter 119 9
concrete road construction
201 1-24
concrete scraper 200 13
concrete spreader 201 5
concrete spreader box 201 6
concrete tamper 119 83
concrete test cube 119 84
concrete-vibrating
compactor 201 10
concrete vibrator 119 88
condensate 172 17
condenser *Brew.* 92 6
condenser *Optic. Instr.* 112 8;
113 32
condenser *Oil, Petr.* 145 44
condenser *Nucl. Energy* 154
17, 35
condenser *Energy Sources*
155 8
condenser *Synth. Fibres* 170 5
condenser *Paperm.* 172 30
condenser *Warships* 259 64
condenser *Chem.* 350 48
condenser, coiled ~ 349 6
condenser, universal ~ 112 66
condensing locomotive 210
69
condensing tender 210 69
condition report 195 7
conductor *Power Plant* 153 34,
43
conductor *Spa* 274 21
conductor *Theatre* 315 26
conductor, copper ~ 127 43
conductor, electrostatic ~ 230
51; 231 27
conductor, high-voltage ~
152 33
conduit 334 54
cone *Phys. Geog.* 11 24
cone *Mach. Parts etc.* 143 67
cone *Synth. Fibres* 169 27
cone *Bicycle* 187 58
cone *Maths.* 347 43
cone *Decid. Trees* 371 32
cone, cross-wound ~ 165 8, 24
cone, pyrometric ~ 161 6
cone, truncated ~ 347 45
cone axis 372 3
cone breaker 172 82
cone chest 326 12-14
cone creel 165 9
cone drum box 163 30
cone height 347 44
cone nozzle 83 23
cone refiner 172 27, 60, 73, 83
cone scale 372 8, 14, 27, 38
cone-winding frame 165 1

cone-winding machine 169
26
coney 366 24
confectionery 97 17-47; 98
75-86
confectionery unit 97 67-70
conference circuit 242 22
conference connection 242 22
conference grouping 246
31-36
conference hook-up 242 22
conference table 246 31
confetti 306 62
configuration, angular ~ 248
39
confluence 224 90
conga drum 324 55
congregation 330 29
conifers 372 1-71
Conium 379 4
connecting corridor 208 11
connecting door, sliding ~
207 19
connecting element 248 48
connecting hose 208 16, 21
connecting lead 25 20, 56
connecting piece 350 56
connecting rod *Agr.* 63 20
connecting rod *Intern.*
Combust. Eng. 190 21
connecting rod *Railw.* 210 11
connecting-rod bearing 192
25
connecting seal, rubber ~ 207
8; 208 12
connecting shaft 63 20
connecting system, automatic
~ 237 25
connection, internal ~ 245 14
connection, pneumatically
sprung ~ 194 45
connection, rubber ~ 194 45
connection of modules 242 70
connection rebar 119 10, 71
connector *Moon L.* 6 28
connector *Weaving* 166 52
connector, thermoplastic ~
127 29
connector fitting 287 31
consignment, general ~ 206 4
consignment, mixed ~ 206 4
consignment note 206 30
console *Joiner* 133 24
console *Serv. Stat.* 196 29
console *School* 261 37
console *Music. Instr.* 326
36-52
console operator 244 3
console piano 325 1
console typewriter 244 4
consolidating beam 201 2
constant of integration 345
14
constellations 3 9-48
construction, close-seamed ~
285 54
construction, wooden ~ 260
72
construction of circuit 242 72
construction set 48 22
construction site 118; 119

construction unit, precast ~
215 58
construction vehicle 255 75
consulting room 23 1
contact, auxiliary ~ 153 57
contact, magnetic ~ 242 71
contact arc 237 43
contact arm 237 44
contact arm tag 237 46
contact breaker 242 49
contact field 237 45
contact goniometer 351 27
contact maker 127 38-39
contact sleeve, metal ~ 166 31
contact spring 127 28
contact wire maintenance
vehicle 211 41, 44-54
contact wire voltage indicator
211 28
container 206 57; 221 22; 226
3, 6
container *Chem.* 350 61
container, plastic ~ 83 25
container, railroad-owned ~
206 19
container, railway-owned ~
206 19
container, shielded ~ 154 82
container berth 225 48; 226 1
container car 206 58
container carrier truck 225 47
container for vegetables 96 51
container platform 194 27
container ship 221 89; 225 45
container station 206 54
container terminal 225 48;
226 1
container wagon 206 58
containment, steel ~ 154 21
contents 342 40
continents 14 12-18
continuity girl 310 39
continuity tester 127 55
continuous feed grate 199 34
continuous filament process
162 48
continuous reheating furnace
148 69
continuous rolling mill train
148 66-75
contouche 355 66
contour 15 62
contour, submarine ~ 15 11
contour knife 340 10
contrabass 323 23
contrabassoon 323 28
contrabass tuba 323 44
contracted burial 328 17
contractile vacuole 357 5
contra octave 321 43
contrast control 240 32; 249
36
contrast medium injector 27
15
control, digital ~ 242 35
control, manual ~ 115 52
control, sliding ~ 311 18
control and monitoring panel
311 8
control arm 240 29; 313 11
control board 153 1

control box *Moon L.* 6 23
control box *Mach. Tools* 150
36
control box *Offset Platem.*
179 33
control button *Hosp.* 25 30
control button *Cine Film* 117
98
control button *Text, Finish.*
168 40
control button *Navig.* 224 32
control button *Audiovis.* 243
13
control button *Office* 246 19
control button *School* 261 45
control cable 271 53
control column 230 24; 257
8; 288 14
control console *Power Plant*
153 1-6
control console *Photomech.*
Reprod. 177 5
control console *Films* 311 12
control console *Theatre* 316 2
control desk *Hosp.* 27 10
control desk *Brew.* 93 1
control desk *Iron & Steel* 147
66
control desk *Power Plant* 153
1-6
control desk *Nucl. Energy* 154
80
control desk *Offset Print.* 180
16
control desk *Photograv.* 182
28
control desk *Films* 311 12
control desk, driver's ~ 212 32
control desk, engineer's ~ 212
32
control device 26 7
control frame 287 46
control gear 164 38
control grip *Pest Contr.* 83 19
control grip *Photog.* 115 76
control handle, cranked ~ 168
52
control knob *Hosp.* 25 49; 27
41
control knob *Electrotyp. etc.*
178 15
controller 197 27
controller, rear ~ 197 8
controller handwheel 211 20;
212 12
control lever *Agr. Mach.* 64
59
control lever *Pest Contr.* 83 21
control lever *Cine Film* 117 63
control lever *Cotton Spin.* 163
28
control lever *Road Constr.*
201 8, 12
control lever *Navig.* 224 19
control lever *Broadcast.* 240
29
control lever *Films* 313 11
control lever *Theatre* 316 58
control line model 288 89
control linkage 190 30
control loudspeaker 311 13

- control mechanism 181 26
 control module 238 45; 240 11
 control panel *Hosp.* 26 20; 27 10
 control panel *Roof & Boilerr.* 38 67
 control panel *Dairy* 76 11
 control panel *Brew.* 93 1, 20
 control panel *Offshore Drill.* 146 28
 control panel *Power Plant* 153 1
 control panel *Nucl. Energy* 154 80
 control panel *Paperm.* 173 43
 control panel *Photomech.* *Reprod.* 177 36, 60
 control panel *Offset Platem.* 179 10, 17
 control panel *Offset Print.* 180 74
 control panel *Bookbind.* 185 2
 control panel *Broadcast.* 240 31
 control panel *Films* 311 4, 17, 29
 control panel, bracket-mounted ~ 177 6
 control panel, electric ~ 168 25, 58
 control panel, hinged ~ 177 6
 control platform 226 55
 control point 203 25
 control rod *Nucl. Energy* 154 24
 control rod *Warships* 259 69
 control rod drive 154 23
 control room *Hosp.* 25 1-9
 control room *Offshore Drill.* 146 32
 control room *Power Plant* 152 19, 28; 153 1-8
 control room *Railw.* 214 65
 control room *Broadcast.* 238 17
 control room *Theatre* 316 1
 control room, central ~ *Dairy.* 76 7
 control room, central ~ *Brew.* 92 25
 control room window 238 38
 controls 25 29; 153 6; 271 48
 control speaker 238 15
 control station 217 45
 control stick 230 24; 257 8; 288 14
 control switch *Hosp.* 25 29
 control switch *Electrotyp. etc.* 178 36
 control switch *Offset Print.* 180 74
 control switch *Navig.* 224 23
 control tap 172 9
 control tower 233 17; 287 12
 control unit *Hosp.* 26 7
 control unit *Optien.* 111 29
 control unit *Blacksm.* 138 31
 control unit *Mach. Tools* 150 36
 control unit *Photomech.* *Reprod.* 177 51
 control unit *Electrotyp. etc.* 178 29
 control unit *Offset Platem.* 179 33
 control unit *Audio* 241 40
 control unit, central ~ *Hosp.* 25 1, 20
 control unit, central ~ *Inf. Tech.* 242 2
 control unit, electric ~ 168 58
 control valve 153 52
 control weight 166 63
 control well 117 98
 control wheel *Text. Finish.* 168 40
 control wheel *Railw.* 212 81
 convenience outlet 127 5
 convenience outlet, double ~ 127 6
 convent 15 63
 convergence 224 90
 convergence module 240 12
 conversion filter step 117 38
 converter 92 42
 converter bottom, solid ~ 147 47
 converter chimney 147 67
 converter top, conical ~ 147 45
 converter tube 27 19
 convertible 193 9
 convertiplane 232 31
 conveyances 186 1-54
 conveyor *Poultry Farm* 74 22
 conveyor *Dairy.* 76 23
 conveyor *Bldg. Site* 118 77
 conveyor *Synth. Fibres* 169 32
 conveyor *Paperm.* 172 79
 conveyor *Photograv.* 182 30
 conveyor *Refuse Coll.* 199 36
 conveyor *Docks* 225 51
 conveyor belt *Dairy.* 76 23
 conveyor belt *Bldg. Site* 118 77
 conveyor belt *Synth. Fibres* 169 32
 conveyor belt *Paperm.* 172 79
 conveyor belt *Photograv.* 182 30
 conveyor belt *Docks* 225 51
 conveyor brattice 163 13
 conveyor trolley 74 39
 conveyor unit 83 59
 cook, head ~ 207 34
 cooker 96 47
 cooker, calor gas ~ 278 33
 cooker, double-burner ~ 278 33
 cooker, electric ~ 39 12; 46 32
 cooker, gas ~ 39 12; 278 33
 cooker hood 39 17; 46 31
 cooker unit 39 12-17
 cooking liquor 172 46
 cooking pot 39 29; 40 12
 cookroom 223 42
 coolant 149 44
 coolant bore 242 54
 coolant-collecting plant 92 7
 coolant feed line 235 38
 coolant flow passage 154 29
 coolant pump 190 61
 coolant pump, primary ~ 154 25
 coolant supply pipe 138 26; 149 25
 coolant system 154 55
 coolant tray 149 44
 cooler *Oil, Petr.* 145 44
 cooler *Coking* 156 27
 coolie 353 43
 cooling 170 34
 cooling compressor 92 22
 cooling cylinder 170 27
 cooling fan 312 34
 cooling rib 189 20; 190 80; 242 60
 cooling roll 173 25
 cooling roller 180 28
 cooling room 281 28
 cooling system 154 48
 cooling table 97 67
 cooling tank 162 15
 cooling tower *Coal* 144 15
 cooling tower *Nucl. Energy* 154 39
 cooling tower *Synth. Fibres* 170 43
 cooling unit 209 21; 212 26, 77
 cooling water *Nucl. Energy* 154 18
 cooling water *Railw.* 212 65, 78
 cooling water bore 242 54
 cooling water flow circuit 154 10
 cooling water heat exchanger 155 3
 cooling water pipe *Optien.* 111 31
 cooling water pipe *Power Plant* 152 27
 cooling water pipe *Car* 191 10
 cooling water temperature gauge 212 21
 cooling water thermostat 190 62
 cool shelf 266 49
 coon 368 9
 cooper 130 11
 coordinate 347 2-3, 8
 coordinate, right-angled ~ 347 1
 coot 359 20
 cop, full ~ 163 2
 cope 148 19
 copier, automatic ~ 249 32
 copier, web-fed ~ 249 32
 coping stone 37 37
 copper 305 6, 18
 copper, unworked ~ 260 64
 copper cylinder, polished ~ 182 7
 copper plate 179 9
 copperplate, polished ~ 340 53
 copperplate engraver 340 44
 copperplate engraving 340 14-24
 copperplate press 340 36
 copper sulphate 351 26
 copy 176 3; 177 18
 copy, received ~ 245 2

- copy, transmitted ~ 245 2
 copyboard 177 14, 22, 30
 copy cylinder 177 64
 copy delivery 249 43
 copyholder 177 15
 copying camera, overhead ~ 177 1
 copying stand 115 90, 92, 93
 cypod 115 90
 copy stand 115 90, 92, 93
 coquille 294 38, 43
 coral, precious ~ 357 17
 coral, red ~ 357 17
 coral animal 357 17
 coral *Clavaria* 381 32
 coral colony 357 18
 coral evergreen 377 12
 coral polyp 357 19
 coral reef 13 32
 cor anglais 323 38
 cord 206 12
 cord, warp-faced ~ 171 26, 27
 cordate 370 35
 corded ware 328 10
 cordon, horizontal ~ 52 17, 29
 cordon, quadruple ~ 52 1
 cordon, vertical ~ 52 2
 core *Phys. Geog.* 11 5
 core *Soft Fruit* 58 36, 59
 core *Iron Foundry etc.* 148 36
 core *Power Plant* 153 17, 36
 core *Electrotyp. etc.* 178 18
 core, soft-lead ~ 87 56
 core, special ~ 301 47
 core bit 145 21
 core print 148 37
 cooking machine, semi-automatic ~ 79 10
 corkscrew 40 18; 45 46
 corkscrew piton 300 40
 cormorant 359 10
 corn 68 1, 31
 corn camomile 61 8
 corn champion 61 6
 corn cob 68 36
 corn cockle 61 6
 cornea 19 47
 cornelian cherry 373 30, 32
 corner *Games* 276 27
 corner *Ball Games* 291 41; 292 18
 corner *Sports* 305 6; 305 8
 corner *Maths.* 347 33
 corner bottom slate 122 77
 corner brace 120 26
 corner flag 291 8
 corner kick 291 41
 corner peg 292 79
 corner seat 207 58; 265 10; 266 38
 corner section 42 26
 corner stile 120 52
 corner strut 120 52
 corner stud 120 52
 corner table 246 34; 266 39
 corner unit 39 27
 corner work 149 51
 cornet 323 43
 cornet, curved ~ 322 12
 cornfield 63 32
 corn flower 61 1

- corn head 64 35
 cornice *Carp.* 120 34
 cornice *Mountain.* 300 20
 cornice *Art* 334 11-14; 335 48
 corn marigold 61 7
 corn poppy 61 2
 corn removal 92 38
 corn salad 57 38
 corn spurry 69 12
 corn stem 68 5
 corn weevil 81 26
 corolla 59 11; 378 4
 corolla, papilionaceous ~ 57 1
 corona 334 12
 corona, solar ~ 4 39
 Corona *Borealis* 3 31
 coronet, baronet's ~ 254 43
 coronet, baronial ~ 254 44
 coronet, count's ~ 254 45
 coronet, ducal ~ 254 39
 coronet, elector's ~ 254 41
 coronet, prince's ~ 254 40
 coronets 254 37-46
 coronets of rank 254 43-45
 corporation stock 251 11-19
 corps de ballet 314 25
 corpus callosum 17 44
 corpus cavernosum and spongiosum 20 67
 corral 319 14
 correcting fluid 247 13
 correcting lens 115 22
 correcting paper 247 12
 correction lens 115 72
 corrector, universal ~ 238 48
 corrector plate 113 11
 correspondence 245 19
 correspondence file 22 12
 correspondent 342 54
 corresponding angle 346 12
 corrida 319 1-33
 corridor *Railw.* 207 11
 corridor *Winter Sp.* 301 71
 corridor compartment coach 207 1-21
 Corvidae 361 1-3
 corydalis 377 8
 cosine 346 32
 cosmetics 99 27-35
 cosmetics gondola 99 23
 cossack trousers 30 44
 costume, theatrical ~ 315 51
 costume designer 315 38
 costumes, historical ~ 355
 cot, collapsible ~ 28 1
 cotangent 346 32
 cottage, dikereeve's ~ 216 45
 cottage, ferryman's ~ 216 45
 cottage piano 325 1
 cotter punch 137 31
 cotton *Cotton Spin.* 163 1-13
 cotton *Industr. Plants* 383 16
 cotton bale, compressed ~ 163 3
 cotton bobbin 100 29
 cotton boll, ripe ~ 163 1
 cotton feed 163 9
 cotton-feeding brattice 163 8
 cotton grass 377 18
 cotton reel 104 9
 cotton rush 377 18
 cotton spinning 163; 164
 cotton wool 99 28
 cotton wool ball 99 30
 cotyledon 370 87
 couch *Doc.* 22 43
 couch *Weeds* 61 30
 coucher 173 49
 couch grass 61 30
 couchman 173 49
 coudé ray path 5 3
 coudière 329 48
 coulee 13 45
 coulter 65 10
 coulter, disc ~ 64 66; 65 69
 coulter, drill ~ 65 76
 coulter, rolling ~ 64 66; 65 69
 coulter, skim ~ 65 68
 counter *Child. Rm.* 47 28
 counter *Shoem.* 100 59
 counter *Shoes* 101 37
 counter *Cotton Spin.* 163 61
 counter *Composing Rm.* 175 41
 counter *Offset Print.* 180 74
 counter *Railw.* 207 31
 counter *Café* 265 1
 counter *Restaurant* 266 1-11
 counter *Water* 269 59
 counter *Ball Games* 291 23
 counter *Winter Sp.* 302 18
 counter *Flea Market* 309 83
 counter, cashier's ~ 250 1
 counter, extra ~ 271 64
 counter, special ~ 271 64
 counter assistant 265 7
 counterbalance 241 22
 counterbalance weight 242 50
 counterblow hammer 139 5
 counterbrace 215 35
 counter clerk 236 16
 counter gear assembly 269 55
 counter officer 236 16
 counterpoise *Optic. Instr.* 113 19
 counterpoise *Hydr. Eng.* 217 76
 counterpoise *Docks* 226 50
 counterpoise *Army* 255 78
 counter stamp machine 236 19
 counter tube 2 21
 counter tube casing 2 20
 counterweight *Overh. Irrign.* 67 37
 counterweight *Optic. Instr.* 113 19
 counterweight *Bldg. Site* 119 33
 counterweight *Forging* 139 34
 counterweight *Hydr. Eng.* 217 76
 counterweight *Docks* 226 50
 counterweight *Audio* 241 22
 counterweight *Army* 255 78
 counting, automatic ~ 74 52
 counting beads 47 14
 counting blocks 48 17
 counting mechanism 309 83
 counting out 299 42
 country estate 15 94
 countryside in winter 304

coupé *Carriages* 186 3
 coupé *Car* 193 28
 couple 267 46; 272 72; 317 17-18
 couple, bridal ~ 332 15-16
 coupler *Bldg. Site* 119 53
 coupler *Plumb. etc.* 126 43
 coupler *Music. Instr.* 326 41
 couplet 321 23
 coupling *Agr. Mach.* 65 61
 coupling *Bldg. Site* 119 53
 coupling *Railw.* 208 16; 210 2; 212 82; 214 18
 coupling, front ~ 65 50
 coupling, unlinked ~ 208 19
 coupling bolt 202 15
 coupling hook 122 64
 coupling hose 208 21
 coupling link 208 17
 coupling screw 208 18
 coupling spindle 148 58
 coupon 251 17
 coupon sheet 251 17
 courbette 71 6
 course *Weaves* 171 42
 course *Rivers* 216 9
 course *Winter Sp.* 301 44
 course, damp-proof ~ 123 4
 course, first ~ 118 67
 course, second ~ 118 68
 course, triangular ~ 285 16
 course counter 167 43
 course-marking flag 301 45
 course markings 289 19
 courser 70 24
 court dress 355 79
 courtesy light 191 77
 court shoe 101 29
 court shoe, fabric ~ 101 54
 court shoe, sling-back ~ 101 53
 couter 329 48
 cove 13 7
 cover *Atom* 2 14
 cover *Dining Rm.* 44 5
 cover *Tablew. etc.* 45 3-12
 cover *Optic. Instr.* 113 13
 cover *Photog.* 115 11
 cover *Bldg. Site* 118 22
 cover *Bookbind.* 185 40
 cover *Bicycle* 187 30
 cover *Water* 269 56
 cover, canvas ~ 255 98
 cover, glass ~ *Kitch. Utensils* 40 7
 cover, glass ~ *Energy Sources* 155 33
 cover, hinged ~ 309 27
 cover, nylon ~ 207 68
 cover, porous ~ 199 21
 cover, screw-in ~ 115 11
 cover, screw-on ~ 83 40
 cover, soundproof ~ 310 48
 cover, terry ~ 49 14
 cover, transparent ~ 249 27
 coverall 29 23
 cover cylinder 184 10
 covering 287 40
 covering, felt ~ 353 20
 covering, green baize ~ 277 15

covering material 184 12
 cover projection 243 47
 coving 336 10
 cow 73 1
 cowberry 377 23
 cowboy 306 31; 319 36
 cowboy boot 101 9
 cowcatcher 210 34
 cow corn 68 31
 cowl *Blacksm.* 137 7
 cowl *Warships* 258 21; 59
 cowl *Church* 331 56
 cowl collar 30 3
 cow neck jumper 30 2
 Cowper's gland 20 75
 cowshed 62 7
 cowslip 376 8
 cox 283 11
 coxed single 283 18
 coxless four 283 9
 coxless pair 283 15
 CQR anchor 286 16
 Crab *Astron.* 4 56
 crab *Shipbuild.* 222 14, 28
 crab *Articulates* 358 1
 crab *Deep Sea Fauna* 369 16
 crab apple tree 58 51
 crab louse 81 40
 cracker 306 50
 cracker, catalytic ~ 145 48
 crackowe 355 42
 cradle 237 13
 cradle, bouncing ~ 28 2
 cradle, double ~ 214 68
 cradle, two-wheel ~ 214 69
 cradle frame, lightweight ~ 189 17
 cradle switch 237 13
 craft room 260 46-85
 craneberry 377 23
 cramp 119 58; 120 66
 cramp iron 119 58; 121 97
 crampon 300 48
 crampon cable fastener 300 52
 crampon strap 300 51
 Crane *Astron.* 3 42
 crane *Warships* 258 88
 crane, floating ~ 225 10; 226 48
 crane, flying ~ 232 16
 crane, hammer-headed ~ 222 7
 crane, overhead ~ 222 20
 crane, polar ~ 154 38
 crane, revolving ~ 146 3
 crane, travelling ~ 147 41; 222 20
 crane cable 222 13
 crane framework 226 53
 crane hoist, auxiliary ~ 147 61
 crane hook 139 45
 crane motor 157 28
 crane's bill 53 1; 376 24
 crane track 119 27
 crane truck 270 47
 crank *Agr. Mach.* 64 43
 crank *Bicycle* 187 41
 crank *Road Constr.* 201 18
 crankcase 190 40; 242 51
 crankcase scavenging 242 59

crank drive 217 53
 crankshaft 166 50; 190 23; 192 29
 crankshaft, counterbalanced ~ 242 50
 crankshaft bearing 190 22; 192 23
 crankshaft bleed 192 22
 crankshaft drilling 192 22
 crankshaft tributary 192 22
 crankshaft wheel 166 51
 crash bar 188 18
 crash barrier 259 17
 crash hat 290 3
 crash helmet 301 13; 303 14
 crate 76 30; 206 5
 crater 312 44
 crater, volcanic ~ 11 16
 cravat 32 40
 craw 73 20
 crawl 282 37
 crawl stroke 282 37
 crayon 47 26; 338 5
 crayon, wax ~ 48 11; 260 6
 crayon engraving 340 14-24
 cream 99 27, 46
 cream, whipped ~ 97 28; 265 5
 cream cake 97 21, 24
 creamer 265 21
 creamery butter machine 76 33
 cream heater 76 13
 cream jar 28 13
 cream jug 265 21
 cream maturing vat 76 31
 cream pie 97 24
 cream puff 97 27
 cream roll 97 17
 cream separator 76 14
 cream supply pump 76 40
 cream tank 76 19
 crease *Men's Wear* 33 6
 crease *Ball Games* 292 72
 crease *Ethnol.* 353 44
 creatures, fabulous ~ 327 1-61
 creatures, mythical ~ 327 1-61
 creek *Phys. Geog.* 13 8
 creek *Map* 15 80
 creel *Fish Farm.* 89 25
 creel *Cotton Spin.* 164 28, 58
 creel *Weaving* 165 25
 creel, full ~ 164 41
 creeper 51 5; 52 5; 53 2; 57 8
 creeping foot 357 28
 creese 353 44
 crenate 370 46
 crenel 329 18
 crenellation 329 6
 crepe paper 49 11
 crepidoma 334 4
 crescendo 321 31
 crescendo roller 326 49
 crescendo roller indicator 326 37
 crescent *Astron.* 4 3, 7
 crescent *Bakery* 97 32
 crescent *Supermkt.* 99 13
 Crescent *Flags* 253 19

crescent-forming machine 97 64
 crescent moon 4 3, 7
 crescent roll 97 32; 99 13
 crescent wing 229 18
 crest *Horse* 72 12, 14
 crest *Dom. Anim.* 73 22
 crest *Heraldry* 254 1
 crest, dorsal ~ 364 21
 crest, erectile ~ 359 26
 Cresta tobogganing 303 22-24
 crest coronet 254 12
 crested lark 361 19
 crested newt 364 20
 cresting 305 65
 crest of dam 217 59
 crests 254 1, 11, 30-36
 crevasse 12 50; 300 23
 crew compartment 6 41; 235 16
 crew cut 34 11
 crew entry tunnel 235 71
 cricket 292 70-76
 cricket bat 292 75
 crimping 170 59
 crimping iron 106 26
 crimson clover 69 4
 crinoline 355 72
 crispbread 97 50
 cross-cross skin 297 44
 cristobalite 112
 croaking sac 104 25
 crochet 335 38
 croissant 97 32; 99 13
 croquet 220 26
 croquet yard 220 25
 cromlech 328 16
 crook 324 71
 crook of the arm 16 44
 crop 73 20
 crops, arable ~ 68
 croquant 98 85
 croquet 292 77-82
 croquet ball 292 82
 croquet mallet 292 81
 croquet player 292 80
 Cross *Astron.* 3 44
 cross *Plumb. etc.* 126 50
 cross *School* 260 28
 cross *Church* 331 25
 cross, ansate ~ 332 63
 cross, cardinal's ~ 332 65
 cross, Constantinian ~ 332 67
 cross, fivefold ~ 332 72
 cross, Greek ~ 332 56
 cross, Latin ~ 332 55
 cross, Papal ~ 332 66
 cross, patriarchal ~ 332 64
 cross, processional ~ 330 47
 cross, quintuple ~ 332 72
 cross, Russian ~ 332 57
 cross, saltire ~ 332 60
 cross, St. Andrew's ~ 332 60
 cross, St. Anthony's ~ 332 59
 cross, St. Peter's ~ 332 58
 cross arm 152 37
 cross arms 10 30
 crossbar *Goldsm. etc.* 108 5
 crossbar *Bicycle* 187 16
 crossbar *Ball Games* 291 36

crossbar *Athletics* 298 14, 34
 cross beam 119 57
 cross bearer 331 43
 cross bond, English ~ 118 65
 cross bottonnée 332 71
 crossbrace 215 35
 cross bracing wire 229 12
 crossbuck 202 41
 cross chain conveyor 157 22
 cross conveyor 157 20
 cross-country *Equest.* 289 17
 cross-country *Winter Sp.* 301 42
 cross-country binding 301 15
 cross-country boot 301 16
 cross-country equipment 301 14-20
 cross-country gear 301 17
 cross-country lorry 194 1
 cross-country motorcycle 189 16
 cross-country pole 301 20
 cross-country race 290 33
 cross-country ski 301 14
 cross-country stretch-suit 301 43
 cross-country tyre 194 4
 cross-cut 144 31
 cross-cut, octagonal ~ 36 53
 cross-cut, oval hexagonal ~ 36 63
 cross-cut, round hexagonal ~ 36 65
 cross-cut, trapezium ~ 36 58
 cross-cut chain saw 157 38
 cross-cut chisel 140 25
 cross-cut saw 120 14
 crosses, Christian ~ 332 55-72
 crossfall 200 57
 cross fold knife 185 12
 cross fold unit, third ~ 185 14
 cross grasp 296 43
 cross hairs 87 32
 cross hairs, double ~ 115 66
 cross hatch 340 54
 cross head *Forging* 139 37
 cross head *Railw.* 210 27
 crossing 205 15
 crossing, intercom-
 controlled ~ 202 47
 crossing, telephone-
 controlled ~ 202 47
 crossing keeper 202 42
 crossing the bar 298 31
 crossjack 220 26
 crossjack yard 220 25
 cross joint 151 50
 cross lacing 29 37
 crosslet 332 68
 cross moline 332 69
 cross of Jerusalem 332 70
 cross of Lorraine 332 62
 cross of the Passion 332 55
 crossover 241 14
 crossover, double ~ 203 49-52
 crossover network 241 14
 cross piece *Bldg. Site* 119 61
 cross piece *Shipbuild.* 222 15
 cross piece *Fencing* 294 42
 cross rib 335 31
 cross slide 149 23, 39; 150 12

cross-slide guide 174 48
 cross spider 358 45
 cross stitch 102 5
 cross stitch, Russian ~ 102 9
 cross strut 119 67
 cross tie *Roof* 121 30
 cross tie *Station* 205 60
 crosstie, concrete ~ 202 37
 crosstie, coupled ~ 202 14, 38
 crosstie, steel ~ 202 36
 cross total counter 242 3
 crosstrees 223 37; 284 13
 crosstrees, starboard ~ 286 9
 cross trellée 332 71
 cross vault 335 31-32
 crosswalk 198 11; 268 24, 51
 cross-winding the threads 165 11
 cross wire, overhead ~ 197 42
 cross wires 87 32
 crotchet 320 15
 crotchet rest 320 23
 crouch 295 6, 23
 crouch start 298 4
 croup 72 31
 croupier 275 4
 croupier, head ~ 275 6
 crow 86 50, 51; 361 2
 crowbar 158 32
 crowberry 377 23
 crowfoot 375 8
 crown *Man* 16 1; 19 37
 crown *Dent.* 24 28
 crown *Forging* 139 36
 crown *Bridges* 215 31
 crown *Park* 272 60
 crown *Art* 336 39
 crown *Hist. Cost.* 355 21
 crown *South. Fruits* 384 29
 crown, gold ~ 24 28
 crown, mural ~ 254 46
 crown block 145 4
 crown cork 93 27
 crown cork bottle-opener 45 47
 crown cork closure 93 27
 crown cork opener 45 47
 crown of hooks 81 38
 crown-of-the-field 61 6
 crown of tree 370 3
 crownpiece 71 10
 crowns 254 37-46
 crown safety platform 145 3
 crown wheel *Clocks* 110 41
 crown wheel *Mach. Parts etc.* 143 93
 crows 361 1-3
 crow's nest 223 38
 crucible, clay ~ 350 31
 crucible, graphite ~ 108 10
 crucible tongs 108 11; 350 32
 crucifer 331 43
 crucifix *Gymn.* 296 50
 crucifix *Church* 332 33
 crucifix, processional ~ 331 42
 crude benzene, production of ~ 156 41
 crude benzene tank 156 42
 crude benzol, production of ~ 156 41

crude benzol tank 156 42
 crude oil production 145 22-27
 crude phenol tank 156 40
 crude tar tank 156 32
 cruet set 332 44
 cruet stand 266 22
 cruiser 286 5
 cruiser keelboat 285 29-34
 cruiser stern 285 45
 cruising yacht 284 60
 crumb 97 3
 crumhorn 322 6
 crupper 71 34; 72 31
 crupper-strap 71 34
 crusader 329 72
 crushed grape transporter 78 16
 crusher 172 5
 crusher, coarse ~ 158 19
 crusher, fine ~ 158 19
 crusher, gyratory ~ 158 19
 crusher, primary ~ 158 17
 crusher, rotary ~ 158 19
 crush hat 35 36
 crush room 315 12-13
 crust 97 4, 5
 crust, earth's ~ 11 1
 crust, outer ~ 11 1
 crustacean 369 12, 15, 16
 crustaceans 358 1-2
 crusta petrosa 19 29
 crutch 148 15
 Crux 3 44
 cryosurgery 22 63
 Cryptolestes 81 27
 crystal 351 29
 crystal centre 351 3
 crystal combinations 351 1-26
 crystal cone 77 21
 crystal detector 309 23
 crystal forms 351 1-26
 crystallography 351
 crystallography 351 27-33
 crystal plate glass 124 5
 crystals 351 1-26
 crystal set 309 23
 crystal system 351 1-17
 cub 88 42
 cube *Kindergart.* 48 21
 cube *Maths.* 347 30
 cube *Crystals* 351 2, 14, 16
 cube root 345 2
 cube sugar 98 53
 cubic crystal system 351 1-17
 cubitière 329 48
 cuckoo 359 30
 cuckoo clock 109 31
 cuckoo flower 375 11; 376 21
 cuckoo pint 379 9
 cucumber 57 13; 99 83
 cue 277 9
 cue ball, white ~ 277 11
 cue rack 277 19
 cue tip, leather ~ 277 10
 cuff 25 16; 30 14; 32 45
 cuff, fur ~ 30 62
 cuff, fur-trimmed ~ 30 62
 cuff, inflatable ~ 23 34

cuff, ribbed ~ 30 30
 cuff link 32 46; 36 21
 cuff protector 324 17
 cuff slit 30 48
 cuirass 329 46
 cuish 329 52
 cuissard 329 52
 cuisse 329 52
 culicid 358 16
 culm *Arable Crops* 68 6
 culm *Coking* 156 14
 culotte 31 48; 29 59
 cultivator *Market Gdn.* 55 21
 cultivator *Agr. Mach.* 65 55
 cultivator, three-pronged ~ 56 13
 cultivator attachment 56 21
 culture, bacteriological ~ 261 29
 cumulonimbus 8 17; 287 26
 cumulonimbus cloud 287 26
 cumulus 8 1; 287 22
 cumulus cloud 287 22
 cumulus congestus 8 2
 cumulus humilis 8 1
 cup *Bicycle* 187 79
 cup *Decid. Trees* 371 5
 cup, baby's ~ 28 27
 cup, hemispherical ~ 10 30
 cup, rust-proof ~ 122 102
 cup, zinc ~ 122 102
 cup bearer 329 69
 cupboard 246 5
 cupboard, children's ~ 47 21
 cupboard, sliding-door ~ 248 38
 cupboard base unit 42 6
 cupboard unit 42 7
 cupboard unit, two-door ~ 46 6
 cup cymbals 324 50
 cupid 272 20
 cupola *Iron Foundry etc.* 148 1
 cupola *Art* 334 58
 cupola, bulbous ~ 336 3
 cupola furnace 148 1
 cupule 59 42; 371 5; 384 52
 curb 198 6; 272 25
 curb bit 71 13, 52
 curb chain 71 12
 curbstone 198 7
 curbstone broker 251 5
 curbstoner 251 5
 curd cheese 76 38
 curd cheese, packeted ~ 76 45
 curd cheese machine 76 38
 curd cheese packing machine 76 44
 curd cheese pump 76 39
 curds separator 76 41
 curettage 26 52
 curette 22 50; 26 52
 curing floor 92 18
 curing kiln 92 30
 curl 34 3
 curl brush 105 13
 curl clip 105 14
 curler *Hairdresser* 105 4
 curler *Winter Sp.* 302 41
 curling 302 41-43

curling broom 302 43
 curling brush 302 43
 curling iron 105 5; 106 31
 curling stone 302 42
 curling tongs 105 5; 106 31
 curly kale 57 34
 currant 58 12, 14; 98 9
 currant bush 52 19; 58 10
 current 216 9
 current, cold ~ 9 29
 current, three-phase ~ 153 42
 current, warm ~ 9 28
 current collector *Lorries etc.* 194 41
 current collector *Tram* 197 2, 23
 current collector *Railw.* 207 24, 75; 211 2, 30
 current meter *Railw.* 212 18
 current meter *Rivers* 216 43
 current rating 127 37
 currents, oceanic ~ 14 30-45
 current transformer 153 58
 current/voltage meter 242 77
 currycomb 71 54
 curtail step 123 18, 42
 curtain *Dining Rm.* 44 13
 curtain *Railw.* 207 56
 curtain *Chivalry* 329 15
 curtain, iron ~ 316 24
 curtain, theatrical 316 23
 curtain department 271 66
 curtain lace 167 29
 curtain operation, types of ~ 315 1-4
 curtain rail 44 15
 curtain wall 329 15
 curvature 346 22
 curve *Sports* 305 19
 curve *Maths.* 347 11, 18
 curve, ballistic ~ 87 79
 curve, hypsographic ~ 11 6-12
 curve, inflected ~ 347 13
 curve, plane ~ 347 12
 curved electrotype casting machine 178 13
 curved plate casting machine 178 13
 curve eight 302 11
 curvet 71 6
 cushion 42 23; 47 8; 202 6
 cushion, gilder's ~ 129 50
 cushion, rubber ~ 277 16
 cushion capital 335 21
 cusp 20 48
 customer 98 43; 99 2, 18; 111 2; 248 18; 250 6; 266 25; 271 16, 55
 customer accounts office 271 24
 customer area 207 78
 customer card index 248 24
 customer service representative 248 17
 customs 217 24
 customs barrier 225 4
 customs boat pendant 253 35
 customs boat pennant 253 35
 customs entrance 225 5
 customs flags 253 35-38

customs launch 221 100
 customs signal flag 253 37
 cut *Metalwkr.* 140 28
 cut *Fencing* 294 23
 cut, antique ~ 36 49
 cut, cold ~ 96 14
 cut, positive ~ 340 3
 cut, round ~ 36 42-43
 cut, standard ~ 36 48
 cut and thrust weapon 294 34
 cutlery 45; 309 47
 cutlery chest 266 41
 cutlery drawer 39 10; 44 21
 cutlery holder 266 48
 cutlet 95 12
 cut nippers, detachable-jaw ~ 140 67
 cutoff knife and roughing station 184 3
 cuts 36 42-86
 cuts, fancy ~ 36 68-71
 cutter *Paperhanger* 128 42
 cutter *Joiner* 132 20
 cutter *Drawing Off.* 151 15
 cutter *Brickwks.* 159 15
 cutter *Paperm.* 173 44
 cutter *Composing Rm.* 175 33, 51
 cutter *Shr.* 220 8
 cutter *Workshps* 258 12, 61
 cutter *Films* 311 43
 cutter, automatic ~ 162 19
 cutter, fine ~ 133 37
 cutter, rotary ~ *Forestry* 85 26
 cutter, rotary ~ *Bookbind.* 184 22
 cutter, spherical ~ 108 7
 cutter, universal ~ 134 28
 cutter bar 64 3
 cutter for metal watch straps 109 19
 cutter spindle 175 60
 cutting *Map* 15 84
 cutting *Plant Propagn.* 54 19, 20
 cutting *Synth. Fibres* 170 60
 cutting *Films* 311 42-46
 cutting, shooting ~ 54 24
 cutting, sprouting ~ 54 24
 cutting attachment 141 19
 cutting bench 117 96; 311 42
 cutting blade 183 19
 cutting cylinder *Gdn. Tools* 56 35
 cutting cylinder *Text. Finish.* 168 44
 cutting drum 64 34
 cutting edge 45 57; 66 14; 85 2
 cutting edge, cemented carbide ~ 149 48, 50
 cutting edge, razor's ~ 106 40
 cutting head 175 51
 cutting-in brush 129 20
 cutting machine *Furrier* 131 5
 cutting machine *Gas Weld.* 141 34
 cutting machine *Synth. Fibres* 169 30
 cutting machine, universal ~ 141 36

cutting nozzle 141 38
 cutting-off machine 125 16
 cutting pliers 127 51
 cutting point 136 35
 cutting room 310 3
 cutting scale, illuminated ~ 185 6
 cutting shears 103 3
 cutting table *Dressm.* 103 4
 cutting table *Cine Film* 117 96
 cutting table *Composing Rm.* 175 52
 cutting table *Films* 311 42
 cutting template 103 13
 cutting tip, adjustable ~ 149 45, 46
 cutting tip, cemented carbide ~ 149 50
 cutting unit *Gdn. Tools* 56 33, 41
 cutting unit *Agr. Mach.* 64 8
 cuttlefish 357 37; 369 4
 cuttling device 168 35
 cutup 326 25
 cutwater 215 56
 cutworm 80 44
 cyan filter adjustment 116 45
 cyclamen 53 5
 cycle 187 1
 cycle, motor-paced ~ 290 15
 cycle racing 290 1-23
 cycle serial number 187 51
 cycle track 290 1
 cycling track 290 1
 cyclohexanol, pure ~ 170 18
 cyclohexanol, raw ~ 170 16
 cyclohexanone 170 20
 cyclohexanoxime 170 22
 cyclone 4 38; 9 5
 cyclone heat exchanger 160 6
 cyclorama 310 12; 316 9
 cyclotron 2 49
 Cygnus 3 23
 cylinder *Cooper* 130 27
 cylinder *Metalwkr.* 140 45
 cylinder *Cotton Spin.* 163 43
 cylinder *Offset Print.* 180 79
 cylinder *Railw.* 210 32
 cylinder *Swim.* 279 19
 cylinder *Graphic Art* 340 40
 cylinder *Chem.* 350 45
 cylinder, developed ~ 182 13
 cylinder, grooved ~ 165 10
 cylinder, high-pressure ~ 153 23
 cylinder, hydraulic ~ 64 8; 194 26
 cylinder, low-pressure ~ 153 25
 cylinder, medium-pressure ~ 153 24
 cylinder, perforated ~ 163 21
 cylinder, right ~ 347 38
 cylinder, steel ~ 180 54
 cylinder arm 177 68
 cylinder crankcase 190 19
 cylinder diameter 167 16
 cylinder head 190 45; 242 47
 cylinder head gasket 190 48
 cylinder loek 140 44
 cylinder oil 145 63

cylinder-processing machine 182 9
 cylinder temperature gauge 230 9
 cylinder trimmer 85 25
 cylinder trolley 141 23
 cylinder undercasing 163 55
 cyma 334 11, 19
 cymatium 334 19
 cymbal 324 51
 cymbal holder 324 52
 cymbals 323 50
 cymbal stand 324 52
 cyme 370 70; 374 36
 cyme, curled ~ 370 77
 cyme, helicoid ~ 370 76
 cyme, scorpioid ~ 370 77
 cypress 372 58
 cythara 322 15

D
 dabber 340 22
 dachshund 70 39
 dactyloscopy 264 28
 dado, oil-painted ~ 129 15
 daemon 327 58
 da gamba violin 323 16
 dagger, bronze ~ 328 22
 dagger, hafted ~ 328 22
 dagger, Malayan ~ 353 44
 dahlia 51 20; 60 23
 dairy 76 1-48
 dairy cow 62 34; 75 17
 dairy cow shed 75 14
 dairy plant 76 1-48
 dairy product 99 43
 daisy 376 1
 dam *Map* 15 69
 dam *Game* 88 1
 dam *Energy Sources* 155 38
 dam *Hydr. Eng.* 217 57-64
 damp course 123 4
 dampener 180 23, 52, 61
 dampening roller 180 23, 52, 61
 dampening unit 180 39, 61
 damper *Offset Print.* 180 23, 52, 61
 damper *Car* 191 26; 192 69
 damper *Music. Instr.* 322 54; 325 37
 damper, electromagnetic ~ 11 40
 damper block 325 37
 damper door 210 6
 damper lifter 325 38
 damper-lifting lever 325 23
 damper pedal 325 8
 damper rest rail 325 39
 damping roller 180 23, 52, 61
 damping unit 180 39, 61
 dam sill 217 79
 dance band 306 2
 dance band instruments 324 47-78
 dance band musician 306 3
 dance costume 354 36
 dance drum 354 14
 dance floor 317 16

dance floor lighting 317 14
dancer 317 17, 18
dancer, principal ~ 314 28
dancing girl, Hindu ~ 306 25
dancing snake 353 48
dancing stick 354 37
dandelion 51 34; 61 13
dandy 306 33
dandy brush 71 55
Danebrog 253 17
Danforth anchor 286 18
danger zone 2 50
Dan grade 299 15
Danish pastry 97 30
Dannebrog 253 17
daphne 377 10
dark beer 93 26
darkroom equipment 116
1-60
darkroom lamp 116 21
dark slide 114 64
darning stitch 102 17
dart 352 28
dart, barbed ~ 319 22
dart point 352 29
das 366 24
dash 342 23
dashboard *Carriages* 186 6
dashboard *Car* 191 57-90
dashboard *Tram* 197 29
dashboard lighting 197 30
dassie 366 24
data, technical ~ 151 32
data carrier 237 59, 62-64
data centre 248 43
data collection station,
central ~ 242 20
data display terminal 238 2,
11; 248 16, 44
data output 112 44
data print-out 195 7
data processor 237 60
data recording back 115 67
data service 237 58
data storage unit 242 32
data terminal 242 19
data transmission 237 58
data transmission service 237
41
date 384 9
date and second button 110 4
date indicator display 237 39
date kernel 384 10
date of issue 250 14
date of maturity 250 16
date of publication 342 42
date palm 384 1
date sheet 247 33
date stamp postmark 236 57
daughter boat 228 17
davit 221 78, 101; 223 20; 258
13, 83, 88
day cream 99 27
dayfly 358 6
daylight film magazine 311 7
daylight-loading tank 116 5
day nursery 48
dead axle 210 35
deadly nightshade 379 7
dead man's handle 211 21;
212 13

deadwood 285 47
de-aerator 152 16
de-airing pug mill 161 7
de-airing pug press 161 7
dealer 275 3
death notice 342 68
death's-head hawkmoth 365
9
death's-head moth 365 9
death spiral 302 5
debarking 85 23
debenture bond 251 11-19
debenzoling 156 27
decade 332 32
decatizing cylinder,
perforated ~ 168 50
decay, spontaneous ~ 1 28
Decca navigation system 224
39
decimal, recurring ~ 344 21,
22
decimal fraction, proper ~
344 20
decimal key 247 19
decimal place 344 20
decimal point 344 20
deck *Rowing* 283 57
deck *Films* 311 10
deck, lower ~ *Offshore Drill*
146 35
deck, lower ~ *Lorries etc.* 194
37
deck, lower ~ *Space* 235 28
deck, main ~ *Offshore Drill*
146 37
deck, main ~ *Ship* 221 80; 223
32-42
deck, main ~ *Warships* 258 9
deck, middle ~ 146 36
deck, orthotropic ~ 215 2
deck, top ~ 146 37
deck, upper ~ *Lorries etc.* 194
38
deck, upper ~ *Railw.* 213 36
deck, woven ~ 215 18
deck beam 222 57
deck bucket 221 113
deck-chair 37 47; 51 2; 221
111; 274 13
deck crane 221 5, 61
deck crane *Warships* 259 10
decker 172 24, 42, 44, 48, 62
deck hand 221 112
deckhouse 221 6, 39; 223 34;
258 72
decking, woven ~ 215 18
deck plan 259 12-20
deck plating 222 56
deck slab 215 6
deck space 223 28
deck tennis 280 31
declination axis 113 5, 17
declination bearing 113 6
declination gear 113 4
decoder 110 18
décolletage 306 24
decometer 279 17
decoration, Greek ~ 334
38-43
decoration, Romanesque ~
335 14-16

decorative glass worker 124 8
decorative pieces 35 4
decoy bird 86 48
decrescendo 321 32
dedication, handwritten ~
185 50
dedusting fan 83 53
dedusting screen 83 56
deep-sea cable 237 56
deep-sea fauna 369
deep-sea fishing 90 1-23
deep-sea floor 11 10
deep-sea medusa 369 5
deep-sea salvage tug 258 96
deep-sea trench 11 12
deep tank 223 78
deep-water start 286 46
deer, antlerless ~ 88 1
deer fence 84 7
deer stalking 86 1-8
defence area 293 66
defender *Ball Games* 292 4
defender *Fencing* 294 6
defending fencer 294 6
deflection system 240 23
deflector piston 242 56
defroster vent 191 42; 192 64
dégagé 314 11, 12
degree 345 2
degree scale 313 14
dehydrogenation 170 19
delayed-action release 115 15
delay indicator 205 24
delicatessen shop 98 1-87
deliveries 305 17-20
delivery 184 5; 185 23, 35
delivery blower 181 33
delivery cylinder 180 42, 65
delivery hose 270 31
delivery mechanism *Offset
Print.* 180 45
delivery mechanism *Post* 236
49
delivery pile 180 44; 181 9
delivery pipe *Docks* 226 44
delivery pipe *Water* 269 16,
49, 52
delivery pouch 236 54
delivery reel 173 28
delivery roller 164 59
delivery table 181 31; 184 14,
19
delivery tray 185 15
delivery tube 65 77
delivery unit 180 45
delivery valve 67 9
delphinium 60 13
delta 13 1
delta connection 153 21
delta wing 229 19
deltoid 346 38
demand regulator, two-tube
~ 279 20
demesne 15 94
demi-goat 254 32
demigod 327 40
demi-john 206 13
demi-man 254 11
demi-mondaine 306 37
demi-monde 306 37
demi-rep 306 37

demisemiquaver 320 18
demisemiquaver rest 320 26
demi-woman 254 11
demonstration bench 261 3
demonstration equipment
242 45-84
demonstration model 242 45,
55
demonstrator 262 6
den 273 56
Deneb 3 23
denims 31 60; 33 22
denomination *Money* 252 32
denomination *Maths.* 344 19
denominator 344 15
dental surgeon 24 1
dentate 370 47
dent corn 68 31
dentil 334 14
dentine 19 31
denticing draft 171 6
dentist 24 1
denture 24 25
department manager 271 60
department store 268 41; 271
departure building 233 15
departures 233 25
departure schedule 204 20
departure time indicator 205
23
departure timetable 204 20
deposit counter 236 25
deposit slip 236 27
depot 144 1
depression 9 5
depth adjustment 64 88; 65
9; 157 45
depth-charge thrower 258 34
depth gauge *D.I.Y.* 134 47
depth gauge *Swim.* 279 15
depth gauge attachment rule
149 68
depth of focus 11 34
depth reading 224 67
depth recorder 224 24
depth recording 224 67
depth scale 224 66
depth wheel 65 59, 63
derailment guard 214 75
derivative 345 13
derrick *Phys. Geog.* 12 33
derrick *Offshore Drill.* 146 12
derrick *Ship* 221 67
derrick boom 221 26, 59; 223
36
derrick boom, heavy-lift ~
221 25, 62
derrick mast 221 60
descant viol 322 23
descent stage 6 28-36
desert monitor 364 31
desert zone 9 54
desiccator 350 51
desiccator insert 350 54
design 151 16
design, chequered ~ 335 14
design, computer-generated
~ 248 19
design, imbricated ~ 335 15
design, knitted ~ 30 37
design, modular ~ 240 1

design, quilted ~ 30 31
design for costume 315 39
designs, decorative ~ 334
38-43; 335 14-16
desk 46 22; 246 2
desk, cashier's ~ 250 1
desk, clerical assistant's ~ 248
11
desk, double ~ 260 2
desk, instructor's ~ 242 2
desk, stage manager's ~ 316
29
desk, teacher's ~ 260 22
desk chair 46 27
desk diary 247 32
desk drawer 46 26; 246 4
desk lamp 246 11
desk mat 46 23; 246 6; 260 25
desk set 246 9
desk top 246 3
desk unit 46 21
dessert bowl 45 6
dessert plate 45 6
dessert spoon 45 61, 66
destination board 205 21, 38
destination indicator 205 22
destination sign 197 20
destroyer 258 1, 38
desulfurization see
desulphurization
desulfurizing see
desulphurizing
desulphurization 156 28
desulphurizing 169 20
desulphurizing plant 145 46,
68
detaching roller 163 71
detangling brush 105 2
detective 264 33
detector indicator unit 224 34
detonator cap 87 58
detritus 12 45
deutero-pyramid 351 20
Deutschmark 252 7
Devanagari 341 9
developer 27 33
developer, first ~ 116 10
developing dish 116 25
developing dish, semi-
automatic ~ 116 56
developing dish,
thermostatically
controlled ~ 116 56
developing solution 116 9
developing spiral 116 2
developing tank *Photog.* 116
1, 20
developing tank *Photograv.*
182 11
developing tank, multi-unit ~
116 3
developing tank
(thermometer) 116 8
developing tray 116 25
deviation mirror 113 11
device 252 12
devil 306 14
devil's tail 340 34
devil's tobacco pouch 381 20
devil's wheel 308 46
de-waxing 145 50

dew claw 88 23, 57
dewlap 73 24
dexter 254 18, 20, 22
D (flat major) 320 67
diabetics file 22 26
diacritics 342 30-35
diadem 355 21
diadem, pearl ~ 355 16
diacresis 342 34
diagnostic test bay 195 1-23
diagonal 346 33
diagram *Drawing Off.* 151 11
diagram *School* 260 34
diagram *Univ.* 262 8
dial 204 5; 237 10; 245 16
dial finger plate 237 11
dial finger stop 237 12
dialling unit 237 67
dial wind-up plate 237 11
diameter 346 45
diamond *Composing Rm.* 175
21
diamond *Audio* 241 26
diamond *Crystals* 351 10, 13
diamonds 276 41
diaper, disposable ~ 28 22
diaphragm *Meteorol. Instr.* 10
27
diaphragm *Man* 20 9, 26
diaphragm *Dent.* 24 33
diaphragm *Inf. Tech.* 242 82
diaphragm, bladed ~ 233
diaphragm chest 326 12-14
diaphragm spring 190 29
diathermy unit 23 22
diaz plate 179 32, 34
dibber 54 7; 56 1
dibble 54 7; 56 1
dice 276 29, 31
dice cup 47 42; 276 30
dicing 276 29
dictating machine 22 27; 209
30; 246 17; 248 34
dictating machine, pocket-
sized ~ 246 32
dictionary 262 17
dictionary, medical ~ 22 22
didelphid 366 2
Didone 342 6
die *Metalwks.* 140 32
die *Brickwks.* 159 13
die, lower ~ 252 41
die, steel ~ 175 36
die, upper ~ 252 40
die and stock 140 32
die blank 175 35
die block, lower ~ 139 14, 39
die block, upper ~ 139 13, 38
die case 174 42, 46
die head 143 57
diesel-electric drive 223
68-74; 259 75
diesel engine *Energy Sources*
155 5
diesel engine *Intern.
Combust. Eng.* 190 4
diesel engine *Railw.* 211 47;
212 25, 51
diesel engine *Ship* 223 73
diesel engine, auxiliary ~ 209
19

diesel engine, eight-cylinder ~ 212 73
 diesel engine, five-cylinder in-line ~ 190 3
 diesel engine, four-cylinder ~ 65 44
 diesel engine, six-cylinder ~ *Agr. Mach.* 64 28
 diesel engine, six-cylinder ~ *Railw.* 209 23
 diesel engine, underfloor ~ 209 23
 diesel fuel 146 26
 diesel generator 259 94
 diesel generator unit 209 5
 diesel-hydraulic locomotive 212 1, 24, 47; 213 1
 diesel locomotive 212 1, 68
 diesel locomotive, single-engine ~ 208 1
 diesel locomotives 212 1-84
 diesel oil 145 56
 diesel railcar 208 13; 211 41
 diesel tank 146 13
 diesel trainset 209 1
 die stock 125 27
 diet meal 266 62
 difference 344 24
 differential *Agr. Mach.* 65 32
 differential *Intern. Combust. Eng.* 190 75
 differential *Maths.* 345 13, 14
 differential gear 65 32; 190 75
 differential sign 345 13
 diffuser *Photog.* 114 60
 diffuser *Paperm.* 172 11, 13
 diffuser *Space* 234 15
 diffusing screen 310 38
 digester 172 7
 digger 64 59
 digger, toy ~ 273 65
 digging bucket 200 5
 digging bucket arm 200 4
 digging bucket teeth 200 6
 digging fork 66 22
 Digitalis 379 2
 digital readout *Clocks* 110 2
 digital readout *Optic. Instr.* 112 47
 digitate 370 39
 digitated 370 39
 digitus I 19 52, 64
 digitus II 19 53, 65
 digitus III 19 54, 66
 digitus IV 19 55, 67
 digitus V 19 56, 68
 digitus anularis 19 67
 digitus medius 19 66
 digitus minimus 19 56, 68
 dike 216 34, 39
 dike, main ~ 216 32
 dike batter 216 40
 dike ramp 216 47
 dikereeve 216 46
 dike slope 216 40
 diligence 186 39
 dimension line 151 25
 diminished triad 321 3
 diminuendo 321 32
 dimmer switch 127 17
 dimple 16 16
 dinar 252 28
 diner 207 22-32
 dinghy, inflatable ~ 228 18; 258 82; 278 14; 279 27
 dinghy cruiser 284 61
 dining area 266 73
 dining car 207 22-32
 dining car kitchen 207 33
 dining chair 44 10
 dining compartment 207 32, 77
 dining room 44; 223 44; 267 20
 dining set 42 33-34; 44 1-11
 dining table 42 33; 44 1; 45 1; 46 34
 dinner dress 33 7
 dinner plate 39 42; 44 7; 45 4
 dinner service 44 33
 dinner set 44 33
 diopter control ring 117 15
 dioptic adjustment ring 117 15
 dip, true ~ 12 3
 diploma 106 42
 dipole antenna 230 65
 dipper stick 200 4
 dipstick 190 47
 dipterans 358 16-20
 dipyramid, tetragonal ~ 351 18
 direct current motor 150 9
 direction, negative ~ 347 7
 direction, positive ~ 347 6
 directional antenna *Moon L.* 6 4, 44
 directional antenna *Post* 237 51, 52
 directional antenna assembly 234 64
 directional gyro 230 13
 direction finder, automatic ~ 230 5
 direction finder antenna 223 5
 director 310 40; 316 40
 director of photography 310 44
 directory enquiries 237 33
 directory holder 236 11
 direct-vision frame finder 117 58
 dirndl 31 26
 dirndl, girl's ~ 29 36
 dirndl apron 31 31
 dirndl blouse 31 29
 dirndl dress 31 26
 dirndl necklacc 31 28
 disc *Flat* 46 15
 disc *Agr. Mach.* 65 83
 disc *Disco* 317 24
 disc, adhesive ~ 364 26
 disc, carborundum ~ 24 35
 disc, facial ~ 362 18
 disc, germinal ~ 74 65
 disc, insertable ~ 115 96
 disc, metal ~ 309 15
 disc, plain ~ 65 84
 disc, revolving ~ 275 31
 disc, serrated-edge ~ 65 85

disc, silver ~ 10 24
 disc, solar ~ 4 36
 disc barbell 299 3
 disc brake *Intern. Combust. Eng.* 190 74
 disc brake *Car* 191 17-18; 192 48-55
 disc brake *Railw.* 208 4
 disc brake, front ~ 189 32
 disc brake calliper 189 33
 disc clutch 139 21
 disc coultter drive 64 68
 disc fibula 328 30
 discharge, pneumatic ~ 213 18
 discharge connection valve 213 21
 discharge conveyor 64 83
 discharge door 139 2; 213 25
 discharge flap 213 25
 discharge flume 91 41
 discharge opening *Forging* 139 2
 discharge opening *Sawmill* 157 56
 discharge opening *Hydr. Eng.* 217 56
 discharge pipe 64 37
 discharge structure 217 44
 discharging chute 147 39
 discharging position 147 58
 disc jockey 317 25
 discomedusa 357 14
 discotheque 317
 disc pack 176 34
 disc slot 243 38
 disc stack 176 34
 disc store 244 1
 discussion tube arrangement 112 22
 disc wheel 191 14
 disgorgers 89 40
 disguise 306 6-48
 dish 332 50
 dish, three-compartment 40 8
 dish drainer 39 33
 dish rack 39 41
 dish thermometer 116 13
 dishwasher 39 40
 dishwashing machine 39 40
 disinfectant powder 83 60
 disintegrator 172 5
 disk *see* disc
 dislocation 11 50
 dispenser 22 64
 displacement 11 50
 displacement boats 286 32-37
 display 47 30; 271 67
 display, digital ~ *Clocks* 110 20
 display, digital ~ *Optic. Instr.* 112 47
 display, individual ~ 242 3
 display, visual ~ *Railw.* 211 34
 display, visual ~ *Broadcast.* 238 2, 43
 display cabinet 44 26; 46 9
 display cabinet unit 42 5
 display case 271 13

display counter 99 10
 display pipes 326 1-3
 display window, indoor ~ 271 13
 dissecting bench 261 22
 dissolver 172 37
 dissolving tank 172 37
 distance 346 5
 distance-measuring instrument 112 70
 distance piece *Bees* 77 41
 distance piece *Bldg. Site* 119 81
 distance scale 115 4
 distance setting 114 28; 117 3
 distance-setting ring 114 39; 115 8
 distant signal identification plate 203 24
 distillation 170 17
 distillation, gradual ~ 170 4
 distillation apparatus 350 46
 distillation column 145 37, 49
 distillation flask 350 47, 50
 distillation plant 145 66
 distillation product, heavy ~ 145 40
 distillation product, light ~ 145 39
 distilling apparatus 350 46
 distilling flask 350 47, 50
 distributary 32
 distributing machine 236 38
 distributing mechanism 174 20
 distributing pipe 126 8
 distributing roller 181 7, 62; 249 51
 distribution board 157 67
 distribution main 269 22
 distribution pipe, main ~ 38 71
 distribution steel 119 69
 distributor *Composing Rm.* 174 20
 distributor *Letterpress* 181 7, 62
 distributor *Intern. Combust. Eng.* 190 9, 27
 distributor *Office* 249 51
 distributor cylinder 62 23
 distributor roller 181 7, 62
 distributor shaft 190 27
 distributor unit 62 22
 district boundary 15 103
 district heating main 198 28
 ditch 329 33, 37
 ditch fern 377 16
 divan, double ~ 43 4-13
 diver 282 5
 dividend 344 26
 dividend coupon 251 18
 dividend coupon sheet 251 17
 dividend warrant 251 18
 divider *Agr. Mach.* 64 1
 divider *Bakery* 97 56
 divider and rounder 97 63
 dividing 344 26
 dividing breeching 270 32
 diving, acrobatic ~ 282 40-45

diving, competitive ~ 282 40-45
 diving, fancy ~ 282 40-45
 diving apparatus 279 12, 19; 282 5-10
 diving board 282 9
 diving boards 282 5-10
 diving goggles 280 38
 diving mask 279 10
 diving plane, aft ~ 259 95
 diving platform 282 6
 diving pool 282 11
 division *Navig.* 224 89
 division *School* 260 39
 division *Maths.* 344 26
 division sign 344 26
 divisor 344 26
 D major 320 57
 D minor 320 63
 Doberman terrier 70 27
 dock *Horse* 72 34
 dock *Shipbuild.* 222 36-43
 dock, emptied ~ 222 43
 dock, floating ~ *Shipbuild.* 222 34-43, 41
 dock, floating ~ *Docks* 225 16
 dock area 225 1
 dock basin 222 36
 dock bottom 222 31
 dock crane 222 34
 dock floor 222 31
 dock gate 222 32
 docking a ship 222 41-43
 docking hatch 6 45
 docking target recess 6 47
 docks 225; 226
 dockside crane 222 34
 dock structure 222 37-38
 dockyard 222 1-43
 doctor 22; 23
 'doctor' *Airport* 233 44
 doctor blade 168 44
 document 245 19
 document, confidential ~ 246 25
 document file 245 6; 247 37; 248 5
 document glass 249 39
 dodecahedron, pentagonal ~ 351 8
 dodecahedron, rhombic ~ 351 7
 dodgem 308 62
 dodgem car 308 63
 dodger 223 17
 doe *Dom. Anim.* 73 18
 doe *Game* 88 40, 59
 doe, barren ~ 88 34
 doe, young ~ 88 39
 doffer 163 42
 doffer comb, vibrating ~ 163 39
 dog *Dom. Anim.* 73 16
 dog *Game* 88 42
 dog *Bldg. Site* 119 58
 dog *Roof* 121 97
 dog *Intern. Combust. Eng.* 190 39
 dog, three-headed ~ 327 30
 dog, toy ~ 47 7, 41
 dog biscuit 99 37

dog bowl 70 32
 dog brush 70 28
 dogcart 186 18
 dog comb 70 29
 dog flange 190 39
 dog food 99 36
 dog lead 70 30
 dog rose 373 26
 dogs *Dog* 70
 dogs *Forging* 139 33
 dog sled 353 3
 dog sledge 353 3
 Dog Star 3 14
 dog tick 358 44
 do-it-yourself 134
 do-it-yourself enthusiast 134 61
 do-it-yourself work 134 1-34
 doldrums 9 46
 dolina 13 71
 doll 309 11
 doll, sleeping ~ 47 11
 doll, walking ~ 273 63
 dollar 252 33
 doll's pram 47 10; 48 24
 dolly *Flea Market* 309 68
 dolly *Films* 310 49
 dolmen 328 16
 dolphin 225 12
 dolphin butterfly stroke 282 35
 dome *Brew.* 92 45
 dome *Art* 337 21
 dome, high ~ 36 79
 dome, imperial ~ 121 25
 dome, main ~ 334 72
 dome, revolving ~ 5 12
 dome cover 38 48
 dome shutter 5 14
 dome system 334 72-73
 domiciliation 250 22
 dominant seventh chord 321 5
 domino *Games* 276 34
 domino *Carnival* 306 13, 15
 dominoes 276 33
 domino panel 203 66
 donjon 329 4
 donkey 73 3
 door *Farm Bldgs.* 62 17
 door *Carriages* 186 11
 door *Tram* 197 32
 door *Railw.* 207 20, 22
 door, bottom ~ 210 7
 door, double ~ *Tram* 197 14
 door, double ~ *Railw.* 208 7
 door, double ~ *Hotel* 267 27
 door, driver's ~ 193 2
 door, folding ~ *Tram* 197 14
 door, folding ~ *Railw.* 207 39; 208 7
 door, front ~ *Dwellings* 37 65
 door, front ~ *Hall* 41 25
 door, front ~ *Household* 50 30
 door, front ~ *Floor etc. Constr.* 123 24
 door, front ~ *Car* 193 5
 door, glass ~ 44 18
 door, hinged ~ 194 12
 door, ledged ~ 37 34
 door, main ~ *Church* 331 16

door, main ~ *Art* 335 24
 door, outer ~ 259 78
 door, outward-opening ~ 194 35
 door, rear ~ *Car* 193 3, 6, 20
 door, rear ~ *Lorries etc.* 194 11
 door, revolving ~ 213 9
 door, side ~ *Lorries etc.* 194 8, 12
 door, side ~ *Railw.* 213 9
 door, sliding ~ *Farm Bldgs.* 62 16
 door, sliding ~ *Brew.* 92 47
 door, sliding ~ *Lorries etc.* 194 8
 door, sliding ~ *Railw.* 213 15
 door, vertical-lift ~ 139 51
 doorbell 127 2
 door frame 41 26
 door handle *Hall* 41 28
 door handle *Carriages* 186 12
 door handle *Car* 191 5
 door-lifting mechanism 139 55
 door lock *Hall* 41 27
 door lock *Metalwkr.* 140 36-43
 door lock *Car* 191 6
 doorman 267 1; 271 44
 dormer 37 56; 38 7; 121 6; 329 11; 336 4
 dormer window 37 56; 38 7; 121 6; 329 11; 336 4
 dormer window, hipped ~ 121 13
 dorsum manus 19 83
 dorsum of the foot 19 61
 dorsum of the hand 19 83
 dorsum pedis 19 61
 dosimeter 2 8-23
 dosing mechanism 83 60
 dossier 78 15
 dossier carrier 78 14
 dot 178 39
 dot, French ~ 102 13
 dot ball, white ~ 277 13
 double 276 35
 double backward somersault 282 42
 double bass 323 23
 double bassoon 323 28
 double bass viol 322 23; 323 23
 double bull capital 333 28
 double bull column 333 23
 double edger 157 57
 double flat 320 53
 double-lap roofing 122 2
 double leg circle 296 54
 double leg lock 299 11
 double mill 276 25
 double overarm stroke 282 37
 doubles 293 2-3
 doubles, mixed ~ 293 49
 double sharp 320 51
 doubles match 293 2-3
 doubles sideline 293 2-3
 doublet, padded ~ 355 30, 45
 doublet, paned ~ 355 33
 doublet, quilted ~ 355 45

doublet, short ~ 355 41, 45
 doublet, slashed ~ 355 33
 doublet, stuffed ~ 355 30
 double-three 302 14
 double unit for black 180 12-13
 double unit for cyan 180 8-9
 double unit for magenta 180 10-11
 double unit for yellow 180 6-7
 double-whole note 320 12
 doubling frame 164 57
 doubling of slivers 164 5
 dough mixer 97 55, 59
 doughnut 97 29
 douze dernier 275 27
 douze milieu 275 26
 douze premier 275 25
 dovetail halving 121 89
 dowel hole 120 22, 23
 dowel hole borer 133 6
 dowel hole boring machine 133 6
 down-draught carburettor 192 1-15
 down-gate 148 21
 downhill racing 301 32
 downhill racing pole 301 25
 downhill racing position 301 33
 downhill ski 301 34
 downpipe 37 13; 38 10; 122 29; 147 63
 downspout 37 13; 38 10
 downtake 147 13
 down-town 268
 down tube 187 17
 downy mildew 80 20, 21
 drachma 252 39
 Draco 3 32
 draft 92 50
 draft see draught
 draft *Weaves* 171 4, 11, 13, 19, 21, 27
 draft *Bank* 250 12
 draft, rough ~ 338 4
 draft board 168 7
 draft clause 250 17
 drafting 164 12, 13
 drafting machine 151 2
 drafting roller 164 21, 22, 29
 draft mark 222 73
 drag *Iron Foundry etc.* 148 20
 drag *Equest.* 289 48
 drag chute housing 257 24
 drag hook *Horse* 71 14
 drag hook *Fire Brig.* 270 49
 drag hunt 289 41-49
 drag lift 214 15
 Dragon *Astron.* 3 32
 dragon *Sailing* 284 57
 dragon *Fabul. Creat.* 327 1, 50
 dragon, seven-headed ~ 327 50
 dragon beam 120 42
 dragon figurehead 218 16
 dragonfly 358 3
 dragon piece 120 42
 dragon ship 218 13-17
 drain *Street Sect.* 198 23

drain *Rivers* 216 37
 drain *Town* 268 8
 drainage 144 46
 drainage basin 12 24
 drainage ditch *Road Constr.* 200 63
 drainage ditch *Rivers* 216 33
 drainage layer 199 25
 drainage sluice 216 34
 drainage tube 26 47
 drain cock 178 34
 drain cover 198 24
 drain pipe 198 25; 199 26
 drain plug 284 36
 drake 73 35
 drapery 338 33
 draught beam 65 18
 draughtboard 276 17
 draught mark 222 73
 draughts 276 17-19
 draughtsman 276 18, 19
 drawbar 64 47, 61; 65 18
 drawbar coupling *Agr. Mach.* 65 30
 drawbar coupling *Camping* 278 55
 drawbar frame 65 26
 drawbar support 64 62
 drawbar trailer 194 22
 drawbench 108 2
 drawbridge 329 25
 draw cord 29 67
 draw curtain 315 1
 drawee 250 20
 drawer *Dent.* 24 17
 drawer *Hall* 41 9
 drawer *Bedrm.* 43 18
 drawer *Flat* 46 11
 drawer *Bathrm. etc.* 49 34
 drawer *Bank* 250 21
 draw frame 164 1
 draw frame, four-roller ~ 164 9
 draw frame, simple ~ 164 9
 draw frame cover 164 7
 draw hoe 66 1
 draw hook 270 49
 drawing *Drawing Off.* 151 16
 drawing *Synth. Fibres* 170 55
 drawing, final ~ 170 47
 drawing, preliminary ~ 170 45
 drawing, rolled ~ 151 10
 drawing bench 108 2
 drawing board 151 1
 drawing board adjustment 151 5
 drawing easel 338 34
 drawing floor 120 11
 drawing head 151 4
 drawing ink cartridge 151 36
 drawing ink container 151 63
 drawing-in roller 168 12
 drawing knife 120 79
 drawing machine 162 7
 drawing office 151
 drawing pen, tubular ~ 151 37, 38
 drawing roll 162 11
 drawing table 151 6
 draw-in wire 127 30

drawknife 120 79
 draw-off tap 126 34
 drawshave 120 79
 draw stop 325 44; 326 6
 drawstring 29 64, 67
 drawstring waist 31 66
 draw well 329 3
 draw wire 127 30
 draw works 145 11
 dredger 216 56; 226 41
 dredger, hydraulic ~ 216 59
 dredger bucket 226 44
 dredging bucket 216 58
 dredging machine, floating ~ 216 56
 dress 31 9
 dress, button-through ~ 30 10
 dress, jersey ~ 29 28
 dress, knitted ~ 29 28; 30 33
 dress, off-the-peg ~ 271 29
 dress, peasant-style ~ 30 27
 dress, ready-made ~ 271 29
 dress, ready-to-wear ~ 271 29
 dress, shirt-waister ~ 30 10
 dress, two-piece ~ 30 33; 31 11
 dress, wrap-around ~ 30 25
 dress, wrapover ~ 30 25
 dressage 289 1-7
 dressage arena 289 1
 dress and jacket combination 31 6
 dress circle 315 18
 dress form 103 6
 dress guard 104 14
 dressing, sterile gauze ~ 21 6
 dressing axe 158 38
 dressing comb 105 15; 106 28
 dressing floor 92 8
 dressing gown 29 24; 32 35
 dressing machine 83 52
 dressing material 26 34
 dressing room 315 43-52
 dressing room mirror 315 43
 dressing stool 43 24
 dressing table 43 25; 105 19
 dressing-table mirror 43 29
 dressmaker 103 1
 dress shirt 32 43
 dress sword 355 63
 dribble 291 52
 drier *Synth. Fibres* 170 38
 drier *Paperm.* 173 22
 drier *Offset Print.* 180 14, 27
 drier, swivel-mounted ~ 105 25
 drier felt 173 23
 driers 50 23-34
 drift net fishing 90 1-10
 drill *Dent.* 24 6, 17
 drill *Agr. Mach.* 65 74
 drill *Goldsm. etc.* 108 4
 drill *Turner* 135 22
 drill, electric ~ 56 19; 120 21; 134 16, 50-55
 driller 158 9
 drilling bit 145 21
 drilling cable 145 7
 drilling line 145 7
 drilling machine, electric ~ 108 6

drilling machine, radial-arm ~ 150 18
 drilling machine, suspended ~ 108 6
 drilling pipe 145 19
 drilling platform 146 1-37; 221 66
 drilling rig 145 1; 146 1-39
 drilling vessel, semisubmersible ~ 221 64
 drill pipe 145 6
 drill spindle 150 23
 drill stand 134 54
 drill tower 270 3
 drink, soft ~ 96 30; 99 72
 drinker, mechanical ~ 74 16
 drinking bowl, mechanical ~ 74 16
 drinking fountain 205 33
 drinking straw 266 46
 drinking trough 74 6
 drinking water carrier 278 32
 drinking water supply 269 1-66
 drinking water tank 146 16
 drinks cabinet 246 29
 drinks cupboard 42 20
 drinks gondola 99 71
 drinks shelf 266 59
 drinks stall 308 3
 drip, intravenous ~ 25 13; 26 9
 drip fuel line 190 53
 drip ring 283 40
 dripstone 13 80
 drip tray 266 2
 drive *Composing Rm.* 175 37
 drive *Railw.* 214 2
 drive, clockwork ~ 10 14
 drive, conventional ~ 259 75
 drive, crystal-controlled ~ 310 19, 24
 drive, fluid ~ 65 37
 drive, hydraulic ~ 139 9, 15
 drive, main ~ 214 63
 drive belt 103 10
 drive-belt gear 109 21
 drive chain 188 17
 drive clutch 177 54
 drive connection 67 19
 drive gearbox 163 57; 168 10, 32
 drive mechanism 110 43
 drive motor *Poultry Farm* 74 37
 drive motor *Dressm.* 103 9
 drive motor *Forging* 139 25
 drive motor *Mach. Tools* 150 9
 drive motor *Cotton Spin.* 163 12, 23, 49
 drive motor *Text. Finish.* 168 55
 drive motor *Composing Rm.* 175 61
 drive motor *Electrotyp. etc.* 178 12, 28
 drive motor *Offset Platem.* 179 11
 drive motor *Hydr. Eng.* 217 47

drive pulley, fast-and-loose ~ 163 50
 drive pulley, main ~ 163 50
 driver *Carriages* 186 32
 driver *Bicycle* 187 72
 driver *Serv. Stat.* 196 8
 driver *Ship* 219 30
 driver *Equest.* 289 26
 driver *Ball Games* 293 91
 driver plate 149 55
 driver's brake valve 210 53; 211 22; 212 11
 driver's position *Agr. Mach.* 64 33
 driver's position *Tram* 197 25
 drive shaft *Car* 192 30
 drive shaft *Hydr. Eng.* 217 49
 drive unit *Shoem.* 100 8
 drive unit *Photomech. Reprod.* 177 56
 drive unit, central ~ 238 57
 drive well 269 60
 drive wheel *Agr. Mach.* 65 80
 drive wheel *Shoem.* 100 8
 drive wheel *Text. Finish.* 168 4
 drive wheel *Offset Print.* 180 66
 drive wheel *Army* 255 50
 drive wheel unit 209 3
 driving 86 34-39
 driving axle 210 37
 driving axle gearing 64 30
 driving barrel 187 73
 driving cylinder 165 32
 driving drum 165 32, 35
 driving gear *Cotton Spin.* 163 57
 driving gear *Railw.* 210 2-37
 driving guide rail 226 39
 driving pinion 214 8
 driving plate *Turner* 135 9
 driving plate *Mach. Tools* 149 55
 driving shaft 163 24
 driving trailer car 211 62
 driving unit 209 2
 driving wheel tyre 64 31
 drizzle 9 33
 drone *Bees* 77 5
 drone *Music. Instr.* 322 11
 drone cell 77 36
 drone pipe 322 11
 drone string 322 31
 droop flap 229 54
 droop nose 231 16
 drop 98 76
 drop, plain ~ 36 85
 drop board 267 5
 drop cloth 316 11
 drop compass 151 59
 drop forging 139
 drop grate 210 5
 drop grate lever 210 40
 drop hammer, air-lift ~ 139 24
 drop hammer, short-stroke ~ 139 11
 drop net 89 29
 drop pin 165 37
 droppings removal 74 23-27

dropping worm 149 18
 drop pin roller 165 39
 drop windscreen 255 97
 drop windshield 255 97
 drop wire 166 34
 drop worm 149 18
 drove 158 37
 drove chisel 158 37
 'druggist' 233 45
 drum *Meteorol. Instr.* 10 5, 16, 20
 drum *Household* 50 29
 drum *Agr. Mach.* 64 12
 drum *Painter* 129 9
 drum *Cooper* 130 13
 drum *Nucl. Energy* 154 77
 drum *Nightclub* 318 10
 drum *Music. Instr.* 323 57
 drum *Art* 335 44
 drum, hollow ~ 312 49
 drum, lansquenets ~ 306 70
 drum, revolving ~ 273 45
 drum brake 188 36
 drum brake, front ~ 189 11
 drum brake, rear ~ 189 13
 drum head 323 52
 drum kit 324 47-54
 drummer 318 11
 drum of paint 129 9
 drums 324 47-54
 drum set 324 47-54
 drumstick *Supermkt.* 99 59
 drumstick *Music. Instr.* 323 54
 drumstick *Ethnol.* 354 19
 drupe 59 41, 43, 49; 370 99; 382 51; 384 40
 drupes 59 59, 1-36
 dryas 51 7
 dry bulb thermometer 10 34
 dry cell battery 127 27
 dry cooling tower 154 39
 dry dock 222 31-33; 225 17
 drying 169 24; 170 58
 drying cabinet 116 23
 drying chamber 170 49
 drying cylinder 165 50, 53; 173 22
 drying cylinder, heated ~ 173 33
 drying floor 92 16
 drying kiln 92 29
 drying machine 169 31
 drying rack *Agr.* 63 28, 29
 drying rack *Flea Market* 309 49
 drying section 168 28
 drying shed 159 17
 dry-seed dressing 83 52
 dry zone, equatorial ~ 9 54
 D sharp minor 320 61
 dual film-tape recording 117 70
 dual film-tape reproduction 117 75
 dual film-tape system 117 7
 dubbing *Films* 311 1-46, 37-41
 dubbing *Chivalry* 329 66
 dubbing actress 311 39
 dubbing director 311 38

dubbing mixer 311 36
 dubbing room 311 34
 dubbing speaker 311 39
 dubbing studio *Broadcast.* 238 28
 dubbing studio *Films* 311 37
 dubbing theatre *Broadcast.* 238 28
 dubbing theatre *Films* 311 37
 duck 73 35
 duck, toy ~ 49 4; 273 30
 duck, wild ~ 86 41; 272 51
 duck-bill 366 1
 duck hunting 86 40
 ducking 299 29
 duckling 73 35
 duck-mole 366 1
 duck shooting 86 40
 duck's meat 378 35
 duckweed 378 35
 duct 163 11
 duct, cystic ~ 20 38
 duct, hepatic ~ 20 37
 duct, spermatic ~ 20 74
 ductor 181 63
 ductor roller 181 63
 duct roller 181 64
 due date 250 16
 duffle coat 271 21
 dugout 218 7; 354 20
 duk-duk dancer 352 34
 dulcimer 322 32
 Dülfer seat 300 30
 dumb barge 225 8
 dumb barge, tug-pushed ~ 221 94
 dummy *Infant Care etc.* 28 15
 dummy *Store* 271 34
 dummy, dressmaker's ~ 103 6
 dummy bull 319 3
 dummy funnel 221 16
 dump body 194 25; 200 8
 dump car 213 37
 dump chest 172 81
 dumping bucket 214 34
 dumping device 147 44, 59
 dump truck 47 38; 147 64; 200 7
 dump truck, three-way ~ 194 24
 dune, crescentic ~ 13 40
 dune, migratory ~ 13 39
 dune, travelling ~ 13 39
 dune, wandering ~ 13 39
 dune buggy 193 12
 dung 63 15
 dungarees 29 40; 30 21
 dung beetle 358 39
 dungeon 329 5
 dunging, mechanical ~ 74 23-27
 dunging chain 74 27
 dunging conveyor 74 27
 dung tank 221 72
 dunnage 222 62u.63
 duodenum 20 14, 43
 duplet 321 23
 duplicate list 263 27
 duramen 120 84; 370 13
 dust, fine ~ 158 22
 dust, lunar ~ 6 14

dust bag container 50 62
 dustbin 199 3
 dustbin-tipping device 199 2
 dust brush 109 18
 dust cap 187 57, 82
 dust catcher *Goldsm. etc.* 108 45
 dust catcher *Iron & Steel* 147 14
 dust-collecting chamber 163 11
 dust-collecting machine 147 14
 dust collector *Goldsm. etc.* 108 45
 dust collector *Cement Wks.* 160 7
 dust collector *Refuse Coll.* 199 47
 dust container 50 86
 dust counter 112 42
 dust cover *Bookbind.* 185 37
 dust cover *Audio* 241 32
 dust cover *Store* 271 30
 dust discharge flue 163 22
 dust escape flue 163 22
 dust exhauster 108 43
 dust extraction fan 163 10
 dust extractor 92 40; 172 1
 dust filter 270 59
 dust hood 133 20
 dust jacket 185 37
 dust pan 50 52; 260 60
 dust removal fan 83 53
 dust removal screen 83 56
 dust-settling chamber 172 6
 dust shield 2 48
 Dutch clover 69 2
 'duty free shop' 233 52
 duty presentation officer 238 22
 duvet, quilted ~ 43 8
 dwale 379 7
 dwarf 308 22
 dwarf French bean 57 8
 dwarf pine 372 21
 dwelling 37
 dwelling, lacustrine ~ 328 15
 dye liquor padding trough 165 47
 dye spray 100 35
 dyke *see* dike
 dynamo 187 8
 dynastarter 209 13

E

Eagle 3 9
 eagle fern 377 16
 eagle owl *Hunt.* 86 48, 51
 eagle owl *Birds* 362 15
 eagles 362 5-9
 ear *Man* 16 18
 ear *Arable Crops* 68 2
 ear *Dog* 70 2
 ear *Horse* 72 1
 ear *Dom. Anim.* 73 11
 ear *Game* 88 16, 32, 44, 61
 ear *Music. Instr.* 326 32
 ear *Birds* 362 16

ear, external ~ 17 56-58
 ear, feathered ~ *Game* 88 78
 ear, feathered ~ *Birds* 362 16
 ear, internal ~ 17 62-64
 ear, middle ~ 17 59-61
 earcup 241 69; 261 40
 earflap 35 31
 earlobe 17 57
 earmuff 304 28
 earphone *Hairst. etc.* 34 38
 earphone *Audio* 241 69
 earphone *Office* 248 35; 249 63
 earphones 34 37
 earphone socket *Cine Film* 117 10
 earphone socket *Office* 249 68
 ear piece *Forestry* 84 23
 earpiece *Post* 237 8
 earplug 354 30
 earrings 36 13
 earrings, drop ~ 36 11
 earrings, pendant ~ 36 11
 earth 4 8, 30
 Earth 4 45
 earth 6 17
 earth, composted ~ 55 15
 earth, excavated ~ 118 78
 earth, prepared ~ 55 15
 earth core 11 5
 earthing button 237 21
 earthing clamp 142 35
 earth moth 80 42
 earthquake 11 32-38
 earthquake, submarine ~ 11 53
 earthquake focus 11 32
 earth station 237 51
 earthworm 357 24
 earthworm, artificial ~ 89 67
 ear tuft 362 16
 earwig 81 11
 easel 116 35
 easel, folding ~ 338 26
 East Australian Current 14 38
 Easter candle 330 44
 Easter candlestick 330 45
 easterlies 9 48, 49
 Eastern cut-off 298 21
 Eastern roll 298 15
 east point 4 14
 easy chair 336 18
 eaves 38 11; 121 4; 122 36
 eaves, rafter-supported ~ 37 9
 eaves course 122 49, 76
 eaves fascia 122 42
 eaves joint 122 76
 E-boat 258 69, 75
 écarté 314 15
 ECG 23 28
 ECG amplitude 25 49
 ECG analyser 25 45
 ECG analysis 25 50
 ECG impulse 25 46
 ECG lead 25 43
 ECG machine, portable ~ 23 46
 ECG monitor 25 2, 21, 28, 47
 ECG recorder 25 41
 ECG recording unit 25 27

ECG rhythm 25 48
 E-channel 143 7
 echinoderm 369 3, 11, 17, 18, 19
 echinoderms 357 38-39
 Echinops 53 14
 echinus 334 21
 Echiostoma 369 13
 echo 224 63
 echo chamber 311 31
 echo chamber loudspeaker 311 32
 echo chamber microphone 311 33
 echogram 224 67
 echograph 224 24, 65
 echo receiver 224 64
 echo recorder 224 24
 echo signal 224 63
 echo sounder 224 61-67
 echo sounding machine 224 61-67
 echo sounding machine recorder 224 65
 eclipse 4 33
 eclipse, lunar ~ 4 29-35, 34-35
 eclipse, solar ~ 4 29-35, 32, 39, 41
 ecliptic 3 2; 4 22
 economizer *Power Plant* 152 26
 economizer *Railw.* 210 23
 Edam cheese 99 42
 edelweiss 378 9
 edge *Tablew. etc.* 45 57
 edge *Forestry* 85 2
 edge *Winter Sp.* 302 21
 edge *Maths.* 347 32
 edge, aluminium ~ 301 51
 edge, front ~ 122 88
 edge, hidden ~ 151 24
 edge, matching ~ 128 21
 edge, non-matching ~ 128 22
 edge, razor's ~ 106 40
 edge, steel ~ 301 4, 50
 edge, upper ~ 301 51
 edge, visible ~ 151 23
 edge board, lower ~ 118 74
 edge board, upper ~ 118 73
 edge mill 159 8
 edge of platform 205 19
 edge of pool 281 3
 edge runner mill 159 8
 edge sander 133 12
 edge-sanding machine 133 12
 edge-veneering machine 133 26
 edging *Flower Gdn.* 51 15
 edging *Optics.* 111 35
 edging, concrete ~ 52 20
 edging, hoop ~ 55 38
 edging machine 111 24
 editing 311 42-46
 editing table 117 96; 311 42
 editorial 342 48
 EDP print-out 248 47
 education, nursery ~ 48 1-20
 education, pre-school ~ 48 1-20
 eel 364 17

eel hook 89 87
 effacé 314 13
 efflux viscometer 129 38
 E flat major 320 65
 E flat minor 320 68
 egg *Man* 20 84
 egg *Poultry Farm* 74 58
 egg *Bees* 77 26, 27
 egg *Gdn. Pests* 80 15, 55
 egg *Forest Pests* 82 19
 egg *Supermkt.* 99 50
 egg *Articulates* 358 49
 egg and anchor cyma 334 42
 egg and dart cyma 334 42
 egg and tongue cyma 334 42
 egg box 74 42, 45
 egg collection 74 22, 34
 egg collection system 74 34
 egg-counting board 89 19
 egg gallery 82 23
 egg integument 74 59
 egg-packing machine, fully automatic ~ 74 46
 egg position 301 33
 egg production 74 34-53
 eggshell 74 59
 egg timer 110 31
 egg weigher 74 43
 Egyptian 342 8
 eight 283 10
 eighth note 320 16
 eighth rest 320 24
 ejection seat 257 6, 7
 ejector seat 257 6, 7
 E-layer 7 27
 elbow *Man* 16 45
 elbow *Overh. Irrign.* 67 6
 elbow *Horse* 72 20
 elbow *Winter Sp.* 301 70
 elbow boot 289 31
 elbow coupling 126 40
 elbow joint 126 51, 52
 elbow pad 303 16
 elbow screw joint 126 40, 45
 elbow snips 125 2
 elder 374 35
 elderberry 374 37
 elder flower 374 36
 election 263 16-30
 election meeting 263 1-15
 election officer 263 17
 election regulations 263 25
 election speaker 263 5
 election supervisor 263 28
 elector 263 24
 electoral register 263 18
 electric action organ 326 36-52
 electrical fitter 127 1
 electrical point 261 12
 electrical socket 261 12
 electrical system bus 235 55
 electric engine room 223 68
 electrician 127 1
 electricity cable 198 14, 19
 electricity meter 127 32
 electricity meter cupboard 127 31
 electricity transmission line 15 113
 electric light bulb 127 56

electric power plant 152 1-28
 electrocardiogram monitor 25 2, 21, 28
 electrocardiograph 23 28; 25 41
 electrode *Hosp.* 25 26, 35, 38
 electrode *Slaughterho.* 94 8
 electrode *Arc Weld.* 142 10
 electrode *Iron & Steel* 147 52
 electrode, central ~ 2 3
 electrode, platinum-iridium ~ 24 44
 electrode, strap-on ~ 23 30
 electrode arm 142 24
 electrode case 142 7
 electrode exit point 25 34
 electrode holder 142 9, 20
 electrode lead 25 25
 electrode-pressure cylinder 142 26
 electromagnet 237 47
 electron 1 3, 17, 27, 32
 electron, free ~ 1 25
 electron beam 240 16
 electron gun 113 31
 electron gun assembly 240 24
 electronic circuits 242 68-72
 electronics, remote ~ 112 53
 electronics cabinet 177 69
 electron microscope 113 30
 electron shell 1 6, 8
 electron spin 1 4
 electroplating bath 178 4
 electroplating tank 178 4
 electroplating vat 178 4
 electrotome 22 38
 electrotype, curved ~ 178 21
 electrotyping 178
 electrotyping plant 178 1-6
 element, electronic ~ 242 69
 element, fissionable ~ 1 49
 element, front ~ 115 7
 element, fusible ~ 127 36
 element, oscillating ~ 110 9
 element of set 348 2
 elephant 366 20
 elephant, toy ~ 47 6
 elephant enclosure 356 9
 elephant house 356 10
 elevating conveyor 200 49
 elevating drum, rotary ~ 64 74
 elevating gear 255 67
 elevating piston 255 51
 elevation, front ~ 151 17
 elevation, side ~ 151 18
 elevator *Offshore Drill.* 146 8
 elevator *Synth. Fibres* 170 36
 elevator *Aircraft* 229 27; 230 63
 elevator *Air Force* 257 22
 elevator *Store* 271 45
 elevator *Airports* 288 24
 elevator *Theatre* 316 33, 34
 elevator, chain and slat ~ 64 7
 elevator, open-web ~ 64 69
 elevator bridge 226 25
 elevator car 271 46
 elevator carrier 174 22
 elevator controls 271 48
 elevator operator 271 47

elevator shaft *Offshore Drill.* 146 20
 elevator shaft *Store* 271 51
 elevon section, movable ~ 235 33
 elevon structure, heat-resistant ~ 235 34
 elk 367 1, 2
 ellipse 347 22
 ellipse template 151 71
 ellipsis 342 29
 ellipsoid of revolution 347 42
 elm tree 371 49
 elytron 82 10; 358 36
 E major 320 59
 embankment *Map* 15 104
 embankment *Refuse Coll.* 199 14
 embankment *Rivers* 216 49
 embossing platen 183 29
 embrace 205 53
 embrasure 329 18
 embroidery 29 29; 30 42; 355 67
 embryo *Arable Crops* 68 16
 embryo *Bot.* 370 86
 embryo *Trop. Plants* 382 21
 embryo *South. Fruits* 384 22
 embryo plant 68 14
 embryo sac 370 64
 emergency brake 214 3, 71
 emergency brake valve 210 57
 emergency cable 214 47
 emergency-cable tensioning mechanism 214 48
 emergency crash barrier 259 17
 'emergency exit' *Airport* 233 41
 emergency exit 307 33; 312 7
 emergency flare stack 146 11
 emergency lighting 312 6
 emergency telephone 237 4
 emery paper 135 25
 eminence, frontal ~ 16 4
 eminence, thenar ~ 19 75
 E minor 320 56
 emission control 190 73
 Emmental cheese 99 41
 empennage shapes 229 23-36
 Empire table 336 16
 empress, Byzantine ~ 355 15
 emptying system, dust-free ~ 199 2
 em rule 342 23
 emu 359 1
 emulsion 129 4
 emulsion paint 129 4
 emulsion paste 128 28
 emulsion tube 192 10
 enamel 19 30
 enamelling 260 62
 enamelling stove, electric ~ 260 63
 enamel powder 260 65
 enclaving hammer 108 41
 enclosing wall 356 4
 enclosure, outdoor ~ 356 1
 enclosure wall 329 15
 encyclopaedia 42 18; 262 17
 end *Baskeim.* 136 23

end *Mach. Parts etc.* 143 23
 end, hipped ~ 122 10
 end, partial-hipped ~ 121 17
 end, round ~ 143 50
 end, rounded ~ 143 20
 end, west ~ 335 22
 end frame, hemispherical ~ 235 48
 end-grain block 340 1
 endive 57 39
 endive leaf 57 39
 endleaf 185 49
 end line 292 36
 end mill 150 43
 end moraine 12 55
 endorsee 250 26
 endorsement 250 25
 endorser 250 27
 endpaper 185 49
 end pier 215 27
 end plate 229 33
 end rib, hemispherical ~ 235 48
 end ring 89 52
 end support 150 40
 end switch 241 60
 endurance competition 289 16
 energy 1 55
 energy, solar ~ 155 17-36
 energy level 1 15, 27
 energy sources 155
 energy system 6 6, 8
 engagement 294 46
 engine *Moon L.* 6 30
 engine *Oil, Petr.* 145 12
 engine *Aircraft* 231 26
 engine *Airports* 288 35
 engine, air-cooled ~ 188 7; 189 3, 50
 engine, auxiliary ~ *Ship* 223 71
 engine, auxiliary ~ *Aircraft* 231 33
 engine, eight-cylinder ~ 190 1
 engine, four-cylinder ~ 189 50
 engine, four-stroke ~ 189 3, 50
 engine, main ~ *Railw.* 209 4
 engine, main ~ *Ship* 221 81; 223 73
 engine, rear ~ *Garage* 195 49
 engine, rear ~ *Aircraft* 231 10
 engine, side ~ 228 29
 engine, single-cylinder ~ 188 26; 189 3
 engine, twin-shaft ~ 232 51
 engine, two-stroke ~ 188 7, 26; 242 55; 305 92
 engine, water-cooled ~ 189 31, 39
 engine and propeller room 227 22
 engine and transmission control wheel 212 67
 engine compartment 195 35
 engine compartment structure 235 2
 engine control system 235 39
 engine driver 208 2

engineer 208 2
 engineering workshop 222 8
 engineer's brake valve 210 53; 211 22; 212 11
 engine fairing, aerodynamic ~ 234 6
 engine mount 234 21
 engine mounting 190 38; 191 53; 226 58
 engine oil 196 15
 engine oil temperature gauge 212 19
 engine order (telegraph) 224 25
 engine pod 231 26; 256 25
 engine room *Ship* 221 10
 engine room *Fire Brig.* 270 1
 engine room ventilator 212 37
 engine superstructure 226 58
 engine telegraph 224 25
 english *Composing Rm.* 175 29
 English *Billiards* 277 5
 English daisy 376 1
 English hand 342 10
 English ryegrass 69 26
 English setter 70 41
 engraver 340 16
 engraving 36 41
 engraving ball 108 34
 engraving machine 177 52
 engraving system 177 66
 enlarger 116 26
 enlarger head 116 41
 enlarging meter 116 53
 enlarging photometer 116 53
 engrin of head of state 253 14
 ensign staff 223 31; 258 25
 entablature 334 52
 entire 370 43
 entrance 77 48; 99 4; 208 10; 307 19
 'entrance' *Airport* 233 36
 entrance, bullfighters' ~ 319 10
 entrance, main ~ 319 6
 entrance, side ~ 331 15; 335 13
 entrance and exit door 197 14
 entrance hall 41 1-29
 entrance tunnel 353 6
 entrechat 314 22
 entrepôt 225 7
 entry/exit hatch 6 38
 entry hatch 6 10; 235 26
 epaulière 329 44
 épée 294 25-33, 36
 épée, electric ~ 294 26
 épéeist 294 25
 épée point 294 27
 ephemerid 358 6
 epicalyx 58 22
 epicenter 11 33
 epicentre 11 33
 epididymis 20 73
 epistyle 334 18
 equalizer 311 19
 equalizer, universal ~ 238 48
 'equals' key 247 20
 equals sign 344 23
 equation, conditional ~ 345 9

equation, identical ~ 345 5
 equation, simple ~ 345 4
 equator 14 1
 equator, celestial ~ 3 3
 Equatorial Countercurrent 14 33
 equestrian sport 289
 equilibrist 307 48
 equinoxes 3 6-7
 equipment carrier 177 58
 equipment locker 212 35
 equipment section 239 1
 equisetum 376 18
 equitation 71 1-6
 erase head 241 59; 243 20; 311 25
 eraser 151 42
 eraser, glass ~ 151 47
 eraser, pencil-type ~ 151 41
 erasing head 241 59; 243 20; 311 25
 erasing knife 151 43
 erasing knife blade 151 44
 erasing shield 151 35
 erasing table 249 26
 erasion 26 52
 erection shop 222 4
 Ergates faber 358 38
 ergometer, bicycle ~ 23 26
 ergometry 23 26-31
 ergot 68 4
 Eridamus 3 12
 Erlenmeyer flask 173 2; 350 39
 ermine moth 80 5
 erne 362 5
 error indicator 244 7
 eruption 7 21
 escalator 271 22
 escape wheel 110 40
 escapologist 308 28
 escarpment 13 57
 escudo 252 23
 Eskimo 353 1
 Eskimo kayak 283 68
 esophagus 17 49
 espalier 37 33; 52 1, 2, 16, 17, 29
 espalier, free-standing ~ 52 16
 espalier fruit tree 52 1, 2, 16, 17, 29
 esparto grass 136 26
 espresso bar 265 1-26
 esquire 329 68
 estate 193 15
 estate car 193 15
 estoque 319 32
 etchant 178 24; 182 16
 etching 340 14-24
 etching bath 178 31; 340 51
 etching ground 340 55
 etching machine *Electrotyp.* etc. 178 23
 etching machine *Photograv.* 182 15
 etching needle 340 16
 etching solution 178 24; 182 16
 etching tank 178 24, 31; 182 16
 ethmoid 17 39

ethnology 352; 353; 354
 ethylene molecule 242 61
 Eurobottle 93 26
 Europe 14 15
 European silver fir 372 1
 European Southern Observatory 5 1-16
 European toad 364 23
 Euscorpius flavicandus 358 40
 evacuating pump, centrifugal ~ 67 11, 23
 evaporating basin 350 29
 evaporating dish 350 29
 evaporator 155 6
 evening dress 33 13
 evening gown 30 53
 evening sandal 101 27
 evening suit 33 7
 everlasting 377 3
 ever-ready case 115 103
 evolution 345 2
 ewe 73 13; 75 10
 examination couch 22 43; 23 4
 examination table 27 1, 26
 excavation *Bldg. Site* 118 69-82
 excavation *Garage* 195 28
 excavation side 118 72
 excavator 118 76, 81; 200 1
 excavator, large-scale ~ 159 3
 excavator, toy ~ 273 65
 excavator, universal ~ 158 13
 excess water conduit 269 23
 exchange *Post* 237 17, 22
 exchange *Stock Exch.* 251 1-10
 exchange broker 251 4
 exchange floor 251 1
 exchange golf ball 249 28
 exchange hall 251 1
 exchange rate 204 32
 exchange typing element 249 28
 excited state 1 19
 exciter lamp 312 48
 exclamation mark 342 21
 exclamation point 342 21
 exclusion principle 1 7
 excretory vacuole 357 5
 excursion steamer 221 101-128; 225 29
 executive-secretary system 246 13
 exercise book 47 24; 260 4, 18
 exercises 296 48-60
 exergue 252 10
 exhaust *Agr. Mach.* 64 38
 exhaust *Railw.* 209 12, 22
 exhaust, upswept ~ 188 15; 189 15
 exhaust bubbles 279 26
 exhaust casing 212 69
 exhaust escape flue 258 79
 exhaust fan *Brew.* 92 15
 exhaust fan *Joiner* 133 33
 exhaust gas 160 4
 exhaust gas stack 154 37
 exhaust manifold 190 36, 73
 exhaust mast 221 17

exhaust muffler 212 42, 48
 exhaust outlet 259 92
 exhaust pipe *Photograv.* 182 25
 exhaust pipe *Car* 191 51
 exhaust pipe *Ship* 221 76
 exhaust pipe *Warships* 258 44
 exhaust pipe, four-pipe ~ 189 51
 exhaust port 242 58
 exhaust repair 195 52
 exhaust silencer 212 42, 48
 exhaust system 195 51
 exhaust valve 190 46; 242 53
 'exit' *Airport* 233 37
 exit 307 19
 exit, emergency ~ 99 79
 exit gate 319 12
 ex libris 185 51
 exosphere 7 31
 exotic 306 30
 expansion line 1 61
 expansion tank 38 24
 experimental apparatus 261 11
 explosion, atomic ~ 7 11
 exponent 345 1
 exposing lamp 182 3
 exposure bath 228 21
 exposure control device 176 9
 exposure control switch 117 17
 exposure counter 115 17
 exposure meter 114 29
 exposure meter, hand-held ~ 114 56
 exposure meter control step 117 37
 exposure meter needle 115 57
 exposure system 249 42
 exposure time balancing knob 116 39
 exposure timer 116 24; 179 18
 expression marks 321 27-41
 express locomotive 205 35
 express train car 207 1-21
 express train carriage 207 1-21
 express train coach 207 1-21
 express train compartment 207 43
 extension *Joiner* 133 13
 extension *Post* 237 17, 19, 21, 22-26, 26
 extension arm 132 63
 extension bar 151 57
 extension bellows 115 85
 extension cord 127 10
 extension ladder 270 14
 extension lead 127 10
 extension plug 127 11
 extension socket 127 12
 extension tube *Household* 50 70
 extension tube *Photog.* 115 81
 extensor, common ~ 18 57, 63
 extensor, radial ~ 18 56
 extensor carpi radialis longus 18 56

extensor communis digitorum 18 57, 63
 extinguisher, mobile ~ 270 63
 extra 310 29; 316 39
 extra bold 175 9
 extracting a root 345 2
 extraction fan 199 32
 extraction forceps 24 47
 extraction of phenol 170 3
 extraction vent 49 20
 extractor 170 37
 extractor duct, movable ~ 142 15
 extractor fan 133 33
 extractor grid 100 13
 extractor support 142 16
 extradors 336 26
 extremity, fimbriated ~ 20 82
 extrusion press 159 11; 161 7
 eye *Man* 16 7; 19 38-51
 eye *Horse* 72 4
 eye *Dom. Anim.* 73 32
 eye *Game* 88 15, 33, 43, 60
 eye *Fish Farm* 89 82
 eye *Mills* 91 19
 eye *Blacksm.* 137 29
 eye *Weaving* 166 28, 29
 eye *Art* 334 75
 eye, compound ~ *Bees* 77 20-24
 eye, compound ~ *Articulates* 358 7
 eye, simple ~ 77 2
 eye, stalked ~ 357 30
 eyeball 19 45
 eye-bright 61 27
 eyebrow *Man* 19 38
 eyebrow *Roof* 121 23
 eyecup 115 73; 117 14; 313 34
 eyeground 22 32
 eyelash 19 41
 eyelet *Shoem.* 100 63
 eyelet *Glaz.* 124 23
 eyelet *Weaving* 166 28
 eyelet, hook, and press-stud setter 100 53
 eyelet embroidery 102 11
 eyelid, lower ~ 19 40
 eyelid, upper ~ 19 39
 eye muscles 19 44
 eyepiece 113 20; 115 42; 117 14; 311 9
 eyepiece, binocular ~ 23 6
 eyepiece control ring 313 7
 eyepiece focusing knob 112 56
 eyespot 358 54

F

fabled beings 327
 fabric *Bldg. Site* 118 1-49
 fabric *Knitting* 167 29, 48
 fabric *Text. Finish.* 168 39, 51, 64
 fabric *Weaves* 171 29
 fabric *Store* 271 59
 fabric, air-dry ~ 168 22
 fabric, metallic ~ 270 46
 fabric, non-woven ~ 103 27

fabric, printed ~ 168 57
 fabric, raised ~ 168 36
 fabric, shrink-resistant ~ 168 26
 fabric, tubular ~ 167 1, 9
 fabric, woollen ~ *Dressm.* 103 27
 fabric, woollen ~ *Text. Finish.* 168 1
 fabric, woven ~ 166 12
 fabric box 167 10
 fabric container 167 10
 fabric department 271 58
 fabric drum 167 10
 fabric-finishing machine, decatizing ~ 168 49
 fabric for upholstery 134 60
 fabric guide roller 168 5
 fabric-plaiting device 168 30
 fabric-raising machine 168 31
 fabric roll 167 29
 fabric roller 166 20
 fabric shaft 171 21, 23
 fabric wallhanging 128 18
 fabulous creatures 327
 façade, west ~ 335 22
 face *Man* 16 4-17
 face *Horse* 72 5
 face *Clocks* 110 25
 face *Blacksm.* 137 28
 face *Composing Rm.* 174 31; 175 42
 face *Art* 336 24
 face, metal ~ 303 11
 face compress 106 25
 face guard 292 11, 25
 face mask *Fire Brig.* 270 40
 face mask *Swim.* 279 10
 face mask filter 270 57
 face par 251 12
 face pipes 326 1-3
 facet 77 20
 face urn 328 38
 face vault 297 30
 facing 24 32
 facing, decorative ~ 30 47
 facsimile signature 252 34
 facsimile telegraph 245 1
 factor 344 25
 factory number 187 51
 factory ship *Sea Fish.* 90 11
 factory ship *Ship* 221 86
 fahlerz 351 1
 fahl ore 351 1
 fair 308
 fair, annual ~ 308 1-69
 fairground 308 1
 fairing 189 43
 fairing, integrated ~ 189 44
 fairing, metal ~ 188 50
 fairlead 284 29
 fairway 216 21
 fairway, main ~ 224 92
 fairway, secondary ~ 224 93
 fairway markings 224 84-102
 fairway marks 224 68-83
 fair-weather cumulus 8 1
 fairy-tale figure 306 65
 falcon 86 46
 falconer 86 42

falconry 86 42-46
 falcons 362 1-4
 fall 221 106
 falling wedge 85 4
 fallow 63 1
 fallow buck 88 40
 fallow deer 88 40-41
 falls 11 45
 falls, artificial ~ 272 9
 false acacia 371 70
 false oat 69 22
 family grave 331 27
 family tomb 331 27
 fan *Roof & Boilerr.* 38 58
 fan *Agr. Mach.* 64 15; 65 52
 fan *Pest Contr.* 83 49
 fan *Game* 88 75
 fan *Energy Sources* 155 14
 fan *Weaving* 165 23
 fan *Intern. Combust. Eng.* 190 7
 fan *Refuse Coll.* 199 35, 46
 fan *Aircraft* 232 34, 43
 fan *Ethnol.* 353 42
 fan, low-pressure ~ 199 33
 fan blower 179 22
 fan clutch 190 8
 fancy appliqué 35 7
 fancy dress 306 6-48, 32
 fancy-dress ball 306 1-48
 fan drift 144 22
 fan drive, hydrostatic ~ 212 67
 fan fold sheet, continuous ~ 248 47
 fan 19 36
 fan-jet turbine 232 38
 fanlight 37 35
 fan nozzle 83 4
 fan tail 73 29
 fan vault 336 46
 faradization unit 23 37
 farm 15 101
 farm buildings 62
 farmer 62 6
 farmhand 63 5
 farming 63
 farm labourer 63 5
 farmland 63 17
 farm produce 68 1-47
 farm road 63 18
 farmstead 62
 farm track 63 18
 farm vehicle engineering 138
 farmworker 63 5
 farmyard 62 31
 farmyard hedge 62 35
 farmyard manure 63 15
 farrowing and store pen 75 40
 farrowing rails 75 43
 fascia panel 191 57-90
 fascine 216 53
 fashion catalogue 104 6
 fashion doll 47 9; 48 32
 fashion house 268 9
 fashion journal 104 4; 271 36
 fashion magazine 104 4; 271 36
 fast and slow motion switch 117 87
 fastback 193 29

fast breeder 154 1
 fast-breeder reactor 154 1
 fastening *Plant Propagn.* 54 13
 fastening *Station* 206 12
 fat end 95 53
 fat lady 308 21
 fattening pond 89 6
 faucet *Kitch.* 39 36
 faucet *Plumb. etc.* 126 34
 faucet *Electrotyp. etc.* 178 34
 faucet *Chem.* 349 5, 22
 faucet, outside ~ 37 41
 fault *Phys. Geog.* 12 4
 fault *Coal* 144 51
 fault, distributive ~ 12 8
 fault, multiple ~ 12 8
 fault, normal ~ 12 7
 fault-block mountain 12 4-11
 faulting 12 4-20
 fault line 12 5
 fault repair service 237 27
 faults, complex ~ 12 8-11
 fault throw 12 6
 fault trace 12 5
 faustball 293 72-78, 74
 favorite 289 52
 favourite 289 52
 fawn 88 39
 fawn, female ~ 88 34
 F-clef 320 9
 F-contact 115 14
 feather *Headgear* 35 6, 12
 feather *Dom. Anim.* 73 31
 feather *Mach. Parts etc.* 143 73
 feather *Chivalry* 329 78
 feather, falcate ~ 88 68
 feather, peacock's ~ 254 36
 feather star 369 3
 feed *Iron & Steel* 147 51
 feed *Mach. Tools* 149 9
 feed adjustment 100 28
 feed board 180 32, 49, 67; 181 4, 21, 30; 185 9
 feed chain 172 67
 feed chain drive 172 69
 feed channel 157 55
 feed conveyor 236 33
 feed conveyor, endless-chain ~ 74 25
 feed dispenser 74 13
 feed drum 180 33, 34
 feeder *Agr. Mach.* 64 72
 feeder *Poultry Farm* 74 49-51
 feeder *Brickwks.* 159 7
 feeder *Offset Print.* 180 31, 48, 68, 74
 feeder *Letterpress* 181 22, 24
 feeder *Bookbind.* 185 25
 feeder, automatic ~ 181 5
 feeder, mechanical ~ 74 13, 23
 feeder broom 199 44
 feeder mechanism 181 22
 feeder panel 153 4
 feeder-selecting device 167 40
 feeder skip 118 35
 feed gearbox 149 8
 feed gear lever 149 10
 feed guide 184 23

feed hopper *Poultry Farm* 74 24
 feed hopper *Bookbind.* 185 26
 feed-in 173 13
 feed indicator 157 9
 feeding, mechanical ~ 74 23-27
 feeding apparatus 181 22
 feeding bottle 28 19
 feeding bowl 70 32
 feeding-in 164 15
 feeding passage 75 3
 feeding place 86 28
 feeding site 80 50
 feeding trough *Poultry Farm* 74 21
 feeding trough *Livestock* 75 37
 feeding trough, adjustable ~ 74 4
 feed mechanism *Agr. Mach.* 65 78
 feed mechanism *Mach. Tools* 149 18
 feed mechanism *Post* 236 48
 feed mechanism *Graphic Art* 340 33
 feed motor 177 43
 feed pawl 157 44
 feed pipe 96 50
 feed pump *Nucl. Energy* 154 13
 feed pump *Railw.* 210 9
 feed roll 85 19
 feed roller 85 24; 157 4, 40
 feed roller, fluted ~ 163 52
 feed runner 147 22
 feed screw 149 15
 feed setting 100 28
 feed shaft 149 33
 feed spindle 312 36
 feed spool 117 31
 feed sprocket 312 26
 feed supply pipe 74 15
 feed table *Sawmill* 157 63
 feed table *Offset Print.* 180 32, 49, 67
 feed table *Letterpress* 181 4, 21, 30
 feed table *Bookbind.* 184 12, 21; 185 9, 34
 feed-through insulator 153 12, 35
 feed-through terminal 153 12, 35
 feed trip 149 18
 feed tripping device 149 18
 feed valve 210 20
 feedwater heater 210 23
 feedwater line 154 12, 30
 feedwater preheater 210 23
 feedwater steam circuit 154 45
 feedwater tank 152 17
 feedwater tray, top ~ 210 29
 feeler *Agr. Mach.* 64 86
 feeler *Forest Pestis* 82 3
 feeler *Weaving* 166 32
 feeler *Invertebr.* 357 31
 feeler *Articulates* 358 27, 53
 feeler, maxillary ~ 358 42

feeler gauge 140 53
 feeler support wheel 64 88
 feet-first jump 282 13
 felines 368 2-8
 feller 84 20
 felling 84 27
 felling wedge 84 4, 30
 felling wedge, hydraulic ~ 84 25
 felt 173 51
 felt, dry ~ 173 23
 felt nail 122 96
 felt pen 48 18
 felt tip pen 247 11; 260 19
 female, winged ~ 358 21
 femur 17 22
 fence *Joiner* 132 65
 fence *Refuse Coll.* 199 13
 fence *Aircraft* 231 8
 fence *Swim.* 281 17
 fence *Equest.* 289 8
 fence, electrified ~ 62 46
 fence, paling ~ 52 10
 fence, protective ~ 84 7
 fence, stone ~ 337 23
 fence, timber ~ 118 44
 fence, wicker ~ 216 54
 fence, wire ~ 15 39
 fence, wire netting ~ 84 7
 fence, wooden ~ 37 53
 fence adjustment handle 132 66
 fence rack 63 28
 fencers 294 5-6
 fencer's salute 294 18
 fencing 294
 fencing, modern ~ 294 1-33
 fencing glove 294 12
 fencing instructor 294 1
 fencing jacket 294 16
 fencing mask 294 13, 14
 fencing master 294 1
 fencing measure 294 10
 fencing movement 294 7
 fencing shoe, heelless ~ 294 17
 fencing weapons 294 34-45
 fender *Horse* 71 40
 fender *Tram* 197 12
 fender *Hydr. Eng.* 217 9
 fender *Docks* 225 12
 fender, front ~ *Bicycle* 187 13
 fender, front ~ *Car* 191 3; 191 3, 13
 fender, integral ~ 193 33
 fender, wooden ~ 218 26
 fender pile *Hydr. Eng.* 217 9
 fender pile *Shipbuild.* 222 35
 F-1 engine 234 4
 fennel 380 6
 fen peat 13 17
 fermentation room 97 72
 fermentation thermometer 93 9
 fermentation trolley 97 73
 fermentation vessel 93 8
 fermenter 93 8
 fermenting cellar 93 7
 fern 377 16
 ferret 86 24
 ferreter 86 25

ferreting 86 23
 ferris 221
 Ferris wheel 308 37
 ferroconcrete construction 119 1-89
 ferrule 45 53
 ferry, flying ~ 216 10
 ferryboat 216 11, 15; 225 11
 ferry cable 216 2
 ferry landing stage 216 7
 ferryman 216 17
 ferry rope 216 2
 fertilizer, artificial ~ 63 14
 fertilizer, chemical ~ 63 14
 fertilizer, lime ~ 63 14
 fertilizer, nitrogen ~ 63 14
 fertilizer, phosphoric acid ~ 63 14
 fertilizer, potash ~ 63 14
 fertilizer spreader 62 21
 fescue 69 24
 festoon *Carnival* 306 5
 festoon *Art* 335 54
 festoon lamp 318 26
 festoon lighting 318 25
 fetish 354 43
 fetlock 72 24
 fettler 148 43
 fettling shop 148 38-45
 feuilleton 342 67
 F-hole 323 6
 fiber see fibre
 fibre 77 23
 fibre, glass ~ 151 48
 fibre, loose ~ 168 43
 fibreboard 338 24
 fibula 17 24
 fibula, serpentine ~ 328 28
 fibula, spiral ~ 328 30
 fibula, two-piece ~ 328 30
 fiddle string 323 9
 field *Agr.* 63 4, 17
 field *Equest.* 289 41, 51
 field *Ball Games* 291 1; 292 40-58
 field, fallow ~ 63 1
 field bean 69 15
 field bindweed 61 26
 field camomile 61 8
 field chopper, self-propelled ~ 64 34-39
 fielder 292 76
 field eryngo 61 32
 field glasses 86 6
 field guard 63 13
 field illumination 112 33
 fielding side 292 73
 field lens 115 40
 field mangel 69 21
 field marigold 61 7
 field mushroom 381 1
 field pests 80 37-55
 field player 292 2
 field poppy 61 2
 field sprinkler 67 32
 fig 383 35; 384 11, 13
 fighter-bomber 256 1, 29
 fighting bull 319 28
 fighting ships 258 64-91
 fighting ships, modern ~ 259
 figure, clay ~ 48 13; 339 7

figure, plasticine ~ 48 13
 figure, symbolic ~ 327 20
 figure, symmetrical ~ 346 24
 figure, wax ~ 308 69
 figurehead 218 16
 figures, compulsory ~ 302 11-19
 figure ski 286 56
 figurine, clay ~ 328 20
 filament 169 17, 22; 170 44
 filament, continuous ~ 169 1-34
 filament, solid ~ 169 15
 filament lamp 127 56
 filament tow 169 28, 30
 file *Doc.* 22 12, 26
 file *Metabwkr.* 140 16
 file *Office* 245 6; 247 37; 248 5
 file, flat ~ 108 49; 140 27
 file, half-round ~ 140 29
 file, rough ~ 140 8
 file, round ~ 108 47; 140 29
 file, smooth ~ 140 8
 file handle 108 50
 filet 102 22
 file tab 248 4
 filigree work 102 30
 filing cabinet 245 4
 filing clerk 248 6
 filing drawer 248 2, 23
 filing machine 140 15
 filing shelf 248 10
 fill, sanitary ~ 199 10
 filler *Tobacc. etc.* 107 7
 filler *Paperhanger* 128 3
 filler *Power Plant* 153 38
 filler *Films* 310 52
 filler hoist 200 51
 filler hole 213 19
 filler light 310 52
 filler opening 200 52
 filler rod 141 12
 fillet *Meat* 95 13
 fillet *Carp.* 120 45
 fillet *Floor etc. Constr.* 123 57, 67
 fillet *Bookbind.* 183 3
 fillet, tilting ~ 121 31
 fillet gauge 142 36
 filleting knife 89 38
 fillet of beef 95 24
 fillet of pork 95 44
 filling *Dent.* 24 30
 filling *Tablew. etc.* 45 38
 filling *Hydr. Eng.* 217 7
 filling *Water* 269 29
 filling compound 153 38
 filling end 162 2
 filling inlet 50 12
 filling knife 128 35
 filling machine 76 21, 26
 filling material 24 51
 filling station 196 1-29
 fill-in light 310 52
 fill light 310 52
 fill *Atom* 2 10, 13
 film *Photog.* 114 9
 film *Composing Rm.* 176 25
 film, cine ~ 117
 film, exposed ~ 117 42

film, unexposed ~ 117 41
 film actor 310 28
 film actress 310 27
 film advance 114 32
 film advance lever, single-stroke ~ 115 16
 film agitator, automatic ~ 116 19
 film and sound cutting table 117 96
 film and tape synchronizing head 117 102
 film back 115 80
 film break detector 312 30
 film camera 27 20
 film camera, soundproof ~ 310 47; 313 15
 film cameras 313 1-39
 film cassette 112 65
 film cassette, miniature ~ 114 7
 film cassette, universal ~ 242 44
 film cement 312 22
 film clip 116 14
 film copier, automatic ~ 176 28
 film-developing machine 311 30
 film director 310 40
 film dosimeter 2 8
 film drier 116 23
 film editor 311 43
 film extra 310 29
 film feed spool 117 79
 film former 178 24
 film gate 117 30; 312 34
 film gate opening 117 40
 filmgoer 312 5
 filming 310 14-60, 26-60
 filming, exterior ~ 310 18
 filming, outdoor ~ 310 18
 filming agent 178 24
 filming speed selector 117 12
 film laboratory 310 2, 30
 film library 310 5
 film magazine 113 40
 film marker 117 95
 film matrix case 176 17
 film of fluorescent material 240 19
 film orchestra 310 17
 film path 312 31
 film perforator 117 95; 242 10
 film poster 268 57
 film-processing machine 311 30
 film processor, automatic ~ 177 72
 film projection 312 1-23
 film projector 311 22; 312 24
 film projectors 312 24-52
 film reel 311 24; 312 32
 film-ring dosimeter 2 11
 films 310; 311; 312; 313
 filmstrip 310 45
 film set 310 7
 filmsetter 176 7
 filmsetting 176
 film speed setting 117 18

film spool 114 8; 311 24; 312 32
 film spool holder 238 6
 film star 310 27, 28
 film storage vault 310 5
 film studios 310 1-13
 film title 310 35
 film transport 114 32
 film transport handle 116 7
 film transport mechanism 311 26
 film turntable 117 99; 311 44
 film viewer 117 91; 242 8
 film wind 114 32
 film window 114 18; 115 28, 34
 filter *Atom* 2 9, 12, 14
 filter *Weaving* 165 14
 filter *Synth. Fibres* 170 32
 filter *Paperm.* 172 20
 filter *Water* 269 62
 filter *Chem.* 349 12
 filter, fluted ~ 350 41
 filter adjustment 116 43, 44, 45
 filter bed 269 10
 filter bottom 269 11
 filter cake 161 13
 filter change, automatic ~ 316 49
 filtered water outlet 269 12
 filter flask 350 40
 filter funnel 349 11
 filter gravel 269 10
 filter lens 142 40
 filter mount 115 6
 filter pick-up 112 57
 filter plate 349 12
 filter press *Porcelain Manuf.* 161 12
 filter press *Synth. Fibres* 169 12
 filter screen 116 22
 fimbria 20 82
 fin *Swim.* 279 18
 fin *Bathing* 280 41
 fin *Motorboats etc.* 286 43
 fire alarm siren 270 4
 fire alarm ~ 364 8
 fin, anal ~ 364 9
 fin, caudal ~ 364 10
 fin, dorsal ~ *Fish etc.* 364 6
 fin, dorsal ~ *Mammals* 367 27
 fin, fixed ~ 286 61
 fin, pectoral ~ 364 7
 fin, pelvic ~ 364 8
 fin, ventral ~ 364 8
 fin, vertical ~ *Aircraft* 229 24; 230 59; 231 6; 232 7
 fin, vertical ~ *Space* 235 1
 fin, vertical ~ *Air Force* 256 32
 fin, vertical ~ *Airsports* 288 21
 final image tube 113 39
 final picture quality checking room 238 60-65
 finch 360 1
 finches 361 6-8
 finds, prehistoric ~ 328 1-40
 fine cut 107 25
 fine focusing indicator 224 36
 finger, fifth ~ 19 68
 finger, fourth ~ 19 67

finger, little ~ 19 68
 finger, middle ~ 19 66
 finger, pivoted ~ 74 36
 finger, second ~ 19 65
 finger, third ~ 19 66
 fingerboard 323 21; 324 8
 finger guard 83 20; 85 15
 finger hole *Office* 247 39
 finger hole *Sports* 305 16
 fingerhole *Music. Instr.* 323 33; 324 34
 finger hook 324 67
 fingernail 19 80
 finger pad 19 78
 finger paint 260 26
 finger painting 260 26
 finger plate 237 11
 fingerprint 264 29
 fingerprint identification 264 28
 finger roll 97 15
 finger stop 237 12
 fingertip 19 79
 finial 335 37
 fining bath 162 4
 fining lap 111 37, 38
 finish 286 28
 finish, gloss ~ 128 32
 finished malt collecting hopper 92 20
 finishing 168 1-65; 170 57
 finishing bur 24 38
 finishing layer 123 40
 finishing line 282 28; 286 30
 finishing machine 100 3
 finishing of textile fabrics 168
 finishing press 183 4
 finishing train 148 71
 Finn 284 51
 Finn dinghy 284 51
 fin post 235 3
 fipple flute 322 7
 fir cone 372 2
 fire, blacksmith's ~ 137 1-8; 138 34
 fire, open ~ 267 25
 fire alarm 270 4
 fire alarm siren 270 4
 fire appliance building 233 8
 fire-arm 87 2
 fireboat 270 65
 firebox 210 4
 fire control radar antenna 258 51
 fire control system 255 74
 firecrest 361 10
 fire curtain 316 24
 fire department 270
 fire door handle handgrip 210 63
 fire eater 308 25
 fire engine 270 5
 fire extinguisher 196 9
 fire extinguisher, portable ~ 270 61
 fire extinguisher, wheeled ~ 270 63
 firefighter 270 37
 fire-fighting equipment 227 25; 228 20
 fire gable 121 9

fire gun 221 4
 fire hat 270 38
 firehole door 210 61
 firehole shield 210 60
 fireman 270 37
 fire nozzle 221 4
 fireplace 267 23
 fire plug 270 35
 fire prevention 316 6
 fire protection 316 6
 fire salamander 364 22
 fire service 270
 fire service drill 270 1-46
 fireside 267 22
 fire siren 270 4
 fire station 270 1-3
 fire tube 210 17
 firewood basket 309 10
 fireworks 306 49-54
 firing mechanism 255 29
 firing mould 161 4
 firing pin 87 21
 firing position 305 73
 firing process 161 2
 firing sequence insert 195 13
 firing trigger 87 11
 firmer chisel 134 30
 firm basin 12 48
 fir needle 372 11
 firm field 12 48
 firm slope 300 14
 first aid 21
 first aid dressing 21 5
 first aid kit 21 4
 first aid post 308 61
 first aid station 204 44
 first aid tent 308 61
 first base 292 46
 first-class section 207 17
 first floor 37 2; 118 7
 first-floor landing 123 23
 first position 294 18
 Fish *Astron.* 4 64
 fish *Grocer* 98 19
 fish *Fish etc.* 364
 fish, canned ~ 96 28
 fish, female ~ 89 13
 fish basket 89 25
 fishbolt 202 13
 fishbone stitch 102 7
 fish-canning factory 225 59
 fish culture 89 1-19
 fish dish 266 53
 fish dock 225 56
 fish egg 89 12
 fishes 364 1-18
 fish-eye 115 44
 fish farming 89 1-19
 fish fork 45 8, 65
 fish hook 89 79
 fishing 89 26
 fishing boat 89 27; 90 24
 fishing line 89 63
 fishing lugger 90 1
 fishing pliers 89 37
 fishing tackle 89 37-94
 fishing tackle, suspended ~ 90 29
 fish knife *Tablew. etc.* 45 8, 64
 fish knife *Fish Farm.* 89 39
 fish ladder 89 93

fish lance 280 40
 fish market 225 57
 fish pass 89 93
 fishplate 202 12
 fishpole antenna 258 60
 fish spawn 89 12
 fish spear 280 40
 fishtail bit 145 21
 fish way 89 93
 fission 1 43, 46
 fission, nuclear ~ 1 34
 fission fragment 1 44, 47, 51
 fission fragments 1 37-38
 fissure 11 52
 fissure, diagonal ~ 300 3
 fissure, horizontal ~ 300 3
 fissure, vertical ~ 300 3
 fissure bur 24 39
 fist 16 48
 fist hatchet 328 1
 fitch 129 19
 fitter 140 1
 fitting booth 271 32
 fitting of the frame 111 10
 fitting-out quay 222 5-9
 fittings 126 38-52
 five-four time 320 41
 fix 224 45
 flag *Flags* 253 7-11
 flag *Town* 268 44
 flag *Ball Games* 293 86
 flag, club's ~ 283 25
 flag, linesman's ~ 291 60
 flag, Olympic ~ 253 5
 flag, swallow-tailed ~ 253 22
 flag at half-mast 253 6
 flag at half-staff 253 6
 flag dressing 221 85
 flag of the Council of Europe 253 4
 flag of the United Nations 253 1-3
 flagpole 253 1, 7; 273 61
 flags 253
 flags, national ~ 253 15-21
 flags, triangular ~ 253 30-32
 flagstaff 253 1, 7; 258 4; 259 87; 273 61
 flagstick 293 88
 flagstone 51 17
 flail rotor 64 73
 flame regulator 107 31
 flamingo 272 53
 flan 252 43
 flancard 329 86
 flan case 97 47
 flanchard 329 86
 flange *Cooper* 130 28
 flange *Mach. Parts etc.* 143 2, 5
 flange *Electrotyp. etc.* 178 44
 flange *Hydr. Eng.* 217 67
 flange, bottom ~ 215 10
 flange, top ~ 215 9
 flange mount 130 20
 flanging, swaging, and wiring machine 125 25
 flank *Man* 16 32
 flank *Game* 88 26
 flank *Meat* 95 2, 15-16
 flank *Bldg. Site* 119 6
 flank, thick ~ 95 15, 36

flank, thin ~ 95 16
 flank vault 297 31
 flans 97 22-24
 flap *Child. Clothes* 29 35
 flap *Horse* 71 40, 47
 flap *Aircraft* 229 37
 flap, double-slotted ~ 229 48
 flap, extending ~ 229 51
 flap, fur ~ 35 32
 flap, normal ~ 229 46
 flap, outer ~ 259 78
 flap, slotted ~ 229 47
 flap, split ~ 229 49
 flap extension 78 19
 flaps, plain ~ 229 46-48
 flaps, simple ~ 229 46-48
 flaps, split ~ 229 49-50
 flap valve 192 63
 flare, pork ~ 95 45
 flash, battery-portable ~ 114 65
 flash, electronic ~ 114 65, 68; 309 40-41
 flash, single-unit ~ 114 68
 flash bar 114 75
 flash bulb 309 39
 flash contact 114 30
 flash cube 114 74
 flash cube contact 114 13
 flash cube unit 114 73
 flash eliminator 255 18
 flashgun 114 68; 309 38
 flashgun, electronic ~ 309 40-41
 flash head 114 67; 309 40
 flash hider 255 18
 flash lamp *Photomech. Reprod.* 177 37
 flash lamp *Inf. Tech.* 242 43
 flashlight *Electr.* 127 26
 flashlight *Fire Brig.* 270 6
 flashlight, underwater ~ 279 25
 flash socket 115 14
 flash switch 114 33
 flash tube 176 26
 flask, collared ~ 328 12
 flask, conical ~ 350 39
 flask, flat-bottomed ~ 350 36
 flask, long-necked ~ 350 38
 flask, round-bottomed ~ 350 38
 flask, three-necked ~ 350 55
 flask, volumetric ~ 173 3
 flat *Dwellings* 37 64-68, 69-71
 flat *Flat* 46
 flat *Music. Not.* 320 52
 flat-bed cylinder press, two-revolution ~ 181 1
 flat-bed knitting machine 167 35
 flat-bed offset machine 180 75
 flat-bed offset press 180 75
 flatcar 206 24; 213 5, 11, 40
 flat clearer 163 44
 flat four engine 230 34
 flat glass production 162 1-20
 flat plate keel 222 49
 flats *Cotton Spin.* 163 45, 46
 flats *Navig.* 224 87, 97

flatter 137 35
 flatworm 81 35
 flauto piccolo 323 30
 flavourings 382
 flax 383 6
 flay brush 129 21
 flaying knife 94 13
 flea 81 42
 flea beetle 80 39
 flea market 309
 fleet of lorries 206 25
 fleet submarine, nuclear-powered ~ 259 54
 flesh *Soft Fruit* 58 24, 35, 58
 flesh *Drapes & Nuts* 59 6
 fletching 305 62
 fleur-de-lis 254 13
 flews 70 26
 flex 50 66, 77
 flex hook 50 65
 flexor, radial ~ 18 40
 flexor, ulnar ~ 18 58
 flexor carpi radialis 18 40
 flexor carpi ulnaris 18 58
 flies 316 1-60
 flight, negative ~ 288 9
 flight board 77 49
 flight deck *Space* 235 16
 flight deck *Warships* 259 2, 12
 flight instrument 288 68
 flight of wild ducks 86 41
 flight refueling probe 256 7
 flit-flak 272 24
 flint 107 28
 flint corn 68 31
 flintlock 353 28
 flint maize 68 31
 flip-over numeral 110 20
 flipper *Swim.* 279 18
 flipper *Bathing* 280 41
 flipper *Mammals* 367 28
 flip-up window 142 4
 flitch of bacon 96 2
 flitter-mouse 366 9
 float *Bldg. Site* 118 57
 float *Plumb. etc.* 126 15
 float *Weaves* 171 40
 float *Car* 192 15
 float *Rivers* 216 12
 float *Hydr. Eng.* 217 34
 float *Aircraft* 232 6
 float *Swim.* 282 18
 float *Motorboats etc.* 286 44
 float *Theatre* 316 26
 float, cork ~ *Fish Farm.* 89 43
 float, cork ~ *Swim.* 282 32
 float, lead-weighted ~ 89 48
 float, plastic ~ 89 44
 float, polystyrene ~ 89 46
 float, quilt ~ 89 45
 float, skin ~ 353 11
 float, sliding ~ 89 43, 48
 float, spherical ~ 90 19
 float, wooden ~ 90 6
 float bath 162 16
 float chamber 192 14
 float glass process 162 12
 floating thread, diagonal ~ 171 38
 floating thread, loose ~ 171 41
 floating vessel 221 65

floating yarn, diagonal ~ 171 38
 floating yarn, loose ~ 171 41
 float lever 65 43
 float line 90 4
 floatplane 232 5
 floats 89 43-48
 float seaplane 232 5
 float shaft 217 35
 flood bed 216 41
 flood containment area 216 42
 flood damage 216 5
 floodgate 217 77
 flood plain 13 62
 flood wall 216 32
 floor 296 11; 297 6
 floor, blind ~ 123 38, 73
 floor, concrete ~ 118 16
 floor, false ~ 120 43; 123 68
 floor, ferroconcrete ~ 119 8
 floor, first ~ 37 2, 3; 118 7, 14
 floor, inserted ~ 120 43; 123 68
 floor, reinforced concrete ~ 119 8; 123 35
 floor, ribbed ~ 123 35
 floor, second ~ 37 3; 118 14
 floor, upper ~ 37 3; 118 14
 floor and carpet cleaning 50 53-86
 floorboard 120 36
 floor brick 159 24
 floor brush 129 27
 floor ceiling 222 63
 floor cleaning 50 53-86
 floor cloth 50 55
 floor construction 123
 floor filling 120 44; 123 69
 floor grinding machine 138 7
 floor indicator 271 49
 flooring block, hollow ~ 159 26
 floor manager 271 33
 floor nozzle 50 71
 floor plate 222 59
 floor socket 127 23
 floor socket, sunken ~ 127 24
 floor trader 251 6
 floorwalker 271 33
 flop 298 9
 floppy disc reader 244 8
 flora 356 21
 florin 252 19
 flour 91 28; 97 52
 flour beetle 81 18
 flour corn 68 31
 flour silo 97 74
 flour 216 9
 flow chart 76 9
 flow coating machine 129 34
 flow diagram 76 9; 92 25
 flower *Soft Fruit* 58 4
 flower *Drapes & Nuts* 59 9
 flower *Weeds* 61 10, 19, 22
 flower *Arable Crops* 68 42
 flower *Fodder Plants* 69 7, 14
 flower *Gdn. Pests* 80 11
 flower *Bot.* 370 23, 51
 flower *Decid. Trees* 371 17, 26, 35, 40, 52, 55, 62

flower *Shrubs etc.* 373 5, 7, 11, 14, 31; 374 6, 7, 15, 21, 24
 flower *Flowers etc.* 375 3, 6, 16, 19, 20, 23, 40, 46; 376 2, 5, 11, 19, 23
 flower *Alp. Plants etc.* 378 16, 20, 28, 31, 32, 37, 47, 57
 flower *Trop. Plants* 382 4, 17, 18, 29, 42, 55
 flower *Industr. Plants* 383 12, 17, 27, 31, 36, 39, 46, 47
 flower *South. Fruits* 384 13, 18, 56, 57, 65
 flower, amaranthine ~ 60 21
 flower, androgynous ~ *Shrubs etc.* 374 10
 flower, androgynous ~ *Trop. Plants* 382 12, 14
 flower, female ~ *Drapes & Nuts* 59 38
 flower, female ~ *Decid. Trees* 371 6, 13
 flower, female ~ *Conifers* 372 43
 flower, female ~ *Shrubs etc.* 373 20
 flower, female ~ *Alp. Plants etc.* 378 25; 378 53
 flower, female ~ *Trop. Plants* 382 32, 50
 flower, female ~ *Industr. Plants* 383 50
 flower, female ~ *South. Fruits* 384 7, 14, 42, 43
 flower, forced ~ 55 24
 flower, fumariaceous ~ 60 5
 flower, hermaphroditic ~ *Shrubs etc.* 374 10
 flower, hermaphroditic ~ *Trop. Plants* 382 12, 14
 flower, male ~ *Drapes & Nuts* 59 39
 flower, male ~ *Decid. Trees* 371 14
 flower, male ~ *Conifers* 372 43
 flower, male ~ *Shrubs etc.* 373 21; 374 11
 flower, male ~ *Alp. Plants etc.* 378 23, 53
 flower, male ~ *Trop. Plants* 382 13
 flower, male ~ *Industr. Plants* 383 51
 flower, male ~ *South. Fruits* 384 5, 15, 44, 51
 flower, open ~ 374 17
 flower, withered ~ 58 55
 flower arrangement 266 78; 267 37; 330 48
 flower basket 266 29
 flower bed *Fruit & Veg. Gdn.* 52 18
 flower bed *Market Gdn.* 55 37
 flower bed *Park* 272 41
 flower box 37 20
 flower bud *Soft Fruit* 58 27
 flower bud *Bot.* 370 24
 flower bud *Decid. Trees* 371 25
 flower bud *Shrubs etc.* 374 14

flower bud *Trop. Plants* 382 28
 flower cone, female ~ 372 4, 16, 22, 34, 62, 68
 flower garden 51 1-35
 flower girl 266 28
 flower head *Weeds* 61 14
 flower head *Alp. Plants etc.* 378 12
 flower head, discoid ~ 370 74
 flower head, hollow ~ 370 75
 flowering branch *Decid. Trees* 371 2, 10, 16, 34, 39, 51, 54, 66, 71
 flowering branch *Conifers* 372 33
 flowering branch *Trop. Plants* 382 8, 12, 23, 27, 31, 50
 flowering branch *Industr. Plants* 383 22, 26, 30, 38
 flowering branch *South. Fruits* 384 17, 24, 37, 49, 54
 flowering rush 378 39
 flowering shoot *Alp. Plants etc.* 378 2, 27
 flowering shoot *Trop. Plants* 382 41, 47
 flowering shoot *Industr. Plants* 383 42
 flower of inner series 375 32
 flower of outer series 375 31
 flower pot 54 8
 flowers, wild ~ 375; 376
 flower seller 266 28
 flower shoot 59 28
 flower shoot, male ~ 372 6, 62, 68
 flower stalk *Drapes & Nuts* 59 4
 flower stalk *Bot.* 370 52
 flower stalk *Industr. Plants* 383 7
 flower stand 204 48; 267 36
 flower stem 370 52
 flower umbel 378 40
 flower vase 309 2
 flower window 37 68
 flowmeter *Hosp.* 26 3
 flowmeter *Dairy.* 76 4
 flow path 154 51
 flow pipe *Roof & Boilerr.* 38 74
 flow pipe *Plumb. etc.* 126 23
 flow pipe *Energy Sources* 155 10
 fluate 128 7
 flue 155 25
 flueblock 38 40
 flue brush 38 35
 flue pipe 322 57
 flue pipe, metal ~ 326 23-30
 flue pipe, open ~ 326 23-30, 31-33
 flue pipe, stopped ~ 326 34
 flue pipe, wooden ~ 326 31-33
 flue pipe duct 326 24
 flue pipe windway 326 24
 flue tube 210 8
 fluid container 247 9
 fluid reservoir 247 9
 fluid transmission 212 27, 52

fluorescent display, eight-digit ~ 247 15
 fluorescent material 240 18
 fluorescent tube 127 61, 62
 fluorite 351 16
 fluoroscope, mobile ~ 26 14
 fluorspar 351 16
 fluothane container 26 26
 flush-deck vessel 258 2; 259 22
 flushing lever *Bathrm. etc.* 49 17
 flushing lever *Plumb. etc.* 126 19
 flushing valve 126 37
 flush pipe 126 17
 flute *Mills* 91 17
 flute *Music. Instr.* 323 31
 flute *Art* 334 27
 flute *Ethno.* 353 47
 flute, globular ~ 324 32
 flute, small ~ 323 30
 fluting 157 6
 flux *Goldsm. etc.* 108 36
 flux *Plumb.* 125 7
 flux *Gas Weld.* 141 18
 flux *Iron & Steel* 147 2
 fly *Men's Wear* 33 48
 fly *Fish Farm.* 89 65
 fly *Articulates* 358 18
 fly agaric 379 10
 fly amanita 379 10
 fly and draw curtain 315 4
 fly curtain 315 3
 flyer 164 25
 fly floor 316 5
 fly frame 164 19
 fly frame operative 164 24
 fly frame operator 164 24
 fly front 33 62
 fly fungus 379 10
 fly gallery 316 5
 flying boat 232 1
 flying boat, amphibian ~ 232 8
 flying buttress 335 28
 Flying Dutchman 284 49
 fly leaf 185 49
 fly line 316 8
 fly man 316 7
 fly nut *Mach. Parts etc.* 143 42
 fly nut *Bicycle* 187 39
 flyover 268 48
 flysheet 278 22
 fly swat 83 32
 fly title 185 44
 flywheel *Weaving* 166 15
 flywheel *Intern. Combust. Eng.* 190 20
 F major 320 63
 F minor 320 66
 foal 73 2
 foam bath 49 3
 foam can 228 28
 foam canister 83 6
 foam feed pipe 83 10
 foam gun 270 64
 foam-making branch 270 64
 focal length setting 117 3
 focimeter 111 33

fo'c'sle 218 10, 19; 221 13; 223 48
 focus 347 25, 27
 focus, seismic ~ 11 32
 focusing adjustment 240 30
 focusing aid 115 60
 focusing device 5 11
 focusing hood 114 23; 115 68
 focusing ring 114 39; 115 8
 focusing screen *Optic. Instr.* 112 21
 focusing screen *Photog.* 115 39
 focusing screen *Photomech. Reprod.* 177 2, 34
 focusing screens, interchangeable ~ 115 58-66
 focusing stage 115 86
 focusing telescope 115 74
 focusing wedge 115 55
 focus setting 114 28; 117 3
 fodder plants 69 1-28
 fodder silo 62 11, 43
 fodder tank 221 73
 fog 9 31
 fog, high ~ 8 4
 fog headlamp and rear lamp switch 191 64
 fog horn 223 3
 fog horn, ship's ~ 224 32
 fog lamp, rear ~ 191 67
 fog lamp warning light 191 63
 foil 294 1-18, 11
 foil, electric ~ 294 26
 foil, French ~ 294 37
 foil, Italian ~ 294 39
 foil fences 294 5-6
 foillists 294 5-6
 foil mask 294 13
 foil pommel 294 40
 foilsman 294 5-6
 fold 185 54
 fold, asymmetrical ~ 12 13
 fold, gluteal ~ 16 42
 fold, nasolabial ~ 16 11
 fold, normal ~ 12 12
 fold, reclined ~ 12 15
 fold, recumbent ~ 12 15
 fold, symmetrical ~ 12 12
 fold-away table 207 53
 foldboats 283 54-66
 folder *Offset Print.* 180 15, 29
 folder *Letterpress* 181 55
 folder *Photograv.* 182 27
 folder *Office* 245 19
 folder-feeding station 184 17
 folder unit *Offset Print.* 180 15, 29
 folder unit *Letterpress* 181 55
 folder unit *Photograv.* 182 27
 folding 12 4-20
 folding machine 249 58
 folding mechanism 249 46
 fold mountains 12 12-20
 fold plate 185 10
 fold unit 74 1
 foliage 330 48
 foliage plant 39 37
 folk instruments 324 1-46
 follicle *Man* 20 84

follicle *Bot.* 370 91
 follower *Metalwkr.* 140 43
 follower *Composing Rm.* 175 57
 follow-through 293 84
 font 332 10
 fontange, lace ~ 355 65
 font basin 332 11
 food, canned ~ 96 25; 98 15-20
 food, frozen ~ 99 58-61
 food compartment 207 83
 food pests 81 15-30
 food price list 266 65
 food slicer 40 38
 food store, self-service ~ 99 1-96
 food vacuole 357 6
 fool 306 38
 foolscap 306 39
 fool *Man* 16 54; 17 26-29; 19 52-63
 foot *Shoem.* 100 23
 foot *Photog.* 114 71
 foot *Joiner* 132 29
 foot *Blacksm.* 137 15
 foot *Bookbind.* 185 58
 foot *Sailing* 284 40
 foot *Music. Instr.* 326 23
 foot, palmate ~ 73 36; 359 7
 foot, prehensile ~ 364 34
 foot, rubber ~ 114 45
 foot, second ~ 286 59
 foot, serpent's ~ 327 39
 foot, webbed ~ 73 36; 359 6, 7
 footage counter 117 52
 foot bag *Infant Care etc.* 28 38
 foot bag *Winter Countr.* 304 27
 football 273 10, 12; 291 17; 292 22
 football boot 291 21
 football pad 291 33
 football pitch 291 1-16
 football player 292 23
 football sock 291 58
 footband 185 42
 foot bar lever 100 27
 footbath 282 22
 footbed, surgical ~ 101 50
 foot binding, front ~ 286 57
 footboard 186 7, 13
 foot brake 188 52
 footbridge 15 78
 foot control 139 27
 foot control socket 249 66
 foot-fault judge 293 24
 foot ferry 15 60
 foot gear-change control 188 55; 190 77
 foot gearshift control 188 55; 190 77
 footing 123 2
 foot lever 83 34
 footlight 316 26
 footman 186 20
 foot margin 185 58
 foot muff *Infant Care etc.* 28 38
 foot muff *Winter Countr.* 304 27

foot muscle 18 49
 footnote 185 62
 foot of bed 43 4
 foot of goblet 162 42
 foot of machine 133 25
 foot of mast 284 20
 foot passenger ferry 15 60
 footpath 15 43
 footpath under railway 15 44
 foot pedal *Pest Contr.* 83 34
 foot pedal *Forging* 139 27
 foot pedal *Arc Weld.* 142 31
 foot pedal *Letterpress* 181 12
 foot pedal *Bookbind.* 183 18
 footpiece *Mach. Tools* 149 12
 footpiece *Carriages* 186 13
 footprints 126 59
 foot rail 267 52
 footrest *Hairdresser* 105 18; 106 19
 footrest *Bicycle* 187 47
 footrest *Motorcycles etc.* 188 44
 footrest *Railw.* 207 57
 footrest *Winter Sp.* 301 58
 footrest *Sports* 305 81
 footrope *Sea Fish.* 90 9, 18
 footrope *Ship* 219 46
 foot scraper 123 25
 foot switch *Hosp.* 27 21
 foot switch *Dressm.* 103 26
 foot switch *Sawmill* 157 66
 foot switch, electric ~ 50 2
 foot treadle 83 34
 foot valve 269 6, 14, 43
 footwear 101
 fop 306 33
 forage harvester, self-propelled ~ 64 34-39
 forage plants *Fodder Plants* 69 1-28
 foramen 383 57
 forceps 22 52
 forceps, obstetrical ~ 26 53
 forcing 55 24
 forcing bed 55 16
 forcing house 55 4
 forearm *Man* 16 46
 forearm *Horse* 72 21
 forearm balance 295 26
 forearm stand 295 26
 forebay 217 39
 forecarriage 65 14-19
 forecastle 218 10, 19; 221 13; 223 48
 fore course 218 41; 219 55
 foredeck 223 47; 284 10
 foredeck, flooded ~ 258 65; 259 77
 fore edge 185 57
 fore edge margin 185 57
 fore end 95 51
 forefinger 19 65
 forefoot 72 22-26
 foregrip 87 13
 forehead 72 18-27
 forehead stroke 293 40
 forehead volley 293 41
 forehead *Man* 16 4-5
 forehead *Horse* 72 3
 foreign counter 204 31

foreign exchange counter 204 31; 250 10
 foreign trade zone 225 2
 foreleg 70 5; 88 25, 64
 forelock 72 2
 foremast 218 42; 219 2-4; 220 21; 221 2
 foremast, lower ~ 219 2
 forepart 218 49
 forepaw 70 6
 forepeak 227 18
 fore royal 219 60
 fore royal yard 219 37
 foresail 218 41; 219 55
 foresail, square ~ 220 13
 foresheet 284 23
 fore ship 286 33, 36, 40
 foresight 255 3, 23, 37; 305 42
 foresight block 255 23; 37
 foreskin 20 70
 forest 84 1-34
 forestage 316 25
 forestay 284 15
 forest Indian 352 19
 forest labourer 84 18
 forest pests 82
 forestry 84; 85
 forestry office 15 3
 forest track 84 3
 foretop 219 50
 fore topgallant mast 219 4
 fore topgallant rigging 219 18
 fore topgallant sail 218 52
 fore topmast 219 3
 fore topmast crossrees 219 51
 fore topmast rigging 219 17
 fore topmast staysail 219 20
 forewring 358 36
 foreyard 219 32
 forge 137 1-8, 1, 34
 forget-me-not 378 26
 forging and sizing press 139 18
 forging press, hydraulic ~ 139 35
 fork *Tablew. etc.* 45 7, 58
 fork *Agr. Impl.* 66 3, 7, 22
 fork *Horse* 71 29
 fork *Optic. Instr.* 113 12
 fork *Quarry* 158 33
 fork *Circus* 307 54
 fork, rear ~ 188 14; 189 7
 fork, swinging-arm ~ 188 14; 189 7
 fork blade 187 12
 fork column 187 14
 fork end 187 12
 forklift 93 23; 206 16; 225 44; 226 8
 forklift truck 93 23; 206 16; 225 44; 226 8
 fork mount 113 24
 fork mounting 113 12, 24
 forks, front ~ 187 10-12
 forks, telescopic ~ 188 8
 fork spanner 134 2
 fork truck 93 23; 206 16; 225 44; 226 8
 fork wrench 134 2
 form *see forme*
 form *Office* 245 24

formaldehyde atom 242 64
 format selection 249 34
 forme 174 10
 forme, locked up ~ 181 36
 forme bed 180 78; 181 17
 forme-inking roller 181 18, 27, 61
 former *Opticn.* 111 25, 26
 former *Plumb. etc.* 126 83
 former *Letterpress* 181 53
 former *Aircraft* 230 55
 former *Air Force* 257 28
 forme roller 181 7, 18, 27
 forms 36 42-86
 Formula One racing car 290 34
 Formula Two racing car 290 36
 formwork 119 54-76
 forsythia 373 1
 forte 321 38
 forte fortissimo 321 40
 forte pedal 325 8
 forte piano 321 41
 fortissimo 321 39
 fortress 15 74
 fortune teller 308 36
 forward *Swim.* 282 50
 forward *Ball Games* 293 75
 forward, reverse and still projection switch 117 88
 forward horizontal stand 295 30
 forwarding agent 206 28
 forwarding office 206 26
 forwarding roll 180 4
 forward kip 296 58
 forward pace 295 43
 forward roll 297 19, 20
 forward somersault 297 18
 forward split 295 15
 forward straddle 295 4
 forward walkover 297 26
 forward wind button 249 73
 Fosbury flop 298 9
 fosse 329 37
 fossette 16 16
 foul 291 50; 299 34
 foul line 292 48
 foundation *Bees* 77 43
 foundation *Floor etc. Constr.* 123 2
 foundation base 123 3
 foundation pile 5 28
 foundation trench 118 75
 founder 148 8
 fountain 272 8, 21, 22, 62; 334 68
 fountain pen 260 14
 fountain roller 181 64; 249 52
 Fourcault glass-drawing machine 162 8
 Fourcault process 162 1
 four-channel balance control 241 42
 four-channel demodulator 241 45
 four-channel level control 241 42
 four-eight time 320 31
 four-four time 320 32

four-masters 220 28-31
 four-to-pica 175 20
 four-two time 320 33
 four-wheel drive 194 1
 fowl, domestic ~ 73 19-36
 Fowler flap 229 52
 Fowler flap, double-slotted ~ 229 40
 fowl run 74 11
 foxglove 379 2
 fox hunt 289 41-49
 fox terrier, wire-haired ~ 70 15
 foyer 5 25; 267 1-26, 44-46; 315 12-13
 fraction 344 10, 19
 fraction, complex ~ 344 17
 fraction, compound ~ 344 17
 fraction, improper ~ 344 16, 18
 fraction, proper ~ 344 15
 fractionating column 145 37
 fractions, vulgar 344 15-16
 fractocumulus 8 12
 fractostratus 8 11
 Fraktur 342 3
 frame *Agr. Mach.* 65 8, 90
 frame *Bees* 77 40
 frame *Mills* 91 3
 frame *Opticn.* 111 5
 frame *Basketm.* 136 22
 frame *Forging* 139 16
 frame *Iron Foundry etc.* 148 57
 frame *Mach. Tools* 149 65
 frame *Knitting* 167 33
 frame *Railw.* 207 3; 208 5
 frame *Shipbuild.* 222 58
 frame *Aircraft* 230 55
 frame *Rowing* 283 49, 67
 frame *Sailing* 285 51
 frame *Gymn.* 297 12
 frame *Sports* 305 14, 88
 frame, aluminium ~ 50 19
 frame, annular ~ 235 47
 frame, bone ~ 353 13
 frame, C-shaped ~ 26 19; 27 17
 frame, ferroconcrete ~ 119 2
 frame, heated ~ 55 16
 frame, iron ~ 325 2
 frame, lower ~ 148 20
 frame, metal ~ *Opticn.* 111 7
 frame, metal ~ *Music. Instr.* 324 76
 frame, plate glass ~ 179 15
 frame, reinforced concrete ~ 119 2
 frame, sectional ~ 65 56
 frame, shell ~ 111 8
 frame, tortoiseshell ~ 111 8
 frame, tubular ~ 188 9, 49
 frame, upper ~ 148 19
 frame, wire ~ 339 35
 frame, wooden ~ 353 13
 frame bar 64 51
 frame-clamping machine 133 42
 frame-coding device 242 8-10
 frame counter 115 17; 313 28

frame-cramping machine 133 42
 frame drum 353 26
 frame end plate 164 26
 frame hive 77 45-50
 frame-mounting device 133 48
 frame number 187 51
 frame sample 124 2
 frame-sanding pad 133 34
 frame saw, vertical ~ 157 2
 frame section, aft ~ 234 49
 frame section, forward ~ 234 45
 frame slipway 222 19-21
 frame stand 133 43
 frame tent 278 36
 frame timber 119 64
 frame timber, bolted ~ 119 74
 frame vent 55 17
 frame wood 124 3
 frame wood sample 124 2
 framework 339 22
 framework support 214 77
 framing 336 11
 framing chisel 132 11
 framing control 312 29
 framing table 132 62
 franc 252 15, 16, 17, 18
 Frankfurter 96 8
 Frankfurter garland cake 97 42
 Frankfurter sausage 96 8
 franking machine 22 24; 236 7, 27, 47
 freak show 308 19
 free backward circle 297 29
 free combination knob 326 40
 free combination stud 326 40
 free exercise 295
 free-fall positions 288 60-62
 free flight model, remote-controlled ~ 288 86
 free kick 291 43
 free leg *Athletics* 298 27
 free leg *Winter Sp.* 302 3
 free leg, vertical ~ 298 25
 free port 225 2
 freestyle relay race 282 24-32
 freestyle wrestling 299 10-12
 free-throw line 292 38
 free walkover forward 297 25
 freeway *Map* 15 16
 freeway *Docks* 225 54
 free-wheel hub 187 63
 freezer 22 63; 96 21; 97 65; 98 74
 freezer, upright ~ 39 7
 free zone enclosure 225 3
 free zone frontier 225 3
 freight agent 206 28
 freight barge 216 25
 freight car 206 6
 freight car, flat ~ 206 21
 freight car, open ~ 213 8, 33
 freight car, special ~ 213 33
 freight depot *Map* 15 91
 freight depot *Station* 206
 freighter 221 57
 freight house 206 7, 26-39
 freight house door 206 37

freight office 206 26
 freight truck 206 15
 French chalk 271 39
 French horn 323 41
 French lady 355 51
 French toast 97 54
 French window 37 21
 frequency band 309 22
 fresco 338 40
 fresh-air inlet 356 16
 fresh-air inlet and control 191 85
 fresh-air regulator 191 86
 fresh meat counter 99 51
 fresh milk filling and packing plant 76 20
 fresh milk tank 76 15
 fresh oil tank 65 46
 freshwater eel 364 17
 freshwater pearl mussel 357 33
 fresh water tank 221 70; 223 79
 Fresnel lens 115 64
 fret *Roulette* 275 30
 fret *Music. Instr.* 324 9
 fretsaw 135 12; 260 53
 fretsaw blade 135 13; 260 54
 friction drive 116 33; 312 37
 friction pad 192 49
 friction tape 127 34
 friction wheel 322 26
 fridge *Kitchen* 39 2
 fridge *Fla.* 46 33
 fridge *Disco* 317 10
 frize 335 9
 frize, Babylonian ~ 333 19
 frize decoration 334 16
 frigate 258 53
 frill 31 34; 32 44
 frill collar 31 46
 frill front 32 44
 fringe 34 36
 fringe, decorative ~ 353 25
 fringe region 7 34
 frit 162 2
 frit feeder 162 13
 frit funnel 162 13
 frock coat 355 76
 frog *Agr. Mach.* 65 8
 frog *Road Constr.* 200 26
 frog *Railw.* 202 24
 frog *Music. Instr.* 323 13
 frog position 288 61
 frog's bit 378 29
 frond 378 49
 front 305 1
 front, cold ~ 8 13; 9 27
 front, extended ~ 200 10
 front, hinged ~ 213 10
 front, occluded ~ 9 25
 front, warm ~ 8 5; 9 26
 frontalis 19 4
 front axle pivot pin 65 48
 front axle suspension 65 49
 front band 71 9
 front element mount 115 6
 front fan-jet 232 33
 front-line player 293 63
 front panel, sliding ~ 349 27

front roller underclearer 164 44
 fronts 9 25-29
 fronts, cold ~ 8 13-17
 fronts, warm ~ 8 5-12
 front seat headrest 193 7
 front seat head restraint 193 7
 front sight block 255 23, 37
 front support *Free Exerc.* 295 21, 23
 front support *Gymn.* 296 28
 front wheel drive 191 52
 front wheel drum brake 188 36
 froth 266 4
 frozen food compartment 39 5
 fruit *Weeds* 61 11, 20, 23
 fruit *Restaurant* 266 57
 fruit *Decid. Trees* 371 4, 19, 28, 45, 69
 fruit *Conifers* 372 53, 64
 fruit *Shrubs etc.* 373 12, 18, 19, 25, 29, 31, 34
 fruit *Flowers etc.* 375 4, 7, 10, 13, 17, 24, 35, 37, 47; 376 3, 6, 14
 fruit *Alp. Plants etc.* 378 11, 38, 42
 fruit *Trop. Plants* 382 3, 5, 10, 15, 17, 24, 39
 fruit *Industr. Plants* 383 14, 18, 21, 28, 32, 40, 43, 52, 56, 59
 fruit *South. Fruits* 384 19, 26, 39, 45
 fruit, aggregate ~ *Soft Fruit* 58 28
 fruit, aggregate ~ *Bot.* 370 100, 101
 fruit, canned ~ 98 16
 fruit, compound ~ *Soft Fruit* 58 28
 fruit, compound ~ *Bot.* 370 100, 101
 fruit, dehiscent ~ 375 27
 fruit, immature ~ 378 31
 fruit, indehiscent ~ 375 43
 fruit, mature ~ *Decid. Trees* 371 61
 fruit, mature ~ *Trop. Plants* 382 33
 fruit, ripe ~ *Decid. Trees* 371 61
 fruit, ripe ~ *Trop. Plants* 382 33
 fruit, soft ~ 58 1-30
 fruit, stewed ~ 45 30
 fruit, unripe ~ 378 31
 fruit, young ~ *Decid. Trees* 371 59
 fruit, young ~ *South. Fruits* 384 31
 fruit and vegetable counter 99 80
 fruit and vegetable garden 52 1-32
 fruit bowl 45 29, 40
 fruit capsule, mature ~ 382 44
 fruit capsule, ripe ~ 382 44

fruit cone 372 2, 29, 30, 36, 41, 57
 fruit dish 45 28
 fruit flan 97 22; 99 20
 fruit garden 52
 fruiting body 381 2
 fruiting branch *Decid. Trees* 371 3, 11, 18, 31, 36, 41, 47, 50, 56, 64
 fruiting branch *Conifers* 372 40, 51, 59, 63, 66, 70
 fruiting branch *Trop. Plants* 382 2, 37
 fruiting branch *Industr. Plants* 383 34, 46
 fruiting branch *South. Fruits* 384 38
 fruiting palm 384 2
 fruit juice 98 18; 266 58
 fruit juice, bottled ~ 99 74
 fruit juice, canned ~ 99 75
 fruit knife 45 71
 fruit pests 80 1-19
 fruit picker 56 22
 fruit pip 58 37, 60
 fruit preserver 40 23
 fruits 370 91-102
 fruits, dehiscent ~ 370 91-96
 fruits, indehiscent ~ 370 97-102
 fruits, Mediterranean ~ 384
 fruits, southern ~ 384
 fruits, subtropical ~ 384
 fruits, tropical ~ 384
 fruit scale 372 67
 fruit spoon 45 66
 fruit stall 308 53
 fruit storage shed 225 52
 fruit tree, standard ~ 52 30
 fruit trees, dwarf ~ 52 1, 2, 16, 17, 29
 fruit warehouse 225 52
 frustum of a cone 347 45
 frying pan 40 4
 fry pond 89 6
 F sharp major 320 61
 F sharp minor 320 58
 fuchsia 53 3
 fuel cell 234 62
 fuel gas 145 52
 fuel gauge 191 38, 65
 fuel-handling hoist 154 27
 fuel hand pump 190 64
 fuel-injection engine 190 1
 fuel injector 190 32
 fuel inlet 192 13
 fuel leak line 190 53
 fuel level sensor 234 27
 fuel line 190 31
 fuel line duct 234 40
 fuel oil 38 50
 fuel oil, heavy ~ 145 59
 fuel oil, light ~ 145 58
 fuel oil tank 212 75
 fuel pin 154 4
 fuel pipe 286 25
 fuel pressure gauge 230 19
 fuel pressure line 190 52
 fuel pressure pipe 190 52
 fuel pressure regulator 190 17
 fuel rod 154 4

fuel storage **154** 28
 fuel supply pipe **190** 31
 fuel tank *Moon L.* **6** 7, 29, 37
 fuel tank *Agr. Mach.* **65** 42
 fuel tank *Motorcycles etc.* **188** 10, 28
 fuel tank *Motorcycle* **189** 2
 fuel tank *Railw.* **209** 20; **212** 56
 fuel tank *Ship* **221** 71; **223** 80
 fuel tank *Aircraft* **230** 48
 fuel tank *Space* **234** 58
 fuel tank, forward ~ **235** 21
 fuel tank, jettisonable ~ **235** 46
 fuel tank, main ~ **212** 4
 fuel tanker **258** 97
 fuel tender **210** 67
 fuel warning light **191** 71
 full circle **308** 43
 full-colour print **340** 28
 full-cone indicator **165** 7
 fuller's earth **199** 38
 fulling machine, rotary ~ **168** 1
 fulling roller, bottom ~ **168** 6
 fulling roller, top ~ **168** 3
 full point **342** 16
 full spread position **288** 60
 full-step **320** 51, 53
 full stop **342** 16
 full title **185** 46
 fulmar **359** 12
 fume extraction equipment **142** 13
 fume extractor **255** 59, 89
 fumigation chamber, mobile ~ **83** 15
 fumigation plant, vacuum ~ **83** 11
 fumigator, vacuum ~ **83** 11
 function, trigonometrical ~ **346** 32
 function key **247** 17
 funeral **331** 33-41
 fungi, edible ~ **381**
 fungi, esculent ~ **381**
 fungi, poisonous ~ **379** 10-13
 funicular **214** 12
 funicular railway car **214** 13
 funnel *Photog.* **116** 12
 funnel *Ship* **221** 8, 40, 75, 84; **223** 1
 funnel *Warships* **258** 58; **259** 32
 funnel *Chem.* **350** 16
 funnel, aft ~ **258** 20
 funnel, forward ~ **258** 19
 Funnel-Beaker culture **328** 12
 funnel marking **223** 2
 fur marker **131** 22
 furnace **199** 29
 furnace, continuous ~ **139** 1
 furnace, electric ~ **147** 51-54
 furnace, gas ~ **139** 47
 furnace, gas-fired ~ **139** 47; **140** 11
 furnace, low-shaft ~ **147** 51-54
 furnace, stationary ~ **147** 23

furnace bed **38** 66
 furnace incline **147** 2
 furnace lift **147** 2
 furnace thermometer **38** 64
 furniture **174** 8; **181** 40
 furniture lorry **268** 47
 furniture truck **268** 47
 furrier **131** 1
 furrow *Agr.* **63** 8
 furrow *Mills* **91** 17
 furrow, gluteal ~ **16** 42
 furrow wheel **65** 16
 fur seal **367** 18
 fur-sewing machine **131** 9
 fur side **131** 12, 17
 furskin **131** 5
 furskin, cut ~ **131** 14
 furskin, uncut ~ **131** 6
 furskins **131** 11-21
 fur trapper **306** 8
 fur worker **131** 8, 23
 fuse *Electr.* **127** 19, 36
 fuse *Quarry* **158** 28
 fuse box *Hall* **41** 19
 fuse box *Weaving* **166** 23
 fuse carrier **127** 68
 fuse cartridge **127** 36
 fuse holder **127** 35
 fuselage **230** 54; **288** 26
 fuselage attachment **235** 4
 fuselage tank **257** 31
 fuse wire **127** 68

G

gable **37** 15; **121** 5; **122** 25
 gable, curved ~ **336** 5
 gable, round ~ **335** 50
 gable end **37** 15; **122** 25
 gable roof **37** 5; **121** 1
 gable slate **122** 80
 gaffer **310** 37
 gaffsail **220** 1
 gaff topsail **219** 31
 gag *Horse* **71** 53
 gag *Fish Farm.* **89** 42
 gag bit **71** 53
 gage *see* gauge
 gaillardia **60** 19
 gait **289** 7
 gaiter, leather ~ **191** 92
 gaits of the horse **72** 39-44
 Galaxy **3** 35
 gale **373** 33
 galena **351** 14
 galingale **53** 17
 gall *Gdn. Pests* **80** 33
 gall *Forest Pests* **82** 34
 gallant soldier **61** 31
 gall bladder **20** 11, 36
 galleries under bark **82** 23-24
 gallery *Forest Pests* **82** 24
 gallery *Coal* **144** 29
 gallery *Theatre* **315** 16
 gallery *Church* **330** 25
 gallery, drilled ~ **192** 21
 gallery grave **328** 16
 galley *Composing Rm.* **174** 12, 44
 galley *Ship* **218** 44-50; **223** 42

galley *Aircraft* **231** 20
 galley loader **233** 22
 galley slave **218** 48
 gall gnat **80** 40
 gall midge **80** 40
 gallop, full ~ **72** 43-44, 43, 44
 gallows **221** 87
 gall wasp **82** 33
 galvanometer **11** 44
 gamba **322** 23
 gambling casino **275** 1
 gambling game **275** 1-33
 gambling table **275** 8
 gambrel **94** 21
 gambrel roof **121** 18
 gambrel stick **94** 21
 game **86** 28; **88**
 game, furred ~ **86** 35
 game, positional ~ **276** 1-16
 game, winged ~ **86** 41
 game of chance **275** 1-33
 game path **86** 16
 game preserve **86** 1-8
 gaming room **275** 1
 gaming table **275** 8
 gamma radiation **133**, 40
 gammon steak **95** 54
 gander **73** 34
 gang mill **157** 2
 gang stitcher **184** 15
 gangway **38** 3
 gangway, central ~ *Railw.* **208** 23
 gangway, central ~ *Ship* **218** 46
 gannet **359** 9
 gantry *Photomech. Reprod.* **177** 13
 gantry *Shipbuild.* **222** 26
 gantry *Docks* **225** 40
 gantry crane **157** 27; **206** 55; **222** 20, 25
 gantry support **214** 24
 garage *Dwellings* **37** 32, 79
 garage *Garage* **195**
 garage, agent's ~ **195** 1-55
 garage, distributor's ~ **195** 1-55
 garage driveway **37** 52
 garbage **199** 17
 garbage can **199** 3
 garbage can dumping device **199** 2
 garbage container **199** 4
 garbage disposition **199**
 garbage incineration unit **199** 28
 garbage truck **199** 1
 garden **37** 57
 garden, Baroque ~ **272** 1-40
 garden, formal ~ **272** 1-40
 garden, front ~ **37** 58
 garden chair **37** 49
 gardener **55** 20
 garden fence **52** 10
 garden flowers **60**
 garden gate **272** 31
 garden hedge **51** 9
 garden hoe **66** 1
 garden hose **37** 42; **56** 27
 garden house **52** 14

garden ladder **52** 8
 garden light **37** 38
 garden mould **55** 15
 garden pansy **60** 2
 garden parasol **37** 48
 garden path **51** 14; **52** 23
 garden pests **80**
 garden pond **51** 16
 garden rake **51** 4
 garden rose **60** 15
 garden seat **272** 42
 garden shed **52** 3
 garden shovel **55** 14
 garden sieve **55** 13
 garden spider **358** 45
 garden strawberry **58** 16
 garden table **37** 50
 garden tiger **365** 7
 garden tools **56**
 garden wall **37** 37
 gargoyle **335** 30
 garland **306** 17; **335** 54
 garnet **351** 7
 Garratt locomotive **210** 64
 garter **318** 28
 gas, liquid ~ **145** 53
 gas, natural ~ **12** 30
 gas appliances **126** 12-25
 gas bottle **278** 53
 gas cap **12** 30
 gas circulation unit **83** 16
 gas-collecting main **156** 17
 gas compressor **156** 26
 gas connection **141** 31
 gas control **141** 32
 gas cooler *Offshore Drill.* **146** 27
 gas cooler *Coking* **156** 19
 gas cooling **156** 29
 gas cutting installation **148** 67
 gas cylinder **138** 35
 gas cylinder manifold **141** 1
 gas drying **156** 30
 gas extractor **156** 21
 gas fitter **126** 1
 gas fitter's tools **126** 58-86
 gas flue **152** 12
 gas generator **350** 59
 gas holder **156** 25
 gas hose **141** 9
 gas inlet **350** 2
 gas inlet pipe **350** 2
 gaskin **72** 36
 gas lighter **107** 30
 gas main **198** 21
 gas main, high-pressure ~ **156** 45
 gas main, low-pressure ~ **156** 44
 gas meter *Plumb. etc.* **126** 5
 gas meter *Coking* **156** 31
 gas oil component **145** 42
 gasoline can **196** 25
 gasoline canister **84** 36
 gasoline inlet **192** 13
 gasoline pump **196** 1
 gasoline pump, self-service ~ **196** 8
 gasoline pump hose **196** 2
 gasoline station **196** 1-29

gasoline tank **188** 10, 28; **189** 2; **305** 87
 gasometer **144** 12
 gas outlet *Oil, Petr.* **145** 29
 gas outlet *Chem.* **350** 63
 gas pipe *Pest Contr.* **83** 14
 gas pipe *Forging* **139** 54
 gas pipe *Metalwkr.* **140** 12
 gas pipe *Oil, Petr.* **145** 29
 gas pipe *Iron & Steel* **147** 18, 27
 gas pliers *Plumb. etc.* **126** 58
 gas pliers *Metalwkr.* **140** 68
 gas pressure vessel **234** 32
 gas regenerator chamber **147** 28
 gas regulator **255** 34; **350** 6
 gas-separating plant **145** 69
 gas separator **145** 28
 gas station **196** 1-29
 gas supply **27** 41
 gas tap **261** 24
 gastrocnemius **18** 62
 gas tube **83** 35
 gas turbine **209** 9
 gas turbine, auxiliary ~ **231** 33
 gas turbine, twin-shaft ~ **209** 23
 gas turbine controller **209** 16
 gas turbine driving unit **209** 8
 gas turbine fuel tank **209** 17
 gas turbine trainset **209** 1
 gas-washing bottle **350** 58
 gas water **156** 39
 gas welder **141**
 gas welding torch **130** 14
 gate **202** 40; **289** 8; **337** 24
 gate, removable ~ **118** 46
 gate, sliding ~ **217** 18, 55
 gate, vertical ~ **217** 31, 38
 gate, wrought iron ~ **272** 31
 gate and rails **289** 8
 gateau **99** 15; **265** 4
 gateaux **97** 22-24
 gatehouse **329** 22
 gateman **202** 42
 gate pole **301** 30
 gateway **336** 15; **337** 11
 gateway, monumental ~ **333** 9
 gatherer and wire-stitcher **184** 15
 gathering and wire-stitching machine **184** 15
 gathering machine **249** 59
 gathering station **249** 60
 gaucho **306** 31
 gauge **76** 6
 gauntlet **329** 50
 gauze **183** 33; **185** 20
 gauze, sterile ~ **22** 58
 gauze, wire ~ **350** 18, 19
 gauze roll holder **185** 19
 G-clef **320** 8
 gear *Gdn. Tools* **56** 20
 gear *Iron Foundry etc.* **148** 63
 gear *Road Constr.* **201** 11
 gear *Hydr. Eng.* **217** 48
 gear, epicyclic ~ **143** 94
 gear, planetary ~ **143** 94
 gearbox *Agr. Mach.* **65** 79
 gearbox *Turner* **135** 4

gearbox *Cotton Spin.* **164** 2, 33, 39
 gearbox, five-speed ~ **189** 6
 gear-change *Agr. Mach.* **65** 35
 gear-change *Motorcycles etc.* **188** 31
 gear-change, floor-type ~ **191** 91
 gear-change, two-speed ~ **188** 12
 gear-change lever **189** 28
 gear-change pattern **192** 47
 gear control **149** 2
 gearing *Agr. Mach.* **64** 50, 65
 gearing *Overh. Irrign.* **67** 21
 gearing *Road Constr.* **201** 11
 gearing, helical ~ **143** 89
 gearing, multi-speed ~ **190** 72
 gearing, multi-step ~ **190** 72
 gear lever **191** 91; **192** 46
 gear meter **76** 4
 gears *Agr. Mach.* **64** 50, 65
 gears *Overh. Irrign.* **67** 21
 gear shaft **232** 58
 gear shaft, intermediate ~ **190** 57
 gearshift **65** 23, 35; **188** 31
 gearshift, two-speed ~ **188** 12
 gearshift lever *Motorcycle* **189** 28
 gearshift lever *Car* **191** 91; **192** 46
 gearshift pattern **192** 47
 gearshift rod **192** 41
 gearshift switch **134** 46
 gear wheel, helical ~ **192** 34, 36, 39, 43
 gear wheel, herringbone ~ **143** 87
 gear wheel, stepped ~ **143** 82
 gear wheels **143** 82-96
 gecko **364** 36
 Geiger counter **2** 19
 Geiger-Müller counter **2** 19
 geisha **353** 39
 gelatine **316** 49
 gelding **73** 2
 Gemini **3** 28; **4** 55
 general cargo ship **225** 14; **226** 13
 general cargo transit shed **225** 9
 general practice **22** 1-74
 general practitioner **23** 2
 general service lamp **127** 56
 generator *Nucl. Energy* **154** 15, 47, 53
 generator *Energy Sources* **155** 46
 generator *Intern. Combust. Eng.* **190** 76
 generator *Railw.* **211** 46
 generator *Ship* **223** 74
 generator exhaust **146** 2
 generator unit **231** 33
 Geneva movement **312** 38
 Genoa jib **284** 16
 genouillère **329** 53
 gentleman *Café* **265** 22

gentleman *Hist. Cost.* 355 54, 61, 73
 'gentlemen' 233 47
 'gentlemen's toilet' 233 47
 geodesy 14 46-62
 geography, physical ~ 11; 12; 13
 geology 12 1-33
 geometrical shape 260 79
 geometrid 80 16; 82 28
 geometry 346; 347
 geometry, elementary ~ 346 1-58
 geometry, Euclidian ~ 346 1-58
 geranium 53 1
 gerbera 51 26
 germ 370 86
 German hand 342 11
 German pointer 70 40
 German sheepdog 70 25
 German shepherd 70 25
 geyser *Phys. Geog.* 11 21
 geyser *Plumb. etc.* 126 12-13
 G flat major 320 68
 gherkin, pickled ~ 98 29
 giant 306 63; 308 20; 327 37
 gib *Plumb.* 125 3
 gib *Mach. Parts etc.* 143 74
 gig 186 34
 gig, four-oared ~ 283 26-33
 Gigantocypris agassizi 369 1
 gilder 183 2
 gilding *Painter* 129 40
 gilding *Bookbind.* 183 1
 gilding and embossing press 183 26
 gill *Dom. Anim.* 73 24
 gill *Edib. Fungi* 381 4, 6
 gill, tufted ~ 364 19
 gill cleft 364 3
 gill cover 364 5
 gill slit 364 3
 gillyflower 60 7
 gimbal ring 224 50
 gimbal suspension 241 23
 gimlet 120 65
 gimping 102 28
 gimping needle 102 29
 gingerbread 97 51
 gipsy girl 306 36
 gipsy moth 80 1
 giraffe 367 4
 giraffe house 356 10
 girder, steel ~ 143 3-7
 girdle 32 5
 girdle clasp 328 24
 girl, exotic ~ 306 30
 girt 120 50
 girth 71 18, 36; 289 11
 girth, emergency ~ 71 23
 girth, second ~ 71 23
 glacier *Phys. Geog.* 12 49
 glacier *Mountain.* 300 22
 glacier snout 12 51
 glacier table 12 56
 gladiolus 51 28; 60 11
 gland, bulbourethral ~ 20 75
 gland, parotid ~ 19 9
 gland, pituitary ~ 17 43
 gland, prostate ~ 20 76

gland, submandibular ~ 19 11
 gland, submaxillary ~ 19 11
 gland, suprarenal ~ 20 29
 gland, thyroid ~ 20 1
 glans penis 20 69
 glass 54 9
 glass, armoured ~ 109 29
 glass, bullet-proof ~ 250 3
 glass, coloured ~ 260 68
 glass, crystal ~ 45 86
 glass, frosted ~ 124 5
 glass, laminated ~ 124 5
 glass, lined ~ 124 6
 glass, molten ~ 162 23, 31, 50
 glass, ornamental ~ 124 6
 glass, patterned ~ 124 5
 glass, pulverized ~ 340 48
 glass, raw ~ 124 6
 glass, shatterproof ~ 124 5
 glass, stained ~ 124 6; 330 15
 glass, tapered ~ 45 85
 glass, thick ~ 124 5
 glass, wired ~ 124 6
 glassblower 162 38
 glassblowing 162 38-47
 glass case 356 15
 glass cloth 130 29
 glass cutter, diamond ~ 124 25
 glass cutter, steel ~ 124 26
 glass cutters 124 25-26
 glass-drawing machine 162 8
 glasses 111 9
 glass fibre, production of ~ 162 48-55
 glass fibre products 162 56-58
 glass filament 162 52
 glass forming 162 38-47
 glass furnace 162 1, 49
 glass holder 124 9
 glasshouse pot, covered ~ 162 46
 glassmaker 162 38
 glassmaking 162 38-47
 glass mosaic picture 260 69
 glass paper 135 25
 glass pliers 124 19
 glass ribbon 162 10
 glass sponge 369 7
 glass wool 162 58
 glassworker 124 8
 glazier 124; 124 8
 glazing sheet 116 58
 glazing sprig 124 24
 glede 362 11
 glider 287 3
 glider, high-performance ~ 287 9
 glider, motorized ~ 287 8
 glider, powered ~ 287 8
 glider field 287 13
 gliding 287
 globe 42 13
 globe, frosted glass ~ 267 4
 globe, solar ~ 4 36
 globe, terrestrial ~ 4 8
 globe artichoke 57 41
 globe lamp 267 4
 globe thistle 53 14
 glove 33 67; 292 12; 298 47; 318 31
 glove, catcher's ~ 292 60

glove, fielder's ~ 292 59
 glove, goalkeeper's ~ 291 19
 glove box lock 191 89
 glove compartment lock 191 89
 glove stand 271 20
 glow plug 190 66
 gloxinia 53 7
 glue 48 4; 260 50-52, 51
 glue, joiner's ~ 132 13
 glue-enamel plate 179 32
 glue pot 132 12, 13; 183 15; 236 5; 260 57
 glue roller 185 33
 glue size 128 4
 glue tank 184 9; 185 32
 glue well 132 13
 gluing 183 14
 gluing machine 185 31
 gluing mechanism 184 4
 glume 68 11
 gluteus maximus 18 60
 G major 320 56
 G minor 320 64
 gnat 358 16
 goaf 144 37
 goal *Playground* 273 11
 goal *Swim.* 282 46
 goal *Ball Games* 291 35; 292 7
 goal *Winter Sp.* 302 37
 goal area 291 5
 goalkeeper *Playground* 273 14
 goalkeeper *Swim.* 282 47
 goalkeeper *Ball Games* 291 10; 292 8
 goalkeeper *Winter Sp.* 302 36
 goal kick 291 38
 goal line 291 7
 goalpost 273 11; 291 37
 goal scorer 273 13
 Goat *Astron.* 3 36; 4 62
 goat *Dom. Anim.* 73 14
 goat beard 34 10
 goat's beard *Forest Plants etc.* 377 5
 goat's beard *Edib. Fungi* 381 32
 goatsbeard *Edib. Fungi* 381 32
 goat willow 371 24
 gob *Coal* 144 37
 gob *Glass Prod.* 162 40
 gobbler 73 28
 goblet, hand-blown ~ 162 41
 gobo 310 51
 gob of molten glass 162 23, 31
 go-cart 273 33
 god, Indian ~ 337 19
 godet 30 52
 Godet wheel 169 16
 godparent 332 13
 God's acre 331 21-41
 'GO' gauging member 149 57
 goggles 140 21; 303 15
 going about 285 27
 go-kart 305 83
 go-karting 305 82
 gold *Heraldry* 254 24
 gold *Crystalx* 351 6
 gold and silver balance 108 35

goldcrest 361 10
 goldcup 375 8
 gold cushion 183 6
 golden chain 374 32
 golden crested wren 361 10
 golden maidenhair 377 17
 golden oriole 360 7
 golden rain 374 32
 goldfinch 360 1
 gold finisher 183 2
 gold knife 183 7
 gold leaf 129 45, 52; 183 5
 gold size 129 44
 goldsmith 108 17
 golf 293 79-93
 golf ball *Office* 249 15
 golf ball *Ball Games* 293 89
 golf ball cap 249 30
 golf ball typewriter 249 1
 golf course 293 79-82
 golfer 293 83
 golf trolley 293 85
 gondola *Supermkt.* 99 23, 43, 62
 gondola *Railw.* 214 20
 gondola *Airsports* 288 64
 gondola cableway 214 19
 gonfalon 253 12
 goods 271 10
 goods, bulky ~ 206 18
 goods, general ~ 206 4
 goods depot 15 91
 goods tonnage 206 15
 goods office 206 26
 goods shed 206 7, 26-39
 goods shed door 206 37
 goods shelf 47 36; 98 14
 goods station 206
 goods van 206 6; 213 22
 goods van, covered ~ 213 14
 goods wagon, covered ~ 213 14
 goods wagon, open ~ 213 8
 goosander 359 15
 goose 73 34; 272 52
 gooseberry 58 9
 gooseberry bush 52 19; 58 1
 gooseberry cane, flowering ~ 58 2
 gooseberry flan 97 22
 gooseberry flower 58 6
 goosefoot 61 25
 gooseneck 284 37
 gorge 13 52
 gorgerin 334 22
 gorget 329 43
 gorilla 368 16
 goshawk 362 10
 'GO' side 149 60
 gosling 73 34
 gouache 338 17
 gouge 132 9; 135 15; 339 17
 gouge, U-shaped ~ 340 6
 gouge, V-shaped ~ 339 20; 340 9
 gourd 354 27
 governor 224 56
 gown 105 34; 106 4; 355 25, 36, 66
 gown, linen ~ 355 5

gown, open ~ 355 50
 gown, sleeveless ~ 355 50
 graben 12 11
 grace notes 321 14-22
 graces 321 14-22
 grade crossing, protected ~ 202 39
 grade crossing, unprotected ~ 202 49
 grade crossings 202 39-50
 grader 200 19
 grader levelling blade 200 21
 grader ploughshare 200 21
 gradient 347 12
 grading 74 44
 grading, automatic ~ 74 52
 graduated measuring rod 14 47
 graduation house *Map* 15 32
 graduation house *Spa* 274 1
 graftage 54 30-39
 grafting 54 30-39
 grain *Arable Crops* 68 1-37, 4, 37
 grain *Brew.* 92 50
 grain *Graphic Art* 340 47
 grain, farinaceous ~ 68 13
 grain auger 64 20
 grain harvest 63 31-41
 grain leaf 68 8, 19
 grain lifter 64 2
 grain pest 81 27
 grain tank 64 23
 grain tank auger 64 24
 grain tank unloader 64 25
 grain unloader spout 64 26
 grain weevil 81 16
 grammar school 261 1-45
 gramophone 309 31
 gramophone box 309 35
 gramophone needle 309 33
 gramophone record 309 32
 granary weevil 81 16
 grand 325 40
 grandee 306 26
 grandfather clock 110 24; 309 56
 grand piano 325 40
 grand piano pedal 325 41
 grandstand, glass-covered ~ 289 34
 granite 302 42
 gran turismo car 193 32
 granular texture 340 47
 grape 80 21; 99 89
 grape-berry moth 80 22, 23, 24
 grape crusher 78 17
 grapefruit 384 23
 grape gatherer 78 11
 grape phylloxera 80 26
 grapevine *Wine Grow.* 78 2-9
 grapevine *Sports* 299 10
 grape worm 80 23, 24
 graphic art 340
 graphic art studio 340 27-64
 graphite 1 54
 grapnel 218 11
 grapple 218 11
 grappling iron 218 11
 grasp, kinds of ~ 296 40-46

grasping arm 2 47
 grass 136 26
 grass, paniculate ~ 69 27
 grassbox 56 29
 grasshopper, artificial ~ 89 68
 grassland 15 18
 grassland, marshy ~ 15 19
 grassland, rough ~ 15 5
 grass ledge 300 4
 grass shears 56 48
 grass snake 364 38
 grasstrack racing 290 24-28
 grass verge 200 56
 grate 199 33
 graticule *Map* 14 1-7
 graticule *Hunt.* 87 31-32
 graticule *Photomech. Reprod.* 177 4
 graticule adjuster screw 87 30
 graticule system 87 31
 grating 141 14
 grating spectrograph 5 5
 graupel 9 35
 grave *Church* 331 23, 34
 grave *Script* 342 31
 grave, child's ~ 331 29
 grave, soldier's ~ 331 32
 grave digger 331 22
 gravel 118 36; 119 26
 gravel filter layer 199 23
 grave mound 331 24
 graver 175 33; 340 5
 graver, round-headed ~ 340 20
 gravestone 331 26
 graveyard 331 21-41
 graveyard chapel 331 28
 graveyard gate 331 19
 graveyard wall 331 18
 gravity fault 12 7
 gravity fuelling point 257 32
 gravity hammer, air-lift ~ 139 24
 gravity mixer 118 33
 gravure cylinder 182 10
 gravure cylinder, etched ~ 182 22
 gravure cylinder, printed ~ 182 17
 gravure etcher 182 18
 gravure printing 182
 gravy boat 45 17
 gravy ladle 45 18
 gray see grey
 grayhound 70 24
 grease gun 195 30
 grease nipple 143 81
 greasepaint stick 315 46
 greasy chalk 340 26
 great apes 368 14-16
 Great Bear 3 29
 great brain 17 42; 18 22
 Great Dane 70 14
 Great Dog 3 14
 Greater Bear 3 29
 greater burnet saxifrage 69 28
 Greater Dog 3 14
 greater water newt 364 20
 great hall 329 30
 great horned owl 362 15
 great mullein 376 9

great primer 175 30
great tit 361 9
great titmouse 361 9
greave 329 54
Greek 355 3
Greek woman 355 1
green *Ball Games* 293 82
green *Colour* 343 8
green bowls 305 21
green cloth 277 15
green cormorant 359 10
greenfly 358 13
greengage 59 24
green grasshopper 358 8
greenhouse, heated ~ 55 32
greenhouse, polythene ~ 55 40
greenhouse, unheated ~ 55 33
green liquor, unclarified ~ 172 41
green liquor preheater 172 43
green locust 358 8
green oak roller moth 82 43
green oak tortrix 82 43
green plover 359 21
Greenwich meridian 14 5
grenzanthydrite 154 67
Gretchen style 34 31
greyhound 70 24
grey scale 343 15
grey sea eagle 362 5
grid *Cotton Spin.* 163 26
grid *Water* 269 11
grid *Theatre* 316 4
grid hearth 139 1
gridiron 316 4
griffin 327 11
grill *Painter* 129 12
grill *Station* 204 38
grill *Fair* 308 33
grinder *Painter* 129 29
grinder *Metalwkr.* 140 18
grinder, continuous ~ 172 53, 66
grinder, pneumatic ~ 148 44
grinder chuck 157 46
grinding, hollow ~ 302 22
grinding cylinder 161 1
grinding disc 340 46
grinding machine 140 18
grinding machine, universal ~ 150 1
grinding machine bed 150 6
grinding machine table 150 7
grinding-roller bearing 163 41
grinding stone *Paperm.* 172 71
grinding stone *Ethnol.* 354 24
grinding wheel *Dent.* 24 36
grinding wheel *D.I.Y.* 134 23
grinding wheel *Blacksm.* 137 19; 138 8
grinding wheel *Metalwkr.* 140 19
grinding wheel *Mach. Tools* 150 4
grinding wheel *Sawmill* 157 43
grindstone 172 71
grip *Photog.* 114 37

grip *Cine Film* 117 61
grip *Bicycle* 187 3
grip *Navig.* 224 9
grip *Rowing* 283 35
grip *Athletics* 298 45
grip *Winter Sp.* 301 6
grip *Sports* 305 57
grip *Films* 313 21
gripper 180 65
gripper bar 180 56
gripping jaw 149 36
grip sole 101 19
grist 92 42
grit guard 148 40
gritter, self-propelled ~ 200 41
grocer 98 41
grocer's shop 98 1-87
groceryman 98 41
grocery store 98 1-87
groin *Man* 16 38
groin *see* groyne
groin vault 335 31-32; 336 42
groom *Carriages* 186 27
groom *Church* 332 16
groove *Iron Foundry etc.* 148 59
groove *Sawmill* 157 6
groove *Ball Games* 291 29
groove *Winter Sp.* 301 39
groove *Music. Instr.* 326 13
groove *Art* 334 27
groove, anal ~ 16 41
grooving 157 6
groschen 252 13
Grotesque 342 7
grotto 272 1
ground 123 9
ground, fallow ~ 63 1
ground, icy ~ 304 19
ground avalanche 304 1
ground control 6 44
ground floor 37 2; 118 7
ground-floor landing 123 23
ground game 86 35
ground ivy 375 18
ground layer 7 7
ground nut 383 41
ground-nut oil 98 24
ground power unit 233 22
groundsheet ring 278 26
ground signals 288 52-54
ground state level 1 18
ground tackle 223 49-51
groundwater 12 21
groundwater level 269 1, 42, 63
groundwater stream 269 3
groundwood 172 68
groundwood mill 172 53-65
groundwood pulp 172 77, 78
group 260 3; 268 60
group instruction 242 1
group selector switch 238 42
grove 354 5
grower 55 20
grower, commercial ~ 55 20
growing stock 74 1
growler 186 26
growth, annual ~ 372 25
groyne *Phys. Geog.* 13 37

groyne *Rivers* 216 19
groyne head *Phys. Geog.* 13 38
groyne head *Rivers* 216 20
grub 58 64; 77 29; 81 20; 358 9; 80 6, 19, 36, 41, 46, 53, 54; 82 25, 36
grubber 55 21; 65 55
grub screw 143 48
Grus 3 42
G sharp minor 320 60
GT car 193 32
guanaco 366 30
guard *Blacksm.* 138 9
guard *Metalwkr.* 140 20
guard *Fencing* 294 35, 38, 43
guard, king's ~ 306 68
guard, protective ~ 168 45
guard board 118 29
guard cam 167 57
guard for V-belt drive 180 58
guard iron 210 34
guard netting 118 90
guard rail *Roof & Boilerr.* 38 28
guard rail *Agr. Mach.* 64 55
guard rail *Forestry* 84 8
guard rail *Floor etc. Constr.* 123 53
guard rail *Weaving* 165 31
guard rail *Railw.* 202 23
guard rail *Ship* 221 121
guard rail *Shipbuild.* 222 66
gudgeon pin 192 26
guelder rose 373 10
guest rope 227 14
gugelhufl 97 33
guide 23 21
guide, stationary ~ 243 21
guide bar *Cotton Spin.* 164 17
guide bar *Weaving* 165 38
guide bearing 113 14
guide block 174 48; 176 18
guide chain 65 13
guide-chain crossbar 65 12
guide dog 70 25
guide groove 217 75
guide notch 117 36
guide pin 243 21
guide post 15 110
guide rail *Weaving* 165 3
guide rail *Railw.* 214 56
guide rail *Store* 271 54
guide rod 200 27
guide roller *Sawmill* 157 5
guide roller *Cotton Spin.* 164 18
guide roller *Films* 312 29
guide step 117 36
guide tractor 141 19
guiding blade 322 40
guiding roller 312 29
guiding slot *Weaving* 165 11
guiding slot *Music. Instr.* 322 41
guilder 252 19
guillemet 342 27
guillemot 359 13
guillotine *Plumb.* 125 26
guillotine *Bookbind.* 183 16; 185 1

guillotine cutter, automatic ~ 185 1
guinea fowl 73 27
guinea pig 366 12
guiro 324 60
guitar 318 8; 324 12, 73
guitarist 318 9
guitar player 318 9
gulden 252 19
gules 254 27
Gulf Stream 14 30
gull 359 14
gullet *Man* 17 49; 20 23, 40
gullet *Bees* 77 19
gullet *Forestry* 84 28
gull wing, inverted ~ 229 14
gully 12 44
gum 19 15
gun 218 50
gun, pneumatic ~ 94 3
gun, self-cocking ~ 87 23
gun, self-propelled ~ 255 57
gun barrel, rifled ~ 87 34
gun carriage 255 43
gun carriage, self-propelled ~ 255 49-74
gun dog 86 7
gunnel 283 30
gunport 218 59
gunport shutter 218 60
gun slit 86 72
gun turret 258 29
gunwale 283 30
gutta-percha tree 383 37
gutter *Dwellings* 37 6, 11
gutter *Roof & Boilerr.* 38 9
gutter *Roof* 122 28, 92
gutter *Bookbind.* 185 55
gutter *Street Sect.* 198 10
gutter, parallel ~ 122 83
gutter bracket 122 32
guy *Wine Grow.* 78 8
guy *Camping* 278 23
guy line 278 23
guy pole 152 31
guy wire *Wine Grow.* 78 8
guy wire *Energy Sources* 155 44
gybe 285 28
gybing 285 26
gymkhana 290 32
gymnastic ball 297 34
gymnastic club 297 38
gymnastic hoop 297 46
gymnastic ribbon 297 49
gymnastics 297 33-50
gymnastics, men's ~ 296 1-11
gymnastics, Olympic ~ 296 1-11; 297 1-6
gymnastics, women's ~ 297 1-11; 297 1-6
gymnastics apparatus 296 51-52
gym shoe 296 63; 297 52
gym trousers 296 62
gypsum *Sculpt. Studio* 339 29
gypsum *Crystals* 351 24, 25
gypsum crusher 160 14
gypsum powder 339 29
gypsum store 160 13

gyro compass 224 31, 51-53
gyro compass unit 224 51-53
gyrodyne 232 29
gyro horizon 230 3
gyro repeater 224 52

H

habergeon 329 51
habit, monk's ~ 331 55
hack 186 26
hacking knife 128 37
hackney carriage 186 26
hackney coach 186 26
hacksaw 134 3, 17; 136 40; 138 23; 140 9; 150 14
hacksaw frame 126 71
haematite 108 48
haft 137 30
hail 9 36
hail, soft ~ 9 35
hair 16 3
hair, bobbed ~ 34 34
hair, closely-cropped ~ 34 11
hair, curled ~ 34 33
hair, curly ~ 34 18
hair, long ~ 34 1
hair, pinned-up ~ 34 28
hair, shingled ~ 34 34
hair, swept-back ~ 34 28
hair, swept-up ~ 34 28
hairbell 375 14
hairbrush 28 7; 105 10
haircap moss 377 17
hair clip 105 11
hair curler 106 31
haircut 106 3
haircuts 34 1-25
haircutting scissors 105 7; 106 34
hair decoration 355 82
hairdress 354 9
hairdresser 105 35; 106 1
'hairdresser' *Airport* 233 53
hairdresser, ladies' ~ 105
hairdresser, men's ~ 106
hairdresser's tools 105 1-16
hairdressing salon, ladies' ~ 105 1-39
hairdressing salon, men's ~ 106 1-42
hair drier, hand-held ~ 105 33; 106 22
hair element 10 9
hair-fixing spray 105 24
hair moss 377 17
hairpin *Needlewkr.* 102 29
hairpin *Winter Sp.* 301 69
hairpin work 102 28
hair sieve 260 66
hair spray 105 24
hairstyle 106 3
hairstyles 34 1-25
hairstyles, girls' ~ 34 27-38
hairstyles, ladies' ~ 34 27-38
hairstylist 310 36; 315 48
hair tonic 106 10
hair trigger 87 12
hairworm 80 51
hake 65 19

hake chain 65 17
half-barrier crossing 202 45
half chicken 266 56
half mask 306 13
half-moon 4 4, 6
half nonpareil 175 20
half note 320 14
half nut 149 19
half rest 320 22
half-step 320 50, 52
half-title 185 43, 44
halftone dot 178 39
half-way line 291 3
hall 41 1-29
hall, main ~ 236 1-30; 250 1-11
halliard 253 2
hall manager 275 7
hall mirror 41 6
hall of mirrors 308 55
Hallstatt period 328 21-40
hallux 19 52
halma 276 26-28
halma board 276 26
halma man 276 28
halma piece 276 28
halogen lamp 177 31
halothane container 26 26
halt 15 27
halter 71 7-11
halter top 31 64
halved joint 121 86
halving joint 121 86
halyard 253 2
ham 95 51
hame 71 14
hammer 85 5; 126 78; 134 7; 137 26; 139 26
hammer *Army* 255 4
hammer *Athletics* 298 42
hammer *Music. Instr.* 322 35; 325 3
hammer *Graphic Art* 340 14
hammer, anvil and stirrup 17 61
hammer, bricklayer's ~ 118 53
hammer, brickmason's ~ 118 53
hammer, carpenter's ~ 120 74
hammer, flat-face ~ 137 35
hammer, glazier's ~ 124 18
hammer, iron-headed ~ 339 16
hammer, machinist's ~ *D.I.Y.* 134 40
hammer, machinist's ~ *Metalwkr.* 140 23
hammer, shoemaker's ~ 100 37
hammer, stonemason's ~ 158 35
Hammer and Sickle 253 21
hammer axe 300 37
hammer blow 293 78
hammer crusher *Quarry* 158 20
hammer crusher *Cement Wks.* 160 2
hammer cylinder 139 30
hammer drill 158 11

- hammer drill, electric ~ 134 43
 hammer forging 139
 hammer guide 139 29
 hammer head *Airsports* 288 4
 hammer head *Athletics* 298 43
 hammer head, felt-covered ~ 325 24
 hammer jack 325 30
 hammer lever 325 30
 hammer mill 160 2
 hammer rail 325 15, 26
 hammer shank 325 25
 hammer throw 298 42-47
 hammock 278 4
 ham on the bone 96 1; 99 52
 hamper 306 11
 hamster 366 16
 hand 16 47, 48; 17 15-17; 19 64-83
 hand apparatus 297 33-50
 hand axe 328 1
 handball 292 1
 handball player 292 2
 hand bindery 183 1-38
 handbook 262 17
 hand bookbinding 183 1-38
 hand brace 140 13
 hand brake 187 5; 191 72; 212 33
 hand brake lever 188 33; 191 93
 hand brake wheel 212 64, 80
 hand camera, large-format ~ 114 36
 handcart 120 6
 handcart, wooden ~ 309 86
 hand circle 297 47
 hand circling 297 37
 handclap 117 69
 hand-composing room 174 1
 hand compositor 174 5
 hand control 195 8
 hand cream 99 27
 hand cultivator 55 21
 hand die 126 85
 hand die, electric ~ 125 12
 hand drill 140 13
 hand flat knitting machine 167 35
 hand gallop 72 42
 hand glass *Hairdresser* 105 23; 106 7
 hand glass *Optics* 111 16
 handgrip *Photog.* 114 37
 handgrip *Cine Film* 117 5, 61
 handgrip *Bicycle* 187 3
 handgrip *Navig.* 224 9
 handgrip *Films* 313 21, 24, 38
 hand guard 94 10
 hand hair drier 105 33; 106 22
 hand hammer, blacksmith's 137 23
 hand harpoon 280 40
 handcraft 48 3
 hand-ironing pad 104 30
 hand-iron press 103 18
 handkerchief 33 10
 hand ladle 148 23
 hand lamp 270 42
 hand lance 83 46
 handle *Atom* 2 39
 handle *Hosp.* 26 12
 handle *Infant Care etc.* 28 50
 handle *Tablew. etc.* 45 51, 59, 62
 handle *Household* 50 9, 63
 handle *Market Gdn.* 55 27
 handle *Agr. Mach.* 65 2
 handle *Agr. Impl.* 66 17
 handle *Pest Contr.* 83 19
 handle *Forestry* 85 3
 handle *Hairdresser* 106 37
 handle *Joiner* 132 10, 18
 handle *D.I.Y.* 134 47
 handle *Metalwkr.* 140 5
 handle *Carriages* 186 12
 handle *School* 260 8
 handle *Motorboats etc.* 286 48
 handle *Fencing* 294 41
 handle *Athletics* 298 44
 handle *Sports* 305 57, 80
 handle, bound ~ 89 55
 handle, cork ~ 89 50
 handle, double ~ 148 15
 handle, fixed ~ 129 7
 handle, insulated ~ 127 54
 handle, tubular ~ 50 64
 hand lead 224 58
 handlebar 187 2; 188 45
 handlebar, adjustable ~ 188 3
 handlebar, semi-rise ~ 188 11
 handlebar fittings 188 30-35
 handlebar grip 187 3
 handlebar moustache 34 8
 handlebars 34 8
 handlebar stem 187 10
 handler 264 5
 hand lever *Joiner* 132 55
 hand lever *Bookbind.* 183 31
 hand-lever press 183 26
 hand luggage 194 19
 hand mirror *Hairdresser* 105 23; 106 7
 hand mirror *Optics* 111 16
 hand net 89 2
 handpiece 24 6
 hand press 340 29
 hand pump 83 26; 269 66
 hand puppet 260 74
 handrail *Roof & Boilerr.* 38 28
 handrail *Hall* 41 23
 handrail *Floor etc. Constr.* 123 53, 79
 handrail *Ship* 221 122
 handrailing 215 70
 hand rammer 148 32
 hand-removing tool 109 10
 handrest 112 58
 hand sail 302 28
 hand saw 120 60; 126 72; 134 27
 handscrew 132 14
 handset 237 7; 245 15
 handset cord 237 14
 handset cradle 237 13
 hand-setting room 174 1
 hand shank 148 14
 hand shears *Tailor* 104 11
 hand shears *Bldg. Site* 119 87

- hand signal 268 33
 handsledge 304 29
 hand spray *Pest Contr.* 83 24
 hand spray *Hairdresser* 105 30; 106 13
 hand spray *Painter* 129 35
 hand spray *Offset Platem.* 179 7
 handspring 297 22
 handstamp 236 45
 handstand 295 27; 296 52
 handstand dive 282 45
 hand steel shears 119 22
 handstrap, leather ~ 296 47
 hand-to-hand throw 297 33
 hand towel 28 9; 49 23; 106 24
 hand vice 140 24
 hand weapons 255 1-39
 handwheel *Shoem.* 100 24
 handwheel *Cooper* 130 19
 handwheel *Cotton Spin.* 163 18
 handwheel *Knitting* 167 7, 30
 handwheel *Paperm.* 172 74
 handwheel *Bookbind.* 183 23
 handwheel *Road Constr.* 201 9
 handwriting, English ~ 342 10
 handwriting, German ~ 342 11
 hang 296 33, 35; 298 41
 hangar 287 14
 hanger 215 41
 hang glider 287 44
 hang glider pilot 287 45
 hang gliding 287 43
 Hansa cog 218 18-26
 Hansa ship 218 18-26
 hansom 186 29
 hansom cab 186 29
 harbour 216 14; 225; 226
 harbour ferry 225 11
 harbour tunnel 225 55
 hardboard 338 22
 hardcore 123 12
 hardener 130 33
 hardie 137 32
 hard-rock drill 158 11
 hard-top 193 26
 hardwood cutting 54 25
 hardy 137 32
 hare 86 35; 88 59
 hare-and-hounds 289 41-49
 harebell 375 14
 hare call 87 44
 hare hunting 86 34-39
 harlequin 306 35
 harmonica 324 35
 harmonium 325 43
 harmonium case 325 47
 harmonium keyboard 325 48
 harness *Horse* 71 7-25
 harness *Airsports* 288 43
 harness horse racing 289 23-40
 harness of diving apparatus 279 12
 harness racing 289 23-40
 harness racing track 289 23
 harp 323 60

- harpoon 353 10
 harpoon, bone ~ 328 3
 harpoon thrower 328 5
 harpsichord 322 45
 harpsichord mechanism 322 48
 harpy 254 35; 327 55
 harrow, disc ~ 65 82
 harrow, rotary ~ 65 89
 harrow, spike-tooth ~ 65 88
 harrow, three-section ~ 65 88, 89
 hasp 71 14
 hat 35 9
 hat, Alpine ~ 35 23
 hat, felt ~ 35 15, 24; 355 55
 hat, fox ~ 35 19
 hat, hard ~ 289 18
 hat, huntsman's ~ 86 5
 hat, iron ~ 329 59
 hat, knitted ~ 35 10
 hat, ladies' ~ 41 11
 hat, lightweight ~ 35 37
 hat, loden ~ 35 23
 hat, men's ~ 35 13
 hat, mink ~ 35 18
 hat, mohair ~ 35 6, 11
 hat, paper ~ 306 45
 hat, pleader's ~ 319 20
 hat, sailor's ~ 309 63
 hat, Thessalonian ~ 355 4
 hat, three-cornered ~ 355 62
 hat, trilby style ~ 35 14
 hat, Tyrolean ~ 35 24
 hat, wide-brimmed ~ 35 38; 355 55
 hat, woollen ~ 29 57; 35 10, 26
 hat and light luggage rack 208 28
 hat box 205 11
 hatch *Roof & Boilerr.* 38 14
 hatch *Roof* 122 24
 hatch *Post* 236 30
 hatchback 193 18
 hatchboard 222 65
 hatch coaming 222 64
 hatch cover 222 65
 hatcher 74 30
 hatchery 89 11-19
 hatchet 270 43
 hatchet iron 125 5
 hatching compartment 74 30
 hatching jar 89 17
 hatching tray 74 31, 32
 hatchment 254 1-6
 hatch platform 6 34
 hatchway 222 64-65
 hatchway, main ~ 259 86
 H atom 1 26
 hat peg 266 13
 hats, ladies' ~ 35 1-21
 hats, men's ~ 35 22-40
 hat shop 268 38
 hatter's shop 268 38
 haubergeon 329 51
 haulage *Forestry* 85 42
 haulage *Rivers* 216 27
 haulage cable *Railw.* 214 14, 26, 37, 42, 45

- haulage cable *Winter Sp.* 301 63
 haulage cable driving pulley 214 62
 haulage cable guide wheel 214 61
 haulage cable roller 214 32, 49, 60
 haulage cable sleeve 214 73
 hauling 216 27
 hauling capstan 217 22
 haulm conveyor 64 76
 haulm conveyor agitator 64 77
 haulm conveyor drive 64 78
 haulm elevator 64 90
 haulm stripper 64 73
 haulm stripper, flexible ~ 64 76
 haulyard 253 2
 haunch *Horse* 72 35
 haunch *Game* 88 21, 37
 haunch jump 282 14
 Hauptwerk 326 1, 43
 hautboy 323 38
 haute école 71 1-6
 Havana cigar 107 2
 Hawaii girl 306 16
 hawk, male ~ 86 46
 hawkbells 276 45
 hawk *308* 12, 51
 hawking 86 42-46
 hawkmoth 82 27; 358 55; 365 9
 hawkbill turtle 364 28
 hawse 222 75
 hawse hole 227 11
 hawse pipe 222 76; 258 54
 hawthorn 374 30
 hay 75 13
 hay, tedded ~ 63 25
 hay fork, three-pronged ~ 66 3
 hay harvest 63 19-30
 haymaking 63 19-30
 hay rack, double ~ 75 12
 hayrake 66 23
 hay tripod 63 30
 hazard flasher 191 76
 hazard flasher switch 191 68
 hazel 59 49
 hazel branch, flowering ~ 59 44
 hazel bush 59 44-51
 hazel grouse 88 69
 hazel hen 88 69
 hazel leaf 59 51
 hazelnut 59 49
 hazel tree 59 44-51
 H-beam 143 6
 head *Man* 16 1-18; 17 42-55
 head *Arable Crops* 68 2
 head *Horse* 72 1-11
 head *House Insects etc.* 81 33, 36
 head *Forest Pests* 82 2
 head *Game* 88 12
 head *Brew.* 93 31
 head *Tobacc. etc.* 107 23
 head *Carp.* 120 58
 head *Roof* 122 87

- head *Mach. Parts etc.* 143 14, 52
 head *Weaves* 171 31
 head *Composing Rm.* 175 39
 head *Hydr. Eng.* 217 25
 head *Restaurant* 266 4
 head *Music. Instr.* 323 52; 324 10
 head *Prehist.* 328 4
 head *Articulates* 358 28
 head, bald ~ 34 22
 head, binocular ~ 112 12
 head, cock's ~ 327 35
 head, combined ~ 241 59
 head, composite ~ 370 74
 head, countersunk ~ 143 46
 head, eagle's ~ 327 12
 head, goat's ~ 327 18
 head, human ~ 327 21
 head, lion's ~ 327 17
 head, partly bald ~ 34 20
 head, pig's ~ 95 43
 head, rotating ~ 64 52
 head, shrunken ~ 352 30
 head, woman's ~ 327 56
 head and neck 19 1-13
 head badge 187 15
 headband 183 35
 headband, padded ~ 241 67; 261 41
 head bandage 21 3
 head beam 183 21
 headboard *Bedrm.* 43 6
 headboard *Sailing* 284 47
 headbox 173 11
 head cellarman 79 17
 headcheese 96 9
 headdress 354 9; 355 65
 headdress, feather ~ 352 12
 headdress, ornamental ~ 352 12
 head drum 243 19, 27
 header *Carp.* 120 41
 header *Roof* 121 71
 header *Ball Games* 291 46
 header joist 120 41
 header tank 212 78
 head frame 144 3
 headgear 35; 144 1; 302 34
 headguard 299 30
 heading 130 10
 heading bond 118 60
 heading course 118 64
 head interlocking point 171 34
 headlamp 187 7; 189 10; 191 20
 headlight 189 10; 191 20
 head line *Man* 19 73
 headline *Sea Fish.* 90 7
 headline *Script* 342 44
 head margin 185 56
 head of department 271 60
 head of railcar 197 3
 headphone cable 241 71
 headphone cable plug 241 70
 headphone cord 241 71
 headphones 241 66; 249 63; 261 38; 309 24
 headphone socket 117 10; 249 68

headpiece 71 7-11
 head piece 183 21
 headpiece, padded ~ 241 67;
 261 41
 head post 123 54
 headrace 91 41
 head rail 120 58
 headrest *First Aid* 21 13
 headrest *Railw.* 207 67
 headrest, adjustable ~ 191 33;
 207 47
 headrest, integral ~ 193 31
 headrest cushion, down-
 filled ~ 207 68
 head restraint, adjustable ~
 191 33
 head restraint, integral ~ 193
 31
 headset 241 66; 249 63; 261
 38; 309 24
 headset socket 249 68
 headspring 297 27
 headstall 71 7-11
 headstand 295 28
 headstock 150 2
 headstock, geared ~ 149 2
 headstock, movable ~ 150 26
 headstone 331 26
 head support assembly 311 25
 heald, wire ~ 166 27
 heald eyelet 166 28
 heald frame 166 4
 heald frame guide 166 3
 heald shaft 166 4
 heald shaft guide 166 3
 heald shaft guiding wheel 166
 36
 health insurance certificate
 22 9
 heap cloud 8 1, 2, 17; 287 22
 heart 18 14; 20 8, 24-25,
 45-57
 heart cherry 59 5
 hearth *Blacksm.* 137 1-8, 1;
 138 34
 hearth *Iron & Steel* 147 24
 heart line 19 74
 heart plank 120 93
 heart rhythm 25 1
 hearts 276 40, 44
 heartsease pansy 60 2
 heart-shield 254 17
 heartwood *Carp.* 120 84
 heartwood *Bot.* 370 13
 heartwood plank 120 93
 heat 1 55
 heat colour 343 16
 heater 172 32
 heater, electric ~ 174 45; 179
 3
 heater, gas ~ 126 25
 heater, water-controlled ~
 192 60-64
 heater box 192 61
 heater plug 190 55
 heat exchanger *Nucl. Energy*
 154 6, 44
 heat exchanger *Coking* 156
 27
 heat exchanger *Cement Wks.*
 160 4, 6

heat exchanger *Paperm.* 172
 19
 heat exchanger *Car* 192 61
 heat exchanger *Railw.* 207 6;
 209 15; 212 36, 55
 heat exchanger *Warships* 259
 66
 heat exchanger, auxiliary ~
 212 43
 heat exchanger exhaust 160 7
 heat extractor 182 5
 heath 15 5
 heath and moor 15 5
 heather 377 19
 heating, underfloor ~ 356 18
 heating box 183 27
 heating coupling hose 208 20
 heating element 172 32
 heating engineer 126
 heating oil 38 50
 heating oil tank 212 75
 heating pipe 55 8
 heating regulator 207 54
 heating system 207 6
 heating system, hot-water ~
 38 38-81
 heating unit, electric ~ 174 45
 heat pump 155 22
 heat pump system 155 1
 heat reservoir 155 20
 heat-sealing machine 76 27;
 226 12
 heat shield *Motorcycles etc.*
 188 16
 heat shield *Space* 234 5, 20;
 235 8, 40
 heat space 259 93
 heat transfer fluid 155 31
 heaume 254 7
 Heaviside-Kennelly Layer 7
 27
 heavy-duty boot 101 39
 heavy liquor pump 172 34
 heavy vehicle elevator 221 56
 heavy vehicle lift 221 56
 heckelphone 323 38
 heckler 263 15
 heddle, wire ~ 166 27
 heddle eyelet 166 28
 hedge *Map* 15 98
 hedge *Dwellings* 37 59
 hedge *Fruit & Veg. Gdn.* 52 32
 hedge, trimmed ~ 272 37
 hedgehog 366 5
 hedgehog fungus 381 31
 hedge mustard 61 16
 hedge shears 56 49
 hedge trimmer 134 55
 hedge trimmer, battery-
 operated ~ 56 17
 hedge-trimming attachment
 134 55
 heel *Man* 19 63
 heel *Agr. Impl.* 66 15
 heel *Bakery* 97 5
 heel *Shoem.* 100 67
 heel, high ~ 101 28
 heel, raised ~ 101 33
 heelbone 17 27
 heel flap 286 58
 heel trimmer 100 4

heel unit, automatic ~ 301 54
 height adjuster 106 17
 height-adjuster bar 106 17
 height adjustment *Hosp.* 27 3
 height adjustment *Photog.*
 116 34
 height adjustment *Sawmill*
 157 49
 height adjustment crank 64
 57
 height adjustment wheel 132
 60
 height and angle adjustment
 177 21
 height gauge 22 69
 height of shank 175 45
 height of shoulder 175 45
 height scale *Sawmill* 157 60
 height scale *Athletics* 298 20
 height to paper 175 44
 helicon 323 44
 helicopter deck 146 7
 helicopter hangar 221 52; 259
 38
 helicopter landing deck 228
 15
 helicopter landing platform
 259 39, 53
 helicopter platform 221 19
 helicopters 232 11-25
 heliostat 5 29
 heliozoan 357 7
 heliport 146 7
 heliport deck 146 7
 helium atom (model) 1 5
 helium-neon laser 243 57
 helium nucleus 1 30-31
 helium pressure bottle 234 14
 helium pressure vessel 234
 43, 50
 heller 252 27
 hellhound 327 29
 helm 218 13
 helmet *Police* 264 35
 helmet *Equest.* 289 18
 helmet *Ball Games* 292 24
 helmet *Chivalry* 329 39-42
 helmet, barred ~ 254 8
 helmet, fireman's ~ 270 38
 helmet, grilled ~ 254 8
 helmet, protective ~ *Police*
 264 21
 helmet, protective ~
Mountain. 300 53
 helmet, protective ~ *Winter*
 Sp. 302 34
 helmet affronty 254 9
 helmet flower 379 1
 helmet lamp 300 54
 helmets 254 4, 7-9
 helms 254 4, 7-9
 helmsman 224 16
 helper 21 19
 helve 85 3
 hemidemisemiquaver 320 19
 hemidemisemiquaver rest
 320 27
 hemihedron 351 24
 hemipyramid 351 24
 hemisphere, northern ~ 3
 1-35

hemline marker 271 40
 hemlock 379 4
 hemp 383 9
 hem stitch work 102 14
 hen 62 36; 73 19
 hen, fattened ~ 98 7
 henbane 379 6
 hen pheasant 88 77
 herald 329 75
 heraldic beasts 254 15-16
 heraldry 254 1-36
 herb, primulaceous ~ 53 5
 herb, solanaceous ~ 53 6; 379
 7
 Hercules 3 21
 herd 86 15
 Herdsman 3 30
 Herero woman 354 25
 herm 334 35
 herma 334 35
 hermes 334 35
 heron 86 46; 359 18
 herring 364 14
 herringbone 301 26
 herringbone stitch 102 9
 herring drift net 90 2-10
 herring lugger 90 1
 Hessian fly 80 40
 Heterocera 365 7-11
 hexagon 351 15
 hexagonal crystal system 351
 20-22
 hexahedron 351 2
 hexakis-octahedron 351 13
 hexoctahedron 351 13
 H girder 143 6
 hibernation cocoon 80 31
 hide 88 56
 hide, raised ~ 86 14-17, 14
 hide beetle 81 22
 hieroglyphics, ancient
 Egyptian ~ 341 1
 Hi-Fi component 241 13-48
 high 9 6
 high-altitude anorak 300 6
 highball 317 33
 highball glass 267 56
 high bar *Playground* 273 32
 high bar *Gymn.* 296 7
 highboard diver 282 5
 highboard diving 282 40-45
 high chair, baby's ~ 28 33
 high-draft draw frame 164 14
 high-draft speed frame 164
 19
 high-draft system 164 14
 high frequency 7 26
 high-hat cymbals 324 50
 high house 305 75
 high jump 298 9-27
 high jump apparatus 298 32
 high jump equipment 298 32
 high jumper 298 10
 highland Indian 352 23
 high-moor bog 13 19
 high-mountain region 12
 39-47
 high performance sailplane
 287 9
 high-pile lining 101 3
 high-pressure area 9 6

high-pressure belt 9 47
 high-pressure manometer
 141 4
 high-pressure xenon arc
 lamp 312 39
 high-rise handlebar 188 57
 high-riser 188 56
 high school 261
 high school riding 71 1-6
 high seat 86 14
 high-speed plate, automatic ~
 39 15
 high-tension voltage
 indicator 211 29
 high tide 280 7
 high toss 297 35
 high-water line 13 35
 high-water mark 13 35
 highway construction 201
 1-24
 hiking boot 101 18
 hiking stick 284 31
 hiking strap 284 30
 hill *Phys. Geog.* 13 66
 hole *Ball Games* 293 79-82, 87
 hole, elongated ~ 240 17
 hole, square ~ 140 43
 hollowing tool 135 17
 hollow of the throat 16 20
 hollow-shaft boring bit 133
 7
 holly 374 9
 holohedron 351 2
 holster 264 24
 Holy Bible 330 11
 Holy Communion 332 26
 Holy Scripture 330 11
 holy table 330 4
 holy water basin 332 47
 home and overseas news
 section 342 62
 home base 292 53
 home plate 292 53
 home port 286 8
 homogenizer 76 12
 homopteran 358 3
 honey 77 33
 honey, strained ~ 77 62-63
 honey bag 77 18
 honey-bee 77 1-25
 honey cell 77 33
 honeycomb 77 31-43, 45
 honeycomb, artificial ~ 77 42
 honeycomb, natural ~ 77 60
 honeycomb weave 171 29
 honeydew melon 266 50
 honey extractor 77 61
 honey fungus 381 28
 honey gland 59 18
 honey in the comb 77 64
 honey jar 77 63
 honey pail 77 62
 honey sac 77 18
 honey separator 77 61
 honeysuckle 374 13
 honey super 77 45
 honey wrack 378 48
 hood *Infant Care etc.* 28 26
 hood *Child. Clothes* 29 2
 hood *Ladies' Wear* 30 69
 hood *Headgear* 35 2
 hood *Blacksm.* 137 7

hood *Carriages* 186 42
 hood *Car* 191 8
 hood *Garage* 195 36
 hood *Aircraft* 230 39
 hood *Mountain* 300 19
 hood *Church* 331 56
 hood, collapsible ~ 186 52;
 193 10
 hood, convertible ~ 193 10
 hood, detachable ~ 31 21
 hood, falcon's ~ 86 44
 hood, folding ~ 28 35
 hood, protective ~ 157 65
 hood drawstring 29 64
 hood support 195 37
 hoof *Horse* 72 26
 hoof *Game* 88 24
 hoof, horse's ~ 327 42
 hoofprints 86 8
 hook *Roof & Boilerr.* 38 22
 hook *Horse* 71 14
 hook *Shoem.* 100 62
 hook *Oil, Petr.* 145 9
 hook *Sports* 299 33
 hook *Winter Sp.* 301 61
 hook *Sports* 305 18, 46
 hook *Music. Not.* 320 5
 hook, blunt ~ 26 50
 hook, butcher's ~ 96 55
 hook, closed ~ 89 85
 hook, concealed ~ 89 75
 hook, double ~ 89 83
 hook, open ~ 89 83
 hook, treble ~ 89 85
 hookah 107 42
 hook-and-ride band 140 50
 hook ball 305 18
 hook belt 270 44
 hook disgorging 89 40
 hook ladder 270 16
 hooks 89 79-87
 hoop *Airsports* 288 67
 hoop *Ball Games* 292 78
 hoop *Circus* 307 58
 hoopoe 359 25
 hoop of barrel 130 8
 hooter *Motorcycles etc.* 188 53
 hooter *Fire Brig.* 270 7
 hop boiler 92 52
 hop garden 15 114
 hop growing 83 27
 hopper *Agr. Mach.* 64 59
 hopper *Wine Grow.* 78 18
 hopper *Mills* 91 13
 hopper *Cotton Spin.* 163 31
 hopper *Music. Instr.* 325 30
 hopper, endless-floor ~ 64
 84
 hopper barge 226 46
 hopper delivery roller,
 wooden ~ 163 32
 hopper feeder 163 33
 hopsack weave 171 11
 horizon 13 21
 horizon, artificial ~ 230 3
 horizon glass 224 7
 horizon light 316 15
 horizon mirror 224 7
 horizontal bar 296 7
 horizontal boring and milling
 machine 150 25

horizontal deflection module
 240 10
 horizontal eight 288 2
 horizontal linearity control
 module 240 9
 horizontally-opposed twin
 engine 189 47
 horizontal milling spindle
 150 39
 horizontal piano 325 40
 horizontal slow roll 288 8
 horizontal synchronizing
 module 240 7
 horn *Horse* 71 38
 horn *Motorcycles etc.* 188 53
 horn *Car* 191 60
 horn *Railw.* 212 70
 horn *Fire Brig.* 270 7
 horn *Flea Market* 309 34
 horn *Music. Instr.* 323 41
 horn *Invertebr.* 357 31
 horn *Birds* 362 16
 horn, spirally twisted ~ 327 8
 hornbeam 371 63
 horned owl 362 14
 horns 88 29-31
 horse *Horse* 71; 72
 horse *Dom. Anim.* 73 2
 horse *Carp.* 120 18
 horse *Gymn.* 296 1; 297 1
 horse, armoured ~ 319 18
 horse, piebald ~ 289 29
 horse, toy ~ 47 15
 horse, wild ~ 328 7
 horse, winged ~ 327 26
 horse armour 329 83-88
 horse bean 69 15
 horse box 75 2
 horse brush 71 55
 horse chestnut 371 60
 horse chestnut tree 371 58
 horsefish 364 18
 horsehair 323 15
 horsehair brush 100 12
 horse latitudes 9 47
 horsemanship 289
 horse racing 289 50
 horse-radish 57 20
 horse's head 72 1-11
 horseshoe *Game* 88 71
 horseshoe *School* 260 1
 horseshoe arch 336 30
 horseshoe grip 298 53
 horseshoe marking 88 71
 horseshoe mount 113 25
 horseshoe mounting *Astron.*
 5 9
 horseshoe mounting *Optic.*
Instr. 113 25
 horse sleigh 304 25
 horse stall 75 2
 horsetail 376 18
 horst 12 10
 hose *Household* 50 75
 hose *Bldg. Site* 118 38
 hose *Serv. Stat.* 196 2; 196 23
 hose *Fire Brig.* 270 54
 hose *Hist. Cost.* 355 47
 hose, rotary ~ 145 13
 hose carriage 270 28
 hose cart 270 28

hose connection 83 30
 hose connector 56 45
 hose coupling 270 29
 hose layer 270 53
 hosepipe 118 38; 196 23
 hose reel 56 26; 270 28
 hose truck 270 28
 hose wagon 270 28
 hosiery 271 56
 hosiery department 271 17
 hosiery mill 167 1-66
 hosiery shelf 99 25
 hospital 25; 26; 27
 hospital bed 25 10
 hospital unit 228 21
 Host 331 48; 332 28, 35
 hostess 318 33
 hot-air duct 139 52
 hot-air gun 130 25
 hot-air sterilizer 22 71
 hotbed 55 16
 hotbed vent 55 17
 hot-blast pipe 147 19
 hot-blast stove 147 15
 hot dog 308 34
 hot-dog stand 308 32
 hotel 267
 hotel bar 267 51
 hotel bill 267 11
 hotel guest 267 14
 hotel lobby 267 18-26
 hotel manager 267 19
 hotel porter 204 17
 hotel register 267 8
 hotel restaurant 267 20
 hotel room 267 27-38
 hotel sticker 205 9
 hothouse 55 4; 272 65
 hot-metal receiver, tilting-
 type ~ 148 5
 hot-pipe space 259 93
 hotplate 39 15; 207 30
 hotplate, electric ~ 45 45
 hot reservoir 155 20
 hot-shoe contact 114 72
 hot-shoe flash contact 115 21
 hot tap 126 28
 hot water supply 155 26
 hot water tank 38 68
 hot water tank *Brew.* 92 10
 hot water tank *Paperm.* 172
 18
 hound *Hunt.* 86 33
 hound *Sailing* 284 14
 hour and minute button 110 3
 hour axis 5 8
 hour axis drive 5 7
 hourglass 110 31
 hour hand 110 13
 house *Dwellings* 37 54
 house *Farm Bldgs.* 62 1
 house *Bldg. Site* 118 1-49
 house, detached ~ 37 1-53
 house, dikereeve's ~ 216 45
 house, duplex ~ 37 64-68
 house, ferryman's ~ 216 45
 house, semi-detached ~ 37
 69-71
 house, solar ~ 155 17
 house, solar-heated ~ 155 17
 house, terraced ~ 37 58-63

house, timber ~ 37 84-86
 houseboat 353 31
 house cat 62 3
 housecoat *Underwear etc.* 32
 20
 housecoat *Hist. Cost.* 355 66
 house cricket 81 7
 house detective 275 16
 house dress 31 36
 housefly 81 1, 2
 house frock 31 36
 household appliances 50
 household utensils 50
 house insects 81 1-14
 houseleek 51 7
 house light dimmer 312 17
 houseplant 42 36; 248 14
 houseplants 53
 house sparrow 361 5
 house spider 81 9
 house telephone 127 3
 house wall 120 29
 housewife 39 1
 housing *Meteorol. Instr.* 10 18
 housing *Iron Foundry etc.* 148
 57
 housing *Films* 312 48
 housing, protective ~ 10 39
 housing, soundproof ~ 310
 48; 313 16, 18, 27
 housing development 37
 54-57
 housing estate 37 54-57
 housing lock 313 33
 hover 74 3
 hovercraft 286 63
 hubs 187 26
 hub, centre ~ 187 59
 hub, front ~ 187 52
 hub assembly, front ~ 187 52
 hub barrel 187 69
 hub body 187 69
 hub shell 187 69
 huckleberry 377 23
 hula-hula girl 306 16
 hula skirt 306 18
 hull *Aircraft* 232 2, 9
 hull *Warships* 258 2; 259 22,
 42
 hull bottom 286 32, 35, 39
 hull frame 222 29
 human flea 81 42
 Humanist 342 4
 human louse 81 40, 41
 humblebee 358 23
 humerus 17 12
 humidifier 79 22
 hummock 13 42
 hump 206 46
 hundreds 344 3
 hunt 289 41-49
 Hunter *Astron.* 3 13
 hunter 86 1
 hunting 86 1-52, 9-12, 14-17
 hunting cap 289 14
 hunting cap, hard ~ 289 18
 hunting clothes 86 2
 hunting dog 86 33
 hunting equipment 87 41-48
 hunting horn 87 60; 289 44
 hunting knife 87 42

hunting knife, double-edged
 ~ 87 41
 hunting leopard 368 7
 hunting pink 289 13, 42
 hunting rifle 86 4
 hunting rifles 87 1-40
 hunting screen 86 9
 hunting weapons 87
 huntsman 86 1
 hurdle *Free Exerc.* 295 12
 hurdle *Athletics* 298 8
 hurdle position 295 12
 hurdle racing 298 7-8
 hurdles 298 7-8
 hurdy-gurdy 322 25
 hurst 91 20
 husk 59 50; 68 33
 husk corn 68 31
 husky 70 22; 353 2
 hut 300 1
 hut, beehive-shaped ~ 354 28
 hut, Indian ~ 273 59
 Hydra 3 16
 Hydra, Lernaean ~ 327 32
 Hydrallmania 369 9
 hydrangea 51 11
 hydrant key 270 27
 hydraulic engineering 217
 hydraulic lift pad 195 27
 hydraulic plant 92 13
 hydraulic plant room 316 50
 hydraulic system *Agr. Mach.*
 64 65
 hydraulic system *Paperm.* 173
 37
 hydraulic system *Army* 255 53
 hydraulic system *Air Force*
 257 16
 hydrocyanic acid 83 15
 hydro-extraction 169 23
 hydro-extractor, pendulum-
 type ~ 168 14
 hydro-extractor lid 168 18
 hydroformer 145 47
 hydrogenation 170 16
 hydrogen atom I 15; 242 62
 hydrogen atom (model) 1 1
 hydrogen balloon 10 56
 hydrogen bomb explosion 7
 12
 hydrogen cooler 153 27
 hydrogen inlet *Synth. Fibres*
 170 15
 hydrogen inlet *Chem.* 350
 12
 hydrogen sulphide scrubber
 156 22
 hydrogen sulphide wet
 collector 156 22
 hydrogen tank 6 6
 hydropathic 274 8
 hydrophone 224 64
 hydroplane 286 22
 hydroplane, stepped ~ 286
 38-41
 hydroplane, three-point ~
 286 42
 hydrosphere 11 2
 hydroxylamine inlet 170 21
 hyena 368 1
 hygrograph 10 8, 50

hygrometer *Drawing Off.* 151
 39
 hygrometer *Offset Platem.*
 179 28
 hygrometer *Swim.* 281 23
 hygrometer element 10 9
 hymenium 381 17
 Hymenoptera 358 21-23
 hymn board 330 24
 hymn book 330 30
 hymn number 330 24
 hyoid 20 2
 hyperbola 347 26
 hyperbolic position line 224
 43, 44
 hyphae 381 2
 hyphen 342 28
 hypocentre 11 32
 hypocotyl 370 89
 hypophysis cerebri 17 43
 hypotenuse 346 32
 hypotrachelium 334 22
 hyrax 366 24
 hyssop 374 5

I

ibex 367 7
 ice 266 44
 ice, glacial ~ 12 48-56
 ice accident 21 28-33
 ice axe 300 16, 31
 ice axe, short-shafted ~ 300
 36
 iceboat 302 44
 iceboating 302 44-46
 icebox 39 2; 46 33; 317 10
 ice breaker 221 50
 ice bucket 267 67
 ice-cream cornet 308 31
 ice-cream man 308 30
 ice-cream sundae 266 76
 ice-cream vendor 308 30
 ice-crystal cloud 8 6
 ice-crystal cloud veil 8 7
 ice cube 266 44
 ice hockey 302 29-37
 ice hockey player 302 29
 ice hockey set 302 23
 ice hockey skate 302 23
 ice hockey stick 302 30
 ice ledge 300 4
 ice pellets 9 35
 ice piton 300 40, 41
 ice racing 290 24-28
 ice ridge 300 21
 ice sailing 302 44-46
 ice skater 302 1
 ice skates 302 20-25
 ice skating 302 1-26
 ice skating boot 302 24
 ice slope 300 14
 ice speedway 290 24-28
 ice step 300 17
 ice stick 302 39
 ice-stick shooter 302 38
 ice-stick shooting 302 38-40
 ice yacht 302 44
 ice yachting 302 44-46
 icicle 304 21

icing, chocolate ~ 97 34
icing sugar 98 54
icosahedron 351 11
icositetrahedron 351 12
identification mark 163 6
identification number 85 33
identification tally 74 55
idle air bleed 192 2
idle mixture adjustment screw 192 11
idling adjustment 190 51
idling air jet 192 2
idling jet 192 1
idol 328 20
igloo 353 4
igloo tent, inflatable ~ 278 58
ignition distributor 190 9, 27
iguana 364 32
ileum 20 16
ilium 17 18
illumination, incident ~ 112 59, 63
illumination, vertical ~ 112 59, 63
illumination beam path 112 6
illumination optics 112 7
illumination path 112 6
image beam 115 35
image converter 26 15, 18; 27 19
imago 358 10
imbrication 335 15
imitation motorcycle fork 188 58
immersion heater 40 17
immersion roller 165 45
immersion vibrator 119 88
impact crusher 158 20
impact wrench 195 44
impair 275 23
impeller wheel 217 52
Imperial Crown 254 38
impost 336 21
impounding reservoir 217 57
impregnating spray 50 40
impression-adjusting wheel 180 81
impression control 249 10
impression cylinder 180 35, 64, 181 2, 44, 59
impression-setting wheel 180 81
impression tray 24 56
imprint, publisher's ~ 185 48
impulse generator, programmed ~ 25 33
impulse meter, automatic ~ 25 42
incense boat 332 42
incense spoon 332 43
incident light measurement 114 60
incident neutron 1 42
incisor 19 16, 34
inclined cable anchorage 215 48
inclined cable system 215 51
incubation tank, long ~ 89 18
incubator 261 30
incubator, Californian ~ 89 15

incus and stapes 17 61
indentation 175 16
index 345 1, 2
index arm 224 3
index bar 224 3
index cards 22 7
index finger 19 65
indexing mark 249 74
indexing table, rotary ~ 150 42
index mirror 224 6
index plate 151 51
Indian 352 25
Indian chief 352 11
Indian corn 68 31
Indian cress 53 4
Indian meal moth 81 28
Indian Ocean 14 23
indicator *Hosp.* 26 28
indicator *Motorcycle* 189 37, 45
indicator *Tram* 197 22
indicator, rear ~ 189 42
indicator and dimming switch 191 59
indicator board *Station* 204 32
indicator board *Hotel* 267 5
indicator for rough and fine adjustment 148 65
indicator lamp *Sawmill* 157 62
indicator lamp *Cotton Spin.* 164 8
indicator lamp *Office* 249 71
indicator light *Hosp.* 25 6
indicator light *Motorcycle* 189 37, 45
indicator light *Serv. Stat.* 196 7
indicator light *Tram* 197 22
indicator light *Railw.* 203 14
indicator light *Audio* 241 55
indicator light *Office* 249 71
indicator light *Hotel* 267 6
indicator light *Fencing* 294 30
indicator light, front ~ 191 19
indicator light, rear ~ 189 42
indicator needle *Photog.* 114 58
indicator needle *Inf. Tech.* 242 76
indicator plate 203 12
indicator scale 114 58; 313 28
indigo dyeing and sizing machine 165 40
Indio 352 23
individual-section machine 162 21
indoor target rifle 305 35
indorse 250 26
indorsement 250 25
indorser 250 27
induced-draught fan 152 14
induction coil 11 44
industrial plant 225 71
inert-gas atmosphere 162 16
inert-gas supply 142 34
inert-gas torch 142 33
inert-gas welding 142 33

inert-gas welding equipment 138 29
inertial measurement unit 6 43
inescutcheon 254 17
infant care 28
infants' wear 29 13-30
in-feed scale 157 61
infighting 299 31
infiltration drain 216 37
infinity 345 15
inflating bulb 25 17
inflator 22 37
inflections 320 50-54
inflight antenna 6 46
inflight refuelling probe 256 7
inflorescence 371 43, 48; 378 7, 53, 55; 382 38; 383 49; 384 31
inflorescence, female ~ 59 46; 68 32; 383 11; 384 50
inflorescence, male ~ 59 39; 68 35; 371 8; 372 17, 24; 383 13
inflorescences 370 67-77
'information' 233 31
information bureau 204 29
information clerk 204 49
information counter 250 9
information office 204 29
information plate 356 20
information position 237 34
information technology 242
infrared drier 173 32
infrared laser rangefinder 255 82
infrared sound headphones 242 30
infrared sound transmitter 242 29
infrared transmission 242 27
infraspinus 18 53
infringement 291 50
infructescence 61 15; 371 22, 44, 69, 72; 373 8; 374 18; 383 56; 384 32
infusion apparatus 25 11
infusion bottle 25 12
infusion device 25 14
ingot 148 48
ingot mould 147 32
ingot tipper 148 49
ingress/egress hatch 6 38
ingress/egress platform 6 34
inhalation 274 7
inhalational therapy 274 6-7
inhalator 23 24
inhalatorium 274 6
inhaler 26 2, 29
inhaling apparatus 23 24
inhaling tube 26 2, 29
initial 175 1
initial position *Fish Farm.* 89 33
initial position *Fencing* 294 18
injection condenser 172 16
injection nozzle 190 32, 54
injection pump *Intern.* *Combust. Eng.* 190 65
injection pump *Railw.* 211 48

injection pump drive 190 57
injection timer unit 190 58
ink 260 83
ink ball 340 22
ink duct 180 22; 181 65
inker 180 21, 50, 60, 77
inker unit 180 6-13, 40, 51, 60, 71, 76; 181 7, 8, 19, 28, 50, 57; 249 51-52
ink fountain 180 22; 181 65
ink fountain roller 181 64
inking ball 340 22
inking roller 180 21, 50, 60, 77; 249 52
inking unit 180 6-13, 40, 51, 60, 71, 76; 181 7, 8, 19, 28, 50, 57; 249 51-52
ink pad 22 30
ink plate 181 8
ink roller 180 21, 50, 60, 77; 249 52
ink slab 181 8
ink unit, tubular ~ 151 68
inkwell 309 78
inlay 323 26
inlet *Paperm.* 172 77
inlet *Chem.* 349 21
inlet filter 146 26
inlet manifold 190 18; 192 13
inlet valve 242 52
inlet vent 191 47
inner tube 187 30
input 117 27
input keyboard 238 13
input/output device 237 59
input selector 241 44
input selector switch 238 49
input unit 176 30
inscription 252 11
insect, homopterous ~ 358 3
insect, orthopterous ~ 358 8
insectivores 366 4-7
insects 358 3-23
insects, dipterous ~ 358 16-20
insert, wood ~ 85 4
insertion ring 349 17
inshore fishing 90 24-29
inside defender 291 12
inside forward 291 15
insolation 155 18
insole 291 27
inspection apparatus 79 20
inspection window 38 62
inspector 205 44
instep 19 61
instruction, programmed ~ 242 16
instruction key 247 21
instruction laser 242 81
instrument, keyed ~ 325 1
instrument, plucked ~ 322 21
instrument basin 27 5
instrument cabinet 24 16
instrument housing *Atom* 2 5, 22
instrument housing *Meteorol. Instr.* 10 59
instrument panel *Offset Print.* 180 74
instrument panel *Railw.* 212 31

instrument panel *Aircraft* 230 1
instrument panel *Airsports* 288 11
instruments, dental ~ 24 4
instruments, orchestral ~ 323 1-62
instruments, retractable ~ 258 68; 259 74, 88-91
instruments for gynecological and proctological examinations 23 3-21
instruments for minor surgery 22 48-50
instrument table 22 45
instrument table, mobile ~ 26 37
instrument tray 24 5; 26 39
instrument unit 234 53
insufflator 23 18
insulating board 122 44
insulating casing 10 26
insulating tape 127 34
insulation *Slaughterho.* 94 10
insulation *Energy Sources* 155 36
insurance company office 268 40
intaglio printing 182
intaglio process 340 14-24
intake muffler 191 54
intake pipe 189 5
intake silencer 190 16; 191 54
integer 344 10
integral 345 14
integral sign 345 14
integration 345 14
intensive care unit 25 1-30
interceptor 256 1
Inter-city train 205 34
intercom *Doc.* 22 34
intercom *Garage* 195 55
intercom *Computer* 244 5
intercom *Office* 245 20; 246 10
intercommunication telephone 239 13
intercom system *Railw.* 202 48; 203 69
intercom system *Computer* 244 5
interest 345 7
interior equipment 239 6
interlacing point 171 28
interleaving device 181 11
intermediate frequency amplifier module 240 4
intermediate image screen 113 37
internal combustion engine, single-cylinder ~ 190 6
internal combustion engine, two-stroke ~ 190 6
internal combustion engines 190
internal facing tool 149 51
International Signals Code 253 29
interrogation mark 342 20
interrogation point 342 20
interrupter 153 55

intersection 347 12
intersection of sets 348 4
interspacing 175 13
inter-stage connector 234 31, 36
inter-stage section 234 31, 36
inter-tank connector 234 16
inter-tank section 234 16
intervals 321 6-13
intestine 77 15
intestine, large ~ 20 17-22
intestine, small ~ 20 14-16
intestines 20 14-22
intestinum crassum 20 17-22
intestinum tenue 20 14-16
intrusion 11 30
inundation area 216 41
Inverness 186 32
invertebrates 357
inverted comma 342 26
inverted flight 288 9
involucre 59 50
ion chamber 2 2, 17
ionization chamber 2 2, 17
ionizing particle 1 58
ionosphere *Atmos.* 7 23
ionosphere *Post* 237 55
iris *Man* 19 42
iris *Flower Gdn.* 51 27
iris *Gdn. Flowers* 60 8
iron *Shoem.* 100 9
iron *Tailor* 104 29
iron *Ball Games* 293 92
iron, electric ~ 50 6
iron, lightweight ~ 50 6
iron, molten ~ 148 11
iron, slater's ~ 122 84
iron, square ~ 143 9
Iron Age 328 21-40
iron and steel works 147
ironer 103 19
iron foundry 148 1-45
iron handle 50 9
ironing board 50 16
ironing-board cover 50 17
ironing head 50 4
ironing machine, electric ~ 50 1
ironing surface *Household* 50 16
ironing surface *Dressm.* 103 23
ironing table 50 15
iron ladle 147 12, 21, 42
iron pyrites 351 8
iron runoff 147 11
irons 50 1-20
iron well 50 18
irradiation table 2 36
irrigation, overhead ~ 67
irrigation system, portable ~ 67 3
irrigation unit, long-range ~ 67 18
ischium 17 19
island *Phys. Geog.* 13 6
island *Warships* 259 3
island *Park* 272 55
isobar 9 1
isochem 9 42
isohel 9 44

isohyet 9 45
isometric crystal system 351
1-17
isosceles triangle 346 27
isoseismal 11 37
isotherm 9 43
isotherm 9 40
issue desk 262 20
Italian ryegrass 69 26
italics 175 7
ITOS satellite 10 64
ivory carver 135

J

jack *Ship* 223 54
jack *Army* 255 68
jack *Fire Brig.* 270 12
jack *Sports* 305 23
jack *Music. Instr.* 322 50
jack, hydraulic ~ 85 45
jackal 367 11
jack boot 355 58
jack chain, endless ~ 157 17
jacket 29 51; 31 2; 33 2
jacket, baby's ~ 28 25; 29 9
jacket, casual ~ 33 39
jacket, cork ~ 282 19
jacket, denim ~ 33 21
jacket, leather ~ 33 43
jacket, metallic ~ 294 15
jacket, mink ~ 30 1
jacket, oilskin ~ 228 6
jacket, padded ~ 300 6
jacket, pile ~ 29 44
jacket, poplin ~ 31 37
jacket, short-sleeved ~ 33 26
jacket, suede ~ 30 58
jacket button 33 55
jacket crown 24 28
jacket flap 185 38
jack-in-the-box 306 56
jack panel 311 16
jack plane 132 16
jack rafter 121 61, 63
jack spur, screwed ~ 71 50
jack spur, strapped ~ 71 51
jackstaff 223 53; 258 4
jackstay 221 118
jacob's ladder 221 91
jai alai 305 67
jam 98 52
jam, whole-fruit ~ 98 51
jamb 118 11; 120 32, 51
jambeau 329 54
jam cleat 284 22
Jamestown weed 379 8
Japan Current 14 31
Japanese quince 373 17
japonica 373 17
jardin anglais 272 41-72
javelin 319 17
javelin throw 298 51-53
jaw *Man* 16 17
jaw *Hosp.* 26 46
jaw *Joiner* 132 33
jaw *Metalwkr.* 140 3
jaw, lower ~ *Man* 17 35
jaw, lower ~ *Horse* 72 11
jaw, upper ~ 17 36; 19 27

jawbone, lower ~ 17 35
jawbone, upper ~ 17 36
jaws, inside ~ 149 71
jaws, outside ~ 149 70
jaw trap 87 48
jay 361 1
jazz band instruments 324
47-78
jazz guitar 324 73
jazz trumpet 324 65
jeans 31 60; 33 22
jejenum 20 15
jellyfish 357 14
jelly roll 97 19
J-2 engine 234 19, 34
jenny 222 14, 28
jerboa 366 15
jerkin 355 45
jerkin head roof 121 16
jerk with split 299 4
jersey 291 56
jersey, padded ~ 292 26
jess 86 45
jester 306 38
jet 83 19
jet, main ~ 192 12
jet aeroplanes 231 7-33
jet airplanes 231 7-33
jet blower 281 34
jet condenser 172 16
jet engine 231 26
jet engines 232 33-50
jet fuel tank 146 18
jet nozzle 153 29
jet planes 231 7-33
jet pump 216 62
jets 231 7-33
jet stream level 7 5
jet trainer 257 1-41
jet turbine 231 26
jet turbine engine 231 26
jet turbine engines 232 33-50
jet turbines 232 33-50
jetty *Map* 15 59
jetty *Docks* 225 30, 66
jetty *Park* 272 46
jetty *Camping* 278 13
jetty *Rowing* 283 19
jewel 110 33; 355 17
jewel box 36 31
jewel case 36 31
jewellery 36; 36 1
jewellery department 271 62
jewelry *see* jewellery
jib *Bldg. Site* 119 36
jib *Ship* 220 2
jib *Docks* 226 24, 49
jib *Army* 255 95
jib *Sailing* 284 16; 285 3
jib, flying ~ 219 23
jib, inner ~ 219 21
jib, outer ~ 219 22
jib boom 218 51; 219 1
jib crane 222 34
jib downhaul 284 17
jibe 285 28
jibing 285 26
jib sheet 284 23
jib stay 219 14
jig 134 42
jiggering 161 14

jig saw 108 12
jigsaw puzzle 48 9
jigsaw puzzle piece 48 10
jimson weed 379 8
jimson weed 379 8
job advertisement 342 70
jockey 22 68
jockey cap 35 8
jockey roller 181 45
jockey wheel 278 54
jogger 249 56
join 122 94
joiner 132 38; 133
joiner's tools 132 1-28
joining of modules 242 70
joint *Phys. Geog.* 13 50
joint *Plumb. etc.* 126 38
joint *Railw.* 202 11
joint *Industr. Plants* 383 63
joint, pre-packed ~ 96 22
joint, universal ~ 284 6
joint and side pasting
attachment 185 28
joint cutter 201 16
joint-cutting blade 201 17
jointed charlock 61 21
jointer 133 37
joint vice 108 34
joist 121 54
joist shuttering 119 12
jollying 161 14
Jordan 172 27, 60, 73, 83
Jordan refiner 172 27, 60, 73,
83
journal 143 63
joust 329 71
jousting helmet *Heraldry* 254
4
jousting helmet *Chivalry* 329
77
judge *Cyc. Racing* 290 5
judge *Sports* 299 43
judo 299 13-17
judoist 299 14
judoka 299 14
judo throw 299 17
jug 39 30
jug, clay ~ 260 78
juice extractor 40 19
ju-jitsu 299 13-17
jumbo derrick boom 221 25,
62
jumbo jet 231 14
jump 289 21
jumper *Child. Clothes* 29 43
jumper *Equest.* 289 9
jumper, child's ~ 29 47
jumper, cowl neck ~ 30 2
jumper, polo neck ~ 30 7
jumper, short-sleeved ~ 31 67
jumping 298 9-41
jumping hoop 307 58
jumping jack 306 52
jumping rope 273 15, 16
jumping saddle 289 10
jumping sheet 270 18
jump rope 273 16
jump-sit-spin 302 8
jump ski 286 62
jumpsuit 31 53
jump throw 292 3

junior hacksaw 127 52
juniper berry 372 52
juniper tree 372 47
junk 353 32
junk stall 308 60
Jupiter 4 48
just 329 71
justifying scale 174 35
jute 383 25

K

kail 57 34
kale 57 34
kangaroo 366 3
kapok tree 383 20
karabiner 300 46
karabiner hole 300 35
karate 299 18-19
karateka 299 18
karst formation 13 71-83
karst spring 13 74
kart 305 83
karting 305 82
kayak 283 4; 353 12
kayak, folding ~ 283 61, 62, 67
kayak, one-man ~ 283 54
kayak, two-seater ~ 283 61
kayaks 283 68 70
Keel *Astron.* 3 46
keel *Shipbuild.* 222 22
keel *Space* 237 7
keel *Rowing* 283 32
keel *Sailing* 285 32
keel, pad ~ 285 36
keel, vertical ~ 222 53
keel arch 336 36
keel block 222 39
keel-centreboard yawl 285
37-41
keel plate 222 49
keelson 222 53; 283 50
keep 329 4
keep net 89 28
kegellade chest 326 12-14
kelly 145 14
kelson 222 53; 283 50
kerb 198 6; 272 25
kerbstone 198 7
kerbstone broker 251 5
kerbstoner 251 5
kerf 84 28
kernel 68 13; 383 44
kerosene 145 60
kerosene tank 234 9
kerria 373 28
ketchup 45 43
kettle, brass ~ 42 14
kettle, whistling ~ 39 16; 40
10
kettledrum 323 57
Keuper 154 57
key *Map* 14 27-29
key *Metalwkr.* 140 33-35
key *Town* 268 4
key *Music. Instr.* 322 28, 38,
49; 323 32, 35; 324 40; 326
8
key, black ~ 325 5
key, ebony ~ 325 5

key, flat ~ 140 48
key, gib-headed ~ 143 74
key, iron ~ 328 32
key, ivory ~ 325 4
key, sunk ~ 143 73
key, white ~ 325 4
key action 325 22-39
keyboard *Composing Rm.* 174
32, 37; 176 2
keyboard *Post* 236 44; 237 70
keyboard *Office* 245 27; 249
2-6
keyboard *Music. Instr.* 322
28; 324 40; 325 4-5
keyboard, lower ~ 322 47
keyboard, upper ~ 322 46
keyboard console 176 1
keyboard instrument 325 1
keyboard operator 176 4
keyboard send-receive
teleprinter 176 31
keyboard side 324 39
keyboard unit 176 1
keyhole 140 40
keyhole saw 120 63; 126 70;
132 3
key lever 322 38, 49; 326 8
key mechanism 325 22-39
key rack 267 3
keys *Mach. Parts etc.* 143
73-74
keys *Music. Not.* 320 55-68
key seat 143 85
key signatures 320 50-54
key slot 143 85
keystone 336 23
keyway 143 66, 85
kick-back guard 132 47; 157
59
kicker 292 10
kicking strap 284 21
kick stand 187 34
kickstarter 188 39, 43; 189 38
kidney, left ~ 20 30-31
kidney, right ~ 20 28
kidney dish 23 45
kidney vetch 69 6
kieselguhr 93 3
kieselguhr filter 93 4
kill *Hunt.* 86 38
kill *Bullfight, etc.* 319 30
killer 94 1
kiln 92 19
kiln, circular ~ 159 19
kiln, rotary ~ 160 8
kilning floors 92 16-18
kilns 161
kilometer *see* kilometre
kilometre sign 216 44
kimono 353 40
kindergarten 48
king 276 8
King Carnival 306 58
king cup 375 8
kingfisher 360 8
king penguin 359 4
king pin roof structure 121 42
king post 223 35
king post, ventilator-type ~
221 58
king's fern 377 16

Kipp generator 350 59
Kipp's apparatus 350 59
Kirghiz 353 22
Kirschner beater 163 25
kit 322 20
kitchen 39, 207 29, 80
kitchen, ship's ~ 223 42
kitchen appliances 40
kitchen cabinet 207 35
kitchen chair 39 43
kitchen clock 39 20; 109 34
kitchen cupboard 39 8
kitchen lamp 39 39
kitchen roll 40 1
kitchen scales 309 84
kitchen table 39 44
kitchen unit 46 29
kitchen utensils 40
kite *Playground* 273 41, 42
kite *Maths.* 346 38
kite *Birds* 362 11
kite, paper ~ 260 71
kite string 273 44
knapsack 86 3
knapsack sprayer, plunger-
type ~ 83 43
knapweed 376 12
kneading machine 97 55
knee *Man* 16 50
knee *Horse* 72 22
knee-breeches 33 40
kneecap *Man* 17 23
knee cap *Chivalry* 329 53
kneeler 332 25
knee lever 325 45
kneeling front support 295 20
kneeling position *Free Exerc.*
295 8
kneeling position *Sports* 305
28
knee mounting 113 21
knee pad *Ball Games* 292 9
knee pad *Winter Sp.* 303 17
knee piece 329 53
knee roll 71 48
knee strap 33 41
knee swell 325 45
knife *Tablew, etc.* 45 7, 50
knife *Forestry* 85 11
knife *Paperhanger* 128 38
knife *Papern.* 172 74
knife *Swim.* 279 8
knife, bookbinder's ~ 183 13
knife, bronze ~ 328 31
knife, butcher's ~
Slaughterho. 94 15
knife, butcher's ~ *Butch.* 96
37
knife, cobbler's ~ 100 50
knife, electrician's ~ 127 63
knife, gardener's ~ 56 9
knife, gilder's ~ 129 51
knife, hafted ~ 328 31
knife, shoemaker's ~ 100 50
knife, surgical ~ 26 43
knife blade 96 32
knife case 94 12
knife couler 65 10
knife handle 96 34
knife rest 45 11
knife thrower 307 37

knight *Games* 276 11
 knight *Chivalry* 329 67
 knighting 329 66
 Knight Templar 329 73
 knit 101 43
 knits 171
 knits, basic ~ 171 30-48
 knit stitch 101 43
 knitting 167
 knitting head 167 21
 knitting machine, circular ~ 167 1
 knitting machine, flat ~ 167 18
 knives, butcher's ~ 96 31-37
 knob 359 17
 knob, adjustable ~ 151 3
 knobkerrie 354 33
 knobkerry 354 33
 knob-leaf capital 333 14
 knockout 299 40
 knock-over bit 167 52
 knot *Meteorol. etc.* 9 12
 knot *Ladies' Wear* 31 47
 knot *Underwear etc.* 32 42
 knot *Roof* 122 68
 knot, French ~ 102 13
 knot hole cutter 132 53
 knot hole moulding machine 132 52
 knot stitch, twisted ~ 102 13
 knotted work 102 21
 knotter 172 54; 173 13
 knotting machine 85 18
 knuckle *Man* 19 82
 knuckle *Mear* 95 38, 42, 49
 knuckle, fore ~ 95 5, 8
 knuckle, hind ~ 95 1, 10
 knuckle of pork 96 17
 Kocher's forceps 22 49
 kohlrabi 57 26
 Korean 341 27
 Kort vent 227 21
 koruna 252 27
 kraft pulp mill 172 1-52
 KR-class 284 63
 kris 353 44
 krona 252 25
 krone 252 24, 26
 Krüger flap 229 55
 krummhorn 322 6
 Kuroshio 14 31
 Kuro Siwo 14 31
 kursaal 274 8
 kymation 334 19

L

label 54 4
 laboratory 23 41-59
 laboratory, multi-purpose ~ 235 66
 laboratory and research microscope 112 1
 laboratory apparatus *Doc.* 23 57
 laboratory apparatus *Paperm.* 173 2-10
 laboratory apparatus *Chem.* 349 1-38; 350 1-63

laboratory equipment *Doc.* 23 57
 laboratory equipment *Paperm.* 173 2-10
 laboratory equipment *Chem.* 349 1-38; 350 1-63
 laboratory microscope 112 1
 laboratory technician 23 41
 laboratory timer 116 18
 laborer *see* labourer
 labourer, bricklayer's ~ 118 19
 labourer, builder's ~ 118 19
 Labrador Current 14 40
 labret 354 23
 laburnum 374 32
 labyrinth 17 62
 lace 100 64; 291 32
 lace, cotton ~ 31 32
 lace, Venetian ~ 102 30
 lace fastening 101 21
 lackey 186 20
 lackey moth 80 13
 lacolith 11 30
 lacquered work, incised ~ 337 6
 lacquey 186 20
 lactam oil 170 37
 ladder *Moon L.* 6 35
 ladder *Roof & Boilerr.* 38 15
 ladder *Child. Rm.* 47 5
 ladder *Fruit & Veg. Gdn.* 52 8
 ladder *Bldg. Site* 118 42
 ladder *Railw.* 211 43
 ladder *Hydr. Eng.* 217 8
 ladder *Space* 235 28
 ladder, aluminium ~ 50 35
 ladder, arched ~ 5 20
 ladder, extending ~ 270 10
 ladder, standard ~ 118 86
 ladder, steel ~ 270 10
 ladder dredge, multi-bucket ~ 216 56
 ladder hook 122 15, 69
 ladder mechanism 270 11
 ladder operator 270 13
 ladder scaffold 118 86-89
 'ladies' 233 48
 'ladies' toilet' 233 48
 ladies' wear 30; 31
 ladies' wear department 271 28
 ladle 130 32
 ladle, crane-operated ~ 147 60
 ladle, drum-type ~ 148 6
 ladle, mobile ~ 148 6
 lady *Café* 265 23
 lady *Hist. Cost.* 355 59, 64, 68, 70, 79
 ladybird 358 37
 ladybug 358 37
 lady-finger 69 6
 lady's finger 69 6
 ladysmock 375 11
 lady's slipper 376 27
 lady's smock 375 11
 lager 93 26
 lager cellar 93 12
 lagging 38 72
 lagoon 13 33

lake 13 3
 lake, coastal ~ 13 44
 lake, ox-bow ~ 15 75
 lake dwelling 328 15
 lamantin 366 23
 lamb 73 13; 75 11
 lamb's lettuce 57 38
 lamellicorn 82 1
 lamellicorn beetle 358 24, 39
 lamina 68 20; 370 28, 85
 laminate 301 48
 lamp *Dent.* 24 19
 lamp *Dining Rm.* 44 12
 lamp *Watchm.* 109 12
 lamp *Carriages* 186 9
 lamp *Street Sect.* 198 18
 lamp *Nightclub* 318 26
 lamp, directional ~ 22 44
 lamp, fluorescent ~ 49 32; 271 23
 lamp, front ~ 188 29
 lamp, individual ~ 26 11
 lamp, pendant ~ 44 12
 lamp, rear ~ 187 46
 lamp, side ~ 191 20
 lamp bracket *Photomech. Reprod.* 177 16
 lamp bracket *Bicycle* 187 6
 lamp compartment 177 41
 lampholder 127 60
 lamphouse 112 28, 59; 116 29; 309 44; 312 39-44
 lamphouse connector 112 60
 lamp housing 116 29
 lamp post 198 18
 lam rod 166 54
 lance *Gdn. Tools* 56 25
 lance *Bullfight. etc.* 319 17
 lance *Chivalry* 329 81
 lance *Ethnol.* 353 9
 lanceolate 370 32
 lancer 319 16
 lance rest 329 80
 lancet arch 336 31
 lancet window 335 39-41
 land 87 39
 landau 186 36
 landaulette 186 36
 land drill 282 20
 landfill, sanitary ~ 199 10
 landing *Floor etc. Constr.* 123 34-41
 landing *Athletics* 298 19
 landing, intermediate ~ 123 52-62
 landing area 298 36, 39
 landing beam 123 34, 55
 landing beam, main ~ 123 66
 landing craft 258 89; 259 46
 landing flap 229 42; 230 53; 257 38; 288 29
 landing gear, hydraulically operated ~ 235 31
 landing gear, main ~ 235 31
 landing gear, retractable ~ 232 10
 landing gear housing 256 15
 landing gear hydraulic cylinder 257 41
 landing gear unit, forward-retracting ~ 257 40

landing gear unit, main ~ 230 41; 231 28; 257 40; 288 33
 landing gear unit, retractable ~ 231 28
 landing light 230 49; 257 37; 288 32
 landing mat 296 13; 297 7
 landing net 89 2
 landing pad *Moon L.* 6 33
 landing pad *Athletics* 298 36
 landing pontoon 225 63
 landing skid 232 15; 256 21
 landing stage 225 63; 278 13; 283 19
 landing unit, main ~ 256 26
 landlord 305 7, 13
 landside 65 5, 67
 landslide 11 46
 landslip 11 46
 land surveying 14 46-62
 land wheel 65 15
 lane *Map* 15 112
 lane *Forestry* 84 1
 lane arrow 268 73, 74
 lane timekeeper 282 24
 language laboratory 261 35
 languid 326 28
 lansquenet 355 32
 lantern *Carriages* 186 9
 lantern *Ship* 218 44; 221 48
 lantern *Navig.* 224 105
 lantern *Art* 335 45
 lantern, Chinese ~ 353 36
 lantern, combined ~ 286 13
 lantern, paper ~ 52 15; 306 4
 lantern mast 224 82
 lantern tower 224 82
 lantyard 284 19
 lap *Dom. Anim.* 73 23
 lap *Roof* 122 100
 lap *Cotton Spin.* 163 58, 64
 lap, carded ~ 163 47
 lapboard 136 7
 lap cradle 163 15
 lapel 31 23; 33 5
 lapel, silk ~ 33 8
 lapping plate 125 4
 lap riveting 143 56
 lap scorer 290 6
 lap-turner, movable ~ 163 19
 lapwing 359 21
 larch 372 32
 larch cone 372 36
 lard 96 5
 large cabbage white butterfly 80 47
 larks 361 18-19
 larkspur 60 13
 larmier 88 14
 larry 144 8; 156 6
 larry car 144 8; 156 6
 larva 58 64; 77 29; 80 6, 19, 36, 38, 41, 46; 81 20; 358 9, 19; 82 12, 25, 36
 larva, first-generation ~ 80 23
 larva, mature ~ 80 53
 larva, second-generation ~ 80 24
 larva, young ~ 77 28; 80 54
 larynx 20 2-3
 laser 242 81

laser beam 243 53
 lashing *Bldg. Site* 118 30
 lashing *Ship* 218 32; 221 119
 lasso 319 40; 352 5
 last 100 34
 last, iron ~ 100 54
 last, wooden ~ 100 32
 latch bolt 140 37
 latch needle 167 12, 56, 61
 lateen sail 218 29; 220 3
 lateen spanker 218 29
 lateen yard 218 30
 La Tène period 328 21-40
 lateral 144 30
 lath 123 70
 lath, double ~ 122 43
 lath, tilting ~ 122 43
 lath, toothed ~ 122 26
 lath axe 122 21
 lathe 135 1
 lathe, watchmaker's ~ 109 20
 lathe bed 135 2; 149 31
 lathe carrier 149 54
 lathe foot 149 12
 lathe spindle 149 20
 lathe tool 149 48, 52
 lathe tools 149 45-53
 lathing 123 71
 latissimus dorsi 18 59
 latitude 14 6
 latrine 118 49
 lattice casing 221 84
 lattice girder 235 12
 lattice mast 258 18
 lattice structures 1 9-14
 lattice swing bridge 215 63
 launch 225 25
 launcher 258 49
 launching container 258 32
 launching housing 259 26
 launching ramp 255 66
 launch phase escape tower 234 66
 lauter battery 92 51
 lauter tun 92 50
 lava plateau 11 14
 lava stream 11 18
 lavatories 317 31
 lavatory 49 12; 146 29; 207 16, 42, 72; 211 59; 231 31; 278 5
 lavatory, public ~ 268 62
 lavender 380 7
 lawn 37 46; 51 33; 272 36; 274 12
 lawn aerator 56 15
 lawn mower, electric ~ 56 31
 lawn mower, motor ~ 56 28
 lawn rake 51 3; 56 3
 lawn sprinkler 37 43; 56 43
 lay-by 217 27
 layer 54 11, 12
 layer, bast ~ 54 35
 layer, bituminous ~ 200 58
 layer, level ~ 123 39
 layer, raffia ~ 54 35
 layer, top ~ 123 41
 layer cloud 8 3, 4, 8, 9, 10
 layering 54 10
 layette 28
 layette box 28 18

lay figure 338 31
 laying battery 74 19
 laying hen 74 57
 laying-on trowel 118 56
 laying up 216 14
 lay shaft 192 37
 L-D converter 147 45-50
 lead *Kitch.* 39 25
 lead *Dog* 70 30
 lead *Slaughterho.* 94 9
 lead *Arc Weld.* 142 25
 lead *Navig.* 224 59
 lead, electric ~ *Household* 50 77
 lead, electric ~ *Gdn. Tools* 56 32
 lead, oval ~ 89 88
 lead, pear-shaped ~ 89 90
 lead, spare ~ 151 46
 lead came 124 13
 leader *Dwellings* 37 13
 leader *Roof & Boilerr.* 38 10
 leader *Fish Farm.* 89 78
 leader *Photog.* 114 9
 leader *Carriages* 186 46
 leader *Mountain.* 300 25
 leader *Script* 342 48
 lead hammer 124 11
 leading article 342 48
 leading edge *Sailing* 284 42
 leading edge *Gliding* 287 34
 leading edge, carbon fibre reinforced ~ 235 32
 leading-edge flap, profiled ~ 229 54
 leading lady 310 27
 leading light, higher ~ 224 102
 leading light, lower ~ 224 101
 leading lights 224 101-102
 leading man 310 28
 leading soloist 314 28
 lead-in tube 153 40
 lead knife 124 12
 leadline 224 60
 leads 89 88-92; 224 58-67
 leadscrew 149 19, 32
 leadscrew handwheel 149 13
 leadscrew reverse-gear lever 149 6
 lead shot 89 89
 lead sinker 224 59
 leaf 58 3, 53; 59 17; 68 8; 333 24; 370 19, 26; 371 21, 23, 27, 29, 68; 372 23; 373 3, 16, 25; 374 28; 375 2; 378 15, 18, 19, 41, 45; 384 55, 62
 leaf, alternate pinnate ~ 59 40
 leaf, basal ~ 375 9, 12, 15, 30; 383 2
 leaf, pinnate ~ 57 3
 leaf, sprouting ~ 59 29
 leaf, ternate ~ 58 19
 leaf, trifoliate ~ 58 19
 leaf, young ~ 59 29
 leaf axil 370 25; 375 38
 leaf blade 68 20; 370 28, 85
 leaf bud 59 47; 370 90
 leaf cluster, rooted ~ 54 17
 leaf drop 80 20
 leaf fat 95 45

leaflet 263 9
 leaf margin shapes 370 43-50
 leaf ornament 334 40
 leaf roller 82 43
 leaf shapes 370 31-38
 leaf sheath 68 9, 21; 370 83;
 384 30
 leaf stalk 370 27; 371 73
 leaf tendril 57 4
 leaf vegetables 57 28-34
 leakage steam path 153 28
 lean forward 301 36
 lean-to roof 37 78; 121 7
 leaping hind leg 358 11
 learner-swimmer 282 17
 learning programme, audio-
 visual ~ 242 7
 lease rod 166 38
 leash 70 30
 leather beetle 81 22
 leathers 290 26
 leather side 131 13, 18
 leaves 276 43
 leaves, compound ~ 370
 39-42
 lebkuchen 97 51
 lectern 262 4; 330 2, 37
 lecture 262 1
 lecture notes 262 5
 lecturer 262 3
 lecture room 262 2
 lecture theatre 262 2
 lederhosen 29 32
 ledge *Photograv.* 182 23
 ledge *Mountain* 300 4
 ledge, cushioned ~ 277 16
 ledger 118 26
 ledger tube 119 48
 leeboard 220 7; 283 63
 leech *Sailing* 284 45
 leech *Invertebr.* 357 20
 leech pocket 284 43
 leek 57 21
 lee waves 287 17
 left 254 19, 21, 23
 left corner pin 305 6
 left front second pin 305 2
 left luggage locker 204 21
 left luggage office 204 27
 left tank fuel gauge 230 16
 leg *Man* 16 49-54; 17 22-25
 leg *Game* 88 21, 37, 81
 leg *Meat* 95 1, 38
 leg *Mach. Parts etc.* 143 2
 leg *Maths.* 346 27
 leg, back ~ 82 8
 leg, broken ~ 21 11
 leg, downwind ~ 285 23
 leg, first ~ 285 19
 leg, fractured ~ 21 11
 leg, front ~ 82 6
 leg, hind ~ *Dog* 70 7
 leg, hind ~ *Horse* 72 33-37
 leg, hind ~ *Bees* 77 3, 6-9
 leg, hind ~ *Game* 88 22, 63
 leg, middle ~ 82 7
 leg, second ~ 285 20
 leg, third ~ 285 21
 leg, tubular ~ 114 44
 leg, vertical ~ 143 4
 leg, windward ~ 285 22
 leg armour 319 19
 legato 321 33
 leg boot, high ~ 101 7, 13
 leg boot, men's ~ 101 7, 13
 legend 252 11
 leg feather 362 3
 leggings 28 24; 29 45; 352 17
 leg holder 23 11
 leg of mutton piece 95 22, 29
 leg ring 74 54
 legs 82 6-8
 leg space ventilation 191 81
 leg support 23 10, 11
 legume 57 6; 370 92
 legume, immature ~ 374 22
 legume, unripe ~ 374 22
 Leguminosae 57 1-11
 leg vice 140 10
 Leine rock salt 154 64
 leisure centre 281
 lemon 384 23
 lemonade 265 15
 lemonade glass 265 16
 lemon peel, candied ~ 98 10
 lemon squeezer 40 9
 lending library 262 18
 length adjustment 100 20
 lengthening arm 151 57
 lengths of material 104 2
 length stop 157 68
 lens *Man* 19 48
 lens *Photog.* 115 32, 84; 116
 32
 lens *Composing Rm.* 176 23
 lens *Audiovis.* 243 2, 52
 lens *Films* 313 2
 lens *Crystals* 351 33
 lens, bifocal ~ 111 15
 lens, concave and convex ~
 111 41
 lens, convex and concave ~
 111 42
 lens, fisheye ~ 115 44
 lens, flat ~ 111 38
 lens, flush ~ 114 5
 lens, interchangeable ~ 112
 62; 115 43
 lens, long focal length ~ 115
 48
 lens, long-focus ~ 115 49
 lens, medium focal length ~
 115 47
 lens, negative ~ 111 37
 lens, normal ~ 115 3-8, 46;
 117 49
 lens, plano-concave ~ 111 39,
 40
 lens, positive ~ 111 37
 lens, short focal length ~ 115
 45
 lens, special ~ 111 38
 lens, standard ~ 115 3-8, 46;
 117 49
 lens, telephoto ~ 115 48
 lens, variable focus ~ 117 2
 lens, varifocal ~ 117 2
 lens, wide-angle ~ 115 45;
 117 48
 lens barrel 115 3
 lens carrier 177 27
 lens case 115 104

lens head 117 46-49
 lens hood 313 3, 10
 lens hood barrel 313 5
 lens hood bellows 313 39
 lens panel 112 18
 lens pouch, soft-leather ~ 115
 105
 lens standard 114 52
 lens surface 111 37
 lens system 242 83
 lens turret 117 46; 313 32
 lenticular 287 19
 Lent lily 60 3, 12
 Leo 3 17; 4 57
 Leonberger 73 16
 leopard 368 6
 leotard 297 51
 Lepidoptera 358 48-56; 365
 lepton 252 39
 lesene 335 11
 Lesser Bear 3 34
 lesser celandine 375 36
 Lesser Dog 3 15
 lesser housefly 81 1
 less-than-carload freight 206
 4
 let-off motion 166 59
 let-off weight lever 166 62
 let-out section 131 7
 let-out strip 131 7
 letter 174 44
 letter, capital ~ 175 11
 letter, double ~ 175 6
 letter, initial ~ 175 1
 letter, lower case ~ 175 12
 letter, small ~ 175 12
 letter, upper case ~ 175 11
 letter carrier 236 53
 letter container 236 32
 letter feed 236 31
 letter flags 253 22-28
 letter-folding machine 249 44
 lettering 129 40
 lettering brush 129 41
 lettering stencil 151 69
 letter matrix 174 47; 176 16
 letterpress machine, rotary ~
 181 41
 letterpress machine, web-fed
 ~ 181 41
 letterpress press, rotary ~ 181
 41
 letterpress printing 181
 letterpress printing machines
 181 1-65
 letterpress printing method
 340 1-13
 letter rack 267 2
 letter-rate item 236 55
 letters, illuminated ~ 268 45
 letter scales 236 24
 letter-sorting installation 236
 31-44
 letter spacing 175 13
 letter tray 245 30; 248 41
 lettuce 57 36
 lettuce leaf 57 37
 leucite 351 12
 levade *Horse* 71 4
 levade *Circus* 307 30
 levee 13 9; 216 49

level 14 48
 level, lower ~ 217 17
 level, motor-driven ~ 112 69
 level, upper ~ 217 25
 level crossing 15 26
 level crossing, protected ~ 202
 39
 level crossing, unprotected ~
 202 49
 level crossings 202 39-50
 level indicator 316 57
 leveling see levelling
 levelling 14 46
 levelling and support shovel
 255 94
 levelling beam 201 3, 4
 levelling blade 200 18
 levelling staff 14 47
 lever *Plumb. etc.* 126 19
 lever *Sawmill* 157 46
 lever *Cotton Spin.* 164 42
 lever *Office* 249 50
 lever *Graphic Art* 340 61
 lever for normal and coarse
 threads 149 4
 lever hang 296 56
 lever mechanism 203 54
 liberty horses 307 30-31
 Libra 3 19; 4 59
 librarian 262 4, 19
 library, ships ~ 223 25
 library ticket 262 25
 library user 262 24
 license plate 189 8
 lichgate 331 19
 licker-in 163 53
 licker-in roller 163 53
 licker-in undercasing 163 54
 lid *Kitch. Utensils* 40 13
 lid *Electrotyp. etc.* 178 37
 lid *Chem.* 350 52
 lid, glass ~ 269 56
 lid, hinged ~ 127 24
 lid, sliding ~ 179 2
 lid clip 50 83
 lido deck 223 22
 Lieberkühn reflector 115 97
 liege lord 329 67
 lifebelt 221 124; 222 24; 280
 3; 281 6
 lifebelt light 221 125
 lifeboat *Offshore Drill.* 146 19
 lifeboat 221 78, 107; 223 19
 lifeboat launching gear 221
 101-106
 lifebuoy *Ship* 221 124
 lifebuoy *Shipbuild.* 222 24
 lifebuoy *Bathing* 280 3
 lifebuoy light 221 125
 lifeguard 280 1
 lifeguard station 280 46
 life jacket 286 20
 life jacket, cork ~ 228 9
 life jacket, inflatable ~ 228 8
 life line 19 72
 lifeline 221 103; 228 12; 280 2
 life preserver, cork ~ 228 9
 life raft 228 19; 258 11; 286
 19
 life rocket 228 2
 lifesaver 21 36; 280 1

life saving 228
 life support pack 6 20
 life support system 6 20
 lift *Ship* 219 47
 lift *Store* 271 45
 lift *Theatre* 316 33
 lift, hydraulic ~ 195 25, 26
 lift, vertical ~ 170 36
 liftback 193 29
 lift bridge 225 70
 lift cage 271 46
 lift car 271 46
 lift chair 214 16
 lift chair, double ~ 214 17
 lift controls 271 48
 lift device 103 24
 lift dump 229 42
 lifter *Agr. Mach.* 64 59
 lifter *Sawmill* 157 46
 lifter rail 164 30
 lifter roller 181 63
 lifting arm 255 76
 lifting bolt 164 37
 lifting crane 270 48
 lifting device 255 76
 lifting gear 206 56
 lifting hook 85 6
 lifting motor 150 22
 lifting platform 232 19
 lifting rod 65 29
 lifting rod adjustment 65 25
 lifting spindle 217 36
 lifting undercarriage 232 18
 lift-off hinge 140 49
 lift operator 271 47
 lift platform 173 40
 lift shaft 271 51
 ligament, falciform ~ 20 34
 ligature *First Aid* 21 14-17
 ligature *Composing Rm.* 175
 6
 ligature-holding forceps 26
 44
 light 106 8; 210 46; 224 69
 light, flashing ~ 270 6
 light, fluorescent ~ 271 23
 light, leaded ~ 124 14
 light, polar ~ 7 30
 light, rear ~ 187 46; 189 9
 light, supplementary ~ 203 17
 light ale 93 26
 light and bell buoy 224 74
 light and whistle buoy 224 68
 light beer 93 26
 light box 179 25
 light bulb 127 69; 318 26
 light-emitting diode readout
 110 2
 lighter 216 25; 225 8, 25
 lighter, disposable ~ 107 30
 lighter, tug-pushed ~ 221 94
 lighterman 216 26
 light face 175 8
 lighthouse *Map* 15 8
 lighthouse *Navig.* 224 103
 lighting, external ~ 197 32
 lighting, indirect ~ 317 12
 lighting, internal ~ 197 32
 lighting aperture 334 75
 lighting bridge, travelling ~
 316 19

lighting console 316 2
 lighting control console 316 2
 lighting effects 316 2
 lighting electrician 310 37
 lighting gallery, travelling ~
 316 19
 lighting man 310 37; 316 20
 lighting operator 316 20
 lighting plot 316 3
 lighting station 226 27
 lighting technician 307 4
 lightning 9 39
 lightning arrester 152 35
 lightning conductor 38 30
 lightning rod 38 30
 light plot 316 3
 light railway diesel
 locomotive 200 24
 light rays 1 62
 light readout 195 9
 lights, set of ~ 268 54
 light section tube 112 38
 light-sensitive section 77 22
 lightship *Map* 15 13
 lightship *Ship* 221 47
 lightship *Navig.* 224 81
 light source *Atom* 1 59
 light source *Optic. Instr.* 112
 52
 light source, photometric ~
 112 50
 light stop 5 22
 light vessel 221 47; 224 81
 ligula 68 22; 370 84
 ligule 68 22; 370 84
 lily 60 12
 lily of the valley 377 2
 limb 370 5
 limb, fractured ~ 21 10
 limb, moon's ~ 4 41
 limbing machine 85 18
 limbs 16 43-54
 lime 147 56
 lime, reconverted ~ 172 52
 lime bunker 147 62
 lime kiln 15 86
 limerick 89 84
 lime slaker 172 51
 limestone 160 1
 lime tree 371 46
 limiter display 238 44
 limit switch 241 60
 limousine 193 1
 linden plant 53 9
 linden tree 371 46
 line *Horse* 71 33
 line *Composing Rm.* 175 4
 line *Carriages* 186 31
 line *Railw.* 202 1-38
 line *Theatre* 316 8
 line *Maths.* 346 1-23
 line, curved ~ 346 21
 line, equinoctial ~ 3 3
 line, horizontal ~ 344 15
 line, local ~ 15 25
 line, straight ~ 346 2-3, 5, 16
 linear 370 31
 line block 178 42
 line-casting machine 174 19
 line cut 178 42
 line engraving 178 42

line etching 178 42
 line glass 124 6
 line guide 89 60
 linen 206 11
 linen, dirty ~ 50 22
 linen bin 50 21
 linen compartment 267 31
 linen drawer 44 22; 47 22
 linen goods 271 57
 linen shelf 43 2
 linen tester 177 23
 line-of-battle ship 218 51-60
 line of fencing 294 9
 line of latitude 14 2
 line of life 19 72
 line of longitude 14 4
 line of the head 19 73
 line of the heart 19 74
 line of the staff 320 43
 line plate 178 42
 liner 221 82; 225 32
 lines *Horse* 71 25
 lines *Rowing* 283 52
 line shooting 89 20
 linesman *Railw.* 202 44
 linesman *Ball Games* 291 59;
 293 69
 lines of the hand 19 72-74
 line space adjuster 249 23
 line space and carrier return
 key 249 4
 line steam injector 210 41
 line-throwing gun 228 1
 lingerie 32 1-15
 lining *Bldg. Site* 119 54
 lining *Hist. Cost.* 355 57
 lining, fireproof ~ 147 48
 lining, knitwear ~ 101 17
 lining, leather ~ 291 22
 lining, refractory ~ 147 48
 lining, tricot ~ 101 17
 lining board *Bldg. Site* 118
 41; 119 18
 lining board *Floor etc. Constr.*
 123 56
 lining paper 128 5
 lining paper, shredded ~ 128
 8
 link 36 39
 link, lower ~ 65 28
 link, top ~ 65 27
 linkage, three-point ~ 64 45;
 65 72
 linking of modules 242 70
 link-up of modules 242 70
 Linotype line-composing
 machine 174 19
 Linotype matrix 174 29
 lint 383 19
 lintel 37 25; 118 9
 lintel, reinforced concrete ~
 118 13
 Linz-Donawitz converter 147
 45-50
 Lion *Astron.* 3 17; 4 57
 lion 307 56; 356 5; 368 2
 lip, lower ~ *Man* 19 26
 lip, lower ~ *Horse* 72 10
 lip, lower ~ *Music. Instr.* 326
 26
 lip, upper ~ *Man* 19 14
 lip, upper ~ *Horse* 72 8
 lip, upper ~ *Music. Instr.* 326
 27
 lip of the pudendum 20 87
 lip of the vulva 20 87
 lip plug 354 23
 liquefied-gas tanker 221 35
 liqueur 98 58
 liqueur decanter 45 48
 liqueur glass 45 89; 317 7
 liquid-column barometer 10
 1
 liquid crystal readout 110 2
 liquid feed pipe 74 26
 liquid hydrogen and liquid
 oxygen tank, jettisonable ~
 235 46
 liquid hydrogen line 234 51;
 235 50
 liquid hydrogen pump, high-
 pressure ~ 235 41
 liquid hydrogen suction line
 234 23
 liquid hydrogen supply, main
 ~ 235 35
 liquid hydrogen tank 234 26,
 41
 liquid level indicator 316 57
 liquid manure channel 75 44
 liquid manure silo 62 13
 liquid oxygen line 234 52; 235
 51, 56
 liquid oxygen pump, high-
 pressure ~ 235 42
 liquid oxygen supply line 234
 10
 liquid oxygen tank 234 12, 24,
 39
 liquid stage 148 27
 liquor 168 14
 liquor, weak ~ 172 45
 liquor preheater 172 8
 liquor pump 172 33
 liquor supply pipe 92 48
 lira 252 20, 21
 literature 330 57
 literature stand 330 56
 litho artist 340 45
 Lithodes 369 16
 lithographer 340 45
 lithographic crayon 340 26
 lithographic press 340 60
 lithographic stone 340 25, 57
 lithography 340 25-26
 lithosphere 11 1
 litter *Poultry Farm* 74 8
 litter *Livestock* 75 6
 litter *Town* 268 22
 litter basket 37 63; 205 55;
 272 43; 273 25
 litter bin 37 63; 205 55; 268 5;
 272 43; 273 25
 litter receptacle 196 12; 207
 55
 Little Bear 3 34
 little brain 17 45; 18 23
 little cluster fungus 381 33
 Little Dipper 3 34
 Little Dog 3 15
 little owl 362 19
 livelong 377 9

live power take-off 65 31
 live power take-off shaft 65
 31
 liver 20 10, 34-35
 livery 186 21
 live sound 117 100
 livestock, small 213 28
 livestock ramp 206 1
 living quarters 224 108; 227
 19; 259 84
 living room 42
 lizards 364 27, 30-37
 llama 366 28
 load 73 5
 load, driven ~ 226 19
 load, foil-wrapped ~ 226 9
 load, unitized ~ 226 9, 21
 load hook 270 49
 loading bridge 221 90; 226 2
 loading chamber 116 6
 loading crane 85 28, 44
 loading deck 221 34
 loading dock 206 9
 loading door 207 23
 loading foreman 205 30; 206
 29
 loading gauge 206 22
 loading platform *Lorries etc.*
 194 3
 loading platform *Ship* 221 90
 loading siding 206 17
 loading strip 206 8
 loading supervisor 206 36
 loaf, French ~ 97 12
 loaf, long ~ 97 8
 loaf, round ~ 97 6, 7; 99 14
 loaf, small ~ 97 7
 loaf, white ~ 97 9
 loaf of bread 97 2
 loam 120 44; 159 2
 loan, personal ~ 250 4
 lobby 267 18-26; 315 12-13
 lobe 229 30
 lobe, pulmonary ~ 20 7
 lobe, upper ~ 20 7
 lobe of the liver 20 35
 lobster fork 45 79
 local-battery telephone 224
 27; 238 9, 40
 lock *Map* 15 58
 lock *Hunt.* 87 9
 lock *Hydr. Eng.* 217 20
 lock approach 217 26
 lock chamber 217 20
 lock gate 217 18, 32
 lock indicator panel 203 63
 locking bolt 117 62
 locking lever *Atom* 2 40
 locking lever *Motorcycles etc.*
 188 2
 locking lever *Office* 247 42
 locking mechanism 246 23
 locking nut 143 30; 187 54
 lock lever 203 55
 locknut 143 30; 187 54
 locksmith 140 1
 lock washer 202 8
 locomotive, articulated ~ 210
 64
 locomotive, electric ~ 205 35;
 211 1

locomotive, elevation of ~
 212 51-67
 locomotive, fireless ~ 210 68
 locomotive, mainline ~ 212 1
 locomotive boiler 210 2-37
 locust tree 371 70
 loft 37 4; 38 18
 log *Forestry* 84 20, 31
 log *Maths.* 345 6
 log, mechanical ~ 224 54
 log, sawn ~ 157 33
 log, ship's ~ 224 22
 logarithm 345 6
 logarithm sign 345 6
 log capacity scale 157 10
 log chain, endless ~ 157 17
 log clock 224 57
 log dump 85 32; 157 31
 log grips 85 29; 157 13, 39
 log grips, pivoted ~ 157 29
 logic element 242 68
 logic module 242 68
 log-kicker arm 157 19
 log ladder 273 22
 loin *Game* 88 18, 35
 loin *Meat* 95 3
 loin *Butch.* 96 4
 loin, pork ~ 95 46
 loincloth 352 38; 354 31
 loins *Man* 16 24
 loins *Horse* 72 30
 loin strap 71 32
 long-conductor antenna 230
 66
 long-distance racing 290
 1-15
 long-distance runner 298 5
 long drink 317 32
 long-eared bat 366 9
 long-eared owl 362 14
 long-fly 296 48; 297 20
 long haul airliner 231 13, 14
 long horse 296 1
 longicorn 358 38
 longicorn beetle 358 38
 longitude 14 7
 long johns 32 29
 long jump 298 37-41
 long line 90 28
 long-line fishing 90 28-29
 long-lining 90 28-29
 long measure 294 10
 long primer 175 27
 long rifle cartridge 305 38
 longship 218 13-17
 long sitting 295 10
 longwall face, cut ~ 144 34
 longwall face, ploughed ~ 144
 33
 longwall faces 144 33-37
 long-wire antenna 230 66
 lookout platform 273 23
 loom, automatic ~ 166 1, 35
 loom framing 166 24
 loop *Knitting* 167 62, 66
 loop *Weaves* 171 39
 loop *Airports* 288 1
 loop *Winter Sp.* 301 7; 302 15
 loop, closed ~ 171 36
 loop, open ~ 171 30
 loop, platinum ~ 23 15

loop, primary ~ 154 2, 42
 loop, secondary ~ 154 7, 45
 loop antenna 223 5
 loop paper 49 11
 loop fastening 30 41
 loop formation 167 65
 loop former 312 30
 loose-leaf file 260 15
 Lophocalyx philippensis 369
 7
 lopping 85 11
 lords-and-ladies 379 9
 Lord's table 330 4
 lorries 194
 lorry 226 19
 lorry, heavy ~ 194 20; 200 7
 lorry, light ~ 194 1, 5
 lorry, toy ~ 47 38; 273 62
 lorry tyre 273 19
 lorry wheel 138 21
 lorry with trailer 213 34
 loser 299 40
 lot 310 1
 lottery booth 308 44
 lottery ticket seller 266 20
 lotus column 333 13
 loud hailer 264 12
 loud pedal 325 8
 loudspeaker 42 10; 241 14;
 264 12; 311 46; 317 15; 318
 12
 loudspeaker, built-in ~ 249
 70
 loudspeaker aperture 309 19
 louis-d'or 252 5
 Louis Seize table 336 14
 lounge *Living Rm.* 42
 lounge *Ship* 223 26
 lounge *Airport* 233 18
 'lounge' *Airport* 233 28
 louver 321 29
 louvre shutter 304 12
 love-lies-bleeding 60 21
 low 9 5
 low box 172 26
 lower cable sleeve 214 74
 lower fore topgallant sail 219
 58
 lower fore topgallant yard 219
 35
 lower fore topsail 219 56
 lower fore topsail yard 219 33
 Lower Keuper 154 57
 lower main topgallant sail
 219 64
 lower main topgallant yard
 219 41
 lower main topsail 219 62
 lower main topsail yard 219
 39
 Lower Muschelkalk 154 60
 lower station platform 214
 51
 low house 305 76
 low-moor bog 13 14
 low-pressure area 9 5
 low-pressure manometer 141
 6
 low-pressure regulator 190 59
 low relief 339 33
 low-speed aileron 229 41

low-temperature surface
 insulation 235 15
 low tide 280 7
 low-voltage bushing 152 44
 low-voltage terminal 152 44
 lozenge 346 35
 L-seat 295 10
 L-support 295 16
 lubber's line 224 48
 lubber's mark 224 48
 lubber's point 224 48
 lubricant pump, automatic ~
 210 42
 lubricating nipple 143 81
 lubricating oil 145 62
 lubricating oil refinery 145 67
 lubricating system, pressure-
 feed ~ 192 16-27
 lubrication hole 187 62
 lubrication system 65 45
 lubricator 187 62, 65
 lubricator, automatic ~ 210 42
 lucerne 69 9
 ludo 47 19
 luff 284 42
 luffing 285 9
 luffing jib crane 222 23
 luge 303 13
 luge, junior ~ 303 3
 luge toboggan 303 13
 luge toboggan, junior ~ 303 3
 luge tobogganer 303 12
 luggage 205 7-12
 luggage carrier 187 44
 luggage clerk 204 9
 luggage compartment *Car*
 193 17, 23
 luggage compartment *Lorries*
etc. 194 13
 luggage compartment *Railw.*
 207 71; 208 15
 luggage counter 204 4
 luggage label 205 8
 luggage locker 194 18
 'luggage lockers' 233 39
 luggage rack 207 51; 208 27
 luggage receipt 204 8
 luggage rest 204 43
 luggage sticker 204 7
 lugger 90 1
 lugsail 220 4
 lug strap 166 22
 lumbar region 72 30
 lumber 120 2
 lumber, rough ~ 120 83
 lumberer 84 18
 lumbering 84 15-37
 lumberjack 84 18
 lumber-jacket 30 38
 lumberman 84 18
 lumber room door 38 20
 luminescent 369 14
 luminescent material 240 18
 lump coal 156 14
 lunar module 234 55
 lunar module hangar 234 54
 lunation 4 2-7
 lung 18 13; 20 6-7
 lung, right ~ 20 6
 lunge 295 42
 lunging 294 5

lunging position 294 5
lungwort 377 7
lunula *Man* 19 81
lunula *Prehist.* 328 25
lunula *Church* 332 36
lunule 19 81
lupin 51 23
lur 322 1
lute 324 1
lute pin 324 11
lycaenid butterfly 365 6
lychgate 331 19
Lyman series 1 20
lymph gland, submandibular ~ 19 10
lynx 368 8
lynx fur 131 20
lynx skin 131 15
lynx skin, let-out ~ 131 16
Lyoner sausage 96 10
Lyra 3 22
Lyre *Astron.* 3 22
lyre *Music. Instr.* 322 15
lyre flower 60 5

M

maar 11 25
macadam spreader 200 31
macaroni 98 33
macaroon, coconut ~ 97 37
mace 382 34
machicolation 329 23
machicolis 329 23
machine, four-cylinder ~ 189 49
machine, heavy ~ 189 43
machine, heavy-weight ~ 189 43
machine, high-performance ~ 189 43
machine, multi-magazine ~ 174 19
machine base 168 15
machine bed 177 57
machine chest 172 86; 173 1, 13
machine control lever 167 44
machine drum 323 57
machine gun 255 32
machine hood 173 27
machine housing 200 2
machine part 111 30
machine parts 143
machine processor 116 60
machinery and observation deck 224 107
machinery and observation platform 224 107
machinery shed 62 15
machine tap 150 44
machine tools 149; 150
machine wire 173 14
machining centre 150 41
mackerel sky 8 14
MacPherson strut unit 192 72-84
macramé 102 21
macro equipment 115 81-98
macro frame 117 56
macro lens attachment 117 55

macronucleus 357 11
Macropharynx longicaudatus 369 2
macrophoto stand 115 94
macro zoom lens 117 53
madeira glass 45 84
Madonna 330 51
Madonna lily 60 12
magazine *Doc.* 22 4
magazine *Flat* 46 20
magazine *Hunt.* 87 17
magazine *Cine Film* 117 45
magazine *Office* 249 33
magazine *Army* 255 15, 21
magazine *Police* 264 25
magazine *Chivalry* 329 13
magazine, rotary ~ 114 77
magazine, spring-loaded ~ 247 6
magazine back 115 80
magazine holder 255 7
magazine housing 313 9
magazine repeater 87 2
magazine rifle 87 2
magazine spring 87 18
magenta filter adjustment 116 43
maggot *Gdn. Pests* 80 19
maggot *Articulates* 358 19
'magic eye' 309 18
magmatism, plutonic ~ 11 29-31
magnesium plate 179 9
magnet 1 63; 2 51; 108 32; 212 38
magnetic disc store 244 1
magnetic film 311 21
magnetic film spool 311 2
magnetic head, four-track ~ 312 51
magnetic head cluster 312 28
magnetic head support assembly 311 3
magnetic sound amplifier 311 28
magnetic sound deck 311 20
magnetic sound head 312 50
magnetic sound recorder 310 58; 311 1
magnetic sound recording and playback deck 238 4
magnetic sound recording and playback amplifier 311 5
magnetic sound recording equipment 310 58; 311 1
magnetic sound unit, attachable ~ 312 50
magnetic sound unit, four-track ~ 312 50
magnetic tape 237 63; 238 4, 5; 244 2
magnetic tape dictating machine 249 62
magnetic tape loop 245 28
magnetic tape recording and playback equipment 238 55
magnetic tape reel 244 10
magnetic tape station 242 32
magnetic tape unit 244 9

magnifier 175 34
magnifying glass 175 34; 177 23
magnitude 3 14
magpie 361 3
magpie moth larva 58 5
maharaja 306 28
mahlstick 129 47
mail 329 62, 63
mail and cargo terminal 233 9
mailbag 236 54
mailbox 236 50
mail carrier 236 53
mailcoach 186 39, 53
mailcoach driver 186 40
mailman 236 53
mail van 236 52
main air pressure gauge 212 6
main air reservoir pressure gauge 212 8
main beam warning light 191 69
main course 218 33; 219 61
main drive unit 113 15
main engine revolution indicator 224 21
main engine room 223 72
main exchange line 237 18, 24
main line 203 45
mainmast 218 40; 219 5-7; 220 22
mainmast, lower ~ 219 5
main royal sail 219 66
main royal staysail 219 26
main royal yard 219 43
mainsail 218 33; 219 61; 220 11; 284 46; 285 2
mains button 195 11
mainsheet 284 28
mains power unit 311 11
maintained lift 299 5
maintenance technician 237 28
main title 185 46
maintop 219 52
main topgallant mast 219 7
main topgallant rigging 219 18
main topgallant sail 218 53
main topgallant staysail 219 25
main topmast 219 6
main topmast crossrees 219 53
main topmast rigging 219 17
main topmast staysail 219 24
main topsail 218 38
main topsail yard 218 39
main yard 218 37; 219 38
maize 68 1, 31
maize billbug 81 26
maize cob 68 36
maize kernel 68 37
majorette 306 67
major keys 320 55-68
major second 321 7
major seventh 321 12
major sixth 321 11
major third 321 8
major triad 321 1
majuscule 175 11

make-up 174 5
make-up artist 310 36; 315 48
make-up artist, chief ~ 315 47
make-up gown 315 44
make-up man, chief ~ 315 47
make-up table *Offset Platem.* 179 23
make-up table *Theatre* 315 45
Malacosteus indicus 369 10
malaria mosquito 81 44
malleolus, external ~ 19 59
malleolus, inner ~ 19 60
malleolus, internal ~ 19 60
malleolus, lateral ~ 19 59
malleolus, medial ~ 19 60
malleolus, outer ~ 19 59
malleolus fibulae 19 59
malleolus medialis 19 60
malleolus tibiae 19 60
mallet 118 54; 120 67; 125 18; 132 5; 158 36; 278 25; 339 21
malleus 17 61
malt 92 1-41
malt, green ~ 92 23
malt beer 93 26
malt elevator 92 35
maltster's cross mechanism 312 38
maltster's movement 312 38
malting 92 1-41
malting 92 1
malting tower 92 1
malt silo 92 37
mammary 16 28-29
mammal, flying ~ 366 9
mammal, oviparous ~ 366 1
mammal, scaly ~ 366 10
mammals 366; 367; 368
mammals, insect-eating ~ 366 4-7
mammals, marsupial ~ 366 2-3
mammoth tree 372 69
Man 16; 17; 18; 19; 20
manager 299 45
manatee 366 23
manati 366 23
mandarin *Carnival* 306 29
mandarin *South. Fruits* 384 23
mandible *Man* 17 35
mandible *Articulates* 358 25
mandible, lower ~ 359 8
mandolin 324 16
mandrel 125 19
mane 72 13
mane, lion's ~ 368 3
man-eater 364 1
maneuver *see* manoeuvre
maneuvering *see* manoeuvring
mangelwurzel 69 21
manger board 258 7, 76
mangle 165 46
mangold 69 21
mangoldwurzel 69 21
manhole *Roof & Boilerr.* 38 45

manhole *Brew.* 93 13
manhole *Cooper* 130 18
manhole *Space* 234 30; 235 52
manhole *Water* 269 26, 51
manhole cover *Roof & Boilerr.* 38 46
manhole cover *Cooper* 130 19
manhole cover *Street Sect.* 198 17
manikin 338 31
manipulator 2 38
manipulator, mechanical ~ 139 32
manipulators 2 47
man-made fibres 169; 170
mannequin 338 31
manoeuvres, principal, of aircraft 230 67-72
manoeuvring keel 227 30
manoeuvring rocket assembly 234 63
manoeuvring rockets 6 5, 39
manometer 25 22; 67 10; 83 42; 178 8; 196 20; 349 19
manostat 269 47
manque 275 22
mansard dormer window 121 19
mansard roof 121 18
mantelpiece 267 24
mantelshef 267 24
mantissa 345 6
mantle *Phys. Geog.* 11 3
mantle *Iron & Steel* 147 46
mantle *Heraldry* 254 3
mantle clock 42 16
mantling 254 3, 14
manual 325 48; 326 42, 43, 44, 45
manual, lower ~ 322 47
manual, upper ~ 322 46
manual feed station 184 2
manure 63 15
manure distributor 62 21
manure fork, four-pronged ~ 66 7
manure gutter 75 20
manure hoe 66 8
manure removal 74 23-27; 75 21
manure spreader 62 21; 63 39
manway 154 32
map *Map* 14; 15
map 204 15; 260 44; 268 2
maple seed 371 57
maple tree 371 53
map light 230 23
map of the world 14 10-45
mapping 348 9, 10
mapping, one-to-one ~ 348 11
mappings 348 9-11
map projections 14 8-9
map signs 15 1-114
map symbols 14 27-29; 15 1-114
maraca 324 59
marcando 321 27
marcato 321 27
mare 73 2

margarine 98 21; 99 48
margin 185 55-58
margin, back ~ 185 55
margin, inside ~ 185 55
margin, outside ~ 185 57
margin, upper ~ 185 56
margin control 180 5, 20
margin release key 249 6
margin scale 249 12
margin stop, left ~ 249 13
margin stop, right ~ 249 14
marguerite 51 24; 376 4
marimba, steel ~ 324 61
marimbaphone 324 61
marine sequence 310 11
mark 285 17
mark, port hand ~ 224 95
mark, starboard hand ~ 224 96
marker 85 12
marker, port ~ 224 100
marker, starboard ~ 224 99
market for securities 251 2
market garden 55 1-51, 3
market place 15 52
market square 15 52
market woman 308 65
markiert 321 27
marking, axillary ~ 88 74
marking hammer 85 12
marking iron 85 12
marking out 104 21
markings, graduated ~ 115 65
mark of omission 342 29
marks, diacritical ~ 342 30-35
marl 160 1
marmot 366 18
maroon 306 53
marquise 36 55
marriage ceremony 332 14
Mars 4 46
marsh *Phys. Geog.* 13 14-24
marsh *Map* 15 20
marshal 329 75
marshaling *see* marshalling
marshalling yard 206 42
marshalling yard signal box 206 44
marsh harrier 362 13
marshmallow *Bakery* 97 36
marshmallow *Med. Plants* 380 12
marsh plants 378 14-57
marsh tea 377 21
marsupials 366 2-3
marten 86 22
martens 367 14-17
martinet 218 36
marzipan 98 82
Masai warrior 354 8
mash 93 10
mash copper 92 44
masher 92 49
mashhouse 92 42-53
mashing process 92 42-53
mash kettle 92 44
mash thermometer 93 9
mash tub 92 43
mash tun 92 43, 44
mask *Hosp.* 27 48
mask *Swim.* 279 10

mask *Carnival* 306 7
 mask *Films* 310 51; 313 4
 mask *Sculpt. Studio* 339 37
 mask, clay ~ 260 75
 mask, pressure-equalizing ~ 279 10
 mask, wooden ~ 354 16
 mask drum 177 48
 masked ball 306 1-48
 masking frame 116 35
 masking tape 128 16
 mask-scanning head 177 47
 masonry bonds 118 58-68
 masonry dam 217 58
 masquerade 306 1-48, 6-48
 mass 11 43
 mass, continental ~ 11 7
 massage bath 281 33
 mass book 330 38
 masseter 19 7
 massif 12 39
 mast 219 1-9; 221 77; 284 4, 11
 mast, full-rigged ~ 220 16
 mast, half-rigged ~ 220 15
 Master 289 45
 master arm 2 42
 master brewer 92 49
 master butcher 96 38
 master clock 245 18
 master compass 224 51
 master control panel 242 3
 master furrow 91 18
 master gyro compass 224 51
 Master of foxhounds 289 45
 master selector 195 8
 master/slave manipulator 2 47
 master station 224 40
 master switch 153 2
 master turner 135 20
 master volume control 261 44
 masterwort 376 7
 mat 299 12
 matador 319 25, 31
 match 107 22
 matchbox 107 21
 matchbox holder 266 24
 match head 107 23
 mate 276 15
 maté 382 11
 material *School* 260 81
 material *Store* 271 59
 material, basic ~ 169 1
 material, radioactive ~ 1 28
 materials store 146 6
 maté shrub 382 11
 mathematics 344; 345; 346; 347; 348
 mathematics, higher ~ 345 11-14
 matinée coat 29 3
 matrix *Man* 20 79
 matrix *Composing Rm.* 174 21, 31
 matrix, punched ~ 175 37
 matrix, stamped ~ 175 37
 matrix-boring machine 175 49
 matrix case 174 42, 46; 176 17
 matrix clamp 175 59

matrix disc 176 20
 matrix drum 176 27
 matrix-engraving machine 175 49
 matrix for hand-setting 174 28
 matrix holder 24 55
 matrix mimic board 153 8
 mat sail 353 33
 matte 313 4
 matte box 313 3
 matter 174 15; 181 37
 matter, front ~ 185 43-47
 matter, machine-set ~ 174 27
 matter, preliminary ~ 185 43-47
 matting, reed ~ 55 6
 matting, straw ~ 55 6
 mattress 47 3; 296 18
 mattress, foam ~ 43 10
 matt weave 171 11
 maturing 169 7
 mauerkrone 254 46
 mausoleum 337 16
 mavis 361 16
 maw worm 81 31
 maxilla 17 36; 19 27
 maximum 347 19
 maximum thermometer 10 53
 may 374 30
 Maya temple 352 20
 May bug 82 1
 mayfly 358 6
 maypole swing 273 8
 maze 272 5
 M-cardan 67 29
 meadow 13 13; 62 44; 63 22
 meadow buttercup 375 8
 meadow fescue grass 69 24
 meadow flowers 375; 376
 meadow foxtail 69 27
 meadow grass 375 39
 meadow grasshopper 358 8
 meadow mushroom 381 1
 meadow saffron 379 3
 meal, complete ~ 266 17
 meal, deep-freeze ~ 96 23
 meal, deep-frozen ~ 96 23
 meal, hot ~ 266 67
 meal, ready-to-eat ~ 96 23
 meal beetle 81 18
 meal of the day 266 27
 meal worm beetle 81 18
 meander *Phys. Geog.* 13 11
 meander *Art* 334 43
 meander core 13 12
 mean low water 15 9
 mean sea level 146 39
 measure *Hotel* 267 60
 measure *Music. Not.* 320 28-42
 measure line 320 42
 measurement chamber 112 43
 measurement dial 242 75
 measurement range selector *Atom* 2 4, 23
 measurement range selector *Optic. Instr.* 112 46

measurement range selector *Inf. Tech.* 242 74
 measurement scale 242 75
 measuring and control unit 178 3
 measuring arm 142 38
 measuring beaker 267 60
 measuring cylinder *Doc.* 23 43
 measuring cylinder *Photog.* 116 11
 measuring cylinder *Paperm.* 173 4
 measuring cylinder *School* 261 26
 measuring cylinder *Chem.* 350 26
 measuring device 112 51
 measuring flask 350 27
 measuring glass 10 47; 350 26
 measuring instrument 153 30
 measuring instrument platform 235 69
 measuring instruments 149 56-72
 measuring machine, universal-type ~ 112 67
 measuring probe 234 42
 measuring rod *Map* 14 47
 measuring rod *Cine Film* 117 59
 measuring rod *Quarry* 158 26
 measuring scale 149 63
 measuring tank 130 22
 measuring tape 103 2; 271 38
 measuring vessel 93 3; 130 33
 meat 96 1-4, 59; 99 53
 meat, canned ~ 98 20
 meat, cold ~ 96 14
 meat, minced ~ 96 16
 meat, roast ~ 45 27
 meat, smoked ~ 96 3
 meat axe 94 18
 meat chopper 40 39
 meat counter 99 51
 meat dish 266 55
 meat grinder 96 53
 meathook 96 55
 meat inspector 94 24
 meat joints 95
 meat mincer 96 53
 meat-mixing trough 96 40
 meat plate 45 26
 meat platter 45 26
 meat product 99 53
 meat salad 96 13
 meat saw 94 20
 mechanic 140 1
 mechanical finger car 159 18
 mechanical pulp mill 172 53-65
 mechanism casing 255 10
 medallion 339 36
 Mediaeval 342 4
 medical card 22 8
 medical laboratory technician 23 41
 medical record 22 8
 medicament, water-soluble ~ 25 14
 medicine 22 23

medicine cabinet 49 49
 medicine case 24 7
 medicine cupboard 22 35
 medicine sample 22 41
 Mediterranean 14 25
 medium 308 9
 medium haul airliner 231 12
 medium measure 294 10
 medulla oblongata 17 47; 18 24
 medusa 357 14
 meeting 263 8
 meeting, public ~ 263 1-15
 'meeting point' 233 29
 meganucleus 357 11
 megaphone 283 21
 megaphone exhaust pipe 189 51
 meibar 9 3
 Melanocetes 369 6
 melodium 325 43
 melody key 324 39
 melody pipe 322 10
 melody side 324 39
 melody string 322 30; 324 24
 melon 57 23
 melter 148 7
 melting bath 162 3, 14
 melting furnace *Iron Foundry etc.* 148 11
 melting furnace *Electrotyp.* etc. 178 19
 melting plant 148 1-12
 melting pot *Goldsm. etc.* 108 8
 melting pot *Synth. Fibres* 170 30
 member, diagonal ~ 215 35
 member, upright ~ 119 59
 member, vertical ~ 215 36
 member of set 348 2
 membership card 275 14
 membrane 241 68
 membrane, parchment ~ 324 31
 membrane, periodontal ~ 19 28
 membrane, tympanic ~ 17 59
 membrane, vitelline ~ 74 64
 membranophones 323 51-59
 memorial chapel 331 12
 memorial plate 331 14
 memorial tablet 331 14
 memory, main ~ 244 6; 245 28
 memory key 247 22
 memory typewriter 245 26
 memory unit 176 11; 242 9
 memo sheet 247 34
 menagerie 307 63
 menhir 328 18
 menhir group 328 11
 men's wear 33
 men's wear department 271 12
 menu 266 21
 menu card 266 21
 Mercator projection 14 9
 Mercury 4 43
 mercury barometer 10 1
 mercury battery 25 32

mercury column 10 2
 mercury manometer 25 18
 meridian 14 4
 meridian circle 113 26
 meridian of Greenwich 14 5
 meridian of longitude 14 4
 meridians 14 1-7
 meridian telescope 113 29
 meringue 97 26; 265 5
 merlin 362 1
 merlon 329 7
 mermaid 327 23
 merman 327 23, 40
 merry-go-round 308 2
 mesa 13 59
 mesh 171 37
 mesh connection 153 21
 mesh gauge 102 25
 mesh pin 102 25
 mesh ventilator 278 40
 Mesolithic period 328 1-9
 messroom 228 25
 metacarpal 17 16
 metal, noble ~ 237 42
 metal-blocking device 111 34
 metal feeder 174 26
 metal feeder, automatic ~ 174 40
 metal runner 147 35
 metals 254 24-25
 metal shears 108 23; 125 1
 metalworker 140 1
 metalwork shop 140 1-22
 metatarsus 17 28
 metazoans 357 13-39
 meteor 7 18
 meteorite crater 6 16
 meteorological instruments 10
 meteorological office 225 33
 meteorological watch office 9 7
 meteorology 8; 9
 meter *Atom* 2 6
 meter *Photog.* 114 62
 meter *Blacksm.* 138 19
 meter *Serv. Stat.* 196 14
 meter *Music. Not.* 320 28-42
 meter, customer's ~ 237 16
 meter, multiple ~ 242 73
 meter, private ~ 237 16
 meter, rotary ~ 269 53
 meter, subscriber's ~ 237 16
 meter cell 114 3, 24; 115 37
 metering pump 169 13
 metope 334 16
 metre tape measure 103 2
 metronome 325 19
 mezzanine 315 18
 mezzo staccato 321 29
 mezzotint 340 14-24
 micro attachment 115 89
 micro cassette recorder 246 32
 microfilm card 237 38
 microfilm file 237 37
 microfilming system 242 31
 microfilm reader 237 36
 micrometer 142 37; 149 62; 173 10; 224 4
 micrometer eyepiece 14 53

micrometer head 14 52
 micronucleus 357 12
 microphone 22 15; 117 8, 24, 74; 197 26; 209 31; 224 30; 230 29; 237 9; 241 49; 261 39; 263 7; 310 30; 317 20
 microphone, built-in ~ 241 5; 243 3
 microphone, umpire's ~ 293 21
 microphone base 241 51
 microphone boom 310 25
 microphone boom, telescopic ~ 117 23
 microphone cable 239 14; 310 32; 311 41
 microphone connecting cord 117 25
 microphone connecting lead 117 25
 microphone cradle 249 65
 microphone screen 241 50
 microphone socket 249 69
 microphone socket panel 238 36
 microphone stand 241 51
 micropism collar 115 54
 micropism spot 115 58, 59, 62, 63
 micropyle 383 57
 microscope 111 19; 112 1
 microscope, metallurgical ~ 112 23
 microscope, surgical ~ 112 31
 microscope, universal ~ 112 54
 microscope, wide-field ~ 112 23, 54
 microscope body 113 31-39
 microscope camera, fully automatic ~ 112 64
 microscope for reflected light 112 23
 microscope stage 112 9
 microscope tube 113 31-39
 microwave treatment unit 23 36; 24 23
 mid-channel 224 98
 middle-distance runner 298 5
 middle ground 224 91
 middle ground to port 224 88
 middle mast 220 33
 Middle Muschelkalk 154 59
 middle of the fairway 224 98
 middle section 259 55-74
 middling 91 2
 midfield player 291 14
 midge 358 16
 midget 308 22
 midi bus 194 34
 midinette 306 21
 mid-range speaker 241 16
 midrib 370 30
 mihrab 337 14
 milch-cow 62 34; 75 17
 mild 93 26
 mildew 80 20
 milestone 15 109
 milk 99 45; 266 60
 milk, canned ~ 98 15
 milk, homogenized ~ 99 44

milk, long-life ~ 99 44
 milk, pasteurized ~ 99 44
 milk, sterilized ~ 76 16
 milk carton 76 22
 milk churn 309 89
 milker 62 34; 75 17, 25
 milk glass 124 5
 milk heater 76 13
 milking parlour 75 23
 milk jug 44 31
 milkman 75 25
 milk pipe 75 27
 milk pot 40 15
 milk processing area 76 12-48
 milk reception 76 1
 milk tanker 76 2
 milk tub filler 76 21
 milkwort 377 3
 Milky Way 3 35
 mill 276 24
 miller 91 15
 millet 68 28
 millibar scale 10 3
 millimeter graduation 247 36
 millimetre scale 10 3
 milliner 35 1
 milliner's shop 268 38
 milling machine, rotary ~ 168 1
 milling machine, universal ~ 150 32
 milling machine table 150 33
 milling roller, bottom ~ 168 4, 6
 milling roller, top ~ 168 3
 millrace 91 44
 mills 91
 mill spindle 91 12
 millstone 91 16, 21
 millstone, upper ~ 91 22
 millstone casing 91 20
 millstone ruff 355 52
 millstream 91 44
 mill weir 91 42
 mill wheel, breast ~ 91 37
 mill wheel, middleshot ~ 91 37
 mill wheel, overshot ~ 91 35
 mill wheel, undershot ~ 91 39
 milometer 187 33
 mimbar 337 15
 minaret 337 13
 minbar 337 15
 mince 96 16
 mincemeat 96 16
 mincer 40 39; 96 53
 mincing machine 96 52, 53
 mine 15 34
 mine, disused ~ 15 35
 mine car 144 45
 mine fan 144 16
 minehead buildings 154 70
 mine hunter 258 80
 minelayer 258 94
 mineral bath, outdoor ~ 281 9
 mineral spring 274 11
 mineral water 266 61
 minesweeper 258 84
 mine-sweeping gear 258 87
 miniature film cassette 112 35
 minibus 194 9; 195 47

minigolf course 272 68
 minigolf hole 272 70
 minigolf player 272 69
 minim 320 14
 minim rest 320 22
 minimum 347 20
 minimum thermometer 10 54
 mining, underground ~ 144 21-51
 minion 175 24
 minionette 175 23
 mink 30 60
 mink skin 131 11
 mink skin, let-out ~ 131 19
 minnesinger 329 70
 minor keys 320 55-68
 minor planets 4 47
 minor triad 321 2
 minstrel 329 70
 mintage 252 10, 40-44
 minting dies 252 40-41
 minting press 252 44
 mint mark 252 10
 minuend 344 24
 minus blue filter adjustment 116 44
 minuscule 175 12
 minuscule, Carolingian ~ 341 18
 minus green filter adjustment 116 43
 minus red filter adjustment 116 45
 minus sign 344 8, 24
 minute hand 110 12
 Mira 3 11
 mirabelle 59 25
 mire crow 359 14
 mirror 43 29; 49 33; 105 20; 106 6; 111 4; 177 38; 188 35; 189 30; 207 49
 mirror, angled ~ 177 28
 mirror, auxiliary ~ 115 38
 mirror, concave ~ 5 32; 308 56; 312 39
 mirror, convex ~ 308 57
 mirror, flat ~ 5 3
 mirror, illuminating ~ 14 59
 mirror, main ~ 5 1; 113 10
 mirror, primary ~ 5 1; 113 10
 mirror, right-angle ~ 261 10
 mirror, rotating ~ 243 54
 mirror, secondary ~ 5 2; 113 11
 mirror, semi-reflecting ~ 243 55
 mirror, triple ~ 104 1
 mirror arc lamp 312 39
 mirror assembly 176 21
 mirror carp 364 4
 mirror lens 115 50
 mirror manometer 349 20
 mirror reflex system 115 31
 mirror spot 316 48
 mirror spotlight 316 48
 mirror system 176 24
 missal 330 38
 missile 258 49
 missile, short-range ~ 259 26
 missile, wooden ~ 352 39; 353 8

missile cruiser 259 21, 41
 missile launcher, underwater ~ 259 37, 51
 missile-launching housing 258 71
 miter see mitre
 miter angle 120 82
 mitre 124 4
 mitre block 124 30
 mitre board 124 31
 mitre box *Glaz.* 124 30
 mitre box *Joiner* 132 43
 mitre gate 217 19
 mitre joint 124 4
 mitre shoot 124 31
 mitre square 120 82
 mitring machine 124 7
 mitt, catcher's ~ 292 60
 mitt, fielder's ~ 292 59
 mitten crab 358 1
 mixed asphalt outlet 200 54
 mixer *Dent.* 24 51
 mixer *Kitch. Utensils* 40 45
 mixer *Cine Film* 117 26
 mixer *Synth. Fibres* 170 53
 mixer *Aircraft* 232 48
 mixer *Broadcast.* 238 25
 mixer *Films* 311 21
 mixer *Disco* 317 26
 mixer, double shaft ~ 159 10
 mixer, hand ~ 39 22
 mixer, high-speed ~ 79 5
 mixer, propeller-type ~ 79 5
 mixer drum 200 15
 mixer operator 118 32
 mixer tap 39 36; 49 2; 106 14; 126 27
 mixing 169 2
 mixing chamber 83 62
 mixing chest 173 1
 mixing console *Cine Film* 117 26
 mixing console *Broadcast.* 238 25
 mixing console *Films* 310 56; 311 35
 mixing console *Disco* 317 26
 mixing desk *Cine Film* 117 26
 mixing desk *Broadcast.* 238 25
 mixing desk *Films* 310 56; 311 35
 mixing desk *Disco* 317 26
 mixing drum 118 34; 200 15
 mixing faucet 39 36; 49 2; 106 14; 126 27
 mixing machine 200 15
 mixing plant, central ~ 201 19
 mixing plant, stationary ~ 201 19
 mixing room 311 34
 mixing screw 83 59
 mixing spoon 40 3
 mixing tank 172 35
 mixture, additive ~ 343 10
 mixture, subtractive ~ 343 12
 mixture control 230 31; 288 16
 Mizar 3 29
 mizen see mizzen
 mizzen 218 29; 219 30

mizzen, lower ~ 219 8
 mizzen mast 218 31; 219 8-9; 220 23, 24, 30, 34
 mizzen staysail 219 27
 mizzen top 219 54
 mizzen topgallant sail 218 54
 mizzen topgallant staysail 219 29
 mizzen topmast 219 9
 mizzen topmast rigging 219 17
 mizzen topmast staysail 219 28
 moat 329 33, 37; 356 3
 mobile 260 70
 moccasin 101 30; 352 18
 moccasin flower 376 27
 mock orange 373 9
 model, clay ~ 260 67
 model, dressmaker's ~ 103 6
 model, nude ~ 338 32
 model, plaster ~ 339 4
 model, wax ~ 339 26
 model aeroplane 273 37, 38
 model aeroplanes 288 85-91
 model coat 103 7
 model dress 103 5
 model flight, radio-controlled ~ 288 85
 model hat 357
 modeling see modelling
 modeller 339 5
 modelling board 48 14; 339 34
 modelling clay 48 12; 339 31
 modelling stand 339 9
 modelling substance 339 8
 modelling tool 161 20
 modelling tool, wire ~ 339 11
 modelling tool, wooden ~ 339 10
 model of set 315 42
 models of molecules 242 61-67
 model stage 315 41
 moderator 1 54
 modular elements 242 68-72
 module, electronic ~ 242 69
 module, lunar ~ 6 12
 module, magnetic ~ 242 72
 moistener 247 31
 moisturising cream 99 27
 molar 19 18, 35
 mold see mould
 molder 97 57
 mole *Map* 15 48
 mole *Hydr. Eng.* 217 15
 mole *Docks* 225 65
 mole *Mammals* 366 4
 molecular rearrangement 170 23
 molluscs 357 27-36
 monastery *Map* 15 63
 monastery *Church* 331 52-58
 monastery garden 331 53
 money 252; 265 3
 money, hard ~ 252 1-28
 money, metal ~ 252 1-28
 money, paper ~ 252 29-39
 money compartment 271 6
 money order 236 27

moneywort 375 26
 monitor 23 27; 26 15, 16, 33; 27 23
 monitor *Cine Film* 117 97
 monitor *Broadcast.* 238 33
 monitor *Audiovis.* 243 6
 monitor *Fire Brig.* 270 66
 monitor *Theatre* 316 18
 monitor *Fish etc.* 364 31
 monitor, six-channel ~ 27 31
 monitoring and control panel 238 1, 7
 monitoring controls 153 5
 monitoring instrument 311 15
 monitoring loudspeaker 239 9; 311 13
 monitoring speaker 238 15
 monitoring unit, mobile ~ 25 24
 monitor lizard 364 31
 monitor support, swivel-mounted ~ 27 24
 monitor unit 25 44
 monk 89 9
 monk, Benedictine ~ 331 54
 monkey bridge 223 4-11; 227 24
 monkey house 356 10
 monkey nut 383 41
 monkeys 368 12-13
 monkshood 379 1
 monochlorobenzene 170 9
 monoclinic crystal system 351 24-25
 monogram 36 41
 mono-line control system 288 90
 monolith 328 18
 monoplane, high-wing ~ 229 1; 231 2
 monoplane, low-wing ~ 229 5, 14; 231 1
 monoplane, midwing ~ 229 4
 monoplane, shoulder-wing ~ 229 3
 mono posto 290 34
 monorail car 144 43, 44
 monoski 286 56
 mono sound 311 35
 monotreme *Mammals* 366 1
 monotype caster 174 39
 monotype casting machine 174 39
 monotype composing and casting machine 174 32-45
 monotype composing machine 174 32
 monsoon 9 52
 monster 327 16
 monster, winged ~ 327 55
 monstrel 331 48; 332 34
 monter 319 29
 monument *Map* 15 92
 monument *Park* 272 10
 moon 4 1-9, 31, 45
 moon, full ~ 4 5
 moon, new ~ 4 2
 moon, waning ~ 4 7
 moon, waxing ~ 4 3
 moon landing 6

moor buzzard 362 13
 moor harrier 362 13
 moor hawk 362 13
 mooring 283 19
 mooring bitt, cross-shaped ~ 217 13, 14
 mooring bitt, double ~ 217 14
 mooring chain 224 72
 mooring line 288 66
 mooring sinker 224 73
 moose 367 1
 mop, gilder's ~ 129 54
 mopboard 123 21, 63
 moped 188 24
 moped, battery-powered ~ 188 20
 moped headlamp 188 29
 mopeds 188
 Mopsea 369 8
 moraine, lateral ~ 12 53
 moraine, medial ~ 12 54
 morainic filter layer 199 24
 Morchella conica 381 27
 Morchella esculenta 381 26
 mordant 178 24; 182 16
 mordent, inverted ~ 321 19
 mordent, lower ~ 321 20
 mordent, upper ~ 321 19
 morel 381 26, 27
 morello 59 5
 morello cherry 59 5
 morion 329 60
 morse 367 20
 morse lamp 223 7
 mortadella 96 7
 mortar *Army* 255 40
 mortar *Chem.* 349 9
 mortar bed 123 27
 mortar pan 118 39
 mortar trough 118 20, 39, 84
 mortar tub 118 39
 mortice see mortise
 mortise, forked ~ 121 85
 mortise and tenon joint 121 84, 85
 mortise axe 120 72
 mortise chisel 132 8
 mortise lock 140 36-43
 mortiser 120 17
 mortising chain, endless ~ 132 50
 mortuary 331 21
 mosaic 338 37
 mosaic figure 338 38
 mosque 337 12
 mosquito 358 16
 moss 377 17
 moss phlox 60 14
 moss pink 60 14
 moth 58 64; 81 13; 82 15, 18, 45, 48
 moth, female ~ 82 30
 moth, male ~ 82 29
 moth, night-flying ~ 82 14
 moth, nocturnal ~ 82 14
 mother 28 6; 272 71
 mother-of-pearl 357 34
 mother sheep 75 10
 moths 358 48-56; 365 7-11
 motif *Child. Clothes* 29 20
 motif *Art. Studio* 338 27

motion, longitudinal ~ 149 17
 motion picture camera,
 lightweight ~ 313 20
 motion picture camera,
 narrow-gauge ~ 313 31
 motion picture camera,
 professional ~ 313 20, 31
 motion picture camera,
 soundproof ~ 310 47; 313
 15
 motion picture camera,
 standard-gauge ~ 313 1
 motion picture cameras 313
 1-39
 motion picture laboratory 310
 2; 311 30
 motion picture library 310 5
 motion picture projection 312
 1-23
 motion pictures 310; 311;
 312; 313
 motion picture storage vault
 310 5
 motions, rotary ~ 4 22-28
 moto cross 290 24-28
 motor *Forestry* 84 34
 motor *Watchm.* 109 13
 motor *Iron Foundry etc.* 148
 64
 motor *Weaving* 165 12, 34
 motor *Electrotyp. etc.* 178 14
 motor *Tram* 197 5, 7
 motor *Water* 269 45
 motor, auxiliary ~ 211 17
 motor, built-in ~ 164 2
 motor, built-on ~ 164 33
 motor, electric ~ *Roof &
 Boilerr.* 38 59
 motor, electric ~ *Pest Contr.*
 83 53
 motor, electric ~ *Blacksm.*
 138 2
 motor, electric ~ *Weaving* 166
 18
 motor, electric ~ *Railw.* 212
 34
 motor, electric ~ *Ship* 223 69
 motor, synchronous ~ 176 19
 motor, three-phase ~ 164 35
 motor, two-stroke ~ 56 30
 motor base plate 164 36
 motor bedplate 164 36
 motorboat 283 2
 motorboat landing stage 216 7
 motorboats 286 1-5
 motor car 191 1-56; 192;
 193; 195 34
 motor car mechanic 195 53
 motor coach 194 17
 motor cruiser 286 4
 motor cultivator 56 18
 motorcycle 189; 268 35
 motorcycle, heavyweight ~
 189 31
 motorcycle, light ~ 188 39;
 189 1, 16
 motorcycle, lightweight ~ 189
 1
 motorcycle, pacer's ~ 290 12
 motorcycle chain 189 22
 motorcycle racing 290 24-28

motorcycles 188
 motorcycles, heavy ~ 189
 31-58
 motorcycles, heavyweight ~
 189 31-58
 motorcycles, large-capacity ~
 189 31-58
 motorcycle stand 189 21
 motorcycle tyre 189 26
 motorcyclist 268 34; 290 11
 motor drive 115 76
 motor drive, attachable ~ 115
 78
 motor drive gear 167 31
 motor ferry 216 6
 motor grader 200 19
 motor pump 270 8
 motor safety switch 269 46
 motor saw 84 22, 27; 85 13
 motor scooter 188 47
 motor ship 223
 motorsports 290 24-38
 motor truck, heavy ~ 194 20
 motor turntable ladder 270 9
 motor unselector 237 42
 motor unit 50 82
 motor vehicle mechanic 195
 53
 motorway *Map* 15 16
 motorway *Docks* 225 54
 motor winch 287 6
 moufflon 367 6
 mouflon 367 6
 mould *Bldg. Site* 119 84
 mould *Iron & Steel* 147 37
 mould *Glass Prod.* 162 47
 mould *Paperm.* 173 48
 mould, fixed ~ 178 22
 mouldboard 65 4, 64
 moulder *Bakery* 97 57
 moulder *Iron Foundry etc.*
 148 30
 moulding, concave ~ 334 29
 moulding, hollow ~ 336 10
 moulding, ornamental ~ 336
 12
 moulding box, closed ~ 148
 18
 moulding box, open ~ 148 33
 moulding department 148
 30-37
 moulding press, hydraulic ~
 178 7
 moulding sand 148 35
 moulding shop 148 30-37
 mould loft 222 3
 mould wall 148 29
 mound *Equest.* 289 8
 mound *Prehist.* 328 16
 mound *Art* 337 21
 mountain ash 371 42
 mountain climber 300 5
 mountain climbing 300 1-57
 mountaineer 300 5
 mountaineering 300 1-57
 mountaineering boot 300 42
 mountaineering equipment
 300 31-57
 mountain hut 300 1
 mountain racing 290 24-28
 mountain railroads 214 1-14

mountain railways 214 1-14
 mountain range 12 39
 mountain ridge 12 36
 mountains, folded ~ 12 12-20
 mountain slope 12 37
 mountain top 12 35
 mounting, German type ~
 113 16
 mounting, mobile ~ 27 22
 mounting, underfloor ~ 127
 22
 mount of the frame 111 10
 mourner 331 33
 mourning cloak butterfly 365
 5
 mourning veil 331 39
 mousetrap 83 36
 moustache, English-style ~
 34 19
 moustache, military ~ 34 19
 moustache, waxed ~ 34 13
 mouth *Man* 16 13; 19 14-37
 mouth *Horse* 72 9
 mouth *Forestry* 84 28
 mouth *Game* 88 13, 45
 mouth *Joiner* 132 21
 mouth *Airsports* 288 70, 81
 mouth *Music. Instr.* 326 25
 mouth, fork-tongued ~ 327 5
 mouth band 322 5
 mouth gag 22 48
 mouth lamp 24 42
 mouth mirror 24 41
 mouth organ 324 35
 mouthpiece *Hosp.* 27 38
 mouthpiece *Tobacc. etc.* 107
 40
 mouth piece *Electrotyp. etc.*
 178 17
 mouthpiece *Post* 237 9
 mouthpiece *Music. Instr.* 323
 36; 324 33, 72
 mouthwash 49 36
 movable-comb hive 77 45-58
 movable-frame hive 77
 45-50
 movable half 215 66
 move 276 14
 movie audience 312 5
 moviegoer 312 5
 movie house 312 1
 movie projector 312 24
 movie script 310 45
 movie set 310 7
 movie studios 310 1-13
 movie theater 312 1
 movie theater box office 312
 2
 movie theater ticket 312 3
 moving iron 137 39
 mower, electric ~ 56 31
 mower, hand ~ 56 34
 mower, motor ~ 56 28
 mower, riding ~ 56 37
 mower, rotary ~ 63 19
 mud drum 210 28
 mudguard, front ~ 187 13
 mudguard, rear ~ 187 43
 mud pump 145 16
 muffle furnace 140 11
 muffler *Car* 191 29

muffler *Railw.* 209 12, 22, 24;
 211 49
 muffler *Sports* 305 93
 mulberry-feeding moth 358
 48
 mule *Dom. Anim.* 73 8
 mule *Shoes* 101 25
 mule, open-toe ~ 101 22
 mule cop 165 15
 muleta 319 33
 mull 183 33; 185 20
 mullion *Dwellings* 37 35
 mullion *Art* 335 41
 mull roll holder 185 19
 multiple cable system 215 51
 multiple drying machine 169
 31
 multiple-frame viewfinder
 114 41
 multiple meter 127 41
 multiple-unit train 211 60
 multiplicand 344 25
 multiplication 344 25
 multiplication sign 344 25
 multiplier 344 25
 multiplier phototube 112 51
 multiplier reel 89 59
 multiplying 344 25
 multiple combat aircraft 256
 8
 multirole helicopter, light ~
 232 11
 multi-tier transport 74 35
 mummy 352 21
 Munich beer 93 26
 mural 338 40
 Muschelkalk 154 58, 59, 60
 muscle, contractile ~ 77 17
 muscle, deltoid ~ 18 35
 muscle, pectoralis ~ 18 36
 muscle, sternocleidomastoid
 ~ 18 34; 19 1
 muscle, sternomastoid ~ 18
 34; 19 1
 muscle, temporal ~ 19 3
 muscle, thenar ~ 18 41
 muscles, ocular ~ 19 44
 muscles of facial expression
 19 6
 muscles of the neck 19 12
 muscular system 18 34-64
 musculature 18 34-64
 musette 322 8
 mushroom 381 2, 3
 mushrooms, poisonous ~ 379
 10-13
 musical instruments 322;
 323; 324; 325; 326
 musical instruments, popular
 ~ 324 1-46
 musical notation 320; 321
 music recording studio 310 14
 music recording theatre 310
 14
 music rest 326 36
 music stand 326 36
 music systems 241
 musk ox 367 10
 mussel shell 357 36
 mustard 352 4
 mustard *Weeds* 61 16

mustard *Grocer* 98 28
 mute 323 10; 324 68
 mute swan 359 16
 mutton spanker 218 29
 mutule 334 13
 muzzle *Dog* 70 3, 31
 muzzle *Game* 88 45
 muzzle *Army* 255 58
 muzzle *Sports* 305 71
 mycelium 68 4; 381 2
 myrtle 53 11
 Myrtus 53 11
 N
 Na atom 1 8
 nacre 357 34
 nadir 4 13
 naiad 327 23
 nail 19 80
 nail, clenched ~ 285 52
 nail, galvanized ~ 122 74
 nail, riveted ~ 285 52
 nail, wire ~ 121 95; 122 74;
 143 51
 nail, wooden ~ 121 92
 nail bag 122 72
 nail claw 120 75
 nail grip 100 56
 nail polish 99 32
 nail puller 100 47
 nail punch 134 32
 nail varnish 99 32
 naked boys 379 3
 naked lady 379 3
 name plate 118 47; 285 46
 Nansen sledge 303 18
 nape of the neck 16 21
 napkin 45 9; 266 47; 267 48
 napkin ring 45 10
 nappy, disposable ~ 28 22
 narcissus 53 8; 60 3
 narghile 107 42
 narghileh 107 42
 narrow-gauge diesel
 locomotive 200 24
 narrow-gauge track system
 159 4
 nasicorn 366 25
 nasturtium 53 4
 natural 320 45, 46, 54
 natural-gas engine 155 5
 naturalist 281 16
 naum keag 100 7
 nave 334 62; 335 1
 navel 16 34
 navette 36 55
 navigating bridge 223 14; 228
 22, 23, 24
 navigating officer 224 37
 navigation 224
 navigational marks, floating
 ~ 224 68-108
 navigational television
 receiver mast 221 37
 navigation equipment 288 13
 navigation light *Air Force* 257
 36
 navigation light *Warships* 258
 56

navigation light *Airsports* 288
 31
 navigation light, left ~ 230 50
 navigation light, right ~ 230
 44
 navigation light, side ~ 258 15
 navigation light indicator
 panel 224 29
 navigation lights 286 10-14
 navy 118 76
 navy 258
 navy plug 107 25
 navy yard 222 1-43
 Neanderthal man 261 19
 neck *Man* 16 19-21
 neck *Horse* 72 12, 15
 neck *Game* 88 3
 neck *Meat* 95 6, 20
 neck *Mach. Parts etc.* 143 64
 neck *Weaves* 171 33
 neck *Rowing* 283 37
 neck *Airsports* 288 70
 neck *Music. Instr.* 324 7, 18
 neck, cylindrical ~ 328 40
 neck, ground glass ~ 350 37
 neckband 36 16
 neck brush 106 27
 neckerchief 31 57
 neck flap *Fencing* 294 14
 neck guard *Fencing* 294 14
 neck guard *Chivalry* 329 83
 neck interlocking point 171
 35
 necklace 36 2; 328 25; 352
 14
 necklace, coral ~ 36 34
 necklace, cultured pearl ~ 36
 12
 necklace, ivory ~ 36 28
 necklace, pearl ~ 36 32
 neckline *Ladies' Wear* 30 34
 neck line *Airsports* 288 71
 neck of violin 323 2
 neck piece 329 83
 neck ring, gold ~ 328 26
 neck strap 71 30
 necktie 319 38
 nectary 59 18
 needle *Mach. Parts etc.* 143
 76
 needle *Drawing Off.* 151 56
 needle *Conifers* 372 11
 needle, hypodermic ~ 22 65;
 24 54
 needle, right-angle ~ 151 67
 needle, surgical ~ 22 57
 needle, tapered ~ 190 51
 needle bar 167 28
 needle bed 167 51, 55
 needle butt 167 60
 needle cage 143 75
 needle cam 167 14
 needle cylinder *Knitting* 167
 8, 11
 needle cylinder *Bookbind.*
 185 21
 needed part of the cylinder
 163 70
 needle file 108 22
 needle head 309 33
 needle holder 22 59

needle holder, cylindrical ~ 167 8, 11
 needle hook 167 64
 needle-matching system 114 29
 needlepoint 102 30
 needle point attachment 151 54
 needlepoint lace 102 30
 needle-raising cam 167 59
 needle roller bearing 143 75-76
 needles in parallel rows 167 53
 needle trick 167 15
 needlework 102
 negative carrier 116 30
 negative flight 288 9
 negligée 355 66
 negress 354 22
 negro 354 13
 negro hut 354 21
 nematode 80 51
 Neolithic period 328 10-20
 neon sign 268 16
 Neptune 4 51
 Nereid 327 23
 nerve 370 30
 nerve, auditory ~ 17 64
 nerve, femoral ~ 18 31
 nerve, optic ~ *Man* 19 51
 nerve, optic ~ *Bees* 77 23, 24
 nerve, peroneal ~ 18 33
 nerve, radial ~ 18 28
 nerve, sciatic ~ 18 30
 nerve, thoracic ~ 18 26
 nerve, tibial ~ 18 32
 nerve, ulnar ~ 18 29
 nerves 19 33
 nervous system 18 22-33
 nervure *Articulates* 358 34
 nervure *Bot.* 370 29
 nest 359 28
 nesting cavity 359 29
 Net *Astron.* 3 48
 net *Hunt.* 86 27
 net *Sea Fish.* 90 8
 net *Airsports* 288 74
 net *Ball Games* 293 13
 net background 102 16
 net-cord judge 293 23
 net curtain 42 35; 44 14
 net fabric 167 29
 net post 293 15
 net sonar cable 90 14
 net sonar device 90 17
 net stocking 306 10
 net strap 293 14
 netting 102 22
 netting, wire ~ 339 35
 netting loop 102 23
 netting needle 102 26
 netting thread 102 24
 nettle 61 33
 net vault 336 45
 network 288 74
 neume 320 1
 neuropteran 358 12
 neutral conductor 127 13
 neutral corner 299 38
 neutral point 153 22

neutron 1 30, 39, 45, 52, 53
 neutron bombardment 1 36, 50
 nevè 12 48
 new-born baby 28 5
 newel 123 43
 newel, open ~ 123 76
 newel, solid ~ 123 77, 78
 newel post 123 43
 Newfoundland dog 70 34
 new penny 252 37
 news, miscellaneous ~ 342 63
 newscaster 238 21
 news dealer 205 17; 268 75
 news in brief 342 63
 news item 342 50
 newspaper 182 31; 205 51; 265 25; 342 37-70
 newspaper, folded ~ 181 56
 newspaper delivery unit 182 29
 newspaper heading 342 39
 newspaper holder 265 26
 newspaper page 342 37
 newspaper rack 265 8
 newspaper shelf 262 16; 265 8
 newspaper typesetting 176 29
 newsreader 238 21
 newsreel camera 313 26
 New Stone Age 328 10-20
 news trolley 205 16
 news vendor 205 17; 268 75
 New World opossum 366 2
 nib 122 51
 nib size 151 40
 niche 331 60
 nick 175 47
 nigger 310 51
 night-care cream 99 27
 nightclub 318 1-33
 nightdress 32 16
 nightgown 32 16
 nightie 32 16
 nightingale 361 14
 nightshirt 32 37
 night spot 318 1-33
 nightwear 32
 nightwear, ladies' ~ 32 16-21
 nightwear, men's ~ 32 35-37
 Nile crocodile 356 13
 nimbostratus 8 10
 nine-eight time 320 39
 nine-four time 320 40
 nine men's morris 276 18, 23-25
 nine men's morris board 276 23
 nipper, bottom ~ 163 65
 nipper, top ~ 163 66
 nippers 100 40, 41
 nipping press 183 20
 nipple 16 28
 nipple key 126 63
 nitrogen tetroxide tank 234 59
 nitrous oxide 26 3
 nix 327 23
 nixie 327 23
 nobleman 355 44
 nock 305 63
 node 68 7

node, lymph ~ 19 10
 nodosity 80 27
 nogging piece 120 55
 noir 275 21
 nominal par 251 12
 non-belayer 300 27
 nonpareil 175 23
 non-printing area 340 56
 noodle 98 34; 99 65
 Norfolk Island pine 53 16
 North America 14 12
 North Atlantic Drift 14 30
 North Equatorial Current 14 32
 Northern Cross 3 23
 Northern Crown 3 31
 northern gannet 359 9
 northern pike 364 16
 north light 121 21
 north point 4 16
 North Pole 14 3
 North Sea 14 26
 North Star 3 1, 34
 Norton tumbler gear 149 8
 nose *Man* 16 10
 nose *Dog* 70 4
 nose *Horse* 72 6
 nose *Fish etc.* 364 2
 nose, false ~ 306 46
 noseband 71 7
 nose cone, carbon fibre reinforced ~ 235 20
 nose gear flap 231 24
 nose landing gear unit, retractable ~ 231 23
 nose piece, revolving ~ 112 11, 30
 nose rib 287 36
 nose undercarriage flap 231 24
 nose undercarriage unit, retractable ~ 231 23
 nose wheel 288 34
 nose wheel, forward-retracting ~ 257 3
 nose wheel, hydraulically steerable ~ 235 30
 nose wheel, steerable ~ 230 40
 nosing 123 20
 nostril 72 7
 notation, mensural ~ 320 2
 notation, square ~ 320 1
 notch *Phys. Geog.* 13 30
 notch *Forestry* 84 28
 notch *Hunt.* 87 66, 70
 notch *Army* 255 22
 notch, wedge-shaped ~ 54 38
 note, marginal ~ 185 68
 note, musical ~ 320 3-7
 notebook 47 24; 260 18
 note head 320 3
 notepaper 245 12
 notes 252 29-39
 notes, medieval ~ 320 1-2
 note stem 320 4
 note tail 320 4
 note values 320 12-19
 'NOT GO' gauging member 149 58
 'NOT GO' side 149 61
 notice 356 7

notice board 204 12
 nougat 98 81
 novillero 319 2
 nozzle *Moon L.* 6 3
 nozzle *Household* 50 67
 nozzle *Overh. Irrign.* 67 33
 nut, hexagonal ~ 143 18
 nozzle *Serv. Stat.* 196 3
 nozzle *Aircraft* 232 39, 45, 49, 55
 nozzle *Space* 234 35; 235 37
 nozzle, pistol-type ~ 83 28
 nozzle, revolving ~ 56 44
 nozzle, swivelling ~ 235 64
 nozzle fuel tank 235 45
 nuclear energy 154
 nuclear power plant 154 19
 nuclear reactor casing 259 67
 nuclear research ship 221 9
 nucleus 1 43
 nucleus, atomic ~ 1 2, 16, 29, 35, 49, 51
 nude 338 32
 nudist 281 16
 nudist sunbathing area 281 15
 null hyperbola 224 42
 number *Equest.* 289 33, 36
 number *Cyc. Racing* 290 28
 number *Winter Sp.* 301 37
 number *Sports* 305 84
 number, abstract ~ 344 3
 number, cardinal ~ 344 5
 number, complex ~ 344 14
 number, concrete ~ 344 4
 number, even ~ 344 11
 number, four-figure ~ 344 3
 number, mixed ~ 344 10
 number, negative ~ 344 8
 number, odd ~ 344 12
 number, ordinal ~ 344 6
 number, positive ~ 344 7
 number, prime ~ 344 13
 number, whole ~ 344 10, 18
 number disc 189 18
 number key *Office* 247 18
 number key *Store* 271 3
 number key *Flea Market* 309 76
 'number one' 283 13
 number plate 189 8; 290 28; 305 84
 numbers 344 1-22
 number sign 197 21
 number tab 267 10
 number tag 267 10
 numeral, Arabic ~ 344 2
 numeral, Roman ~ 344 1
 numeral pendants 253 33-34
 numeral pennants 253 33-34
 numerator 344 15
 nun 331 50
 nun moth 82 17
 nursery 47
 nursery child 48 2
 nursery education 48 1-20
 nursery gardener 55 20
 nursery hand 55 45, 46
 nursery sapling 83 15
 nursery teacher 48 1
 nut *Bldg.* 119 75
 nut *Mus. Instr.* 323 13, 20

nut *Bot.* 370 98
 nut *Industr. Plants* 383 44
 nut *South. Fruits* 384 52, 58, 60
 nut, castellated ~ 143 24, 77
 nut, castle ~ 143 24
 nut, hexagonal ~ 143 18
 nut, round ~ 143 35
 nutation 4 24
 nutcracker 361 1
 nutcrackers 45 49
 nuthatch 361 11
 nutmeg 382 34, 35
 nutmeg tree 382 30
 nuts 59 59, 37-51
 Nydam boat 218 1-6
 nylon 101 4
 nylon 6 fibres 170 1-62
 nylons 99 26
 nylon-thread cop 133 4
 nymph, artificial ~ 89 66

O

oak 51 12
 oak apple 82 34
 oak gall 82 34
 oak-gall wasp 82 33
 oak tree 51 12; 371 1
 oar 218 5; 278 19; 283 14, 26, 35-38
 oarlock 278 18; 283 29, 41
 oarsman 218 3; 283 12
 oasis 354 4
 oat-grass 69 22
 oat panicle 68 27
 oats 68 1
 oats, rolled ~ 98 37
 obelisk 333 10
 Oberwerk 326 2, 44
 obi 353 41
 object ball, red ~ 277 12
 objective, interchangeable ~ 112 62
 objective aperture 113 35
 objective lens 113 36
 objective turret 112 11, 30
 object lens 114 26; 313 2
 object stage 112 9
 oblique, external ~ 18 43
 obliquus externus abdominis 18 43
 oboe 323 38
 O'Brien technique 298 50
 observation opening 5 13
 observation port *Agr. Mach.* 64 27
 observation port *Films* 312 15
 observation room 5 33
 observation shaft 5 30
 observation telescope 351 31
 observation window 25 8
 observation window, forward ~ 235 25
 observation window, upward ~ 235 24
 observatory 5 1-16; 9 7
 observatory, solar ~ 5 29-33
 observatory dome 5 12
 obstacle, almost-fixed ~ 289 8

obstacle, fixed ~ 289 20
 obstruction 291 51
 obverse 252 8
 ocarina 324 32
 occipitalis 18 50; 19 2
 occipito frontalis 19 4
 occiput 16 2
 occlusion 9 25
 ocean *Phys. Geog.* 13 26
 ocean *Map* 14 19-26
 ocean current, cold ~ 14 27
 ocean current, warm ~ 14 28
 ocean currents 14 30-45
 ocean drifts 14 30-45
 Oceanid 327 23
 ocean liner 221 82; 225 32
 ocean nymph 327 23
 ocean station vessel 9 7
 ocellus *Dom. Anim.* 73 32
 ocellus *Bees* 77 2
 octagon 351 17
 octahedron 351 6, 14, 16
 Octans 3 43
 Octant 3 43
 octave, five-line ~ 321 50
 octave, four-line ~ 321 49
 octave, great ~ 321 44
 octave, one-line ~ 321 46
 octave, small ~ 321 45
 octave, three-line ~ 321 48
 octave, two-line ~ 321 47
 octave engagement 294 50
 odalisque 306 41
 odd-pinnate 370 42
 odds 289 37
 odds-and-ends box 195 31
 Oertz rudder 222 69-70
 oesophagus *Man* 17 49; 20 23, 40
 oesophagus *Bees* 77 19
 offcut 120 96
 off-end framing 165 14
 offering 330 60
 offertory bag 330 59
 offertory box 330 55
 office *Coal* 144 18
 office *Railw.* 207 41
 office *Office* 245; 246; 247; 248; 249
 office *Camping* 278 1
 office *Chivalry* 329 27
 office, executive's ~ 246 1-36
 office, manager's ~ 271 24
 office, open plan ~ 248 1-48
 office, physician's ~ 22 1-74
 office, purser's ~ 223 45
 office, receptionist's ~ 245 1-33
 office, secretary's ~ 245 1-33
 office building *Coal* 144 18
 office building *Offshore Drill* 146 14
 office building *Docks* 225 53
 office building *Films* 310 4
 office calculator 245 31
 office chair 248 25
 office cupboard 248 12
 office equipment 247 1-44
 office furniture 248 39
 office intercom 245 20; 246 10
 office machinery 249

office materials 247 1-44
 officer in charge 270 36
 officer of the watch 221 126
 offices 205 13; 217 24; 310 4
 offices, administrative ~ 222
 1
 office supplies 247 1-44
 offset machine, four-colour ~
 180 30
 offset machine, rotary ~ 180
 1, 18
 offset machine, sheet-fed ~
 180 30
 offset machine, single-colour
 ~ 180 46, 59
 offset plate 179 1
 offset plate, coated ~ 179 16
 offset platemaking 179
 offset press *Paperm.* 173 21
 offset press *Office* 249 48
 offset press, four-colour ~
 180 1, 18, 30
 offset press, rotary ~ 180 1, 18
 offset press, sheet-fed ~ 180
 30, 70
 offset press, single-colour ~
 180 46, 59
 offset printing 180
 offshoot 370 21
 offshore drilling 146
 offshore drilling rig supply
 vessel 221 32
 offside 291 42
 off switch 10 15
 ogee arch 336 36
 ogee wing 229 22
 oil 98 24
 oil, crude ~ *Phys. Geog.* 12 31
 oil, crude ~ *Oil, Petr.* 145
 28-35, 36-64
 oil, mineral ~ 145
 oil, viscous ~ 84 35
 oil and vinegar bottle 45 42
 oil bag 228 11
 oil bath air cleaner *Agr.*
Mach. 65 54
 oil bath air cleaner *Railw.* 212
 79
 oil bath air filter *Agr. Mach.*
 65 54
 oil bath air filter *Railw.* 212
 79
 oil bleeder screw 190 24
 oil burner 38 58-60
 oil can 196 16
 oil-circulating pump *Power*
Plant 152 45
 oil-circulating pump *Railw.*
 211 12
 oil conservator 152 42; 153 9
 oil cooler *Power Plant* 152 46
 oil cooler *Car* 192 19
 oil cooler *Railw.* 211 11
 oil drain plug 190 24
 oil drilling 145 1-21
 oiler 109 4
 oil filler neck 190 28
 oil filter 190 43; 192 20
 oil-firing system 199 30, 35
 oil furnace 145 36
 oil gallery, main ~ 192 21

oil gauge *Roof & Boilerr.* 38
 54
 oil gauge *Power Plant* 153 11
 oil heating furnace 38 57
 oil level pipe 38 53
 oil paint 338 11
 oil palm 383 54
 oil pipe 190 13
 oil pipeline 145 65
 oil pressure gauge *Sawmill*
 157 7
 oil pressure gauge *Aircraft*
 230 20
 oil pressure limiting valve
 190 67
 oil pressure warning light 191
 73
 oil production 145 22-27
 oil products 145 52-64
 oil pump 190 42; 192 16
 oil pump drive 190 25
 oil refinery 145 65-74
 oil reservoir 64 29, 93
 oil rig 146 1-39
 oil scraper ring 190 37
 oilskins 228 4
 oil stand 109 5
 oilstone 340 21
 oil sump *Agr. Mach.* 65 45
 oil sump *Intern. Combust.*
Eng. 190 41
 oil sump *Car* 192 17
 oil tank *Roof & Boilerr.* 38 44
 oil tank *Agr. Mach.* 64 93
 oil tank *Oil, Petr.* 145 34
 oil tank *Motorcycle* 189 36
 oil temperature gauge *Car*
 191 38
 oil temperature gauge
Aircraft 230 21
 oil temperature sensor 195 16,
 40
 oil-to-air cooling unit 209 18
 ointment, tube of ~ 22 47
 O-Joller 284 50
 Old Stone Age 328 1-9
 old woman's tooth 132 26
 oleander 373 13
 olive oil 98 24
 olive tree 383 29
 omnibus, horse-drawn ~ 186
 37
 on-board equipment 239 6
 on-board telephone 239 13
 one-design keelboat 284 62
 one-half twist isander 282 41
 Oneirophanta 369 18
 one-second theodolite 112
 73
 one-two 291 49
 one-way tap 350 42
 on full point 314 19
 on guard line 294 3
 on guard position 294 18, 33
 onion 57 24
 onion skin 57 25
 on-line disc storage unit 176
 32
 on-load tap changer 153 13
 on/off switch *Railw.* 211 30
 on/off switch *Audio* 241 63

on/off switch *Audiovis.* 243
 16
 on/off switch *Office* 247 16;
 249 9, 37, 64
 on/off valve 279 22
 on-ramp 15 16
 on-the-ground wrestling 299
 8
 open gate 301 65
 open-hearth furnace 147
 21-30
 opening 122 24
 opening, pharyngeal ~ 19 24
 opening control 313 8
 open-newel staircase 123 76
 open-reel tape 241 58
 open vertical gate 301 67
 open work 102 27
 opera glass 315 9
 opera hat 35 36
 operating cabin 228 21
 operating handle 309 81
 operating indicator 244 11
 operating instructions 244 15
 operating key 243 13, 41, 48;
 246 19; 261 45
 operating lamp 27 25
 operating lamp, shadow-free
 ~ 26 10
 operating lamp, swivel-
 mounted ~ 26 10
 operating lever *Pest Contr.* 83
 21
 operating lever *Cinè Film* 117
 63
 operating lever *Road Constr.*
 201 12
 operating mechanism
 housing 153 60
 operating table 26 8, 36
 operating table, pedestal ~ 26
 5
 operating theatre 26 1-33
 operating valve 153 52
 operation indicator 244 7
 operations, arithmetical ~ 344
 23-26; 345 1-10
 operator *Post* 237 35
 operator *Computer* 244 14
 operator *Theatre* 316 59
 operator, chief ~ 244 3
 operator's position 237 34
 operator's set 237 23
 operculum 364 5
 ophthalmic test stand 111 43
 ophthalmometer 111 44
 ophthalmoscope 22 62
 opium poppy 380 15
 opponent 293 18
 optical bench 114 50; 242 79
 optical instruments 112; 113
 optical sound recorder 310
 60; 311 6
 optical sound recording 311 9
 optical sound recording
 equipment 311 6
 optical sound unit 312 45
 optical system 242 41; 243 50
 optician 111 1
 optic plate, right-hand ~ 195
 18

optometer 111 44
 or 254 24
 orange *Colour* 343 7
 orange *South. Fruits* 384 23,
 27
 orange flower 384 25
 orange peel, candied ~ 98 11
 orangery 272 3
 orange tip butterfly 365 3
 orange tree 55 49
 orang-utan 368 15
 orang-utan 368 15
 orbicular 370 33
 orbicularis oculi 19 5
 orbicularis oris 19 8
 orbiculate 370 33
 orbit, moon's ~ 4 1
 orbital manoeuvring main
 engine 235 44
 orb spinner 358 45
 orchard 15 108
 orchard sprayer, mobile ~ 83
 38
 orchestra *Theatre* 315 25
 orchestra *Art* 334 47
 orchestra pit 315 24
 orchestrion 308 38; 309 14
 orchid 376 28
 orchis 376 28
 ordinal 344 10
 ordinate 347 10
 ord 147 2
 ore 252 24, 25, 26
 ore deposit 11 31
 organ 326 1-5, 1-52
 organ, automatic ~ 308 38
 organ, portable ~ 322 56
 organ, portable ~ 322 56
 organ, positive ~ 322 56
 organ, suctorial ~ 81 36
 organ case 326 1-5
 organ console 326 36-52
 organelle 357 5
 organistrum 322 25
 organ of equilibrium and
 hearing 17 56-65
 organ pipes 326 17-35
 organs, internal ~ 20 1-57
 orifice, cardiac ~ 20 41
 original 177 18
 origin of ordinates 347 4
 Orion 3 13
 ornament, Rococo ~ 336 13
 ornamental 53 16
 ornamentation, Greek ~ 334
 38-43
 ornamentation, Romanesque
 ~ 335 14-16
 ornaments 321 14-22
 orogeny 12 4-20
 orogeny 12 4-20
 orographic lift 287 28
 orpine 377 9
 orthopinacid 351 25
 orthopteron 358 8
 ortolan 361 7
 ortolan bunting 361 7
 Orton cone 161 6
 oscillation counter 110 17
 osier branch 371 29
 osier rod 136 15

osier stake 136 14
 ossicles, auditory ~ 17 61
 Ostiak 353 17
 ostrich 359 2
 ostrich egg 359 3
 ostrich feather 254 30
 Ostyak 353 17
 os uteri externum 20 85
 otter 367 17
 otter boards 90 13
 Otto-cycle engine 190 1
 Otto-cycle internal
 combustion engine 190 2
 outboard 278 15; 283 6, 7
 outboard inflatable 286 1
 outboard motor 278 15; 283
 7; 286 1, 21
 outboard motorboat 283 6
 outboard speedboat 283 6
 outdrive motorboat 286 2
 outer case 187 30
 outfall 216 36
 outfielder 292 41
 outflow condenser 92 4
 outhouse 62 14
 outlet *Electr.* 127 5
 outlet *Paperm.* 172 78
 outlet *Water* 269 21
 outlet, double ~ 127 6
 outlet cock 178 34
 outlet control valve 269 30
 outlet duct 92 19
 outlet structure 217 44
 outlet to brake line 192 53
 outlet tunnel 217 62
 outlet valve 269 31
 outline drawing 129 46
 output 117 28
 output gear box 212 53
 outrigger *Rowing* 283 42
 outrigger *Ethnol.* 352 36
 outrigger canoe 352 35
 outside broadcast vehicle 239
 1-15
 outside defender 291 13
 outside forward 291 16
 outside grip 296 45
 outsider 289 53
 ovary *Man* 20 83
 ovary *Soft Fruit* 58 40
 ovary *Bot.* 370 54, 60
 ovary *Shrubs etc.* 373 2, 5
 ovary *Flowers etc.* 375 34
 ovary, epigynous ~ 58 7
 ovary, perigynous ~ 59 14
 ovary cavity 370 62
 ovary wall 370 61
 ovate 370 36
 oven 39 13; 97 66, 71
 oven, electric ~ 207 30
 oven window 39 14
 overall 33 56
 overalls, hairdresser's ~ 106 2
 overalls, leather ~ 290 26
 over-and-under shotgun 305
 70
 overblouse 31 61
 overblouse, girl's ~ 29 48
 overburden 158 2
 overburden excavator 159 3
 overdress 31 17

overfall 91 43
 overfeed, initial ~ 168 26
 overflow *Roof & Boilerr.* 38
 69
 overflow *Bathrm. etc.* 49 25,
 45
 overflow *Fish Farm.* 89 5
 overflow *Water* 269 33
 overflow basin 272 23
 overflow container 350 60
 overflow pipe 38 69; 269 20,
 33
 overflow spillway 217 60
 overfold 12 14
 overgown 355 36, 50
 overgrasp 296 40
 overhead bicycle kick 291 45
 overhead camshaft 189 3;
 190 14
 overhead contact wire 197
 41; 205 58
 overhead line support 152 36
 overhead projector 261 8
 overhead spray washing plant
 169 29
 overhead wire maintenance
 vehicle 211 41
 overhead wire voltage
 indicator 211 28
 overlap angle 128 51
 overlay flooring 123 62
 overload indicator 224 33
 oversite concrete 123 13
 overskirt, panniered ~ 355 83
 over tile 122 58
 overtop 29 48
 overtop, knitted ~ 30 4, 31 65
 oviduct 20 81
 ovule 58 39; 59 14; 370 63
 ovum 20 84
 owl 252 2
 owl-glass 306 38
 owls 362 14-19
 ox *Dom. Anim.* 73 1
 ox *Slaughterho.* 94 2
 ox *Meat* 95 14-37
 oxeer 289 8
 ox eye 361 9
 oxeye daisy 376 4
 oxeye daisy, white ~ 51 24
 Oxford 101 31
 Oxford shoe 101 31
 ox hide, painted ~ 354 11
 oxidation 170 19
 oxidation, controlled ~ 169 7
 oxide ceramic 149 46
 oxteam 63 16
 oxygen apparatus *Moon L.* 6
 18
 oxygen apparatus *Fire Brig.*
 270 20
 oxygen atom 1 13
 oxygen-blowing converter
 147 45-50
 oxygen connection 141 30
 oxygen control 141 29
 oxygen cylinder *Hosp.* 27 45
 oxygen cylinder *Gas Weld.*
 141 3, 21
 oxygen cylinder *Road Constr.*
 200 40

oxygen flow meter **26** 4
oxygen hose **141** 10
oxygen inlet **350** 11
oxygen jet **350** 13
oxygen lance **147** 49
oxygen molecule **242** 65
oxygen supply **25** 22
oxygen tank *Moon L.* **6** 6
oxygen tank *Space* **234** 61
oxygen tank *Air Force* **257** 2
oxygen treatment **25** 23
oxymeter **27** 13
oxysphere **11** 1
oyster **357** 32
oyster fork **45** 80
oyster round **95** 11
ozone layer **7** 13, 19

P

pace **72** 40
pacemaker **25** 36
pacemaker, cardiac ~ **25** 31, 37
pacemaker, internal ~ **25** 37
pacemaker, short-term ~ **25** 25
pacemaker battery **25** 51
pacemaker control unit **25** 40
pacemaker impulse **25** 44
pacemaker unit **25** 30
pacer **290** 11
Pacific Ocean **14** 19
pack *Dom. Anim.* **73** 5
pack *Hunt* **86** 33
pack *Airsports* **288** 44
pack, disposable ~ **93** 28
package, unitized ~ **226** 21
package cargo transit shed **225** 9
package freight **206** 4, 27
pack animal **354** 3
packing, sterile ~ **26** 31
packing box **210** 33
packing box dispenser **74** 53
packing machine **76** 36
pack of hounds **86** 33; **289** 46
pack saddle **73** 4
pad *Horse* **71** 49
pad *Game* **88** 46
pad *Shoem.* **100** 16
pad *Ball Games* **292** 9
pad *Graphic Art* **340** 13
pad, bakelite ~ **166** 64
pad, leather ~ *Goldsm. etc.* **108** 29
pad, leather ~ *Weaving* **166** 64
pad, suctorial ~ **77** 9
pad, unsterile ~ **26** 23
pad bridge **111** 12
padding, foam rubber ~ **291** 20
paddle *Brew.* **92** 46
paddle *Electrotyp. etc.* **178** 25, 33
paddle *Ship* **218** 8
paddle *Ethnol.* **353** 14
paddle, double-bladed ~ **283** 39

paddle, double-ended ~ **283** 39
paddle, single-bladed ~ **283** 34
paddle boat **280** 12
paddling pool **37** 44; **273** 28
paddock **319** 15
padlock **38** 21
page *Bookbind.* **185** 53
page *Hotel* **267** 18
page, double-column ~ **185** 64
page, front ~ **342** 38
pageboy **267** 18
pageboy style **34** 35
page cord **174** 16
page heading **342** 52
page number **185** 63; **251** 14
page printer **237** 66
pagoda, Indian ~ **337** 21
pagoda, multi-storey ~ **337** 1
pail **50** 54
pailoo **337** 3
pailou **337** 3
paint **129** 6, 7-8, 9; **338** 10
paintbox **48** 6; **338** 10
paintbrush **48** 7; **129** 3; **260** 84
paint bucket **129** 10
paint container **315** 34
Painter *Astron.* **3** 47
painter *Painter* **129** 2
painter *Art. Studio* **338** 2
painting **129** 1; **260** 27
painting, watercolour ~ **48** 5
painting materials **338** 6-19
painting surface **338** 22
painting table **338** 25
paint kettle **129** 8
paint roller **129** 11
paint room **315** 28-42
paint scraper **129** 22
paint trolley **315** 36
pair **275** 20
pairing season **86** 9-12
pair skater **302** 4
pajamas **32** 17, 36
palace, Baroque ~ **272** 7
palace, Renaissance ~ **335** 47
palace buildings **333** 29
palace gardens **272** 1-40
Palaeolithic period **328** 1-9
Palaeopneustes niasicus **369** 19
palate, hard ~ **19** 20
palate, soft ~ **19** 21
pale ale **93** 26
palette **338** 28
palette dipper **338** 29
palette knife **338** 14
paling **52** 10
palisade *Equest.* **289** 8
palisade *Chivalry* **329** 36
palisading **329** 36
palla **355** 10
pallbearer **331** 40
pallet *Porcelain Manuf.* **161** 20
pallet *Station* **206** 32
pallet *Docks* **225** 43; **226** 7
pallet *Music. Instr.* **326** 10

pallet, flat ~ **226** 10
pallet, standard ~ **226** 10
palette **329** 45
palm **88** 41
Palma Christi **380** 14
palma manus **19** 71
palmate **370** 39
palmation **73** 36; **359** 7
palm capital **333** 25
palm column **333** 17
palmette **334** 41
palm frond **384** 3
palm of the hand **19** 71
palm rest **255** 13, 19; **305** 45
palm tree **354** 5
palpebra, lower ~ **19** 40
palpebra, upper ~ **19** 39
pampas grass **51** 8
pamphlet **330** 57
pan *Household* **50** 52
pan *Carp.* **120** 59
pan *School* **260** 60
panache **329** 78
Panama hat **35** 16
pan and tilt head **114** 48; **313** 12
pancreas **20** 44
Pandean pipes **322** 2
pandora **322** 21
pane **66** 10; **137** 27
panel **120** 59
panel, front ~ **32** 24
panel, mirrored ~ **267** 66
panelboard **157** 67
panelling, metal ~ **208** 6
panelling, wood ~ **281** 19, **266** 37
panel pin **124** 29
pane of glass **124** 16
pangolin **366** 10
pan grinding mill **159** 8
Panhard rod **192** 70
panicle **68** 27; **370** 69; **378** 44, **382** 54
pan loaf **97** 10
pannier **78** 15
panpipes **322** 2
pan set **40** 12-16
pansy **60** 2
pantaleon **325** 1
pantaloon **306** 42
pantie briefs **32** 8
pantie-corsette **32** 3
pantie-girdle **32** 2
pantie-hose **32** 12
panties, long-legged ~ **32** 10
pantile **122** 54
pantograph *Map* **14** 65
pantograph *Composing Rm.* **175** 58
pantograph *Tram* **197** 23
pantograph carriage **175** 53
pantry, ship's ~ **223** 43
pants, long ~ **32** 11
paper *Photog.* **116** 50
paper *Drawing Off.* **151** 14
paper *Paperm.* **173** 2-10
paper *Offset Print.* **180** 47
paper *Letterpress* **181** 46
paper *Office* **249** 57
paper, asphalted ~ **153** 48

paper, blank ~ **180** 2, 69; **181** 23, 30
paper, coated ~ **173** 35
paper, cork ~ **128** 18
paper, metallic ~ *Paperhanger* **128** 18
paper, metallic ~ *Power Plant* **153** 44
paper, metallized ~ **153** 44
paper, natural ~ **128** 18
paper, printed ~ **180** 57; **181** 9, 25
paper, raw ~ **173** 29
paper, unprinted ~ **180** 2, 69; **181** 23, 30
paper, wood ~ **128** 18
paper bag, cone-shaped ~ **98** 49
paper bail **249** 17
paper chase **289** 41-49
paper clip **247** 1, 2
paper edge, butted ~ **128** 20
paper feed **245** 11; **249** 45, 49
paper feed and delivery **181** 14
paper feeding and delivery unit **181** 14
paperhanger **128**
paperhanging **128** 18-53
paperhanging brush **128** 40
paperhanging kit **128** 33
paper hunt **289** 41-49
paper machine **173** 11, 13-28
papermaking **172**; **173**
papermaking by hand **173** 48-51
paper punch **22** 28
paper recorder **25** 56, 57
paper recorder unit **27** 33
paper reed **383** 64
paper release lever **249** 20
paper ribbon **174** 34
paper roll **249** 33; **309** 75
paper roller **128** 47
paper rush **383** 64
paper size selection **249** 34
paper speed scale **116** 54
paper stand **151** 13
paper tape **237** 32
paper towel **196** 11
paper-towel dispenser **196** 10
paper tower **174** 33, 43
pappus **375** 34
pappus bristle **375** 33
pappus tuft **378** 11
paprika **57** 42
papyrus column **333** 15
papyrus plant **383** 64
par **251** 12
para **252** 28
parabola **347** 14
parachute *Meteorol. Instr.* **10** 57
parachute *Airsports* **288** 37
parachuting **288** 37-62
paraffin **145** 60
paraffin lamp **278** 29
paraffin oil **145** 60
paragon **175** 31
Paraguay tea **382** 11
parallel **346** 4

parallel bars **296** 2
parallelepiped **347** 36
parallel of latitude **14** 2
parallelograms **346** 33-36
parallels **14** 1-7
Paramecium **357** 9
parapet *Dwellings* **37** 19
parapet *Bridges* **215** 70
parapet *Chivalry* **329** 21
parapet, battlemented ~ **329** 20
parasites **81**
parasites of man **81** 31-42
parasol mushroom **381** 30
paravane **258** 87
parcel *Station* **204** 2
parcel *Post* **236** 3, 6
parcel registration card **236** 7
parcel registration slip **236** 4
parcels counter **236** 1
parcels office **204** 1
parcels scales **236** 2
parent **54** 15
parentheses **342** 24
parent plant **54** 15
paring knife **100** 51
parison **162** 47
parison mould **162** 26
park *Map* **15** 97
park *Park* **272**
park *Ball Games* **291** 1; **292** 40-58
park, landscaped ~ **272** 41-72
parka **29** 66
parka coat **29** 66
park bench **272** 16, 42
park by-law **272** 29
park chair **272** 48
park entrance **272** 32
park gardener **272** 66
parking meter **268** 1
park keeper **272** 30
park path **272** 38
park railing **272** 33
parlour, herringbone ~ **75** 23
parquet floor **123** 74
parquet strip **123** 62
parrot **363** 1
parrying **294** 6
parry of the fifth **294** 24
parry of the quinte **294** 24
parry of the tierce **294** 8
parsley **57** 19
parsonage **331** 20
part, imaginary ~ **344** 14
part, real ~ **344** 14
parterre **272** 39
Parthenon **334** 1
partial-hip end **121** 17
parting, centre ~ **34** 9
parting, side ~ **34** 14
parting kiss **205** 52
parting-off tool **149** 53
parting tool *Turner* **135** 24
parting tool *Mach. Tools* **149** 53
partition **75** 38
partition, framed ~ **120** 48
partition, glass ~ **25** 8
partition, sound-absorbing ~ **248** 20

partition, wooden ~ **38** 19
partition screen **248** 1
partition wall *Bldg. Site* **119** 25
partition wall *Office* **248** 1
part load **206** 4
part-load goods **206** 27
partridge **88** 70
partridge call **87** 47
party **263** 20
party, private ~ **267** 40-43
party blouse **30** 55
party games **276**
party skirt **30** 56
par value **251** 12
Paschen series **1** 22
pas de (rois) **314** 27-28
Pasiphaea **369** 12
pass *Phys. Geog.* **12** 47
pass *Ball Games* **291** 47
pass, short ~ **291** 49
passage **71** 3
passage, barred ~ **307** 51
passage grave **328** 16
passe **275** 19
passenger **204** 24; **205** 6; **208** 30; **221** 97, 109
passenger aircraft **231** 2
passenger cabin **231** 22
passenger car **208** 3
passenger coach **207** 1-21; **208** 3
passenger compartment **207** 13
passenger door, centre ~ **231** 25
passenger door, rear ~ **231** 30
passenger ferry **216** 1
passenger liner **221** 82; **225** 32
passenger loading bridge **233** 14
passenger seat *Car* **191** 36
passenger seat *Lorries etc.* **194** 14
passenger seat *Aircraft* **230** 38; **231** 22
passenger sledge **353** 18
passenger terminal **225** 31
passenger vehicle **191** 1-56; **195** 34
passerines **361**
Passiflora **53** 2
passion flower **53** 2
passport **267** 13
'passport check' **233** 42
pastas **98** 32-34
paste **128** 26
paste, heavy-duty ~ **128** 24
pasteboard **128** 31
paste brush **128** 27
pastel crayon **338** 19
pastern **72** 25
pasting machine **128** 25
pastor *Church* **330** 22
pastor *Birds* **361** 4
pastry whirl **97** 38
pasture, rough ~ **15** 5
patch pocket **29** 68; **30** 22; **31** 56; **33** 38; **35** 37
pâté **96** 15

patella 17 23
 paten 330 9; 332 51
 patent 246 26
 patent anchor 222 78; 258 5; 286 17
 patent key 187 50
 patent log 224 54
 patent valve 187 31
 paternoster 332 31
 path, central ~ 55 42
 path, gravel ~ 272 18
 path, unfenced ~ 15 102
 patient 22 2, 3; 24 2; 274 7, 18
 patients file 22 6
 patin 330 9; 332 51
 patine 330 9; 332 51
 patrician lady 355 48
 patrol car 264 10
 patrolman 264 13
 patrol submarine 259 75
 patten 355 43
 pattern *Iron Foundry etc.* 148 34
 pattern *Composing Rm.* 175 55
 pattern, chequered ~ 335 14
 pattern control chain 167 19
 pattern repeat 171 12
 pattern stencil 168 62
 pattern table 175 56
 pauldron 329 45
 Pauli exclusion principle 1 7
 Pauli principle 1 7
 pause 321 25
 pause sign 321 25
 pavais 329 56
 pavement 37 60; 198 8, 9
 paving 198 8
 paving, brick ~ 123 7
 paving, flagstone ~ 123 26
 paving brick 159 27
 pavis 329 56
 Pavo 3 41
 paw 88 46, 50; 368 4
 paw, hind ~ 70 8
 pawn 276 13
 payee 250 19
 payer 250 20
 paying agent 250 22
 paying-in counter 236 25
 paying-in slip 236 27
 payload bay 235 26
 payload bay door 235 14
 payload bay insulation 235 13
 payload manipulator arm 235 29
 pay phone 236 9; 237 3
 pea 57 1, 7
 peach 59 31
 peach blossom 59 27
 peach flan 97 22
 peach flower 59 27
 peach leaf 59 32
 peach tree 59 26-32
 Peacock *Astron.* 3 41
 peacock *Dom. Anim.* 73 30
 peacock butterfly 365 2
 pea flower 57 2
 pea jacket 221 127
 peak 11 6; 12 40
 peanut 45 41; 383 41

pear 58 33
 pear blossom 58 38
 pearl *Jewell.* 36 8
 pearl *Game* 88 30
 pearl *Composing Rm.* 175 22
 pearl *Invertebr.* 357 35
 pearl barley 98 35
 pear pip 58 37
 pears 99 87
 pear-shape, faceted ~ 36 84
 pear-shape, plain ~ 36 83
 pear-shape, standard ~ 36 54
 pear-shapes 36 82-86
 pear stalk 58 34
 pear tree 58 31, 32
 peasecod 355 30
 peat 55 31; 206 10
 pea tendril 57 4
 peavy 85 9
 peba 366 8
 pebble, painted ~ 328 6
 pectoralis, greater ~ 18 36
 pectoralis major 18 36
 pedal *Joiner* 132 72
 pedal *Bicycle* 187 40, 78
 pedal *Sports* 305 85
 pedal *Music. Instr.* 323 62; 325 41, 46
 pedal, adjustable ~ 298 2
 pedal, left ~ 325 9
 pedal, right ~ 325 8
 pedal bracket 325 42
 pedal car 273 55
 pedal crank 188 25
 pedal cylinder 163 27
 pedal drive 188 25
 pedal frame 187 83
 pedal harp 323 60
 pedal key 326 51, 52
 pedal lever 163 28
 pedal mechanism 324 54
 pedal pipe 326 3
 pedal roller 163 27, 28
 pedal tower 326 4
 peddle boat 280 12
 pedestal *Optic. Instr.* 113 2
 pedestal *Office* 248 37
 pedestal *Park* 272 11
 pedestal *Circus* 307 55
 pedestal crane 146 3
 pedestal grinding machine 138 7
 pedestal mat 49 18
 pedestrian 268 18
 pedestrian crossing 198 11; 268 24, 51
 'pedestrian crossing' sign 268 29
 pedestrian lights 268 55
 pedestrian precinct 268 58
 pedicel 59 4; 383 7
 pediculate 369 6
 pediment *Phys. Geog.* 13 65
 pediment *Art* 334 3; 335 36
 peduncle 59 4; 383 7
 peeler 133 1
 peeling machine 133 1
 peen 66 10; 137 27
 peewit 359 21
 peg *Floor etc. Constr.* 123 11
 peg *Camping* 278 24

peg *Music. Instr.* 323 18; 324 11
 Pegasus *Astron.* 3 10
 Pegasus *Fabul. Creat.* 327 26
 pegbox 323 19
 pegbox, bent-back ~ 324 10
 pegbox, swan-head ~ 324 10
 pegdisc 324 19
 pein 137 27
 Pekinese dog 70 19
 Peking man 261 18
 pelargonium 53 1
 pelican 359 5
 pelican eel 369 2
 pellitone 323 44
 pelorus 224 53
 pelota 305 67
 pelota player 305 68
 pelvis 17 18-21
 pelvis, renal ~ 20 31
 pen *Livestock* 75 36
 pen *Office* 245 21
 pen *School* 260 14
 pen, ballpoint ~ 47 26
 pen, felt tip ~ 47 26; 48 18
 pen, metal ~ 341 25
 penalty 291 40
 penalty area 291 4
 penalty kick 291 40
 penalty line 292 5
 penalty spot 291 6
 pen and pencil case 260 12
 pen and pencil tray 245 22; 260 24
 pencil 47 26; 129 41; 260 5
 pencil, carpenter's ~ 120 77
 pencil, clutch-type ~ 151 45
 pencil, coloured ~ 48 11
 pencil, lead ~ 118 51
 pencil attachment 151 62
 pencil box 309 73
 pencil holder 22 31
 pencil lead 151 46
 pencil of rays 346 19
 pencil point attachment 151 55
 pencil sharpener 247 25
 pencil silhouette 31 14
 pen clip 2 18
 pendant 335 32
 pendant, gemstone ~ 36 14
 pendant, oblong ~ 253 28
 pendants 253 30-32
 pendeloque 36 54
 pendentive 334 74
 pendulum *Atom* 2 35
 pendulum 110 27; 309 58
 pendulum device 2 35
 pendulum spray 83 27
 penguin 359 4
 peninsula 13 5
 penis 20 66
 penlight pocket 6 24
 pen meter 2 15
 pennant, oblong ~ 253 28
 pennants 253 30-32
 pennon 278 9; 280 11
 pennon staff 280 10
 pensions counter 236 25
 Pentacrinus 369 3
 pentagon 351 9

pentaprism 115 41, 70
 pentaprism viewfinder, interchangeable ~ 115 69
 penthouse 37 83
 penthouse head 312 50
 penthouse roof 37 55
 pent roof 37 55, 78; 121 7
 penumbra 4 34
 peplos 355 2
 pepper 382 39
 peppercorn 382 39
 peppermint 380 3
 pepper plant 382 36
 pepper pot 266 77
 percentage focusing chart 177 7
 percentage key 247 23
 percentage sign 345 7
 percent key 247 23
 perch 86 49
 percolation of a river 13 73
 percussion cap *Hunt.* 87 59
 percussion cap *Carnival* 306 49
 percussion drill, electric ~ 134 43
 percussion instruments 323 49-59; 324 47-58
 percussion screwdriver 138 6
 Percussion 22 73
 peregrine falcon 362 2
 perennial 52 22
 perennial, flowering ~ 52 9
 perfect binder 184 1; 249 61
 perfect fifth 321 10
 perfect fourth 321 9
 perfecting unit 181 49
 perfecting unit for black 180 12-13
 perfecting unit for cyan 180 8-9
 perfecting unit for magenta 180 10-11
 perfecting unit for yellow 180 6-7
 perfect octave 321 13
 perforated brick 159 21
 perforation 236 62
 perforator *Paperhanger* 128 12
 perforator *Composing Rm.* 176 5
 perfume bottle 43 27; 105 36
 perfume spray 43 26; 106 21
 pergola 37 80; 51 1; 272 17
 pericarp 57 6
 pericementum 19 28
 perineum 20 64
 period 342 16
 periodical 262 15
 periodicals rack 262 15
 periodontium 19 28
 periphery 346 44
 peristomion 322 5
 peristyle 334 2
 peritoneum 20 58
 perlon fibres 170 1-62
 Permian 154 62
 peroneus longus 18 64
 perpendicular 346 6, 27, 28
 perpetual frost climate 9 58

Persian cat 73 17
 Persian lamb 30 60
 personnel carrier, armoured ~ 255 91
 Peru Current 14 42
 pesade 71 4; 307 30
 peseta 252 22
 pest control 83
 pestle 349 10
 petal 58 43; 59 11; 370 59
 petasus 355 4
 pet foods 99 36-37
 petiole 370 27
 petri dish 173 7; 261 25
 petrol can 196 25
 petrol canister 84 36
 petroleum *Phys. Geog.* 12 31
 petroleum *Oil, Petr.* 145 41
 petroleum gas, liquefied ~ 145 53
 petroleum reservoir 12 27
 petrol lighter 107 27
 petrol motor 83 41
 petrol pump 196 1
 petrol pump, self-service ~ 196 8
 petrol pump hose 196 2
 petrol station 196 1-29
 petrol tank 188 10, 28; 189 2; 305 87
 petticoat 355 37
 petty cash 246 27
 petty morel 379 5
 petunia 53 6
 pew 330 28
 pewit 359 21
 Pfund series 1 24
 phaeton 86 18; 186 38
 phalange 17 17, 29; 19 77
 phalanx 17 17; 19 77
 pharmacopoeia 22 23
 pharynx 19 24
 phases, lunar ~ 4 2-7
 pheasant 88 77
 pheasant cock 88 77
 pheasant hen 88 77
 pheasant's eye 60 4
 phenol 170 3, 14, 16
 phenol extraction 156 39
 philomel 361 14
 philomela 361 14
 philtrum 16 12
 phloem 370 9
 phlox 60 14
 Phoenix 327 9
 phonetics 342 14
 phonetic transcription 342 14
 phorbica 322 5
 phorofer 111 44
 phosphorescent material 240 18
 photocell *Garage* 195 21, 22
 photocell *Films* 312 49
 photocomposition 176
 photocomposition system 176 29
 photodiode 114 70; 243 56
 photoengraving, halftone ~ 178 38
 photogrammetry 14 63-66; 112 67

photographic plate 309 49, 50
 photographic unit 176 14
 photography 114; 115; 116
 photography, underwater ~ 279 23
 photogravure 182
 photomechanical reproduction 177
 photometer 23 54
 photometer, microscopic ~ 112 49
 photometry 23 52, 53
 photomicrographic camera attachment 112 36
 photomicro mount adapter 112 64
 photomicroscope 112 34
 photomicroscope adapter 115 89
 photomultiplier 112 51
 photosetting 176
 photosetting system 176 29
 phototheodolite 112 67
 phototopography 14 63-66
 phototypesetting 176 1
 photo-unit 176 14
 piaffe 71 1
 pianino 325 1
 pianissimo 321 36
 pianissimo piano 321 37
 piano *Music. Not.* 321 35
 piano *Music. Instr.* 325 1, 40
 piano accordion 324 36
 piano action 325 2-18
 piano case 325 6
 pianoforte 325 1
 piano keys 325 4-5
 piano mechanism 325 2-18
 piano pedal 325 9
 piano pedals 325 8-9
 piano string 325 7
 pica 175 28
 picador 319 16
 piccolo 323 30
 Piciformes 363 6
 pick 158 31; 300 33
 pick counter 166 2
 picker 166 64
 picker head 184 11
 picking bowl 166 67
 picking cam 166 66
 picking knife 136 38
 picking stick 166 17, 22
 picking stick buffer 166 65
 picking stick return spring 166 68
 pickpocket 308 16
 pick stick 166 17
 pickup attachment 62 41; 63 27
 pickup reel 64 4
 pickup sucker 184 8
 pickup truck 194 1, 5
 pickup unit 240 36
 pictographs 233 24-53
 Pictor 3 47
 picture 43 20; 246 28
 picture, panoramic ~ 24 21
 picture frame 43 21
 picture gate 312 34
 picture house 312 1

picture monitor **238 65; 239 12**
 picture rail **128 29**
 picture tube **240 3**
 picture tube geometry **242 39**
 pier *Bridges* **215 21, 54**
 pier *Docks* **225 66**
 pier *Airport* **233 12**
 pier *Art* **336 25**
 pier, clustered ~ **335 34**
 pier, compound ~ **335 34**
 pier, reinforced concrete ~ **215 61**
 piercing saw **108 12**
 piercing saw blade **108 13**
 pierette **306 12**
 pierhead **233 13**
 pierrot **306 19**
 pies **97 22-24**
 pig *Farm Bldgs.* **62 10**
 pig *Dom. Anim.* **73 9**
 pig *Livestock* **75 39**
 pig *Slaughterho.* **94 11**
 pig *Meat* **95 38-54**
 pig *Iron & Steel* **147 40**
 pig, solidifying ~ **148 25**
 pig-casting machine **147 34-44**
 pigeon **73 33; 359 23**
 pigeon hole **267 2**
 pig iron, molten ~ **147 55**
 pig iron ladle **147 12, 21, 42**
 pig iron runout **147 11**
 piglet **73 9; 75 42**
 pigment paper **182 1, 8, 10**
 pigmy **354 41**
 pigpen **62 8; 75 35**
 pigskin **292 27**
 pigsty **62 8; 75 35**
 pigtail *Hairst. etc.* **34 6**
 pigtail *Tobacc. etc.* **107 18**
 pigtail wig **34 5; 355 77**
 pig trap **146 31**
 pike *Fish Farm.* **89 17**
 pike *Free Exerc.* **295 38**
 pike *Fish etc.* **364 16**
 pike, spawning ~ **89 11**
 piked reverse hang **296 36**
 pike pole **319 17**
 pi-key **247 24**
 pilaster **335 46**
 pilaster strip **335 11**
 pile **226 40**
 pile, steel ~ **217 4**
 pile delivery unit **180 55**
 pile driver, floating ~ **226 36**
 pile driver frame **226 37**
 pile dwelling **328 15; 352 33**
 pile feeder **180 73**
 pile feeder, automatic ~ **180 48**
 pile foundation **216 8**
 pile hammer **226 38**
 pile of arrow **305 61**
 pile shoe **269 61**
 pileus **381 4**
 piling **157 25**
 pillar *Mach. Tools* **150 21**
 pillar *Shipbuild.* **222 61**
 pillar *Art* **335 20**
 pillar, engaged ~ **335 35, 46**

pillar guide **139 42**
 pillar stand *Atom* **2 29**
 pillar stand *Optic. Instr.* **112 32**
 pillar tap **126 31**
 pillion footrest **188 44**
 pillion passenger **268 36**
 pillion rider **268 36**
 pillow **27 27; 43 12-13; 47 4**
 pillowcase **43 12**
 pillow lace **102 18**
 pillowslip **43 12**
 pilot *Railw.* **210 34**
 pilot *Music. Instr.* **325 33**
 pilot, automatic ~ **224 18**
 pilot boat **221 95**
 pilot chute **288 39**
 pilot flag **253 23**
 pilot light **50 10**
 pilot light, covered ~ **38 60**
 'pilot on board' **253 24**
 pilot tone cable **313 29**
 pilot tone generator **313 30**
 pilot tone socket **117 7**
 pilot wire **325 34**
 Pilsener beer **93 26**
 pimehinketone **170 20**
 pin *Roof* **121 93**
 pin *Turner* **135 9**
 pin *Metalwkr.* **140 47**
 pin *Mach. Parts etc.* **143 31**
 pin *Sports* **305 12**
 pin, bronze ~ **328 29**
 pin, cylindrical ~ **143 40**
 pin, diamond ~ **36 18**
 pin, front ~ **305 1**
 pin, grooved ~ **143 40**
 pin, split ~ **143 19, 25, 78**
 pin, tapered ~ **143 37**
 pinacoid, triclinic ~ **351 26**
 pinafore, bib top ~ **29 41**
 pinafore dress **29 13; 30 8; 31 8**
 pin block **324 22; 325 18**
 pincers *Shoem.* **100 40, 41**
 pincers *Plumb. etc.* **126 65**
 pincers *D.I.Y.* **134 13**
 pincers *Basketm.* **136 37**
 pincers *Metalwkr.* **140 69**
 pincers, caudal ~ **81 12**
 pinch bar **158 32**
 pinchock **350 30**
 pinch roller **243 25**
 pinch roller, rubber ~ **117 35**
 pincushion **104 20**
 pine **372 20**
 pineapple **99 85**
 pineapple flower **384 64**
 pineapple gall **82 40**
 pineapple plant **384 61**
 pine beauty **82 46**
 pine cone **372 26**
 pine hawkmoth **82 27**
 pine moth **82 28**
 pine weevil **82 41**
 pin groove **143 49**
 pin holder **109 16**
 pinion *Game* **88 76**
 pinion *Mach. Parts etc.* **143 92**
 pink *Equest.* **289 13**
 pink *Colour* **343 4**

pinnacle **335 29**
 pinnate **370 41**
 pinnatifid **370 40**
 pinnipeds **367 18-22**
 pin slit **143 49**
 pin slot **143 49**
 pin vice **109 16**
 pin wire **124 28**
 pip **276 32**
 pipe *Living Rm.* **42 12**
 pipe *Ship* **221 3**
 pipe *Music. Instr.* **322 57; 326 16, 29**
 pipe, briar ~ **107 39**
 pipe, cast-iron ~ **37 14**
 pipe, cement ~ **200 62**
 pipe, clay ~ **107 34**
 pipe, Dutch ~ **107 34**
 pipe, earthenware ~ **269 35**
 pipe, long ~ **107 35**
 pipe, magic ~ **354 42**
 pipe, perforated ~ **200 62**
 pipe, polyester ~ **67 26**
 pipe, short ~ **107 33**
 pipe, vertical ~ *Dwellings* **37 14**
 pipe, vertical ~ *Fire Brig.* **270 26**
 pipe bender **125 28**
 pipe-bending machine *Plumb.* **125 28**
 pipe-bending machine *Plumb. etc.* **126 82**
 pipe bowl **107 36**
 pipe cleaner **107 46, 48**
 pipe clip *Roof* **122 31**
 pipe clip *Plumb. etc.* **126 56**
 pipe connection, quick-fitting ~ **67 28**
 pipe cutter **126 84**
 pipe-cutting machine **126 10**
 pipeline **145 65**
 pipe of peace **352 6**
 pipe rack *Living Rm.* **42 11**
 piperack *Offshore Drill.* **146 4**
 pipe repair stand **126 11**
 pipes **326 17-35**
 pipe scraper **107 45**
 pipe stem **107 38**
 pipe still **145 36**
 pipe support **67 7, 25**
 pipe supports **126 53-57**
 pipette **22 72; 350 25**
 pipette, automatic ~ **23 44**
 pipette, graduated ~ **350 24**
 pipette stand **23 52**
 pipetting device, automatic ~ **23 47**
 pipe union **350 5**
 pipe vice **126 81**
 pipe wrench **126 61; 127 47; 134 11**
 piping **30 13; 31 7**
 pirate *Sailing* **284 52**
 pirate *Carnival* **306 43**
 pirn **166 30**
 pirn, empty ~ **166 21**
 pirn holder, spring-clip ~ **166 33**
 pirouette **314 24**
 Pisces **4 64**

pisciculture **89 1-19**
 pistachio **382 51**
 pistachio nut **382 51**
 pistachio tree **382 49**
 piste **294 2**
 pistil **59 13**
 pistol **255 1**
 pistol, captive-bolt ~ **94 3**
 pistol grip *Hunt.* **87 6**
 pistol grip *D.I.Y.* **134 44**
 pistol grip *Army* **255 6, 38**
 pistol grip *Police* **264 23**
 piston *Drawing Off.* **151 60**
 piston *Intern. Combust. Eng.* **190 37**
 piston *Inf. Tech.* **242 46**
 piston, hydraulic ~ **139 41**
 piston pin **192 26**
 piston pump lever **83 45**
 piston ring **190 37**
 piston rod *Intern. Combust. Eng.* **190 21**
 piston rod *Car* **192 75**
 piston rod *Railw.* **210 33**
 pit *Blacksm.* **138 17**
 pit *Coal* **144 1-51**
 pitcher *Ball Games* **292 50, 68**
 pitcher *Prehist.* **328 35**
 pitcher's mound **292 49, 69**
 pitching **230 67**
 pitching, stone ~ **216 55**
 pitch number **278 42**
 pitch of rivets **143 60**
 pith **370 14**
 pith building **144 4**
 pith head frame **144 3**
 pith gear **144 1**
 Pithecanthropus erectus **261 16**
 pith ray **370 11**
 pit hydrant **270 25**
 piton **300 38**
 piton, ringed ~ **300 39**
 pitot-static tube **256 11; 257 1**
 pitot tube **256 11; 257 1**
 pivot *Hairdresser* **106 36**
 pivot *Bridges* **215 69**
 pivot *Winter Sp.* **302 6**
 pivot bearing **91 10**
 pivoting half **215 66**
 pivoting section **215 66**
 pivoting span **215 66**
 pivot pier **215 65**
 pix **330 8; 332 53**
 placard **263 13; 271 65; 308 50**
 place **44 5; 45 3-12**
 place card **45 13**
 place mat **44 4**
 place of issue **250 13**
 place of payment **250 15**
 place of publication **324 43**
 place setting **44 5; 45 3-12**
 placing judge **282 25**
 plaid strap **303 2**
 plain, alluvial ~ **13 10**
 plainclothes policeman **264 33**
 plain part of the cylinder **163 69**

plains Indian **352 3**
 plainsong notation **320 1**
 plain-tile roofing **122 2**
 plait **97 41**
 plait, coiled ~ **34 38**
 plaiter **168 30, 35**
 plaiting-down platform **168 37**
 plaits **34 30**
 plaits, coiled ~ **34 32**
 plan *Drawing Off.* **151 19**
 plan *Railw.* **207 10-21, 26-32, 38-42, 61-72, 76**
 planchet **252 43**
 plane *Carp.* **120 64**
 plane *Aircraft* **230 67-72**
 plane *Maths.* **347 31**
 plane, abyssal ~ **11 10**
 plane, circular ~ **347 39**
 plane, high-wing ~ **229 1; 231 2**
 plane, horizontal ~ **4 12**
 plane, low-wing ~ **229 5, 14; 231 1**
 plane, midwing ~ **229 4**
 plane, propeller-driven ~ **231 1-6**
 plane, shoulder-wing ~ **229 3**
 plane, two-seater ~ **288 18**
 plane, types of ~ **231 1-33**
 plane geometry **346 1-58**
 plane iron **132 20**
 plane of symmetry **351 5**
 planer, two-column ~ **150 8**
 planer table **150 11**
 planes **132 15-28**
 planetarium **5 17-28**
 plane tree **371 67**
 plane triangles **346 26-32**
 planets **4 42-52**
 planing boats **286 38-44**
 planing machine, two-column ~ **150 8**
 plank **55 22; 118 87; 120 1, 91; 157 34, 35**
 plank, unsquared ~ **120 94**
 plank, wooden ~ **340 2**
 plank cut **340 4**
 planking **119 52**
 planking, inner ~ **285 57**
 plank platform **118 28**
 plank roadway **118 79**
 plan of locomotive **211 10-18**
 planographic printing method **340 25-26**
 plant **370 15; 382 53**
 plant, anagraceous ~ **53 3**
 plant, asclepiadaceous ~ **53 15**
 plant, climbing ~ **51 5; 52 5; 57 8**
 plant, cyperaceous ~ **53 17**
 plant, ericaceous ~ **53 12**
 plant, female ~ **383 10**
 plant, flowering ~ **58 17**
 plant, fruit-bearing ~ **58 17**
 plant, gesneriaceous ~ **53 7**
 plant, indoor ~ **42 36; 248 14**
 plant, insectivorous ~ **377 13**
 plant, liliaceous ~ **53 13**
 plant, pistillate ~ **383 10**
 plant, pneumatic ~ **92 12**

plant, potted ~ **55 25**
 plant, ranunculaceous ~ **60 13**
 plant, tiliaceous ~ **53 9**
 plant, tuberous ~ **68 38**
 plantation, young ~ **84 11, 12**
 plant body **378 49**
 planter **248 13**
 plant in bloom **382 53**
 plant in flower **378 36**
 plant louse **358 13**
 plants, alpine ~ **378 1-13**
 plants, aquatic ~ **378 14-57**
 plants, drupaceous ~ **59 1-36**
 plants, farinaceous ~ **68 1-37**
 plants, indoor ~ **53**
 plants, leguminous ~ **57 1-11**
 plants, medicinal ~ **380**
 plants, poisonous ~ **379**
 plants, pomiferous ~ **58 31-61**
 plants, propagation of ~ **54**
 plants, tropical ~ **382**
 plants of forest, marsh, and heathland **377**
 plant stand **248 13**
 plants used in industry **383**
 plaque *Roulette* **275 12**
 plaque *Sculpt. Studio* **339 38**
 plaster *Hosp.* **26 54**
 plaster *Paperhanger* **128 2**
 plaster *Art. Studio* **338 42**
 plaster, adhesive ~ **21 7; 22 55**
 plaster cast **339 4**
 plaster cup **134 18**
 plasterer **118 83**
 plastering **118 83-91**
 plaster mould **161 15**
 plaster of Paris **128 2; 260 85**
 plasticine **48 12**
 plate **266 11**
 plate, baby's ~ **28 28**
 plate, bottom ~ **45 3**
 plate, curved ~ **178 21**
 plate, deep ~ **44 6; 45 5**
 plate, front ~ **85 35**
 plate, halftone ~ **178 38**
 plate, presensitized ~ **179 31**
 plate, rear ~ **85 40**
 plate, sliding ~ **183 28**
 plate, steel ~ **96 54**
 plate armour **329 65**
 plateau **13 46**
 plate clamp *Electrotyp. etc.* **178 27**
 plate clamp *Offset Platem.* **179 8**
 plate-coating machine **179 1**
 plate cylinder *Offset Print.* **180 25, 38, 53, 62**
 plate cylinder *Letterpress* **181 51, 60**
 plate cylinder *Office* **249 50**
 plate-drying cabinet, vertical ~ **179 27**
 plate girder bridge **215 52**
 plate magazine **113 40**
 plate mount **178 41**
 plate mounting **178 41**
 platen *Letterpress* **181 13, 15, 29**
 platen *Bookbind.* **183 24**
 platen *Office* **249 18**

platen *Graphic Art* 340 31
 platen knob 249 22
 platen machine 181 13, 29
 platen press 181 13, 29; 340 29
 platen variable 249 25
 plate rack 178 35
 plate rod 178 6
 plate whirler 179 1
 platform *Wine Grow.* 78 20
 platform *Shoes* 101 8
 platform *Bldg. Site* 118 87; 119 52
 platform *Station* 205 1, 14
 platform *Swim.* 282 7, 8
 platform *Art. Studio* 338 30
 platform, continental ~ 11 8
 platform, covered ~ 218 49
 platform, intermediate ~ 145 5
 platform, operator's ~ 168 23
 platform, wave-cut ~ 13 31
 platform clock 205 46
 platformer 145 47
 platform lighting 205 48
 platform loudspeaker 205 27
 platform mailbox 205 56
 platform number 205 4
 platform post box 205 56
 platform railing 118 24
 platform roofing 205 5
 platform scale 204 5
 platform seat 205 54
 platform sole 101 8
 platform telephone 205 57
 platform truck 194 6
 platypus 366 1
 play area 272 44
 playback deck 238 4
 playback deck, single ~ 238 56
 playback head 311 25
 player 48 20
 player's name 293 36
 playgoer 315 8
 playground, children's ~ 273
 playing card 276 36, 37
 play pen 28 39
 playsuit 29 11, 19, 22
 plaza de toros 319 5
 pleasure boat 283 1
 pleasure steamer 221 101-128; 225 29
 pleasure vehicle 186 33
 pleat, front ~ 31 25
 plectrum 322 19; 324 20
 Pleiades 3 26
 Pleiads 3 26
 pleiobar 9 2
 plexus, brachial ~ 18 27
 pliers, flat-nose ~ 126 62; 140 66
 pliers, multiple ~ 134 12
 pliers, round-nose ~ 126 64; 127 50
 pliers, shoemaker's ~ 100 38
 plinth *Dwellings* 37 17
 plinth *Carp.* 120 28
 plinth *Art* 334 31
 plinth, natural stone ~ 37 85
 Plough *Astron.* 3 29
 plough *Agr.* 63 6
 plough *Brew.* 92 24

plough, four-furrow ~ 63 40
 plough, mounted ~ 65 62
 plough, reversible ~ 65 62
 plough, single-bottom ~ 65 1
 plough anchor 286 16
 plough beam 65 9, 71
 plough bottom 65 4-8, 64-67
 plough frame 65 70
 plough handle 65 3
 ploughshare 65 7, 65; 328 33
 plough stilt 65 3
 plovers 359 19-21
 plow 63 6
 plow see plough
 plowshare 328 33
 plucking device 322 19
 Pluderhose 355 34
 plug *Tobacc. etc.* 107 19
 plug *Plumb. etc.* 126 55
 plug *Metalwkr.* 140 45
 plug, double-jointed ~ 89 70
 plug, earthed ~ 127 9
 plug, multi-pin ~ 241 70
 plug, single-jointed ~ 89 69
 plug, three-pin ~ 127 67
 plugboard 242 69
 plug gauge 149 56
 plugging 123 69
 plugging sand bucket 158 29
 plug point 127 5
 plug point, double ~ 127 6
 plug socket 50 78
 plum 59 25
 plum, black-skinned ~ 59 20
 plum, oval ~ 59 20
 plum bob 118 50, 71
 plumber 125; 125 17; 126; 126 1
 plumber's tools 126 58-86
 plumbing fixtures 126 26-37
 plume *Heraldry* 254 36
 plume *Chivalry* 329 78
 plumicorn 88 78; 362 16
 plum leaf 59 21
 plummet *Fish Farm.* 89 91
 plummet *Bldg. Site* 118 50, 71
 plum slice 97 43
 plum stone 59 23
 plum tree 59 19-23
 plumule 370 90
 plunger *Oil, Petr.* 145 23
 plunger *Glass Prod.* 162 32
 plunger *Car* 192 7
 plus sign 344 7, 23
 Pluto 4 52
 pneumatic pick longwall face 144 35
 pneumatophore 370 82
 pneume 320 1
 poacher 86 29
 pochette 322 20
 pocket, front ~ 30 23; 33 46; 260 10
 pocket, inset ~ 29 63; 31 4
 pocket billiards 277 7
 pocket book 264 36
 pocket calculator 246 12
 pocket calculator, electronic ~ 247 14
 pocket camera 114 16
 pocket chamber 2 15

pocket flap 33 18
 pocket meter 2 15
 pocket timetable 204 42; 205 45
 pocket torch 127 26
 pocket train schedule 204 42; 205 45
 pod 57 6; 61 20, 23; 69 8, 16; 370 92, 93; 378 33; 384 46
 pod, immature ~ 374 22
 pod, mature ~ 383 4
 pod, pouch-shaped ~ 61 11
 pod, ripe ~ 383 4
 pod, unripe ~ 374 22
 pod corn 68 31
 poet's daffodil 60 4
 poet's narcissus 60 4
 point *Game* 88 10, 31
 point *Mach. Parts etc.* 143 23, 54
 point *Sculpt. Studio* 339 15
 point *Maths.* 346 1-23
 point, angular ~ 346 1
 point, diamond ~ 24 40
 point, equinoctial ~ 3 6, 7
 point, front ~ 300 49
 point, typographic ~ 175 18
 pointer *Hosp.* 26 28
 pointer *Dog* 70 40, 43
 pointer *Photog.* 114 58
 pointer *Inf. Tech.* 242 76
 pointer *Chem.* 349 34
 point guard 300 50
 pointing 122 55
 pointing sill 121 47
 point lace 102 30
 point light exposure lamp 179 21
 point lock 202 28
 point-of-aim mark 305 56
 point of Aries 3 6
 point of arrow 305 61
 point of contact 346 49
 point of hook 89 80
 point of inflexion 347 21
 point of intersection 346 1
 point of release 89 34
 point paper design 171 4, 27
 points, equinoctial ~ 3 6-7
 points, manually-operated ~ 202 16
 points, remote-controlled ~ 202 27
 points, single ~ 203 45-48
 points change indicator 197 39
 point shoe 314 30
 point size 175 46
 points knob 203 62
 points lever 203 55
 points mechanism, electric ~ 197 43
 points mechanism, electrohydraulic ~ 197 43
 points mechanism, electromechanical ~ 197 43
 points motor 202 35
 points of sailing 285 1-13
 points of the horse 72 1-38
 point source lamp 182 4



points signal 197 38; 202 19
 points signal, electrically illuminated ~ 202 33
 points signal lamp 202 19
 points signals 203 45-52
 point wire 202 30
 poison gland 77 14
 poison sac 77 13
 poitrel 329 85
 poke bonnet 306 23; 355 71
 poker 38 41; 137 5
 polar bear 368 11
 Polaris 3 1, 34
 polarizer 112 14
 polarizing filter 112 19
 polar sledge 303 18
 polar wind zone 9 51
 pole *Fruit & Veg. Gdn.* 52 28
 pole *Horse* 71 21
 pole *Fish Farm.* 89 30
 pole *Mills* 91 32
 pole *Carriages* 186 19, 30
 pole *Rivers* 216 16
 pole *Athletics* 298 28
 pole, bamboo ~ 307 46
 pole, celestial ~ 3 1; 4 24, 26
 pole, geographical ~ 14 3
 pole, hooked ~ 77 55
 pole, terrestrial ~ 14 3
 pole chain 71 20
 pole horse 186 47
 pole mast 258 42; 259 6
 Pole Star 3, 34
 pole vane 298 28-36
 pole vaulter 298 29
 polyn 329 53
 polihode 4 28
 police 264
 police badge 264 27
 police dog 70 25; 264 5, 6
 police duties 264 1-33
 police helicopter 264 1
 police identification disc 264 26
 police launch 221 100
 policeman 264 18, 34
 police officer 264 18
 police patrolman 264 13
 police signalling disc 264 14
 police van 264 38
 policewoman 264 37
 polishing 109 17
 polishing and burnishing machine 108 42
 polishing bonnet, lamb's wool ~ 134 21
 polishing brush 100 11
 polishing iron 108 51
 polishing machine attachment 109 15
 polishing wheel 108 44
 polish rod 145 27
 political section 342 51
 Politzer bag 22 37
 polje 13 72
 pollen 77 3, 35; 370 65
 pollen basket 77 6
 pollen comb 77 7
 pollen sac 372 45, 50
 pollen tube 370 66
 pollex 19 64

polling booth 263 23
 polling card 263 19
 polling number 263 19
 polling place 263 16
 polling station 263 16
 polo jumper, striped ~ 30 20
 polo neck jumper 30 7
 polo outsole 101 24
 polo saddle, high-back ~ 188 13
 polyamide 170 34, 35, 37, 41
 polyamide chip, dry ~ 170 39
 polyamide cone 170 51, 52
 polyamide fibres 170 1-62
 polyamide filament 170 43
 polyamide staple 170 61, 62
 polyamide thread 170 46
 polyanthus narcissus 60 4
 Polychaetes 369 15
 polyester resin 130 17
 polygon 346 40
 polygon, eight-sided ~ 351 17
 polygon, five-sided ~ 351 9
 polygon, regular ~ 346 41
 polygon, six-sided ~ 351 15
 polyhedron 260 73
 polyhedron, eight-faced ~ 351 6
 polyhedron, forty-eight-faced ~ 351 13
 polyhedron, four-faced ~ 351 1
 polyhedron, regular ~ 351 11
 polyhedron, six-faced ~ 351 2
 polyhedron, twenty-faced ~ 351 11
 polyhedron, twenty-four-faced ~ 351 12
 polymerization 170 33, 54
 polyp, hydroid ~ 369 9
 polypod 377 16
 polypody 377 16
 pome 370 102
 pomegranate 384 16
 Pomeranian 70 20
 pomes 58
 pommel 296 6
 pommel horn 71 38
 pommel horse 296 5
 pommer 322 14
 pompier 270 43
 pompier ladder 270 16
 pompon 29 4
 pompon dahlia 60 23
 poncho 352 24
 pond *Map* 15 79
 pond *Park* 272 50
 ponds 17 46
 pons cerebelli 17 46
 pons cerebri 17 46
 pontic, porcelain ~ 24 29
 pontoon 226 57
 pontoon, bottom ~ 222 38
 pontoon bridge 15 46
 pontoon dock 222 34-43; 225 16
 pony 75 4
 ponytail 34 27
 poodle 70 36
 pool, indoor ~ 281 1-9

pool, non-swimmers' ~ 282 21
 pool, swimmers' ~ 282 23
 pool attendant 281 4; 282 15
 pool billiards 277 7
 poolroom 277 7-19
 poop 223 33; 258 22
 poor man's weatherglass 61 27
 popcorn 68 31
 poplar 371 15
 poppy 51 30; 61 2
 poppy flower 61 4
 poppy seed 61 5
 porcelain manufacture 161
 porcelain painter 161 17
 porcupine 366 13
 porifer 357 13
 pork 95 38-54
 pork, collared ~ 96 9
 porridge oats 98 37
 port *Ship* 220 27
 port *Docks* 225; 226
 port administration offices 225 36
 portal 331 16
 portal, main ~ 333 34
 portal, recessed ~ 335 24
 portal figure 333 36
 portal frame 215 38
 portal relief 333 35
 portal spotlight 316 21
 portato 321 29
 portcullis 329 24
 port custom house 225 6
 port de bras à coté 314 7
 port de bras en avant 314 9
 port de bras en bas 314 8
 port de bras en haut 314 10
 porter *Brew.* 93 26
 porter *Station* 205 31; 206 33
 porter *Hotel* 267 17
 porthole 117 64
 porthole, ornamental ~ 218 57
 port hospital 225 26
 portico 334 50, 56
 port liner 190 73
 port of registry 286 8
 ports de bras 314 7-10
 posaune stop 326 17-22
 position 224 45
 position indicator 246 18
 position light 257 36; 288 31
 position light, left ~ 230 50
 position light, right ~ 230 44
 positions 314 1-6
 positive 322 56
 post *Dent.* 24 34
 post *Wine Grow.* 78 7
 post *Forestry* 84 17; 85 30, 47
 post *Mills* 91 34
 post *Carp.* 120 25
 post *Roof* 121 40, 81
 post *Paperm.* 173 50
 post *Ball Games* 291 37
 post, broker's ~ 251 3
 post, principal ~ 120 53
 postage meter 22 24; 236 7
 postage stamp 236 61

postal code 236 43
 postal collection 236 50-55
 postal delivery 236 50-55
 postbox 236 50
 post code 236 43
 post crown 24 31
 poster 98 2; 204 10; 268 71;
 271 25
 posthorn 186 41
 post horse 186 43
 postman 236 53
 postmark, special ~ 236 59
 postmark advertisement 236
 56
 postmarks 236 56-60
 post office 236; 237; 268 68
 post office box 236 13, 14
 post office savings counter
 236 25
 post office van 236 52
 post-synchronization 311
 37-41
 post-syncing 311 37-41
 post-sync sound 117 101
 post windmill 91 31
 pot *Kitch.* 39 29
 pot *Kitch. Utensils* 40 12
 pot *Plant Propagn.* 54 8
 pot, baby's ~ 28 47
 pot, centrifugal ~ 169 17
 potash salt bed 154 65
 potash salt seam 154 65
 potato 68 38, 40
 potato, flat-oval ~ 68 38
 potato, Irish ~ 68 38
 potato, kidney-shaped ~ 68
 38
 potato, long ~ 68 38
 potato, pear-shaped ~ 68 38
 potato, purple ~ 68 38
 potato, red ~ 68 38
 potato, round ~ 68 38
 potato, round-oval ~ 68 38
 potato, white ~ 68 38
 potato, yellow ~ 68 38
 potato apple 68 43
 potato basket 66 25
 potato beetle 80 52
 potato berry 68 43
 potato chipper 40 43
 potato crisp 45 41
 potato dish 45 31
 potato fork 66 5
 potato harvester 64 59-84
 potato haulm 68 41
 potato hoe 66 24
 potato hook 66 6
 potato plant 68 38
 potato planter 66 21
 potato rake 66 20
 potato server 45 75
 potato top 68 41
 potato tuber 68 40
 potential transformer 153 59
 pot-helm 254 7
 pot-helmet 254 7
 pot holder 39 18
 pot holder rack 39 19
 pot plant 39 37; 44 25; 55 25
 potsherd 161 21
 potter's wheel 161 11
 pottery 308 66
 pottery, chip-carved ~ 328 35
 pottery stand 308 64-66
 potting bench 55 12
 potting table 55 12
 potty 28 47
 pouch, gular ~ 359 8
 poulaine 355 42
 poulard 98 7; 99 58
 poultry 73 19-36
 poultry farming 74 1-27
 poultry keeping 74
 poultry management,
 intensive ~ 74 1-27
 pounce bag 129 49
 pouncing 129 48
 pound, lower ~ 217 29
 pound, upper ~ 217 37
 pound lock gate 217 31
 pound sterling 252 37
 pouring end 147 34
 pouring floor, sinking ~ 148
 24
 pouring ladle lip 147 43
 powder, black ~ 87 53
 powder, smokeless ~ 87 53
 powder box 43 28; 49 35
 powder charge 87 57
 powder flag 253 38
 powder 345 1
 powerboat racing 286 21-44
 powerboats 286 1-5
 power control 100 22
 power hacksaw 138 23
 power hammer 137 9
 power house *Hydr. Eng.* 217
 21
 power house *Shipbuild.* 222
 33
 power house *Films* 310 8
 power lift 65 24-29
 power line 127 23
 powerpack unit 114 66
 power plant *Coal* 144 13
 power plant *Power Plant* 152;
 153
 power plant *Glass Prod.* 162
 power regulator 100 22
 power saw *Forestry* 84 22, 27;
 85 13
 power saw *Blacksm.* 138 23
 power screwdriver 195 23
 power shovel 200 1
 power source 110 7
 power station *Coal* 144 13
 power station *Offshore Drill.*
 146 1
 power station *Power Plant*
 152; 153
 power station *Glass Prod.* 162
 power station *Hydr. Eng.* 217
 64
 power supply *Arc Weld.* 142
 25
 power supply *Energy Sources*
 155 21
 power supply, external 115
 79
 power take-off 63 21; 64 49
 power take-off clutch 65 40
 power take-off gear 65 38

power take-off gear-change
 65 23, 40
 power take-off shaft 63 21;
 64 49
 power transformer 152 30, 39
 power unit 84 34
 power zooming arrangement
 117 19
 prairie horse 352 4
 pralltriller 321 19
 pram *Infant Care etc.* 28 34
 pram *Docks* 226 57
 pram *Park* 272 71
 pram *Playground* 273 31
 pram, wicker ~ 28 30; 48 24
 pram jacket 29 3
 pram suit 29 1
 prayer book 330 62
 prayer tower 337 13
 prayer wheel 353 29
 preacher 330 22
 precession 4 24
 precipitation 8 18
 precipitation, scattered ~ 8 19
 precipitation, types of ~ 8
 18-19
 precipitation area 9 30
 precipitation gauge 10 44
 precipitator, electrostatic ~
Power Plant 152 13
 precipitator, electrostatic ~
Coking 156 20
 precipitator, electrostatic ~
Cement Wks. 160 7
 precipitator, electrostatic ~
Papern. 172 39
 precision balance 108 35
 precision bench lathe 109 20
 precision file 140 8
 precision lathe 138 20
 predator, small ~ 86 19, 20, 22
 pre-distributor channel 236
 36
 pre-drying 165 50
 preheater 212 41
 preheater, high-pressure ~
 152 26
 preheater, low-pressure ~ 152
 25
 preheater pressure gauge 210
 43
 preheater unit 185 30
 prehistory 328
 prelims 185 43-47
 pre-listening button 238 46
 pre-listening speaker 238 50
 premasher 92 42
 premixer 97 58
 pre-mixing room 238 54-59
 premolar 19 18
 préparation 314 23
 preparation and sterilization
 room 26 34-54
 preparation level 64 16
 preparation of surfaces 128
 1-17
 preparation room 26 34-54
 prepuce 20 70
 presbytery 330 32
 prescription 22 3, 20
 present-day man 261 21

preserve 98 51
 preserving jar 40 25
 preset control 316 2
 presorter 172 21
 presorting 64 82
 press *Joiner* 133 51
 press *Ball Games* 293 32
 press, first ~ 173 19
 press, rotary ~ *Text. Finish.*
 168 38
 press, rotary ~ *Letterpress* 181
 57
 press, second ~ 173 20
 press, web-fed ~ 181 57
 press-and-blow process 162
 30
 press attachment 100 15
 press bar 100 17
 press bed 180 78; 181 17
 press bowl, heated ~ 168 41
 press camera 114 36
 presser 103 19
 'press facilities' 233 43
 press finishing 168 38
 pressing *Glass Prod.* 162 33
 pressing *Papern.* 173 50
 pressing cloth 104 32
 pressing cushion 104 28
 pressing mechanism 184 13
 pressing nail 104 28
 pressman 340 35
 press mould 162 34
 press photo 342 58
 press photographer 299 49
 press roll 173 37
 press roller 64 64
 pressure, atmospheric ~ 9 4
 pressure, barometric ~ 9 4
 pressure adjustment 249 53
 pressure adjustment,
 calibrated ~ 185 5
 pressure bulkhead 231 32
 pressure bulkhead, forward ~
 235 19
 pressure chamber 83 44
 pressure cloth 116 59
 pressure cooker *Kitch.*
Utensils 40 21
 pressure cooker *Camping* 278
 35
 pressure cylinder 133 46
 pressure foot 133 47
 pressure fuelling point 257 33
 pressure gas 156 28
 pressure gauge *Hosp.* 25 53;
 26 29
 pressure gauge *Overh. Irrign.*
 67 10
 pressure gauge *Pest Contr.* 83
 42
 pressure gauge *Blacksm.* 138
 15
 pressure gauge *Electrotyp.*
etc. 178 8
 pressure gauge *Offset Print.*
 180 74
 pressure gauge *Garage* 195 29
 pressure gauge *Serv. Stat.* 196
 20
 pressure gauge *Railw.* 211 24
 pressure gauge *Theatre* 316 56

pressure graph 27 31
 pressure hull 258 66; 259 55,
 76
 pressure indicator 25 55
 pressure line 235 54, 57
 pressure pipe *Market Gdn.* 55
 8
 pressure pipe *Hydr. Eng.* 217
 50
 pressure pipe *Theatre* 316 54
 pressure pipeline 217 41
 pressure piston 133 52
 pressure plate 115 24
 pressure point 21 14
 pressure pot 129 31
 pressure pump, hydraulic ~
 178 11
 pressure-reducing valve 141
 5
 pressure regulator *Gas Weld.*
 141 5
 pressure regulator *Graphic*
Art 340 38
 pressure release valve 155 7
 pressure tank 316 55
 pressure trace 25 57
 pressure transducer 27 32
 pressure valve 40 22
 pressure weight 168 2
 pressurized gas delivery
 system 234 60
 pressurized-water reactor
 154 19
 pressurized-water system 154
 40
 presto 321 28
 pretzel *Bakery* 97 44
 pretzel *Supermkt.* 99 16
 preventer 270 15
 preview monitor 238 60
 price *Equest.* 289 37
 price *Script.* 342 41
 price card 271 19
 price display 196 6
 price label 96 6
 price list *Butch.* 96 19
 price list *Grocer* 98 73
 price list *Bank* 250 8
 price offered 289 37
 pricket 330 52
 pricking off 54 5
 pricking out 54 5
 priest 330 39; 331 47
 prima ballerina 314 27
 primary 153 15
 primary school 260 1-85
 primary voltage bushing 152
 43
 primary voltage terminal 152
 43
 primates 368 12-16
 prime focus cage 5 2
 Prime meridian 14 5
 primer 128 6
 prime steam line 154 31
 priming brush 338 9
 primitive man 261 19
 princess, German ~ 355 20
 principal 345 7
 principal diapason 326 31-33
 print delivery 249 43

print drier, heated ~ 116 57
 print drier, rapid ~ 116 57
 printer *Garage* 195 6
 printer *Office* 245 32
 printer, rotating ~ 111 27
 printery 340 27-64
 printing, rotary ~ 178 21
 printing cylinder 177 67
 printing-down frame 179 13
 printing element 178 39
 printing image carrier 340 59
 printing office 340 27-64
 printing paper 180 47
 printing paper, photographic
 ~ 116 51
 printing plate 178 38
 printing speed adjustment
 249 55
 printing surface 340 59
 printing unit 180 41, 80
 printing unit, first ~ 181 48
 printing unit, lower ~ 180
 7,9,11,13
 printing unit, reversible ~ 182
 26
 printing unit, second ~ 181 52
 printing unit, upper ~ 180
 6,8,10,12
 print-out machine 195 6
 print quantity selection 249
 35
 print tongs 116 47
 prism, hexagonal ~ 351 21
 prism, monoclinic ~ 351 24
 prism, quadratic ~ 347 34
 prism, triangular ~ 347 37
 private detective 275 16
 privet 373 6
 privet hawkmoth 358 55
 prize 306 11; 308 48
 probe *Dent.* 24 46
 probe *Photog.* 114 63; 116 55
 probe, bulb-headed ~ 22 53;
 26 40
 probe, hollow ~ 26 41
 probe, olive-pointed ~ 22 53;
 26 40
 probe exposure meter 114 61
 probe lead 116 38
 proboscidean 366 20
 proboscidian 366 20
 proboscis *Articulatus* 358 17,
 56
 proboscis *Mammals* 366 21
 procaviid 366 24
 process and reproduction
 camera, universal ~ 177
 24
 process camera, overhead ~
 177 1
 process camera, vertical ~ 177
 32
 process control computer 236
 37
 processing drum 116 48
 processing laboratory 310 2;
 311 30
 processing machine 179 31
 processing plant 144 5
 processing unit, central ~ 176
 29

procession, religious ~ 331 42-50
 processionary moth 82 14
 processor, automatic ~ 116 60
 processor, central ~ 244 6
 proclamation 263 14
 proctoscope 23 17, 19, 21
 proctoscopy 23 18
 Procyon 3 15
 produce, agricultural ~ 68 1-47
 producer 316 40
 product 344 25
 production control room 238 17
 production line 173 13-28
 production manager 310 26
 production oil and gas separator 146 9
 product register 309 82
 profile 118 69
 profile, basic ~ 229 45
 profiling tool 161 14
 profit 345 7
 program *see* programme
 program card 195 5, 10
 program input 177 71
 programme 315 13
 programme, computer-controlled ~ 238 2
 programme, educational ~ 261 7
 programme dial 243 40
 programmed individual presentation system 242 15
 programme monitor 238 61
 programmer 248 15
 programme recorder 261 42
 programme scale 243 40
 programme selector 243 39
 program selector control 50 26
 program selector switch 25 50
 progress counter 242 5
 projectile 255 26
 projection *Films* 311 45
 projection *Art* 335 43
 projection, conical ~ 14 8
 projection, cylindrical ~ 14 9
 projection booth 5 27; 312 12
 projection dome 5 21
 projectionist 312 20
 projection lamp 312 18
 projection lens 261 10; 312 35
 projection room 312 12
 projection room window 312 15
 projection screen *Optic. Instr.* 112 24
 projection screen *Broadcast.* 238 32
 projection screen *School* 260 36
 projection screen *Films* 310 16; 312 11
 projection table 261 13
 projection window 312 15
 projector 5 23; 316 17
 projector, left-hand ~ 312 13
 projector, overhead ~ 242 6
 projector, right-hand ~ 312 14

projector attachment 112 55
 projector gate 312 34
 projector lens 312 35
 projector mechanism 312 25-38
 projector switch 195 20
 projector top 261 9
 promenade 223 27
 promenade deck 223 22-27
 prominence, laryngeal ~ 19 13
 prominence, solar ~ 4 40
 prompt book 316 41
 prompt box 316 27
 prompter 316 28
 prompt script 316 41
 prone position *Free Exerc.* 295 45
 prone position *Sports* 305 29
 prong *Tablew. etc.* 45 60
 prong *Agr. Impl.* 66 4
 proof 340 43
 proofing press 180 75
 proof press 180 75
 prop *Household* 50 37
 prop *Circus* 307 13
 prop *Theatre* 315 50
 prop, front ~ 303 8
 prop, rear ~ 303 9
 propagation 54 10, 14, 27
 propagation of plants 54
 propane gas 278 33
 propane gas bottle 278 34
 propeller *Brew.* 92 46
 propeller *Energy Sources* 155 45
 propeller *Life-Sav.* 228 26
 propeller *Aircraft* 230 32
 propeller *Motorboats etc.* 286 64
 propeller *Airsports* 288 36
 propeller, feathering ~ 224 19
 propeller, reversible ~ 224 19
 propeller, ship's ~ 221 44; 222 72; 223 62
 propeller, three-blade ~ 223 62
 propeller, variable-pitch ~ 224 19
 propeller bracket 223 61
 propeller guard 258 40
 propeller guard boss 258 63
 propeller guard moulding 258 74
 propeller mixer 79 6
 propeller pitch indicator 224 20
 propeller post 222 71
 propeller pump 217 47-52
 propeller shaft *Car* 192 30, 65
 propeller shaft *Ship* 223 65
 propeller shaft *Aircraft* 232 60
 propeller shaft *Warships* 259 59
 propeller strut 223 61
 propeller-turbine engine 256 16
 propeller-turbine plane 231 4
 propelling nozzle 232 39, 45, 49, 55

property 315 50
 proportion, simple ~ 345 8-10
 proportional dividers 339 2
 proprietor 248 29; 266 71
 prop stand 187 34; 188 51
 propulsion nozzle 232 39, 45, 49, 55
 propylaea 334 7
 proscenium 315 15; 334 46
 proscenium, adjustable ~ 316 22
 prostate 20 76
 protection device 255 81, 90
 prothorax 82 4; 358 29
 proton 1 2, 16, 31
 protoplasm 357 3
 protoprism 351 19, 20
 protopyramid 351 19, 20
 prototype 290 38
 protozoans 357 1-12
 protractor 260 38
 protrusion, massive ~ 11 29
 protuberance, frontal ~ 16 4
 pruner 56 11
 pruning knife 56 9
 pruning saw 56 16
 pruning shears 56 50
 prussic acid 83 15
 pseudocarp 58 21; 384 12, 62
 pseudopod 357 4
 psychrometer 10 52
 pubis 17 20
 public conveniences 268 62
 publicity calendar 22 10
 puck 302 35
 pudding fender 227 17
 pudenda 16 39
 puffball 381 19
 puff paste 97 18
 puff pastry 97 18
 pug 70 9; 123 69
 pug dog 70 9
 pull 340 43
 pull-down table 207 53
 pullet 74 9
 pullet fold unit 74 5
 pulley *Cotton Spin.* 164 48
 pulley *Bicycle* 187 9
 pulley, glass ~ 169 16
 pulley cradle 214 36, 53
 pulley cradle, main ~ 214 67
 pullover, heavy ~ 33 52
 pullover, men's ~ 33 51
 pullover, short-sleeved ~ 33 32
 pull rod *Mach. Parts etc.* 143 101
 pull rod *Railw.* 202 20
 pull-switch 127 16
 pull-through 87 64
 pull-up phase 298 29
 pulmonary function test 27 36
 pulp 58 24, 35, 58; 59 6
 pulp, chemical ~ 172 77, 78
 pulp, dental ~ 19 32
 pulp, mechanical ~ 172 77, 78
 pulp-drying machine 172 61
 pulper 172 80
 pulpit 330 19; 337 15
 pulpit balustrade 330 23
 pulpit steps 330 18

pulp machine 172 61
 pulpstone 172 71
 pulp water pump 172 55, 63
 pulsator 75 32
 pulse cable 117 72
 pulse-generating camera 117 71
 pulse generator 313 30
 pulse generator socket 117 7
 pulse rate 23 27
 pulse shape 23 37
 pump *Agr. Mach.* 65 45
 pump *Shoes* 101 29
 pump *Oil, Petr.* 145 22
 pump *Synth. Fibres* 170 31
 pump, centrifugal ~ *Wine Cell.* 79 7
 pump, centrifugal ~ *Rivers* 216 60
 pump, centrifugal ~ *Water* 269 44
 pump, centrifugal ~ *Fire Brig.* 270 8
 pump, direct-connected ~ 83 41
 pump, hydraulic ~ *Agr. Mach.* 64 29, 91
 pump, hydraulic ~ *Theatre* 316 53
 pump, main ~ 269 15
 pump, motor-driven ~ 83 41
 pump, portable ~ 270 52
 pump, power take-off-driven ~ 67 14, 15
 pump compass 151 59
 pump compression spring 174 41
 pump connection 67 8
 pumpernickel 97 49
 pumping plant 217 39-46
 pumping rod 145 25
 pumping station *Offshore Drill.* 146 22
 pumping station *Hydr. Eng.* 217 43
 pumping station *Shipbuild.* 222 33
 pumping station *Spa* 274 4
 pumping unit 145 22
 pumpkin 57 23
 pump pressure spring 174 41
 pump room *Brew.* 92 11
 pump room *Spa* 274 8, 15
 pumps 2 52
 pump shaft 199 19
 pump strainer 269 6, 14, 43
 punch *Shoem.* 100 45, 46
 punch *Goldsm. etc.* 108 19, 30, 31
 punch *Office* 247 3
 punch *Sculpt. Studio* 339 15
 punch, foul ~ 299 34
 punch, hollow ~ 125 13
 punch, illegal ~ 299 34
 punch, revolving ~ 100 44
 punch, rotary ~ 100 44
 punch, round ~ 137 36; 140 65
 punch, steel ~ 175 36
 punch, straight ~ 299 28
 punch bag 299 21

punch ball 299 24
 punch ball, spring-supported ~ 299 20
 punch ball, suspended ~ 299 23
 punch blank 175 35
 punch card 237 64
 punch card reader 244 12
 punch cutter 175 32
 punched card 237 64
 punched card reader 244 12
 punched tape 176 6, 8, 12; 237 62, 68
 punched tape input 176 30
 punched tape reader 176 13, 15
 punching bag 299 21
 punch tape 176 6, 8, 12; 237 62, 68
 punch tape input 176 30
 punch tape reader 176 13, 15
 punctuation marks 342 16-29
 punt 216 15; 283 1
 punt pole 89 30; 216 16
 pup 73 16
 pupa 77 30, 32; 80 4, 25, 43; 81 21, 24; 82 13, 21, 32; 358 20; 365 11
 pupa, coarctate ~ 81 3
 pupil *Man* 19 43
 pupil *School* 260 3, 20
 puppy 73 16
 pure culture plant 93 6
 purfling 323 26
 purge valve 6 25
 purified water tank 269 13
 purlin 119 55; 121 39, 51, 76
 purlin, concrete ~ 119 4
 purlin, inferior ~ 119 3; 121 44; 122 40
 purlin roof 121 46
 purlin roof structure 121 52, 60
 purple clover 69 1
 purple medick 69 9
 purse wig 34 4
 push button 203 67; 237 18, 19; 241 3
 push-button keyboard 237 10; 245 14; 246 14
 push-button telephone 237 20
 pushchair 28 37
 pushchair, doll's ~ 48 31
 pusher ram 156 7
 pushing frame 200 30
 push sledge 304 29
 push tow 225 60
 push tug 221 93
 putlock 118 27
 putlog 118 27
 putter 293 93
 putting green 293 82
 putty 124 17
 putty knife 124 27; 129 24
 puzzle 48 9
 pyelogram 27 6
 pyelogram cassettes 27 14
 pyelography 27 4
 pygmy poodle 70 36

pyjamas 32 17, 36
 pyjama top 32 18
 pyjama trousers 32 19
 pylon *Railw.* 214 31, 77
 pylon *Art* 333 9
 pylon, tubular steel ~ 214 78
 pylorus 20 42
 pyramid *Fruit & Veg. Gdn.* 52 16
 pyramid *Circus* 307 28
 pyramid *Art* 333 1
 pyramid, glass ~ 5 19
 pyramid, orthorhombic ~ 351 23
 pyramid, quadrilateral ~ 347 46
 pyramid, stepped ~ 333 22; 352 20
 pyramid site 333 6
 pyramid tree 52 16; 272 19
 pyrheliometer 10 23
 pyrite 351 8
 pyrometer 178 16
 pyx 330 8; 332 53
 pyxidium 370 95

Q

quack grass 61 30
 quadrant 347 5
 quadraphonic system 241 13-48
 quadra/stereo converter 241 46
 quadrilateral, irregular ~ 346 39
 quadrilaterals 346 33-39
 quadruplet 321 23
 quail 359 22
 quail call 87 45
 quake, tectonic ~ 11 32-38
 quake, volcanic ~ 11 32-38
 quantity, unknown ~ 345 4, 8
 quant pole 89 30; 216 16
 quantum jump 1 15
 quantum jumps 1 20-25
 quantum transitions 1 20-25
 quarantine wing 225 27
 quarrier 158 5
 quarry *Map* 15 87
 quarry *Quarry* 158 1
 quarryman 158 5
 quarry worker 158 5
 quarte engagement 294 47
 quarter *Shoem.* 100 61
 quarter *Carp.* 120 25
 quarter, first ~ 4 4
 quarter, last ~ 4 6
 quarter, third ~ 4 6
 quarter baulk 120 90
 quarter gallery 218 57
 quarterings 254 18-23
 quartering wind 285 13
 quarter light 191 23
 quarter note 320 15
 quarter of beef 94 22
 quarter piece 329 88
 quarter rest 320 23
 quarters, firemen's ~ 270 2
 quarter vent 191 23

quarter wind 285 13
 quartz 110 15
 quartz-halogen lamp 179 21;
 182 3
 quartz watch, electronic ~ 110
 14
 quatrefoil 335 39
 quaver 320 16
 quaver rest 320 24
 quay 222 5; 225 64
 quayside crane 225 24
 quayside railway 225 21
 quayside road 225 38
 quayside roadway 225 38
 quayside steps 283 22
 quay wall 217 1-14
 queen *Bees* 77 4, 38
 queen *Games* 276 9
 queen bee 77 4
 Queen Carnival 306 61
 queen cell 77 37
 queen-excluder 77 47
 queen post 121 46, 52, 68
 queen truss 121 65
 Queen Victoria water lily 378
 17
 quenching car 156 10
 quenching tower 156 11
 quenching trough 137 8
 question mark 342 20
 queue 34 6; 319 26
 quickbeam 371 42
 quick grass 61 30
 quick hitch 65 86
 quicksand 227 3
 quid 107 19
 quill 341 26
 quillions 294 42
 quill pen 341 26
 quill plectrum 322 53
 quilting 29 39; 30 17
 quilt stitching 29 39; 30 17
 quince, apple-shaped ~ 58 49
 quince, pear-shaped ~ 58 50
 quince leaf 58 47
 quince tree 58 46
 quinquefoliate 370 39
 quintuplet 321 23
 quipa 352 22
 quitch grass 61 30
 quiver 352 27
 quoin 181 39
 quoit 280 32; 308 47
 quoits 280 31
 quotation 250 8
 quotation board 251 8
 quotation mark, double ~ 342
 26
 quotation mark, French ~ 342
 27
 quotient 344 26

R

rabbit plane 132 25
 rabbit 73 18; 86 23; 88 65
 rabbit burrow 86 26
 rabbit fence 84 7
 rabbit hole 86 26
 rabbit net 86 27

raccoon 368 9
 race, inner ~ 143 72
 race, outer ~ 143 71
 race board 166 42
 racehorse 289 51
 raceme 58 15; 374 33
 raceme, simple ~ 370 68
 raceway 91 44
 racing 289 50
 racing, motor-paced ~ 290
 11-15
 racing and passenger aircraft
 230 1-31, 32-66; 231 1
 racing bicycle 290 16
 racing boats 283 9-16
 racing car 290 38
 racing cars 290 34-38
 racing cycle 290 15, 16
 racing cyclist 290 8
 racing dive 282 29
 racing flag 284 48
 racing handlebar 290 18
 racing jersey 290 9
 racing keelboat 285 35
 racing motorcycle 290 27
 racing motorcycle,
 streamlined ~ 290 31
 racing motorcyclist 290 25
 racing outboard motor 286 23
 racing saddle 290 17
 racing sculler 283 16
 racing shell, eight-oared ~
 283 10
 racing suit 301 31
 racing toe clip 290 21
 racing tyre 290 19
 rack *Kitch. Utensils* 40 31
 rack *Composing Rm.* 174 8
 rack *Garage* 195 10
 rack *Railw.* 214 9, 11
 rack, removable ~ 40 24
 rack and pinion 112 39
 rack-and-pinion railway 214
 4-5
 rack-and-pinion railways
 214 7-11
 racket 293 29
 racket handle 293 30, 46
 racket press 293 32
 rack for glasses 274 16
 rack head 163 16, 18
 racking back 118 61
 rack mountain railway 214
 4-5
 rack railroad 214 4-5
 rack railroad car 214 5
 rack railroad locomotive,
 electric ~ 214 4
 rack railway coach 214 5
 rack railway locomotive,
 electric ~ 214 4
 rack railways 214 7-11
 rack railway trailer 214 5
 rack track 217 69
 racoon 368 9
 racquet *see* racket
 radar antenna 223 8; 224 104;
 258 36; 259 8, 29, 48, 91
 radar apparatus 224 10-13
 radar display unit 224 12
 radar dome *Aircraft* 231 18

radar dome *Air Force* 256 10
 radar dome *Warships* 258 52,
 77; 259 49
 radar equipment 224 10-13
 radar image 224 13
 radar nose 231 18; 256 10
 radar pedestal 224 10
 radar picture 224 13
 radar reflector 10 58
 radar reflector, revolving ~
 224 11
 radar scanner 223 8; 224 104;
 258 36; 259 8, 29, 48, 91
 radar screen 224 12
 radial side of the hand 19 69
 radiant energy 10 23
 radiation, solar ~ 155 18
 radiation detectors 2 1-23
 radiation meters 2 1-23
 radiation monitor 2 1
 radiation shield 2 31, 46
 radiation shielding 2 31
 radiation unit 24 23
 radiator *Doc.* 23 23
 radiator *Roof & Boilerr.* 38
 76
 radiator *Agr. Mach.* 65 51
 radiator *Plumb. etc.* 126 20
 radiator *Energy Sources* 155
 15
 radiator *Car* 191 9
 radiator *Railw.* 212 54
 radiator bonnet 304 11
 radiator brush 129 21
 radiator grill 191 11
 radiator heating 155 27
 radiator hood 304 11
 radiator rib 38 77; 126 21
 radiators 6 8
 radiator shutter 304 12
 radical 345 2
 radicle 370 88
 radio 238; 239
 radioactive waste storage 154
 56
 radio antenna 197 34
 radio cassette recorder 241 1
 radio communication set 197
 28
 radio compass 230 5
 radio direction finder
 antenna 223 5; 224 106
 radio direction finder frame
 258 17
 radio equipment 197 28; 230
 22; 288 13, 17
 radiographer 27 11
 radiolarian 357 8
 radio link, intercontinental ~
 237 54-55
 radiometer 10 71
 radio navigation equipment
 230 22
 radio OB van 239 1-15
 radiophone 22 14
 radio room 223 12
 radioscope box 74 47
 radioscope table 74 48
 radiosonde 10 59
 radiosonde assembly 10 55
 radio station 238 1-6

radio switching centre
 control room 238 7-15
 radio system 6 26
 radio telephone 212 23
 radish 57 15
 radish, white ~ 57 16
 radius *Man* 17 13
 radius *Mills* 91 2
 radius *Maths.* 346 47
 radius of curvature 346 22
 radome *Aircraft* 231 18
 radome *Air Force* 256 10
 radome *Warships* 258 52, 77;
 259 49
 raffia 136 29
 raffle 306 11
 raft 283 60
 rafter 121 28, 36; 122 19
 rafter, common ~ 121 56
 rafter, principal ~ 121 55
 rafter end 121 45; 122 41
 rafter head 121 45; 122 41
 rafter roof 121 27
 rag bolt 143 43
 rag felt 122 62
 ragged robin 376 21
 rail *Atom* 2 37
 rail *Livestock* 75 16
 rail *Joiner* 133 41
 rail *Mach. Tools* 150 12
 rail *Railw.* 202 1
 rail *Station* 205 59; 206 38
 rail *Railw.* 214 10
 rail *Restaurant* 266 72
 rail *Equest.* 289 2
 rail *Birds* 359 20
 rail, triangular ~ 242 80
 rail bottom 202 4
 rail brake 206 48
 railcar 205 25
 railcar, articulated ~ 197 1,
 13
 railcar, front ~ 211 61
 railcar, light ~ 208 13
 railcar, short-distance ~ 208
 13
 railcar, six-axle ~ 197 13
 railcar, twelve-axle ~ 197 1
 rail clip 202 9
 rail foot 202 4
 rail guard 210 34
 rail head 202 2
 railing *Bldg. Site* 118 89
 railing *Park* 272 34
 rail joint 202 11
 railroad *see* railway
 railroad map 204 33
 railroad policeman 205 20
 railroad station 15 41
 railroad ticket 204 36
 railroad track 202; 203
 rail service, interurban ~ 197
 1
 rail service, urban ~ 197 13
 railway, funicular ~ 214 12
 railway, light ~ 200 23
 railway, main line ~ 15 21
 railway, narrow-gauge ~ *Map*
 15 90
 railway, narrow-gauge ~
Road Constr. 200 23

railway guide, official ~ 204
 50
 railway information clerk 204
 49
 railway line 202; 203
 railway map 204 33
 railway policeman 205 20
 railway siding 225 62
 railway station 15 41
 railway ticket 204 36
 railway vehicles 207; 208;
 209; 210; 211; 212; 213
 rail web 202 3
 rain 8 18; 9 32
 rainbow 7 4
 rainbow, colours of the ~ 343
 14
 rainbow dressing 221 85
 rain cape 41 4; 196 26
 rain cloud 8 10
 raincoat 29 31
 rain cover 10 41
 rain gauge 10 38, 44
 rainwater pipe 37 13; 38 10;
 122 29
 rain zone, temperate ~ 9 55
 rain zone, tropical ~ 9 53
 raisin 98 8
 raising of livestock 75
 raising to a power 345 1
 rake *Roof & Boilerr.* 38 42
 rake *Gdn. Tools* 56 4
 rake *Blacksm.* 137 4
 rake *Roulette* 275 5
 rake *Winter Sp.* 303 24
 rake, wire-tooth ~ 51 3; 56 3
 rake, wooden ~ 66 23
 raking back 118 61
 Ram *Astron.* 4 53
 ram *Dom. Anim.* 73 13
 ram *Blacksm.* 137 10
 ram *Forging* 139 12
 ram *Ship* 218 9
 ram *Theatre* 316 60
 ram, lower ~ 139 7
 ram, upper ~ 139 6
 rambler 52 5
 ram guide 139 8
 ram longwall face 144 36
 rammer 200 26
 rammer, pneumatic ~ 148 31
 ramp *Bldg. Site* 119 41
 ramp *Floor etc. Constr.* 123 30
 ramp *Station* 206 1
 ramp *Ship* 221 55
 ram piston 65 24
 ramson 377 6
 randing 136 1, 4
 randing, oblique ~ 136 3
 rangefinder 255 82
 rangefinder, optical ~ 258 37
 rangefinder window 114 40
 range light, higher ~ 224 102
 range light, lower ~ 224 101
 range lights 224 101-102
 range selector 114 59
 range switch 114 59
 rape 383 1
 rapelling 300 28-30
 rapid adjustment compass
 151 64

rapid feeding system 74 23
 rapid-filter plant 269 9
 rapid heat-up cathode 240 25
 rapid-loading system 115 25
 rapid scale 98 12
 rapid-veneer press 133 49
 rapping iron 136 36
 raptorial leg 358 5
 Raschel fabric 167 29
 rasp 260 55
 rasp, shoemaker's ~ 100 49
 raspberry 58 28; 370 101
 raspberry bush 58 25
 raspberry flower 58 26
 ratan chair cane 136 32
 rate-of-climb indicator 230
 14
 rate of interest 345 7
 rattan chair cane 136 32
 rattle *Infant Care etc.* 28 44
 rattle *Carnival* 306 40, 47
 rattle, baby's ~ 28 44
 rat trap binding 301 15
 Rautek grip 21 18
 ravine 13 52
 raw coal bunker 144 41
 raw material *Cement Wks.*
 160 1, 4
 raw material *Synth. Fibres*
 169 1-12
 raw material store 160 3
 raw meal silo 160 5
 raw milk pump 76 3
 raw milk storage tank 76 5
 raw mill 160 4, 7
 ray *Church* 332 37
 ray *Maths.* 346 20
 ray, medullary ~ 370 11
 ray, vascular ~ 370 11
 rays, sun's ~ 4 9
 razor, open ~ 106 38
 razor, straight ~ 106 38
 razor handle 106 39
 R-class 284 59
 reach, lower ~ 217 29
 reach, upper ~ 217 37
 reaching leg 285 24
 reactor 154 3, 41, 50
 reactor, nuclear ~ 1 48; 154
 19
 reactor building 154 20
 reactor core 259 68
 reactor pressure vessel 154 22
 reader 260 16
 reading adjustment 10 10
 reading lamp 43 15
 reading microscope 113 28
 reading room 262 13
 reading room staff 262 14
 readout, digital ~ 110 2; 112
 47
 readout, fast ~ 195 12
 ready position 305 72
 reamer 109 8; 140 31
 reamer, angled ~ 125 9
 rear brace 329 47
 rearing of livestock 75
 rear of the railcar 197 4
 rear seat headrest 193 8
 rear seat head restraint 193 8
 rearsight 255 22, 36

rear vault 297 32
 rear-view mirror 188 35; 189 30
 rear-view mirror, inside ~ 191 39
 rearward horizontal stand 295 31
 rearward swing 296 57
 rear window heating switch 191 82
 rebate plane 132 25
 receipt 98 44; 271 7
 receipt stamp 236 29
 receiver *Meteorol. Instr.* 10 63
 receiver *Hunt.* 87 16
 receiver *Docks* 226 33
 receiver *Audio* 241 40
 receiver *Office* 246 16
 receiver *Ball Games* 293 50
 receiver *Nightclub* 318 18
 receiver cord 237 14
 receiver surface, blackened ~ 155 29
 receiving hopper 147 5
 receiving table 249 54
 receiving tray 249 47
 receiving truck 226 15
 receptacle 370 53
 reception *Doc.* 22 5
 reception *Camping* 278 1
 reception hall 267 1-26
 receptionist, chief ~ 267 7
 recess 217 70
 reciprocal 344 16
 recirculation pump 154 43, 54
 record 46 15; 309 32; 317 24
 record changer, automatic ~ 241 52
 recorder *Meteorol. Instr.* 10 61
 recorder *Hosp.* 25 3
 recorder *Music. Instr.* 322 7
 recorder, eight-channel ~ 27 28
 recorder, open-reel-type ~ 241 56
 recorder, potentiometric ~ 23 55
 recording, photographic ~ 27 33
 recording amplifier 311 11
 recording and playback deck, single ~ 238 58
 recording and playback equipment 311 23
 recording arm 10 7, 12, 15, 21
 recording channel, central ~ 238 1-6
 recording drum 10 5, 16, 20
 recording engineer 310 23, 55; 311 36
 recording head *Cine Film* 117 33
 recording head *Audio* 241 59
 recording head *Films* 311 25
 recording instrument 10 61
 recording level control 117 16
 recording level display 243 15
 recording level indicator 243 12; 311 14

recording level meter 241 35, 36, 61; 242 14
 recording level meters 241 35-36
 recording loudspeaker 238 37
 recording mechanism 10 42
 recording meter 138 19
 recording paper 25 4; 27 29, 34, 40
 recording pen 10 13
 recording rain gauge 10 38
 recording room 238 16; 310 54
 recording room mixing console 238 25
 recording sensitivity selector 117 16
 recording space 177 49
 recording speaker 238 37
 recording tape 241 58
 record keeper 299 48
 record of posting book 236 18
 record player 241 18; 317 19
 record player base 241 19
 record player housing 241 19
 record rack 309 36
 record storage compartment 241 48
 record storage slot 241 48
 record turntable 238 24
 recovery parachute 235 60
 recovery vehicle, armoured ~ 255 93
 rectangle 346 34
 rectifier *Blacksm.* 138 30
 rectifier *Electrotyp. etc.* 178 2
 rectifier *Films* 312 18
 rector 330 22
 rectory 331 20
 rectoscope 23 16, 17
 rectoscopy 23 18
 rectum 20 22, 61
 rectus abdominis 18 44
 red 343 1
 red admiral 365 1
 red-billed toucan 363 6
 redbreast 361 15
 redcap 205 31
 red card 291 63
 red clover 69 1
 red deer 88 1, 1-27
 red flyer 366 3
 red fox 88 42; 367 12
 red kangaroo 366 3
 red magnolia 373 15
 redstart 360 3
 red swing filter 116 46
 reducing coupler 126 39, 41
 reducing elbow 126 49
 reducing socket 126 39, 41
 reducing valve 141 5
 reduction drive lever 149 3
 reduction gear *Paperm.* 172 69
 reduction gear *Aircraft* 232 59
 reduction gear *Warships* 259 61
 reduction gearing, multi-step ~ 64 71
 red underwing 365 8
 red whortleberry 377 23

red wine glass 45 83
 reed *Basketm.* 136 28
 reed *Weaving* 166 10
 reed *Music. Instr.* 326 41
 reed, double ~ 323 29
 reed mace 136 27
 reed mace bulrush 378 21
 reed organ 325 43
 reed pen 341 22
 reed pipe, metal ~ 326 17-22
 reed stop 326 17-22
 reed-threading draft 171 6
 reef 219 72
 reefer 221 127
 reel, fixed-spool ~ 89 32, 61
 reel, multiplying ~ 89 59
 reel, spring-tine ~ 64 4
 reel, stationary-drum ~ 89 61
 reel arm, foldaway ~ 117 92
 reel drum 312 16
 reel drum, fireproof ~ 312 25
 reel gearing 64 5
 reeling machine 173 41
 reel of film 312 33
 reel oven 97 71
 reels 89 59-64
 reel stand 180 3, 19
 referee 291 62; 293 67; 299 16, 41
 referee's position 299 8
 reference book 262 17
 reference library 262 17
 refill 151 46
 refill lead 151 46
 refiner 172 84
 refiner, conical ~ 172 27, 60, 73, 83
 refining bath 162 4
 reflected-light microscope 112 23
 reflecting goniometer 351 28
 reflector *Atom* 1 65
 reflector *Optic. Instr.* 113 1
 reflector *Bicycle* 187 45
 reflector, glass ~ 187 86
 reflector, swivel-mounted ~ 114 69
 reflector pedal 187 78
 reflex angle 346 10, 11-12
 reflex camera, twin-lens ~ 114 22
 reflex finder 117 44
 reflex mirror 115 33
 reflex system 115 31
 reformer 145 47
 reformer, catalytic ~ 145 71
 refractometer 111 44
 refractometer, dipping ~ 112 48
 refractor 113 16
 refreshment kiosk 205 49
 refreshment stall 308 3
 refrigeration system 93 11
 refrigerator 39 2; 46 33; 317 10
 refrigerator car 213 39
 refrigerator shelf 39 3
 refrigerator van 213 39
 refrigerator wagon 213 39
 refuse 199 17

refuse, compacted and decomposed ~ 199 22
 refuse collection vehicle 199 1
 refuse container 199 4
 refuse disposal 199
 refuse incineration unit 199 28
 regatta 283 1-18
 regatta course 285 14-24, 16
 register *School* 260 23
 register *Hotel* 267 8
 register *Music. Instr.* 322 51
 register device 177 12
 register mark 340 58
 registration form 267 12
 registration number *Election* 263 19
 registration number *Motorboats etc.* 286 7
 reglet 334 57
 regula 334 17
 regular crystal system 351 1-17
 regular customer 266 40
 regular grade gasoline 145 54
 regular grade petrol 145 54
 regulating handle 133 14
 regulating valve 38 75
 regulator 109 32
 regulator main valve 210 13
 regulator valve 210 13
 Regulidae 361 10
 rehearsal 215 21-27
 reheating 162 27, 35
 reichstaler 252 6
 rein 71 33; 186 31; 289 27; 303 4
 reindeer 353 16
 reindeer harness 353 15
 reinforced concrete construction 119 1-89
 reinforcement 119 54-76, 68
 reinforcement, projecting ~ 119 10, 71
 reinforcement, steel-bar ~ 123 37
 reinforcement beading 125 8
 reinforcement binding 119 66
 reinforcement rod 119 23
 reinforcing member, longitudinal ~ 230 47, 57
 reinforcing rib *Road Constr.* 200 9
 reinforcing rib *Hydr. Eng.* 217 78
 reinforcing steel 119 23
 reinforcing strut 315 31
 reins 71 25, 33
 rejects chest 172 59
 relay 186 43
 relay horse 186 43
 release *First Aid* 21 34
 release *Weaving* 165 35
 release, delayed-action ~ 309 51
 release binding 301 2
 release grip 21 34
 release lever *Slaughterho.* 94 6
 release lever *Office* 247 42
 release/lock lever 247 42

release phase 75 33
 release valve 210 58
 relief image carrier 340 2
 relief printing method 340 1-13
 relief tile, glazed ~ 333 20
 remainder 344 24
 remains 15 72
 Remington cartridge 305 39
 remittance 250 19
 remnant 103 16
 remote control jack 117 9
 remote control panel 157 14
 remote control radio 288 87
 remote control socket 117 9
 rendering, exterior ~ 122 38
 rendering coat 123 6
 'rendezvous point' 233 29
 rendezvous radar antenna 6 42
 reniform 370 38
 rennet vat 76 48
 repair bay 196 22
 repairer 161 19
 repair quay 222 10
 repair shop 196 22
 repeater 87 2
 repeaters 253 30-32
 repeating rifle 87 2
 repeat mark 321 26
 replenishing ship 258 97
 report 342 54
 reproducing head 241 59
 reptile enclosure 356 12
 reptiles 364 27-41
 requin 364 1
 re-recording 311 1-46
 re-reeler 173 41
 re-reeling machine 173 41
 rescue 21 18-23, 28-33, 34-38
 rescue cruiser 221 18; 228 14
 rescue helicopter 221 20; 228 16
 rescuer 21 29, 34
 research laboratory 310 9
 research microscope 112 1, 66
 research microscope, binocular ~ 23 51
 research rocket 7 24
 reserve fuel tank 212 60
 reserve tank 232 20
 reservoir *Hydr. Eng.* 217 39-46
 reservoir *Air Force* 257 16
 reservoir, impounded ~ 217 57
 reservoir rock 12 29
 reset button *Cine Film* 117 86
 reset button *Car* 191 77
 resetting button 127 20
 resetting spring 237 49
 residential area 15 28
 residue 145 43
 resin 323 11
 resin, synthetic ~ 130 26
 resistor 153 56
 resonating body 322 29; 323 3; 324 2, 15, 26
 resonating chamber 322 18; 324 15, 63
 resonating sound box 324 26

resonator 322 18, 29; 324 2, 15
 resonator, tubular metal ~ 324 78
 resonator wall 322 33
 respiration, artificial ~ 21 24-27
 respirator 21 27; 26 25
 respiratory apparatus 21 27; 26 24
 respiratory functions 23 31
 respiratory machine 26 1
 respiratory rate 23 27
 respond 335 35
 'restaurant' *Airport* 233 50
 restaurant 266 1-29
 restaurant car 207 22-32
 restaurant car, self-service ~ 207 73
 rest cure 274 12-14
 resting rail 322 42
 restoring spring 237 49
 restricted area 292 37
 rests 320 20-27
 result register 309 82
 results of sets 293 35
 resuscitation 21 24-27
 resuscitation, mouth-to-mouth ~ 21 26
 resuscitation, mouth-to-nose ~ 21 26
 resuscitation apparatus 21 27
 resuscitation equipment 270 20
 resuscitator 21 27; 270 20
 retailer 98 41
 retail shop 98 1-87
 retail store 98 1-87
 retaining plate 167 56
 retarder 206 48
 reticella lace 102 30
 reticule 115 61
 Reticulum 3 48
 retina 19 49
 retort 349 13
 retort ring 350 15
 retoucher 182 14
 retouching and stripping desk 177 19
 retrieving 86 36
 retrofocus position 115 84
 return 38 79
 return pipe 38 56, 79, 80; 126 24
 return spring *Knitting* 167 37
 return spring *Car* 192 55
 return tap 350 49
 Reuther board 296 12; 297 8
 rev counter 189 41; 191 38; 212 22; 230 8
 rev counter, electric ~ 191 70
 rev counter, electronic ~ 188 40
 reveal 37 26; 118 10; 120 31
 revenue stamp 107 26
 revers collar 30 9
 reverse 252 9
 reverse dive 282 41
 reverse gear 192 44
 reverse hang 296 34
 reverse shaft 149 34
 reversing catch 87 24

reversing clutch 115 27
 reversing gear 210 18; 211 53; 212 74
 reversing gears 65 41
 reversing ring 115 83
 reversing wheel 210 56
 revertive signal panel 153 7
 revetment 216 51-55
 revolution counter 189 41; 191 38; 212 22; 230 8
 revolution counter, electric ~ 191 70
 revolution counter, electronic ~ 188 40
 revolving die hammer 85 12
 reward 86 43
 rewind 114 6; 115 12
 rewind bench 238 59; 312 21
 rewind button 249 73
 rewind cam 115 29
 rewind crank 114 6; 115 12
 rewinder *Cine Film* 117 93
 rewinder *Paperm.* 173 41
 rewind handle *Photog.* 114 6; 115 12
 rewind handle *Cine Film* 117 93
 rewinding 170 50
 rewind release button 115 27
 rewind station 173 41
 rhesus macaque 368 12
 rhesus monkey 368 12
 rhinoceros 366 25
 Rhipoglossa 364 33
 rhizome 58 18
 rhizopod 357 1
 rhomb 346 35
 rhombic crystal system 351 23
 rhombohedron 351 22
 rhomboid 346 36
 rhombus 346 35
 rhubarb flan 97 22
 rhyncophore 358 4
 rib *Meat* 95 3
 rib *Floor etc. Constr.* 123 36
 rib *Basketm.* 136 24
 rib *Shipbuild.* 222 58
 rib *Aircraft* 230 46
 rib *Rowing* 283 49
 rib *Sailing* 285 51
 rib *Music. Instr.* 322 33; 323 4, 25
 rib *Art* 335 31
 rib *Bot.* 370 29
 rib, annular ~ 235 47
 rib, false ~ 287 36
 rib, flat ~ 95 21
 rib, fore ~ 95 18
 rib, main ~ *Space* 235 10
 rib, main ~ *Gliding* 287 35
 rib, middle ~ 95 19
 rib, prime ~ 95 18
 rib, top ~ 95 31
 ribbon 34 7; 355 78
 ribbon, corded ~ 35 13
 ribbon, fancy ~ 35 14
 ribbon cassette 249 16
 ribbon of glass 162 10
 ribbon selector 249 11
 ribbon window 37 86
 Ribes 58 1-15

ribgrass 380 11
 rib randing 136 2
 ribs, false ~ 17 10
 ribs, true ~ 17 9
 rib vault 336 43
 rib weave, combined ~ 171 19
 ribwort 380 11
 ribwort plantain 380 11
 rice *Arable Crops* 68 1; 68 29
 rice *Grocer* 98 38
 rice grain 68 30
 rickshaw 353 34
 rickshaw coolie 353 35
 rickstand 63 28, 29
 riddle 55 13
 ride *Map* 15 112
 ride *Forestry* 84 1
 rider *Cyc. Racing* 290 25
 rider *Chem.* 349 33
 rider bar 349 31
 rider holder 349 32
 ridge *Phys. Geog.* 12 36; 13 60
 ridge *Dwellings* 37 7
 ridge *Roof* 121 2; 122 93
 ridge *Mountain.* 300 21
 ridge, concave ~ 302 22
 ridge, hollow ~ 302 22
 ridge beam 121 48
 ridge board 121 48
 ridge capping piece 122 99
 ridge course 122 47, 79
 ridge course tile 122 4
 ridge cross 331 10
 ridge hook 122 65
 ridge joint 122 79
 ridge purlin 121 43
 ridge rope 221 118
 ridge tent 278 21; 280 45
 ridge tile 122 3, 8, 52
 ridge turret 121 14
 ridge vent 55 11
 ridging hoe 56 5
 riding animal 354 2
 riding cap 289 14
 riding seat 296 32
 riding switch 289 22
 riffer 172 2; 173 13
 rifle, self-loading ~ 255 16
 rifle, short ~ 86 30
 rifle, single-loading ~ 87 1
 rifle, triple-barrelled ~ 87 23
 rifle barrel 87 26
 rifle butt 255 24
 rifle cleaning kit 87 61-64
 rifle grip *Photog.* 115 100
 rifle grip *Films* 313 37
 riflescope 87 29; 305 49
 rifle shooting 305 26
 rifling 87 36
 rifling calibre 87 37
 rig 219 1-72
 Rigel 3 13
 rigging 219 1-72
 rigging, running ~ 219 67-71
 rigging, standing ~ 219 10-19
 right 254 18, 20, 22
 right angle 346 9, 32
 right corner pin 305 8
 right front second pin 305 4
 right hook 299 33
 right tank fuel gauge 230 17

rim *Bicycle* 187 28
 rim *Motorcycle* 189 25
 rim *Car* 191 16; 192 77
 rim brake 187 5
 rimfire cartridge 305 35
 rind 120 86; 370 8
 ring *Jewell.* 36 4
 ring *Forestry* 85 4
 ring *Fish Farm.* 89 56
 ring *Cotton Spin.* 164 51, 54
 ring *Sports* 299 35
 ring *Circus* 307 21
 ring *Bullfight. etc.* 319 9
 ring *Church* 332 17
 ring *Maths.* 346 57
 ring *Chem.* 350 15
 ring, all-round ~ 89 58
 ring, annual ~ 84 24
 ring, asymmetrical ~ 36 27
 ring, diamond ~ 36 23, 24
 ring, front ~ 113 7
 ring, gemstone ~ 36 15
 ring, man's ~ 36 20
 ring, rubber ~ *Kitch. Utensils* 40 26
 ring, rubber ~ *Bathing* 280 32
 ring, spring-steel ~ 89 51
 ring and bead sight, optical ~ 305 51
 ring attendant 307 27
 ring cake 97 33; 99 22
 ringed snake 364 38
 ring entrance 307 11
 ring fence 307 22
 ring file 260 15
 ring finger 19 67
 ring frame 164 34
 ring gauge 108 25, 27
 ring gemstones 36 72-77
 ringmaster 307 31
 ring net 90 25
 ring plectrum 324 27
 ring rail 164 42, 54
 ring-rounding tool 108 26
 rings 296 4
 ring sight, optical ~ 305 50
 ring snake 364 38
 ring spindle, standard ~ 164 45
 ring spinning frame 164 34
 ring tube *Cotton Spin.* 164 52
 ring tube *Weaving* 165 15
 riot duty 264 15
 riot gear 264 18
 riot shield 264 20
 rip panel 288 75, 83
 rip panel, emergency ~ 288 72
 ripper 200 20
 ripping line 288 76
 ripping line, emergency ~ 288 73
 ripple marks 13 41
 riprap 216 51
 rise adjustment 133 21
 rise adjustment wheel 133 22
 rise and fall adjustment wheel 132 60
 riser *Floor etc. Constr.* 123 33, 48
 riser *Iron Foundry etc.* 148 22
 riser *Water* 269 19

riser *Fire Brig.* 270 26
 riser *Airsports* 288 42
 riser *Sports* 305 55
 riser gate 148 22
 riser pipe 269 19
 rise to straddle 296 49
 rising 283 31
 Rising Sun 253 20
 ritual cart, miniature ~ 328 36
 ritual chariot, miniature ~ 328 36
 river *Phys. Geog.* 13 61
 river *Map* 15 76
 river *Rivers* 216 31
 river, navigable ~ 15 45
 river, subterranean ~ 13 83
 river arm 13 2; 216 3
 river arm, blind ~ 216 18
 riverbank 216 5
 riverbed 13 68
 river bend 13 11
 river branch 13 2; 216 3
 river branch, blind ~ 216 18
 river engineering 216
 river ferry 216 10
 river island 216 4
 river islet 216 4
 river mouth 13 1
 river nymph 272 2; 327 23
 river police 217 24
 rivers 216
 river terrace 13 49, 63
 river tree 216 23
 river valley 13 57-70
 rivet 143 57-60
 rivet head 143 57
 riveting 143 56
 riveting machine 138 27
 rivet shank 143 58
 riving hammer 85 5
 rivulet *Phys. Geog.* 13 8
 rivulet *Map* 15 80
 road 37 61
 road, bituminous ~ 200 55
 road, good ~ 15 30
 road, main ~ 15 83
 road, metallised ~ 15 30
 road, poor ~ 15 99
 road, secondary ~ 15 36
 road, unmetalled ~ 15 99
 road bridge 15 55
 road building 200; 201
 road-building machinery 200 1-54
 road coach 186 39
 road construction 200; 201
 road form 201 15
 road layers 198 1-5
 road making 200; 201
 road-metal spreading machine 200 31
 road over railway 15 22
 road race 290 8-10
 road race bicycle 290 16
 road racer 290 8
 road racing 290 16, 24-28
 road ripper 200 20
 road roller 200 36
 roadster *Bicycle* 187 1
 roadster *Car* 193 26
 road surface 215 8; 217 1

road sweeper 199 5; 268 20
 road-sweeping lorry 199 41
 roadway, orthotropic ~ 215 2
 road wheel 255 86
 roast 45 27
 roasting chicken 98 6
 roasting drum 98 71
 roasting round 95 11
 robe de chambre 355 66
 robes 330 22; 332 4
 robin 361 15
 robin redbreast 361 15
 robot 273 36
 rocaille 336 13
 rock 13 25; 327 38; 356 2
 rock, blasted ~ 158 4
 rock, coal-bearing ~ 144 49
 rock, impermeable ~ 12 23; 13 78
 rock, impervious ~ 12 23; 13 78
 rock, loose ~ 158 4
 rock, piece of ~ 6 15
 rock, sedimentary ~ 12 1; 13 48
 rock, stratified ~ 13 48
 rock bit 145 21
 rock climbing 300 2-13
 rocker *Child. Rm.* 47 16
 rocker *Winter Sp.* 302 19
 rocker *Music. Instr.* 326 39
 rocker *Graphic Art* 340 19
 rocker arm 190 33
 rocker arm mounting 190 34
 rocker switch 127 4
 rockery 37 40; 51 6
 rocket *Life-Sav.* 228 2
 rocket *Army* 255 26, 65
 rocket *Carnival* 306 54
 rocket, short-range ~ 259 26
 rocket apparatus 228 1
 rocket cruiser 259 21, 41
 rocket engine 6 3
 rocket engine, liquid-fuelled ~ 235 36
 rocket engine, main ~ 235 36
 rocket gun 228 1
 rocket launcher 255 64, 70
 rocket launcher, underwater ~ 259 37, 51
 rocket line 228 3
 rocket stage, first ~ 234 3
 rocket stage, second ~ 234 18
 rocket stage, third ~ 234 33
 rocket tube 255 71
 rock face *Phys. Geog.* 12 43; 13 28
 rock face *Quarry* 158 15
 rock face *Mountain.* 300 2
 rock garden 37 40; 51 6
 rock goat 367 7
 rocking chair 309 61
 rocking tool 340 19
 rock island 13 12
 rock ledge 300 4
 rock painting 328 9
 rock plant 51 7
 rock rose 377 20
 rock salt 351 2
 rockslide 11 46
 rock slip 11 46

rock spike 300 9
 rock terrace 13 47
 rock tomb 333 38
 rock wall 300 2
 rod, carbon-fibre ~ 89 57
 rod, glass ~ 89 49, 57
 rod, iron ~ 130 3
 rod, metal ~ 339 24
 rod, polished ~ 145 27
 rod, telescopic ~ 89 53
 rodents 366 12-19
 rodeo 319 34
 rodeo rider 319 39
 rod rest 89 23
 rods 89 49-58
 rod section 89 54
 rod tip 89 35
 roe *Game* 88 28-39
 roe *Fish Farm.* 89 12
 roe, female ~ 88 34
 roebuck 86 17; 88 28
 roe call 87 43
 roe deer 88 28-39
 roll *Kitch. Utensils* 40 31
 roll *Tablew. etc.* 45 21
 roll *Horse* 71 48
 roll *Supermkt.* 99 12
 roll *Athletics* 298 17
 roll, brown ~ 97 13
 roll, filled ~ 266 54
 roll, lower ~ 148 55
 roll, upper ~ 148 54
 roll, white ~ 97 14
 roll bar *Agr. Mach.* 65 21
 roll bar *Motorcycles etc.* 188 18
 roll bar *Car* 193 13
 roll bearing 148 60
 roll cutter 173 42
 roller *Hairdresser* 105 12
 roller *Cooper* 130 26
 roller *Glass Prod.* 162 11
 roller *Weaving* 165 57
 roller *Road Constr.* 200 37
 roller *Station* 206 39
 roller *Hydr. Eng.* 217 65
 roller *Office* 249 17
 roller *Cyc. Racing* 290 13
 roller *Graphic Art* 340 12
 roller *Birds* 359 25; 360 6
 roller, bottom ~ 164 10
 roller, fluted ~ 164 10
 roller, grooved ~ 130 30
 roller, lambskin ~ 130 31
 roller, leather ~ 340 23
 roller, lower ~ *Iron Foundry etc.* 148 55
 roller, lower ~ *Cotton Spin.* 164 10
 roller, rubber ~ 182 8
 roller, rubber-disc ~ 64 82
 roller, steel ~ 164 10
 roller, submersible ~ 217 68
 roller, three-wheeled ~ 200 36
 roller, top ~ 164 11
 roller, upper ~ *Iron Foundry etc.* 148 54
 roller, upper ~ *Cotton Spin.* 164 11
 roller, wire-covered ~ 168 34

roller bearing 164 47
roller bit 145 21
roller chain *Bicycle* 187 36
roller chain *Intern. Combust. Eng.* 190 25
roller chain, double ~ 190 10
roller covering 50 3
roller guide 201 4
roller path 148 50
roller postmark 236 60
roller printing machine, ten-colour ~ 168 53
rollers 148 54-55
roller stamp 236 46
roller table 157 23
roller top 217 66
roller trestle 157 26
rollfilm 114 19
rollfilm spool 114 20
roll holder 40 1
rolling 230 71
rolling circle 288 3
rolling dam 217 65-72
rolling mill 148 46-75
rolling plant 159 9
rolling road 138 16
rolling shutter frame 37 29
rolling stock 207; 208; 209; 210; 211; 212; 213
roll-on roll-off operation 225 39
roll-on roll-off ship 226 17
roll-on roll-off system 225 39
roll-on roll-off trailer ferry 221 54
rollover device 139 43
rolls *Bakery* 97 13-16
rolls *Iron Foundry etc.* 148 54-55
roll stand 148 56-60
roll unit 97 61
roll-up door 245 5
Roman 355 11
Roman woman 355 7
romper 29 21
romper suit 29 22
roof 37 5; 38; 121; 122; 337 2
roof, cement ~ 122 97
roof, flat ~ 37 77
roof, glass ~ 55 5
roof, hipped ~ 37 64; 121 10, 60
roof, imperial ~ 121 25
roof, mission-tiled ~ 122 56
roof, pantiled ~ 122 53
roof, paper ~ 122 90
roof, pitched ~ 38 12
roof, plain-tiled ~ 122 50
roof, sliding ~ 193 24; 194 10; 213 22
roof, snow-covered ~ 304 20
roof, Spanish-tiled ~ 122 56
roof, split-tiled ~ 122 45
roof, swivelling ~ 213 26, 27
roof, tiled ~ 122 1
roof beam 121 29
roof board 122 61
roof boarding 122 61
roof cable 211 5
roof cladding 38 1
roof course 122 78
roof covering 38 1
roofer 122
roof guard 38 8
roof hook 38 6
roofing, cement ~ 122 90-103
roofing, paper ~ 122 90-103
roofing felt 122 62
roofing nail 143 55
roofing paper 122 62
roof ladder 38 4; 122 63
roof lashing 278 51
roof opening 213 23
roof rack 278 50
roofs, styles and parts of ~ 121 1-26
roof sheathing 122 61
roof structures of timber 121 27-83
roof trestle 122 66
roof truss 120 7; 121 78
roof valley 121 15; 122 11, 82
roof ventilator 278 56
rook *Games* 276 12
rook *Birds* 361 2
room, double ~ 267 27-38
room, heated ~ 169 24
room divider 42 19
room key 267 9
room number 267 10
room telephone 267 34
room thermostat 38 78
room trader 251 6
room waiter 267 33
rooster 62 37; 73 21
root *Man* 19 36
root *Plant Propagn.* 54 21
root *Arable Crops* 68 17, 45
root *Horse* 72 34
root *Maths.* 347 12
root *Bot.* 370 16-18
root *Industr. Plants* 383 43
root, adventitious ~ 370 78, 80
root, aerial ~ 370 80
root, primary ~ 370 16
root, secondary ~ 370 17
root, tuberous ~ 370 79
root crops 68 38-45
rooter 200 20
root gall 80 27
root hair 68 18; 370 18
root louse 80 26
roots 54 12; 370 78-82
rootstock 54 33
root thorn 370 81
rope *First Aid* 21 30
rope *Weaving* 166 61
rope *Swim.* 282 32
rope *Gymn.* 296 19; 297 43
rope *Mountain.* 300 12, 22-27
roped party 300 22-27
rope ladder 221 91; 273 49; 307 8
rope-pulley hoist 118 91
ropes 299 36
rope sling 300 11
ropeway, aerial ~ 15 67
ropeway, double-cable ~ 214 25, 30
ropeway gondola 214 52
ropeways 214 15-38

ropeways, endless ~ 214 15-24
ropeways, single-cable ~ 214 15-24
ropeway support 214 76
roping down 300 28-30
ro-ro depot 226 20
ro-ro-ship 226 17
ro-ro system 225 39
ro-ro trailer ferry 221 54
rosary 332 30
rose *Market Gdn.* 55 28
rose *Game* 88 5, 29
rose *Music. Instr.* 324 5
rose, bush ~ 52 13
rose, climbing ~ 52 12
rose, double ~ 60 17
rose, ivory ~ 36 29
rose, rambling ~ 52 12
rose, standard ~ 51 25; 52 21
rosebay 373 13
rosebud 60 16
rose cut 36 45
rose-ear 70 2
rose hip 370 100
rose laurel 373 13
rose thorn 60 18
rose tree, standard ~ 52 13, 21
rosette 306 34
rose window 335 23
rosin 323 11
rostrum 263 6; 316 34
rotary engine, two-rotor ~ 190 5
rotary-table machine 150 41
rotary-table shot-blasting machine 148 39
rotary turbine pump 259 57
rotated grasp 296 44, 46
rotation 298 18
rotation axis 351 4
rotator 224 55
rotisserie 40 32
rotogravure press, multicolour ~ *Photograv.* 182 24
rotor *Clocks* 110 32
rotor *Intern. Combust. Eng.* 190 68
rotor *Aircraft* 232 22
rotor *Gliding* 287 18
rotor, main ~ 232 12-13; 256 19; 264 3
rotor, tail ~ 256 20
rotor, tilting ~ 232 32
rotor blade *Energy Sources* 155 45
rotor blade *Aircraft* 232 12
rotor head 232 13
rotor pylon 232 23
rouge 275 24
rough 293 80
rough focusing indicator 224 35
roughing file 134 9
roughing-out hammer 195 46
roughing wheel 111 36
roulette *Roulette* 275 1-33, 28
roulette *Graphic Art* 340 18
roulette ball 275 33
roulette bowl 275 29

roulette layout 275 9, 17
roulette player 275 15
roulette table 275 8
roulette wheel 275 10, 28
round 95 14
round, caseless ~ 305 37
roundabout 308 2
round bar reinforcement 119 80
round-bilge boat 286 32-34
round end 95 52
rounding machine *Bakery* 97 63
rounding machine *Plumb.* 125 30
roundwood 120 35; 157 30
round worm 81 31
route 203 68
route indicator 203 20, 21
route lever 203 58
route of the paper 180 26
route of the sheets 180 33
route of the web 180 26
router plane 132 26
route sign 197 21
route straight ahead 203 45, 49, 50
rowing 164 29
roving bobbin 164 23
row 312 9
rowan 371 22
rowboats 283 9-15
rowing 283
rowing boat 89 27
rowing boat, Germanic ~ 218 1-6
rowing boats 283 9-15
rowing coach 283 20
rowlock 278 18; 283 29, 41
row of needles 167 27
row of needles, back ~ 167 46
row of needles, front ~ 167 47
row of seats, tiered ~ 261 1
royal 88 8
Royal Crown, English ~ 254 42
royal fern 377 16
royal osmund 377 16
royal stay 219 13
royal water lily 378 17
rubber, synthetic ~ 164 11
rubber belt, studded ~ 64 79
rubber plant 383 33
rubber solution 340 49
rubber tree 383 33
rubber tyre cable car 273 53
rubber tyre swing 273 18
rubbing strake, reinforced ~ 258 81
rubbish 268 22
rubble 11 47
rubble, rough ~ 269 37
ruby 175 22
ruby, synthetic ~ 110 33
Rückpositiv 326 5, 42
rucksack 283 65
rudder *Ship* 218 6, 24; 221 43
rudder *Shipbuild.* 222 69
rudder *Ship* 223 63
rudder *Life-Sav.* 228 26
rudder *Aircraft* 229 25; 230 60

rudder *Air Force* 257 23
rudder *Rowing* 283 51-53, 53
rudder *Sailing* 284 9, 34; 285 34
rudder *Motorboats etc.* 286 65
rudder *Airsports* 288 22
rudder, retractable ~ 285 37
rudder, vertical ~ 259 95, 96
rudder angle indicator 224 17
rudder blade 221 43; 222 69; 223 63; 283 53; 284 34
rudderhead 284 33
rudder pedal 230 27; 257 10
rudder pedal, co-pilot's ~ 230 28
rudder post 222 70
rudder stock 222 68; 284 33
ruff *Carnival* 306 20
ruff *Hist. Cost.* 355 52
rugby 292 19
rugby ball 292 21
rugby football 292 19
rule 151 33
rule, folding ~ 120 76; 134 33
rule, glazier's ~ 124 21
rule of three sum 345 8-10
rule pocket 33 49
ruler 151 33; 247 35
ruling pen 151 49
ruling pen attachment 151 58, 61
rum 98 57
ruminant 73 1
ruminants 366 28-30; 367 1-10
rummer 45 87
rump *Horse* 72 31
rump *Game* 88 20, 36
rump *Meat* 95 14, 35
rump piece 329 88
runch 61 18
rune 341 19
rung 38 17; 50 38
runner *Plant Propagn.* 54 14, 16
runner *Soft Fruit* 58 20
runner *Mills* 91 22
runner *Iron Foundry etc.* 148 21
runner *Rowing* 283 45
runner *Ball Games* 292 45, 66
runner *Athletics* 298 5
runner, movable ~ 303 10
runner, outrigger ~ 302 46
runner bean 52 28; 57 8
runner gate 148 21
running 298 1-8
running axle 210 35
running-boar target 305 33
running dog 334 39
running gear, front ~ 191 52
running head 185 66
running light 258 56
running light, side ~ 258 15
running light indicator panel 224 29
running posture 295 2
running side 277 5
running step 295 41
running step indicator 211 36

running take-off twist dive 282 43
running three 305 3, 5
running title 185 66
running track 298 6
running wheel 64 41, 56; 214 7, 70
runout 147 54
runway *Hunt.* 86 16
runway *Airport* 233 1
runway *Gliding* 287 15
rush *Phys. Geog.* 13 17
rush *Basketm.* 136 27
rusk 97 54
Russula vesca 381 23
rustication 335 51
rustic work 335 51
rutting mane 88 27
rutting season 86 9-12
rye 68 1, 2
rye bread 97 10, 49
rye-bread roll 97 16
rye flour 97 52
ryegrass, perennial ~ 69 26

S

sabaton 329 55
saber see sabre
sable *Ladies' Wear* 30 60
sable *Heraldry* 254 26
sable *Mammals* 367 15
sabat 101 47
sabre, light ~ 294 20, 34
sabre fencer 294 19
sabre fencing 294 19-24
sabre gauntlet 294 21
sabre glove 294 21
sabre mask 294 22
sabreur 294 19
sack 38 34
sacker 92 39
Sacrament 331 48
sacarium 330 32
sacristan 330 26, 58
sacristy 331 13
sacristy door 330 17
sacrum 17 21; 20 59
saddle *Phys. Geog.* 12 16, 42
saddle *Mach. Tools* 149 13
saddle, adjustable ~ 188 4
saddle, English ~ 71 45-49
saddle, reciprocating ~ 185 24
saddle, unsprung ~ 290 17
saddle, western ~ 71 37-44
saddle apron 149 16
saddleback roof 37 5; 121 1
saddle bag 187 25
saddle clip 126 53
saddle-pad 71 17, 31
saddle roof 37 5; 121 1
saddles 71 37-49
saddle seat 71 37
saddle spring 187 23
saddle stitching 31 45
saddle tree 374 1
safe 246 22
safelight 116 21
safety bar 301 58
safety binding 301 2

safety bonnet 85 36
 safety brake 85 15
 safety catch *Atom* 2 40
 safety catch *Household* 50 25
 safety catch *Hunt* 87 8, 24
 safety catch *Army* 255 14
 safety catch, sliding ~ 87 25
 safety chain 126 3
 safety current 127 2
 safety curtain 316 24
 safety device 290 13
 safety equipment 316 18
 safety glass 124 5
 safety glasses 140 21
 safety helmet 84 23; 120 13;
 140 22; 158 10; 300 53
 safety helmet, shock-
 resisting ~ 127 48
 safety hood 85 36
 safety jet 301 53
 safety key 140 48
 safety latch 50 25
 safety lighting 312 6
 safety lock 140 44
 safety net *Warships* 259 18
 safety net *Circus* 307 14
 safety nut 187 64
 safety pin 328 27
 safety rail 119 43
 safety valve *Roof & Boilerr.*
 38 70
 safety valve *Railw.* 210 3
 safety wall 122 35
 saffron milk cap 381 29
 sagger 161 2
 sagger 161 2
 Sagittarius 3 37; 4 61
 sagittate 370 37
 sago 98 39
 sago palm 383 58
 sail 219 1-72; 283 62; 284 2;
 285 8
 sail, ballooning ~ 285 4
 sail, brailed-up ~ 218 21
 sail, fore-and-aft ~ 220 15
 sail, furled ~ 218 21
 sail, square ~ 218 21, 33; 219
 55-66; 220 16
 sail axle 91 5
 sailboat *Playground* 273 29
 sailboat *Camping* 278 12
 sailboat *Sailing* 284 10-48
 sailboat, single-masted ~ 220
 6-8
 sailboats, mizzen-masted ~
 220 9-10
 sailboats, two-masted ~ 220
 11-17
 sailing 284; 285
 sailing barge, ketch-rigged ~
 220 9
 sailing boat *Playground* 273
 29
 sailing boat *Camping* 278 12
 sailing boat *Sailing* 284 10-48
 sailing boat, single-masted ~
 220 6-8
 sailing boats, mizzen-masted
 ~ 220 9-10
 sailing boats, two-masted ~
 220 11-17

sailing close-hauled 285 10
 sailing downwind 285 1
 sailing ship 219; 220
 sailing ships, development of
 ~ 220 35-37
 sailing ships, four-masted ~
 220 28-31
 sailing vessels, three-masted
 ~ 220 18-27
 sailing with free wind 285 12
 sailing with wind abeam 285
 11
 sailor suit 309 62
 sailplane 287 3
 sailplane, high-performance
 ~ 287 9
 sails, fore-and-aft ~ 219
 20-31
 sail shapes 220 1-5
 sail top 91 6
 sainfoin 69 10
 saint, Buddhist ~ 337 10
 Saint Andrew's cross bond
 118 65
 salad 266 51
 salad bowl 45 23
 salad chicory 57 40
 salad cream 96 29
 salad drawer 39 4
 salad fork 45 68
 salad oil 98 24; 99 66
 salad plants 57 36-40
 salad servers 45 24
 salad spoon 45 67
 salamander 364 22
 salamanders 364 20-22
 sal-ammoniac block 125 6
 sales area 99 4
 sales check 98 44; 271 7
 salesclerk 98 13
 sales counter 271 42, 61
 salesgirl 97 1; 98 31; 99 17;
 271 18, 63
 saleslady 97 1; 98 31; 99 17;
 271 18, 63
 salesman 309 29
 sales premises 111 1-19
 sales shelf 99 23
 sales statistics 248 46
 salicional 326 23-30
 salientians 364 23-26
 salina *Map* 15 32
 salina *Spa* 274 1-7
 sallow 371 24
 salon, men's ~ 106 1-42
 salon mirror 105 20; 106 6
 saloon, lower ~ 194 37
 saloon, upper ~ 194 38
 saloon car 193 4, 25
 salt 98 40
 salt, common ~ 1 9
 salta 276 20
 salta piece 276 21
 salt cake storage tank 172 36
 salt cellar 266 77
 salt mine 154 57-68, 72
 saltstick 97 31
 salt water outlet 145 33
 salt water pipe 145 33
 salt water tank 146 17
 salt works *Map* 15 32

salt works *Spa* 274 1-7
 salt works attendant 274 5
 saltzstange 97 31
 salvage 227
 salvage tug 227 5, 16
 salvaging 227 1
 Salvator beer 93 26
 salving 227 1
 sampan 353 31
 sample beam 115 36
 sample sagger 161 2
 sample scoop 98 72
 samson post 223 35
 samson post, ventilator-type
 ~ 221 58
 samurai 353 37
 sanctuary 330 32
 sanctuary lamp 330 49
 sanctus bell 330 46
 sand *Map* 15 6
 sand *Bldg. Site* 118 36; 119 26
 sandal 101 51
 sandal, ladies' ~ 101 49
 sandal court shoe 101 27
 sandbag 216 50; 288 65
 sandbank 227 3
 sand bed 123 8
 sand belt, endless ~ 133 15
 sand box *Railw.* 212 59, 76
 sandbox *Playground* 273 64
 sandcastle 280 35
 sand delivery pipe 148 38
 sand deposit 216 52
 sand dome 210 14
 sander 129 30
 sander, orbital ~ 134 53
 sander, single-belt ~ 133 30
 sander control 211 32
 sander switch 211 32
 sandhill 273 66
 sand hills 15 6
 sanding 129 28
 sanding attachment, orbital
 134 53
 sanding belt, endless ~ 133 15
 sanding belt regulator 133 14
 sanding disc 134 25
 sanding dust extractor 133 28
 sanding machine, single-belt
 ~ 133 30
 sanding table 133 35
 sanding valve 210 55
 sanding wheel 133 27
 sand lizard 364 27
 sandpaper 128 14; 129 25;
 135 25
 sandpaper block 128 13; 129
 26
 sand pipe 210 15, 19
 sandpit 273 64
 sand star 369 11
 sand table 173 13
 sand track racing 290 24-28
 sand trap *Paperm.* 173 13
 sand trap *Ball Games* 293 81
 sand tube 210 15
 sandwich 45 39
 sandwich, open ~ 45 37; 266
 75
 sandwich board 308 50
 sandwich man 308 49

sanitary articles 99 35
 San-José scale 80 35
 Sanserif 342 7
 Sanserif type 342 7
 Sanskrit 341 9
 sap 120 85; 370 12
 sappho 363 4
 sapwood 120 85; 370 12
 sarcophagus 335 53
 sardine server 45 78
 sardines in oil 98 19
 Sargon's Palace 333 29
 sartorius 18 45
 Satan's mushroom 379 12
 satchel 260 9
 sate 137 34
 satellite 4 45
 satellite radio link 237 51-52
 satellite sounding 7 33
 satin stitch 102 10
 Saturn 4 49
 Saturn V 234 1, 2
 sauceboat 45 17
 sauce ladle 45 18
 saucepan 40 16
 saucer 44 30
 sauna, mixed ~ 281 18
 sauna stove 281 21
 sausage 98 4; 99 54
 sausage, beef ~ 96 11
 sausage, pork ~ 96 11; 99 55
 sausage, scalded ~ 96 8
 sausage filler 96 49
 sausage fork 96 44
 sausage meat 96 41, 52
 sausages 96 6-11
 sausages, manufacture of ~
 96 31-59
 sausage stuffer 96 49
 sausage tongs 308 35
 savings account 250 4
 savoy 57 33
 savoy cabbage 57 33
 saw, butcher's ~ 94 19
 saw, circular ~ 119 19; 125
 24; 134 50
 saw, free-cutting ~ 84 32
 saw, two-handed ~ 120 68
 saw, vertical frame ~ 157 2
 sawbill 359 15
 saw blade 120 62; 150 16; 157
 3, 47; 260 54
 saw carriage 132 71; 133 38
 saw chain 84 35; 85 14; 85 15;
 120 16
 saw frame 138 25; 150 17;
 157 8
 saw guide 85 16
 saw handle 132 4
 sawing shed 120 3
 sawmill 144 6; 157 1
 saw rasp 134 6
 saw set 132 42
 saw-sharpening machine 157
 42
 saw tooth 96 33
 sawtooth roof 121 20
 saxboard 283 43
 saxifrage, rotundifoliate ~
 375 1
 saxophone 324 69

scaffold 118 25; 122 34; 222
 18
 scaffold, steel ~ 5 18
 scaffold, supporting ~ 14 50
 scaffold, tubular steel ~ 119
 46
 scaffold board 122 70
 scaffolding 215 62
 scaffolding, tubular steel ~
 119 46
 scaffolding joint 118 30
 scaffold pole 118 23
 scaffold standard 118 23
 scalding colander 96 45
 scale *Map* 14 29
 scale *Chem.* 349 35
 scale *Fish etc.* 364 11
 scale *Decid. Trees* 371 12
 scale *Conifers* 372 34, 42, 45,
 50
 scale, triangular ~ 151 34
 scale, wax ~ 77 25
 scale adjustment 116 34
 scale armour 329 64
 scaled prickle fungus 381 24
 scale insect 80 35
 scale louse 80 35
 scale pan *Kitch. Utensils* 40 37
 scale pan *Chem.* 349 36
 Scales *Astron.* 3 19; 4 59
 scales *Doc.* 22 66
 scales *Kitch. Utensils* 40 35
 scales *Child. Rm.* 47 33
 scales *Supermkt.* 99 88
 scales *Photog.* 114 58
 scales *Music. Not.* 320 45-49
 scaling hammer 137 38
 scallop shell 309 46
 scalp 352 15
 scalpel 26 43
 scalper 340 7
 scaly ant-eater 366 10
 scanner 177 39
 scanner film 177 72
 scanning drum 177 45
 scanning head 177 46, 63
 scanning zone 243 47
 scantling 120 10
 scape 370 52
 scapula 16 23; 17 7
 scar 11 48
 scarecrow 52 27
 scarf *Ladies' Wear* 31 57
 scarf *Men's Wear* 33 65
 scarf *Headgear* 35 16
 scarf *Bullfight. etc.* 319 38
 scarf joint, oblique ~ 121 88
 scarf joint, simple ~ 121 87
 scarifier 200 20
 scarlet pimpernel 61 27
 scarlet runner 52 28; 57 8
 scarlet runner bean 57 8
 scarp 13 57
 scatter cushion 42 27; 46 17
 scauper 340 7
 scaur 11 48
 scaw 11 48
 scene *Theatre* 316 36
 scene *Art* 334 45
 scene number 310 35
 scene painter 315 35

scene-repeat key 243 42
 scenery 316 35
 scenery projector 316 17
 scene shifter 315 28; 316 46
 scenic artist 315 35
 scenic railway 308 39
 scent, artificial ~ 289 49
 sceptre, fool's ~ 306 59
 schalmeyes 322 14
 schedule 204 16
 schedule, engineer's ~ 210 52
 Scheidt globe 349 1
 schilling 252 13
 schizocarp 370 94
 schnauzer 70 35
 schnorkel *Warships* 259 72,
 90
 schnorkel *Swim.* 279 11
 schnorkel *Bathing* 280 39
 school 260; 261
 school bag 260 7
 school book 47 25
 school children's wear 29
 31-47
 school figure 289 7
 school horse 289 3
 school satchel 260 9
 schooner, four-masted ~ 220
 28
 schooner, three-masted ~ 220
 18
 schooner, topsail ~ 220 11-13
 Schottel propeller 227 20
 Schwellwerk 326 45
 scion 54 37
 scion bud 54 23, 34
 scissor-blade 106 35
 scissor jump 295 39; 298 22
 scissors *Shoem.* 100 43
 scissors *School* 260 49
 scissors *Gymn.* 296 51
 scissors *Athletics* 298 22
 scissors, angled ~ 22 51
 scissors, bull-nosed ~ 128 34
 scissors, curved ~ 26 42
 scissors movement 296 51
 scoop *Doc.* 22 50
 scoop *Hosp.* 26 52
 scoop *Graphic Art* 340 8
 scoop thermometer 92 53
 scooter 188 47
 scooters 188
 scoreboard 293 34, 70
 scorer 293 71
 scoring equipment, electrical
 ~ 294 25-33
 scoring equipment, electronic
 ~ 294 32
 scoring light 294 28
 scorper 340 7
 Scorpio 3 38; 4 60
 Scorpion *Astron.* 3 38; 4 60
 scorpion *Articulates* 358 40
 scorzonera 57 35
 Scots pine 372 20
 Scottish terrier 70 17
 scouring machine, open-
 width ~ 168 8
 scouring nozzle 216 62
 scouring tunnel 217 62
 scouring wheel 100 6

scout 278 11
 scout camp 278 8-11
 scrag 95 6
 scrag end 95 6
 scramble racing 290 24-28
 scrambling motorcycle 189 16
 scrap box 141 15
 scraper *Butch.* 96 42
 scraper *Paperhanger* 128 10
 scraper *Painter* 129 23
 scraper *Graphic Art* 340 63
 scraper, pointed ~ 140 63
 scraper, triangle ~ 140 63
 scraper adjustment 340 62
 scraper and burnisher 340 17
 scraper blade 200 17
 scraper floor, movable ~ 62 24
 scrap iron charging box 147 26
 scrap iron feed 147 65
 scray entry, curved ~ 168 47
 scree 11 47; 12 45; 13 29
 screech owl 362 17
 screech 123 41
 screeding beam 201 14
 screeding board 201 14
 scree ledge 300 4
 screen *Hunt.* 86 9
 screen *Fish Farm.* 89 10
 screen *Bldg. Site* 118 85
 screen *Paperm.* 172 57
 screen *Refuse Coll.* 199 11
 screen *Post* 236 40
 screen *Inf. Tech.* 242 84
 screen *Swim.* 281 17
 screen *Films* 310 16, 51; 312 11
 screen, all-matt ~ 115 58, 59, 60, 65
 screen, centrifugal ~ 172 22, 56
 screen, crystal glass ~ 179 24
 screen, fluorescent ~ 74 40
 screen, ground glass ~ 112 24; 115 58, 59, 60, 61, 65, 66; 177 2, 34
 screen, illuminated ~ 177 20; 264 30
 screen, inner ~ 240 20
 screen, lead ~ 259 70
 screen, magnetic ~ 240 20
 screen, matt ~ *Optic. Instr.* 112 24
 screen, matt ~ *Photog.* 115 61, 66
 screen, protective ~ 154 74
 screen, rotary ~ 172 2
 screen, secondary ~ 172 58
 screen, vibrating ~ 158 21
 screen curtain 312 10
 screen frame, mobile ~ 168 60
 screen holder, hinged ~ 177 3
 screening 156 14
 screening, inner ~ 240 20
 screening, magnetic ~ 240 20
 screenings 158 22
 screen magazine 177 9
 screen printing 168 59
 screen printing operator 168 65

screen table 168 63
 screen work 136 4
 screw *First Aid* 21 16
 screw *Metalwkr.* 140 4
 screw *Weaving* 165 36
 screw *Life-Sav.* 228 26
 screw, cheese-head ~ 143 36
 screw, cross-head ~ 143 26
 screw, feathering ~ 224 19
 screw, hexagonal socket head ~ 143 27
 screw, main ~ 148 62
 screw, self-tapping ~ 143 26
 screw, ship's ~ 221 44; 222 72; 223 62
 screw, slotted ~ 143 36
 screw, three-blade ~ 223 62
 screw-back 277 4
 screw base 127 59
 screw block 136 8
 screw clamp 120 66
 screw conveyor 92 26
 screw-cutting machine 125 27; 126 86
 screw die 140 61
 screw dive 282 44
 screwdriver 109 6; 126 69; 127 46; 134 4; 140 62
 screwdriver, cross-point ~ 134 5
 screw gate 300 47
 screw groove 143 38
 screw joint 126 42
 screw log 224 54
 screw post 222 71
 screws 143 13-50
 screw slit 143 38
 screw slot 143 38
 screw tap 140 60
 screw thread 50 50
 screw wrench 126 67
 scrim 183 33; 185 20
 scrim roll holder 185 19
 script *Films* 310 45
 script *Script* 341; 342
 script, cuneiform ~ 341 8
 script, director's ~ 316 44
 script, Latin ~ 342 12
 script, producer's ~ 316 44
 script, Sinaitic ~ 341 13
 script, uncial ~ 341 17
 script girl 310 39
 scripts 341 1-20
 Scriptures 330 11
 scroll *Music. Instr.* 323 17
 scroll *Art* 333 26; 334 23
 scroll, Vitruvian ~ 334 39
 scroll-opening roller 168 13
 scrollwork 336 8
 scrotum 20 71
 scrubber 156 22, 23, 24
 scrubbing agent 156 37
 scrubbing brush 50 56
 scrubbing oil tank 156 43
 scrub board 123 21, 63
 scrum 292 20
 scrummage 292 20
 scuba 279 19
 scull 283 17, 35-38
 sculptor 339 1
 sculpture 339 32

sculpture, modern ~ 272 64
 scut 88 19, 62
 scutcher, double ~ 163 14
 scutcher lap 163 47
 scutcher lap holder 163 48
 scutch grass 61 30
 scutellum 82 5; 358 30
 scythe 66 12
 scythe blade 66 13
 scythe sheath 66 18
 scythestone 66 19
 sea 13 26; 14 19-26
 sea, epeiric ~ 14 26
 sea, epicontinental ~ 14 26
 sea, marginal ~ 14 26
 sea, open ~ 227 4
 sea anemone 369 20
 sea bear 367 18
 seabirds 359 11-14
 sea calf 367 19
 sea couch grass 61 30
 sea cucumber 369 18
 sea deity 327 23
 sea divinity 327 23
 sea dog 367 19
 sea fan 369 8
 sea feather 369 14
 sea fishing 90
 Sea Goat 3 36; 4 62
 sea goddess 327 23
 sea grass 378 54
 sea hedgehog 357 39; 369 19
 sea horse 364 18
 seakale beet 57 28
 seal 190 69
 seal, clay ~ 269 39
 seal, loam ~ 269 39
 sea ladder 221 91
 sea lead 89 92
 sea level 11 11
 sea lily 369 3
 sealing tape 126 75
 seals 367 18-22
 seam 144 29
 sea maid 327 23
 sea maiden 327 23
 seaman 327 23
 sea marks 224 68-108
 seam binding 103 14; 104 19
 seamless engraving adjustment 177 53
 sea monster 327 47
 seam roller 128 36
 sea nymph 327 23
 sea otter 367 17
 sea ox 327 47
 sea pen 369 14
 seaplane 232 1, 5
 seaquake 11 53
 search 264 31
 searchlight 258 28
 Sea Serpent 3 16
 seaside pleasure boat 221 15
 sea star 357 38; 369 17
 sea strait 14 24
 seat *Man* 16 40
 seat 24 24; 41 10; 44 11; 65 22; 71 45; 212 63; 271 35; 273 58; 283 28; 303 6; 307 15; 312 9; 315 20
 seat *Mach. Parts etc.* 143 65

seat, back ~ 193 22
 seat, captain's ~ 235 17
 seat, child's ~ 187 21
 seat, circular ~ 281 38
 seat, coachman's ~ 186 8
 seat, commander's ~ 235 17
 seat, conical ~ 143 67
 seat, co-pilot's ~ 230 37; 235 18
 seat,cox's ~ 283 27
 seat, double ~ 197 19; 207 63
 seat, driver's ~ 186 8; 191 34; 210 59
 seat, engineer's ~ 210 59
 seat, fireman's ~ 210 39
 seat, folding ~ 193 22; 207 12
 seat, instructor's ~ 257 7
 seat, observer's ~ 257 7
 seat, pilot's ~ 230 36; 235 18; 257 6
 seat, rear ~ 191 31
 seat, reclining ~ 191 34; 207 44, 64
 seat, single ~ 197 17; 207 62
 seat, sliding ~ 283 41-50, 44
 seat, student pilot's ~ 257 6
 seat, upholstered ~ 207 44; 208 25; 265 10
 seat cushion 42 23
 seated position 296 31
 seating 330 28
 seating group 42 21-26
 seat pillar 187 24
 seat stay 187 19
 seat stick 86 10
 seat tube 187 18
 seat upholstery 207 65
 sea urchin 357 39; 369 19
 seawater desalination plant 146 25
 sea wave, seismic ~ 11 53
 sea wing 232 3
 secant 346 50
 secateurs 56 50; 78 12
 second 299 44
 secondary 153 16
 secondary school 261
 second base 292 43
 second-class seating arrangement 211 58
 second-class section 207 10; 208 22
 seconde engagement 294 50
 second-hand stall 308 60
 second indicator 110 21
 second man 300 26
 second-stage separation retro-rocket 234 37
 seconds timer 129 39
 secretary 209 27
 secretary, proprietor's ~ 248 31
 section *Forestry* 84 2
 section *Drawing Off.* 151 28
 section *Bookbind.* 183 12
 section *Railw.* 203 29
 section, hollow ~ 215 5
 section, middle ~ 215 68
 section, tubular ~ 215 5
 section line *Map* 15 112
 section line *Forestry* 84 1

section line *Drawing Off.* 151 27
 section mark 342 36
 section of warp rib fabric 171 14
 sections 143
 sections, conic ~ 347 11-29
 sector 346 54
 securities 251 11-19
 security 251 1-10
 security, fixed-income ~ 251 11-19
 security, unlisted ~ 251 5
 security drawer 236 22
 sedan 193 4, 25
 sedge *Phys. Geog.* 13 17
 sedge *Indoor Plants* 53 17
 sedilia 330 41
 sediment *Phys. Geog.* 13 69
 sediment *Doc.* 23 50
 sediment filter, stainless steel ~ 79 8
 seed *Plant Propagn.* 54 3
 seed *Soft Fruit* 58 23
 seed *Drapes & Nuts* 59 8
 seed *Agr.* 63 12
 seed *Arable Crops* 68 13, 15, 25
 seed *Bot.* 370 86
 seed *Decid. Trees* 371 20, 65
 seed *Conifers* 372 9, 10, 15, 28, 37, 54, 57, 60, 71
 seed *Flowers etc.* 375 25, 28
 seed *Alp. Plants etc.* 378 33, 34
 seed *Trop. Plants* 382 20, 34, 35, 39, 45
 seed *Industr. Plants* 383 15, 23, 24, 57
 seed *South. Fruits* 384 10, 20, 21, 47, 52, 58
 seed, foraminifera ~ 383 57
 seed, oleiferous ~ 383 5
 seedbed preparation 63 31-41
 seed capsule 61 5
 seed corn 63 12
 seed-dressing machine 83 52
 seed dusting 83 52
 seed fish 89 13
 seed-harrow, combination ~ *Agr.* 63 41
 seed-harrow, combination ~ *Agr. Mach.* 65 87
 seed hopper 65 75
 seed leaf 370 87
 seedling *Plant Propagn.* 54 6
 seedling *Market Gdn.* 55 23
 seedling *Forestry* 84 7, 9
 seedling box 55 51
 seedling nursery 84 6
 seedling plant 54 6
 seedlip 63 11
 seed lobe 370 87
 seed pan 54 2
 seed pike 89 11
 seed potato 68 39
 seed sowing 54 1
 seed tuber 68 39
 seed vessel 57 6; 378 5; 383 8
 seed vessel, circumscissile ~ 370 95
 seesaw 273 35; 307 59

Seeger cone 161 6
 seggar 161 2
 segment *Maths.* 346 52
 segment *Invertebr.* 357 25
 segment disc shutter 313 8
 seismograph, horizontal ~ 11 39
 seismology 11 32-38
 seismometer 11 39
 seizing 90 5
 selector 237 42
 selector, electronic ~ 237 42
 selector fork 192 42, 45
 selector head 192 44
 selector motor 237 48
 self-discharge freight car 213 24
 self-discharge wagon 213 24
 self-feeder 74 13
 self-heal 376 16
 self-rescue 21 33
 self-service restaurant 266 45-78
 self-service station 196 1-29
 self-threading guide 165 18
 self-time lever 115 15
 self-timer 115 15
 selvage 166 11; 171 20, 24
 selvage shaft 171 22
 selvage thread draft 171 20
 semaphore arm 203 2
 semaphore arm, supplementary ~ 203 8
 semaphore signal 203 1, 7, 12
 semibold 175 3
 semibreve 320 13
 semibreve rest 320 21
 semicircle 346 46
 semicolon 342 19
 semidome 334 73
 semiquaver 320 17
 semiquaver rest 320 25
 semitone 320 50, 52
 semi-trailer *Lorries etc.* 194 30-33
 semi-trailer *Station* 206 59
 semolina 98 36
 sending-off 291 61
 senna 380 16
 senna leaf 380 16
 sensing element 10 22
 sepal 58 8, 44; 59 12; 370 58
 separating funnel 349 3
 separating layer 7 10
 separating rail 164 30
 separation plant 199 31
 separation rocket motor, aft ~ 235 62
 separation rocket motor, forward ~ 235 60
 separator *Bldg. Site* 119 81
 separator *Offshore Drill.* 146 28
 separator *Cotton Spin.* 164 43
 separator *Paperm.* 172 31
 separator *Roulette* 275 30
 separator, centralized ~ 172 15
 septimole 321 23
 septolet 321 23
 septum 77 43

septum, interventricular ~ 20
52
septum, ventricular ~ 20 52
septuplet 321 23
sequester forceps 26 45
sequoia 372 69
seraglio, Sultan's ~ 306 41
serial number *Stock Exch.*
251 13
serial number *Money* 252 36
series, arithmetical ~ 345 11
series, geometrical ~ 345 12
series, inner ~ 375 32
series, outer ~ 375 31
series of moulds 147 36
Serpens 3 20
Serpent *Astron.* 3 20
serpent *Gymn.* 297 48
serpent *Music. Instr.* 322 13
serpent, nine-headed ~ 327
33
serpent, paper ~ 308 14
serrate 370 44
serratus anterior 18 42
serrulate 370 44
server *Ball Games* 293 51, 62
server *Church* 330 40
service 293 42
service area 293 61
service bell panel 267 28
service bridge 217 72
service building 154 36
service bunker 156 3
service counter 250 4
service court 293 12
service girder, adjustable ~
119 78
service line 293 6-7
service line judge 293 27
service module 6 2
service module main engine
234 57
service pistol 264 22
service riser 126 7
service room 329 27
service station 196 1-29
service tray 105 31
service vehicle 233 22
servicing craft 258 93
serviette 45 9; 266 47
serviette ring 45 10
serving, jute ~ 153 49
serving area 207 79
serving cutlery 45 69-70
serving fork 45 70
serving hatch 266 66
serving spoon 45 74, 75
serving trolley 45 32
servo-actuating mechanism
257 22, 23
servo cylinder 192 50
servo unit 192 50
sesame plant 383 45
sesquiplane 229 13
set *Plant Propagn.* 54 20
set *Blacksm.* 137 34
set *Composing Rm.* 175 48
set *Ball Games* 293 37
set *Maths.* 348 1, 3
set collar 143 33
set designer 310 43; 315 37

set hammer 137 33
set head 143 57
set of rolls 148 54-55
set piece 315 30; 316 47
sets 348
set screw 127 21
set square 151 7
set square, adjustable ~ 151 4
set square, steel ~ 108 28
sett 137 34
settee 42 24
setting 54 18
setting and hatching machine
74 28
setting lever 115 15
setting lotion 106 23
setting rule 174 14
setting stick 174 13
set trigger 87 12
set trigger, second ~ 87 11
Seven Sisters 3 26
seventh chord 321 5
sewer, combined ~ 198 27
sewing 183 8, 34
sewing cord 183 10
sewing frame 183 9
sewing machine *Dressm.* 103
8
sewing machine *Tailor* 104 12
sewing machine *Bookbind.*
185 16
sewing machine cotton 103 12
sewing machine drawer 104
18
sewing machine table 104 17
sewing machine thread 103
12
sewing mechanism 133 5
sewing needle 185 21
sewing silk 104 10
sewing thread 183 11
sex organs, female ~ 20 79-88
sex organs, male ~ 20 66-77
sextant 224 1
sextolet 321 23
sexton 330 26, 58
sextuplet 321 23
sgraffito 338 41
shading panel 55 9
shadow 34 17
shadow mask 240 17
shadow mask mount,
temperature-compensated
~ 240 22
shadow roll 289 30
shaft *Farm Bldgs.* 62 20
shaft *Agr. Mach.* 64 59
shaft *Mach. Parts etc.* 143 61
shaft *Nucl. Energy* 154 69
shaft *Cotton Spin.* 164 42
shaft *Weaving* 166 4
shaft *Carriages* 186 19, 30
shaft *Aircraft* 232 56
shaft *Rowing* 283 37
shaft *Ball Games* 291 26
shaft *Sports* 305 64
shaft *Art* 333 27
shaft, intermediate ~ 232 57
shaft, main ~ *Coal* 144 24
shaft, main ~ *Car* 192 40
shaft alley 223 66

shaft bossing 223 59
shaft chain 71 20
shaft furnace 147 1
shaft guide 166 3
shaft strut 223 61
shaft tunnel 223 66
shag *Tobacc. etc.* 107 25
shag *Birds* 359 10
shake 321 17, 18
shaker 324 59
shallot 326 18
shallows 224 87, 97
shaman 353 24
shampoo 106 20
shampoo basin 105 29; 106 12
shampoo bottle 105 32
shampooing head 50 79
shampoo spray 105 30; 106 13
shampoo unit 105 28; 106 11
shank *Man* 16 52
shank *Meat* 95 14, 33
shank *Shoem.* 100 68
shank *Metalwkr.* 140 33
shank *Mach. Parts etc.* 143 15,
53
shaper 150 45
shapes game 48 19
shaping, final ~ 162 28, 36
shaping hammer 108 40
shaping machine *Dairy.* 76 35
shaping machine *Mach. Tools*
150 45
shaping pad 104 23
shard 161 21
share *Agr. Mach.* 65 7, 58, 65
share *Stock Exch.* 251 11-19
share, chisel-shaped ~ 65 58
share, diamond-shaped ~ 65
58
share, pointed ~ 65 65
share, three-bladed ~ 64 67
share certificate 251 11
share register 251 14
share warrant 251 11
shark 364 1
sharp 320 50
sharpie 284 53
shave 136 39
shave, clean ~ 34 25
shaver, electric ~ 49 37
shaving 120 80
shaving cream 99 33
shavings 132 40; 135 26
shawl 31 71
shawm 322 14
shawm, double ~ 322 3
shearing train 148 74, 75
shears 128 34
shears, tinner's ~ 125 1
sheatfish 364 12
sheath *Arable Crops* 68 9
sheath *Forestry* 84 30
sheath, lead ~ 153 39, 47
sheath, leather ~ 283 ps
sheathfish 364 12
sheathing paper 122 62
shed 166 40
shedding tappet 166 57
shed roof 37 78; 121 7
sheep 73 13
sheepdog 70 25

sheep pen 75 9
sheer 259 23
sheer strike 222 44
sheet *Household* 50 5
sheet *Offset Print.* 180 17, 47
sheet *Ship* 219 68
sheet *Office* 249 57
sheet *Fire Brig.* 270 18
sheet *Gymn.* 297 11
sheet, blank ~ 180 69; 181 23,
30
sheet, corrugated ~ 122 98
sheet, linen ~ 43 9
sheet, plastic ~ 76 28
sheet, printed ~ 180 55, 57;
181 25
sheet, single ~ 340 27
sheet, unprinted ~ 180 69;
181 23, 30
sheet cloud 8 3, 4, 8, 9, 10
sheet counter 181 54
sheet delivery 249 54
sheet feeder 180 31, 48, 68,
74; 181 24; 184 16; 185 25
sheet feeder, automatic ~ 181
5
sheet-feeding station 184 16
sheet glass 124 5
sheet glass production 162
1-20
sheeting support 119 86
sheet metal 128 17
sheet-metal screw 143 26
sheet of glass 162 10
sheet of stamps 236 21
sheet pile 119 17
sheet pile bulkhead 217 5
sheet pile wall 119 17; 217 5
sheet piling 119 17; 217 5
sheet shears 125 26
sheet zinc 122 14
shelf 44 19; 98 14; 100 36; 195
14; 271 27
shelf, continental ~ 11 8
shelf, revolving ~ 39 28
shelf, steel ~ 262 12
shelf, wall-mounted ~ 248 40
shelf for bottles 266 10; 267
64; 317 4
shelf for glasses 266 9; 267
65; 317 5
shelf unit 46 1
shell *Cooper* 130 23
shell *Shipbuild.* 222 44-49
shell *Rowing* 283 33, 48
shell *Ball Games* 293 33
shell *Invertebr.* 357 29
shell *Fish etc.* 364 29
shell, soft ~ 59 42
shell, steel ~ 154 21
shell bit 135 16
shell bossing 223 59
shell membrane 74 60
shell plating 222 44-49
shells 283 9-15
shelter 223 17
shelving 248 28
shepherd bird 361 4
shepherd's club 376 9
shepherd's purse 61 9
shepherd's weatherglass 61 27

sherd 161 21
sherry glass 45 84
shield *Game* 88 55
shield *Plumb. etc.* 126 33
shield *Ship* 218 17
shield *Heraldry* 254 5
shield *Ethnol.* 354 10
shield, concrete ~ 154 20
shield, concrete and lead ~ 1
57
shield, protective ~ 2 46
shield, round ~ 329 57
shield, sliding ~ 2 32
shield budding 54 30
shielding, protective ~ 2 46
shielding-gas supply 142 34
shielding wall, lead ~ 2 46
shield volcano 11 13
shifting spanner 126 68
shift key 249 3
shift lock 249 5
shift pattern 192 47
shikara 337 26
shin 95 22, 28
shinbone 17 25
shingle 34 34
shin guard 142 12; 291 34
shin pad 292 9; 302 33
ship, five-masted ~ 220 35
ship, four-masted ~ 220 31
ship, full-rigged ~ 220 24-27,
31, 35
ship, stranded ~ 228 10
shipbuilding 222
shipbuilding sheds 222 3-4
shipbuilding yard 222 1-43
'ship cleared through
customs' 253 36
ship-drawing office 222 2
ship fix 224 45
ship of the line 218 51-60
shipper 206 28
shipping traffic radio
telephone 224 28
ship run aground 227 2
ship under construction 222
30
shipyard 222 1-43
shirt 30 26; 291 56
shirt, casual ~ 32 38; 33 37
shirt, check ~ 33 50
shirt, knitted ~ 33 36
shirt, short-sleeved ~ 33 33
shirt-blouse 30 40
shirt button 33 34
shirts, men's ~ 32 38-47
shirt top 30 45
shirtwaist 319 23
shirt-waister dress 30 10
Shiva 337 19
shoals 224 87, 97
shoat 75 42
shock absorber *Moon L.* 6 32
shock absorber *Car* 191 26;
192 69
shock absorber *Railw.* 207 4
shock absorber, telescopic ~
188 41; 189 23
shock treatment 25 26
shock wave 11 35

shoe *Mills* 91 14
shoe *Bldg. Site* 119 50
shoe, bast ~ 122 75
shoe, copped ~ 355 42
shoe, finished ~ 100 1
shoe, hemp ~ 122 75
shoe, high-heeled ~ 101 35
shoe, laced ~ 101 31
shoe, peaked ~ 355 42
shoe, piked ~ 355 42
shoe, repaired ~ 100 1
shoe, slater's ~ 122 75
shoe brake 143 97
shoe brush 50 41
shoe buckle 101 52
shoe care utensils 50 39-43
shoelace 100 64
shoemaker 100
shoe polish 50 39, 43
shoes 41 16; 101
shoe sieve 64 19
shoe spray 50 40
shoot 54 37; 370 19-25
shoot, female ~ 372 46, 48
shoot, long ~ 78 3
shoot, male ~ 372 44, 49, 56
shoot, short ~ 372 23, 31
shooting *Hunt.* 86 47-52
shooting *Films* 310 14-60,
26-60
shooting, exterior ~ 310 18
shooting, outdoor ~ 310 18
shooting box 305 78
shooting brake 193 15
shooting gallery 308 58
shooting positions 305 27-29
shooting range 305 74
shooting script 310 45
shooting seat 86 10
shooting star 7 25
shooting station 305 78
shooting stick 86 10
shop 195
shop, goldsmith's ~ 215 33
shop assistant 97 1; 98 13, 31;
99 17; 271 18
shop front 268 42
shopkeeper 98 41
shopper 50 87
shopping bag 98 45; 99 3; 268
19
shopping trolley 50 87; 99 1
shop shelf 47 36
shop sign 268 39
shop walker 271 33
shop window 268 10
shop window decoration 268
12
shop window display 268 11
shorthand 342 13
shorthand pad 245 29; 248 32
shorthand writing 342 13
short measure 294 10
short/medium haul airliner
231 4; 231 11
short run 184 1; 249 59
shorts 33 25; 291 57
shorts, children's ~ 29 25
shorts, ladies' ~ 31 39
shorts, leather ~ 29 32
short standing 75 22

short stop 292 42
short wave 7 26
short-wave station 237 54
short-wave therapy apparatus 23 22, 39
shot Athletics 298 49
shot Sports 305 52
shote 75 42
shot firer 158 25
shotgun, over-and-under ~ 87 33
shot number 310 35
shot put 298 48
shoulder Phys. Geog. 12 41
shoulder Man 16 22
shoulder Horse 72 18
shoulder Game 88 17, 38
shoulder Meat 95 5, 9
shoulder Composing Rm. 175 40
shoulder balance 295 29
shoulderblade 16 23; 17 7
shoulder button 31 15
shoulder cape 355 39
shoulder girdle 17 6-7
shoulder guard 142 5
shoulder iron 38 33
shoulder landing 298 12
shoulder rest 255 9, 31, 39
shoulder stand 295 29
shoulder strap 260 11
shoulder strap, frilled ~ 29 14
shovel 55 14; 137 2; 200 1; 255 77
shovel, mechanical ~ 118 81
shovel, wooden ~ 91 24
shovel bucket 118 82
show booth 308 6
showcase 271 13
shower Meteorol. 8 19
shower Meteorol. etc. 9 37
shower Life-Sav. 228 30
shower Swim. 282 2
shower, lukewarm ~ 281 29
shower adjustment rail 49 43
shower attachment, extendible ~ 126 30
shower base 49 44
shower bath 282 2
shower cubicle 49 39
shower curtain 49 40
shower head, adjustable ~ 49 41
shower nozzle 49 42
'showers' 233 46
show jumping 289 8-14
showman 308 10
show people, travelling ~ 308 25-28
shredding 169 6
shrew 366 7
shrew mouse 366 7
shrimp 369 12
shrine 337 21
shrine, Buddhist ~ 337 21
shrink foil 76 25
shrink ring 130 24
shrink-sealing machine 76 24
shroud 219 16; 284 18
shrub, anemophilous ~ 59 44-51
shrub, ornamental ~ 272 14
shrub, wind-pollinating ~ 59 44-51
shrub bed 55 37
shrubs, ornamental ~ 373; 374
shuck 68 33
shunter 206 43
shunting engine 206 43
shunting locomotive 206 43
shutter Market Gdn. 55 9
shutter Mills 91 4
shutter, folding ~ 37 30
shutter, louvred ~ 212 84
shutter, rolling ~ 37 28
shutter, side ~ 119 55
shutter board 118 41; 119 18, 76
shutter catch 37 31
shuttering 119 54-76; 123 10
shuttering, bottom ~ 119 54
shuttering board 119 76
shuttering strut 119 13
shutter opening 304 12
shutter release 114 12, 31; 115 18; 117 6; 313 24, 38
shutter release button 114 12; 115 18
shutter speed control 114 35; 115 19
shutter speed setting knob 115 19
shutter weir 217 65-72
shuttle Needlewk. 102 20
shuttle Weaving 166 9, 26
shuttle Ball Games 293 44
shuttle box 166 9
shuttlecock 273 7; 293 44
shuttlecock game 273 6
shuttle eye 166 29
shuttle tip, metal ~ 166 25
sickle 56 8
side Man 16 32
side Optic. 111 13
side Joiner 132 23
side Weaves 171 32
side Billiards 277 5
side Ari 336 40
side Maths. 346 26, 27
side, subordinate ~ 252 9
side, woven ~ 136 18
side batten 222 62
side blackboard 260 35
sideboard Dining Rm. 44 20
sideboard Tablew. etc. 45 44
side board Farm Bldgs. 62 25
sideboards 34 24
sideburns 34 24
sidecar 290 30
sidecar body 189 54
sidecar combination 290 29
sidecar crash bar 189 55
sidecar machine 189 53
sidecar wheel 189 57
sidecar windscreen 189 58
sidecar windshield 189 58
side cast, two-handed ~ 89 32
side ceiling 222 62
side comb 105 6
side control 180 5, 20
side drum 323 51

side elevation 207 1, 22-25, 37, 60, 74
side flat 310 33
side frame 165 12; 167 20
side girder, longitudinal ~ 222 52
side grafting 54 36
side grip 134 45
side horse 296 5
side joint 111 14
side lay control 180 5, 20
sidelight 189 56; 191 20; 223 15
sidelight, green ~ 286 11
sidelight, headlight, and parking light switch 191 62
sidelight, port ~ 286 12
sidelight, red ~ 286 12
sidelight, starboard ~ 286 11
sideline 292 17; 293 2 bis 3, 4 bis 5; 293 55
side margin control 180 5, 20
sidemarker lamp 189 56; 191 20
side note 185 68
side of pork 94 23
side panel, removable ~ 188 48
side parting 315 1
side planking 62 25
side pocket 33 12
siderostat 5 16
side rudder 218 6
side shoot 370 21
sideshow 308 24
side slit 30 49
side split 295 14
side stake 206 24
side stay 284 18
sidestep 301 27
sidestepping 299 29
side stop 200 34, 44
side straddle 295 3
side stroke 222 45
side stringer 222 50
side stroke 282 36
side support Shipbuild. 222 40
side support Free Exerc. 295 25
side thrust kick 299 19
side trappings 71 16
side view 207 1, 22-25, 37, 60, 74
sidewalk 37 60; 198 9
sidewall Electrotyp. etc. 178 45
sidewall Railw. 213 29
side wall Music. Instr. 323 4, 25
side-whiskers 34 24
side window blower 191 61
siding 206 50
Siemens-Martin open-hearth furnace 147 21-30
sieve Market Gdn. 55 13
sieve Graphic Art 340 24
sieve, louvred-type ~ 64 17
sieve, reciprocating ~ 64 19
sieve, upright ~ 55 13
sieve extension 64 18
sifter 91 26

sight 87 65; 255 45
sight, front ~ 87 71; 255 3, 23, 37; 305 42
sight, optical ~ 305 41
sight, telescopic ~ 87 29; 255 28; 305 49
sight graticule 87 31-32
sighting mechanism 255 45
sighting notch Hunt. 87 66
sighting notch Army 255 22
sight scale division 87 68
sign, chequered ~ 203 30
sign, illuminated ~ 203 38
signal 205 42
signal, distant ~ 203 7-24
signal, main ~ 203 1, 1-6
signal, visual ~ 238 30
signal and radar mast 221 7
signal arm 203 2
signal box 15 24
signal box, electrically-operated ~ 203 61
signal box, manually-operated ~ 203 53
signal element 243 60
signal flags 253 22-34
signal generator 313 30
signalling see signalling
signal knob 203 62
signal lever 203 56
signal light Power Plant 153 3
signal light Cotton Spin. 164 8
signal light Railw. 212 15
signal light Ship 221 125
signalling equipment 203
signalling lamp 223 7
signalling mast 225 34
signal mast Map 14 51
signal mast Docks 225 34
signal position 203 4, 5, 10, 11
signals, supplementary ~ 203 25-44
signal stay 223 11
signal tower 14 51
signal tower, electrically-operated ~ 203 61
signal tower, manually-operated ~ 203 53
signal track 243 59
signature Bookbind. 183 12; 185 69
signature Stock Exch. 251 15, 16
signature, cross-folded ~ 185 15
signature, parallel-folded ~ 185 13
signature code 185 69
signboard 118 45
signet ring 36 40
sign for day running 203 36
sign for night running 203 38
sign of parallelism 345 21
sign of similarity 345 22
signs, conventional ~ 15 1-114
signs, zodiacal ~ 4 53-64
signs of the zodiac 4 53-64
signwriting brush 129 41
sikar 337 26
sikhara 337 26

silencer 191 29; 209 12; 22, 24; 211 49; 305 93
silhouette 25 39
silicon atom 1 14
siliqua Weeds 61 20, 23
siliqua Bot. 370 93
siliqua Alp. Plants etc. 378 33
siliqua South. Fruits 384 46
siliqua, mature ~ 383 4
siliqua, ripe ~ 383 4
silk-cotton tree 383 20
silk moth 358 48
silk taffeta 35 36
silkworm 358 50
sill Phys. Geog. 11 31
sill Car 193 21
sill rail 120 56
silo 225 68
silo, above-ground ~ 62 11
silo, polythene ~ 62 43
silo cylinder 225 69
silo pipe 62 12
silver 254 25
silver-disc pyrheliometer 10 23
silver fir 372 1
silverfish 81 14
silverleaf 371 23
silver owl 362 17
silver poplar 371 23
silverside 95 34
silversmith 108
sima 11 4
simple interest formula 345 7
simsim 383 45
Sinanthropus 261 18
sine 346 32
singer 315 22, 23
single, clinker-built ~ 283 18
single-hand control 185 7
single-loader 87 1
singles 293 4-5
single sculler 283 16
single-shot rifle 305 35
singles match 293 4-5
singles sideline 293 4-5
single-system recording 117 8
singlet 296 61
single-trip bottle 93 29
sinister 254 19, 21, 23
sink Phys. Geog. 11 49; 13 71
sink Kitch. 39 35
sink Forestry 84 28
sink Bakery 97 68
sink Coal 144 47
sink Energy Sources 155 16
sink School 261 6, 34
sink Camping 278 6
sinker Sea Fish. 90 10
sinker Knitting 167 58
sinker Navig. 224 73
sinker, oval ~ 89 88
sinkhole 11 49; 13 71
sink unit 39 33-36
Sinningia 53 7
sinter terraces 11 23
sinuate 370 48
sinus, frontal ~ 17 55
sinus, sphenoidal ~ 17 54
siphon barometer 10 1
siphon tube 10 43

siren Ship 223 3
siren Fabul. Creat. 327 58
siren, ship's ~ 224 32
sirenian 366 23
Sirius 3 14
sirloin 95 17; 96 4
sisal 35 13
siskin 361 8
site fence 118 44
site hut 118 48; 119 44
site of battle 15 93
site office 118 48
sit harness 300 57
situla, sheet-bronze ~ 328 34
Siva 337 19
six-day race 290 2-7
six-day racer 290 2
six-eight time 320 34
six-four time 320 35
sixte engagement 294 48
sixteenth note 320 17
sixteenth rest 320 25
six-to-pica 175 19
sixty-fourth note 320 19
sixty-fourth rest 320 27
size 128 4
size press 173 24
sizing 162 53
sizing and edging machine 132 57
sizing machine 165 52
skateboard 273 51
skate guard 302 25
skate sailing 302 27-28
skate sailor 302 27
skeeet 305 70-78
skeeet choke 305 71
skeeet shooting 305 70-78
skeg 279 3; 286 61
skeletal 194 30-33
skeleton Man 17 1-29
skeleton School 261 14
skeleton Winter Sp. 303 22
skeleton, siliceous ~ 357 8
skeleton construction 119 1
skeleton rider 303 23
skeleton toboggan 303 22
skeleton tobogganing 303 22-24
skep 77 52
sketch for costume 315 40
sketch pad 338 35
skew notch 120 54
skew notch, double ~ 121 91
skew notch, single ~ 121 90
ski, compact ~ 301 1
ski, modern ~ 301 46
ski bag 301 28
ski bob 304 16
ski cap 35 39; 301 10
skid chain 304 10
skidder 85 34
skidder, short-haul ~ 85 27
skife knife 100 51
skiff 283 16
skiing 301 1-72
skiing boot, cemented sole ~ 301 12
skiing cap 35 39; 301 10
skiing goggles 301 11
ski jumping 301 35

ski jumping boot 301 41
 ski jumping ski 301 38
 ski lift 301 57-63, 59
 skim couler 65 11
 skimmer 96 43
 skimmer, stepped ~ 286 38-41
 skimmer rod 148 17
 skimmers 286 38-44
 skim milk tank 76 17
 skin *Shipbuild.* 222 44-49
 skin *School* 261 9
 skin *Gliding* 287 40
 skin, light alloy ~ 235 11
 skin, outer ~ *Rowing* 283 33, 48
 skin, outer ~ *Ball Games* 293 33
 skin diver 279 7
 skin diving 279 7-27
 skip *Road Constr.* 200 25
 skip *Railw.* 213 38; 214 34
 skip *Gymn.* 297 42, 45
 skip hoist *Iron & Steel* 147 3
 skip hoist *Road Constr.* 200 14
 ski pole 301 5
 skipping 273 15
 skipping rope 273 16; 297 43
 skip rope 273 16
 skip-winding system 144 25
 skirt *Child. Clothes* 29 52
 skirt *Ladies' Wear* 31 3, 24
 skirt *Army* 255 85
 skirt *Motorboats etc.* 286 66
 skirt *Airports* 288 48
 skirt, aft ~ 235 63
 skirt, girl's ~ 29 46
 skirt, grass ~ 306 18
 skirt, inverted pleat ~ 30 51
 skirt, loden ~ 30 67
 skirt, long ~ 30 45
 skirt, pleated ~ 30 32
 skirt, wrap-around ~ 31 13
 skirt, wrapover ~ 31 13
 skirting 123 21
 skirting board 123 21, 63
 skirt suit 31 1
 skirt suit, girl's ~ 29 50
 ski stick 301 5
 ski stop 301 56
 ski suit, ladies' ~ 301 9
 ski suit, one-piece ~ 301 9
 skittle frame 305 1-11
 skittles 305 1-13
 skiing knife 100 51
 ski wax 301 21
 ski-waxing equipment 301 21-24
 skull *Man* 17 1, 30-41
 skull *School* 261 15, 17, 19, 21
 skull *Rowing* 283 35-38
 skull *Chivalry* 329 39
 skull, Australopithecine ~ 261 20
 sky 3 1-8
 sky, northern ~ 3 1-35
 sky, southern ~ 3 36-48
 sky blue 343 6
 skylight 38 2, 121 8, 122 12
 skysail 220 32
 slab 120 96

slab, reinforced concrete ~ 123 28
 slab, stone ~ 51 17; 331 61
 slab, wooden ~ 324 62
 slab cake 97 34; 99 21
 slacks 29 49
 slacks, lightweight ~ 31 52
 slack suit 30 57
 slade 65 6, 66
 slag escape 147 9
 slag ladle 147 10
 slag spout 148 12
 slalom 301 29, 64
 slalom canoe 283 4
 slalom ski 286 60
 slant track 243 31
 slapstick 306 48
 slat 229 53
 slat, extensible ~ 229 38
 slate *Roof* 122 85
 slate 309 72
 slate hammer 122 73
 slater *House Insects etc.* 81 6
 slater *Roof* 122 71
 slate roof 122 61-89
 slath 136 21
 slating batten 122 17
 slaughterer 94 1
 slaughterhouse *Slaughterho.* 94
 slaughterhouse *Bullfight, etc.* 319 13
 slaughterman 94 1
 slave, female ~ 306 41
 slave driver 218 47
 slave galley 218 44-50
 slave station 224 41
 sled 303 1, 2
 sled dog 353 2
 sledge 303 1, 2
 sledge dog 353 2
 sledge hammer 137 22; 158 6
 sleeper *Bldg. Site* 119 39
 sleeper *Station* 205 60
 sleeper *Railw.* 207 36
 sleeper, concrete ~ 202 37
 sleeper, coupled ~ 202 14, 38
 sleeper, steel ~ *Railw.* 202 36
 sleeper, steel ~ *Hvdr. Eng.* 217 3
 sleeper and strampler 29 23
 sleeping bag *Infant Care etc.* 28 17
 sleeping bag *Camping* 278 30
 sleeping car 207 36
 sleeping doll 47 11
 sleeve 30 15
 sleeve, batwing ~ 31 16
 sleeve, braided ~ 186 24
 sleeve, daged ~ 355 46
 sleeve, full ~ 355 60
 sleeve, gallooned ~ 186 24
 sleeve, kimono ~ 30 36
 sleeve, petal-scalloped ~ 355 46
 sleeve, protective ~ 142 6
 sleeve, puffed ~ 31 27; 355 49, 60
 sleeve, sliding ~ 192 32, 35
 sleeve, turned-up ~ 31 62
 sleeve, turnover ~ 30 6

sleeve, turn-up ~ 30 6
 sleeve board 50 20
 sleeve protector 324 17
 sleigh, horse-drawn ~ 304 25
 sleigh bell 304 26
 slender funnel fungus 381 25
 slewing crab 222 21
 slew turntable 200 22
 sley 166 41, 53
 sley cap 166 6
 slice *Bakery* 97 43
 slice *Blacksm.* 137 2
 slice, sugared ~ 97 43
 slicer 96 31
 slicker 81 14
 slide *Inf. Tech.* 242 42
 slide *Playground* 273 24
 slide *Winter Countr.* 304 17
 slide *Music. Not.* 321 16
 slide *Music. Instr.* 322 51; 323 47; 326 7, 33
 slide, bed ~ 177 59
 slide bar 313 10
 slide calliper 85 10
 slide chair 202 22
 slide control 238 47; 241 8
 slide-copying adapter 115 88
 slide-copying attachment 115 87
 slide holder 309 43
 slide projector 114 76; 309 42; 312 23
 slider 326 7
 slide rail 206 38
 sliding door 271 50
 sliding scale 349 23
 sliding weight 22 68; 40 36
 sliding-weight scales 22 66; 40 35
 sling *First Aid* 21 2
 sling *Mountain.* 300 11
 sling pump 101 53
 sling ring 87 5
 sling seat 300 29
 slip *Underwear etc.* 32 13
 slip *Plant Propagn.* 54 20
 slip *Roof* 122 48
 slip casting 161 15
 slip fault 12 7
 slip-off slope 13 58
 slipper *Shoes* 101 41
 slipper *Station* 206 49
 slipper animalcule 357 9
 slipper brake 206 49
 slip road 15 16
 slips 222 11-26
 slip sock, woollen ~ 101 42
 slipway 222 11-18
 slipway crane 222 23
 slipway floor 222 17
 slipway frame 222 19
 slipway portal 222 11
 slipways 222 11-26
 slit, side ~ 30 49
 slit gong 354 18
 slitter 181 42
 sliver 164 15, 21
 sliver, carded ~ 163 38
 sliver, carded and combed ~ 163 72
 sliver, coiled ~ 163 35

sliver, doubled ~ 164 12
 sliver, thin ~ 164 13
 sliver can 164 3, 20
 slue 374 27
 slope 347 12
 slope, continental ~ 11 9
 slope soaring 287 27
 slops 355 34
 slosh baffle system 235 53
 slot *Glass Prod.* 162 9
 slot *Weaving* 166 32
 slot *Garage* 195 5
 slot *Election* 263 30
 slot *Airports* 288 45
 slotted board 2 45
 slouch hat 35 21
 slow motion control 243 49
 slow-running jet 192 1
 slowworm 364 37
 slubbing frame 164 19
 slug 174 27
 slug-casting machine 174 19
 slug-composing machine 174 19
 slug of clay 161 10
 sluice dam 217 73-80
 sluice gate 217 53-56, 77
 sluice valve 217 53-56
 slush pump 127 7
 slush 304 30
 slush pump 145 16
 smack 221 49
 small arm 87 2
 small beer 93 26
 smallbore free rifle 305 44
 smallbore rifle 305 48
 smallbore standard rifle 305 43
 small cabbage white butterfly 80 48
 small ermine moth 80 5
 small of the back 16 25
 small of the butt 87 7
 small scabious 375 29
 small-shot cartridge 87 49
 small-shot charge 87 51
 smash 293 17
 smear 23 15, 50
 smelting section 147 8
 smith 137; 138
 smith forging 139
 smock overall 31 35
 smock windmill 91 29
 smokebox door 210 26
 smoke canister 255 83
 smoke dispenser 255 83
 smoke extract 38 81
 smoke flap 352 9
 smoke house 96 48
 smoke outlet 38 81; 210 22; 353 21
 smoker's companion 107 44
 smokestack *Power Plant* 152 15
 smokestack *Railw.* 210 22
 smoke tube 210 8
 smoking requisites 107
 smother 128 11
 smoothing blade 200 18
 smoothing plane 132 15; 134 1

snaffle 289 12
 snail 357 27
 snail, edible ~ 357 27
 snail shell 357 29
 snake, poisonous ~ 364 40
 snake, venomous ~ 364 40
 snake charmer 353 45
 snakes 364 38-41
 snakeweed 376 10
 snapdragon 51 32
 snap gauge 149 59
 snap lid 127 24
 snapping beetle 80 37
 snapping bug 80 37
 snare drum 323 51
 snath 66 16
 snathe 66 16
 snead 66 16
 sneath 66 16
 snedding machine 85 18
 snipe 88 83
 snorkel *Warships* 259 72, 90
 snorkel *Swim.* 279 11
 snorkel *Bathing* 280 39
 snout 73 10; 88 53; 364 2
 snow 8 18; 9 34; 304 24; 353 5
 snow and ice climber 300 15
 snow and ice climbing 300 14-21
 snow and ice climbing equipment 300 31-57
 snow avalanche 304 1
 snowball *Winter Countr.* 304 15
 snowball *Shrubs etc.* 373 10
 snowball bush 373 10
 snowball fight 304 14
 snow blower 213 17
 snow bridge 300 24
 snow chain 304 10
 snow cornice 300 20
 snowdrift 304 5
 snowdrop 60 1
 snowfall 10 48; 304 4
 snow fence 304 6
 snow forest climate 9 56
 snow gaiter 300 55
 snow goggles 300 18
 snow guard 38 8
 snow guard bracket 122 16
 snow hut 353 4
 snow ledge 300 4
 snowman 304 13
 snow plough, rotary ~ 213 17
 snow plough attachment 304 9
 snow plough signs 203 34-35
 snow push 304 23
 snowshirt 300 6
 snow shovel 304 23
 snowslide 304 1
 snow suit 29 38
 snuff 107 20
 snuff box 107 20
 soaking pit 148 46
 soaking pit crane 148 47
 soaking tub 136 13
 soap 49 22
 soap box 273 33
 soap dish 49 21
 soap dispenser 50 27

soaring 287
 soccer 273 10; 291
 sock 291 58
 sock, knee-length ~ 29 53; 32 32; 33 42
 sock, long ~ 32 34
 sock, surgical ~ 101 50
 socket *Hairdresser* 106 15
 socket *Plumb.* 125 20
 socket *Plumb. etc.* 126 43
 socket *Electr.* 127 7
 socket, double ~ 127 6
 socket, earthed ~ 127 5, 6, 13
 socket, four-way ~ 127 8
 socket, multi-outlet ~ 195 39
 socket, surface-mounted ~ 127 13
 socket, switched ~ 127 7
 socket, three-pin ~ 127 66
 socket, three-pole ~ 127 13
 socket, tinner's ~ 125 20
 socket, underfloor ~ 127 22
 socket outlet box 127 25
 socks, men's ~ 32 32-34
 soda bottle 42 32
 soda-lime absorber 27 39
 soda water 98 87
 soda water bottle 42 32
 sodium atom 1 8
 sodium chloride 1 9; 170 13
 sodium ion 1 11
 sodium pump, primary ~ 154 5
 sodium pump, secondary ~ 154 8
 sodium sulphate storage tank 172 36
 sodium system, primary ~ 154 2
 sodium system, secondary ~ 154 7
 sofa 336 17
 sofa, two-seater ~ 246 36
 soffit 122 27
 soft corn 68 31
 soft pedal 325 9
 soil covering 200 64
 soil injector 83 33
 solan goose 359 9
 solar cell 155 34
 solar collector 155 28, 32
 solarium 281 10
 solar panel 10 66
 solar radiation shielding 10 36
 solar sensor 10 69
 solar spectrum 343 14
 solar system 4 42-52
 soldanella 378 3
 solder 108 38
 solder, tin-lead ~ 126 76
 soldering apparatus 125 5-7
 soldering borax 108 39
 soldering fluid 125 7
 soldering flux 108 36
 soldering gun *Goldsm. etc.* 108 14
 soldering gun *D.I.Y.* 134 56
 soldering iron *Plumb.* 125 5
 soldering iron *Plumb. etc.* 126 73

soldering iron *D.I.Y.* 134 19, 57
 soldering iron, electric ~ 127 45
 soldering iron, high-speed ~ 134 58
 soldering stone 125 6
 solder wire, tin-lead ~ 134 20
 soldier, lead ~ 309 52
 soldier, tin ~ 309 52
 sole *Agr. Mach.* 65 6, 66
 sole *Shoem.* 100 66
 sole *Joiner* 132 22
 sole, cemented ~ 101 11
 sole, corrugated ~ 300 43
 sole, inner ~ 291 31
 sole, natural-colour ~ 101 15, 38
 sole, nylon ~ 291 30
 sole, plastic ~ 101 2
 sole, PVC ~ 101 2
 sole, rubber ~ 101 38
 sole, wooden ~ 101 45
 sole bar reinforcement 213 12
 sole leather 100 31
 sole-leather shears 100 39
 solenoid valve 139 23
 sole of the foot 19 62
 sole-plate *Household* 50 7
 sole-plate *Road Constr.* 200 33
 sole-plate *Railw.* 202 5
 sole press, automatic ~ 100 14
 sole stitcher 100 26
 sole-stitching machine 100 26
 sole trimmer 100 5
 solid-fuel rocket, recoverable ~ 235 58
 solidification 170 35, 43
 solid-newel staircase 123 77
 solid rocket booster 235 58
 solids 347 30-46
 solid stage 148 26
 solid-web girder 121 72
 solid-web girder bridge 215 7
 solifluction lobe 11 51
 solifluction tongue 11 51
 soling 284 56
 sollarret 329 55
 solo machine 290 27
 solo seat 189 19
 solo skater 302 1
 solstice 3 8
 solution 345 10
 solution, viscous ~ 169 15
 solvent fumes 182 25
 Somali Current 14 36
 sombrero 35 5
 songbirds 360 1,3,4,5,7,9,10;
 361 1-20
 song thrush 361 16
 soot 38 34
 sordino 323 10; 324 68
 Soricidae 366 7
 sort 174 7, 28
 sorter 172 57
 sorter, rotary ~ 172 23
 sorter, secondary ~ 172 58
 sorting machine 74 38
 sorting siding 206 47
 sorting table 64 81

sound assistant 117 68; 310 57
 soundboard *Music. Instr.* 323 24; 324 3
 soundboard *Church* 330 21
 sound box 322 18, 29; 323 3; 324 15, 63
 sound camera 117 22; 313 26
 sound camera, Super-8 ~ 117 1
 sound coding equipment 242 11-14
 sound connecting cord 117 8
 sound control console 238 20, 41, 54; 239 8
 sound control desk 238 20, 41, 54; 239 8
 sound control engineer 238 19
 sound control room 238 27; 239 7
 sound dubbing 311 34-36
 sound echo 224 63
 sound editor 117 96
 sound effect 310 30
 sound effects box 238 35
 sound engineer 238 19
 sound film 117 82
 sound film cartridge, Super-8 ~ 117 29
 sound head *Cine Film* 117 33
 sound head *Audiovis.* 243 35
 sound head *Films* 312 47
 sound head housing 241 59
 sound hole 322 22; 323 6; 324 5
 sound impulse 224 62
 sounding balloon 7 17
 sounding board 330 21
 sound mixer 238 26
 sound mixing 311 34-36
 sound module 240 14
 sound OB van 239 1-15
 sound optics 312 46
 sound production control room 238 27; 239 7
 sound projector 117 81; 312 24
 sound recorder, portable ~ 310 24
 sound recording 311 1-46
 sound recording camera 310 60; 311 6
 sound recording equipment 117 7
 sound recording level control 243 11
 sound recording selector switch 117 13
 sound recordist *Broadcast.* 238 26
 sound recordist *Films* 310 23, 55; 311 36
 sound source 117 27
 sound source, external ~ 117 8
 sound technician 238 26
 sound track *Cine Film* 117 82
 sound track *Audiovis.* 243 32
 sound track system 117 21
 sound transmitter 224 61

sound turntable, first ~ 117 100
 sound turntable, second ~ 117 101
 sound wave 224 62
 sound wave propagation 7 14
 soup ladle 45 14
 soup plate 44 6; 45 5
 soup seasoning 98 30
 soup tureen 44 8; 45 15
 soup vegetable 68 25
 source water inlet 155 2
 sour cherry 59 5
 souring chamber 159 6
 sour milk vat 76 42
 South America 14 13
 South Equatorial Current 14 34
 Southern Cross 3 44
 Southern Ocean 14 22
 Southern Triangle 3 40
 south point 4 17
 South Pole 14 3
 southwester 35 30; 228 5
 souvenir plate 309 48
 sou'wester 35 30; 228 5
 sow *Dom. Anim.* 73 9
 sow *Livestock* 75 41
 sow *Hunt.* 86 32
 sow *Game* 88 48, 51
 sow bug 81 6
 sower 63 10
 sowing 54 1; 63 10-12
 sow pig 75 42
 spa 274
 space *Composing Rm.* 175 5, 17
 space *Music. Not.* 320 44
 space, popliteal ~ 16 51
 spaceband 174 24
 space bar 249 2
 space capsule 6 9, 10; 234 65
 spacecraft 6 1
 space flight 234; 235
 spaceflight module 235 10
 Spacelab 235 65
 space laboratory 235 65
 spacer 119 81
 Space Shuttle-Orbiter 235 1-45
 space station 235 65
 space suit 6 18-27
 space suit helmet 6 22
 spacing bracket 126 54
 spacing clip 126 57
 spacing lines 10 58
 spacing material 174 8
 spade 56 2; 331 36
 spade *Fish Farm.* 89 82
 spade *Army* 255 55
 spade, semi-automatic ~ 56 12
 spade piston 255 56
 spades 276 39
 spadix 370 71; 378 22
 spadix, female ~ 384 6
 spadix, male ~ 383 55; 384 4
 spa gardens 274 1-21
 spaghetti 98 32
 spale 136 12
 snale basket 136 11

span *Bridges* 215 14
 span *Aircraft* 229 2
 span, clear ~ 215 13
 span, wire rope ~ 221 102
 Spandau 255 32
 Spanish chestnut 384 48
 Spanish paprika 57 42
 spanker 219 30
 spanker boom 218 28; 219 44
 spanker boom topping lift 219 48
 spanker gaff 219 45
 spanker peak halyard 219 49
 spanker sheet 219 69
 spanker vang 219 70
 span of oxen 63 16
 spa orchestra 274 20
 spa promenade 274 10
 spar 230 45
 spar, diagonal ~ 287 33
 spar, integral ~ 257 28
 spar, main ~ 287 30
 spar buoy 224 79
 spar ceiling 222 62
 spare man 291 11
 spare part *Watchm.* 109 22
 spare part *Garage* 195 32
 spare rib 95 47
 spare tyre *Lorries etc.* 194 4
 spare tyre *Cyc. Racing* 290 23
 spare wheel 191 25; 194 33
 spar hawk 362 12
 spark arrester 210 24
 spark gap 153 62
 spark-ignition engine 190 1, 2
 sparking plug 190 35; 242 48
 spark plug 190 35; 242 48
 spark-plug cap 188 27
 Sparmannia 53 9
 sparring partner 299 27
 sparrow hawk 362 12
 sparrow owl 362 19
 spars 219 32-45
 spatula *Dent.* 24 50
 spatula *Hosp.* 25 7
 spatula *Art. Studio* 338 15
 spatula, plastic ~ 128 44
 spawn 89 12
 spawner 89 13
 speaker *Living Rm.* 42 10
 speaker *Election* 263 5
 speaker *Hotel* 267 40
 speaker *Disco* 317 15
 speaker *Nightclub* 318 12
 speaker, three-way ~ 241 14
 speaking key 242 24
 spear, long-bladed ~ 354 12
 spear head, bronze ~ 328 21
 spear thrower 352 40
 special effects equipment 310 59
 special offer 96 20; 271 65
 specialty shop 195 1-55
 specie 252 1-28
 speciestaler 252 6
 specimen insertion air lock 113 33
 specimen stage adjustment 113 34
 spectacle fitting 111 1-4

spectacle frame *Optics.* 111 5, 10-14
 spectacle frame *Ship* 223 61
 spectacle lens 111 15
 spectacles 111 5, 9
 spectator 308 29
 spectator barrier 292 40
 spectators' terrace *Airport* 233 20
 'spectators' terrace' *Airport* 233 30
 spectrograph 5 33
 speculum, aural ~ 22 74
 speculum, rectal ~ 23 19
 speculum, vaginal ~ 23 13
 speed ball 299 22
 speed change lever 149 5
 speed changer 241 29
 speed code number 203 37
 speed control 179 29
 speed indicator 203 18
 speed indicator, distant ~ 203 19
 speedo 188 19, 34; 191 38, 74
 speedometer *Motorcycles etc.* 188 19, 34, 40
 speedometer *Motorcycle* 189 40
 speedometer *Car* 191 38, 74
 speedometer *Tram* 197 31
 speedometer *Railw.* 211 35; 212 9
 speedometer *Navig.* 224 54
 speedometer, ship's ~ 224 22
 speedometer drive 192 38, 39
 speed recorder 210 54
 speed restriction, permanent ~ 203 41, 42
 speed restriction, temporary ~ 203 39, 40
 speed restriction sign 203 36-38, 41, 44
 speed restriction signs 203 36-44
 speed restriction warning sign 203 43
 speed selector 241 29
 speed skate 302 20
 speed skater 302 26
 speed skating set 302 20
 speedway 290 24-28
 speedwell 375 22
 speleothems 13 80-81
 spelling book 260 17
 spelt 68 24
 spelt, green ~ 68 25
 spencer 220 1
 sperm whale 367 25
 sphagnum mosses 13 20, 22
 sphenoid 17 38
 sphere 347 41
 sphere, celestial ~ 4 23
 sphere, plain ~ 36 82
 sphere, solar ~ 4 36
 spheres 36 82-86
 sphere unit 2 38
 spherical typing element 249 15
 sphincter, anal ~ 20 63
 sphinx *Fabul. Creat.* 327 20
 sphinx *Articulates* 358 55

sphinx *Lepidopt.* 365 9
 sphinx, Egyptian ~ 333 11
 sphygmograph 26 32
 sphygmomanometer 25 15
 Spica 3 18
 spice 99 67
 spice jar 39 32
 spice rack 39 31; 47 29
 spices 382
 spider legs 115 91
 spiders 358 44-46
 spider's web *Playground* 273 46
 spider's web *Articulates* 358 47
 spike *Arable Crops* 68 2
 spike *Mountain.* 300 9
 spike *Music. Instr.* 323 22
 spike *Industr. Plants* 383 62, 66
 spike, fleshy ~ 370 71
 spike, racemose ~ 370 67
 spikelet 68 3, 10; 69 23; 375 41, 42
 spill light 310 51
 spillway 217 60
 spin *Roulette* 275 32
 spin *Airsports* 288 7
 spinach 57 29
 spinal cord 17 48; 18 25
 spindle *Watchm.* 109 17
 spindle *Mach. Tools* 149 66; 150 27
 spindle *Cotton Spin.* 164 43
 spindle *Bookbind.* 183 22
 spindle *Bicycle* 187 60, 80
 spindle, horizontal ~ 150 40
 spindle, main ~ 149 11
 spindle, screwed ~ 149 66
 spindle catch 164 49
 spindle drive 164 31
 spindle oil 145 61
 spindle rail 164 50
 spindle rotation speed 150 35
 spindle shaft 164 46
 spindle speed 164 38, 40
 spindle top 126 32
 spine *Man* 17 2-5
 spine *Bookbind.* 183 14; 185 41
 spine *Mammals* 366 6
 spine label 247 38
 spine of the book 183 1
 spinet 322 45
 spine tag 247 38
 spinet piano 325 1
 spinner *Fish Farm.* 89 74, 75
 spinner *Aircraft* 230 33
 spinner, long ~ 89 76
 spinneret *Synth. Fibres* 169 14; 170 41
 spinneret *Articulates* 358 46
 spinneret hole 170 41, 42
 spinning 170 57
 spinning bath 169 15
 spinning jet 169 14; 170 41, 42
 spiraea 374 23
 spiral *Photog.* 116 2
 spiral *Airsports* 288 51
 spiral *Gymn.* 297 50
 spiral design pottery 328 13

spire 331 6
 spirit glass 45 90
 spirit lamp 24 57
 spirit level *Map* 14 61
 spirit level *Bldg. Site* 118 55
 spirit level *Plumb. etc.* 126 79
 spirit level *D.I. Y.* 134 29
 spirits 98 56-59; 318 19
 spirograph 27 36
 Spirographis 357 22
 spirometer 23 31
 spirometry 27 36-50
 spit *Phys. Geog.* 13 5
 spit *Kitch. Utensils* 40 33
 spitz 70 20
 splashboard 186 6
 spleen 20 12, 27
 splenius of the neck 18 51
 splice, wet ~ 117 89
 splice graft 54 39
 splice grafting 54 39
 splicer 117 89
 splicing cement 312 22
 splicing head 133 29
 splint *First Aid* 21 12
 splint *Sawmill* 157 16
 splint, emergency ~ 21 10
 splint bone 17 24
 splinter 157 16
 split-image rangefinder 115 55, 59, 64
 splits 314 20
 splitter 94 17
 splitting hammer 85 5
 spoil 226 47
 spoiler 229 39; 287 38
 spoiler, front ~ 193 36
 spoiler, inner ~ 229 42
 spoiler, rear ~ 193 34; 290 35
 spoiler rim 193 30
 spoil heap 144 19
 spoke *Mach. Parts etc.* 143 88
 spoke *Bicycle* 187 27
 spoke *Motorcycle* 189 24
 spoke end 187 29
 spoke flange 187 29
 spoke nipple 187 29
 spokeshave 132 27
 spoke wheel 289 25
 sponge *Bathrm. etc.* 49 6
 sponge *School* 260 42
 sponge *Graphic Art* 340 25
 sponge *Invertebr.* 357 13
 sponge holder 23 12
 sponge tray 260 41
 spool 162 55
 spool box 312 16
 spool box, fireproof ~ 312 25
 spool holder 185 17
 spool knob 114 27
 spoon *Tablew. etc.* 45 61
 spoon *Fish Farm.* 89 73
 spoon, wooden ~ 40 2
 spoon bait 89 73
 spoon bit 135 16
 spoon bow 285 30
 spoon chisel 339 18
 spore 381 8, 13
 sporting coupé 193 28
 sporting gun 86 4
 sporting guns 87 1-40

sporting rifle 86 4
 sporting rifles 87 1-40; 305 40-49
 sport parachute 288 45
 sports, various ~ 305
 sportsboat, inflatable ~ 286 1
 sportsboats *Rowing* 283 9-16
 sportsboats *Motorboats etc.* 286 1-5, 10-14
 sports news item 342 61
 sports report 342 60
 sports reporter 299 50
 sports section 342 57
 spot 276 32
 spot, central ~ 115 65
 spot, clear ~ 115 66
 spot ball, white ~ 277 13
 spotlight 307 3; 318 24
 spotlight catwalk 310 53
 spotted bruchus 81 19
 spotted woodpecker 359 27
 spotting position 297 16
 spot welder, foot-operated ~ 142 29
 spot welding 142 22
 spot welding electrode holder 142 23
 spout 91 14
 spout, swivel-mounted ~ 64 37
 spout hole 367 26
 spray *Doc.* 22 60
 spray *Pest Contr.* 83 8
 spray boom 83 3
 spray can 106 23
 spray canister 83 44
 spraydeck 283 56
 sprayer *Gdn. Tools* 56 24
 sprayer *Letterpress* 181 10, 34
 sprayer, semi-mounted ~ 83 47
 sprayer, tractor-mounted ~ 83 2
 spray fluid tank 83 5, 50
 spray gun *Pest Contr.* 83 18
 spray gun *Painter* 129 32
 spray gun *Letterpress* 181 34
 spray gun, airless ~ 129 37
 spraying 129 28
 spraying tube 83 29
 spray line, oscillating ~ 67 1
 spray nozzle *Household* 50 13
 spray nozzle *Intern. Combust. Eng.* 190 54
 spray pipe 172 72
 spray tank 83 39
 spray tube 83 22
 spray unit *Pest Contr.* 83 58
 spray unit *Offset Platem.* 179 5, 6
 spray unit, airless ~ 129 36
 spreader *Paperhanger* 128 46
 spreader *Ship* 223 37
 spreader *Sailing* 284 13
 spreader cylinder 62 23
 spreader unit 62 22
 spreading flap 200 42
 spring *Map* 15 82
 spring *Metalwkr.* 140 46
 spring *Knitting* 167 38
 spring *Carriages* 186 15

spring, artesian ~ 12 26
 spring, rubber ~ 297 13
 spring attachment 11 42
 spring barrel 110 38
 springboard *Swim.* 282 9, 10
 springboard *Gymn.* 296 12; 297 8
 springboard *Circus* 307 36
 springboard acrobat 307 35
 springboard artist 307 35
 springboard trampoline 297 14
 spring bolt 140 37
 spring bow compass 151 64
 spring buffer 214 50
 spring bumper 214 50
 spring chest 326 12-14
 springer 336 22
 spring extension 309 28
 spring fly 358 12
 spring form 40 27
 spring pin tool 109 9
 spring ring hinge 151 65
 spring snowflake 60 1
 spring suspension 83 7
 spring tine 65 57
 spring line, double ~ 64 42, 54
 spring vice 140 10
 spring washer 143 34; 202 8
 sprinkler 55 19
 sprinkler, oscillating ~ 56 46
 sprinkler, revolving ~ 56 43; 62 29; 67 4, 32
 sprinkler cart 62 27
 sprinkler hose 62 30
 sprinkler nozzle 67 27
 sprinkler stand 62 28
 sprinkler system 316 6
 sprinkling can 51 21; 55 26
 sprinkling device 55 19
 sprinter 298 5
 spritsail 218 43; 220 5
 sprocket 143 90; 187 38, 74
 sprocket piece 121 30
 sprocket wheel 187 38
 sprout *Veg.* 57 30
 sprout *Bot.* 370 19-25
 spruce 372 12
 spruce cellulose 169 1
 spruce cone 372 13
 spruce fir 372 12
 spruce-gall aphid 82 38
 spruce needle 372 19
 spur *Dom. Anim.* 73 26
 spur *Game* 88 82
 spur *Mountain.* 300 13
 spurrey 69 12
 spurs 71 50-51
 spur vein 72 28
 spur wheel, helical ~ 143 89
 sputum 23 25
 spyhole *Hall* 41 29
 spyhole *Iron Foundry etc.* 148 4
 squadron marking 256 2
 square *Metalwkr.* 140 57
 square *Maths.* 346 33; 347 31
 square, black ~ 276 3
 square, glazier's ~ 124 20
 square, iron ~ 120 78
 square, white ~ 276 2

squared timber store 157 32
 square piano 325 40
 square root 345 3
 squash 57 23
 squat 295 9
 squat-style snatch 299 1
 squat vault 296 53
 squaw 352 10
 squaw corn 68 31
 squeeze *Photog.* 116 49
 squeeze *Text. Finish.* 168 61
 squeeze phase 75 34
 squeeze roller 165 46
 squirrel 366 19
 squirrel's bread 381 16
 stabilizer *Photog.* 116 10
 stabilizer *Motorcycles etc.* 188 5
 stabilizer *Railw.* 214 55
 stabilizer *Navig.* 224 26
 stabilizer *Air Force* 256 22
 stabilizer *Winter Sp.* 301 49
 stabilizer *Sports* 305 58
 stabilizer, horizontal ~ 229 26; 230 62; 256 31; 288 23
 stabilizer, vertical ~ 229 24; 230 59; 231 6; 232 7; 256 32; 288 21
 stabilizer and rudder, vertical ~ 229 24, 25; 230 58
 stabilizer bar 192 71
 stabilizing fin *Air Force* 256 22
 stabilizing fin *Swim.* 279 3
 stabilizing fin, aerodynamic ~ 234 7
 stabilizing layer 301 49
 stabilizing panel 288 49
 stabilizing surface 256 22
 stabilizing wing 117 60
 stable 62 2; 75 1
 stable fly 81 4
 stableman 186 27
 staccato 321 34
 stack *Forestry* 84 15
 stack *Univ.* 262 11
 stack bearer 157 37
 stacker, intermediate ~ 236 34
 stacker truck 159 18
 stacking machine 162 20
 stack of logs 84 16
 staff 320 43-44
 staff compartment 207 81
 staff lavatory 207 82
 staff toilet 207 82
 staff washroom 207 26
 staff WC 207 82
 stag, rutting ~ 86 12; 88 4
 stag beetle 358 24
 stag call 87 46
 stage *Films* 312 8
 stage *Theatre* 315 14-27, 14
 stage *Nightclub* 318 22
 stage, mechanical ~ 112 10, 29; 115 98
 stage, microscopic ~ 112 9
 stage, revolving ~ 316 31
 stage, universal ~ 112 17
 stage base 112 15
 stage carpenter 316 45
 stagecoach 186 39

stagecoach, English ~ 186 53
 stage curtain 312 10
 stage designer 315 37
 stage director 316 30
 stagehand 315 28; 316 46
 stagehouse 316 1-60
 stage light 316 14
 stage lighting 318 23
 stage lighting unit 316 14
 stage manager 316 30
 stage plate 115 95
 stage rehearsal 315 21-27
 stage separation retro-rocket 234 8
 staghorn 377 12
 stag horn moss 377 12
 staghound 289 47
 staging *Photograv.* 182 12
 staging *Shipbuild.* 222 18
 stag jump 295 40; 302 7
 stag leap 295 40; 302 7
 stag's horn 377 12
 stag's horn moss 377 12
 staining dish 23 50
 staining vat 130 15
 staircase 37 72; 118 22
 staircase, dog-legged ~ 123 42-44
 staircase, outside ~ 333 33
 staircase, quarter-newelled ~ 123 75
 staircase, spiral ~ 123 76, 77
 staircase, winding ~ 123 76, 77
 staircase bolt 123 46
 staircase construction 123
 staircase of locks 217 17-25
 staircase window 37 81; 123 65
 stair light 41 22
 stairs, concrete ~ 123 16
 stair well 120 46
 stake *Wine Grow.* 78 7
 stake *Forestry* 84 17
 stake *Plumb.* 125 23
 stake *Basketm.* 136 6
 stake *Roulette* 275 13
 stake net 89 94
 stalactite 13 80, 82
 stalactite vault 337 17
 stalagmite 13 81, 82
 stalk 58 13, 34, 61; 68 6; 370-20; 378 31
 stalk, herbaceous ~ 384 30
 stalking 86 1-8
 stall 75 2
 stallion 73 2
 stalls, front ~ 315 19
 stall turn 288 4
 stamen 58 45; 59 10, 39; 370 57, 60; 372 7, 18; 373 2, 5; 374 3
 stamp *Doc.* 22 29
 stamp *Slaughterho.* 94 24
 stamp *Post* 236 21, 61
 stamp *Bank* 250 24
 stamp, impressed ~ 252 35
 stamp book 236 20
 stamp counter 236 15
 stanchion 221 117
 stanchion, hinged ~ 213 6

stanchion, steel ~ 213 6
 stand *Hosp.* 25 11; 26 9, 29
 stand *Overh. Irrign.* 67 2
 stand *Shoem.* 100 54
 stand *Optic.* 111 5
 stand *Optic. Instr.* 112 2
 stand *Basketm.* 136 10
 stand *Composing Rm.* 175 50
 stand *Photomech. Reprod.* 177 29
 stand *Motorcycles etc.* 188 51
 stand *Circus* 307 57
 stand *Bullfight, etc.* 319 8
 stand, hydraulic ~ 310 50
 stand, raised ~ 86 14, 14-17
 standard *Bldg. Site* 119 47, 59
 standard *Forging* 139 19
 standard *Photomech. Reprod.* 177 11
 standard adjustment 114 51
 standard lamp 46 37
 Standard meridian 14 5
 standard of the German Federal President 253 14
 standby drive 214 64
 standing-in position 297 16
 standing matter 174 11
 standing matter rack 174 9
 standing position 305 27
 standing press 183 20
 standing room portion 197 18
 standing stone 328 18
 standing take-off pike dive 282 40
 standing type 174 11
 standing type rack 174 9
 standing wrestling 299 6
 standpipe *Farm Bldgs.* 62 12
 standpipe *Oil, Petr.* 145 13
 standpipe *Paperm.* 173 12
 standpipe *Space* 234 25
 standpipe *Fire Brig.* 270 26
 standpipe coupler 67 5
 stapelia 53 15
 staple fibre 169 1-34
 staple fibre lap 169 31
 staple fibre, viscose rayon ~ 169 28-34
 staple fibre layer 169 31
 staple length 170 60
 stapler 22 25; 247 4
 staple shaft 144 27
 stapling machine 247 4
 star *Sailing* 284 55
 star *Films* 310 27, 28
 star, binary ~ 3 29
 star, circumpolar ~ 3 5
 star, double ~ 3 29
 star, principal ~ 3 9
 star, variable ~ 3 11
 star connection 153 20
 star finch 360 3
 starfish 357 38; 369 17
 starling 361 4
 star map 3 1-35
 star network 153 20
 stars, fixed ~ 3 9-48
 Stars and Stripes 253 18
 Star-Spangled Banner 253 18
 start *Motorboats etc.* 286 28, 29

start *Athletics* 298 1-6, 3
 starter 282 30
 starter, electric ~ 56 39
 starter and steering lock 191 75
 starter battery 212 46
 starter button, electric ~ 189 52
 starter motor *Intern.*
 Combust. Eng. 190 44
 starter motor *Railw.* 212 30
 starter pedal 188 25
 starter's flag 273 34
 starter switch 241 30
 starting and braking device, automatic ~ 168 20
 starting and finishing buoy 285 14
 starting and stopping handle 166 8
 starting and stopping lever 165 17; 180 80; 181 32
 starting block *Swim.* 282 27
 starting block *Athletics* 298 1
 starting dive 282 29
 starting gear ring 192 31
 starting handle 163 17
 starting lever 178 20
 starting line 286 30
 starting motor 190 44
 starting place 282 27
 starting position 295 1
 starting price 289 37
 starting resistance 135 3
 starting resistor 135 3
 starting rod 167 22
 starting signal 205 47
 start print button 249 38
 start-stop lever 163 40
 star wheel *Mach. Tools* 149 43
 star wheel *Graphic Art* 340 39
 Stassfurt salt 154 66
 Stassfurt seam 154 65
 stately home 15 96
 statement of account 247 44
 state of play 293 38
 static air tank 196 19
 station, coastal ~ 237 53
 station, lower ~ 214 39
 station, top ~ 214 57
 station, upper ~ 214 57
 stationary rings 296 4
 station bookstall 204 26
 station bookstand 204 26
 station clock 204 30
 station foreman 205 41
 station hall 204
 station mailbox 204 11
 station of the Cross 330 54
 station platform 205
 station post box 204 11
 station preset button 241 4; 243 17; 309 20
 station restaurant 204 13
 station selector button 241 4; 243 17; 309 20
 station sign 205 28
 station wagon 193 15
 statistics chart 248 36
 statue 215 22; 272 10; 334 5; 339 32

statue, stone ~ 272 2
 statuette, ivory ~ 328 8
 stave *Cooper* 130 2
 stave *Music. Not.* 320 43-44
 stay 219 10
 stay, triatic ~ 223 11
 stayer 290 14
 stay pole 152 31
 stay rope 299 37
 stay-warm plate 28 28
 stay wire 296 10; 297 5; 299 37
 St. Bernard dog 70 37
 steady, fixed ~ 150 30
 steam 50 11
 steam and recirculation water flow path 154 51
 steam boiler 152 5
 steam chest 210 31
 steam collector 210 21
 steam coupling hose 208 20
 steam dome 210 12
 steam extraction 103 26
 steam extractor 103 25
 steam-generating station 152 1-28
 steam generator 154 9, 26, 44
 steam heater 172 38
 steam hole 50 14
 steaming light 223 40; 258 55
 steaming light mast 221 51
 steam iron 103 20; 131 3
 steam line 154 11
 steam locomotives 210 1-69
 steam pipe 172 64
 steam pipe, high-pressure ~ 259 63
 steam press 104 26
 steam pressing unit 104 26
 'steam radio' 309 16
 steam reversing gear 210 18
 steam slit 50 14
 steam spray gun 131 2
 steam sterilizer 22 39
 steam storage locomotive 210 68
 steam trawler 221 46
 steam tube 210 17
 steam turbine 152 23; 153 23-30; 154 14, 46, 52
 steam turbine generator 259 58
 steel 94 16
 steel, finished ~ 148 68
 steel bender 119 21
 steel-casting ladle 147 31
 steel grit delivery pipe 148 38
 steel ingot 147 33
 steel lattice bridge 215 34
 steel-leg vice 126 80
 steel-wheel glass cutter 124 26
 steelworks 147 21-69
 steep face 12 43
 steeping 169 4
 steeping floor 92 8, 28
 steeping tank 92 8
 steeple 331 2
 steeplechase *Equest.* 289 20-22
 steeplechase *Athletics* 298 7-8

steep liquor 92 6
 steering, hydraulic power ~ 65 41
 steering alignment 195 17; 22
 steering alignment, visual ~ 195 41
 steering and control position 224 14
 steering arm 192 79
 steering axle 64 32
 steering column 192 56
 steering column, controlled-collapse ~ 191 57
 steering drop arm 192 58
 steering gear 192 56-59
 steering head 187 11
 steering line *Rowing* 283 52
 steering line *Airports* 288 41
 steering oar 218 6
 steering rudder 283 51-53
 steering runner 302 45
 steering system, rear-wheel ~ 64 39
 steering tube 187 14
 steering wheel 191 37; 305 89
 steering wheel spoke 191 58
 steersman *Ship* 218 2
 steersman *Winter Sp.* 303 20
 stein 309 53
 steinbock 367 7
 Steinheim man 261 17
 stela 330 43; 334 33
 stela 330 43; 334 33
 stem *Forestry* 84 19
 stem *Tobacc. etc.* 107 38
 stem *Metalwkr.* 140 33
 stem *Ship* 218 4; 221 14, 83, 108; 258 3
 stem *Chem.* 350 7
 stem *Bot.* 370 2
 stem *Edib. Fungi* 381 18
 stem, bulbous ~ 222 74
 stem, prostrate ~ 58 20
 stem, straight ~ 285 40
 stem, wire ~ 325 29
 stem cutting 54 25
 stemless alpine gentian 378 13
 stemming sand bucket 158 29
 stem post 218 4
 stem rudder 218 24
 stem stitch 102 4
 stencil ejection 245 9
 stencil knife 129 43
 stencil lettering guide 151 69
 stencil magazine, vertical ~ 245 8
 stencil storage drawer 245 10
 stenography 342 13
 steno pad 245 29; 248 32
 stenter 165 54; 168 21
 stenter clip 168 24
 stenter pin 168 24
 step *Roof & Boilerr.* 38 27
 step *Hall* 41 24
 step *Carriages* 186 13
 step *Tram* 197 15
 step *Aircraft* 230 42
 step *Swim.* 281 32, 37
 step *Mountain.* 300 17
 step, bottom ~ 123 18, 42

step, top ~ 123 19
 step, wedge-shaped ~ 123 31
 step bearing 91 10
 step-cut, hexagonal ~ 36 62
 step-cut, octagonal ~ 36 52
 step-cut, rectangular ~ 36 50
 step-cut, rhombus ~ 36 59
 step-cut, round hexagonal ~ 36 64
 step-cut, square ~ 36 51
 step-cut, trapezium ~ 36 57
 step-cut, triangular ~ 36 60-61
 step fault 12 8
 step irons 269 28
 stepladder 50 35; 126 2; 129 5
 steppe zone 9 54
 stepping stones 37 45
 steps *Dwellings* 37 39
 steps *Household* 50 35
 steps *Station* 204 25; 205 2
 steps *Circus* 307 20
 steps, front ~ 37 66
 steps, wooden ~ 38 25
 stereobate 334 4
 stereo cassette deck 241 33
 stereo component system, three-in-one ~ 241 52
 stereo effect 310 30
 stereo equipment 42 9; 317 22-23
 stereo microphone jack 241 65
 stereo microphone socket 241 65
 stereomicroscope, wide-field ~ 112 61
 stereoplanigraph 14 66
 stereo receiver 241 52
 stereoscope 14 64
 stereo sound 311 35
 stereo speakers 241 13-14
 stereo system 42 9; 241 13-48; 317 22-23
 sterilization room 26 34-54
 sterilizer 76 12
 sterilizer, small ~ 26 35
 stern 222 66-72; 258 26; 285 29
 stern, elliptical ~ 218 25
 stern, gilded ~ 218 55-57
 stern, lower ~ 218 58
 stern, round ~ 218 25
 stern, square ~ 285 43
 stern, upper ~ 218 55
 sterncastle 218 23
 stern fender 227 29
 stern frame 222 70-71
 stern gallery 218 56
 stern light 258 62
 stern light, white ~ 286 14
 stern loading door 221 31
 stern opening 221 55; 226 18
 stern port 221 55; 226 18
 stern post 218 1
 stern ramp 221 88; 258 91
 stern towing point 221 53
 sternum 17 8
 stethoscope 23 35
 stetson hat 319 37
 steward *Ship* 221 110

steward *Election* 263 10
 steward *Cyc. Racing* 290 4
 stick 322 35; 323 14, 56
 stick, forked ~ 54 13
 stick, French ~ 97 12
 stick blade 302 32
 sticker *Slaughterho.* 94 14
 sticker *Music. Instr.* 325 30; 326 9
 stick handle 302 31
 sticking knife 94 14
 sticking paper 260 50-52
 sticking plaster 21 7; 22 55
 stiffener 215 53
 stiffening 101 37
 stifle 72 33
 stifle joint 72 33
 stigma *Soft Fruit* 58 41
 stigma *Drupes & Nuts* 59 16
 stigma *Articulates* 358 32
 stigma *Bot.* 370 56
 stile *Roof & Boilerr.* 38 16
 stile *Household* 50 36
 stile *Carp.* 120 25
 stile *Roof* 121 40
 stiletto 102 12
 stiletto beard 34 13
 stiletto heel 101 28
 stillhunting 86 1-8
 stilling basin 217 61
 stilling box 217 61
 stilling pool 217 61
 still life group 338 27
 stilt 359 19
 stilt bird 359 19
 stilt plover 359 19
 stilts 308 49
 stimulants 382
 sting 77 11
 stinging nettle 61 33
 stinging organs 77 10-14
 sting sheath 77 12
 stinkweed 379 8
 stipe 381 18
 stipple paint 129 53
 stippler 129 18
 stippling roller 129 13
 stipule 57 5; 58 48; 371 73
 stirrer *Dairy.* 76 43
 stirrer *Paperm.* 172 47
 stirrer *Chem.* 349 18
 stirrup *Horse* 71 43
 stirrup *Bldg. Site* 119 70
 stirrup iron 71 43
 stirrup leather 71 42
 stitch, flat ~ 102 10
 stitch, knotted ~ 102 13
 stitch, ornamental ~ 102 3
 stitch, overcast ~ 102 8
 stitch, Russian ~ 102 9
 stitching 183 8, 34
 stitching, decorative ~ 31 5
 stitching machine 100 21
 stitching wire feed mechanism 184 18
 stock *Plant Propagn.* 54 33
 stock *Hunt.* 87 3, 4, 6, 13
 stock *Mills* 91 2
 stock *Joiner* 132 24
 stock *Paperm.* 173 1, 2-10
 stock *Stock Exch.* 251 1-10

stock *Stock Exch.* 251 11-19
 stock, round ~ 139 1
 stock, square ~ 143 9
 stockbroker, sworn ~ 251 4
 stock certificate 251 11
 stock chest 172 85; 173 1
 stock cube 98 26
 stock exchange 251 1-10
 stock exchange agent 251 7
 stock exchange attendant 251 9
 stocking 99 26; 318 32
 stocking, knee-high ~ 32 9
 stockjobber 251 6
 stock ledger 251 14
 stock list 250 8
 stock preparation plant 172 79-86
 stocks 222 11-26
 stock saddle 71 37-44
 stogy 101 39
 stoker, travelling-grate ~ 152 3
 stola 355 9
 stole, fur ~ 318 30
 stollen 97 11
 stomach *Man* 16 35-37; 20 13, 41-42
 stomach *Bees* 77 16
 stomiatid 369 10, 13
 stone *Agr.* 63 9
 stone *Mills* 91 21
 stone *Clocks* 110 33
 stone *Quarry* 158 8
 stone *Swim.* 281 22
 stone *Sculpt. Studio* 339 5
 stone *Shrubs etc.* 374 12
 stone, crushed ~ 158 24
 stone, dressed ~ 158 30
 stone, lower ~ 91 23
 Stone Age idol 328 8
 stone block 339 5
 stone catcher 64 9
 stone chippings 158 23
 stonecrop 51 7; 61 17; 375 21
 stone-crushing plant 158 18
 stone-dressing device 172 70
 stone fruit 59 41, 43, 49; 370 99
 stone lithography 340 25-26
 stone marten 367 14
 stonemason 158 34
 stonemason's tools 158 35-38
 stone pine 372 55
 stones, faceted ~ 36 42-71
 stone spreader 200 31
 stone trap 64 9
 stool 24 14; 27 50; 260 58
 stop *Bookbind.* 185 11
 stop *Railw.* 214 35
 stop *Music. Instr.* 325 44; 326 6
 stop *Chem.* 349 37
 stop and start lever 163 31
 stop and tail light 189 9
 stop and tail light unit 188 38
 stop bar 133 11
 stop bath 116 10
 stop board 203 25, 33
 stop boards 203 31-32
 stop button *Clocks* 110 22

stop button *Office* 249 73
 stopclock 238 62
 stopclock, electronic ~ 238 31
 stopclock *Plumb. etc.* 126 4
 stopclock *Gas Weld.* 141 7
 stopclock *Water* 269 48
 stopcock, flange-type ~ 130 21
 stop-cylinder machine 181 20
 stop-cylinder press 181 20
 stop fillet 119 62
 stop key 243 43
 stop knob *Music. Instr.* 325 44; 326 6
 stop knob *Chem.* 349 38
 stop lever 324 42
 stop line 268 50
 stop motion 166 43
 stop-motion device 168 19
 stopper *Overh. Irrign.* 67 36
 stopper *Iron & Steel* 147 31
 stopper *Music. Instr.* 326 35
 stopper *Chem.* 350 44
 stopper, ground glass ~ 349 4
 stopper, octagonal ~ 349 4
 stopping device 168 19
 stopping handle 164 6, 32
 stopping point 203 25, 31-32
 stop plate 157 18
 stop rod blade 166 43
 stops 342 16-29
 stop signal 203 1
 stop signal, electric ~ 203 3
 stop signals 203 1-6
 stop tab 326 39
 storage area 246 5
 storage bin 200 35
 storage box *Child. Rm.* 47 2
 storage box *D. I. Y.* 134 34, 39
 storage cell 77 35
 storage chamber 154 71, 76
 storage container 130 17
 storage cupboard 207 27
 storage door 39 6
 storage reservoir 217 57
 storage shelf 174 10
 storage siding 206 50
 storage tank *Brew.* 93 13
 storage tank *Oil, Petr.* 145 72
 storage tank *Paperm.* 172 17, 41, 45, 46
 storage tank *Docks* 225 72
 storage tank gauge 76 10
 storage unit *Dent.* 24 8
 storage unit *Composting Rm.* 176 11
 storage unit *Inf. Tech.* 242 9
 storage vessel 10 46
 store area 5 17
 storehouse 329 13
 storekeeper 98 41
 store room 223 57
 storey roof 337 2
 storm front 287 24
 storm-front soaring 287 23
 storm lantern 278 29
 storm signal 225 35; 280 4
 stout 93 26
 stove, cylindrical ~ 309 4
 stove, tiled ~ 266 34
 stove bench 266 36

stove door 309 7
 stovepipe 309 5
 stovepipe elbow 309 6
 stove screen 309 8
 stove tile 266 35
 stowage 227 26; 228 27
 straddle 298 23
 straddle jump 298 23
 straddle position 296 30
 straddle seat 295 18
 straight ball 305 17
 straightedge *Paperhanger* 128 39
 straightedge *Metalwkr.* 140 56
 straightedge rule 179 26
 straight hang 296 38
 straight header 282 12
 straight inverted hang 296 37
 straight thrust 294 7
 strainer *Paperm.* 172 54
 strainer *Water* 269 32
 strainer, basket ~ 67 12
 strainer, rotary ~ 172 23
 strain insulator 152 38
 strait 14 24
 Strait of Gibraltar 14 24
 straits bridge 215 57
 strake, outside ~ 285 50
 stramonium 379 8
 stramony 379 8
 strampler 29 23
 strand 162 54
 strand of fruit 384 8
 strand of moulds 147 36
 strap *Clocks* 110 5
 strap *Bldg. Site* 119 60, 65
 strap *School* 260 11
 strap *Cyc. Racing* 290 22
 strap *Winter Sp.* 301 3
 strap hinge 140 51
 strap support 286 59
 stratification 12 1
 stratocumulus 8 3
 stratosphere 7 8
 stratosphere aircraft 7 15
 stratovolcano 11 15
 stratum, impermeable ~ *Phys. Geog.* 12 28
 stratum, impermeable ~ *Water* 269 36
 stratum, impervious ~ *Phys. Geog.* 12 28
 stratum, impervious ~ *Water* 269 36
 stratum, porous ~ 12 29
 stratum, water-bearing ~ *Phys. Geog.* 12 22
 stratum, water-bearing ~ *Water* 269 2, 38
 stratus 8 4
 straw *Agr.* 63 34, 36
 straw *Livestock* 75 7
 straw *Basketm.* 136 30
 straw *Station* 206 23
 straw *Restaurant* 266 46
 straw baler 63 35
 strawberry 58 21
 strawberry flan 97 22
 strawberry plant 58 16
 straw fiddle 324 61
 straw hive 77 52

straw press 63 35
 straw shaker 64 14
 strawwalker 64 14
 straw yard system 74 1-17
 stream *Phys. Geog.* 13 8
 stream *Map* 15 80
 stream *Park* 272 45
 stream, subglacial ~ 12 52
 stream, underground ~ 269 3
 streamer 253 9
 streamer, paper ~ 306 66
 streamlining, integrated ~ 189 44
 street 37 61; 198 13
 street, cross-section of a ~ 198
 street café 268 59
 streetcar 197; 268 46
 streetcar schedule 268 27
 streetcar service 197 13
 streetcar stop 268 25
 streetcar stop sign 197 36; 268 26
 streetcar track 268 23
 street cleaner 199 41; 304 8
 street cleaning 199
 street-cleaning lorry 199 41; 304 8
 street corner 198 12
 street lamp 37 62; 268 6
 street lamp, suspended ~ 268 49
 street light 37 62; 268 6
 street map 204 15; 268 2
 street sign 268 7
 street sweeper 199 5; 268 20
 stretcher *Fire Brig.* 270 23
 stretcher *Rowing* 283 47
 stretcher, emergency ~ 21 23
 stretcher, wedged ~ 338 20
 stretcher bar 202 29
 stretch girdle 32 5
 stretching 170 46, 55
 stretching, final ~ 170 47
 stretching, preliminary ~ 170 45
 stretching bond 118 59
 stretching course 118 63
 stretching machine 100 18
 streusel cake 97 35
 streusel slice 97 43
 stridulating apparatus 81 8
 stridulating mechanism 81 8
 strike *Phys. Geog.* 12 2
 strike *Composing Rm.* 175 37
 striker *Hunt.* 87 21
 striker *Ball Games* 291 15
 striker pad 255 47
 striking circle 292 16
 striking force control 249 10
 striking mechanism 325 3
 striking of coins 252 40-44
 striking surface *Tobacc. etc.* 107 24
 striking surface *Ball Games* 293 31
 striking weight 110 28; 309 60
 string *Roof & Boilerr.* 38 26
 string *Sports* 305 59
 string *Music. Instr.* 322 44, 55; 323 9, 61; 325 7

string, catgut ~ 324 6, 14
 string, chalked ~ 128 45
 string, fretted ~ 324 24
 string, gut ~ 324 6, 14
 string, nylon ~ 324 14
 string, open ~ 324 25
 string, outer ~ 123 44
 string, stopped ~ 324 24
 string, unfretted ~ 324 25
 string, wreathed ~ 123 49
 string briefs 32 23
 string course 335 52
 stringed instruments 323 1-27; 324 1-31
 stringer *Roof & Boilerr.* 38 26
 stringer *Shipbuild.* 222 50
 stringer *Aircraft* 230 47, 57
 stringer *Sailing* 285 55
 stringer, outer ~ 123 44
 string fastener 324 4
 string holder 324 4, 13
 strings 293 31
 string vest 32 22
 strip 148 66-75
 stripe, magnetic ~ 117 82
 striped hyena 368 1
 strip flooring 123 62
 stripper *Paperhanger* 128 1, 9
 stripper *Nightclub* 318 27
 stripping 89 11
 stripping knife 128 15; 134 37
 stripping table 179 23
 strip steel 143 11
 striptease act 318 27-32
 striptease artist 318 27
 striptease number 318 27-32
 strip window 37 86
 strobile 376 19
 stroke *Rowing* 283 12
 stroke *Music. Not.* 320 6
 stroke, plain ~ 277 2
 strokes 136 1-4
 stroller 28 37
 strong beer 93 26
 strong man 308 27
 strong room 250 11
 structural parts of ship 222 44-61
 structural system, Gothic ~ 335 27-35
 structure, geological ~ 154 57-68
 structure, longitudinal ~ 222 44-56
 structures, molecular ~ 1 9-14
 strut *Bldg. Site* 119 63, 67
 strut *Carp.* 120 27, 54
 strut *Roof* 121 58, 69, 82
 strut *Ship* 223 61
 strut *Aircraft* 229 11
 strut *Rowing* 283 46
 strut *Winter Sp.* 303 5
 strut, diagonal ~ *Bldg. Site* 118 88
 strut, diagonal ~ *Bridges* 215 4
 stub 84 14
 stub axle 192 78
 stubble beard 34 23
 stubble field 63 33
 stub wing 232 3
 stud *Carp.* 120 25

stud *Roof* 121 40
 stud *Mach. Parts etc.* 143 22
 stud, ornamental ~ 253 8
 stud, rubber ~ 187 84
 stud, screw-in ~ 291 28
 student 262 9, 10
 student input device 242 4
 student response device 242 4
 studio *Broadcast.* 238 18
 studio *Art. Studio* 338 1-43
 studio, artist's ~ 338
 studio, sculptor's ~ 339
 studio apartment 37 74
 studio complex 310 1-13
 studio easel 338 3
 studio electrician 310 37
 studio flat 37 74
 studio lot 310 1
 studio microphone *Broadcast.* 238 34
 studio microphone *Films* 310 31
 studio skylight 338 1
 studio table 238 29
 studio window 238 38
 study in oils 338 36
 study step counter 242 5
 stuff 173 1, 2-10
 stuff box 173 11
 stuff chest 172 85, 86; 173 1, 13
 stuffing box *Oil, Petr.* 145 26
 stuffing box *Railw.* 210 33
 stuffing box *Ship* 223 64
 stuff preparation plant 172 79-86
 stump 84 14
 stump of tooth 24 27
 stunner, electric ~ 94 7
 stunning device 94 3
 stupa 337 21, 28
 Stuttgart Planetarium 5 17-28
 sty 62 8
 style 58 42; 59 15; 68 34; 370 55; 373 5; 378 5
 style jump 288 50-51
 styling scissors 106 34
 stylobate 334 32
 stylus 341 25
 stylus, conical ~ 241 26
 stylus, elliptical ~ 241 26
 stylus, steel ~ 341 21
 stylus force control 241 24
 stylus pressure control 241 24
 sub-base course, bituminous ~ 198 2
 sub-base course, gravel ~ 200 60
 sub-base course, hardcore ~ 200 60
 subcontra octave 321 42
 sub-drainage 200 61
 subfloor 123 38, 73
 subgrade grader 201 1
 sub-machine gun 255 8
 submarine 258 64
 substation, outdoor ~ 152 29-35
 substitute 291 54; 292 39
 substitute flags 253 30-32
 substitute signal 203 6
 substructure *Oil, Petr.* 145 2

substructure *Offshore Drill.* 146 38
 subtitle 185 47
 subtracting 344 24
 subtraction 344 24
 subtrahend 344 24
 succory 57 40; 376 25
 sucker *House Insects etc.* 81 37
 sucker *Optich.* 111 23
 sucker *Invertebr.* 357 21
 sucker rod 145 25
 sucking organ 358 17
 suction 162 25, 28, 36
 suction apparatus *Dent.* 24 11
 suction apparatus *Poultry Farm* 74 41
 suction box *Poultry Farm* 74 41
 suction box *Cotton Spin.* 164 44
 suction box *Paperm.* 173 15
 suction control 50 72
 suction control, fingertip ~ 50 74
 suction control, sliding ~ 50 74
 suction dredger 216 59
 suction electrode 23 29
 suction feeder 180 72
 suction head 217 51
 suction hose *Household* 50 75
 suction hose *Fire Brig.* 270 67
 suction hose, soft ~ 270 30
 suction pipe *Roof & Boilerr.* 38 55
 suction pipe *Docks* 226 32
 suction pipe *Water* 269 5, 14, 41
 suction pipe *Theatre* 316 52
 suction pipe, trailing ~ 216 59
 suction port 199 43
 suction pump 216 62
 suction roll 173 16
 suction slot 168 43
 suction tube 10 37
 sugar 98 53-55
 sugar, confectioner's ~ 98 54
 sugar, refined ~ 98 55
 sugar beet 68 44
 sugar beet eelworm 80 51
 sugar bowl 44 32; 265 20
 sugar cane 382 52
 sugar loaf 99 64
 suit, asbestos ~ 270 46
 suit, casual ~ 33 17
 suit, denim ~ 31 58; 33 20
 suit, extra-vehicular ~ 6 18-27
 suit, jersey ~ 29 17
 suit, men's ~ 33 1
 suit, one-piece ~ 29 17
 suit, quilted ~ 29 38
 suit, single-breasted ~ 33 1
 suit, two-piece ~ 29 12
 suitcase 194 19; 204 6; 205 7
 suitcase, light ~ 267 15
 suitcase, lightweight ~ 267 15
 suite, upholstered ~ 42 21-26
 suiting 104 3
 suits 276 38-45

suits, German ~ 276 42-45
 suit trousers 33 3
 sulfate *see* sulphate
 sulfide *see* sulphide
 sulfur *see* sulphur
 sulfuric *see* sulphuric
 sulky 289 24
 sulphate pulp mill 172 1-52
 sulphur 351 23
 sulphur-crested cockatoo 363 1
 sulphuric acid 170 23, 24
 sulphuric acid, production of ~ 156 34
 sulphuric acid supply 156 33
 sultana 98 8
 sum 344 23
 Sumatra cigar 107 2
 summer 121 67
 summer beam 121 67
 summer blouse 31 22
 summer coat 31 20
 summer dike 216 48
 summer dress 31 9
 summerhouse 52 14
 summer quarters, animals' ~ 356 11
 summer slacks 31 52
 summer solstice 3 8
 summer wear 31
 summit 12 40
 sump Coal 144 47
 sump *Intern. Combust. Eng.* 190 41
 sump filter 192 18
 sun 4 10-21, 29, 36-41, 42
 sun bather 281 12
 sunbathing area *Dwellings* 37 46
 sunbathing area *Spa* 274 12
 sunbathing area *Swim.* 281 11; 282 4
 sun bed 281 5
 sun blind 37 71
 sun canopy 274 14
 sun deck 223 22
 sundew 377 14
 sundial 110 30
 sun disc, winged ~ 333 12
 sundress, child's ~ 29 13
 sun filter 6 22
 sunflower 51 35; 52 7; 69 20
 sunflower oil 98 24
 sunglasses 6 19; 111 6; 301 19
 sunglass pocket 6 19
 sun hat 29 16; 35 37
 sunlight 155 18
 sun lounge 37 70
 sun parlor 37 70
 sun ray lamp 281 13
 sun roof 37 75
 sunroof, steel ~ 193 24
 sun rose 377 20
 sun sensor 10 69
 sunshade *Dwellings* 37 48, 71
 sunshade *Town* 268 61
 sunshade *Park* 272 58
 sunshade *Films* 313 3
 sun spectacles 111 6
 sunspot 4 37, 38
 sun terrace 37 75

supatap 126 35
 super *Bees* 77 45
 super *Theatre* 316 39
 Super-calender 173 36
 supercilium 19 38
 super grade gasoline 145 55
 super grade petrol 145 55
 superheater 152 9
 supermarket 99 1-96
 supernumerary 316 39
 superstructure *Weaving* 165 6
 superstructure *Ship* 221 10, 69
 superstructure, aft ~ 258 22
 superstructure, compact ~ 221 33
 superstructure, forward ~ 259 45
 superstructure deck 258 10
 superstructures 258 10-28
 Super-Vee racing car 290 37
 supplementary angle 346 14
 supply pipe *Butch.* 96 50
 supply pipe *Plumb. etc.* 126 9
 supply sprocket 312 26
 supply table 74 51
 supply vessel 221 32
 support *Plant Propagn.* 54 33
 support *Roof* 121 83
 support *Knitting* 167 38
 support *Offset Platem.* 179 20
 support *Shipbuild.* 222 27
 support *Circus* 307 29, 45
 support, adjustable ~ 67 22
 support, intermediate ~ 214 29, 76
 support, single-pylon ~ 214 23
 support, three-point ~ 349 28
 support, tubular steel ~ 214 78
 support cable 2 30
 supporters 254 15-16
 support guide rail 214 79
 supporting cable 214 27, 38, 41, 44
 supporting cable anchorage 214 59
 supporting cable brake 214 71
 supporting cable guide 214 58
 supporting cable guide rail 214 79
 supporting insulator 153 54
 supporting pulley 163 46
 supporting structure 337 9
 supporting wall 121 77
 support insulator 153 54
 support roll 270 50
 support truss 214 80
 suppressor 190 35
 surcoat 355 25
 surf 13 27
 surface, asphalt ~ 200 58
 surface, bituminous ~ 198 5
 surface, curved ~ 347 40
 surface, flat ~ 111 39
 surface, hatched ~ 151 29
 surface, icy ~ 304 19
 surface, lunar ~ 6 13
 surface, nap ~ 168 31
 surface, plane ~ 347 31
 surface, raised ~ 168 31

surface, special ~ 111 40, 41, 42
 surface boundary layer 7 7
 surface chart 9 1-39
 surface condenser 152 24
 surface finisher 200 43
 surface-finish microscope 112 37
 surface hydrant 270 35
 surface not to be machined 151 20
 surfaces, plane ~ 346 24-58
 surface skimmers 286 38-44
 surface synoptic chart 9 1-39
 surface-to-air missile launcher 259 50
 surface-to-air rocket launcher 259 50
 surface to be machined 151 21
 surface to be superfinished 151 22
 surface wave 11 36
 surfacing 111 36
 surfboard 279 1, 2; 280 15; 284 5
 surfboarder 279 5; 280 14
 surfer 279 5; 280 14
 surfing 279 1-6; 280 13
 surf riding 279 1-6; 280 13
 surge baffle system 235 53
 surge diverter 152 35
 surgery 22 32-74
 surge tank 217 40
 surgical instruments 26 40-53
 surgical unit 26 1-54
 sur le cou-de-pied 314 14
 surroyal 88 9
 survey illumination 112 52
 surveying 14 46-62
 surveying, geodetic ~ 14 46-62
 surveying level 14 48
 surveyor's level 14 48
 suspect 264 32
 suspender *Underwear etc.* 32 6
 suspender *Bridges* 215 41
 suspender *Nightclub* 318 28
 suspenders 29 26, 34; 32 30; 33 45
 suspension 168 16
 suspension, steel and rubber ~ 207 4
 suspension and haulage cable 214 21
 suspension arm, lower ~ 192 84
 suspension bridge 215 39
 suspension bridge, primitive ~ 215 15
 suspension cable *Railw.* 214 27, 38, 41, 44
 suspension cable *Bridges* 215 40
 suspension cable anchorage *Railw.* 214 59
 suspension cable anchorage *Bridges* 215 43
 suspension cable bearing 214 33
 suspension cable brake 214 71

suspension cable guide 214 58
 suspension cable guide rail 214 79
 suspension damper 192 76
 suspension file 248 3
 suspension file system 248 2
 suspension gear 214 54
 suspension gear bolt 214 72
 suspension line 288 40
 suspension line, double-cable ~ 214 25, 30
 suspension line gondola 214 52
 suspension lines, single-cable ~ 214 15-24
 suspension line support 214 76
 suspension rope 215 17
 suspension spring 192 74
 sustaining pedal 325 8
 suture material 22 56; 26 21
 swab 137 3
 swab dispenser 22 36
 swage block *Goldsm. etc.* 108 18
 swage block *Blacksm.* 137 17
 swage block *Metalwkr.* 140 14
 swage head 143 57
 swallow 361 20
 swallowhole 11 49; 13 71
 swallowtail 358 52
 swallow-tail twin crystal 351 25
 swamp 13 24
 Swan *Astron.* 3 23
 Swan 272 54; 359 16
 Swan *Birds* 359 16
 swan-neck 37 12; 122 30
 swan's neck 37 12; 122 30
 swarf 149 44
 swarm cluster of bees 77 53
 swarming net 77 54
 swarm of bees 77 53
 swath 63 23, 36
 swathe 63 23, 36
 swather 63 19
 swather, rotary ~ 63 26; 64 40-45
 swath rake 64 44
 swath reaper 63 19
 sweater 29 43; 31 51
 sweater, short-sleeved ~ 33 32
 sweepback, positive ~ 229 21
 sweepback, semi-positive ~ 229 20
 sweeper, mechanical ~ 199 39
 sweet 98 75, 80
 sweet bread 97 40
 sweet calamus 377 22
 sweet cherry 59 5
 sweet chestnut 384 48
 sweet corn 68 31
 sweet flag 377 22
 sweet gale 373 33
 sweet pepper 57 42
 sweets 47 31, 32
 sweet sedge 377 22
 sweet syringa 373 9
 sweet william 60 6
 swell 325 45
 swell pedal, balanced ~ 326 50

swift 359 24
 swimming 282
 swimming bath 281
 swimming bath attendant 281 4; 282 15
 swimming belt 282 19
 swimming cap 280 29, 44
 swimming instruction 282 16-20
 swimming instructor 282 16
 swimming lane 282 31
 swimming pool 223 23; 281 1-9
 swimming pool, open-air ~ 282 1-32
 swimming pool attendant 281 4; 282 15
 swimming strokes 282 33-39
 swimming teacher 282 16
 swimming trunks 280 43
 swimsuit 280 42
 swing *Gymn.* 297 39
 swing *Athletics* 298 30
 swing, double ~ 273 39
 swing boat 308 41, 42
 swing bridge, flat ~ 215 67
 swing door 207 18
 swing-grippers 180 33
 swing pipe 172 10
 swing seat 273 40
 swing wing 256 9
 Swiss chard 57 28
 Swiss cheese 99 41
 Swiss roll 97 19
 Swiss stone pine 372 29
 switch *Electr.* 127 7
 switch *Garage* 195 4, 12
 switch *Aircraft* 230 26
 switch, main ~ *Joiner* 132 58
 switch, main ~ *Railw.* 211 3, 31
 switch, main ~ *Office* 249 37
 switch, manually-operated ~ 202 16
 switch, remote-controlled ~ 202 27
 switch, rotary ~ *Electr.* 127 18
 switch, rotary ~ *Office* 245 28
 switchback 308 39
 switch blade 202 21
 switchboard *Post* 237 17, 22-26
 switchboard *Office* 245 13
 switch engine 206 43
 switcher 206 43
 switches, single ~ 203 45-48
 switching box 237 25
 switching centre 237 25, 41
 switching device 269 47
 switching system 153 5
 switching system, automatic ~ 237 25
 switch knob 203 62
 switch lever *Mach. Tools* 149 11; 150 35
 switch lever *Railw.* 203 55
 switch lock 202 28
 switch signal 197 38; 202 19
 switch signal, electrically illuminated ~ 202 33
 switch signal lamp 202 19

switch signals 203 45-52
 switch stand 202 17
 switch tongue 202 21
 switch tower 15 24
 switch tower, electrically-operated ~ 203 61
 switch tower, manually-operated ~ 203 53
 switch yard 206 42
 swivel *Fish Farm.* 89 77
 swivel *Oil, Petr.* 145 10
 swivel arm 26 13; 104 27; 105 26
 swivel chair 246 1; 248 25
 swivel coupling 50 69
 swivel head 50 60
 swivel mechanism 65 73
 swivel motor 132 69
 swivel nozzle 235 64
 swivel saddle 188 21
 swivel tap 126 36
 swop platform 194 23
 sword 319 32
 sword antenna 256 28
 sword lily 60 11
 swordsman 319 25
 sword swallower 308 26
 S-wrench, adjustable ~ 126 66
 symbol, algebraic ~ 344 9; 345 5
 symbols, geometrical ~ 345 21-24
 symbols, mathematical ~ 345 15-24
 symphysis, pubic ~ 20 65
 symphonia 322 25
 syncarp 384 63
 sync head 243 34
 synchro 153 32
 synchromesh gearbox, four-speed ~ 192 28-47
 synchronization 311 37-41
 synchronization start 117 65
 synchronization unit 117 77
 synchronizing cone 192 33
 synchronizing filter 311 27
 syncing 311 37-41
 syncline 12 18
 sync pulse cable 313 29
 sync start 117 65, 69
 sync track 243 33
 synthetic fibres 169; 170
 syringe 22 54, 65
 syringe, hypodermic ~ 24 53
 syringe, multi-purpose ~ 24 10
 syrinx 322 2
 system, ancillary ~ 211 34
 system, planetary ~ 4 42-52
 system camera 115 1-105
 system-monitoring device 234 17
 system of accessories 115 43-105
 system of coordinates 347 8, 11
 system of flaps 229 37

T

tabard 30 50
 tabby weave 171 1
 tabernacle 330 42
 table *Forging* 139 20
 table *Restaurant* 266 74
 table *Playground* 273 2
 table *Music. Instr.* 324 3
 table *Art* 336 14, 16
 table, auxiliary ~ *Blacksm.* 137 14
 table, auxiliary ~ *Mach. Tools* 150 28
 table, director's ~ 316 42
 table, flat ~ 36 46, 72, 73, 74
 table, producer's ~ 316 42
 table, revolving ~ 148 41
 table, rotary ~ 145 15
 tableau curtain 315 2
 table bed 277 15
 tablecloth 45 2
 table decoration 45 19; 266 78
 table en cabochon 36 47
 table en cabochon, antique ~ 36 76
 table en cabochon, rectangular ~ 36 77
 table feed drive 150 34
 table lamp 46 24; 246 35
 tableland 13 46
 table leg 44 2
 table linen 271 57
 table napkin 45 9
 table pedestal 26 6
 table piano 325 40
 table rise adjustment 133 23
 table runner 46 35
 table telephone, standard ~ 237 6
 table tennis 273 1; 293 45-55
 table tennis ball 273 5; 293 48
 table tennis bat 273 4; 293 45
 table tennis net 273 3; 293 53
 table tennis player 293 49
 table tennis racket 273 4; 293 45
 table tennis table 293 52
 table top *Dining Rm.* 44 3
 table top *Arc Weld.* 142 14
 table-top tripod 115 99
 table tripod 115 99
 tableware 45
 tabulator clear key 249 8
 tabulator key 249 7
 tachograph 210 54
 tachometer *Weaving* 166 2
 tachometer *Knitting* 167 43
 tachometer *Letterpress* 181 54
 tachometer *Car* 191 38
 tachometer *Railw.* 212 22
 tachometer *Aircraft* 230 8
 tack 285 25
 tacking 285 25-28
 tackle 219 1-72; 221 27, 104
 taffrail log 224 54
 tagetes 60 20
 tail *Horse* 72 38

tail *Game* 88 19, 47, 49, 58, 62, 67, 75, 80
 tail *Roof* 122 89
 tail *Bookbind.* 185 58
 tail *Birds* 362 8
 tail *Mammals* 367 29
 tail, cruciform ~ 229 28
 tail, curly ~ 73 12
 tail, docked ~ 70 12
 tail, dolphin's ~ 327 25
 tail, falcate ~ 73 25
 tail, fish's ~ 327 25, 43, 46, 49
 tail, horizontal ~ 229 26-27, 35; 230 61; 257 21
 tail, normal ~ 229 23
 tail, prehensile ~ 364 35
 tail, raised ~ 229 35
 tail, serpent's ~ 327 31
 tail, tufted ~ 73 6
 tail, vertical ~ 229 24-25; 230 58
 tailband 185 42
 tail bracing wire 232 4
 tailcoat 33 13
 tail end shaft 223 60
 tail fin *Aircraft* 229 24; 230 59; 231 6; 232 7
 tail fin *Air Force* 256 32
 tail fin *Airsports* 288 21
 tail fin *Fish etc.* 364 10
 tail fluke 367 29
 tailgate 193 16, 20; 195 50
 tailings auger 64 21
 tailings outlet 64 22
 tail line 122 81
 tail loading gate 232 25
 tail margin 185 58
 tail of kite 273 43
 tailor 104 22; 271 37
 tailor's chalk 271 39
 tailor seat 295 11
 tailpiece 323 7
 tailpin 323 22
 tailplane 229 26; 230 62; 256 31; 288 23
 tailpole 91 32
 tail propeller 232 28
 tail rotor 232 14; 264 4
 tails 33 13
 tail shaft 223 60
 tail shapes 229 23-36
 tail skid 256 23
 tail slide 288 5
 tail sting 358 43
 tailstock *Turner* 135 7
 tailstock *Mach. Tools* 149 29; 150 5
 tailstock *Photomech. Reprad.* 177 62
 tailstock barrel 149 27
 tailstock barrel adjusting handwheel 149 30
 tailstock barrel clamp lever 149 28
 tailstock centre 149 26
 tail unit, cruciform ~ 229 28
 tail unit, double ~ 229 32, 34
 tail unit, normal ~ 229 23
 tail unit, triple ~ 229 36
 tail unit shapes 229 23-36
 tail vice 132 37

tail wheel 256 27
 take-down weight 167 32
 lake number 310 35
 take-off 298 26, 37
 take-off, balloon ~ 288 84
 take-off board 298 38
 take-off shaft 65 31
 take-off stand 165 41
 taker-in 163 53
 take-up reel 117 80
 take-up spindle 312 37
 take-up spool *Photog.* 115 25
 take-up spool *Cine Film* 117 32, 80
 take-up sprocket 312 27
 taking lens 313 2
 talcum powder 99 29
 talkback equipment 238 64
 talkback microphone 238 10, 53
 talkback microphone, producer's ~ 238 39
 talkback speaker 238 8, 52
 talkback system 238 64
 talk button 242 24
 talk key 242 24
 talon *Stock Exch.* 251 19
 talon *Birds* 362 7
 talus 11 47; 12 45
 tambour door 245 5
 tambourine *Disco* 317 27
 tambourine *Music. Instr.* 324 45
 tamer 307 52
 tamper 200 26; 201 13
 tamping beam 200 32; 201 2
 tandem 186 50
 tandem kayak 283 5
 tang 45 52, 60
 tangent *Music. Instr.* 322 43
 tangent *Maths.* 346 32, 48
 tangent screw 14 56
 tangerine 384 23
 tank *Cooper* 130 1
 tank *Lorries etc.* 194 30
 tank *Army* 255 80
 tank, bottom ~ 222 38
 tank, concrete ~ 310 11
 tank, side ~ 222 37
 tank, spherical ~ 145 73; 221 36
 tank bottom valve 38 49
 tank car 213 31
 tank construction engineer 130
 tanker *Docks* 225 73
 tanker *Airport* 233 22
 tanker terminal 145 74
 tank farm 225 61
 tank for sterilized milk 76 16
 tank furnace 162 1
 tank inlet 38 47
 tank locomotive 210 65
 tank margin plate 222 51
 tank reel 116 2
 tank spiral, multi-unit ~ 116 4
 tank top 222 54
 tank top plating 222 54
 tank vent 234 44
 tank wagon 213 31

tansy 380 9
 tap *Doc.* 23 49
 tap *Metalwkr.* 140 60
 tap *Power Plant* 153 18
 tap *Spa* 274 17
 tap *Disco* 317 8
 tap *Chem.* 349 5, 22; 350 44, 53
 tap, outside ~ 37 41
 tap bar 148 9
 tap changer 211 10
 tapchanger driving mechanism 211 13
 tape *Ball Games* 293 73
 tape *Music. Instr.* 325 36
 tape, adhesive ~ 98 47; 134 38; 247 29
 tape, magnetic ~ 25 46
 tape, varnished-cambric ~ 153 46
 tape cassette 117 76
 tape counter 241 64; 243 9
 tape deflector roller 241 60
 tape feed 243 29
 tape guide 243 22
 tape measure 103 2; 271 38
 tape punch 176 5
 taper wax ~ 77 65
 tape recorder 117 70; 317 21; 318 17
 tape recorder, four-track ~ 242 13
 tape recorder, portable ~ 309 37
 tape recorder, two-track ~ 242 12
 tape reel, open ~ 241 57
 taper thread, female ~ 126 47
 tape speed selector 241 62
 tapestry wallpaper 128 18
 tape threading indicator light 243 14
 tape wire 325 35
 tapeworm 81 35
 tap hole 147 50
 tapir 366 26
 tappet 166 57
 tappet shaft 166 56
 tapping 153 18
 tapping a spring 269 24-39
 tapping bar 148 9
 tapping hole 147 50
 tapping spout 148 3
 taproot, swollen ~ 370 79
 tap wrench 140 30
 tar 170 4
 tar and bitumen heater 200 46
 target *Inf. Tech.* 242 84
 target *Sports* 305 30, 32, 66, 77
 target, bobbing ~ 305 33, 48
 target, turning ~ 305 33, 48
 target archery 305 52-66
 target areas 294 51-53
 target cross 288 56
 target jack 305 23
 target rectangle 292 34
 targets 305 30-33
 tar-spraying machine 200 46
 tar storage tank 200 47
 tarsus *Man* 17 26
 tarsus *Birds* 362 4

tartlet 97 20
 tasse 329 49
 tassel *Headgear* 35 24
 tassel *Arable Crops* 68 35
 tassel *Hist. Cost.* 355 23
 tasset 329 49
 tatting 102 19
 tatting shuttle 102 20
 tattoo 306 44
 tau cross 332 59
 Taurus 3 25; 4 54
 taxi 268 64
 taxicab 268 64
 taxi rank 268 63, 66
 'taxis' 233 32
 taxi sign 268 65
 taxi stand 268 63, 66
 taxi telephone 268 67
 taxiway 233 2
 T-cut 54 32
 tea *Grocer* 98 65-68
 tea *Supermkt.* 99 68-70, 69
 tea *Trop. Plants* 382 9
 tea bag 98 68
 teacher 260 21
 teaching equipment 242; 242 45-84
 teaching laser 242 81
 teaching machine 242 1
 teaching material 261 27
 tea dance 267 44-46
 tea leaf 382 9
 team of oxen 63 16
 tea plant 382 7
 tea plate 39 34
 tear bag 88 14
 tear-off edge 247 30
 tea room 265 1-26
 teat *Infant Care etc.* 28 20
 teat *Livestock* 75 19
 teat cup 75 30
 teat cup cluster 75 26
 tea tree 382 7
 technical drawing 151 16
 technical laboratory 310 9
 Teclu burner 350 4
 tectogenesis 12 4-20
 tedder, rotary ~ 63 24; 64 46-58
 teddy bear 28 46; 273 26; 309 12
 teddy bear, rocking ~ 48 30
 tee 126 44, 47
 tee *Ball Games* 293 90
 teeing ground 293 79
 tee-iron 143 3
 teepee 352 7
 tee-square 151 9
 teeth 19 16-18
 teeth, false ~ 24 25
 teeth grinder 157 43, 45
 teething ring 28 12
 teeth of knock-over bit 167 52
 telecobalt unit 2 28
 telegraphy 237 30
 telemetry antenna 10 70
 telephone 22 18; 41 7; 238 23; 246 13; 248 9
 telephone, public ~ 236 9; 237 1, 3

telephone, toy ~ 47 35
 telephone adapter socket 249 67
 telephone answering and recording set 22 13
 telephone answering device 22 13
 telephone book 236 12; 237 5
 telephone booth 204 46; 236 8; 237 1; 251 10; 268 56
 telephone box 204 46; 236 8; 237 1; 251 10; 268 56
 telephone cable 198 15
 telephone cable pipeline 198 16
 telephone casing 237 15
 telephone connection 242 20
 telephone cover 237 15
 telephone customer 237 2
 telephone directory 236 12; 237 5
 telephone directory rack 236 10
 'telephone - emergency calls only' 233 40
 telephone exchange 237 27-41
 telephone exchange, internal ~ 245 13
 telephone index 22 21
 telephone instruments 237 6-26
 telephone kiosk 204 46; 236 8; 237 1; 251 10; 268 56
 telephone line, customers' ~ 198 20
 telephone line, subscribers' ~ 198 20
 telephone list, internal ~ 245 17
 telephone number 237 38
 telephone receiver 237 7; 246 16
 telephones 237 6-26
 telephone service 237 41
 telephone subscriber 237 2
 telephone switchboard panel 238 14
 telephone user 237 2
 telephoto lens 117 47
 teleprinter 176 31; 237 31, 61, 66; 238 12
 telescope 14 60; 42 15; 224 8
 telescope, gimbal-mounted ~ 235 68
 telescope, monocular ~ 111 18
 telescope, reflecting ~ 113 1
 telescope, refracting ~ 113 16
 telescope, surveyor's ~ 14 48
 telescope magnifier 113 38
 telescope mountings 113 16-25
 telescope mounts 113 16-25
 telescope sight 87 29; 255 28; 305 49
 Teletype 176 31
 teletypewriter 237 31
 television 238; 239
 television cabinet 240 2
 television camera 10 67; 112 36; 154 78; 240 26

television disc system 243
37-45
television engineering 240
television mast 15 33
television OB van 239 1-15
television post-sync studio
238 27-53
television programmes 342 64
television receiver 242 28
television receiver, domestic
~ 243 6
television receiving aerial 239
4, 5
television reception aerial
239 4, 5
television set 42 8; 46 14; 242
28
television sound 242 27
television tube 240 3
telex link 237 65
telex message 237 69
telex service 237 41
telex tape 237 68
Telford base 260 60
teller 250 2
tempera 338 17
temperature 9 8
temperature gauge 179 4
temperature gauge, distant-
reading ~ 210 48
temperature graph 7 37
temperature regulation flap
10 65
temperature regulator 191 84
temperature scale 7 36
temperature selector 50 8
tempest 284 54
template 126 83
template, circular ~ 141 35
temple *Man* 16 6
temple *Weaving* 166 13
temple *Art* 337 7
temple, Doric ~ 334 1
temple, Etruscan ~ 334 49
temple, funerary ~ 333 7
temple buildings 337 25
temple tower 333 32; 337 1, 26
temple wall 334 6
temporalis 19 3
tender *Railw.* 210 38
tender *Warships* 258 92
tender platform 210 2
tendo calcaneus 18 48
tendrils 57 4
tendrils, thorny ~ 58 30
tennis 293 1-42
tennis ball 293 28
tennis court 293 1
tennis net 293 13
tennis player 293 16
tennis racket 41 13; 293 29
tennis shoe 101 36
tenon saw 132 44
tenor clef 320 11
tenor horn 323 39
tenor trombone 323 46
tenor viol 322 23
tenpin bowling 305 14-20
tens 344 3
tension and slub-catching
device 165 13

tension bar 167 49
tension cable, inclined ~ 215
47
tension cable pulley 214 43
tension compensator 165 51
tension equalizer 165 51
tension hoop 324 56
tensioning device *Agr. Mach.*
64 94
tensioning device *Railw.* 208
18
tensioning lever 208 18
tensioning screw 323 53
tension roller *Joiner* 133 13
tension roller *Letterpress* 181
45
tension weight *Knitting* 167
50
tension weight *Railw.* 214 41,
42
tension weight shaft 214 40
tent 80 7
tent, four-pole ~ 307 1
tentacle 357 16, 31
tenter 165 54; 168 21
tenter clip 168 24
tenter pin 168 24
tent peg 278 24
tent pole 278 38; 307 2; 352 8
tent prop 307 13
tenuto 321 30
tepee 352 7
teres major 18 55
teres minor 18 54
tergites 358 31
term 344 23
terminal *Docks* 226 16
terminal *Airport* 233 15
terminal box 211 16
termination of speed
restriction 203 40
tern 359 11
terrace 37 36
terracette 13 64
terrarium 356 14
terrestrial meridian 14 4
terrier 70 15, 16, 17, 18, 27,
39
terry towel 49 9
tessellation 338 37
tessera 338 39
tesseral crystal system 351
1-17
test equipment 195 17
testicle, right ~ 20 72
testing and control station
237 40
testing board 237 29
testing desk 237 29
testing device for waterproof
watches 109 26
testing kit 138 14
testis 20 72
test meter, universal ~ 127 41
test oil and gas separator 146
10
test separator 146 10
test tube 350 34
test tube rack 173 8; 261 31;
350 35
lether 75 15-16

tetradrachm 252 1
tetragonal crystal system 351
18-19
tetrahedrite 351 1
tetrahedron 351 1
text 237 68
textbook 261 28
thalamus 370 53
thallus 378 49
Thaumatolampas diadema
369 4
T-head bolt 202 10
theater *see* theatre
theatre *Astron.* 5 26
theatre *Theatre* 315; 316
theatre, Greek ~ 334 44
theatre, open-air ~ 272 6
theatre projector 312 24
theatre seat 315 20
theatre ticket 315 11
thé dansant 267 44-46
theodolite 14 52-62
theorbo 324 1
thermal 287 21
thermal protection shield 234
5, 20
thermal soaring 287 20
thermograph 10 19, 51
thermometer *Meteorol. Instr.*
10 25
thermometer *Infant Care etc.*
28 29
thermometer *Text. Finish.*
168 27
thermometer *Swim.* 281 24
thermometer, ladle-type ~ 92
53
thermometers 10 53-54
thermometer screen 10 49
thermometer shelter 10 49
thermometric scale 7 36
thermoplastic 130 15
Thermos jug 40 5
thermo time switch 190 63
thickener 172 24, 42, 44, 48,
62
thickener 132 45
thicknessing machine 132
45
thicknessing table 132 46
thief 308 16
thigh 16 49; 17 22
thigh bone 17 22
thill 186 19, 30
thiller 186 28
thill horse 186 28
thimble, graduated ~ 149 64
thinner *Painter* 129 16
thinner *Art. Studio* 338 13
thinning 84 37
thinning razor 105 9; 106 41
thinnings, small-sized ~ 84
37
thinning scissors 105 8; 106
33
thinning shears 105 8; 106 33
third base 292 47
third man 300 27
thirty-second note 320 18
thirty-second rest 320 26
thistle 61 32

Thomas converter 147 55-69
thoracic shield 82 4; 358 29
thorax *Man* 16 28-30; 17 8-11
thorax *Articulates* 358 29-30
thorn *Gdn. Flowers* 60 18
thorn *Spa* 274 2
thorn *Shrubs etc.* 374 30
thorn apple 379 8
thorn house *Map* 15 32
thorn house *Spa* 274 1
thousands 344 3
thread *Overh. Irrign.* 67 38
thread *Mach. Parts etc.* 143
16, 68
thread *Glass Prod.* 162 54
thread *Cotton Spin.* 164 53
thread *Weaving* 165 21
thread *Knitting* 167 17, 36
thread *Bookbind.* 183 11
thread, coarse ~ 149 4
thread, female ~ 126 41, 45
thread, glass ~ 162 56, 57
thread, male ~ 126 38, 51
thread, metal ~ 102 30
thread, mycelial ~ 381 2
thread, normal ~ 149 4
thread, sleeved ~ 162 57
thread chaser 135 14
thread clearer 165 20
thread container 22 61
thread cop 185 18
thread-cutting machine 125
27-126 86
thread guide *Shoem.* 100 30
thread guide *Knitting* 167 3,
54, 64
thread head 187 75
threading draft 171 5
threading key 127 30
thread interlacing 171 26
thread pitch 149 9
thread spool 185 18
thread tapper 108 15
threadworm 80 51
three 302 13
three-day event 289 16-19
three-decker 218 51-60
three-eight time 320 36
three-four time 320 37
three-masters 220 18-27
three-phase generator 153 26
three-phase plug 127 14
three-two time 320 38
threshing drum 64 12
throat *Man* 16 19; 19 14-37,
24
throat *Horse* 72 16
throat *Forestry* 84 28
throatlash 71 11; 72 16
throatlatch 71 11; 72 16
throat piece 329 42
throstle 361 16
throttle control 230 30; 288
15
throttle lever 230 30; 288 15
throttle twist grip 188 30; 189
29
throttle valve *Hosp.* 27 43
throttle valve *Car* 192 9
through-the-lens reflex
finder 117 44

thrower 161 9
throw-in 291 53
throwing act 307 43
throwing knife 354 15
throwing ring 308 47
throwing spear 328 2
throwing stick 352 40
thrush 360 3
thrushes 361 13-17
thrush nightingale 361 17
thrust bearing 221 29
thrust block 223 67; 259 60
thrust lever 257 9
thrust mount, lower ~ 235 6
thrust mount, upper ~ 235 5
thrust nozzle 234 35; 235 37
thrust nozzle fuel tank 235 45
thrust structure 234 21
thrust vector control system
235 43
thrust washer 190 56
thrust weapon 294 11, 36, 37
thuja 372 39
thumb 19 64
thumb hold 323 45
thumb hole 305 47
thumb nut 119 75
thumb piston 326 46
thundercloud 7 2
thunderstorm 9 38
thurible 332 38
thurible bowl 332 41
thurible chain 332 39
thurible cover 332 40
thwart 278 17; 283 28
thyme 334 48
tiara, papal ~ 254 37
Tibetan 353 27
tibia 17 25
tibialis anterior 18 47
tick *Bedrm.* 43 13
tick *Articulates* 358 44
tick, drill ~ 43 10
tick bean 69 15
ticket 204 36
ticket agent 204 39
ticket-cancelling machine
197 16
ticket clerk 204 39
ticket counter 197 33; 204 35
ticket machine 268 28
ticket office 204 34
ticket printer, hand-operated
~ 204 41
ticket-printing machine 204
40
ticket-stamping machine 204
40
tidal power plant 155 37
tide level indicator 225 37
tidemark 13 35
tide table 280 7
tie *Ladies' Wear* 30 46
tie *Underwear etc.* 32 41
tie *Bldg. Site* 119 39
tie *Roof* 121 59
tie *Station* 205 60
tie *Music. Not.* 321 24
tie, concrete ~ 202 37
tie, coupled ~ 202 14, 38
tie, diagonal ~ 121 30

tie, double ~ 121 50
tie, simple ~ 121 49
tie, steel ~ 202 36
tie beam 121 53
tie belt 29 55; 31 19
tie fastening 101 21
tiepin 36 22
tier, lower ~ 228 24
tier, upper ~ 228 23
tierce engagement 294 48
tiercel 86 46
tie rod 65 47
tier of oars 218 12
tie shoe 101 31
tie tube 119 49
tie-up 171 22, 23
tie-up of shafts 171 9
tiger 307 56; 368 5
tightening screw 293 33
tightrope 307 41
tightrope dancer 307 40
tights 29 42; 32 12
tilbury 186 44
tilde 342 35
tile *Bathrm. etc.* 49 19
tile *Games* 276 34
tile, flat interlocking ~ 122 60
tile, interlocking ~ 122 59
tile, plain ~ 122 6, 46
tile beard 34 16
tile cutter 122 33
tile hammer 122 20
tile roofings 122 45-60
tiles 122 45-60
tiling battens 122 17
till 207 86; 271 5
till, electric ~ 271 2
tillage 69 1-28
tiller 218 13; 284 32; 286 24
tiller extension 284 31
tillering 68 5
tilt 329 71
tilt block 12 9
tilting armour 329 76
tilting device 147 44, 59
tilting helmet 254 4; 329 77
tilting lance 329 81
tilting shield 329 79
tilting table 133 17
tilting target 329 79
tilt wing 232 27
timbale 324 57
timber 85 42
timber, end-grained ~ 120 92
timber, halved ~ 120 88
timber, long ~ 120 2
timber, round ~ 120 35; 157
30
timber, sawn ~ 157 22
timber, small ~ 84 37
timber, squared ~ 120 10; 157
36
timber, stacked ~ 84 15
timber, standing ~ 84 4
timber, undressed ~ 120 83
timber, yarded ~ 84 15
timber cutting 84 15-37
timber dog 121 97
timberjack 84 18
timber joints 121 84-98
timber planking 285 50-57

time *Music. Not.* 320 28-42
 time *Maths.* 345 7
 time ball 280 5
 time indicator 289 40
 timekeeper 282 24; 299 47
 timer *Doc.* 23 40
 timer *Hosp.* 27 35
 timer *Kitch.* 39 21
 timer *Watchm.* 109 35
 timer *Photog.* 116 18
 timer *Photograv.* 182 20
 timer *Billiards* 277 17
 timer, synchronous ~ 24 52
 timer switch, built-in ~ 243 18
 time scale *Meteorol. Instr.* 10 17
 time scale *Office* 249 74
 time scale stop 249 75
 time schedule 151 12
 time signatures 320 28-42
 timetable 204 16, 18
 timetable, driver's ~ 210 52
 timetable, official ~ 204 50
 time weight 110 29; 309 59
 timing machine, electronic ~ 109 27
 timpano 323 57
 tin 129 7
 tin, molten ~ 162 17
 tinctures 254 24-29
 tine *Tablew. etc.* 45 60
 tine *Agr. Impl.* 66 4
 tine *Game* 88 10, 31
 tine bar 64 53
 tinner's snips 125 1
 tip, adjustable ~ 149 47
 tip, controlled ~ 199 10
 tip, cork ~ 107 13
 tip, gold ~ 107 13
 tip, oxide ceramic ~ 149 47
 tip, pointed ~ 253 10
 tip-cart, three-way ~ 62 18
 tip heap 144 19
 tipper 200 7
 tipper, three-way ~ 194 24
 tipper wagon 213 37
 tipping body *Lorries etc.* 194 25
 tipping body *Road Constr.* 200 8
 tipping bucket 214 34
 tipping car 147 64
 tipping cylinder 62 19
 tipping device 147 44, 59
 tipping truck 119 28
 tipping wagon 119 28
 tippler, three-way ~ 92 34
 tip tank 231 9; 256 30
 tip-up seat 207 12
 tire *seetyre*
 tired swimmer grip 21 38
 T-iron 143 3
 tissue, erectile ~ 20 67
 tit 360 4; 361 9
 titan 327 37
 title block 151 31
 title bout 299 35-50
 title fight 299 35-50
 title page 185 45
 title panel 151 31

titmouse 360 4; 361 9
 tjalk 220 6
 T-joint 126 44, 47
 T-junction joint 126 44, 47
 toad 364 23
 toadstools 379 10-13
 toast 45 34
 toaster 40 30
 toat 132 18
 tobacco *Tobacc. etc.* 107 25
 tobacco *Trop. Plants* 382 43
 tobacco, raw ~ 83 13
 tobacco beetle 81 25
 tobacco factory 83 11
 tobacco leaf 382 43
 tobacco plant 382 40
 tobacco pouch 107 43
 tobacco presser 107 47
 toboggan 303 1, 2, 13
 toboggan, junior ~ 303 3
 toboggan cap 35 39
 toboggan slide 308 40
 toe, big ~ 19 52
 toe, first ~ 19 52
 toe, fourth ~ 19 55
 toe, great ~ 19 52
 toe, little ~ 19 56
 toe, second ~ 19 53
 toe, third ~ 19 54
 toecap 100 58; 101 16, 40
 toecap remover 100 52
 toe clip 290 21
 toenail 19 57
 toe piston 326 48
 toe post sandal 101 48
 toe stand 295 5
 toestrap 284 30
 toe unit 301 55
 toffee 98 77
 toga 355 13
 toggle 340 30
 toggle action *Letterpress* 181 16
 toggle action *Bookbind.* 183 30
 toggle fastening 30 66
 toggle-joint action 181 16; 183 30
 toggle-joint press 183 26
 toggle-lever press 183 26
 toilet 49 12; 146 29; 207 16, 42, 72; 211 59; 231 31; 278 5
 toilet bowl 49 13
 toilet cistern 126 14
 toilet-cleaning vehicle 233 22
 toilet lid 49 14
 toilet pan 49 13
 toilet paper 49 11
 toiletries 99 27-35
 toilet roll holder 49 10
 toilets 317 31
 toilet seat 49 15
 toilet water 105 37; 106 9
 tomahawk 352 16
 tomato 57 12; 99 82
 tomato plant 55 44
 tomb 331 23; 337 16
 tomb, giant's ~ 328 16
 tomb, megalithic ~ 328 16
 tomb, royal ~ 333 1

tombola 306 11
 tombola booth 308 44
 tomb recess 331 60
 tombstone 331 26
 tom cat 73 17
 tom-tom 324 48, 49
 tondo 339 36
 tone 320 51, 53
 tone arm 241 21
 tone arm balance 241 53
 tone arm lift 241 28
 tone arm lock 241 27
 tone generator 238 51
 toner roll 249 41
 tongs *Atom* 2 44
 tongs *Glass Prod.* 162 44
 tongs *Graphic Art* 340 50
 tongs, concreter's ~ 119 85
 tongs, flat ~ 137 24
 tongs, round ~ 137 25
 tongue *Man* 17 52; 19 25
 tongue *Tablew. etc.* 45 52
 tongue *Game* 88 2
 tongue *Shoem.* 100 65
 tongue *Shoes* 101 32
 tongue *Music. Instr.* 322 52; 326 19
 tongue, foam rubber ~ 291 24
 tongue, forked ~ 327 6
 tonsil 19 23
 tonsil, palatine ~ 19 23
 tonsure 331 57
 tool 195 43
 tool, stone ~ 328 1
 tool bag 187 25
 tool bit holder 149 45
 tool box *D.I.Y.* 134 35
 tool box *Mach. Tools* 150 13
 tool box *Railw.* 212 45
 tool cabinet 134 1-34
 tool case 127 49
 tool cupboard 134 1-34
 tool grinder 137 18
 tool-grinding machine 137 18
 tool post 149 21
 tool rest 135 5; 149 22
 tools 119 77-89
 tool shank 149 49
 tool shed 37 32; 52 3; 55 1
 tool slide 149 22
 tool trolley 195 42
 tooth *Man* 19 28-37
 tooth *Mach. Parts etc.* 143 83
 tooth *Composing Rm.* 174 30
 tooth *Office* 249 31
 tooth, bicuspid ~ 19 18
 tooth, canine ~ 19 17
 tooth, molar ~ 19 18, 35
 tooth, porcelain ~ 24 29
 tooth, premolar ~ 19 18
 toothbrush, electric ~ 49 29
 tooth chisel 339 13
 toothed 370 45
 tooth glass 49 28
 toothing, external ~ 143 96
 toothing, internal ~ 143 95
 toothing, spiral ~ 143 92-93
 toothing plane 132 17
 tooth mug 49 28
 toothpaste 99 31
 toothpick holder 266 23

tooth pulp 19 32
 tooth-root elevator 24 48
 tooth scaler 24 45
 top 12 40; 193 10; 323 24
 top, collapsible ~ *Carriages* 186 52
 top, collapsible ~ *Car* 193 10
 top, convertible ~ 193 10
 top, elasticated ~ 32 33
 top, fireclay ~ 108 9
 top, fixed ~ 186 14
 top, folding ~ 194 10
 top, hard ~ 193 27
 top, humming ~ 309 71
 top, leather ~ 35 19
 top, marble ~ 265 12
 top, shirred ~ 29 15
 top clearer 164 22
 topgallant stay 219 12
 top gases 145 38
 top hat 35 36; 186 25; 289 6
 top light, white ~ 286 10
 top lighting, incident ~ 112 63
 topmark 224 78, 90
 topmark buoy 224 80
 topmast 223 39
 topmast stay 219 11
 topography, fluvial ~ 13 1-13
 topmer 64 85
 topping 266 54
 topping knife 64 87
 top rail 221 122
 top ring 89 2
 top roller, right ~ 164 18
 tops 145 38
 topsail schooner, three-masted ~ 220 19
 top side *Meat* 95 37
 top side *Paperm.* 173 31
 top slide 149 22, 42
 top stroke 277 3
 top tube 187 16
 torch 127 26
 torch lighter 141 27
 torero 319 21, 25
 torii 337 11
 torpedo boat 258 69, 75
 torpedo housing, underwater ~ 259 36
 torpedo tube 258 78; 259 79
 torque converter 190 70
 torque converter bearing 211 54
 torque converter lever 65 34
 torque wrench 195 45
 torril door 319 11
 torsional clamp 287 39
 torso 339 7
 Torsteel 119 82
 torten 97 22-24
 tortrix moth 80 9
 torus *Art* 334 28, 30
 torus *Bot.* 370 53
 totalizer 289 35
 totalizer window 289 34
 tote 289 35
 totem 352 2
 totem pole 352 1
 tote window 289 34
 toucan 363 6
 touch line 291 9

touch-me-not 377 11
 touch-tone button 242 25
 touch-tone pad 242 25
 toupee wig 355 8
 toupet 34 2
 touring bicycle 187 1
 touring boat 283 26-33
 touring cycle 187 1
 touring cycle handlebar 187 2
 touring kayak 283 61, 70
 touring moped 188 24
 tourist 272 28
 tourist guide 272 27
 tournament 329 71
 tournament pennon 254 33
 tournament saddle 329 87
 tourneur 275 3
 tourney 329 71
 tourniquet, emergency ~ 21 15
 tourniquet, surgeon's ~ 26 48
 tow 170 57, 58, 59, 60
 towage 227
 towel 106 25; 281 25
 towel, paper ~ 40 1; 106 5
 towel rail 49 8
 tower *Bldg. Site* 119 34
 tower *Bridges* 215 42
 tower *Airport* 233 17
 tower *Gliding* 287 12
 tower, central ~ 335 6
 tower, lattice steel ~ 152 36
 tower, stepped ~ 333 32
 tower, terraced ~ 333 32
 tower clock 331 7
 tower crane 47 39; 119 31
 tower platform 329 8
 tower roof, pyramidal ~ 335 7
 tower slewing crane 119 31
 tower spotlight 316 21
 tower tomb 333 21
 tow hook 227 27
 towing 216 27
 towing engine *Rivers* 216 29
 towing engine *Salvage* 227 7
 towing engine *Warships* 258 86
 towing gear 227 6, 6-15, 13
 towing hawser 216 24; 227 8, 15
 towing line 286 47
 towing log 224 54
 towing machine 227 7; 258 86
 towing mast 216 28
 towing path 216 30
 towing plane 287 2
 towing track 216 30
 towing vehicle 194 21, 29
 towing winch 227 7; 258 86
 tow line 216 24; 227 8, 15; 286 47
 town 15 51; 268
 town banner 218 22
 town centre 268
 tow path 216 30
 tow rope *Rivers* 216 24
 tow rope *Salvage* 227 8, 15
 tow rope *Gliding* 287 4
 tow rope guide 227 9
 toy, soft ~ 46 13; 47 6, 7, 41
 toy, wooden ~ 260 80

toy duck 28 10
 toys 48 21-32
 toy shop 47 27
 T position 288 62
 trace 71 22, 24, 35
 trace monitor 25 54
 tracer 153 45
 tracer element 153 45
 tracery 335 39-40
 tracery window 335 39-41
 trachea 17 50; 20 4
 tracing head 141 37
 tracing leg 302 2
 tracing wheel 129 42
 track *Atom* 2 37
 track *Hunt.* 86 8
 track *Cine Film* 117 82
 track *Railw.* 202 1-38
 track *Station* 205 59-61
 track *Army* 255 87
 track *Equest.* 289 23
 track *Cyc. Racing* 290 2
 track *Winter Sp.* 301 60
 track, cinder ~ 298 6
 track, indoor ~ 290 1
 track, sand ~ 290 24
 track, synthetic ~ 298 6
 track, unfenced ~ 15 102
 track and field events 298
 track and signal indicator 203 64
 track-clearing vehicle 213 17
 track diagram control layout 203 65
 track diagram control panel 203 66
 tracker action 326 6-16
 track format 243 28
 trackhound 70 42, 43
 track indicator 65 81
 track inspection railcar 213 32
 track racer 290 2
 track rider 290 2
 track rider, motor-paced ~ 290 14
 track rod 65 47
 track-rod ball-joint 192 80
 tracksuit 33 27
 tracksuit bottoms 33 29
 tracksuit top 33 28
 trackwalker 202 44
 tract 330 57
 traction motor 211 6
 traction motor blower 211 15
 tractive effort indicator 211 26
 tractive unit 194 21, 29
 tractor 62 38; 64 46; 65 20; 67 17; 85 43; 194 21, 29; 273 55
 tractor, narrow-track ~ 78 21
 tractor driver 62 39
 tractor unit 85 43
 trader, itinerant ~ 308 51
 trades 9 48, 49
 tradesman 98 41
 trade winds 9 48, 49
 traffic control 264 9
 traffic control cuff 268 31
 traffic helicopter 264 1

traffic light post 268 53
 traffic lights 268 52
 traffic patrol 264 9
 traffic policeman 268 30
 traffic sign 268 66
 trail 86 8
 trail, scented ~ 289 49
 trailer *Farm Bldgs.* 62 40
 trailer *Agr.* 63 27, 38
 trailer *Blacksm.* 138 10
 trailer *Lorries etc.* 194 22
 trailer *Station* 206 3, 35
 trailer *Camping* 278 52
 trailer, collapsible ~ 278 3
 trailer, folding ~ 278 3
 trailer, tip-up ~ 56 42
 trailer frame 138 28
 trailering 278
 trailer wagon 200 25
 trailing arm 191 27; 192 66
 trailing cable hanger 133 39
 trailing cable support 133 39
 trailing edge *Sailing* 284 45
 trailing edge *Gliding* 287 37
 trailing link arm 192 81
 trail rope 288 69
 train 355 80
 train, electric ~ 197
 train, interurban ~ 197
 train, local ~ 208 1-12
 train, short-distance ~ 208 1-12
 train, suburban ~ 205 25
 train control system, inductive ~ 211 7, 38; 212 14, 38
 train deck 221 80
 trainee pastry cook 265 6
 trainer 101 35
 train ferry *Map* 15 12
 train ferry *Ship* 221 74
 train heating generator 212 39
 train heating system 212 17, 18
 train heating system transformer 212 40
 train heating voltage indicator 211 27
 training apparatus 299 20-24
 training equipment 299 20-24
 training ship 258 95
 training shoe 101 35
 train plate, bottom ~ 110 37
 'trains' 233 34
 train schedule 204 50
 train service, local ~ 208 1-30
 trainset 209 1
 trainset, experimental ~ 209 23
 train set, wooden ~ 47 37; 48 29; 273 27
 trajectory 89 36
 tram 197; 268 46
 tramline 268 23
 trammel 125 11
 trampoline 297 10
 tram service 197 13
 tram stop 197 35; 268 25
 tram stop sign 197 36; 268 26
 tram timetable 268 27

transept 335 3
 Trans-Europe Express 209 1-22
 Trans-Europe Express, electric ~ 205 34
 transfer blanket 249 40
 transfer cylinder 180 36
 transfer drum 180 36
 transfer entry 250 25
 transfer port 242 57
 transformer *Clocks* 110 8
 transformer *Power Plant* 153 9-18
 transformer *Railw.* 211 10
 transformer, high-tension ~ 211 4
 transformer, mobile ~ 152 30, 39
 transformer, transportable ~ 152 30, 39
 transformer connection 153 19
 transformer station *Brew.* 92 21
 transformer station *Hydr. Eng.* 217 46
 transformer tank 152 40
 transforming section 23 56
 transillumination 112 60
 transistor, actuating ~ 195 19
 Transitional 342 5
 'transit passengers' 233 27
 transit shed 225 9
 transmission 209 18
 transmission, multi-speed ~ 65 36
 transmission cable 326 53
 transmission line 154 16
 transmission line, high-voltage ~ 152 32
 transmission oil 209 15; 212 36, 43
 transmission oil temperature gauge 212 20
 transmissometer 10 60
 transmitted-light microscope 112 14
 transmitter 10 59, 62
 transmitting antenna 288 88
 transom *Dwellings* 37 35
 transom *Ship* 221 42
 transom *Sailing* 284 35; 285 49
 transom *Motorboats etc.* 286 26
 transom stern 221 42; 258 26; 259 11; 285 48
 transparency 242 42
 transparency arm 177 44
 transparent gage 59 25
 transplanting *Plant Propagn.* 54 5
 transplanting *Forestry* 84 10
 transport aircraft, medium-range ~ 256 14
 transport and communications aircraft 256 24
 transport and rescue helicopter 256 18
 transporter, suction ~ 74 49

transporter container-loading bridge 225 46; 226 2
 transporter loading bridge 225 20
 transport helicopter 232 21
 transport lug 152 48
 transport roller *Cine Film* 117 34
 transport roller *Joiner* 132 72
 transport sprocket 115 26
 transport vehicle 62 18
 transtainer 226 2
 transtainer crane 226 2
 transversal chicane 301 68
 transverse motion 149 17
 trap *Bathrm. etc.* 49 27
 trap *Hunt.* 86 20
 trap *Plumb. etc.* 126 26
 trapdoor 38 13
 trapeze *Sailing* 284 12
 trapeze *Circus* 307 6
 trapeze artist 307 7
 trapeze platform 307 5
 trapezium 346 37
 trapezius 18 52
 trap opening 316 32
 trapper 306 8
 trapping 86 19-27, 19
 trappings *Horse* 71 16
 trappings *Chivalry* 329 74
 trash bin *Doc.* 22 70
 trash bin *Butch.* 96 46
 trash can 199 3
 trash conveyor 64 80
 travel agency 271 24
 travel centre 204 28
 traveler *see* traveller
 travelling *see* travelling
 traveller *Cotton Spin.* 164 51, 55
 traveller *Sailing* 284 27
 Travellers' Aid 204 45
 travelling bag 205 10
 travelling box 77 44
 travelling salesman 209 29
 traverse 152 37
 traversing handle 255 48
 trawler 90 11; 221 86
 trawl fishing 90 11-23
 trawling 90 11-23
 trawl warp 90 12
 tray *Living Rm.* 42 30
 tray *Pest Contr.* 83 17
 tray *Game* 88 8
 tray *Café* 265 3, 14
 tray *Restaurant* 266 19, 45, 63
 tray *Fair* 308 52
 tray, revolving ~ 204 37
 tray, round ~ 44 24
 tray counter 266 64
 tray for purchases 271 15
 tray thermometer 116 13
 tread 50 38; 123 32, 47
 tread, rubber ~ 187 85
 treading water 282 39
 treadle *Poultry Farm* 74 63
 treadle *Dressm.* 103 11
 treadle *Tailor* 104 13
 treadle control 168 48
 treadle lever 166 58

treadle sewing machine 309 1
 treading diagram 171 10
 tread sledge 304 29
 treasury notes 252 29-39
 treble belly bridge 325 11
 treble bridge 325 11
 treble clef 320 8
 treble control 241 31
 treble coupler 324 41
 treble plume 254 30
 treble register 324 41
 treble stop 324 41
 treble string 325 10
 treble tuning 241 43
 treble viol 322 23
 tree 272 59, 61; 370 1
 tree, conical ~ 272 13
 tree, globe-shaped ~ 272 12
 tree, pyramidal ~ 52 16; 272 19
 tree brush 56 23
 tree cake 97 46
 tree calliper, steel ~ 84 21
 tree felling 84 15-37
 tree frog 364 24
 tree guard 118 80
 tree nursery *Map* 15 111
 tree nursery *Market Gdn.* 55 3
 tree nursery *Forestry* 84 6, 10
 tree of life 372 39
 tree pruner 56 11
 trees, coniferous ~ *Map* 15 1
 trees, coniferous ~ *Conifers* 372 1-11
 trees, deciduous ~ 371 1-73
 trees, mixed ~ 15 14
 trees, non-coniferous ~ 15 4
 trees, ornamental ~ 373; 374
 trees, young ~ 84 10-11
 tree scraper 56 14
 tree stake 52 31
 tree stump 84 14
 tree toad 364 24
 treetop 272 60; 370 4
 tree trunk 84 19; 370 2, 7
 tree trunk, hollowed-out ~ 218 7
 trefoil arch 336 32
 trellis 89 5
 trellis, wire ~ 78 9
 trembling poplar 371 21
 trenchcoat 33 57
 trestle *Overh. Irrign.* 67 7
 trestle *Carp.* 120 18, 19
 trestle *Shipbuild.* 222 27
 trestle, paperhanger's ~ 128 52
 trestle rope 122 67
 triad 321 1-4
 triakis-octahedron 351 10
 trial 290 24-28
 trial frame 111 3
 trial lens case 111 45
 triangle *Fish Farm.* 89 85
 triangle *Drawing Off.* 151 7, 8
 triangle *Railw.* 203 13
 triangle *School* 260 37
 triangle *Music. Instr.* 323 49
 triangle, acute-angled ~ 346 28
 triangle, equilateral ~ 346 26

triangle, obtuse-angled ~ 346 30
 triangle, pipe clay ~ 350 17
 triangle, right-angled ~ 346 32
 triangle cut 36 67
 triangles, plane ~ 346 26-32
 triangle sign 203 13
 triangle symbol 345 24
 triangulation point 14 49; 15 71
 triangulation station 14 49; 15 71
 Triangulum Australe 3 40
 triceps brachii 18 38
 trick button 117 84
 trick ski 286 56
 trichine crystal system 351 26
 Tricolour 253 16
 triforium 335 33
 trigger *Slaughterho.* 94 6
 trigger *Army* 255 5
 trigger guard 87 10
 trigger mechanism 255 20
 trigger valve 270 62
 triglyph 334 15
 trilby hat 35 22
 trill 321 17, 18
 trim 46 5
 trimaran 278 16
 trimmer *Carp.* 120 41
 trimmer *Roof* 121 71
 trimmer *Paperhanger* 128 43
 trimmer joist 120 41
 trimming, fur ~ 30 59
 trimming, lace ~ 31 32
 trimming, leather ~ 30 18
 trimming blade 85 22
 trimming knife 128 38
 trimming machine 85 18
 trimmings 266 55
 trimming tab 288 25, 30
 trimming table 132 64
 trimming tool 162 43
 trim tab 288 25, 30
 triplane 229 6
 triple-spar tail construction 257 20
 triplet 321 23
 trip mileage recorder 191 74, 77
 tripod *Photog.* 114 42; 115 99
 tripod *Paperm.* 173 6
 tripod *Chem.* 349 15; 350 14
 tripod, wooden ~ 313 13
 tripod bush 115 30
 tripod crane 222 6
 tripod lattice mast 258 41
 tripod leg 114 43
 tripod socket 115 30
 tripod spotlight 310 52
 trireme 218 9-12
 triton 327 40
 trochilus 334 29
 troika 186 45
 trolley *Blacksm.* 138 35
 trolley *Lorries etc.* 194 42
 trolley *Tram* 197
 trolley *Station* 206 14
 trolley *Town* 268 46
 trolley, electric ~ 205 29

trolley, metal ~ 74 31
 trolley bus 194 40
 trolley bus trailer 194 44
 trolley service 197 13
 trolley shoe 194 42
 trolley shoe, aluminium alloy ~ 197 24
 trolley shoe, carbon ~ 197 24
 trolley stop 197 35; 268 25
 trolley stop sign 197 36; 268 26
 trolley wire 197 41; 205 58
 trolley wire contact point 197 40
 trombone 323 46
 trombone slide 323 47
 tropaeolum 53 4
 trophus 358 26
 trophy 352 15, 30
 tropic of Cancer 3 4
 tropics 14 10
 tropopause 7 9
 troposphere 7 1
 trot 72 41
 trotter *Meat* 95 38, 42, 48
 trotter *Equest.* 289 28
 trotting silks 289 26
 troubadour 329 70
 trough *Phys. Geog.* 12 18
 trough *Mills* 91 14
 trough *Railw.* 202 34
 trough *Art* 336 48
 trough, equatorial ~ 9 46
 trough, outdoor ~ 62 9
 trough gutter 122 83
 trough mixer, double shaft ~ 159 10
 trough plane 12 19
 trough surface 12 19
 trough valley 13 55
 trough vault 336 47
 trouser leg 33 6
 trouser pocket 33 47
 trousers, boy's ~ 29 60
 trouser suit 30 57
 trouser turn-up 31 40
 trout 364 15
 trout breeding 89 14
 trout fry 89 16
 trout pond 89 6
 trout rearing 89 14
 trowel *Gdn. Tools* 56 6
 trowel *Bldg. Site* 118 52
 trub 93 2
 trub removal 93 1-5
 truck *Bldg. Site* 119 32
 truck *Power Plant* 152 41
 truck *Sawmill* 157 16
 truck *Refuse Coll.* 199 38
 truck *Railw.* 207 4; 208 4; 212 2; 213 13
 truck *Docks* 226 4, 19
 truck *Flags* 253 1
 truck, electric ~ 205 29; 206 2, 34
 truck, heavy ~ 194 20; 200 7
 truck, large-capacity ~ 158 14
 truck, light ~ 194 1, 5
 truck, toy ~ 47 38; 273 62
 truck farm 55 1-51, 3
 truck garden 55; 55 1-51, 3

trucks 194
truck tire 273 19
truck-to-truck handling 226
7
truck-to-truck operation 225
41
truck-to-truck system 225 41
truck with trailer 213 34
trudgen 282 37
trudgen stroke 282 37
truffle *Grocer* 98 86
truffle *Edib. Fungi* 381 9, 10,
11
trumpet 318 6; 323 43
trumpet, bronze ~ 322 1
trumpet daffodil 60 3
trumpeter 318 7
trumpet narcissus 60 3
truncheon *Heraldry* 254 31
truncheon *Police* 264 19
trunk *Man* 16 22-41
trunk *Forestry* 84 19
trunk *Car* 191 24; 193 23
trunk *Mammals* 366 21
trunk *Bot.* 370 2
trunk, horse's ~ 327 45
trunk, main ~ 88 11
trunk, woman's ~ 327 24
trunk-bending forwards 295
33
trunk-bending sideways 295
32
trunk call 237 3
trunk-hose, panned ~ 355 34
trunk-hose, stuffed ~ 355 31
trunk lid 191 7
trunk line 15 21
trunk pipeline 145 35
trunk road 15 17
trunks 32 27
truss 215 3
trussed arch bridge 215 23
trussed-rafter roof 121 34
truss element 215 24
trusser 130 12
truss joint 215 37
truss post 121 68
truss tower 155 43
trying plane 132 39
trysail 220 1
try square 120 69; 132 6; 134
26
try-your-strength machine
308 11
tsetse fly 81 43
T-shirt 31 38
T-shirt, children's ~ 29 27
T-square 151 9
tsunami 11 53
T-tail 229 29; 256 31-32; 287
10
T-tail unit 229 29; 256 31-32;
287 10
tub *Market Gdn.* 55 48
tub *Wine Grow.* 78 10
tub, wooden ~ 91 27
tuba 323 44
tubaphone 324 61
tube *Hosp.* 25 13; 26 17
tube *Pest Contr.* 83 31
tube *Optic. Instr.* 111 18

tube *Optic. Instr.* 113 8
tube *Bicycle* 187 30
tube *Music. Instr.* 323 29; 326
22
tube *Invertebr.* 357 23
tube *Edib. Fungi* 381 17
tube, diaphragmed ~ 10 27
tube, eustachian ~ 17 65
tube, fallopian ~ 20 81
tube, steel ~ 155 30
tube, telescopic ~ 65 77
tube, uterine ~ 20 81
tube bin 255 72
tube cap 260 52
tube centre section 113 9
tube clamp 40 20; 350 30
tube clip 40 20; 350 30
tube connection 6 26
tube holder 22 46
tuber *Arable Crops* 68 40
tuber *Bot.* 370 79
tuberoise 60 9
tuberosity 80 27
tube support 27 47
tube valve 187 31
tube well 269 60
tubing 145 20, 24
tub plant 55 47
tuck and miss stitch 171 44,
47
tuck jump 282 14; 295 36;
297 40
tuck stitch, pulled-up ~ 171
45, 48
tuck stitch, staggered ~ 171 46
tue iron 137 6
tuff 11 19
tuff deposit 11 26
tuft 73 7
tufted lark 361 19
tuft of grass 375 44
tug *Shipbuild.* 222 42
tug *Docks* 225 15
tug *Salvage* 227 5, 16
tug *Gliding* 287 2
tulip poplar 374 1
tulip tree 374 1
tulle background 102 16
tulle lace 102 15
tulle work 102 15
tumble drier 50 28
tumbler 140 38
tumbler, seaward ~ 226 23
tumbler, shore-side ~ 226 28
tumbler lever 149 10
tumbler reverse lever 149 14
tumbler spring 140 42
tumbling separator,
mechanical ~ 64 75
tumulus 328 16
tun 92 45
tun, wooden ~ 91 27
tundra climate 9 57
tuner 241 9, 37; 317 22
tuner, automatic ~ 23 38
tunic *Ladies' Wear* 30 29
tunic *Ship* 221 115
tunic *Hist. Cost.* 355 12, 25
tunic, long ~ 355 19
tunica 355 12
tunic dress 30 29

tunic top 30 29
tuning control 241 9
tuning crook 326 21
tuning device 326 30
tuning dial 241 7
tuning flap 326 30
tuning fork element 110 9
tuning fork principle 110 6
tuning fork watch 110 6
tuning hammer 325 20
tuning hole 326 33
tuning key 325 20
tuning knob 241 9; 309 21
tuning meter 241 39, 54
tuning peg 323 18; 324 11; 325
17
tuning pin 324 23; 325 17
tuning screw 323 59
tuning slot 326 33
tuning tongue 326 30
tuning wedge 325 21
tuning wire 326 21
tunnel *Map* 15 70
tunnel *Soft Fruit* 58 63
tunnel *Station* 204 23
tunnel *Railw.* 214 6
tunnel, plastic ~ 55 40
tunnel, underground ~ 198 29
tunnel entrance 233 6
tunnel kiln 161 5
tunnelling machine 144 32
tunnel vault 335 19; 336 38
tup *Blacksm.* 137 10
tup *Forging* 139 12, 26
turban 353 46
turbine 67 20; 209 18; 232 40,
47
turbine, high and low
pressure ~ 259 62
turbine, high-pressure ~ 232
53
turbine, low-pressure ~ 232
54
turbine, reversible ~ 155 39
turbine, supercharged ~ 212
51
turbine engine 232 17, 24;
257 15
turbine exhaust 146 5
turbine house 152 22; 217 43
turbine inlet 155 40, 41
turbine monitoring panel 153
30
turbine transmission 209 10
turbine unit 209 24
turbogenerator 154 34
turbogenerator set 154 33
turbogenerator unit 153
23-30
turbojet engine 231 26
turbojet engines 232 33-50
turbopropeller engine 231 5;
232 30, 51
turbopropeller plane 231 4
turboprop engine 231 5; 232
30, 51; 256 16
turboprop plane 231 4
tureen 45 15
turkey 73 28
turkey cock 73 28
turkey hen 73 28

turkey leg 99 59
Turkish delight 98 84; 308 18
turk's cap 377 4
turk's cap lily 377 4
turn *Athletics* 298 24
turn *Music. Not.* 321 21
turnbuckle 130 4; 202 31
turner *Brew.* 92 24
turner *Turner* 135 20
turnery 135 1-26
turn indicator *Car* 191 76
turn indicator *Aircraft* 230 12
turn indicator light 189 37, 45
turn indicator light, front ~
191 19
turning head, multiple ~ 149
41
turning judge 282 26
turning tools 135 14, 15, 24
turnip moth 80 42
turnout 203 51, 52
turn slot 288 46
turntable *Porcelain Manuf.*
161 11
turntable *Electrotyp. etc.* 178
26
turntable *Lorries etc.* 194 31
turntable *Bridges* 215 64
turntable *Docks* 226 56
turntable *Audio* 241 20
turntable *Army* 255 73
turntable, small ~ 142 41
turntable glazing machine
161 16
turn-up 30 35; 31 54; 33 35
turpentine separator 172 14
turret *Mach. Tools* 149 40
turret *Warships* 258 47, 67,
70; 259 31, 52, 71
turret *Chivalry* 329 28, 35
turret, aft ~ 259 44
turret, armoured ~ 255 84
turret, forward ~ 259 43
turret head 117 46; 313 32
turret lathe 149 38
turtle dove 359 23
tusk 88 54; 366 22; 367 22
tutu 314 29
tuyère 147 20
TV set 42 8; 46 14
tween deck 223 76
tweeter 241 15
tweezers 109 14; 174 18
twig 370 6
twilight area 4 21
twin anti-aircraft gun 258 31
twin anti-aircraft gun turret
259 30
twin anti-aircraft missile
launcher 259 25, 33
twin anti-aircraft rocket
launcher 259 25, 33
twin columns 336 6
twin edger 157 57
twin engine, horizontally-
opposed ~ 189 47
twin etching machine 178 30
twin hull 284 65
twin launching catapult 259
14
Twins 3 28; 4 55

twin seat 188 42
twin seat, racing-style ~ 189
14
twin set 31 49
twin-spar wing construction
257 27
twin tail unit 229 32, 34
twist bit 134 49; 140 59
twist drill 134 49; 140 59
twist grip *Pest Contr.* 83 19
twist grip *Motorcycles etc.* 188
31
twist grip throttle control 188
30; 189 29
twist of tobacco 107 18
twitch grass 61 30
two-eight time 320 28
two-four time 320 29
two-high mill 148 53
two-line brevier 175 30
two-line primer 175 31
two-pipe system 126 22
two-seater 193 28
two-stroke blending pump
196 13
two-toed sloth 366 11
two-two time 320 30
two-way tap 350 49
tympan 340 37
tympanum 335 26
type *Composing Rm.* 174 7,
15, 44; 175 1-17, 38
type *Letterpress* 181 37
type *Office* 249 15, 29
type *Money* 252 12
type, black-letter ~ 342 1, 2, 3
type, bold ~ 175 2
type, bold condensed ~ 175
10
type, boldfaced ~ 175 2
type, extra bold ~ 175 9
type, Gothic ~ 342 1
type, heavy ~ 175 2
type, italic ~ 175 7
type, light face ~ 175 8
type, Schwabacher ~ 342 2
type, semibold ~ 175 3
type area 185 59
type bed 180 78; 181 17
typecase 174 3
type casting 175 32-37
type character 174 7; 175 38
type cleaner 247 8
type-cleaning brush 247 7
type-cleaning kit 247 8
type disc 176 20
type face 174 31; 175 42
type faces 342 1-15
type forme 340 32
typefounding 175 32-37
type height 175 44
type line 175 43
type magazine 174 21
type matrix 174 47; 176 16
type matter 174 15; 175 1-17;
181 37
types 342 1-15
typescript *Composing Rm.*
174 6
typescript *Script* 342 9
typesetter 174 5

typesetting, computer-
controlled ~ 176 14
typesetting computer 176 10
type size 175 18, 46
types of ship 221
typewriter 209 28; 248 22;
309 79
typewriter, electric ~ 249 1
typewriter rubber 247 26
typewriting 342 9
typhoon wheel 308 46
typing compartment 209 26
typing desk 245 25; 248 26
typing opening 249 19
typing window 249 19
typist 248 21
typographer beetle 82 22
tyre 191 15
tyre, high-pressure ~ 187 30
tyre, pneumatic ~ 187 30; 305
86
tyre, rubber ~ 273 54
tyre, tubular ~ 290 19, 23
tyre chain 304 10
tyre pressure gauge 196 17
tyre tread 189 27

U

udder 75 18
ulna 17 14
ulnar side of the hand 19 70
ultra large crude carrier 221 1
umbel 383 65
umbel, simple ~ 370 72
Umbellula encrinus 369 14
umbo 329 58
umbra 4 35
umbrella *Hall* 41 15
umbrella *Station* 205 12
umbrella *Ari* 337 22
umbrella *Invertebr.* 357 15
umbrella, telescopic ~ 41 12
umbrella stand 41 14
umpire 292 55, 65; 293 19, 68
unau 366 11
uncial 341 17
underbrush 84 5
undercarriage 194 32
undercarriage, retractable ~
232 10
undercarriage housing 256 15
undercarriage hydraulic
cylinder 257 41
undercarriage unit, forward-
retracting ~ 257 40
undercarriage unit, main ~
230 41; 231 28; 256 26; 257
40; 288 33
undercarriage unit,
retractable ~ 231 28
underclothes, ladies' ~ 32
1-15
underclothes, men's ~ 32
22-29
undercut *Forestry* 84 28
undercut *Meat* 95 13
undercut swing saw 157 24, 64
underframe 207 3; 208 5
undergown 355 37

undergrasp 296 41
undergrowth 84 5
underlip 72 10
under-ridge tile 122 5
undershirt 296 61
underside 173 34
underskirt 309 85
understructure 191 2
under tile 122 57
underwater case 117 57
underwater housing 117 57
underwater massage bath 281 31
underwater salvo missile launcher 259 24
underwater salvo rocket launcher 259 24
underwater swimmer 279 7; 280 37
underwater swimming 279 7-27; 282 38
underwater swimming set 279 8-22
underwear 32
underwear, ladies' ~ 32 1-15
underwear, men's ~ 32 22-29
underwing tank 256 4
underwood 84 5, 32
uneven bars 297 3
ungulates 366 25-31; 367 1-10
ungulates, even-toed ~ 366 28-31
ungulates, odd-toed ~ 366 25-27
unicorn 254 16; 327 7
uniform 264 7
uniform cap 264 8
Union Jack 253 15
union of sets 348 5-6
unison 321 6
unison interval 321 6
unit, assistant's ~ 24 9
unit, slide-in ~ 27 32
unit indicator 174 36
unit load 225 49; 226 9
unit load, foil-wrapped ~ 225 42
units 344 3
university 262 1-25
university lecturer 262 3
university library 262 11-25
unwind station 173 39
up-and-down roundabout 308 5
up-and-down slide 273 52
upcurrent, frontal ~ 287 vp
upholstery 134 59
upper, corduroy ~ 101 26
upper, rubber ~ 300 45
upper, soft-leather ~ 101 46
upper, terry ~ 101 23
upper arm hang 296 58
upper board 326 15
upper board groove 326 14
uppercut 299 32
upper fore topgallant sail 219 59
upper fore topgallant yard 219 36

upper fore topsail 219 57
upper fore topsail yard 219 34
upper hatch 6 45
upper-leather shears 100 42
upper main topgallant sail 219 65
upper main topgallant yard 219 42
upper main topsail 219 63
upper main topsail yard 219 40
Upper Muschelkalk 154 58
Upper Permian 154 62
upright *Gymn.* 296 9
upright *Athletics* 298 13, 33
upright *Music Instr.* 325 1
upright kneeling position 295 7
upright piano 325 1
upright spin 302 9
upsett 136 25
upsetting block 137 16
upstart 297 28
upward ventilator 154 81
U-rail 214 22
Uranus 4 50
ureter 20 32
urethra 20 68
urethroscope 23 20
urine sediment chart 23 58
urn 328 40; 331 31
urn, cinerary ~ 328 38
urn, domestic ~ 328 38
urn, embossed ~ 328 38
urn grave 328 39; 331 30
Ursa Major 3 29
Ursa Minor 3 34
ursine seal 367 18
usher 315 12
usherette 312 4
uterus 20 79
utility room door 118 6
utility room window 118 5
U-tube 349 2
U-valley 13 55
uvula 19 22

V

vacancy 342 70
vacuum 240 21
vacuum back 177 35
vacuum box 173 15
vacuum chamber 252; 83 12; 159 12
vacuum cleaner *Household* 50 80
vacuum cleaner *Goldsm. etc.* 108 43
vacuum cleaner, cylinder ~ 50 68
vacuum cleaner, upright ~ 50 58
vacuum equipment 145 51
vacuum film holder 177 8
vacuum frame 179 13; 182 2
vacuum line 74 50; 75 29
vacuum printing frame 179 13

vacuum pump *Intern.*
Combust. Eng. 190 59, 60
vacuum pump *Water* 269 8
vacuum pump switch 179 19
vacuum ripening tank 169 11
vacuum timing control 190 9
vagina 20 86
Valasian dulcimer 322 34
Valenciennes 102 18
valerian 380 5
valley *Phys. Geog.* 13 52-56
valley *Roof* 121 15; 122 11, 82
valley, dry ~ 13 75
valley, synclinal ~ 13 56
valley, U-shaped ~ 13 55
valley, V-shaped ~ 13 53, 54
valley bottom 13 67; 215 60
valley floor 13 67
valley glacier 12 49
valley rafter 121 64
valley station 214 39
valley station platform 214 51
valley temple 333 8
value 250 18
value, note's ~ 320 7
valve *Roof & Boilerr.* 38 73
valve *Bicycle* 187 31
valve *Airsports* 288 77
valve *Ball Games* 291 18
valve *Music Instr.* 323 40; 324 66
valve, aortic ~ 20 49
valve, atrioventricular ~ 20 46, 47
valve, bicuspid ~ 20 47
valve, mitral ~ 20 47
valve, pulmonary ~ 20 50
valve, sliding ~ 217 55
valve, tricuspid ~ 20 46
valve control house 217 42, 63
valve horn 323 41
valve house 217 42, 63
valve housing 217 54
valve line 288 78
valve sealing cap 187 32
valves of the heart 20 46-47
valve tube 187 31
vambrace 329 47
vamp *Shoem.* 100 60
vamp *Carnival* 306 32
vamplate 329 82
van, medium ~ 194 7
Vandyke beard 34 13
vane, curved ~ 91 38
vane, flat ~ 91 40
vang 284 21
vanilla 382 48
vanilla plant 382 46
vanilla pod 382 48
vans 194
vaquero 306 31
variable 345 14
variable depth sonar 259 40
variable focus lens 313 23
variable platen action lever 249 24
varifocal lens 313 23
variometer 230 14
varnish 338 12
varnishing 129 14
vas deferens 20 74

vase, Greek ~ 334 37
vase, hand-painted ~ 161 18
vase, porcelain ~ 337 5
vase, stone ~ 272 35
vastus lateralis 18 46
vastus medialis 18 46
vat *Fish Farm.* 89 4
vat *Paperm.* 172 25; 173 47
vat, concrete ~ 79 3
vat, stainless steel ~ 79 4
vatman 173 46
vault 79 1
vault, cloistered ~ 336 41
vault, groined ~ 336 42
vault, ribbed ~ 336 43
vault, stalactitic ~ 337 17
vault, stellar ~ 336 44
vault, types of ~ 336 38-50
vaulter *Athletics* 298 29
vaulter *Circus* 307 32
vaulting 298 9-41
vaulting, Romanesque ~ 335 17
vaulting horse 296 1; 297 1
vaulting pole 298 28
V-belt 64 78
V-belt drive 180 58
V-cardan 67 31
VCR cassette 243 5
veal 95 1-13
vee-belt drive 180 58
vee-neck 31 68
vee-tail 229 31
Vega 3 22
vegetable, frozen ~ 99 61
vegetable basket 99 81
vegetable crate 55 43
vegetable dish 45 25
vegetable garden 52
vegetable oil 98 23
vegetable patch 52 26
vegetable plants 57
vegetable plate 45 33
vegetable platter 45 33
vegetable plot 52 26; 55 39
vegetables 57
vegetables, canned ~ 96 27
vegetable spoon 45 74
vegetarian meal 266 62
vehicle 195 47
vehicle, articulated ~ 194 28
vehicle, electrically-powered ~ 188 20
vehicle ferry 15 47
vehicle ramp 206 1
vehicles 186 1-54
vehicles, horse-drawn ~ 186 1-54
vehicle tanker 194 28
veil 381 5
veil, bridal ~ 332 20
veil, widow's ~ 331 39
vein 370 29
vein, frontal ~ 18 6
vein, iliac ~ 18 18
vein, jugular ~ 18 2
vein, portal ~ 20 39
vein, pulmonary ~ 18 12; 20 56
vein, subclavian ~ 18 8
vein, temporal ~ 18 4

velum 381 5
velum palati 19 21
vena cava, inferior ~ 18 15; 20 57
vena cava, superior ~ 18 9; 20 53
venation 370 29
vendor 308 17
vener 133 2
vener-peeling machine 133 1
vener-splicing machine 133 3
V-engine 190 1
vent *Phys. Geog.* 11 28
vent *Airsports* 288 82
vent, volcanic ~ 11 17
ventilating tile 122 7
ventilation control knob 26 27
ventilation drum 74 29
ventilation drum motor 74 33
ventilation flap *Market Gdn.* 55 41
ventilation flap *Railw.* 213 16, 29, 30
ventilation shaft *Brew.* 92 14
ventilation shaft *Coal* 144 21
ventilation slit 50 30
ventilation switch 191 83
ventilation system 6 26
ventilation system, automatic ~ 191 30
ventilation window 55 10
ventilator *Bathrm. etc.* 49 20
ventilator *Poultry Farm* 74 10, 17
ventilator *Railw.* 207 9
ventilator *Ship* 221 41
ventilator *Water* 269 27
ventilator *Disco* 317 30
ventilator *Zoo* 356 17
ventilator, hinged ~ 55 10
ventilator grill 258 43
ventilator lead 223 41
ventilator opening 258 43
ventilators 55 10-11
vent mast 221 38
vent pipe 155 11
vent prop 55 18
ventral part 95 39
ventricle 20 51
vents 55 10-11
venturi 192 8
venturi throat 190 15
Venus 4 44
Venus's flytrap 377 14
Venus's slipper 376 27
verge 37 8; 121 3
verger 330 26, 58
Vermes 357 20-26
vermouth 98 62
vernier *Metalwkr.* 140 55
vernier *Navig.* 224 5
vernier calliper gauge 140 52; 149 67
vernier depth gauge 140 54; 149 72
vernier scale 149 69
vert 254 29
vertebra, cervical ~ 17 2

vertebra, coccygeal ~ 17 5; 20 60
vertebra, dorsal ~ 17 3
vertebra, lumbar ~ 17 4
vertebra, thoracic ~ 17 3
vertex *Man* 16 1
vertex *Maths.* 346 26; 347 16, 28
vertex refractionometer 111 33
vertical backward somersault 297 17
vertical deflection module 240 8
vertical drive head 150 38
vertical flick spin 288 6
vertical milling spindle 150 37
vertical piano 325 1
vertical/short take-off and landing aircraft 232 26-32
vertical speed indicator 230 14
vertical tangent screw 14 54
vesicle, germinal ~ 74 66
vesicle, seminal ~ 20 77
vessel, completed ~ 162 29, 37
vessel, damaged ~ 227 2; 228 10
vessel, funerary ~ 328 34
vessels, ecclesiastical ~ 332 34-54
vessels, liturgical ~ 332 34-54
vessel with spiral pattern 328 13
vest *Infant Care etc.* 28 23
vest *Underwear etc.* 32 7
vest *Men's Wear* 33 4, 15
vest *Gymn.* 296 61
vest *Hist. Cost.* 355 75
vest, envelope-neck ~ 29 7
vest, knitted ~ 33 53
vest, short-sleeved ~ 32 28
vest, sleeveless ~ 29 6; 32 25
vest, wrapover ~ 29 8
vest and shorts set 32 21
vestibule *Railw.* 207 21
vestibule *Hotel* 267 1-26
vestments 330 22; 332 4
vestry 331 13
vestry door 330 17
VHF and UHF tuner 240 6
VHF antenna 257 25
VHF station selector button 241 38
viaduct 215 59
vibrating beam 201 13
vibrating cylinder 119 89
vibrating head 119 89
vibrating poker 119 89
vibration, macroseismic ~ 11 38
vibration damper 190 26
vibrator 201 13
vicar 330 22
vicarage 331 20
vice 109 28; 134 10; 138 24; 260 47, 56
vice, front ~ 132 30
vice, parallel-jaw ~ 140 2
vice bar 260 48

vice handle 132 31
 vice screw 132 32
 Victoria regia water lily 378 17
 video cassette 242 18
 video cassette recorder 243 7
 video cassette recorder system 243 5-36
 video coding station 236 39
 video controller 239 11
 video control room 239 10
 video data terminal 238 2, 11
 video disc 243 38, 44, 58
 video disc jacket 243 45
 video disc player 243 37, 46
 video head 243 26, 36
 video head movement, direction of ~ 243 30
 video long play video disc system 243 46-60
 video monitor 238 2
 video recorder, portable ~ 243 4
 video signal 243 58
 videotape recorder, portable ~ 243 4
 video telephone 242 21
 video telephone screen 242 26
 video track 243 31
 vielle à roue 322 25
 Vienna sausage 96 8
 view, front ~ 151 17
 view, lateral ~ 27 3
 view, side ~ 151 18
 viewer editor 117 91
 viewfinder, rectangular ~ 114 14
 viewfinder, right-angle ~ 115 71
 viewfinder, universal ~ 114 41
 viewfinder eyepiece *Photog.* 114 2; 115 22
 viewfinder eyepiece *Films* 313 6
 viewfinder hood 114 23; 115 68
 viewfinder image 115 51
 viewing lens 114 25
 viewing screen 117 94
 view point 15 68
 Viking ship 218 13-17
 village 15 105
 vine *Wine Grow.* 78 2-9
 vine *Pest Contr.* 83 51
 vinegar 98 25
 vine layer 83 15
 vine leaf 78 4
 vine pests 80 20-27
 vine root louse 83 33
 vine shoot 78 2
 vine stem 78 6
 vine tendril 54 22
 vineyard *Map* 15 65
 vineyard *Wine Grow.* 78 1, 21
 vineyard area 78 1-21
 vineyard tractor 83 48
 viticulture 78
 viticulturist 78 13
 viol 322 23
 viola 323 27

viola da gamba 322 23
 viol bow 322 24
 violet 343 9
 violin 323 1
 violin, miniature ~ 322 20
 violin body 323 3
 violin bow 323 12
 violin-bow fibula 328 27
 violin bridge 323 5
 violin clef 320 8
 violinist 267 45
 violin string 323 9
 violoncello 323 16
 violone 322 23; 323 23
 vipers 364 40-41
 Virgin 3 18; 4 58
 virginal 322 45
 Virginia creeper 51 5; 374 16
 Virgin Mary 330 51
 Virgo 3 18; 4 58
 vis-à-vis 186 51
 viscose 169 13-27, 15
 viscose process 169 1-34
 viscose rayon 169 1-12, 34
 viscose rayon cake 169 18
 viscose rayon thread 169 13-27
 viscose spinning solution 169 10, 28-34
 viscous drive 190 8
 vise see vice
 vision controller 239 11
 vision control room 239 10
 vision mixer 238 63
 vision-mixing console 238 63
 vision-mixing desk 238 63
 visitor 356 6
 visor *Forestry* 84 23
 visor *Heraldry* 254 9
 visor *Chivalry* 329 40
 visual display 23 27
 visual display unit 248 16, 44
 viticulture 78
 viticulturist 78 13
 vitreous body 19 46
 vixen 88 42
 VLP video disc 243 51
 V-neck 31 68
 vocal pouch 364 25
 vocal sac 364 25
 Voith transmission 209 14; 212 74
 vol-au-vent 97 18
 volcanism 11 13-28
 volcano, active ~ 11 15
 volcano, composite ~ 11 15
 volcano, extinct ~ 11 25, 28
 volcano, subterranean ~ 11 20
 vole and mole trap 83 37
 volley 293 41
 volley, forehand ~ 293 41
 volleyball 293 56-71, 58, 59
 voltage meter 212 17
 voltage regulator, automatic ~ 153 31
 voltage transformer 153 59
 voltmeter 326 38
 volume, respiratory ~ 26 28
 volume control 117 85; 241 41

volume control, pupil's ~ 261 43
 volume control, student's ~ 261 43
 volume readout 196 5
 volumetric flask 350 28
 volume unit meters 241 35-36
 volute 333 26; 334 23
 volute cushion 334 24
 VOR antenna 257 26
 VOR radio direction finder 230 15
 voter 263 22
 voter, qualified ~ 263 24
 votive candle 330 53
 voussoir 336 22
 V-seat 295 13
 V-support 295 17
 V-tail 229 31
 vulcanicity 11 13-28
 vulva 16 39
 V-valley 13 53
 V-way Joiner 132 61
 V-way *Composing Rm.* 175 54

W

wad, felt ~ 87 52
 wafer *Bakery* 97 45
 wafer *Church* 332 28
 wafer, sacred ~ 332 48
 waffle 97 45
 waffle iron, electric ~ 40 34
 waggonette 186 2
 wagon 213 18
 wagon, flat ~ 206 21, 24; 213 5, 11, 40
 wagon, large-capacity ~ 213 28
 wagon, open ~ 213 33
 wagon, special ~ 213 33
 Wagoner 3 27
 wagon load 206 52
 wagon truck 200 25
 wagtail 360 9
 waist *Man* 16 31
 waist *Shoem.* 100 68
 waist, corseted ~ 355 53
 waistband *Ladies' Wear* 31 41
 waistband *Men's Wear* 33 23
 waistcoat 33 4, 15
 waistcoat, denim ~ 31 59
 waistcoat, embroidered ~ 355 75
 waistcoat, knitted ~ 33 53
 waistcoat, quilted ~ 30 16
 waist longeron 235 9
 waist slip 32 14; 309 85
 waiter 267 47
 waiter, head ~ 266 30
 waiting room *Doc.* 22 1
 waiting room *Station* 204 14
 waiting room *Airport* 233 18
 'waiting room' *Airport* 233 28
 waitress 265 13; 266 18
 wake 223 58
 wake-robin 379 9
 waldhorn 323 41
 walk 71 2; 72 39

walk, gravel ~ 272 18
 walkie-talkie set 270 41
 walking stick 41 5
 walking-stick umbrella 205 12
 walkway *Dwellings* 37 60
 walkway *Street Sect.* 198 9
 walkway *Hydr. Eng.* 217 72
 wall *Map* 15 95
 wall *Carp.* 120 29
 wall *Equest.* 289 8
 wall *Ball Games* 291 44
 wall, brick ~ 118 8; 123 29; 260 45
 wall, concrete ~ 123 1
 wall, framed ~ 120 48
 wall, glass ~ 37 16
 wall, hollow-block ~ 118 15
 wall, inner ~ 329 19
 wall, mirrored ~ 317 28
 wall, outer ~ 121 32, 77; 122 37
 wall, Rococo ~ 336 9
 wall, rubble concrete ~ 119 7
 wall, side ~ 42 2; 46 4; 222 37
 wall, slatted ~ 213 29
 wall, stone ~ 337 23
 wall, timber ~ 119 25; 120 9
 wall bars 61 28
 wall bars 296 20
 wall brush flat ~ 129 17
 wall calendar 22 17; 245 3; 248 42
 wall candelabrum 330 16
 wall chart 195 32
 wall clock 109 32; 309 87
 wall connection 25 23
 wall cupboard 39 8; 46 30
 wall desk 267 16
 wall espalier 52 1
 wall fountain 272 15
 wall gecko 364 36
 wall joist 120 39
 wall lamp 265 9
 wall lining, 'acoustic' ~ 310 15
 wall map 260 44
 wall memorial 331 14
 wall mirror 309 3
 wall-of-death rider 308 54
 wall outlet 127 5
 wall outlet, double ~ 127 6
 wallower 91 11
 wallpaper 128 18; 19
 wallpaper, synthetic ~ 128 18
 wallpaper-cutting board 128 41
 wallpapering 128 18-53
 wallpaper paste 128 23
 wallpaper-stripping liquid 128 1
 wallpaper-stripping machine 128 9
 wall pepper 51 7
 wall plaster 123 60
 wall plate 120 40, 49
 wall shelf 104 8
 wall shelf unit 104 8
 wall socket 39 26; 127 5
 wall socket, double ~ 127 6
 wall stone 331 14
 wall string 123 45

wall stringer 123 45
 wall switch 127 16
 wall unit 42 1; 44 17; 46 1
 wall ventilator 266 15
 walnut 59 41, 43
 walnut tree 59 37-43, 37
 walrus 367 20
 wane 120 89
 waney edge 120 89
 Wankel engine, two-rotor ~ 190 5
 wapiti 367 2
 ward, inner ~ 329 2
 ward, outer ~ 329 31
 wardrobe 43 1
 wardrobe door 46 2
 wardrobe trunk 267 29
 warehouse *Station* 206 53
 warehouse *Docks* 225 23
 warhead 255 65
 war horn, ivory ~ 354 39
 warm-air brush 106 30
 warm-air comb 105 22; 106 29
 warm-air curtain 271 43
 warm-air regulator 191 87
 warm house 55 4, 32
 warm-up regulator 190 50
 warning cross 202 41
 warning light 191 67, 72, 76, 80; 202 46, 50; 224 69; 230 64; 270 6
 warning sign 280 6
 warp *Sea Fish.* 90 12
 warp *Weaving* 165 43; 166 39
 warp *Knitting* 167 24
 warp *Weaves* 171 14
 warp *Hydr. Eng.* 217 23
 warp, wire ~ 90 15
 war paint 352 13
 warp beam 165 29, 42; 166 48; 167 24
 warp beam, sized ~ 165 56
 warping capstan 217 22
 warping machine 165 22
 warping machine frame 165 27
 warp-knitting machine 167 23
 warp let-off motion 166 61
 warp rib fabric 171 14
 warp rib weave 171 13
 warp thread 166 39; 171 1-29, 2, 17, 18
 warp thread, lowered ~ 171 8
 warp thread, raised ~ 171 7
 warren 86 23
 warship, Roman ~ 218 9-12
 warships 258; 259
 washbasin 24 15; 49 24; 126 27, 31; 278 6
 washbasin, double ~ 267 32
 washbasin pedestal 49 27
 washboard *Floor etc. Constr.* 123 21, 63
 washboard *Flea Market* 309 70
 wash-bottle 349 8
 washer *Photog.* 116 15
 washer *Mach. Parts etc.* 143 17, 34

washer *Sawmill* 157 21
 washer *Bicycle* 187 55
 washer, lead ~ 122 103
 washing 169 19; 170 48, 56
 washing and toilet facilities 278 5-6
 washing basin 309 65
 washing bottle 261 32
 washing drum 50 24
 washing floor 92 3, 27
 washing line 38 23; 50 33
 washing machine 157 21
 washing machine, automatic ~ 50 23
 washing machines 50 23-34
 washing set 309 64
 washing trough 165 49
 washing unit, compressed-air ~ 92 3
 washing-up area 207 28
 washing-up brush 50 51
 wash liquor, weak ~ 172 44
 washroom 207 15; 278 5
 washstand *Railw.* 207 40
 washstand *Flea Market* 309 67
 wash tank *Photog.* 116 15
 wash tank *Oil, Petr.* 145 30
 washtub 309 69
 wash water, weak ~ 172 44
 wasp 82 35
 wasp waist 355 53
 waste 144 37
 waste, medium-activity ~ 154 72
 waste, nuclear ~ 154 57-68
 waste, radioactive ~ 154 57-68, 77
 waste bin 22 70; 96 46
 waste-gas heat exchanger 155 9
 wastepaper basket 46 25; 248 45
 waste pipe *Bathrm. etc.* 49 45
 waste pipe *Street Sect.* 198 26
 waste steam exhaust 210 22
 waste tray, mobile ~ 26 22
 waste water discharge 156 38
 waste water outlet 217 62
 waste water pump *Paperm.* 172 63
 waste water pump *Refuse Coll.* 199 20
 watch, automatic ~ 110 32-43
 watch, waterproof ~ 109 26; 279 16
 watchdog 62 32; 70 25
 watches 110
 watchglass-fitting tool 109 11, 29
 watchkeeper 221 126
 watchmaker 109 1
 watchman 329 9
 watch strap 110 5
 watch strap, metal ~ 109 19
 watch-testing machine 109 24
 watch-timing machine 109 25
 watchtower 329 35
 water 48 8

water, artesian ~ 12 21
 water, baptismal ~ 332 12
 water, entrapped ~ 13 16
 water, raw ~ 269 4
 water, rising ~ 12 26
 water, running ~ 89 1
 water, shallow ~ 224 87, 97
 water, underlying ~ 12 32
 water and brine separator 145 32
 water appliances 126 12-25
 water ballast 223 78
 water barrel 52 4
 water bath 132 12; 349 14
 water bath, constant temperature ~ 23 48
 Water Bearer 4 63
 water bottle 290 10
 water buffalo 367 8
 water bug 358 4
 water butt 52 4
 water canister 83 57
 water cannon 270 66; 316 18
 Water Carrier *Astron.* 4 63
 water carrier *Camping* 278 32
 water channel 334 54
 water circuit, auxiliary ~ 259 63
 water circuit, primary ~ 259 65
 water circuit, secondary ~ 259 63
 water-collecting tank 92 5
 watercolour 260 27; 338 18
 water connection 179 5
 water container 103 22
 water cooler 189 35
 water-cooling system *Moon* L. 6 26
 water-cooling system *Iron Foundry* etc. 148 28
 watercross 378 30
 water croet 332 45
 water elf 327 23
 water extractor 281 39
 waterfall 11 45
 waterfall, artificial ~ 272 9
 water feed pipe 103 21
 waterfowl 272 51-54
 waterfowling 86 40
 water gauge *Map* 15 29
 water gauge *Roof & Boilerr.* 38 63
 water gauge *Railw.* 210 45
 water gauge *Chem.* 349 16
 water glass 24 13
 water heater 145 31
 water heater, electric ~ 126 13
 water heater, gas ~ 126 12
 water heater, instantaneous ~ 126 12-13
 watering can 51 21; 55 26
 water inlet *Fish Farm.* 89 7
 water inlet *Plumb.* etc. 126 18
 water inlet *Water* 269 54
 water inlet pipe 168 11
 water jet pipe 281 40
 water jet pump 23 49
 water jug 309 66
 water jump 289 20
 water level 13 77

water lily 51 18; 272 56
 waterline 258 27; 285 31
 water main 198 22
 watermark 252 31
 water meter 269 53
 water-meter dial 269 58
 watermill *Map* 15 77
 watermill *Mills* 91 35-44
 water molecule 242 67
 water moth 358 12
 water newt 364 20
 water nixie 327 23
 water nymph *Fabul. Creat.* 327 23
 water nymph *Articulates* 358 3
 water outlet *Fish Farm.* 89 8
 water outlet *Energy Sources* 155 23
 water outlet *Water* 269 57
 water outlet pipe 116 17
 water overfall 91 43
 water ox 367 8
 water pipe *Market Gdn.* 55 30
 water pipe *Poultry Farm* 74 7, 26
 water pipe *Tobacc.* etc. 107 42
 water pipe *Power Plant* 152 7
 water pipe *Paperm.* 172 65
 water pipe *School* 261 4
 water plantain 378 44
 water plants 378 14-57
 water polo 282 46-50
 water polo ball 282 48
 water preheater 152 10
 waterproofing 123 5
 water pump 190 61
 waters, coastal ~ 286 10-14
 waters, inshore ~ 286 10-14
 water scorpion 358 4
 water ski 280 16
 water ski, types of ~ 286 56-62
 water skier 286 45
 water skiing 286 45-62
 water slater 358 2
 Water Snake *Astron.* 3 16
 water snake *Fish* etc. 364 38
 water supply 27 46; 269
 water supply, individual ~ 269 40-52
 water supply pipe *Brew.* 92 48
 water supply pipe *Photog.* 116 16
 water table 13 77; 269 1, 42, 63
 water tank *Market Gdn.* 55 2, 29
 water tank *Gas Weld.* 141 17
 water tank *Refuse Coll.* 199 27
 water tank *Railw.* 210 66
 water tank *School* 261 33
 water tank *Theatre* 316 51
 water tanker 233 22
 water tap 39 36; 49 26; 126 31
 water temperature 280 8
 water temperature gauge 191 38, 66
 water tender 270 51
 water tower *Map* 15 81

water tower *Market Gdn.* 55 2
 water tower *Coal* 144 14
 water tower *Water* 269 18
 water trough 137 8
 water tub 281 26
 water-tube boiler 152 5
 water vole 366 17
 waterway engineering 217
 water wings 281 7; 282 18
 Watling Street thistle 61 32
 wattle 73 24
 wave 13 36; 287 17
 wave, seismic ~ 11 36
 waves, artificial ~ 281 1-9
 wave soaring 287 16
 wave system 287 17
 waxing cork 301 23
 waxing iron 301 22
 wax scraper 301 24
 wax separation 145 50
 waxworks 308 68
 waybill 206 30
 wayside flowers 375; 376
 WC 49 12; 207 16, 42, 72; 211 59; 231 31; 317 31
 weaponry 255 1-98
 weapons, heavy ~ 255 40-95
 weapon system radar 258 35
 weasel 367 16
 weather 8 1-19
 weather chart 9 1-39; 342 66
 weather cloth 223 17
 weathercock 331 3
 weather map 9 1-39; 342 66
 weather radar antenna 231 18
 weather report 342 65
 weather satellite 10 64
 weather ship 9 7
 weather station 9 7; 225 33
 weather vane 121 26; 331 4
 weave, plain ~ 171 1, 4, 24
 weaver 136 5
 weaves *Basketm.* 136 1-4
 weaves *Weaves* 171 1-29
 weaving 165; 166
 weaving draft 171 29
 weaving machine 166 1, 35
 web *Dom. Anim.* 73 36
 web *House Insects* etc. 81 10
 web *Paperm.* 173 30, 45
 web *Letterpress* 181 43, 58
 web *Railw.* 202 3
 web *Gymn.* 297 11
 web *Articulates* 358 47
 web *Birds* 359 7
 webfoot 359 6
 web-offset press 180 1, 18
 wedding ceremony 332 14
 wedding ring 36 5; 332 17
 wedding ring box 36 6
 wedding ring sizing machine 108 24
 wedge 119 15; 132 19; 158 7
 wedge, hardwood ~ 121 96
 wedge, optical ~ 176 22
 wedge heel 101 55
 wedge stone 336 22
 weed 379 8
 weeding hoe 51 22
 weeds 61
 weekend house 37 84-86

weeping willow 272 63
 weevil 80 10, 49; 82 42
 weft feeler 166 31
 weft feeler, electric ~ 166 14
 weft pirn 166 7
 weft replenishment 166 5
 weft thread 171 1-29, 3
 weft thread, lowered ~ 171 15
 weft thread, raised ~ 171 16
 weft yarn 163 2
 weigela 373 23
 weigelia 373 23
 weighbridge 206 41
 weighbridge office 206 40
 weighing apparatus 92 32; 170 29
 weighing bottle 349 24
 weighing bunker 225 22
 weighing machine 206 31
 weighing platform 22 67
 weigh office 199 12
 weight *Roof & Boilerr.* 38 32
 weight *Sea Fish.* 90 10
 weight *Clocks* 110 32
 weight *Railw.* 202 18
 weight *Athletics* 298 49
 weight, iron ~ 90 21
 weight belt 279 14
 weighing disc 165 21
 weightlifter 299 2
 weightlifting 299 1-5
 weights, lead ~ 89 88-92
 weir *Map* 15 66
 weir *Hydr. Eng.* 217 65-72
 weir *Rowing* 283 60
 weir sill 217 79
 welder electrode arm 142 30
 weld gauge 142 36
 welding bench 141 13; 142 21
 welding glove, five-fingered ~ 142 32
 welding glove, three-fingered ~ 142 8
 welding goggles 141 24
 welding lead 142 19
 welding nozzle 141 33
 welding paste 141 18
 welding pressure adjustment 142 31
 welding rod 141 12
 welding table 142 13
 welding torch 141 11, 19, 28
 welding transformer 125 29; 142 1, 27
 well *Astron.* 5 24
 well *Map* 15 100
 well *Carp.* 120 46
 well *Joiner* 132 35
 well *Oil, Petr.* 145 17
 well *Water* 269 40
 well, artesian ~ 12 25
 well, driven ~ 269 60
 well, glass-roofed ~ 271 11
 well casing 269 64
 well head 269 65
 wellington boot 101 14
 wellingtonia 372 69
 wels 364 12
 welt, knitted ~ 29 65; 31 70
 welt, stretch ~ 31 43
 welt cutter 100 48

welt pincers 100 38
 West Australian Current 14 45
 westerlies 9 50
 Western roll 298 16
 west point 4 15
 West Wind Drift 14 44
 westwork 335 22
 wet and dry bulb thermometer 10 52
 wet bulb thermometer 10 35
 wet felt, first ~ 173 17
 wet felt, second ~ 173 18
 wether 73 13
 wet oil tank 145 30
 wetsuit, neoprene ~ 279 9
 wetting trough 165 44
 Weymouth pine 372 30
 Whale 3 11
 whales 367 23-29
 wharve 164 48
 wheat 68 1, 23
 wheat and rye bread 97 6, 8
 wheat beer 93 26
 wheat flour 97 52; 99 63
 wheatgerm bread 97 48
 wheatgerm oil 98 24
 wheel *Overh. Irrign.* 67 24
 wheel *Clocks* 110 11
 wheel *Bicycle* 187 1
 wheel *Aircraft* 230 24
 wheel, back ~ 186 17
 wheel, co-pilot's ~ 230 25
 wheel, front ~ 186 4; 187 26-32
 wheel, light alloy ~ 189 48
 wheel, rear ~ 186 17
 wheel, rubber-tyred ~ 64 32
 wheel, ship's ~ 224 15
 wheel, spoked ~ 289 25
 wheel adjustment 64 58
 wheel alignment 195 17, 21
 wheel alignment, visual ~ 195 41
 wheel and axle drive 212 28
 wheel and axle set 212 3; 213 3
 wheelarch doorway 278 39
 wheelbarrow 56 47; 118 37; 119 42
 wheelbarrow sprayer 83 38
 wheel brush, wire ~ 134 24
 wheel cover 322 27
 wheel cylinder 192 54
 wheel disc, plastic ~ 289 25
 wheeler 186 47
 wheel flange lubricator 211 52
 wheel guard *Tram* 197 11
 wheel guard *Music, Instr.* 322 27
 wheelhead slide 150 3
 wheelhorse 186 47
 wheelhouse 223 18; 224 14-38
 wheel lock 187 49
 wheel mirror 195 41
 wheel nut 187 53
 wheel of fortune 308 45
 wheel plough 65 1
 wheel ratchet 110 10

wheel rim 187 28; 189 25; 191 16; 192 77
 wheelsman 224 16
 wheel tapper 205 39
 wheel-tapping hammer 205 40
 whelp 73 16
 whetstone 66 19
 whetting anvil 66 11
 whetting hammer 66 9
 whip *Blgd. Site* 118 30
 whip *Equest.* 289 43
 whip *Circus* 307 53
 whip antenna 258 60
 whip line 228 3
 whipper-in 289 43
 whipping unit 97 70
 whip stall 288 5
 whirler 179 1
 whirligig 308 2
 whirlpool, hot ~ 281 31, 35
 whirlpool separator 93 2
 whisk 39 23
 whiskers *Hairst. etc.* 34 12
 whiskers *Mammals* 367 21
 whisky 42 31; 98 56
 whisky glass 267 57
 whistle *Kitch. Utensils* 40 11
 whistle *Railw.* 211 9; 212 49
 whistle *Navig.* 224 70
 whistle lever 211 40
 whistle valve handle 210 51
 white *Poultry Farm* 74 62, 67
 white *Heraldry* 254 25
 white *Colour* 343 11
 white bear 368 11
 white clover 69 2
 white light, supplementary ~ 203 15
 white line 268 72
 white owl 362 17
 white daisy 376 4
 white pelican 359 5
 white pine 372 30
 white poplar 371 23
 white-tailed eagle 362 5
 white-tailed sea eagle 362 5
 white wagtail 360 9
 white water lily 378 14
 white water pump 172 63
 white wine glass 45 82
 whitewood 374 1
 wholemeal bread 97 48
 whole note 320 13
 whole rest 320 21
 whortleberry 377 23
 wick 107 29
 wickerwork 136 4, 16
 wicket 292 70
 wicket keeper 292 73
 wide screen camera 310 47
 width *Roof* 122 91, 95
 width *Composing Rm.* 175 48
 width adjustment 100 19
 width scale 157 58
 width-setting tree 100 55
 Wiener 96 8
 wig 105 38; 315 49
 wig, full-bottomed ~ 34 2
 wig, partial ~ 355 8
 wig block 105 39

wiggler 89 72
 wigwam 352 7
 wild animal cage 307 49
 wild animal tamer 307 52
 wild arum 379 9
 wild barley 61 28
 wild boar 86 32; 88 51
 wild briar 373 26
 wild camomile 380 1
 wild cherry 59 5
 wild chicory 376 25
 wild endive 376 25
 wildfowling 86 40
 wild morning glory 61 26
 wild mustard 61 18
 wild oat 61 29
 wild orchid 376 28
 wild pear tree 58 31
 wild radish 61 21
 wild sow 86 32; 88 51
 wild strawberry 58 16
 wild-water racing kayak 283 69
 willow rod 136 15
 willow stake 136 14
 Wilson chamber 2 24
 Wilson cloud chamber 2 24
 winch 270 56
 winched launch 287 5
 winch house 226 54
 wind arrow 9 9
 wind avalanche 304 1
 wind box 147 69
 windbreak 354 35
 wind chest 326 12; 12-14
 wind chest box 326 12
 wind cone 287 11
 wind cripple 13 43
 wind direction 9 9-19; 285 6
 wind-direction indicator 10 31
 wind directions 285 1-13
 wind-direction shaft 9 9
 wind-direction symbols 9 9-19
 windflower 375 5; 377 1
 wind gauge 10 28
 wind generator 55 34; 155 42
 winding, low-voltage ~ 153 16
 winding, primary ~ 153 15
 winding, secondary ~ 153 16
 winding crown 110 42
 winding engine house 144 2
 winding gear 217 74
 winding handle 117 50
 winding inset 144 26
 wind knob 110 23
 windlass 223 49; 258 6
 windmill *Map* 15 31
 windmill *Mills* 91 1-34
 windmill *Fair* 308 15
 windmill, Dutch ~ 91 29
 windmill, German ~ 91 31
 windmill arm 91 1
 windmill cap, rotating ~ 91 30
 windmill sail 91 1
 windmill vane 91 1
 window 2 16; 6 40; 25 8; 28 36, 49; 75 31; 77 50; 186 10; 268 14; 284 38

window, circular ~ 335 12
 window, double casement ~ 37 22
 window, heated ~ 191 80
 window, lead glass ~ 154 75
 window, rear ~ 191 32, 80
 window, side ~ 231 29
 window, single casement ~ 37 23
 window, sliding ~ 207 7
 window, transparent ~ 278 41; 284 3
 window box 268 15
 window breast 37 24
 window decoration 260 68; 268 12
 window display 98 1; 268 11
 window frame 133 44
 window glass 124 5
 window head 37 25; 118 9; 120 57
 window jamb 120 51
 window ladder 296 21
 window ledge 118 12; 120 33
 window lintel 120 57
 window opening 120 30
 window painting 260 26
 window shutter 37 30
 window sill 37 24; 118 12; 120 33
 window vent 55 10
 windpipe 17 50; 20 4
 wind power plant 155 42
 wind pump 15 73; 55 34
 windrow 63 36
 wind screen 5 15
 windscreen, panoramic ~ 191 21
 windscreen wiper 191 41; 197 32
 wind shaft 91 5
 windshield 5 31
 windshield, panoramic ~ 191 21
 windshield wiper 191 41
 wind sock 287 11
 wind speed 9 10
 wind-speed barb 9 10
 wind-speed feather 9 10
 wind-speed indicator 10 29
 wind-speed meter 10 29
 windsurfer 284 1
 windsurfing 284 1-9
 wind systems 9 46-52
 wind trunk 326 11
 wind vane 10 32; 55 36; 331 4
 wind wheel 55 35
 wine 99 76; 266 43
 wine, bottled ~ 98 60-64
 wine, red ~ 98 64
 wine, sparkling ~ 98 63
 wine, white ~ 98 60
 wine bar 266 30-44
 wine bottle 79 14
 wine carafe 266 32
 wine cask 79 2
 wine cellar 79 1-22
 wine cooler 266 42
 wine cruets 332 46
 wineglass 44 9; 45 12, 82, 83; 79 19; 266 33; 317 7

wine grower 78 13
 wine growing 78
 wine in bottles 98 60-64
 wine jug 79 15
 wine list 266 31
 wine press, horizontal ~ 79 21
 wine restaurant 266 30-44
 wine tasting 79 16
 wine vat 79 3
 wine vault 79 1-22
 wine waiter 266 30
 wing *House Insects etc.* 81 8
 wing *Game* 88 76, 79
 wing *Sea Fish* 90 16
 wing *Aircraft* 230 43
 wing *Airports* 288 27
 wing *Fabul. Creat.* 327 15, 28, 51, 60
 wing *Decid. Trees* 371 57
 wing *Conifers* 372 9
 wing, bat's ~ 327 4
 wing, central ~ 229 8
 wing, cranked ~ 229 14
 wing, elliptical ~ 229 15
 wing, front ~ 191 3
 wing, hind ~ 358 33
 wing, lower ~ 229 9
 wing, membranous ~ 82 11
 wing, middle ~ 229 8
 wing, multispar ~ 287 29
 wing, ogival ~ 229 22
 wing, rectangular ~ 229 16
 wing, rotary ~ 232 12
 wing, swept-back ~ 229 20, 21
 wing, tapered ~ 229 17
 wing, upper ~ 229 7
 wing case 82 10
 wing configurations 229 1-14
 Winged Horse 3 10
 winger 291 16
 wing mirror, left-hand ~ 191 40
 wing mirror, right-hand ~ 191 56
 wing nut 143 42; 187 39
 wing of bridge 223 16
 wing rail 202 25
 wings 307 12
 wing shapes 229 15-22
 wing span 229 2
 wing suspension, inner ~ 257 34
 wing suspension, outer ~ 257 35
 wing tally 74 55
 wing tank 256 4
 wing tank, integral ~ 257 29
 wing tip 287 42
 wing-tip tank 231 9; 256 30
 wing wall *Rivers* 216 35
 wing wall *Hydr. Eng.* 217 80
 winker 71 26
 winner 299 39
 winner's price 289 39
 winners' table 289 38
 winning peg 292 77
 winnowing 64 15
 winter boot 101 1
 winter coat 30 61
 winter dike 216 32
 winter dress 30 12

winter green 57 34
 winter moth 80 16
 winter slacks 30 19
 winter sports 301; 302; 303
 winter wear 30
 wiper *Post* 237 44
 wiper *Graphic Art* 340 13
 wiper/washer switch and horn 191 60
 wire *Papern.* 173 14
 wire *Fencing* 294 31
 wire, gold ~ 108 3
 wire, iron ~ 143 12
 wire, overhead ~ 194 43
 wire, silver ~ 108 3
 wire and sheet roller 108 1
 wireless mast 15 33
 wireman 127 1
 wire side 173 34
 wire spool, spring-loaded ~ 294 29
 wire stripper and cutter 134 15
 wire strippers 127 64
 wireworm 80 38
 witch 306 6
 witchgrass 61 30
 withers *Dog* 70 11
 withers *Horse* 72 17
 witloof 376 25
 witness 332 23
 wobbler, double-jointed ~ 89 78
 wobbler, round ~ 89 71
 wobbler, single-jointed ~ 89 69
 wolf 367 13
 wolfsbane 379 1
 womb 20 79
 wood *Forestry* 84 1-34
 wood *School* 260 82
 wood *Ball Games* 293 91
 wood *Sculpt. Studio* 339 27
 wood, coniferous ~ 15 1
 wood, deciduous ~ 15 4
 wood, mixed ~ 15 14
 wood, open ~ 326 31-33
 wood, rough ~ 135 21
 wood anemone 377 1
 woodbind 374 13
 woodbine 51 5; 374 13, 16
 wood carver 339 28
 wood carving 260 77
 wood chip paper 128 18
 wood chisel 339 19
 wood cut 260 83
 wood cutting *Forestry* 84 15-37
 woodcutting *Graphic Art* 340 2
 wood engraving 340 1, 1-13
 wood file 132 2
 wood grouse 88 72
 wood haulage way 84 3
 woodland strawberry 58 16
 woodlark 361 18
 wood louse 81 6
 woodpecker 359 27
 wood pulp, chemical ~ 172 77, 78
 wood pulp paper 128 18

wood rasp 132 1; 134 8; 260 55
 wood screw 122 101; 132 41; 143 45
 wood screw thread 143 47
 wood sculptor 339 28
 woodsman 84 18
 wood tick 358 44
 wood-turning lathe 134 51; 135 1
 woodwind instruments 323 28-38
 woodwinds 323 28-38
 woodworking adhesive 134 36
 woofers 241 17
 woolly apple aphid 80 32, 33
 woolly apple aphid colony 80 34
 woolly milk cap 379 13
 woolpack cloud 8 1; 287 22
 work 118 17
 workbench 97 60, 62; 100 33; 104 7; 108 20; 109 2; 111 20; 124 15; 125 10; 137 21; 140 7; 260 46
 workbench, collapsible ~ 134 41
 workbench lamp 109 12
 workboard 136 7
 work clamp *Joiner* 132 51
 work clamp *Arc Weld.* 142 35
 worker *Bees* 77 1, 6-9, 10-19
 worker *Articulates* 358 22
 worker bee 77 1
 worker cell 77 34
 work folder 261 27
 working, open-cast ~ 158 1
 working area 162 5
 working bath 162 5
 working deck 221 19, 34
 working face 158 3
 working passage 75 24
 working platform 118 17; 145 5; 211 42; 234 28, 46
 workings, underground ~ 144 21-51
 working surface, tiled ~ 261 5
 working top 39 11
 workpiece 104 25; 133 44; 139 46; 140 6; 141 20; 142 28; 148 51; 150 20
 workpiece, blocked ~ 139 28
 workpiece, preshaped ~ 139 28
 work platform 118 17; 211 42; 234 28, 46
 workroom, dressmaker's ~ 103 1-27
 workroom, furrier's ~ 131 1-25
 workroom, tailor's ~ 104 1-32; 268 17
 works 153 7
 workshop 62 17; 146 30; 310 6; 315 28-42
 workshop, bootmaker's ~ 100 1-68
 workshop, carpenter's ~ 120 4
 workshop, cooper's ~ 130 1-33

workshop, fitter's ~ 140 1-22
 workshop, glazier's ~ 124 1
 workshop, joiner's ~ 132 1-73
 workshop, locksmith's ~ 140 1-22
 workshop, mechanic's ~ 140 1-22
 workshop, optician's ~ 111 20-47
 workshop, orbital ~ 235 66
 workshop, shoemaker's ~ 100 1-68
 workshop, tank construction engineer's ~ 130 1-33
 workshop, turner's ~ 135 1-26
 workshop area 5 17
 workshop door 120 5
 workshop trolley 109 22
 work top 50 31
 worm 192 59
 worm-and-nut steering gear 192 56-59
 worm gear sector 192 57
 wormhole 58 65
 worms 357 20-26
 wormwood 380 4
 worshipper 330 29
 wort 92 50, 51, 52
 wort boiler 92 52
 wort cooler 93 5
 wort cooling 93 1-5
 wound 21 8
 wrap, coloured ~ 355 10
 wrapper *Tobacc. etc.* 107 5
 wrapper *Bookbind.* 185 37
 wrapping, jute ~ 163 4
 wrapping counter 271 14
 wrapping material 98 46-49
 wrapping paper 98 46
 wreath 123 52
 wreath, bridal ~ 332 19
 wreath of the colours 254 2
 wreath piece 123 49
 wreck 224 84
 wrecking crane 270 47
 wreck to port 224 86
 wreck to starboard 224 85
 wren 361 12
 wrench 134 14
 wrench, open-end ~ 134 2
 wrest 325 20
 wrestler 299 7
 wrestling 299 6-12
 wrestling, Greco-Roman ~ 299 6-9
 wrestling mat 299 12
 wrest pin 324 23; 325 17
 wrest pin block 324 22; 325 18
 wrest plank 324 22; 325 18
 wrist *Man* 19 76
 wrist *Horse* 72 22
 wristband 296 64
 wrist joint 2 41
 wrist sling 300 32
 wristwatch, automatic ~ 110 32-43
 wristwatch, electronic ~ 110 1
 writing, English ~ 342 10
 writing, German ~ 342 11
 writing cane 341 23
 writing surface 47 23; 246 3

writing system, pictorial

writing system, pictorial ~
341 1
writing unit 46 21
wrought-iron craftsman 140
1
wryneck 359 27

X

xanthate 169 10
X-contact 115 14
xenon lamp 177 17
xenon lamp housing 177 42
X-radiation 1 33, 56
X-ray 25 39
X-ray apparatus 24 21; 27 6
X-ray cassette 27 2
X-ray control unit, central ~
27 9
X-ray examination table 27 1
X-ray generator 24 22
X-ray head 27 18
X-ray image intensifier 27 16
X-ray support, telescopic ~ 27
8
X-ray technician 27 11
X-ray tube 27 17, 18
X-ray unit 27 1-35
xylography 340 1-13
xylophone 324 61

Y

yacht 273 29; 278 12; 284
10-48
yacht classes 284 49-65
yacht hull, types of ~ 285
29-41
yachting 284; 285
yachting cap 35 29
yacht stern 285 42
yacht stern, types of ~ 285
42-49
yacht tacking 285 7
yankee corn 68 31
yard 276 27
yardmaster 206 45
yard radio 212 50; 213 4
yarn 164 53, 56; 167 17, 36;
169 17, 25
yarn, doubled ~ 164 60
yarn, glass ~ 162 56, 57
yarn, inlaid ~ 171 43
yarn, sleeved ~ 162 57

yarn, viscose rayon ~ 169
1-34, 27
yarn count 164 40
yarn-distributing beam 167
25
yarn-dividing beam 167 25
yarn feeder 167 6
yarn-forming frame,
intermediate ~ 164 27
yarn guide *Shoem.* 100 30
yarn guide *Knitting* 167 3, 54,
64
yarn guide support post 167 2
yarn length recorder 165 28
yarn package 165 15; 170 48
yarn package container 165
16
yarn-tensioning device 167 5
yarrow 376 15
yawing 230 69
yaw 220 10
y-axis 347 3
Y-connection 153 20
Y-cross 332 61
yeast 93 6
yeast, baker's ~ 97 53
yeast bread 97 11
yeast propagation 93 6
yellow *Heraldry* 254 24
yellow *Colour* 343 2
yellow bunting 361 6
yellow card 291 63
yellow coral fungus 381 32
yellow filter adjustment 116
44
yellow flag 60 8
yellow-flowered jasmine 373
4
yellowhammer 361 6
yellow iris 60 8
yellow light 203 16
yellow lupin 69 17
yellow meal beetle 81 23
yellow owl 362 17
yellow prickle fungus 381 31
yellow water flag 60 8
yerba maté 382 11
yew tree 372 61
yoghurt maker 40 44
yoke *Bldg. Site* 119 64
yoke *Power Plant* 153 14
yoke *Rowing* 283 51
yoke, adjustable ~ 65 14
yoke, bolted ~ 119 74
yoke, front ~ 33 19
yoke, kimono ~ 31 18

yoke elm 371 63
yoke mount, English-type ~
113 23
yoke mounting, English-type
~ 113 23
yolk 74 68
yolk sac 74 64
Y-tube 350 56
yucca 373 24
yurt 353 19
yurta 353 19

Z

zap flap 229 50
Z-drive motorboat 286 2
zebra 366 27
zebra crossing 198 11; 268 24
Zechstein, leached ~ 154 62
Zechstein, lixiviated ~ 154 62
Zechstein shale 154 68
zenith *Astron.* 4 11
zenith *Hunt.* 87 77
zero 275 18
zero adjustment 2 7
zero isotherm 9 41
zero level 7 6, 20
ziggurat 333 32
zimmerstutzen 305 35
zinc plate 179 9; 180 53; 340
52
zinc plate, etched ~ 178 40
zinc plate, photoprinted ~ 178
32
zink 322 12
zinnia 60 22
zip 31 55; 33 28; 260 13
zip, front ~ 29 18
zip, inside ~ 101 6
zip code 236 43
zircon 351 19
zither 324 21
zone, arid ~ 9 54
zone, paved ~ 268 58
zone, tropical ~ 9 53
zoo 356
zoological gardens 356
zooming lever 117 54; 313 22,
36
zoom lens 112 41; 240 34; 313
23
zoom lens, interchangeable ~
117 2
zoom stereomicroscope 112 40
Zulu 354 36



MORE OXFORD PAPERBACKS

Details of a selection of other Oxford Paperbacks follow. A complete list of Oxford Paperbacks, including The World's Classics, Twentieth-Century Classics, OPUS, Past Masters, Oxford Authors, Oxford Shakespeare, and Oxford Paperback Reference, is available in the UK from the General Publicity Department, Oxford University Press (RS), Walton Street, Oxford, OX2 6DP.

In the USA, complete lists are available from the Paperbacks Marketing Manager, Oxford University Press, 200 Madison Avenue, New York, NY 10016.

Oxford Paperbacks are available from all good bookshops. In case of difficulty, customers in the UK can order direct from Oxford University Press Bookshop, 116 High Street, Oxford, Freepost, OX1 4BR, enclosing full payment. Please add 10 per cent of the published price for postage and packing.

A SPLENDID QUARTET OF SHORT STORIES

CLASSIC IRISH SHORT STORIES

Selected and Introduced by Frank O'Connor

The Irish short story, Frank O'Connor believes, is 'a distinct art form' and the stories he has chosen for this collection show how the form has remained peculiarly itself while being developed in various ways in response to changing social and political conditions. Authors include James Joyce, Liam O'Flaherty, Seán O'Faoláin, George Moore, and Elizabeth Bowen.

CLASSIC ENGLISH SHORT STORIES

Selected and Introduced by Derek Hudson

The years 1930 to 1955 marked a high point in the fortunes of the English short story. Inevitably the Second World War left its mark on many of the tales Derek Hudson has collected here, but, he argues, the dominating impression is that very English characteristic, humour. The authors include Somerset Maugham, Virginia Woolf, Evelyn Waugh, Graham Greene, H. E. Bates, and Rosamond Lehmann.

CLASSIC SCOTTISH SHORT STORIES

Selected and Introduced by J. M. Reid

CLASSIC AMERICAN SHORT STORIES

Selected and Introduced by Douglas Grant

Also in Oxford Paperbacks:

CLASSIC ENGLISH SHORT STORIES

The Dragon's Head
The Killing Bottle
Charmed Lives
The Green Man Revisited

THE WORLD'S CLASSICS

The World's Classics Series makes available the greatest works of world literature at reasonable prices.

'An addition to the library of anyone setting out either to study or begin to read English literature.' *Times Educational Supplement*

COLONEL JACK

Daniel Defoe

Edited by Samuel Holt Monk

With a new Introduction by David Roberts

'Born a gentleman, put 'Prentice to a Pick-Pocket, was Six and Twenty Years a Thief, and then Kidnapp'd to Virginia. Came back a Merchant, married four Wives, and five of them prov'd Whores . . .'

Colonel Jack begins among the alleyways of London and ends in crime, marital disaster, political adventurism, and penitent prosperity. Its elusive hero has been compared to Oliver Twist, Lucky Jim, and to modern criminals who have made their fortune and escaped the law. Jack the occasional Jacobite succeeds almost in spite of himself in making his world conform to his highly individual ends. The result is a novel which subjects a vast range of eighteenth-century life to the scrutiny of an intriguingly unreliable narrator.

Samuel Holt Monk's Oxford English Novels text, the first to use the rare first edition of 1722, is here re-issued with a new introduction by David Roberts which shows why *Colonel Jack* increasingly commands the attention of modern readers.

Also available in the World's Classics:

Peregrine Pickle Tobias Smollett
Castle Rackrent Maria Edgeworth
Joseph Andrews and Shamela Henry Fielding
Camilla Fanny Burney

OXFORD REFERENCE

Oxford is famous for its superb range of dictionaries and reference books. The Oxford Reference series offers the most up-to-date and comprehensive paperbacks at the most competitive prices, across a broad spectrum of subjects.

THE CONCISE OXFORD COMPANION TO ENGLISH LITERATURE

Edited by Margaret Drabble and Jenny Stringer

Based on the immensely popular fifth edition of the *Oxford Companion to English Literature* this is an indispensable, compact guide to the central matter of English literature.

There are more than 5,000 entries on the lives and works of authors, poets, playwrights, essayists, philosophers, and historians; plot summaries of novels and plays; literary movements; fictional characters; legends; theatres; periodicals; and much more.

The book's sharpened focus on the English literature of the British Isles makes it especially convenient to use, but there is still generous coverage of the literature of other countries and of other disciplines which have influenced or been influenced by English literature.

From reviews of *The Oxford Companion to English Literature Fifth Edition*:

'a book which one turns to with constant pleasure . . . a book with much style and little prejudice' Iain Gilchrist, *TLS*

'it is quite difficult to imagine, in this genre, a more useful publication' Frank Kermode, *London Review of Books*

'incarnates a living sense of tradition . . . sensitive not to fashion merely but to the spirit of the age' Christopher Ricks, *Sunday Times*

Also available in Oxford Reference:

The Concise Oxford Dictionary of Art and Artists
edited by Ian Chilvers

A Concise Oxford Dictionary of Mathematics
Christopher Clapham

The Oxford Spelling Dictionary compiled by R. E. Allen

A Concise Dictionary of Law edited by Elizabeth A. Martin

THE OXFORD-DUDEN PICTORIAL ENGLISH DICTIONARY

Fully illustrated

Over 28,000 objects in science and medicine, the arts
and leisure activities, industry, and new technology

Certain kinds of information are conveyed better visually
than by written definitions. It is, for instance, easier and
clearer to describe the features of a range of fold
mountains, a Corinthian column, or the workings of an
internal combustion engine with a picture than with a
verbal description.

Each double page of this dictionary explains the
vocabulary of a particular subject by means of a picture
illustrating it. The illustrations are clearly drawn and
finely detailed, and an alphabetical index is also provided
for quick and easy reference.

An essential complement to any dictionary of English

Cover illustration by Mark Burton

Oxford Paperbacks
Oxford University Press

